

ETSI TR 137 910 V18.0.0 (2024-05)



**5G;
Study on self evaluation towards IMT-2020 submission
(3GPP TR 37.910 version 18.0.0 Release 18)**



Reference

RTR/TSGR-0037910vi00

Keywords

5G

ETSI

650 Route des Lucioles
F-06921 Sophia Antipolis Cedex - FRANCE

Tel.: +33 4 92 94 42 00 Fax: +33 4 93 65 47 16

Siret N° 348 623 562 00017 - APE 7112B
Association à but non lucratif enregistrée à la
Sous-Préfecture de Grasse (06) N° w061004871

Important notice

The present document can be downloaded from:

<https://www.etsi.org/standards-search>

The present document may be made available in electronic versions and/or in print. The content of any electronic and/or print versions of the present document shall not be modified without the prior written authorization of ETSI. In case of any existing or perceived difference in contents between such versions and/or in print, the prevailing version of an ETSI deliverable is the one made publicly available in PDF format at www.etsi.org/deliver.

Users of the present document should be aware that the document may be subject to revision or change of status.

Information on the current status of this and other ETSI documents is available at

<https://portal.etsi.org/TB/ETSIDeliverableStatus.aspx>

If you find errors in the present document, please send your comment to one of the following services:

<https://portal.etsi.org/People/CommitteeSupportStaff.aspx>

If you find a security vulnerability in the present document, please report it through our
Coordinated Vulnerability Disclosure Program:

<https://www.etsi.org/standards/coordinated-vulnerability-disclosure>

Notice of disclaimer & limitation of liability

The information provided in the present deliverable is directed solely to professionals who have the appropriate degree of experience to understand and interpret its content in accordance with generally accepted engineering or other professional standard and applicable regulations.

No recommendation as to products and services or vendors is made or should be implied.

No representation or warranty is made that this deliverable is technically accurate or sufficient or conforms to any law and/or governmental rule and/or regulation and further, no representation or warranty is made of merchantability or fitness for any particular purpose or against infringement of intellectual property rights.

In no event shall ETSI be held liable for loss of profits or any other incidental or consequential damages.

Any software contained in this deliverable is provided "AS IS" with no warranties, express or implied, including but not limited to, the warranties of merchantability, fitness for a particular purpose and non-infringement of intellectual property rights and ETSI shall not be held liable in any event for any damages whatsoever (including, without limitation, damages for loss of profits, business interruption, loss of information, or any other pecuniary loss) arising out of or related to the use of or inability to use the software.

Copyright Notification

No part may be reproduced or utilized in any form or by any means, electronic or mechanical, including photocopying and microfilm except as authorized by written permission of ETSI.

The content of the PDF version shall not be modified without the written authorization of ETSI.

The copyright and the foregoing restriction extend to reproduction in all media.

© ETSI 2024.
All rights reserved.

Intellectual Property Rights

Essential patents

IPRs essential or potentially essential to normative deliverables may have been declared to ETSI. The declarations pertaining to these essential IPRs, if any, are publicly available for **ETSI members and non-members**, and can be found in ETSI SR 000 314: "*Intellectual Property Rights (IPRs); Essential, or potentially Essential, IPRs notified to ETSI in respect of ETSI standards*", which is available from the ETSI Secretariat. Latest updates are available on the ETSI Web server (<https://ipr.etsi.org/>).

Pursuant to the ETSI Directives including the ETSI IPR Policy, no investigation regarding the essentiality of IPRs, including IPR searches, has been carried out by ETSI. No guarantee can be given as to the existence of other IPRs not referenced in ETSI SR 000 314 (or the updates on the ETSI Web server) which are, or may be, or may become, essential to the present document.

Trademarks

The present document may include trademarks and/or tradenames which are asserted and/or registered by their owners. ETSI claims no ownership of these except for any which are indicated as being the property of ETSI, and conveys no right to use or reproduce any trademark and/or tradename. Mention of those trademarks in the present document does not constitute an endorsement by ETSI of products, services or organizations associated with those trademarks.

DECT™, **PLUGTESTS™**, **UMTS™** and the ETSI logo are trademarks of ETSI registered for the benefit of its Members. **3GPP™** and **LTE™** are trademarks of ETSI registered for the benefit of its Members and of the 3GPP Organizational Partners. **oneM2M™** logo is a trademark of ETSI registered for the benefit of its Members and of the oneM2M Partners. **GSM®** and the GSM logo are trademarks registered and owned by the GSM Association.

Legal Notice

This Technical Report (TR) has been produced by ETSI 3rd Generation Partnership Project (3GPP).

The present document may refer to technical specifications or reports using their 3GPP identities. These shall be interpreted as being references to the corresponding ETSI deliverables.

The cross reference between 3GPP and ETSI identities can be found under <https://webapp.etsi.org/key/queryform.asp>.

Modal verbs terminology

In the present document "**should**", "**should not**", "**may**", "**need not**", "**will**", "**will not**", "**can**" and "**cannot**" are to be interpreted as described in clause 3.2 of the [ETSI Drafting Rules](#) (Verbal forms for the expression of provisions).

"**must**" and "**must not**" are **NOT** allowed in ETSI deliverables except when used in direct citation.

Contents

Intellectual Property Rights	2
Legal Notice	2
Modal verbs terminology.....	2
Foreword.....	7
1 Scope	8
2 References	8
3 Definitions, symbols and abbreviations	9
3.1 Definitions	9
3.2 Symbols.....	9
3.3 Abbreviations	9
4 Introduction	10
5 Self evaluation of eMBB technical performance	11
5.1 Peak spectral efficiency	11
5.1.1 NR.....	11
5.1.1.1 DL peak spectral efficiency.....	12
5.1.1.2 UL peak spectral efficiency.....	13
5.1.2 LTE.....	15
5.1.2.1 DL peak spectral efficiency.....	15
5.1.2.2 UL peak spectral efficiency.....	16
5.2 Peak data rate	16
5.2.1 NR.....	16
5.2.1.1 DL peak data rate	16
5.2.1.2 UL peak data rate	17
5.2.2 LTE.....	18
5.2.2.1 DL peak data rate	18
5.2.2.2 UL peak data rate	18
5.3 5 th percentile user spectral efficiency	18
5.4 Average spectral efficiency	18
5.4.1 NR.....	18
5.4.1.1 Indoor Hotspot – eMBB	19
5.4.1.1.1 Evaluation configuration A (CF = 4 GHz)	19
5.4.1.1.2 Evaluation configuration B (CF = 30 GHz).....	25
5.4.1.2 Dense Urban – eMBB	29
5.4.1.2.1 Evaluation configuration A (CF = 4 GHz)	29
5.4.1.2.2 Evaluation configuration B (CF=30 GHz)	35
5.4.1.3 Rural – eMBB	36
5.4.1.3.1 Evaluation configuration A (CF = 700 MHz).....	36
5.4.1.3.2 Evaluation configuration B (CF = 4 GHz)	40
5.4.1.3.3 Evaluation configuration C (LMLC)	44
5.4.2 LTE.....	48
5.4.2.1 Indoor Hotspot – eMBB.....	48
5.4.2.1.1 Evaluation configuration A (CF = 4 GHz)	48
5.4.2.2 Dense Urban – eMBB	49
5.4.2.2.1 Evaluation configuration A (CF = 4 GHz)	49
5.4.2.3 Rural – eMBB	51
5.4.2.3.1 Evaluation configuration A (CF = 700 MHz).....	51
5.4.2.3.2 Evaluation configuration B (CF = 4 GHz)	52
5.4.2.3.3 Evaluation configuration C (LMLC)	53
5.5 User experienced data rate.....	54
5.5.1 NR.....	55
5.5.1.1 Dense Urban – eMBB	55
5.5.1.1.1 Evaluation configuration A (CF = 4 GHz)	55
5.5.1.1.2 Evaluation configuration B (CF = 30 GHz).....	61

5.5.1.1.3	Evaluation configuration C.....	61
5.5.2	LTE.....	62
5.5.2.1	Dense Urban – eMBB	63
5.5.2.1.1	Evaluation configuration A (CF = 4 GHz)	63
5.6	Area traffic capacity	64
5.6.1	NR.....	65
5.6.1.1	Indoor Hotspot – eMBB.....	65
5.6.1.1.1	Evaluation configuration A (CF = 4 GHz)	65
5.6.1.1.2	Evaluation configuration B (CF = 30 GHz).....	67
5.6.2	LTE.....	69
5.6.2.1	Indoor Hotspot – eMBB.....	69
5.6.2.1.1	Evaluation configuration A (CF = 4 GHz)	69
5.7	Latency	70
5.7.1	User plane latency.....	70
5.7.1.1	NR.....	70
5.7.1.1.1	Downlink.....	71
5.7.1.1.2	Uplink.....	74
5.7.1.2	LTE	78
5.7.1.2.1	Downlink.....	78
5.7.1.2.2	Uplink.....	79
5.7.2	Control plane latency	81
5.7.2.1	NR.....	81
5.7.2.2	LTE	87
5.8	Energy efficiency	90
5.8.1	Network side	91
5.8.1.1	NR.....	91
5.8.1.1.1	Evaluation of sleep ratio	92
5.8.1.1.2	Evaluation of sleep duration	93
5.8.1.2	LTE	93
5.8.1.2.1	Evaluation of sleep ratio	94
5.8.1.2.2	Evaluation of sleep duration	94
5.8.2	Device side.....	95
5.8.2.1	NR.....	95
5.8.2.1.1	Evaluation of sleep ratio	95
5.8.2.1.2	Evaluation of sleep duration	96
5.8.2.2	LTE	96
5.8.2.2.1	Evaluation of sleep ratio	96
5.8.2.2.2	Evaluation of sleep duration	98
5.9	Mobility.....	98
5.9.1	NR.....	98
5.9.1.1	Indoor Hotspot – eMBB.....	98
5.9.1.1.1	Evaluation configuration A (CF = 4 GHz)	98
5.9.1.1.2	Evaluation configuration B (CF = 30 GHz).....	99
5.9.1.2	Dense Urban – eMBB	100
5.9.1.2.1	Evaluation configuration A (CF = 4 GHz)	100
5.9.1.2.2	Evaluation configuration B (CF = 30 GHz).....	101
5.9.1.3	Rural – eMBB	102
5.9.1.3.1	Evaluation configuration A (CF = 700 MHz).....	102
5.9.1.3.2	Evaluation configuration B (CF = 4 GHz)	103
5.9.2	LTE.....	105
5.9.2.1	Indoor Hotspot – eMBB.....	105
5.9.2.1.1	Evaluation configuration A (CF = 4 GHz)	105
5.9.2.2	Dense Urban – eMBB	105
5.9.2.2.1	Evaluation configuration A (CF = 4 GHz)	105
5.9.2.3	Rural – eMBB	106
5.9.2.3.1	Evaluation configuration A (CF = 700 MHz).....	106
5.10	Mobility interruption time	107
5.10.1	NR.....	108
5.10.1.1	Scenarios	108
5.10.1.2	Beam mobility.....	108
5.10.1.3	CA Mobility	108
5.10.2	LTE.....	108

5.10.2.1	Scenarios	108
5.10.2.2	PCell mobility	108
5.10.2.3	DC Mobility	109
6	Self evaluation of URLLC technical performance	111
6.1	Reliability	111
6.1.1	NR.....	111
6.1.1.1	DL reliability.....	111
6.1.1.2	UL reliability.....	113
6.2	Latency	117
6.2.1	User plane latency.....	117
6.2.1.1	NR.....	117
6.2.1.2	LTE	117
6.2.2	Control plane latency.....	117
6.3	Mobility interruption time	117
7	Self evaluation of mMTC technical performance	118
7.1	Connection density	118
7.1.1	NR.....	118
7.1.2	LTE.....	119
8	Self evaluation of generic requirements.....	122
8.1	Bandwidth and scalability	122
8.1.1	NR.....	122
8.1.2	LTE.....	123
8.2	Spectrum.....	123
8.2.1	NR.....	124
8.2.2	LTE.....	124
8.3	Service.....	127
9	Conclusion.....	128
Annex A:	Calibration for self evaluation	129
Annex B:	Simulation models and assumptions	132
B.1	Calculation of pre-processing SINR.....	132
B.2	Link level assumption for mobility evaluation.....	134
B.2.1	Scaling factor for link level channel model.....	134
B.2.2	TXRU pattern and inter-port spacing in link level simulation	137
B.3	Evaluation assumption for peak spectral efficiency and peak data rate	138
B.3.1	Evaluation assumption for NR	138
B.3.1.1	NR downlink.....	138
B.3.1.2	NR uplink	139
B.3.2	Evaluation assumption for LTE.....	140
B.3.2.1	LTE downlink.....	140
B.3.2.2	LTE uplink.....	141
B.4	Detailed assumptions and evaluation results for simulation related technical performance requirements	142
B.4.1	Detailed assumptions and results for average and 5 th percentile user spectral efficiency	142
B.4.2	Detailed assumptions and results for mobility.....	142
B.4.3	Detailed assumptions and results for user experienced data rate.....	142
B.4.4	Detailed assumptions and results for reliability.....	142
B.4.5	Detailed assumptions and results for connection density	142
B.5	Simulation results of spectral efficiency for Configuration B in Dense Urban – eMBB with modified ITU-R assumptions (for information only).....	143
B.6	Simulation results of Configuration C for Indoor Hotspot – eMBB test environment (for information only).....	145
B.6.1	Evaluation configuration C (CF = 70 GHz) for spectral efficiency.....	145
B.6.2	Evaluation configuration C (CF = 70 GHz) for area traffic capacity	146

Annex C: ITU-R Submission Templates for IMT-2020.....148

C.1 Description template – characteristics.....148

C.2 Description template – link budget148

C.3 Compliance templates for services, for spectrum, for technical performance148

Annex D: Change history149

History150

Foreword

This Technical Report has been produced by the 3rd Generation Partnership Project (3GPP).

The contents of the present document are subject to continuing work within the TSG and may change following formal TSG approval. Should the TSG modify the contents of the present document, it will be re-released by the TSG with an identifying change of release date and an increase in version number as follows:

Version x.y.z

where:

- x the first digit:
 - 1 presented to TSG for information;
 - 2 presented to TSG for approval;
 - 3 or greater indicates TSG approved document under change control.
- y the second digit is incremented for all changes of substance, i.e. technical enhancements, corrections, updates, etc.
- z the third digit is incremented when editorial only changes have been incorporated in the document.

1 Scope

This report presents the self evaluation results of 3GPP 5G SRIT and 5G NR RIT.

2 References

The following documents contain provisions which, through reference in this text, constitute provisions of the present document.

- References are either specific (identified by date of publication, edition number, version number, etc.) or non-specific.
- For a specific reference, subsequent revisions do not apply.
- For a non-specific reference, the latest version applies. In the case of a reference to a 3GPP document (including a GSM document), a non-specific reference implicitly refers to the latest version of that document *in the same Release as the present document*.

- [1] 3GPP TR 21.905: "Vocabulary for 3GPP Specifications".
- [2] 3GPP TS 38.101-1: "User Equipment (UE) radio transmission and reception; Part 1: Range 1 Standalone".
- [3] 3GPP TS 38.101-2: "User Equipment (UE) radio transmission and reception; Part 2: Range 2 Standalone".
- [4] Report ITU-R M.2410: "Minimum requirements related to technical performance for IMT-2020 radio interface(s)".
- [5] Report ITU-R M.2411: "Requirements, evaluation criteria and submission templates for the development of IMT-2020".
- [6] Report ITU-R M.2412: "Guidelines for evaluation of radio interface technologies for IMT-2020".
- [7] 3GPP TS 38.211: "Physical channels and modulation".
- [8] 3GPP TR 38.817-01: "General aspects for User Equipment (UE) Radio Frequency (RF) for NR".
- [9] 3GPP TS 38.214: "Physical layer procedures for data".
- [10] 3GPP TS 38.306: "User Equipment (UE) radio access capabilities".
- [11] 3GPP TS 36.211: "Physical channels and modulation".
- [12] 3GPP TS 38.133: "Requirements for support of radio resource management".
- [13] 3GPP TS 36.133: "Requirements for support of radio resource management".
- [14] 3GPP TS 36.300: "Overall description; Stage 2".
- [15] 3GPP TS 38.104: "Base Station (BS) radio transmission and reception".
- [16] 3GPP TS 38.331: "Radio Resource Control (RRC) protocol specification".
- [17] 3GPP TS 36.101: "User Equipment (UE) radio transmission and reception".
- [18] 3GPP TS 36.331: "Radio Resource Control (RRC); Protocol specification".
- [19] 3GPP TR 36.873: "Study on 3D channel model for LTE".

3 Definitions, symbols and abbreviations

3.1 Definitions

For the purposes of the present document, the terms and definitions given in 3GPP TR 21.905 [1] and the following apply. A term defined in the present document takes precedence over the definition of the same term, if any, in 3GPP TR 21.905 [1].

3.2 Symbols

For the purposes of the present document, the following symbols apply:

SE_{pj}	Peak spectral efficiency for j -th component carrier (CC); see clause 5.1.1
$v_{Layers}^{(j)}$	Maximum number of layers for j -th CC; see clause 5.1.1
$Q_m^{(j)}$	Maximum modulation order for j -th CC; see clause 5.1.1
$f^{(j)}$	Scaling factor for j -th CC; see clause 5.1.1
μ	Numerology as defined in TS 38.211
T_s^μ	Average OFDM symbol duration in a subframe for numerology; see clause 5.1.1
$N_{PRB}^{BW(j),\mu}$	Maximum RB allocation in bandwidth $BW^{(j)}$ with numerology μ ; see clause 5.1.1
$OH^{(j)}$	Overhead calculated as the average ratio of the number of REs not used for data transmission
$\alpha^{(j)}$	Normalized scalar of downlink/uplink ratio
R	Peak data rate; see clause 5.2
W_j	Effective bandwidth; see clause 5.2
P_{SSB}	SSB set periodicity; see clause 5.8.1
P_{RMSI}	RMSI periodicity; see clause 5.8.1
$Sleep_ratio_{slot_based}$	Sleep ratio per slot basis; see clause 5.8.1
$Sleep_ratio_{symbol_based}$	Sleep ratio per symbol basis; see clause 5.8.1
N_{PC_RF}	The paging frame and subframe with the period of N_{PC_RF} radio frame; see clause 5.8.2
$SINR_{pre-proc}$	Pre-processing SINR; see clause B.1
$RSRP_p$	Reference signal receiving power; see clause B.1
PL	The value of pathloss
SF	The value of shadow fading

3.3 Abbreviations

For the purposes of the present document, the abbreviations given in 3GPP TR 21.905 [1] and the following apply. An abbreviation defined in the present document takes precedence over the definition of the same abbreviation, if any, in 3GPP TR 21.905 [1].

CF	Carrier frequency
CSI-RS	CSI reference signal
DC	Dual connectivity
DM-RS	Demodulation reference signal
DL	Downlink
eMBB	Enhanced mobile broadband
eMTC	Enhanced machine type communication
FDD	Frequency division duplexing
FeMBMS	Further evolved multimedia broadcast multicast service
FR1	Frequency range 1
FR2	Frequency range 2
ISD	Inter-site distance
LMLC	Low mobility large cell
LOS	Line of sight
MeNB	Master E-UTRAN NodeB
MIMO	Multiple input multiple output

mMTC	Massive machine type communication
MU	Multiple user
NB-IoT	Narrow band internet of things
NLOS	Non line of sight
OH	Overhead
OS	OFDM symbol
PSCell	Primary secondary cell
PSS	Primary synchronization signal
PT-RS	Phase-tracking reference signal
RIT	Radio interface technology
RMa	Rural macro
RMSI	Remaining minimum system information
RTT	Round-trip time
SCS	Subcarrier spacing
SeNB	Secondary E-UTRAN NodeB
SIMO	Single input multiple output
SISO	Single input single output
SRI	SRS resource indicator
SRIT	Set of RITs
SRS	Sounding reference signal
SS	Synchronization signal
SSB	SS/PBCH Block
SSS	Secondary synchronization signal
SU	Single user
TDD	Time division duplexing
TRxP	Transmission reception point
UL	Uplink
UMa	Urban macro
URLLC	Ultra reliable and low latency communication

4 Introduction

This report presents the self evaluation results of 5G¹ developed by 3GPP, which includes two submissions:

- Submission 1: SRIT. It consists of two component RITs
 - Component RIT 1: NR
 - Component RIT 2: E-UTRA/LTE (including LTE-NR DC)
- Submission 2: NR RIT.
 - It is the same as in NR component RIT in submission 1.

From evaluation perspective, NR RIT and LTE RIT are evaluated against the technical performance requirements as defined in Report ITU-R M.2410 for eMBB, mMTC and URLLC usage scenarios, as well as spectrum requirements and service requirements as defined in Report ITU-R M.2411, using the evaluation criteria as defined by Report ITU-R M.2412. Detailed self evaluation results are provided through Section 5 to 8.

The conclusion is given in Section 9 for SRIT and NR RIT.

¹ Developed by 3GPP as 5G, Release 15 and beyond.

5 Self evaluation of eMBB technical performance

In the following, frequency ranges indicated by FR1 and FR2 are evaluated. The definition are given in Table 5-1 (see also [2] and [3]).

Table 5-1 Definition of frequency ranges

Frequency range designation	Corresponding frequency range
FR1	410 MHz – 7125 MHz
FR2	24250 MHz – 52600 MHz

5.1 Peak spectral efficiency

As defined in Report ITU-R M.2410 [4], Peak spectral efficiency is the maximum data rate under ideal conditions normalized by channel bandwidth (in bit/s/Hz), where the maximum data rate is the received data bits assuming error-free conditions assignable to a single mobile station, when all assignable radio resources for the corresponding link direction are utilized (i.e. excluding radio resources that are used for physical layer synchronization, reference signals or pilots, guard bands and guard times).

5.1.1 NR

The generic formula for peak spectral efficiency for FDD and TDD for a specific component carrier (say j -th CC) is given by

$$SE_{p_j} = \frac{v_{Layers}^{(j)} \cdot Q_m^{(j)} \cdot f^{(j)} \cdot R_{max} \cdot \frac{N_{PRB}^{BW(j),\mu} \cdot 12}{T_s^\mu} \cdot (1 - OH^{(j)})}{BW^{(j)}} \quad (5.1.1-1)$$

wherein

- $R_{max} = 948/1024$
- For the j -th CC,
 - $v_{Layers}^{(j)}$ is the maximum number of layers
 - $Q_m^{(j)}$ is the maximum modulation order
 - $f^{(j)}$ is the scaling factor
 - The scaling factor can at least take the values 1 and 0.75.
 - $f^{(j)}$ is signalled per band and per band per band combination as per UE capability signalling
 - μ is the numerology (as defined in TS 38.211 [7])
 - T_s^μ is the average OFDM symbol duration in a subframe for numerology μ , i.e. $T_s^\mu = \frac{10^{-3}}{14 \cdot 2^\mu}$. Note that normal cyclic prefix is assumed.
 - $N_{PRB}^{BW(j),\mu}$ is the maximum RB allocation in bandwidth $BW^{(j)}$ with numerology μ , as given in TR 38.817-01 [8] section 4.5.1, where $BW^{(j)}$ is the UE supported maximum bandwidth in the given band or band combination.

- $OH^{(j)}$ is the overhead calculated as the average ratio of the number of REs occupied by L1/L2 control, Synchronization Signal, PBCH, reference signals and guard period (for TDD), etc. with respect to the total number of REs in effective bandwidth time product as given by $(\alpha^{(j)} \cdot BW^{(j)} \cdot (14 \times T_s^\mu))$.
- $\alpha^{(i)}$ is the normalized scalar considering the downlink/uplink ratio; for FDD $\alpha^{(i)}=1$ for DL and UL; and for TDD and other duplexing $\alpha^{(i)}$ for DL and UL is calculated based on the DL/UL configuration.
- For guard period (GP), 50% of GP symbols are considered as downlink overhead, and 50% of GP symbols are considered as uplink overhead.

5.1.1.1 DL peak spectral efficiency

A range of configurations are considered in the evaluation of downlink peak spectral efficiency. The evaluation considers the maximum potential capability as indicated in TS 38.214 [9]. Note that the DL and UL max data rate supported by the UE is indicated in TS38.306 [10].

For NR FDD, DL peak spectral efficiency of frequency range 1 (FR1) for 450 MHz – 7125 MHz is evaluated. The evaluated configurations for FDD generally assume 8-layer downlink transmission, with 256QAM modulation, and a maximum coding rate of 0.9258. The difference among the evaluated configurations lays in the overhead of control and reference signals, etc. The evaluation results are provided in Table 5.1.1.1-1. The detailed assumptions are provided in Annex B.3.1.1.

Table 5.1.1.1-1 NR FDD DL peak spectral efficiency (bit/s/Hz)

SCS [kHz]		5 MHz	10 MHz	15 MHz	20 MHz	25 MHz	30 MHz	40 MHz	50 MHz	60 MHz	80 MHz	90 MHz	100 MHz	Req.
FR1	15	40.8~42.8	44.5~45.5	45.1~46.5	45.4~47.0	45.5~47.2	45.7~47.4	46.2~48.2	46.2~48.3	-	-	-	-	30
	30	32.1~37.7	39.4~41.1	43.0~44.2	43.7~44.8	44.5~45.9	44.5~46.1	45.4~47.1	45.5~47.4	46.2~48.2	46.4~48.5	48.5~48.7	46.7~48.9	30
	60	-	32.4~37.7	38.4~41.1	39.6~41.3	41.8~43.1	43.2~44.3	43.7~44.9	44.5~46.0	45.1~46.8	45.8~47.7	47.6~47.8	46.2~48.2	30

For NR TDD, DL peak spectral efficiency for both FR1 and FR2 for 24.25 GHz – 52.6 GHz are evaluated.

For NR TDD in FR1, the evaluated configurations generally assume 8-layer downlink transmission, with 256QAM modulation, and a maximum coding rate of 0.9258. The DL/UL configurations of DDDSU (with ‘S’ slot = 11DL:1GP:2UL) and DSUUD (with ‘S’ slot = 6DL:2GP:6UL and 11DL:1GP:2UL respectively) are evaluated.

The evaluation results of DDDSU for FR1 are provided in Table 5.1.1.1-2. In the evaluation, different control overhead assumptions are considered due to the different transmission schemes. The detailed assumptions are provided in Annex B.3.1.1.

Table 5.1.1.1-2 NR TDD DL peak spectral efficiency for FR1 (bit/s/Hz)
(Frame structure: DDDSU; $\alpha_{DL}=0.7643$; with OH1 and OH2)

SCS [kHz]		5 MHz	10 MHz	15 MHz	20 MHz	25 MHz	30 MHz	40 MHz	50 MHz	60 MHz	80 MHz	90 MHz	100 MHz	Req.
FR1	15	39.6~41.5	43.6~44.5	44.9~45.6	45.6~46.1	46.1~46.4	46.3~46.6	47.1~47.3	47.2~47.4	-	-	-	-	30
	30	31.7~35.2	38.4~40.3	42.1~43.3	43.1~44.0	44.4~45.1	44.6~45.3	45.9~46.3	46.3~46.6	47.1~47.4	47.5~47.7	47.7~47.9	47.9~48.1	30
	60	-	31.8~35.3	37.5~40.1	38.7~40.5	40.9~42.3	42.3~43.5	43.3~44.2	44.5~45.3	45.4~46.0	46.4~46.9	46.8~47.2	47.1~47.4	30

The evaluation results of DSUUD for the two S-slot configurations for FR1 are provided in Table 5.1.1.1-3. The detailed assumptions are provided in Annex B.3.1.1.

Table 5.1.1.1-3 NR TDD DL peak spectral efficiency for FR1 (bit/s/Hz)
(Frame structure: DSUUD)

(a) S slot = 11DL:1GP:2UL, $\alpha_{DL}=0.5643$, with OH3

SCS [kHz]	5 MHz	10 MHz	15 MHz	20 MHz	25 MHz	30 MHz	40 MHz	50 MHz	60 MHz	80 MHz	90 MHz	100 MHz	Req.
FR1	15	39.1	43.1	44.5	45.2	45.6	45.9	46.7	46.8	-	-	-	30
	30	30.4	38.0	41.7	42.7	44.0	44.3	45.5	46.8	47.1	47.4	47.6	30
	60	-	31.0	37.1	38.4	40.6	42.0	42.9	44.2	45.1	46.1	46.8	30

(b) S slot = 6DL:2GP:6UL, $\alpha_{DL}=0.5$, with OH4

SCS [kHz]	5 MHz	10 MHz	15 MHz	20 MHz	25 MHz	30 MHz	40 MHz	50 MHz	60 MHz	80 MHz	90 MHz	100 MHz	Req.
FR1	15	39.1	42.4	43.5	44.0	44.4	44.6	45.3	45.4	-	-	-	30
	30	33.1	37.4	40.7	41.6	42.7	42.9	44.0	44.4	45.2	45.5	45.9	30
	60	-	33.1	36.4	37.4	39.4	40.7	41.6	42.7	43.5	44.5	44.8	45.1

For NR TDD in FR2, the DL/UL configurations of DDDSU (with 'S' slot = 11DL:1GP:2UL) and DSUUD (with 'S' slot = 6DL:2GP:6UL and 11DL:1GP:2UL respectively) are evaluated. For FR2 evaluation, the number of layers is assumed to be 6. This is because larger than 6-port DMRS is difficult due to the phase noise impact on FR2. Besides, the highest modulation order of 256QAM and the maximum coding rate of 0.9258 are assumed.

The evaluation results of DDDSU and DSUUD for FR2 are provided in Table 5.1.1.1-4 and Table 5.1.1.1-5, respectively. The detailed assumptions are provided in Annex B.3.1.1.

Table 5.1.1.1-4 NR TDD DL peak spectral efficiency for FR2 (bit/s/Hz)
(Frame structure: DDDSU, $\alpha_{DL}=0.7643$, Number of layer = 6)

SCS [kHz]	50 MHz	100 MHz	200 MHz	400 MHz	Req.	
FR2	60	33.7	34.5	34.9	-	30
	120	31.7	34.0	34.7	35.0	30

Table 5.1.1.1-5 NR TDD DL peak spectral efficiency for FR2 (bit/s/Hz)
(Frame structure: DSUUD, S slot = 11DL:1GP:2UL, $\alpha_{DL}=0.5643$, Number of layer = 6)

SCS [kHz]	50 MHz	100 MHz	200 MHz	400 MHz	Req.	
FR2	60	32.9	33.8	34.2	-	30
	120	31.1	33.5	34.2	34.6	30

If phase noise does not exist for FR2, the 8-layer transmission can be supported for FR2. The evaluation of this capability together with DSUUD is provided in Table 5.1.1.1-6.

Table 5.1.1.1-6 NR TDD DL peak spectral efficiency for FR2 (bit/s/Hz)
(Frame structure: DSUUD, S slot = 6DL:2GP:6UL, $\alpha_{DL}=0.5$, Number of layer = 8)

SCS [kHz]	50 MHz	100 MHz	200 MHz	400 MHz	Req.	
FR2	60	41.9	43.2	43.8	-	30
	120	38.0	41.9	43.2	43.8	30

Based on the above analysis, NR fulfils DL peak spectral efficiency requirement with a range of configurations.

5.1.1.2 UL peak spectral efficiency

A range of configurations are considered in the evaluation of uplink peak spectral efficiency.

For NR FDD, UL peak spectral efficiency of FR1 is evaluated. The evaluated configurations for FDD generally assume 4-layer downlink transmission, with 256QAM modulation, and a maximum coding rate of 0.9258. The difference among the evaluated configurations lays in the overhead of control and reference signals, etc. The evaluation results are provided in Table 5.1.1.2-1. The detailed assumptions are provided in Annex B.3.1.2.

Table 5.1.1.2-1 NR FDD UL peak spectral efficiency (bit/s/Hz)

SCS [kHz]	5 MHz	10 MHz	15 MHz	20 MHz	25 MHz	30 MHz	40 MHz	50 MHz	60 MHz	80 MHz	90 MHz	100 MHz	Req.
-----------	-------	--------	--------	--------	--------	--------	--------	--------	--------	--------	--------	---------	------

FR1	15	22.9~ 23.5	23.8~ 24.5	24.1~ 24.8	24.3~ 25.0	24.4~ 25.1	24.4~ 25.2	24.7~ 25.5	24.7~ 25.5	0.0	0.0	0.0	0.0	15
	30	20.1~ 20.7	22.0~ 22.6	23.2~ 23.9	23.4~ 24.1	23.8~ 24.6	23.8~ 24.6	24.3~ 25.1	24.4~ 25.2	24.7~ 25.5	24.8~ 25.7	24.9~ 25.3	25.0~ 25.8	15
	60	0.0	20.1~ 20.7	22.0~ 22.6	22.0~ 22.7	22.7~ 23.4	23.2~ 23.9	23.4~ 24.1	23.8~ 24.6	24.1~ 24.9	24.5~ 25.3	24.9~ 25.0	24.7~ 25.6	15

For NR TDD, UL peak spectral efficiency for both FR1 and FR2 are evaluated.

For NR TDD in FR1, the evaluated configurations generally assume 4-layer uplink transmission, with 256QAM modulation, and a maximum coding rate of 0.9258. The DL/UL configurations of DDDSU (with 'S' slot = 11DL:1GP:2UL) and DSUUD (with 'S' slot = 6DL:2GP:6UL and 11DL:1GP:2UL respectively) are evaluated.

The evaluation results of DDDSU for FR1 are provided in Table 5.1.1.2-2. In the evaluation, different control overhead assumptions are considered due to the different transmission schemes. The detailed assumptions are provided in Annex B.3.1.2.

**Table 5.1.1.2-2 NR TDD UL peak spectral efficiency for FR1 (bit/s/Hz)
(Frame structure: DDDSU, $\alpha_{UL}=0.2357$, with OH1 and OH2)**

SCS [kHz]	5 MHz	10 MHz	15 MHz	20 MHz	25 MHz	30 MHz	40 MHz	50 MHz	60 MHz	80 MHz	90 MHz	100 MHz	Req.	
FR1	15	20.6~ 21.6	21.5~ 22.6	21.8~ 22.9	22.0~ 23.0	22.0~ 23.1	22.1~ 23.2	22.4~ 23.5	22.4~ 23.5	-	-	-	15	
	30	18.2~ 19.1	20.0~ 20.9	21.1~ 22.1	21.3~ 22.3	21.7~ 22.8	21.7~ 22.8	22.2~ 23.2	22.2~ 23.2	22.6~ 23.7	22.7~ 23.8	22.8~ 23.9	22.8~ 23.9	15
	60	-	18.3~ 19.1	20.0~ 21.0	20.1~ 21.0	20.8~ 21.8	21.2~ 22.2	21.4~ 22.4	21.8~ 22.9	22.1~ 23.2	22.5~ 23.5	22.6~ 23.7	22.7~ 23.8	15

The evaluation results of DSUUD for the two S-slot configurations for FR1 are provided in Table 5.1.1.2-3. The detailed assumptions for the two configurations are provided in Annex B.3.1.2.

**Table 5.1.1.2-3 NR TDD UL peak spectral efficiency for FR1 (bit/s/Hz)
(Frame structure: DSUUD)**

(a) S slot = 11DL:1GP:2UL, $\alpha_{UL}=0.4357$, with OH3

SCS [kHz]	5 MHz	10 MHz	15 MHz	20 MHz	25 MHz	30 MHz	40 MHz	50 MHz	60 MHz	80 MHz	90 MHz	100 MHz	Req.	
FR1	15	22.1	23.1	23.4	23.6	23.7	23.8	24.0	24.0	-	-	-	15	
	30	19.4	21.3	22.5	22.7	23.1	23.1	23.6	23.7	24.1	24.2	24.3	24.3	15
	60	-	19.4	21.3	21.3	22.0	22.5	22.7	23.2	23.4	23.8	24.0	24.0	15

(b) S slot = 6DL:2GP:6UL, $\alpha_{UL}=0.5$, with OH4

SCS [kHz]	5 MHz	10 MHz	15 MHz	20 MHz	25 MHz	30 MHz	40 MHz	50 MHz	60 MHz	80 MHz	90 MHz	100 MHz	Req.	
FR1	15	21.7	23.0	23.4	23.6	23.7	23.8	24.1	24.1	-	-	-	15	
	30	18.3	20.8	22.2	22.5	23.0	23.1	23.6	23.7	24.2	24.3	24.4	24.2	15
	60	-	18.3	20.6	20.8	21.7	22.2	22.5	23.0	23.8	23.9	24.1	23.8	15

For NR TDD in FR2, the evaluated configurations generally assume 4-layer uplink transmission, with 256QAM modulation, and a maximum coding rate of 0.9258. The DL/UL configurations of DDDSU (with 'S' slot = 11DL:1GP:2UL) and DSUUD (with 'S' slot = 6DL:2GP:6UL and 11DL:1GP:2UL respectively) are evaluated.

The evaluation results of DDDSU and DSUUD for FR2 are provided in Table 5.1.1.2-4 and Table 5.1.1.2-5, respectively. The detailed assumptions are provided in Annex B.3.1.2.

Table 5.1.1.2-4 NR TDD UL peak spectral efficiency for FR2 (bit/s/Hz)
(Frame structure: DDDSU, $\alpha_{UL}=0.2357$)

SCS [kHz]		50 MHz	100 MHz	200 MHz	400 MHz	Req.
FR2	60	20.9	21.0	21.0	-	15
	120	20.4	21.1	21.2	21.2	15

Table 5.1.1.2-5 NR TDD UL peak spectral efficiency for FR2 (bit/s/Hz)
(Frame structure: DSUUD)

(a) S slot = 11DL:1GP:2UL, $\alpha_{UL}=0.4357$

SCS [kHz]		50 MHz	100 MHz	200 MHz	400 MHz	Req.
FR2	60	21.8	21.9	21.9	-	15
	120	21.3	22.0	22.1	22.1	15

(b) S slot = 6DL:2GP:6UL, $\alpha_{UL}=0.5$

SCS [kHz]		50 MHz	100 MHz	200 MHz	400 MHz	Req.
FR2	60	23.0	23.1	23.2	-	15
	120	22.0	23.0	23.1	23.2	15

Based on the above analysis, NR fulfils UL peak spectral efficiency requirement with a range of configurations.

5.1.2 LTE

For LTE, the similar calculation way to NR is used to analyze the spectrum efficiency.

5.1.2.1 DL peak spectral efficiency

For LTE FDD, the evaluation assumes 8-layer downlink transmission, with 256QAM and 1024QAM modulation, and a maximum coding rate of 0.93. The evaluation results for FDD are provided in Table 5.1.2.1-1. Note that the peak spectrum efficiency of LTE is evaluated by selecting the largest TBS as defined in TS 36.211 [11] matching the supportable coding rate as high as possible and the overhead with the assumed composition of MBSFN and non-MBSFN subframes. The detailed assumptions are provided in Annex B.3.2.1.

Table 5.1.2.1-1 LTE FDD DL peak spectral efficiency (bit/s/Hz)

Modulation order		5 MHz	10 MHz	15 MHz	20 MHz	Req.
FR1	256QAM	37.56	37.55	36.72	37.55	30
	1024QAM	46.38	45.96	47.15	47.11	30

For LTE TDD, the DL/UL configurations of DSUDD (with Special subframe = 11DL:1GP:2UL) and DSUUD (with Special subframe 11DL:1GP:2UL) are evaluated. The evaluation assumes 8-layer downlink transmission, with 256QAM and 1024QAM modulation, and a maximum coding rate of 0.93. The evaluation results are provided in Table 5.1.2.1-2 and Table 5.1.2.1-3, respectively.

Table 5.1.2.1-2 LTE TDD DL peak spectral efficiency (bit/s/Hz)
(Frame structure: DSUDD, Special subframe = 11DL:1GP:2UL, $\alpha_{DL}=0.7643$)

Modulation order		5 MHz	10 MHz	15 MHz	20 MHz	Req.
FR1	256QAM	36.28	36.52	36.51	36.69	30
	1024QAM	45.82	46.27	46.79	46.91	30

Table 5.1.2.1-3 LTE TDD DL peak spectral efficiency (bit/s/Hz)
(Frame structure: DSUUD, Special subframe = 11DL:1GP:2UL, $\alpha_{DL}=0.5643$)

Modulation order		5 MHz	10 MHz	15 MHz	20 MHz	Req.
FR1	256QAM	35.85	36.16	36.44	36.38	30
	1024QAM	45.07	45.93	46.21	46.57	

Based on the above analysis, LTE fulfils DL peak spectral efficiency requirement.

5.1.2.2 UL peak spectral efficiency

For LTE FDD, the evaluation assumes 4-layer uplink transmission, with 256QAM modulation, and a maximum coding rate of 0.93. The evaluation results for FDD are provided in Table 5.1.2.2-1. The detailed assumptions are provided in Annex B.3.2.2.

Table 5.1.2.2-1 LTE FDD UL peak spectral efficiency (bit/s/Hz)

Modulation order		5 MHz	10 MHz	15 MHz	20 MHz	Req.
FR1	256QAM	19.31	20.21	20.25	20.15	15

For LTE TDD, the DL/UL configurations of DSUDD (with Special subframe = 11DL:1GP:2UL) and DSUUD (with Special subframe 11DL:1GP:2UL) are evaluated. The evaluation assumes 4-layer downlink transmission, with 256QAM modulation, and a maximum coding rate of 0.93. The evaluation results are provided in Table 5.1.2.2-2 and Table 5.1.2.2-3, respectively.

Table 5.1.2.2-2 LTE TDD UL peak spectral efficiency (bit/s/Hz)
(Frame structure: DSUDD, Special subframe = 11DL:1GP:2UL, $\alpha_{UL}=0.2357$)

Modulation order		5 MHz	10 MHz	15 MHz	20 MHz	Req.
FR1	256QAM	16.61	17.28	17.31	17.28	15

Table 5.1.2.2-3 LTE TDD UL peak spectral efficiency (bit/s/Hz)
(Frame structure: DSUUD, Special subframe = 11DL:1GP:2UL, $\alpha_{UL}=0.4357$)

Modulation order		5 MHz	10 MHz	15 MHz	20 MHz	Req.
FR1	256QAM	17.97	18.7	18.72	18.7	15

Based on the above analysis, LTE fulfils UL peak spectral efficiency requirement.

5.2 Peak data rate

As defined in Report ITU-R M.2410 [4], peak data rate is the maximum achievable data rate under ideal conditions (in bit/s), which is the received data bits assuming error-free conditions assignable to a single mobile station, when all assignable radio resources for the corresponding link direction are utilized (i.e. excluding radio resources that are used for physical layer synchronization, reference signals or pilots, guard bands and guard times).

For both NR and LTE, the DL/UL peak data rate for FDD and TDD over Q component carriers can be calculated as below

$$R = \sum_{j=1}^Q W_j \times SE_{p_j} = \sum_{j=1}^Q \left(\alpha^{(j)} \cdot BW^{(j)} \right) \times SE_{p_j} \quad (5.2-1)$$

where W_j and SE_{p_j} ($j = 1, \dots, Q$) are the effective bandwidth and spectral efficiencies on component carrier j , respectively, $\alpha^{(j)}$ is the normalized scalar on component carrier j considering the downlink/uplink ratio on that component carrier; for FDD $\alpha^{(j)}=1$ for DL and UL; and for TDD and other duplexing $\alpha^{(j)}$ for DL and UL is calculated based on the frame structure, and $BW^{(j)}$ is the carrier bandwidth of component j .

5.2.1 NR

5.2.1.1 DL peak data rate

A range of configurations are considered in the evaluation of downlink peak data rate.

DL peak data rate for NR is evaluated based on the evaluation results of NR peak spectral efficiency provided in Section 5.1.1.1. Table 5.2.1.1-1 provides the evaluation results for the specific component carrier (CC) bandwidth. It is observed that NR fulfils the DL peak data rate requirement.

Table 5.2.1.1-1 NR DL peak data rate

Duplexing	SCS [kHz]		Per CC BW (MHz)	Peak data rate per CC (Gbit/s)	Aggregated peak data rate over 16 CCs (Gbit/s)	Required DL bandwidth to meet the requirement (MHz) ¹	Req. (Gbit/s)
FDD	FR1	15	50	2.31~2.41	37.0~38.6	414~433	20
		30	100	4.67~4.89	74.7~78.2	409~428	
		60	100	4.62~4.82	73.9~77.1	415~433	
TDD (DDDSU)	FR1	15	50	1.81	29.0	552	
		30	100	3.68	58.9	543	
		60	100	3.62	57.9	552	
	FR2 (N _{layer} =6)	60	200	5.33	85.3	750	
		120	400	10.7	171.2	748	
TDD (DSUUD, S slot=11DL:2GP:2UL)	FR1	15	50	1.32	21.1	757	
		30	100	2.69	43.0	745	
		60	100	2.64	42.3	757	
	FR2 (N _{layer} =6)	60	200	3.86	61.8	1036	
		120	400	7.81	125.0	1024	
		120	400	8.76	140.2	913	
TDD (DSUUD, S slot=6DL:2GP:6UL)	FR1	15	50	1.13	18.1	885	
		30	100	2.30	36.8	870	
		60	100	2.26	36.2	885	
	FR2 (N _{layer} =8)	60	200	4.38	70.1	913	
		120	400	8.76	140.2	913	
		120	400	8.76	140.2	913	

NOTE 1: The value only indicates the required bandwidth to meet the DL peak data rate. It is not necessarily supported as NR Transmission bandwidth.

5.2.1.2 UL peak data rate

A range of configurations are considered in the evaluation of uplink peak data rate.

UL peak data rate for NR is evaluated based on the evaluation results of NR peak spectral efficiency provided in Section 5.1.1.2. Table 5.2.1.2-1 provides the evaluation results for the specific component carrier (CC) bandwidth. It is observed that NR fulfils the UL peak data rate requirement.

Table 5.2.1.2-1 NR UL peak data rate

Duplexing	SCS [kHz]		Per CC BW (MHz)	Peak data rate per CC (Gbit/s)	Aggregated peak data rate over 16 CCs (Gbit/s)	Required UL bandwidth to meet the requirement (MHz) ¹	Req. (Gbit/s)
FDD	FR1	15	50	1.12~1.18	17.9~18.9	424~446	10
		30	100	2.28~2.39	36.5~38.2	418~439	
		60	100	2.27~2.38	36.3~38.1	420~441	
TDD (DDDSU) + SUL	FR1	15	50	1.12~1.18	17.9~18.9	424~446	
		30	100	2.28~2.39	36.5~38.2	418~439	
		60	100	2.27~2.38	36.3~38.1	420~441	
TDD (DSUUD, S slot=11DL:2GP:2UL)	FR1	30	100	1.06	17.0	943	
		60	100	1.05	16.8	952	
	FR2	60	200	1.91	30.6	1047	
		120	400	3.85	61.6	1039	
TDD (DSUUD, S slot=6DL:2GP:6UL)	FR1	30	100	1.05	16.8	952	
		60	100	1.04	16.6	962	
	FR2	60	200	2.02	32.3	990	
		120	400	4.04	64.6	990	

NOTE 1: The value only indicates the required bandwidth to meet the DL peak data rate. It is not necessarily supported as NR Transmission bandwidth.

5.2.2 LTE

5.2.2.1 DL peak data rate

DL peak data rate for LTE is evaluated based on the evaluation results of LTE peak spectral efficiency provided in Section 5.1.2.1. Table 5.2.2.1-1 provides the evaluation results for 20 MHz CC bandwidth. It is observed that LTE fulfils the DL peak data rate requirement.

Table 5.2.2.1-1 LTE DL peak data rate

Duplexing	Modulation order	Per CC BW (MHz)	Peak data rate per CC (Gbit/s)	Aggregated peak data rate over 32 CCs (Gbit/s)	Req. (Gbit/s)
FDD	256QAM	20	0.751	24.0	20
FDD	1024QAM	20	0.942	30.1	

5.2.2.2 UL peak data rate

UL peak data rate for LTE is evaluated based on the evaluation results of LTE peak spectral efficiency provided in Section 5.1.2.2. Table 5.2.2.2-1 provides the evaluation results for 20 MHz CC bandwidth. It is observed that LTE fulfils the UL peak data rate requirement.

Table 5.2.2.2-1 LTE UL peak data rate

Duplexing	Per CC BW (MHz)	Peak data rate per CC (Gbit/s)	Aggregated peak data rate over 32 CCs (Gbit/s)	Req. (Gbit/s)
FDD	20	0.403	12.9	10

5.3 5th percentile user spectral efficiency

As defined in Report ITU-R M.2410 [4], the 5th percentile user spectral efficiency is the 5% point of the CDF of the normalized user throughput. The normalized user throughput is defined as the number of correctly received bits, i.e. the number of bits contained in the SDUs delivered to Layer 3, over a certain period of time, divided by the channel bandwidth and is measured in bit/s/Hz.

As required by Report ITU-R M.2412 [6], 5th percentile user spectral efficiency shall be assessed jointly with average spectral efficiency using the same simulation. Therefore, the evaluation results of the 5th percentile user spectral efficiency are provided together with average spectral efficiency in Section 5.4.

5.4 Average spectral efficiency

As defined in Report ITU-R M.2410 [4], average spectral efficiency is the aggregate throughput of all users (the number of correctly received bits, i.e. the number of bits contained in the SDUs delivered to Layer 3, over a certain period of time) divided by the channel bandwidth of a specific band divided by the number of TRxPs and is measured in bit/s/Hz/TRxP.

As required by Report ITU-R M.2412 [6], average spectral efficiency and 5th percentile user spectral efficiency are assessed jointly using the same simulation.

5.4.1 NR

Average spectral efficiency and 5th percentile user spectral efficiency are evaluated for NR. Both NR FDD and TDD are evaluated. A wide range of antenna configurations and transmission schemes are considered. Detailed evaluation assumptions and results can be found in Annex B.4.1.

The antenna configuration is indicated as $(M, N, P, M_g, N_g; M_p, N_p)$, where M and N are the number of vertical, horizontal antenna elements within a panel, P is number of polarizations, M_g is the number of panels in a column, N_g is

the number of panels in row; and M_p and N_p are the number of vertical, horizontal TXRUs within a panel and polarization.

5.4.1.1 Indoor Hotspot – eMBB

Evaluation configuration A (carrier frequency = 4 GHz) and evaluation configuration B (carrier frequency = 30 GHz) with either 12TRxP or 36TRxP cases are applied for the evaluations of Indoor Hotspot– eMBB test environment for NR.

5.4.1.1.1 Evaluation configuration A (CF = 4 GHz)

The evaluation results of DL spectral efficiency for NR FDD and NR TDD for evaluation configuration A with 12TRxP are provided in Table 5.4.1.1.1-1.

It is noted that for NR, the component carrier bandwidth can be larger than the simulation bandwidth as defined in Report ITU-R M.2412 [6]. For those larger bandwidth cases, the guard band ratio can be further decreased; and the OFDM symbol occupation by PDCCH is expected to be reduced, even to less than one OFDM symbol due to the capability of PDCCH resource sharing with PDSCH.

Such capabilities are evaluated in Indoor Hotspot - eMBB test environment as well as in Dense Urban – eMBB test environment and Rural – eMBB test environment, for DL spectral efficiency. The values of the assumed bandwidths are shown together with the evaluation results.

**Table 5.4.1.1.1-1 DL spectral efficiency for NR in Indoor Hotspot – eMBB
(Evaluation configuration A, CF=4 GHz, for 12TRxP)**

(a) NR FDD

Scheme and antenna configuration	Sub-carrier spacing (kHz)	ITU Requirement		Channel model A				Channel model B			
				Number of samples	BW= 10MHz	BW= 20MHz	BW= 40MHz	Number of samples	BW= 10MHz	BW= 20MHz	BW= 40MHz
32x4 MU-MIMO Type II Codebook; gNB Config. = (4,4,2,1,1;4,4)	15	Average [bit/s/Hz/TRxP]	9	10	10.95	12.38	13.24	7	10.98	12.43	13.29
		5 th -tile [bit/s/Hz]	0.3		0.36	0.41	0.43		0.37	0.42	0.45
32x4 MU-MIMO Type I Codebook; gNB Config = (4,4,2,1,1;4,4)	15	Average [bit/s/Hz/TRxP]	9	1	11.50	13.05	13.97	/	/	/	/
		5 th -tile [bit/s/Hz]	0.3		0.31	0.35	0.38		/	/	/
32x8 MU-MIMO Type II Codebook; gNB Config = (4,4,2,1,1;4,4)	15	Average [bit/s/Hz/TRxP]	9	2	10.43	11.76	12.57	1	10.66	12.11	12.97
		5 th -tile [bit/s/Hz]	0.3		0.39	0.44	0.47		0.47	0.54	0.58

(b) NR TDD

Scheme and antenna configuration	Sub-carrier spacing (kHz)	Frame structure	ITU Requirement		Channel model A			Channel model B				
					Number of samples	BW= 20MHz	BW= 40MHz	BW= 100MHz	Number of samples	BW= 20MHz	BW= 40MHz	BW= 100MHz
32x4 MU-MIMO, Reciprocity based; 4T SRS; gNB Config (4,4,2,1,1;4,4)	30	DDDSU	Average [bit/s/Hz/TRxP]	9	2	11.98	14.03	15.41	4	11.67	13.64	14.98
			5th-tile [bit/s/Hz]	0.3								
32x4 MU-MIMO, Reciprocity based; 4T SRS; gNB Config = (4,4,2,1,1;4,4)	15	DDDSU	Average [bit/s/Hz/TRxP]	9	1	12.77	14.65	/	2	11.78	13.44	/
			5th-tile [bit/s/Hz]	0.3								
32x4 MU-MIMO, Type II Codebook based; gNB Config = (4,4,2,1,1;4,4)	15	DSUUD	Average [bit/s/Hz/TRxP]	9	1	8.77	10.43	/	/	/	/	/
			5th-tile [bit/s/Hz]	0.3								
32x4 MU-MIMO, Type II Codebook; 4T SRS; gNB Config = (4,4,2,1,1;4,4)	15	DSUUD	Average [bit/s/Hz/TRxP]	9	1	13.27	15.18	/	1	13.55	15.5	/
			5th-tile [bit/s/Hz]	0.3								
32x4 MU-MIMO, Reciprocity based; 4T SRS; gNB Config = (4,4,2,1,1;4,4)	30	DSUUD	Average [bit/s/Hz/TRxP]	9	2	11.61	13.68	15.08	2	11.96	14.09	15.53
			5th-tile [bit/s/Hz]	0.3								
32x4 MU-MIMO, Reciprocity based; 4T SRS; gNB Config = (4,4,2,1,1;4,4)	15	DSUUD	Average [bit/s/Hz/TRxP]	9	3	11.73	13.46	/	4	11.81	13.49	/
			5th-tile [bit/s/Hz]	0.3								
32x4 MU-MIMO, Reciprocity based; 4T SRS; gNB Config=(4,4,2,1,1;4,4)	30	DDDD DDSUU	Average [bit/s/Hz/TRxP]	9	2	12.54	14.74	16.23	1	11.71	13.96	15.47
			5th-tile [bit/s/Hz]	0.3								
32x8 MU-MIMO, Reciprocity based; 2T SRS; gNB Config=(4,4,2,1,1;4,4)	15	DSUUD	Average [bit/s/Hz/TRxP]	9	1	9.37	10.79	/	/	/	/	/
			5th-tile [bit/s/Hz]	0.3								
32x4 MU-MIMO, Reciprocity based; 4T SRS; gNB Config=(4,4,2,1,1;4,4)	30	DDDSUD DSUU	Average [bit/s/Hz/TRxP]	9	1	11.37	13.64	15.17	1	11.59	13.91	15.47
			5th-tile [bit/s/Hz]	0.3								
32x8 MU-MIMO, Type II codebook; gNB Config=(4,4,2,1,1;4,4)	30	DDDSU	Average [bit/s/Hz/TRxP]	9	1	9.90	11.55	12.68	1	10.26	11.97	13.14
			5th-tile [bit/s/Hz]	0.3								

The evaluation results of DL spectral efficiency for NR FDD and NR TDD for evaluation configuration A with 36TRxP are provided in Table 5.4.1.1.1-2.

It is observed that both NR FDD and NR TDD fulfill the DL spectral efficiency requirement for all the above configurations in evaluation configuration A.

**Table 5.4.1.1.1-2 DL spectral efficiency for NR in Indoor Hotspot – eMBB
(Evaluation configuration A, CF=4 GHz, for 36TRxP)**

(a) NR FDD

Scheme and antenna configuration	Sub-carrier spacing (kHz)	ITU Requirement		Channel model A				Channel model B			
				Number of samples	BW= 10MHz	BW= 20MHz	BW= 40MHz	Number of samples	BW= 10MHz	BW= 20MHz	BW= 40MHz
32x4 MU-MIMO Type II Codebook; gNB@ Config = (8,16,2,1,1;2,8)	15	Average [bit/s/Hz/TRxP]	9	7	12.24	13.85	14.81	4	13.12	14.83	15.86
		5 th -tile [bit/s/Hz]	0.3		0.36	0.40	0.43		0.35	0.39	0.42
32x4 MU-MIMO Type I codebook; gNB Config = (4,4,2,1,1;4,4)	15	Average [bit/s/Hz/TRxP]	9	1	/	10.67	/	/	/	/	/
		5 th -tile [bit/s/Hz]	0.3		/	0.31	/		/	/	/

(b) NR TDD

Scheme and antenna configuration	Sub-carrier spacing (kHz)	Frame structure	ITU Requirement		Channel model A			Channel model B				
					Number of samples	BW= 20MHz	BW= 40MHz	BW= 100MHz	Number of samples	BW= 20MHz	BW= 40MHz	BW= 100MHz
32x4 MU-MIMO, Reciprocity based; 4T SRS; gNB Config = (8,16,2,1,1;2,8)	30	DDDSU	Average [bit/s/Hz/TRxP]	9	2	12.72	14.88	16.35	1	12.87	15.06	16.55
			5th-tile [bit/s/Hz]	0.3		0.41	0.48	0.53		0.39	0.46	0.50
32x4 MU-MIMO, Reciprocity based; 4T SRS; gNB Config = (8,16,2,1,1;2,8)	15	DDDSU	Average [bit/s/Hz/TRxP]	9	1	14.56	16.71	/	1	14.67	16.84	/
			5th-tile [bit/s/Hz]	0.3		0.39	0.44	/		0.39	0.45	/
32x4 MU-MIMO, Type II Codebook based; gNB Config = (8,16,2,1,1;2,8)	15	DSUUD	Average [bit/s/Hz/TRxP]	9	1	10.38	12.35	/	/	/	/	/
			5th-tile [bit/s/Hz]	0.3		0.33	0.40	/		/	/	/
32x4 MU-MIMO, Type II codebook; Reciprocity based; 4T SRS; gNB@ (M,N,P,Mg,Ng; Mp,Np) = (8,16,2,1,1;2,8)	15	DSUUD	Average [bit/s/Hz/TRxP]	9	2	12.16	13.88	/	2	12.37	14.12	/
			5th-tile [bit/s/Hz]	0.3		0.35	0.40	/		0.33	0.38	/
32x4 MU-MIMO, Reciprocity based; 4T SRS; gNB Config = (8,16,2,1,1;2,8)	30	DSUUD	Average [bit/s/Hz/TRxP]	9	1	13.00	15.18	16.66	1	13.17	15.38	16.88
			5th-tile [bit/s/Hz]	0.3		0.32	0.37	0.40		0.34	0.39	0.43
32x4 MU-MIMO, Reciprocity based; 4T SRS; gNB Config = (8,8,2,1,1;2,8)	30	DDDSU	Average [bit/s/Hz/TRxP]	9	1	9.48	11.05	12.12	1	9.46	11.03	12.11
			5th-tile [bit/s/Hz]	0.3		0.32	0.38	0.41		0.33	0.39	0.43

The evaluation results of UL spectral efficiency for NR FDD and TDD for evaluation configuration A with 12TRxP are provided in Table 5.4.1.1.1-3.

**Table 5.4.1.1.1-3 UL spectral efficiency for NR in Indoor Hotspot – eMBB
(Evaluation configuration A, CF=4 GHz, for 12TRxP)**

(a) NR FDD

Scheme and antenna configuration	Sub-carrier spacing (kHz)	ITU Requirement		Channel model A		Channel model B	
				Number of samples	BW=10MHz	Number of samples	BW=10MHz
2x32 SU-MIMO, OFDMA; gNB Config = (4,4,2,1,1;4,4)	15	Average [bit/s/Hz/TRxP]	6.75	3	8.75	1	8.87
		5th-tile [bit/s/Hz]	0.21		0.52		0.55
4x32 MU-MIMO, OFDMA; gNB Config = (4,4,2,1,1;4,4)	15	Average [bit/s/Hz/TRxP]	6.75	3	10.16	1	10.09
		5th-tile [bit/s/Hz]	0.21		0.44		0.41
4x32 SU-MIMO, OFDMA; gNB Config = (4,4,2,1,1;4,4)	15	Average [bit/s/Hz/TRxP]	6.75	3	8.88	4	8.42
		5th-tile [bit/s/Hz]	0.21		0.55		0.52

(b) NR TDD

Scheme and antenna configuration	Sub-carrier spacing (kHz)	Frame structure	ITU Requirement		Channel model A		Channel model B	
					Number of samples	BW=20MHz	Number of samples	BW=20MHz
2x32 SU-MIMO, Codebook based; gNB Config = (4,4,2,1,1;4,4)	30	DDDSU	Average [bit/s/Hz/TRxP]	6.75	1	6.95	2	7.70
			5 th -tile [bit/s/Hz]	0.21		0.39		0.44
2x32 SU-MIMO, Codebook based; gNB Config = (4,4,2,1,1;4,4)	15	DDDSU	Average [bit/s/Hz/TRxP]	6.75	1	7.17	1	7.26
			5 th -tile [bit/s/Hz]	0.21		0.40		0.41
4x32 SU-MIMO, Codebook based; gNB Config = (4,4,2,1,1;4,4)	30	DDDSU	Average [bit/s/Hz/TRxP]	6.75	1	7.58	1	7.62
			5 th -tile [bit/s/Hz]	0.21		0.43		0.43
4x32 SU-MIMO, Codebook based; gNB Config = (4,4,2,1,1;4,4)	15	DDDSU	Average [bit/s/Hz/TRxP]	6.75	1	7.87	1	7.95
			5 th -tile [bit/s/Hz]	0.21		0.44		0.45
4x32 MU-MIMO, Codebook based; gNB Config = (4,4,2,1,1;4,4)	15	DSUUD	Average [bit/s/Hz/TRxP]	6.75	1	12.22	/	/
			5 th -tile [bit/s/Hz]	0.21		0.59		/
4x32 SU-MIMO, Non-Codebook based; gNB Config = (4,4,2,1,1;4,4)	15	DSUUD	Average [bit/s/Hz/TRxP]	6.75	1	9.57	2	9.34
			5 th -tile [bit/s/Hz]	0.21		0.60		0.50
4x32 SU-MIMO, Non-Codebook based; gNB Config = (4,4,2,1,1;4,4)	30	DSUUD	Average [bit/s/Hz/TRxP]	6.75	1	9.25	1	8.99
			5 th -tile [bit/s/Hz]	0.21		0.58		0.52
4x32 SU-MIMO, Codebook based; gNB Configs = (4,4,2,1,1;4,4)	15	DSUUD	Average [bit/s/Hz/TRxP]	6.75	1	8.99	1	8.65
			5 th -tile [bit/s/Hz]	0.21		0.63		0.54
4x32 SU-MIMO, Codebook based; gNB Config = (4,4,2,1,1;4,4)	30	DSUUD	Average [bit/s/Hz/TRxP]	6.75	1	8.58	1	8.12
			5 th -tile [bit/s/Hz]	0.21		0.57		0.48
2x32 SU-MIMO, Codebook based; gNB Config = (4,4,2,1,1;4,4)	30	DSUUD	Average [bit/s/Hz/TRxP]	6.75	1	8.26	1	9.35
			5 th -tile [bit/s/Hz]	0.21		0.53		0.53
2x32 SU-MIMO, Codebook based; gNB Config = (4,4,2,1,1;4,4)	30	DDDSUDDSU	Average [bit/s/Hz/TRxP]	6.75	1	7.85	1	7.85
			5 th -tile [bit/s/Hz]	0.21		0.58		0.58
2x32 SU-MIMO, Codebook based; gNB Config = (4,4,2,1,1;4,4)	30	DDDSUDDSU	Average [bit/s/Hz/TRxP]	6.75	1	7.02	1	7.01
			5 th -tile [bit/s/Hz]	0.21		0.52		0.52
4x32 MU-MIMO, Codebook based; gNB Config = (4,4,2,1,1;4,4)	30	DDDSU	Average [bit/s/Hz/TRxP]	6.75	1	8.89	1	8.85
			5 th -tile [bit/s/Hz]	0.21		0.36		0.36

The evaluation results of UL spectral efficiency for NR FDD and TDD for evaluation configuration A with 36TRxP are provided in Table 5.4.1.1.1-4.

It is observed that both NR FDD and NR TDD fulfill the UL spectral efficiency requirement for all the above configurations in evaluation configuration A.

**Table 5.4.1.1.1-4 UL spectral efficiency for NR in Indoor Hotspot – eMBB
(Evaluation configuration A, CF=4 GHz, for 36TRxP)**

(a) NR FDD

Scheme and antenna configuration	Sub-carrier spacing (kHz)	ITU Requirement		Channel model A		Channel model B	
				Number of samples	BW=10MHz	Number of samples	BW=10MHz
4x32 MU-MIMO, OFDMA; gNB Config = (8,16,2,1,1;2,8)	15	Average [bit/s/Hz/TRxP]	6.75	1	14.52	/	/
		5 th -tile [bit/s/Hz]	0.21		0.55		/
2x32 MU-MIMO, OFDMA; gNB Config = (4,4,2,1,1;4,4)	15	Average [bit/s/Hz/TRxP]	6.75	2	7.17	/	/
		5 th -tile [bit/s/Hz]	0.21		0.27		/

(b) NR TDD

Scheme and antenna configuration	Sub-carrier spacing (kHz)	Frame structure	ITU Requirement		Channel model A		Channel model B	
					Number of samples	BW=20MHz	Number of samples	BW=20MHz
4x32 MU-MIMO; gNB Config = (8,16,2,1,1;2,8)	15	DSUUD	Average [bit/s/Hz/TRxP]	6.75	1	13.46	/	/
			5 th -tile [bit/s/Hz]	0.21		0.51		/

5.4.1.1.2 Evaluation configuration B (CF = 30 GHz)

The evaluation results of DL spectral efficiency for NR for evaluation configuration B with 12TRxP are provided in Table 5.4.1.1.2-1.

It is noted that for NR, the component carrier bandwidth can be larger than the simulation bandwidth as defined in Report ITU-R M.2412 [6]. For those larger bandwidth cases, the guard band ratio can be further decreased; and the OFDM symbol occupation by PDCCH is expected to be reduced, even to less than one OFDM symbol due to the capability of PDCCH resource sharing with PDSCH.

Such capabilities are evaluated for DL spectral efficiency. The values of the assumed bandwidths are shown together with the evaluation results.

**Table 5.4.1.1.2-1 DL spectral efficiency for NR in Indoor Hotspot – eMBB
(Evaluation configuration B, CF=30 GHz, for 12TRxP)**

(a) NR FDD

Scheme and antenna configuration	Sub-carrier spacing (kHz)	ITU Requirement		Number of samples	BW=40 MHz
8x4 MU-MIMO Type II codebook (2 panel@UE) gNB Config = (4,8,2,1,1;2,2) UE Config = (2,4,2,1,2; 1,1)	120	Average [bit/s/Hz/TRxP]	9	1	8.50
		5 th -tile [bit/s/Hz]	0.3		0.31
32x8 MU-MIMO Type II codebook (2 panel@UE) gNB Config = (4,4,2,1,1;4,4) UE Config = (2,4,2,1,2;1,1)	120	Average [bit/s/Hz/TRxP]	9	1	12.27
		5 th -tile [bit/s/Hz]	0.3		0.44
32x8 MU-MIMO Type II codebook (2 panel@UE) gNB Config = (4,4,2,1,1;4,4) UE Config = (2,4,2,1,2;1,1)	60	Average [bit/s/Hz/TRxP]	9	1	12.69
		5 th -tile [bit/s/Hz]	0.3		0.41

(b) NR TDD

Scheme and antenna configuration	Sub-carrier spacing (kHz)	Frame structure	ITU Requirement		Number of samples	BW= 80MHz / 100 MHz	BW= 200MHz	BW= 400MHz
			Average [bit/s/Hz/TRxP]	5th-tile [bit/s/Hz]				
32x8 MU-MIMO, Reciprocity based; 4T SRS (2 panel@UE) gNB Config = (4,4,2,1,1;4,4); UE Config = (2,4,2,1,2; 1,2)	60	DDDSU	Average [bit/s/Hz/TRxP]	9	3	12.77	14.51	/
			5th-tile [bit/s/Hz]	0.3		0.37	0.42	/
32x8 MU-MIMO, Reciprocity based; 4T SRS (2 panel@UE) gNB Config = (4,4,2,1,1;4,4); UE Config = (2,4,2,1,2; 1,2)	120	DDDSU	Average [bit/s/Hz/TRxP]	9	1	13.86	15.49	16.25
			5th-tile [bit/s/Hz]	0.3		0.48	0.53	0.56
32x4 MU-MIMO, Type II Codebook based (2 panel@UE) gNB Config = (8,8,2,1,1;4,4); UE Config = (2,4,2,1,2; 1,1)	120	DSUUD	Average [bit/s/Hz/TRxP]	9	1	/	9.80	10.46
			5th-tile [bit/s/Hz]	0.3		/	0.40	0.42
32x8 MU-MIMO, Reciprocity based; 4T SRS (2 panel@UE) gNB Config = (8,8,2,1,1;2,8); UE Config = (2,4,2,1,2; 1,2)	60	DSUUD	Average [bit/s/Hz/TRxP]	9	2	13.71	15.87	/
			5th-tile [bit/s/Hz]	0.3		0.57	0.66	/
32x8 MU-MIMO, Reciprocity based; 4T SRS (2 panel@UE) gNB Config = (8,8,2,1,1;2,8); UE Config = (2,4,2,1,2; 1,2)	120	DSUUD	Average [bit/s/Hz/TRxP]	9	1	14.93	16.95	17.65
			5th-tile [bit/s/Hz]	0.3		0.61	0.69	0.72
64x8 MU-MIMO, Reciprocity based ; 4T SRS (2 panel@UE) gNB Config = (8,16,2,1,1;2,16); UE Config = (2,4,2,1,2; 1,2)	60	DSUUD	Average [bit/s/Hz/TRxP]	9	1	16.75	19.22	/
			5th-tile [bit/s/Hz]	0.3		1.00	1.14	/
64x8 MU-MIMO, Reciprocity based; 4T SRS (2 panel@UE) gNB Config = (8,16,2,1,1;2,16); UE Config = (2,4,2,1,2; 1,2)	120	DSUUD	Average [bit/s/Hz/TRxP]	9	1	16.84	19.12	19.91
			5th-tile [bit/s/Hz]	0.3		1.00	1.13	1.18
64x16 MU-MIMO, Reciprocity based ; 4T SRS (2 panel@UE) gNB Config = (4,32,2,1,1;1,32); UE Config = (1,4,2,1,2; 1,4)	60	DDDSU	Average [bit/s/Hz/TRxP]	9	1	13.90	16.87	/
			5th-tile [bit/s/Hz]	0.3		0.35	0.42	/
8x2 MU-MIMO, Reciprocity based; 2T SRS (1 panel@UE) gNB Config = (16,8,2,1,1;2,2); UE Config = (4,4,2,1,1; 1,2)	120	DDDU	Average [bit/s/Hz/TRxP]	9	1	12.03	14.40	14.97
			5th-tile [bit/s/Hz]	0.3		0.49	0.58	0.60
32x8 MU-MIMO, Reciprocity based; 4T SRS (2 panel@UE) gNB Config = (8,16,2,1,1;4,4); UE Config = (2,4,2,1,2; 1,2)	120	DDDSU	Average [bit/s/Hz/TRxP]	9	1	11.03	12.53	13.01
			5th-tile [bit/s/Hz]	0.3		0.40	0.46	0.47

The evaluation results of DL spectral efficiency for NR for evaluation configuration B with 36TRxP are provided in Table 5.4.1.1.2-2.

It is observed that NR fulfills the DL spectral efficiency requirement for all the above configurations in evaluation configuration B.

**Table 5.4.1.1.2-2 DL spectral efficiency for NR in Indoor Hotspot – eMBB
(Evaluation configuration B, CF=30 GHz, for 36TRxP)**

(a) NR TDD

Scheme and antenna configuration	Sub-carrier spacing (kHz)	Frame structure	ITU Requirement		Number of samples	BW= 80MHz / 100MHz	BW= 200MHz	BW= 400MHz
			Average [bit/s/Hz/TRxP]	5th-tile [bit/s/Hz]				
32x4 MU-MIMO Type II Codebook based (2 panel@UE) gNB Config = (8,8,2,1,1;4,4) UE Config = (2,4,2,1,2; 1,1)	120	DSUUD	Average [bit/s/Hz/TRxP]	9	1	/	10.04	10.72
			5th-tile [bit/s/Hz]	0.3		/	0.34	0.36
32x8 MU-MIMO, Reciprocity based; 4Tx SRS (2 panel@UE) gNB Config = (4,16,2,1,1;1,16) UE Config = (2,4,2,1,2; 1,2)	60	DSUUD	Average [bit/s/Hz/TRxP]	9	1	12.72	14.60	/
			5th-tile [bit/s/Hz]	0.3		0.38	0.43	/
32x8 MU-MIMO, Reciprocity based; 4Tx SRS (2 panels@UE) gNB Config = (4,16,2,1,1;1,16) UE Config = (2,4,2,1,2; 1,2)	120	DSUUD	Average [bit/s/Hz/TRxP]	9	1	12.11	13.75	14.32
			5th-tile [bit/s/Hz]	0.3		0.31	0.35	0.36
64x8 MU-MIMO, Reciprocity based; 4T SRS (2 panel@UE) gNB Config = (8,16,2,1,1;2,16) UE Config = (2,4,2,1,2; 1,2)	60	DSUUD	Average [bit/s/Hz/TRxP]	9	1	14.85	17.05	/
			5th-tile [bit/s/Hz]	0.3		0.48	0.56	/
64x8 MU-MIMO, Reciprocity based; 4T SRS (2 panel@UE) gNB Config = (8,16,2,1,1;2,16); UE Config = (2,4,2,1,2; 1,2)	60	DSUUD	Average [bit/s/Hz/TRxP]	9	1	14.22	16.14	16.81
			5th-tile [bit/s/Hz]	0.3		0.49	0.56	0.58

The evaluation results of UL spectral efficiency for NR for evaluation configuration B with 12TRxP are provided in Table 5.4.1.1.2-3.

**Table 5.4.1.1.2-3 UL spectral efficiency for NR in Indoor Hotspot – eMBB
(Evaluation configuration B, CF=30 GHz, for 12TRxP)**

(a) NR FDD

Scheme and antenna configuration	Sub-carrier spacing (kHz)	ITU Requirement		Number of samples	BW=40MHz
		Average [bit/s/Hz/TRxP]	5 th -tile [bit/s/Hz]		
4x8 MU-MIMO, OFDMA (2 panel@UE); gNB Config= (4,8,2,1,1; 2,2) UE Config = (2,4,2,1,2; 1,1)	120	Average [bit/s/Hz/TRxP]	6.75	1	7.66
		5 th -tile [bit/s/Hz]	0.21		0.39
8x32 SU-MIMO, OFDMA (2 panel@UE); gNB Config= (4,4,2,1,1; 4,4) UE Config = (2,4,2,1,2; 1,1)	60	Average [bit/s/Hz/TRxP]	6.75	1	10.39
		5 th -tile [bit/s/Hz]	0.21		0.41

(b) NR TDD

Scheme and antenna configuration	Sub-carrier spacing (kHz)	Frame structure	ITU Requirement		Number of samples	BW=80MHz
			Average [bit/s/Hz/TRxP]	5 th -tile [bit/s/Hz]		
8x32 SU-MIMO, Codebook based, OFDMA (2 panel@UE); gNB Config = (4,4,2,1,1;4,4); UE Config = (2,4,2,1,2; 1,2)	60	DDDSU	Average [bit/s/Hz/TRxP]	6.75	1	7.04
			5 th -tile [bit/s/Hz]	0.21		0.40
4x32 MU-MIMO, Codebook based, OFDMA (2 panel@UE); gNB Config = (8,8,2,1,1;4,4); UE Config = (2,4,2,1,2; 1,1)	120	DSUUD	Average [bit/s/Hz/TRxP]	6.75	1	10.91
			5 th -tile [bit/s/Hz]	0.21		0.41
8x32 SU-MIMO, Non-codebook based, OFDMA (2 panel@UE); gNB Config = (8,8,2,1,1;2,8); UE Config = (2,4,2,1,2; 1,2)	60	DSUUD	Average [bit/s/Hz/TRxP]	6.75	1	7.44
			5 th -tile [bit/s/Hz]	0.21		0.37
8x64 MU-MIMO Codebook based (1 panel@UE); gNB Config = (4,32,2,1,1;1,32) UE Config = (1,4,2,1,1; 1,4)	60	DDDSU	Average [bit/s/Hz/TRxP]	6.75	1	10.19
			5 th -tile [bit/s/Hz]	0.21		0.31
4x2, SU-MIMO, Codebook based, OFDMA (1 panel @UE) gNB Config = (16,8,2,1,1;1,1) UE Config = (4,4,2,1,1; 1,2)	120	DDDU	Average [bit/s/Hz/TRxP]	6.75	1	6.90
			5 th -tile [bit/s/Hz]	0.21		0.30
8x16, MU-MIMO, Codebook based, OFDMA (2 panel@UE) gNB Config = (4,16,2,1,1;4,4) UE Config = (2,4,2,1,1; 1,2)	120	DDDSU	Average [bit/s/Hz/TRxP]	6.75	1	7.83
			5 th -tile [bit/s/Hz]	0.21		0.37
8x32, SU-MIMO, Codebook based, OFDMA (2 panel@UE) gNB Config = (8,8,2,1,1;4,4) UE Config = (2,4,2,1,1; 1,2)	60	DSUDD	Average [bit/s/Hz/TRxP]	6.75	1	7.44
			5 th -tile [bit/s/Hz]	0.21		0.32

The evaluation results of UL spectral efficiency for NR for evaluation configuration B with 36TRxP are provided in Table 5.4.1.1.2-4.

It is observed that NR fulfills the UL spectral efficiency requirement for all the above configurations in evaluation configuration B.

**Table 5.4.1.1.2-4 UL spectral efficiency for NR in Indoor Hotspot – eMBB
(Evaluation configuration B, CF=30 GHz, for 36TRxP)**

(a) NR TDD

Scheme and antenna configuration	Sub-carrier spacing (kHz)	Frame structure	ITU Requirement		Number of samples	BW=80MHz
			Average [bit/s/Hz/TRxP]	5 th -tile [bit/s/Hz]		
4x32 MU-MIMO OFDMA, gNB Config = (8,8,2,1,1;4,4) UE Config = (2,4,2,1,2; 1,1)	120	DSUUD	Average [bit/s/Hz/TRxP]	6.75	1	9.82
			5 th -tile [bit/s/Hz]	0.21		0.33

5.4.1.2 Dense Urban – eMBB

Evaluation configuration A (carrier frequency = 4 GHz) is applied for the evaluations of Dense Urban – eMBB test environment for NR.

5.4.1.2.1 Evaluation configuration A (CF = 4 GHz)

The evaluation results of DL spectral efficiency for NR FDD and NR TDD for evaluation configuration A are provided in Table 5.4.1.2.1-1.

Similar to Indoor Hotspot – eMBB test environment, the capability of NR in larger bandwidth are evaluated for DL spectral efficiency. The values of the larger bandwidths are shown together with the evaluation results.

It is observed that both NR FDD and TDD fulfill the DL spectral efficiency requirement for these configurations in evaluation configuration A.

Table 5.4.1.2.1-1 DL spectral efficiency for NR in Dense Urban – eMBB
(Evaluation configuration A, CF=4 GHz)

(a) NR FDD

Scheme and antenna configuration	Sub-carrier spacing (kHz)	ITU Requirement		Channel model A			Channel model B				
				Number of samples	BW= 10MHz	BW= 20MHz	BW= 40MHz	Number of samples	BW= 10MHz	BW= 20MHz	BW= 40MHz
32x4 MU-MIMO Type II Codebook; gNB Config = (8,8,2,1,1;2,8)	15	Average [bit/s/Hz/TRxP]	7.8	11	11.04	12.52	13.39	9	10.95	12.42	13.28
		5 th -tile [bit/s/Hz]	0.225		0.37	0.42	0.45		0.36	0.41	0.43
32x4 MU-MIMO Type I Codebook; gNB Config = (8,8,2,1,1;2,8)	15	Average [bit/s/Hz/TRxP]	7.8	2	10.95	12.33	13.16	/	/	/	/
		5 th -tile [bit/s/Hz]	0.225		0.33	0.38	0.40		/	/	/
32x4 MU-MIMO Type II Codebook; gNB Config = (8,16,2,1,1;1,16)	15	Average [bit/s/Hz/TRxP]	7.8	1	14.81	16.84	18.04	/	/	/	/
		5 th -tile [bit/s/Hz]	0.225		0.54	0.61	0.65		/	/	/
32x4 MU-MIMO Type II Codebook; gNB Config = (16,8,2,1,1;2,8)	15	Average [bit/s/Hz/TRxP]	7.8	1	12.65	14.3	15.28	1	12.31	13.91	14.87
		5 th -tile [bit/s/Hz]	0.225		0.44	0.50	0.54		0.44	0.49	0.53
32x8 MU-MIMO Type II Codebook; gNB Config = (16,8,2,1,1;2,8)	15	Average [bit/s/Hz/TRxP]	7.8	1	11.83	13.26	14.13	/	/	/	/
		5 th -tile [bit/s/Hz]	0.225		0.33	0.37	0.40		/	/	/

(b) NR TDD

Scheme and antenna configuration	Sub-carrier spacing (kHz)	Frame structure	ITU Requirement		Channel model A			Channel model B				
					Number of samples	BW= 20MHz	BW= 40MHz	BW= 100MHz	Number of samples	BW= 20MHz	BW= 40MHz	BW= 100MHz
32x4 MU-MIMO, Reciprocity based; 4T SRS; gNB Config = (8,8,2,1,1;2,8)	30	DDDSU	Average [bit/s/Hz/TRxP]	7.8	4	13.03	15.26	16.77	4	13.07	15.20	16.60
			5 th -tile [bit/s/Hz]	0.225		0.47	0.55	0.61		0.45	0.53	0.57
32x4 MU-MIMO, Reciprocity based; 4T SRS; gNB Config = (8,8,2,1,1;2,8)	15	DDDSU	Average [bit/s/Hz/TRxP]	7.8	2	13.95	15.88	/	4	11.77	13.36	/
			5 th -tile [bit/s/Hz]	0.225		0.34	0.38	/		0.39	0.44	/
64x4 MU-MIMO, Reciprocity based; 4T SRS; gNB Config = (12,8,2,1,1;4,8)	30	DDDSU	Average [bit/s/Hz/TRxP]	7.8	1	16.10	18.84	20.70	2	16.23	19.14	21.11
			5 th -tile [bit/s/Hz]	0.225		0.49	0.58	0.64		0.52	0.62	0.68
64x4 MU-MIMO, Reciprocity based; 4T SRS; gNB Config = (12,8,2,1,1;4,8)	15	DDDSU	Average [bit/s/Hz/TRxP]	7.8	1	15.71	18.02	/	1	15.46	17.73	/
			5 th -tile [bit/s/Hz]	0.225		0.48	0.56	/		0.49	0.56	/
32x4 MU-MIMO, Type II Codebook based; gNB Config = (8,16,2,1,1;1,16)	15	DSUUD	Average [bit/s/Hz/TRxP]	7.8	1	12.25	14.56	/	/	/	/	/
			5 th -tile [bit/s/Hz]	0.225		0.44	0.53	/		/	/	/
32x4 MU-MIMO, Reciprocity based; 4T SRS; gNB Config = (16,8,2,1,1;2,8)	15	DSUUD	Average [bit/s/Hz/TRxP]	7.8	1	13.11	15.00	/	1	12.81	14.66	/
			5 th -tile [bit/s/Hz]	0.225		0.42	0.48	/		0.41	0.46	/
32x4 MU-MIMO, Reciprocity based; 4T SRS; gNB Config = (8,8,2,1,1;2,8)	15	DSUUD	Average [bit/s/Hz/TRxP]	7.8	2	12.54	14.39	/	2	13.64	15.46	/
			5 th -tile [bit/s/Hz]	0.225		0.36	0.41	/		0.41	0.46	/
32x4 MU-MIMO, Reciprocity based; 4T SRS; gNB Config = (16,8,2,1,1;2,8)	30	DSUUD	Average [bit/s/Hz/TRxP]	7.8	1	12.88	15.04	16.50	1	12.50	14.59	16.02
			5 th -tile [bit/s/Hz]	0.225		0.43	0.50	0.55		0.40	0.47	0.52
64x4 MU-MIMO, Reciprocity based; 4T SRS; gNB Config = (12,8,2,1,1;4,8)	15	DSUUD	Average [bit/s/Hz/TRxP]	7.8	1	15.72	18.01	/	1	15.73	18.03	/
			5 th -tile [bit/s/Hz]	0.225		0.59	0.68	/		0.57	0.65	/
64x4 MU-MIMO, Reciprocity based; 4T SRS; gNB Config = (16,8,2,1,1;4,8)	15	DSUUD	Average [bit/s/Hz/TRxP]	7.8	1	16.23	18.60	/	1	16.28	18.66	/
			5 th -tile [bit/s/Hz]	0.225		0.60	0.68	/		0.61	0.7	/
64x4 MU-MIMO, Reciprocity based; 4T SRS; gNB Config = (12,8,2,1,1;4,8)	30	DSUUD	Average [bit/s/Hz/TRxP]	7.8	2	16.00	18.86	20.8	2	15.89	18.73	20.66
			5 th -tile [bit/s/Hz]	0.225		0.58	0.69	0.76		0.57	0.67	0.74
64x4 MU-MIMO, Reciprocity based; 4T SRS; gNB Config = (16,8,2,1,1;4,8)	30	DSUUD	Average [bit/s/Hz/TRxP]	7.8	1	15.9	18.59	20.42	1	15.87	18.55	20.38
			5 th -tile [bit/s/Hz]	0.225		0.61	0.71	0.78		0.62	0.73	0.80
64x8 MU-MIMO, Reciprocity based; 4T SRS;	15	DDDSU	Average [bit/s/Hz/TRxP]	7.8	1	12.20	14.82	/	/	/	/	/

gNB Config = (4,32,2,1,1,1,32)			5 th -tile [bit/s/Hz]	0.225		0.30	0.36	/		/	/	/
64x4 MU-MIMO, Reciprocity based; 4T SRS; gNB Config = (12,8,2,1,1,4,8)	30	DDDDD DDSUU	Average [bit/s/Hz/TRxP]	7.8	1	16.07	18.95	20.89	/	/	/	/
			5 th -tile [bit/s/Hz]	0.225		0.42	0.50	0.55		/	/	/
32x8 MU-MIMO, Reciprocity based; 2T SRS; gNB Config = (16,8,2,1,1,2,8)	15	DSUUD	Average [bit/s/Hz/TRxP]	7.8	1	11.90	13.70	/	/	/	/	/
			5 th -tile [bit/s/Hz]	0.225		0.32	0.36	/		/	/	/
32x4 MU-MIMO, Reciprocity based; 2T SRS; gNB Config = (16,8,2,1,1,2,8)	15	DSUUD	Average [bit/s/Hz/TRxP]	7.8	1	7.87	9.06	/	/	/	/	/
			5 th -tile [bit/s/Hz]	0.225		0.23	0.26	/		/	/	/
128x4, MU-MIMO, Reciprocity based; 4T SRS; gNB Config = (8,16,2,1,1,4,16)	30	DDSU	Average [bit/s/Hz/TRxP]	7.8	/	/	/	/	1	10.78	12.56	13.78
			5 th -tile [bit/s/Hz]	0.225		/	/	/		0.36	0.42	0.46
64x4 MU-MIMO, Reciprocity based; 4T SRS; gNB Config = (8,8,2,1,1,4,8)	30	DDDSU	Average [bit/s/Hz/TRxP]	7.8	1	14.99	17.51	19.23	1	15.08	17.62	19.34
			5 th -tile [bit/s/Hz]	0.225		0.62	0.72	0.79		0.54	0.63	0.69
16x4 MU-MIMO, Reciprocity based; 4T SRS; gNB Config = (8,8,2,1,1,1,8)	30	DSUUD	Average [bit/s/Hz/TRxP]	7.8	1	9.59	11.19	12.29	1	9.51	11.11	12.19
			5 th -tile [bit/s/Hz]	0.225		0.38	0.44	0.49		0.39	0.45	0.50
32x4 MU-MIMO, Reciprocity based; 4T SRS; gNB Config = (8,8,2,1,1,2,8)	30	DDDDD DDSUU	Average [bit/s/Hz/TRxP]	7.8	1	13.05	15.55	17.23	1	13.35	15.91	17.63
			5 th -tile [bit/s/Hz]	0.225		0.54	0.64	0.71		0.46	0.55	0.61
64x4 MU-MIMO, Reciprocity based; 4T SRS; gNB Config = (12,8,2,1,1,4,8)	30	DDDSU DDSUU	Average [bit/s/Hz/TRxP]	7.8	1	16.73	20.08	22.33	1	16.59	19.91	22.14
			5 th -tile [bit/s/Hz]	0.225		0.61	0.73	0.81		0.57	0.68	0.76

The evaluation results of UL spectral efficiency for NR FDD and NR TDD for evaluation configuration A are provided in Table 5.4.1.2.1-2.

It is observed that both NR FDD and TDD fulfill the UL spectral efficiency requirement for these configurations in evaluation configuration A.

**Table 5.4.1.2.1-2 UL spectral efficiency for NR in Dense Urban – eMBB
(Evaluation configuration A, CF=4 GHz)**

(a) NR FDD

Scheme and antenna configuration	Sub-carrier spacing (kHz)	ITU Requirement		Channel model A		Channel model B	
				Number of samples	BW=10MHz	Number of samples	BW=10MHz
2x16 SU-MIMO, OFDMA; gNB Config = (8,8,2,1,1;1,8)	15	Average [bit/s/Hz/TRxP]	5.4	4	7.69	1	6.67
		5 th -tile [bit/s/Hz]	0.15		0.25		0.22
2x32 SU-MIMO, OFDMA; gNB Config = (8,8,2,1,1;2,8)	15	Average [bit/s/Hz/TRxP]	5.4	2	7.31	3	7.53
		5 th -tile [bit/s/Hz]	0.15		0.37		0.34
4x32 SU-MIMO, OFDMA; gNB Config = (8,8,2,1,1;2,8)	15	Average [bit/s/Hz/TRxP]	5.4	2	9.88	2	9.23
		5 th -tile [bit/s/Hz]	0.15		0.42		0.43
4x32 MU-MIMO, OFDMA; gNB Config = (8,16,2,1,1;1,16)	15	Average [bit/s/Hz/TRxP]	5.4	1	19.00	/	/
		5 th -tile [bit/s/Hz]	0.15		1.00		/
4x32 MU-MIMO, OFDMA; gNB Config = (16,8,2,1,1;2,8)	15	Average [bit/s/Hz/TRxP]	5.4	1	7.08	/	/
		5 th -tile [bit/s/Hz]	0.15		0.24		/
4x16 SU-MIMO, OFDMA; gNB Config = (8,8,2,1,1;1,8)	15	Average [bit/s/Hz/TRxP]	5.4	1	6.09	1	6.40
		5 th -tile [bit/s/Hz]	0.15		0.33		0.35
4x4 SU-MIMO, OFDMA; gNB Config = (8,8,2,1,1;2,1)	15	Average [bit/s/Hz/TRxP]	5.4	1	9.57	/	/
		5 th -tile [bit/s/Hz]	0.15		0.19		/

(b) NR TDD

Scheme and antenna configuration	Sub-carrier spacing (kHz)	Frame structure	ITU Requirement		Channel model A		Channel model B	
					Number of samples	BW=20MHz	Number of samples	BW=20MHz
2x32 SU-MIMO, Codebook based, OFDMA; gNB Config = (8,8,2,1,1;2,8)	30	DDDSU	Average [bit/s/Hz/TRxP]	5.4	1	6.14	1	6.11
			5 th -tile [bit/s/Hz]	0.15		0.28		0.25
2x32 SU-MIMO, Codebook based, OFDMA; gNB Config = (8,8,2,1,1;2,8)	15	DDDSU	Average [bit/s/Hz/TRxP]	5.4	1	6.57	1	6.48
			5 th -tile [bit/s/Hz]	0.15		0.28		0.25
2x64 SU-MIMO, Codebook based, OFDMA; gNB Config = (12,8,2,1,1;4,8)	30	DDDSU	Average [bit/s/Hz/TRxP]	5.4	1	7.03	2	7.21
			5 th -tile [bit/s/Hz]	0.15		0.36		0.41
2x64 SU-MIMO, Codebook based, OFDMA; gNB Config = (12,8,2,1,1;4,8)	15	DDDSU	Average [bit/s/Hz/TRxP]	5.4	1	7.49	1	7.47
			5 th -tile [bit/s/Hz]	0.15		0.36		0.29
4x32 SU-MIMO, Codebook based, OFDMA; gNB Config = (8,8,2,1,1;2,8)	30	DDDSU	Average [bit/s/Hz/TRxP]	5.4	1	6.73	2	7.64
			5 th -tile [bit/s/Hz]	0.15		0.33		0.35
4x32 SU-MIMO, Codebook based, OFDMA; gNB Config = (8,8,2,1,1;2,8)	15	DDDSU	Average [bit/s/Hz/TRxP]	5.4	2	8.02	2	7.71
			5 th -tile [bit/s/Hz]	0.15		0.33		0.34
4x32 MU-MIMO, Codebook based, OFDMA; gNB Config = (8,16,2,1,1;1,16)	15	DSUUD	Average [bit/s/Hz/TRxP]	5.4	1	17.57	/	/
			5 th -tile [bit/s/Hz]	0.15		0.93		/
4x16 SU-MIMO, Non-codebook based,OFDMA; gNB Config = (8,8,2,1,1;1,8)	15	DSUUD	Average [bit/s/Hz/TRxP]	5.4	1	6.56	1	6.90
			5 th -tile [bit/s/Hz]	0.15		0.27		0.32
4x16 SU-MIMO, Non-codebook based,OFDMA; gNB Config = (8,8,2,1,1;1,8)	30	DSUUD	Average [bit/s/Hz/TRxP]	5.4	1	6.28	1	6.34
			5 th -tile [bit/s/Hz]	0.15		0.26		0.35
4x16 SU-MIMO, codebook based,OFDMA; gNB Config = (8,8,2,1,1;1,8)	15	DSUUD	Average [bit/s/Hz/TRxP]	5.4	1	6.05	1	6.43
			5 th -tile [bit/s/Hz]	0.15		0.25		0.28
4x16 SU-MIMO, codebook based,OFDMA; gNB Config = (8,8,2,1,1;1,8)	30	DSUUD	Average [bit/s/Hz/TRxP]	5.4	1	5.69	1	6.02
			5 th -tile [bit/s/Hz]	0.15		0.23		0.29
8x64 MU-MIMO, Codebook based, OFDMA; gNB Config = (4,32,2,1,1;1,32)	15	DDDSU	Average [bit/s/Hz/TRxP]	5.4	1	7.28	/	/
			5 th -tile [bit/s/Hz]	0.15		0.16		/
2x32 SU-MIMO, Codebook based, OFDMA; gNB Config = (12,8,2,1,1;4,4)	30	DSUUD	Average [bit/s/Hz/TRxP]	5.4	/	/	1	8.16
			5 th -tile [bit/s/Hz]	0.15		/		0.55
2x64 SU-MIMO, Codebook based, OFDMA; gNB Config = (12,8,2,1,1;4,8)	30	DSUUD	Average [bit/s/Hz/TRxP]	5.4	1	8.28	1	8.24
			5 th -tile [bit/s/Hz]	0.15		0.60		0.58
4x128, MU-MIMO, Codebook based, OFDMA; gNB Config = (8,16,2,1,1;4,16)	30	DDSU	Average [bit/s/Hz/TRxP]	5.4	/	/	1	5.51
			5 th -tile [bit/s/Hz]	0.15		/		0.17
2x64 SU-MIMO, Codebook based, OFDMA; gNB Config = (12,8,2,1,1;4,8)	30	DDDSUD DSUU	Average [bit/s/Hz/TRxP]	5.4	1	7.86	1	7.87
			5 th -tile [bit/s/Hz]	0.15		0.52		0.52

2x64 SU-MIMO, Codebook based, OFDMA: gNB Config = (12,8,2,1,1;4,8)	30	DDDDDD DSUU	Average [bit/s/Hz/TRxP]	5.4	1	7.03	1	7.04
			5 th -tile [bit/s/Hz]	0.15		0.47		0.47
4x32 SU-MIMO, Non-codebook based, OFDMA: gNB Config = (8,8,2,1,1;2,8)	15	DSUUD	Average [bit/s/Hz/TRxP]	5.4	/	/	1	10.47
			5 th -tile [bit/s/Hz]	0.15		/		0.38
4x32 SU-MIMO, Non-codebook based, OFDMA: gNB Config = (8,8,2,1,1;2,8)	15	DDDSU	Average [bit/s/Hz/TRxP]	5.4	/	/	1	8.86
			5 th -tile [bit/s/Hz]	0.15		/		0.28

5.4.1.2.2 Evaluation configuration B (CF=30 GHz)

The evaluation results for DL spectral efficiency for configuration B are shown in Table 5.4.1.2.2-1. The bandwidth of 80/100 MHz, 200 MHz and 400 MHz are evaluated for TDD.

Table 5.4.1.2.2-1 DL spectral efficiency for NR in Dense Urban – eMBB (Evaluation configuration B, CF=30 GHz)

(a) NR TDD

Scheme and antenna configuration	Sub-carrier spacing (kHz)	Frame structure	ITU Requirement		Number of samples	BW= 80MHz / 100 MHz	BW= 200MHz	BW= 400MHz
			Average [bit/s/Hz/TRxP]					
32x32 MU-MIMO, Reciprocity based; 4T SRS (2 panel@UE) gNB Config = (8,16,2,1,1;1,16); UE Config = (2,8,2,1,1; 1,8)	60	DSUUD	Average [bit/s/Hz/TRxP]	7.8	1	9.83	11.28	/
			5 th -tile [bit/s/Hz]	0.225		0.02	0.02	/
64x32 MU-MIMO, Reciprocity based; 4T SRS (2 panel@UE) gNB Config = (8,16,2,1,1;2,16); UE Config = (2,8,2,1,1; 1,8)	60	DSUUD	Average [bit/s/Hz/TRxP]	7.8	1	11.14	12.79	/
			5 th -tile [bit/s/Hz]	0.225		0.05	0.06	/
128x8 MU-MIMO, Reciprocity based; 4T SRS (2 panel@UE) gNB Config = (8,16,2,1,1;4,16); UE Config = (2,4,2,1,2; 1,2)	120	DDDSU	Average [bit/s/Hz/TRxP]	7.8	1	19.30	21.50	22.60
			5 th -tile [bit/s/Hz]	0.225		0.05	0.06	0.06
128x8 MU-MIMO, Type 1 codebook; Wideband (2 panel@UE) gNB Config = (8,16,2,1,1;4,16); UE Config = (2,4,2,1,2; 1,2)	120	DDDSU	Average [bit/s/Hz/TRxP]	7.8	1	15.30	17.10	18.00
			5 th -tile [bit/s/Hz]	0.225		0.05	0.06	0.06

The evaluation results of UL spectral efficiency for configuration B are provided in Table 5.4.1.2.2-2.

**Table 5.4.1.2.2-2 UL spectral efficiency for NR in Dense Urban – eMBB
(Evaluation configuration B, CF=30 GHz)**

(a) NR TDD

Scheme and antenna configuration	Sub-carrier spacing (kHz)	Frame structure	ITU Requirement		Number of samples	BW=80MHz / 100MHz
			Average [bit/s/Hz/TRxP]	5 th -tile [bit/s/Hz]		
8x32 SU-MIMO, Codebook based, OFDMA, (2 panel@UE); gNB Config = (4,8,2,2,2;1,1) UE Config = (2,4,2,1,2; 1,2)	120	DSUUD	Average [bit/s/Hz/TRxP]	5.4	1	6.93
			5 th -tile [bit/s/Hz]	0.15		0.04
8x128 MU-MIMO, Codebook based, OFDMA, (2 panel@UE); gNB Config = (8,16,2,1,1;4,16) UE Config = (2,4,2,1,2; 1,2)	120	DDDSU	Average [bit/s/Hz/TRxP]	5.4	1	10.10
			5 th -tile [bit/s/Hz]	0.15		0.06

Further evaluation results of configuration B, with modified ITU-R parameters, are shown in Appendix B.5 for information purpose.

5.4.1.3 Rural – eMBB

Evaluation configuration A (carrier frequency = 700 MHz), evaluation configuration B (carrier frequency = 4 GHz), and evaluation configuration C (LMLC) are applied for the evaluations of Rural – eMBB test environment for NR.

5.4.1.3.1 Evaluation configuration A (CF = 700 MHz)

The evaluation results of DL spectral efficiency for NR FDD and NR TDD for evaluation configuration A are provided in Table 5.4.1.3.1-1.

Similar to Indoor Hotspot – eMBB test environment, the capability of NR in larger bandwidth are evaluated for DL spectral efficiency. The values of the assumed bandwidths are shown together with the evaluation results.

It is observed that both NR FDD and TDD fulfill the DL spectral efficiency requirement for these configurations in evaluation configuration A.

**Table 5.4.1.3.1-1 DL spectral efficiency for NR in Rural – eMBB
(Evaluation configuration A, CF=700 MHz)**

(a) NR FDD

Scheme and antenna configuration	Sub-carrier spacing (kHz)	ITU Requirement		Channel model A			Channel model B				
				Number of samples	BW= 10MHz	BW= 20MHz	BW= 40MHz	Number of samples	BW= 10MHz	BW= 20MHz	BW= 40MHz
8x2 MU-MIMO Type II Codebook; gNB Config = (8,4,2,1,1;1,4)	15	Average [bit/s/Hz/TRxP]	3.3	9	5.92	6.66	7.1	7	5.83	6.53	6.94
		5 th -tile [bit/s/Hz]	0.12		0.16	0.18	0.20		0.17	0.19	0.20
16x2 MU-MIMO Type II Codebook; gNB Config = (8,4,2,1,1;2,4)	15	Average [bit/s/Hz/TRxP]	3.3	1	7.48	8.39	8.94	2	8.83	9.96	12.64
		5 th -tile [bit/s/Hz]	0.12		0.15	0.17	0.18		0.20	0.22	0.24
8x4 MU-MIMO Type II Codebook; gNB Config = (8,4,2,1,1;1,4)	15	Average [bit/s/Hz/TRxP]	3.3	1	9.42	10.66	11.40	1	9.08	10.27	10.99
		5 th -tile [bit/s/Hz]	0.12		0.16	0.18	0.19		0.17	0.19	0.21
16x4 MU-MIMO Type II Codebook; gNB Config = (4,8,2,1,1;1,8)	15	Average [bit/s/Hz/TRxP]	3.3	1	15.28	17.37	18.61	/	/	/	/
		5 th -tile [bit/s/Hz]	0.12		0.47	0.54	0.57		/	/	/
16x2 MU-MIMO Type II Codebook; gNB Config = (4,8,2,1,1;1,8)	15	Average [bit/s/Hz/TRxP]	3.3	1	9.58	10.81	11.55	1	10.02	11.23	11.96
		5 th -tile [bit/s/Hz]	0.12		0.25	0.28	0.30		0.27	0.30	0.32
8x2 MU-MIMO Type I codebook; gNB Config = (8,4,2,1,1;1,4)	15	Average [bit/s/Hz/TRxP]	3.3	2	6.08	6.82	7.27	/	/	/	/
		5 th -tile [bit/s/Hz]	0.12		0.15	0.17	0.19		/	/	/

(b) NR TDD

Scheme and antenna configuration	Sub-carrier spacing (kHz)	Frame structure	ITU Requirement		Channel model A			Channel model B				
					Number of samples	BW= 20MHz	BW= 40MHz	BW= 100MHz	Number of samples	BW= 20MHz	BW= 40MHz	BW= 100MHz
8x2 MU-MIMO, Reciprocity based; 2T SRS; gNB Config = {3,4,2,1,1;1,4}	30	DDDSU	Average [bit/s/Hz/TRxP]	3.3	4	6.77	7.80	8.50	4	6.47	7.43	8.12
			5 th -tile [bit/s/Hz]	0.12		0.16	0.19	0.21		0.18	0.21	0.23
8x2 MU-MIMO, Reciprocity based; 2T SRS; gNB Config = {3,4,2,1,1;1,4}	15	DDDSU	Average [bit/s/Hz/TRxP]	3.3	2	8.08	9.11	/	4	5.71	6.44	/
			5 th -tile [bit/s/Hz]	0.12		0.18	0.20	/		0.14	0.16	/
16x2 MU-MIMO, Reciprocity based; 2T SRS; gNB Config = {3,4,2,1,1;2,4}	30	DDDSU	Average [bit/s/Hz/TRxP]	3.3	1	9.21	10.64	11.61	1	9.22	10.65	11.62
			5 th -tile [bit/s/Hz]	0.12		0.21	0.25	0.27		0.22	0.25	0.28
16x2 MU-MIMO, Reciprocity based; 2T SRS; gNB Config = {3,4,2,1,1;2,4}	15	DDDSU	Average [bit/s/Hz/TRxP]	3.3	1	8.9	10.08	/	/	8.95	10.14	/
			5 th -tile [bit/s/Hz]	0.12		0.18	0.2	/		0.18	0.21	/
16x4 MU-MIMO, Type II codebook based; gNB Config = {1,8,2,1,1;1,8}	15	DSUUD	Average [bit/s/Hz/TRxP]	3.3	1	12.61	14.99	/	/	/	/	/
			5 th -tile [bit/s/Hz]	0.12		0.39	0.46	/		/	/	/
8x2 MU-MIMO, Reciprocity based; 2T SRS; gNB Config = {3,4,2,1,1;1,4}	15	DSUUD	Average [bit/s/Hz/TRxP]	3.3	3	8.13	9.34	/	3	8.08	9.25	/
			5 th -tile [bit/s/Hz]	0.12		0.24	0.28	/		0.23	0.26	/
8x2 MU-MIMO, Reciprocity based; 2T SRS; gNB Config = {3,4,2,1,1;1,4}	30	DSUUD	Average [bit/s/Hz/TRxP]	3.3	2	6.71	7.84	8.60	2	6.91	8.07	8.86
			5 th -tile [bit/s/Hz]	0.12		0.19	0.22	0.24		0.19	0.22	0.25
16x4 MU-MIMO, Reciprocity based; 4T SRS; gNB Config = {1,8,2,1,1;1,8}	30	DDDSU	Average [bit/s/Hz/TRxP]	3.3	/	/	/	/	1	6.61	7.7	8.45
			5 th -tile [bit/s/Hz]	0.12		/	/	/		0.13	0.15	0.17
8x2 MU-MIMO, Reciprocity based; 2T SRS; gNB Config = {3,4,2,1,1;1,4}	30	DDDD DDSUU	Average [bit/s/Hz/TRxP]	3.3	1	5.07	5.99	6.60	1	5.12	6.04	6.67
			5 th -tile [bit/s/Hz]	0.12		0.14	0.16	0.18		0.15	0.17	0.19
8x2 MU-MIMO, Reciprocity based; 2T SRS; gNB Config = {3,4,2,1,1;1,4}	30	DDDSU DDSUU	Average [bit/s/Hz/TRxP]	3.3	1	5.04	5.98	6.62	1	5.04	5.98	6.62
			5 th -tile [bit/s/Hz]	0.12		0.14	0.16	0.18		0.14	0.16	0.18

The evaluation results of UL spectral efficiency for NR FDD and NR TDD for evaluation configuration A are provided in Table 5.4.1.3.1-2.

It is observed that both NR FDD and TDD fulfill the UL spectral efficiency requirement for these configurations in evaluation configuration A.

**Table 5.4.1.3.1-2 UL spectral efficiency for NR in Rural – eMBB
(Evaluation configuration A, CF=700 MHz)**

(a) NR FDD

Scheme and antenna configuration	Sub-carrier spacing (kHz)	ITU Requirement		Channel model A		Channel model B	
				Number of samples	BW=10MHz	Number of samples	BW=10MHz
1x8 SU-MIMO, OFDMA; gNB Config = (8,4,2,1,1;1,4)	15	Average [bit/s/Hz/TRxP]	1.6	4	4.35	3	4.04
		5 th -tile [bit/s/Hz]	0.045		0.14		0.14
4x16 MU-MIMO, OFDMA; gNB Config = (4,8,2,1,1;1,8)	15	Average [bit/s/Hz/TRxP]	1.6	1	12.69	/	/
		5 th -tile [bit/s/Hz]	0.045		0.62		/
2x8 SU-MIMO, OFDMA; gNB Config = (8,4,2,1,1;1,4)	15	Average [bit/s/Hz/TRxP]	1.6	3	7.22	5	5.66
		5 th -tile [bit/s/Hz]	0.045		0.17		0.19
		5 th -tile [bit/s/Hz]	0.045		/		0.20

(b) NR TDD

Scheme and antenna configuration	Sub-carrier spacing (kHz)	Frame structure	ITU Requirement		Channel model A		Channel model B	
					Number of samples	BW=20MHz	Number of samples	BW=20MHz
2x8 SU-MIMO, Codebook based, OFDMA; gNB Config = (8,4,2,1,1;1,4)	30	DDDSU	Average [bit/s/Hz/TRxP]	1.6	2	3.75	2	4.82
			5 th -tile [bit/s/Hz]	0.045		0.14		0.10
2x8 SU-MIMO, Codebook based, OFDMA; gNB Config = (8,4,2,1,1;1,4)	15	DDDSU	Average [bit/s/Hz/TRxP]	1.6	2	6.50	2	4.85
			5 th -tile [bit/s/Hz]	0.045		0.09		0.09
4x16 MU-MIMO, Codebook based, OFDMA; gNB Config = (4,8,2,1,1;1,8)	15	DSUUD	Average [bit/s/Hz/TRxP]	1.6	1	11.75	/	/
			5 th -tile [bit/s/Hz]	0.045		0.58		/
2x8 SU-MIMO, Codebook based, OFDMA; gNB Config = (8,4,2,1,1;1,4)	15	DSUUD	Average [bit/s/Hz/TRxP]	1.6	1	4.44	1	4.45
			5 th -tile [bit/s/Hz]	0.045		0.18		0.16
2x8 SU-MIMO, Non-codebook based, OFDMA; gNB Config = (8,4,2,1,1;1,4)	30	DSUUD	Average [bit/s/Hz/TRxP]	1.6	2	5.08	1	4.22
			5 th -tile [bit/s/Hz]	0.045		0.16		0.17
2x8 SU-MIMO, Codebook based, OFDMA; gNB Config = (8,4,2,1,1;1,4)	15	DSUUD	Average [bit/s/Hz/TRxP]	1.6	1	4.71	1	4.74
			5 th -tile [bit/s/Hz]	0.045		0.20		0.16
2x8 SU-MIMO, Codebook based, OFDMA; gNB Config = (8,4,2,1,1;1,4)	30	DSUUD	Average [bit/s/Hz/TRxP]	1.6	1	4.51	1	4.56
			5 th -tile [bit/s/Hz]	0.045		0.18		0.15
2x16 MU-MIMO, Codebook based, OFDMA; gNB Config = (4,8,2,1,1;1,8)	30	DDDSU	Average [bit/s/Hz/TRxP]	1.6	/	/	1	4.19
			5 th -tile [bit/s/Hz]	0.045		/		0.22
2x8 SU-MIMO, Codebook based, OFDMA; gNB Config = (8,4,2,1,1;1,4)	30	DDDSU DDSUU	Average [bit/s/Hz/TRxP]	1.6	1	5.34	1	5.38
			5 th -tile [bit/s/Hz]	0.045		0.11		0.13
2x8 SU-MIMO, Codebook based, OFDMA; gNB Config = (8,4,2,1,1;1,4)	30	DDDDD DDSUU	Average [bit/s/Hz/TRxP]	1.6	1	4.78	1	4.81
			5 th -tile [bit/s/Hz]	0.045		0.13		0.12
2x8 SU-MIMO, Non-codebook based, OFDMA; gNB Config = (8,4,2,1,1;1,4)	15	DSUUD	Average [bit/s/Hz/TRxP]	1.6	/	/	1	5.33
			5 th -tile [bit/s/Hz]	0.045		/		0.14
2x8 SU-MIMO, Non-codebook based, OFDMA; gNB Config = (8,4,2,1,1;1,4)	15	DSUUD	Average [bit/s/Hz/TRxP]	1.6	/	/	1	4.53
			5 th -tile [bit/s/Hz]	0.045		/		0.13

5.4.1.3.2 Evaluation configuration B (CF = 4 GHz)

The evaluation results of DL spectral efficiency for NR FDD and NR TDD for evaluation configuration B are provided in Table 5.4.1.3.2-1.

Similar to Indoor Hotspot – eMBB test environment, the capability of NR in larger bandwidth are evaluated for DL spectral efficiency. The values of the assumed bandwidths are shown together with the evaluation results.

It is observed that both NR FDD and TDD fulfill the DL spectral efficiency requirement for these configurations in evaluation configuration B.

**Table 5.4.1.3.2-1 DL spectral efficiency for NR in Rural – eMBB
(Evaluation configuration B, CF=4 GHz)**

(a) NR FDD

Scheme and antenna configuration	Sub-carrier spacing (kHz)	ITU Requirement		Channel model A			Channel model B				
				Number of samples	BW= 10MHz	BW= 20MHz	BW= 40MHz	Number of samples	BW= 10MHz	BW= 20MHz	BW= 40MHz
32x4 MU-MIMO Type II Codebook; gNB Config = (8,8,2,1,1;2,8)	15	Average [bit/s/Hz/TRxP]	3.3	7	12.50	14.13	15.10	8	13.01	14.70	15.68
		5 th -tile [bit/s/Hz]	0.12		0.44	0.49	0.53		0.41	0.46	0.49
32x4 MU-MIMO Type II Codebook; gNB Config = (8,16,2,1,1;1,16)	15	Average [bit/s/Hz/TRxP]	3.3	2	17.32	19.64	21.01	1	16.63	18.79	20.09
		5 th -tile [bit/s/Hz]	0.12		0.49	0.56	0.59		0.52	0.58	0.62
16x4 MU-MIMO Type II Codebook; gNB Config = (8,8,2,1,1;1,8)	15	Average [bit/s/Hz/TRxP]	3.3	1	12.58	14.23	15.22	1	11.96	13.53	14.47
		5 th -tile [bit/s/Hz]	0.12		0.12	0.14	0.15		0.13	0.14	0.15
32x4 MU-MIMO Type I codebook; gNB Config = (8,8,2,1,1;1,8)	15	Average [bit/s/Hz/TRxP]	3.3	1	10.76	12.07	12.86	1	5.30	5.96	6.35
		5 th -tile [bit/s/Hz]	0.12		0.22	0.25	0.26		1.76	1.98	2.11
16x4 MU-MIMO Type I codebook; gNB Config = (8,8,2,1,1;1,8)	15	Average [bit/s/Hz/TRxP]	3.3	1	10.21	11.43	12.16	/	/	/	/
		5 th -tile [bit/s/Hz]	0.12		0.16	0.18	0.19		/	/	/
32x8 MU-MIMO Type II Codebook; gNB Config = (8,16,2,1,1;1,16)	15	Average [bit/s/Hz/TRxP]	3.3	1	15.32	17.18	18.3	/	/	/	/
		5 th -tile [bit/s/Hz]	0.12		0.27	0.30	0.32		/	/	/

(b) NR TDD

Scheme and antenna configuration	Sub-carrier spacing (kHz)	Frame structure	ITU Requirement		Channel model A			Channel model B				
					Number of samples	BW= 20MHz	BW= 40MHz	BW= 100MHz	Number of samples	BW= 20MHz	BW= 40MHz	BW= 100MHz
32x4 MU-MIMO, Reciprocity based; 4T SRS; gNB Config = (8,8,2,1,1;2,8)	30	DDDSU	Average [bit/s/Hz/TRxP]	3.3	4	14.36	16.75	18.37	4	14.30	16.58	18.08
			5 th -tile [bit/s/Hz]	0.12		0.45	0.52	0.58		0.44	0.51	0.56
32x4 MU-MIMO, Reciprocity based; 4T SRS; gNB Config = (8,8,2,1,1;2,8)	15	DDDSU	Average [bit/s/Hz/TRxP]	3.3	2	15.63	17.79	/	3	12.84	14.60	/
			5 th -tile [bit/s/Hz]	0.12		0.30	0.35	/		0.37	0.43	/
32x4 MU-MIMO, Type II Codebook based; gNB Config = (8,16,2,1,1;1,16)	15	DSUUD	Average [bit/s/Hz/TRxP]	3.3	1	14.86	17.67	/	/	/	/	/
			5 th -tile [bit/s/Hz]	0.12		0.39	0.46	/		/	/	/
32x4 MU-MIMO, Reciprocity based; 4T SRS; gNB Config = (8,8,2,1,1;2,8)	15	DSUUD	Average [bit/s/Hz/TRxP]	3.3	2	15.04	17.46	/	1	15.17	17.84	/
			5 th -tile [bit/s/Hz]	0.12		0.58	0.68	/		0.49	0.58	/
32x4 MU-MIMO, Reciprocity based; 4T SRS; gNB Config = (8,8,2,1,1;2,8)	30	DSUUD	Average [bit/s/Hz/TRxP]	3.3	1	14.29	16.68	18.31	/	/	/	/
			5 th -tile [bit/s/Hz]	0.12		0.47	0.55	0.60		/	/	/
64x4 MU-MIMO, Reciprocity based; 4T SRS; gNB Config = (12,8,2,1,1;4,8)	30	DDDD DDSUU	Average [bit/s/Hz/TRxP]	3.3	1	16.89	19.59	21.44	/	/	/	/
			5 th -tile [bit/s/Hz]	0.12		0.43	0.50	0.55		/	/	/
64x4 MU-MIMO, Reciprocity based; 4T SRS; gNB Config = (12,8,2,1,1;4,8)	30	DSUUD	Average [bit/s/Hz/TRxP]	3.3	2	15.40	18.14	20.00	2	15.23	17.94	19.78
			5 th -tile [bit/s/Hz]	0.12		0.58	0.69	0.76		0.54	0.64	0.71
64x4 MU-MIMO, Reciprocity based; 4T SRS; gNB Config = (12,8,2,1,1;4,8)	30	DDDSU	Average [bit/s/Hz/TRxP]	3.3	/	/	/	/	1	14.52	16.90	18.53
			5 th -tile [bit/s/Hz]	0.12		/	/	/		0.49	0.57	0.63
128x4 MU-MIMO, Reciprocity based; 4T SRS; gNB Config = (4,32,2,1,1;2,32)	30	DDSU	Average [bit/s/Hz/TRxP]	3.3	/	/	/	/	1	10.36	12.08	13.25
			5 th -tile [bit/s/Hz]	0.12		/	/	/		0.13	0.15	0.16
64x8 MU-MIMO, Reciprocity based; 4T SRS; gNB Config = (4,32,2,1,1;1,32)	15	DSUUD	Average [bit/s/Hz/TRxP]	3.3	1	17.38	21.11	/	/	/	/	/
			5 th -tile [bit/s/Hz]	0.12		0.43	0.52	/		/	/	/
32x8 MU-MIMO, Reciprocity	15	DSUUD	Average [bit/s/Hz/TRxP]	3.3	1	12.46	14.35	/	/	/	/	/

Reciprocity based; 2T SRS gNB Config = (8,16,2,1,1,1;1,16)			5 th -tile [bit/s/Hz]	0.12		0.18	0.20	/		/	/	/
32x4 MU-MIMO, Reciprocity based; 4T SRS gNB Config = (8,8,2,1,1;2,8)	30	DDDDD DDSUU	Average [bit/s/Hz/TRxP]	3.3	1	13.21	15.74	17.44	1	13.19	15.71	17.41
			5 th -tile [bit/s/Hz]	0.12		0.43	0.51	0.57		0.48	0.57	0.63
64x4 MU-MIMO, Reciprocity based; 4T SRS gNB Config = (12,8,2,1,1;4,8)	30	DDDSU DDSUU	Average [bit/s/Hz/TRxP]	3.3	1	14.54	17.45	19.40	1	14.76	17.72	19.70
			5 th -tile [bit/s/Hz]	0.12		0.46	0.55	0.61		0.48	0.58	0.64
16x4 MU-MIMO, Reciprocity based; 4T SRS gNB Config = (8,8,2,1,1;1,8)	15	DSUUD	Average [bit/s/Hz/TRxP]	3.3	/	/	/	/	1	11.24	12.63	/
			5 th -tile [bit/s/Hz]	0.12		/	/	/		0.24	0.27	/
16x4 MU-MIMO, Reciprocity based; 4T SRS gNB Config = (8,8,2,1,1;1,8)	15	DDDSU	Average [bit/s/Hz/TRxP]	3.3	/	/	/	/	1	11.08	12.43	/
			5 th -tile [bit/s/Hz]	0.12		/	/	/		0.26	0.29	/

The evaluation results of UL spectral efficiency for NR FDD and NR TDD for evaluation configuration B are provided in Table 5.4.1.3.2-2.

It is observed that both NR FDD and TDD fulfill the UL spectral efficiency requirement for these configurations in evaluation configuration B.

Table 5.4.1.3.2-2 UL spectral efficiency for NR in Rural – eMBB (Evaluation configuration B, CF=4 GHz)

(a) NR FDD

Scheme and antenna configuration	Sub-carrier spacing (kHz)	ITU Requirement		Channel model A		Channel model B	
				Number of samples	BW=10MHz	Number of samples	BW=10MHz
1x32 SU-MIMO, OFDMA; gNB Config = (8,8,2,1,1;2,8)	15	Average [bit/s/Hz/TRxP]	1.6	4	4.28	2	4.52
		5 th -tile [bit/s/Hz]	0.045		0.14		0.16
4x32 SU-MIMO, OFDMA; gNB Config = (8,8,2,1,1;2,8)	15	Average [bit/s/Hz/TRxP]	1.6	2	7.38	3	7.70
		5 th -tile [bit/s/Hz]	0.045		0.29		0.22
4x32 MU-MIMO, OFDMA; gNB Config = (8,16,2,1,1;1,16)	15	Average [bit/s/Hz/TRxP]	1.6	2	12.46	/	/
		5 th -tile [bit/s/Hz]	0.045		0.23		/
2x32 SU-MIMO, OFDMA; gNB Config = (8,8,2,1,1;2,8)	15	Average [bit/s/Hz/TRxP]	1.6	1	6.27	1	6.16
		5 th -tile [bit/s/Hz]	0.045		0.23		0.19
4x16 SU-MIMO, OFDMA; gNB Config = (8,8,2,1,1;1,8)	15	Average [bit/s/Hz/TRxP]	1.6	1	9.90	/	/
		5 th -tile [bit/s/Hz]	0.045		0.02		/

(b) NR TDD

Scheme and antenna configuration	Sub-carrier spacing (kHz)	Frame structure	ITU Requirement		Channel model A		Channel model B	
					Number of samples	BW=20MHz	Number of samples	BW=20MHz
1x32 SU-MIMO, Codebook based, OFDMA; gNB Config (8,8,2,1,1;2,8)	30	DDDSU	Average [bit/s/Hz/TRxP]	1.6	1	3.18	1	3.12
			5 th -tile [bit/s/Hz]	0.045		0.11		0.09
1x32 SU-MIMO, Codebook based, OFDMA; gNB Config (8,8,2,1,1;2,8)	15	DDDSU	Average [bit/s/Hz/TRxP]	1.6	1	3.54	1	3.46
			5 th -tile [bit/s/Hz]	0.045		0.12		0.10
4x32 SU-MIMO, Codebook based, OFDMA; gNB Config (8,8,2,1,1;2,8)	30	DDDSU	Average [bit/s/Hz/TRxP]	1.6	1	5.73	2	5.86
			5 th -tile [bit/s/Hz]	0.045		0.18		0.13
4x32 SU-MIMO, Codebook based, OFDMA; gNB Config (8,8,2,1,1;2,8)	15	DDDSU	Average [bit/s/Hz/TRxP]	1.6	1	6.30	2	5.85
			5 th -tile [bit/s/Hz]	0.045		0.19		0.14
4x32 MU-MIMO, Codebook based, OFDMA; gNB Config (8,16,2,1,1;1,16)	15	DSUUD	Average [bit/s/Hz/TRxP]	1.6	1	13.96	/	/
			5 th -tile [bit/s/Hz]	0.045		0.35		/
8x64 SU-MIMO, Codebook based, OFDMA; gNB Config (4,32,2,1,1;1,32)	15	DDDSU	Average [bit/s/Hz/TRxP]	1.6	1	10.73	/	/
			5 th -tile [bit/s/Hz]	0.045		0.07		/
2x64 SU-MIMO, Codebook based, OFDMA; gNB Config (12,8,2,1,1;4,8)	30	DSUUD	Average [bit/s/Hz/TRxP]	1.6	1	7.83	1	7.66
			5 th -tile [bit/s/Hz]	0.045		0.31		0.32
2x64 SU-MIMO, Codebook based, OFDMA; gNB Config (12,8,2,1,1;4,8)	30	DDDSU	Average [bit/s/Hz/TRxP]	1.6	/	/	1	6.82
			5 th -tile [bit/s/Hz]	0.045		/		0.29
2x128, MU-MIMO, Codebook-based, OFDMA; gNB Config (8,16,2,1,1;4,16)	30	DDSU	Average [bit/s/Hz/TRxP]	1.6	/	/	1	9.2
			5 th -tile [bit/s/Hz]	0.045		/		0.11
2x64 SU-MIMO, Codebook based, OFDMA; gNB Config (12,8,2,1,1;4,8)	30	DDDSU DDSUU	Average [bit/s/Hz/TRxP]	1.6	1	7.44	1	7.33
			5 th -tile [bit/s/Hz]	0.045		0.34		0.29
2x64 SU-MIMO, Codebook based, OFDMA; gNB Config (12,8,2,1,1;4,8)	30	DDDDD DDSUU	Average [bit/s/Hz/TRxP]	1.6	1	6.66	1	6.56
			5 th -tile [bit/s/Hz]	0.045		0.30		0.26
4x16 SU-MIMO, Codebook based, OFDMA; gNB Config (8,8,2,1,1;1,8)	30	DDDSU	Average [bit/s/Hz/TRxP]	1.6	1	2.7	/	/
			5 th -tile [bit/s/Hz]	0.045		0.17		/
4x16 SU-MIMO, Codebook based, OFDMA; gNB Config (8,8,2,1,1;1,8)	15	DSUUD	Average [bit/s/Hz/TRxP]	1.6	/	/	1	6.27
			5 th -tile [bit/s/Hz]	0.045		/		0.08
4x16 SU-MIMO, Codebook based, OFDMA; gNB Config (8,8,2,1,1;1,8)	15	DDDSU	Average [bit/s/Hz/TRxP]	1.6	/	/	1	5.25
			5 th -tile [bit/s/Hz]	0.045		/		0.08

5.4.1.3.3 Evaluation configuration C (LMLC)

LMLC (Low mobility large cell) is characterized by the large inter-site distance (ISD=6000m) and the low mobility users in Rural – eMBB test environment.

The evaluation results of DL spectral efficiency for NR FDD and NR TDD for evaluation configuration C are provided in Table 5.4.1.3.3-1.

Similar to Indoor Hotspot – eMBB test environment, the capability of NR in larger bandwidth are evaluated for DL spectral efficiency. The values of the assumed bandwidths are shown together with the evaluation results.

It is observed that both NR FDD and TDD fulfill the DL spectral efficiency requirement for these configurations in evaluation configuration C.

**Table 5.4.1.3.3-1 DL spectral efficiency for NR in Rural – eMBB
(Evaluation configuration C, LMLC)**

(a) NR FDD

Scheme and antenna configuration	Sub-carrier spacing (kHz)	ITU Requirement ¹		Channel model A			Channel model B				
				Number of samples	BW= 10MHz	BW= 20MHz	BW= 40MHz	Number of samples	BW= 10MHz	BW= 20MHz	BW= 40MHz
8x4 MU-MIMO Type II Codebook; gNB Config = (8,4,2,1,1;1,4)	15	Average [bit/s/Hz/TRxP]	3.3	8	7.81	8.79	9.39	8	7.31	8.22	8.76
		5 th -tile [bit/s/Hz]			0.21	0.23	0.25		0.22	0.25	0.26
16x4 MU-MIMO Type II Codebook; gNB Config = (8,4,2,1,1;2,4)	15	Average [bit/s/Hz/TRxP]	3.3	1	8.13	9.13	9.73	1	8.14	9.13	9.73
		5 th -tile [bit/s/Hz]			0.20	0.23	0.24		0.20	0.23	0.24
16x4 MU-MIMO Type II Codebook; gNB Config = (4,8,2,1,1;1,8)	15	Average [bit/s/Hz/TRxP]	3.3	2	10.40	11.76	12.57	/	/	/	/
		5 th -tile [bit/s/Hz]			0.34	0.39	0.41		/	/	/
8x4 MU-MIMO Type I codebook; gNB Config = (8,4,2,1,1;1,4)	15	Average [bit/s/Hz/TRxP]	3.3	2	8.36	9.38	10.00	/	/	/	/
		5 th -tile [bit/s/Hz]			0.20	0.22	0.24		/	/	/
8x4 MU-MIMO Type I codebook; gNB Config = (8,4,2,1,1;1,4) (Optimized for cell edge)	15	Average [bit/s/Hz/TRxP]	3.3	/	/	/	/	1	3.90	4.37	4.65
		5 th -tile [bit/s/Hz]			/	/	/		0.84	0.94	1.00

Note 1: According to Report ITU-R M.2410 [4], the 5th percentile user spectral efficiency requirement is not applicable to LMLC. The value shown here is for information only.

(b) NR TDD

Scheme and antenna configuration	Sub-carrier spacing (kHz)	Frame structure	ITU Requirement ¹		Channel model A			Channel model B				
					Number of samples	BW= 20MHz	BW= 40MHz	BW= 100MHz	Number of samples	BW= 20MHz	BW= 40MHz	BW= 100MHz
8x4 MU-MIMO, Reciprocity based; 4T SRS; gNB Config = (8,4,2,1,1;1,4);	30	DDDSU	Average [bit/s/Hz/TRxP]	3.3	4	7.35	8.50	9.28	4	7.66	8.83	9.74
			5 th -tile [bit/s/Hz]			0.22	0.26	0.28		0.26	0.30	0.33
8x4 MU-MIMO, Reciprocity based; 4T SRS; gNB Config = (8,4,2,1,1;1,4);	15	DDDSU	Average [bit/s/Hz/TRxP]	3.3	2	9.34	10.56	/	3	7.83	8.79	/
			5 th -tile [bit/s/Hz]			0.22	0.25	/		0.21	0.24	/
16x4 MU-MIMO, Reciprocity based; 4T SRS; gNB Config = (8,4,2,1,1;2,4);	30	DDDSU	Average [bit/s/Hz/TRxP]	3.3	1	8.61	9.98	10.91	1	8.59	9.95	10.89
			5 th -tile [bit/s/Hz]			0.2	0.23	0.25		0.19	0.22	0.25
16x4 MU-MIMO, Reciprocity based; 4T SRS; gNB Config = (8,4,2,1,1;2,4);	15	DDDSU	Average [bit/s/Hz/TRxP]	3.3	1	8.83	9.98	/	1	8.82	9.96	/
			5 th -tile [bit/s/Hz]			0.22	0.25	/		0.21	0.24	/
16x4 MU-MIMO, Type II Codebook; gNB Config = (4,8,2,1,1;1,8);	15	DSUUD	Average [bit/s/Hz/TRxP]	3.3	1	10.44	12.41	/	/	/	/	/
			5 th -tile [bit/s/Hz]			0.35	0.41	/		/	/	/
64x8 MU-MIMO, Reciprocity based; 4T SRS; gNB Config = (4,32,2,1,1;1,32)	15	DDDSU	Average [bit/s/Hz/TRxP]	3.3	1	6.01	7.3	/	/	/	/	/
			5 th -tile [bit/s/Hz]			/	/	/		/	/	/
8x4 MU-MIMO, Reciprocity based; 4T SRS; gNB Config = (8,4,2,1,1;1,4);	15	DSUUD	Average [bit/s/Hz/TRxP]	3.3	2	7.98	9.33	/	2	8.97	19.29	/
			5 th -tile [bit/s/Hz]			0.25	0.29	/		0.23	0.27	/
8x4 MU-MIMO, Reciprocity based; 4T SRS; gNB Config = (8,4,2,1,1;1,4)	30	DSUUD	Average [bit/s/Hz/TRxP]	3.3	1	8.34	9.91	10.97	1	8.38	9.96	11.02
			5 th -tile [bit/s/Hz]			0.28	0.33	0.37		0.31	0.37	0.41
16x4 MU-MIMO, Reciprocity based; 2T SRS; gNB Config = (4,8,2,1,1;1,8)	15	DSUUD	Average [bit/s/Hz/TRxP]	3.3	1	7.59	8.74	/	/	/	/	/
			5 th -tile [bit/s/Hz]			0.23	0.26	/		/	/	/
8x2 MU-MIMO, Reciprocity based; 2T SRS; gNB Config = (8,4,2,1,1;1,4)	15	DDDSU	Average [bit/s/Hz/TRxP]	3.3	/	/	/	/	1	5.70	6.50	/
			5 th -tile [bit/s/Hz]			/	/	/		0.16	0.18	/

Note 1: According to Report ITU-R M.2410 [4], the 5th percentile user spectral efficiency requirement is not applicable to LMLC. The value shown here is for information only.

The evaluation results of UL spectral efficiency for NR FDD and NR TDD for evaluation configuration C are provided in Table 5.4.1.3.3-2.

It is observed that both NR FDD and TDD fulfill the UL spectral efficiency requirement for these configurations in evaluation configuration C.

**Table 5.4.1.3.3-2 UL spectral efficiency for NR in Rural – eMBB
(Evaluation configuration C, LMLC)**

(a) NR FDD

Scheme and antenna configuration	Sub-carrier spacing (kHz)	ITU Requirement ¹		Channel model A		Channel model B	
				Number of samples	BW=10MHz	Number of samples	BW=10MHz
2x8 SU-MIMO, OFDMA; gNB Config = (8,4,2,1,1;1,4);	15	Average [bit/s/Hz/TRxP]	1.6	2	4.22	2	4.16
		5 th -tile [bit/s/Hz]			0.14		0.13
1x8 SU-MIMO, OFDMA; gNB Config = (8,4,2,1,1;1,4);	15	Average [bit/s/Hz/TRxP]	1.6	2	4.54	/	/
		5 th -tile [bit/s/Hz]			0.09		/
4x8 SU-MIMO, OFDMA; gNB Config = (8,4,2,1,1;1,4);	15	Average [bit/s/Hz/TRxP]	1.6	2	5.38	2	4.78
		5 th -tile [bit/s/Hz]			0.13		0.09
4x16 MU-MIMO, OFDMA; gNB Config = (4,8,2,1,1;1,8);	15	Average [bit/s/Hz/TRxP]	1.6	2	8.33	/	/
		5 th -tile [bit/s/Hz]			0.11		/

Note 1: According to Report ITU-R M.2410 [4], the 5th percentile user spectral efficiency requirement is not applicable to LMLC. The value shown here is for information only.

(b) NR TDD

Scheme and antenna configuration	Sub-carrier spacing (kHz)	Frame structure	ITU Requirement ¹		Channel model A		Channel model B	
					Number of samples	BW=20MHz	Number of samples	BW=20MHz
2x8 SU-MIMO, Codebook based, OFDMA; gNB Config = (8,4,2,1,1;1,4);	30	DDDSU	Average [bit/s/Hz/TRxP]	1.6	1	3.33	1	3.31
			5 th -tile [bit/s/Hz]			0.06		0.05
2x8 SU-MIMO, Codebook based, OFDMA; gNB Config = (8,4,2,1,1;1,4);	15	DDDSU	Average [bit/s/Hz/TRxP]	1.6	1	3.56	1	3.57
			5 th -tile [bit/s/Hz]			0.05		/
4x8 SU-MIMO, Codebook based, OFDMA; gNB Config = (8,4,2,1,1;1,4);	30	DDDSU	Average [bit/s/Hz/TRxP]	1.6	1	3.84	3	3.71
			5 th -tile [bit/s/Hz]			0.07		0.06
4x8 SU-MIMO, Codebook based, OFDMA; gNB Config = (8,4,2,1,1;1,4);	15	DDDSU	Average [bit/s/Hz/TRxP]	1.6	2	4.21	2	3.99
			5 th -tile [bit/s/Hz]			0.06		0.06
4x16 SU-MIMO, Codebook based, OFDMA; gNB Config = (4,8,2,1,1;1,8);	15	DSUUD	Average [bit/s/Hz/TRxP]	1.6	1	10.59	/	/
			5 th -tile [bit/s/Hz]			0.08		/
8x64 MU-MIMO, Codebook based, OFDMA; gNB Config = (4,32,2,1,1;1,32)	15	DDDSU	Average [bit/s/Hz/TRxP]	1.6	1	4.82	/	/
			5 th -tile [bit/s/Hz]			/		/
4x8 SU-MIMO, Codebook based, OFDMA; gNB Config = (8,4,2,1,1;1,4);	30	DSUUD	Average [bit/s/Hz/TRxP]	1.6	1	4.41	1	3.56
			5 th -tile [bit/s/Hz]			/		/
4x8 SU-MIMO, Non-codebook based, OFDMA; gNB Config = (8,4,2,1,1;1,4);	15	DSUUD	Average [bit/s/Hz/TRxP]	1.6	/	/	1	4.56
			5 th -tile [bit/s/Hz]			/		0.09
4x8 SU-MIMO, Non-codebook based, OFDMA; gNB Config = (8,4,2,1,1;1,4);	15	DDDSU	Average [bit/s/Hz/TRxP]	1.6	/	/	1	3.79
			5 th -tile [bit/s/Hz]			/		0.08

Note 1: According to Report ITU-R M.2410 [4], the 5th percentile user spectral efficiency requirement is not applicable to LMLC. The value shown here is for information only.

5.4.2 LTE

Average spectral efficiency and 5th percentile user spectral efficiency are evaluated for LTE. Both LTE FDD and TDD are evaluated. Detailed evaluation assumptions and results can be found in Annex B.4.1.

5.4.2.1 Indoor Hotspot – eMBB

Evaluation configuration A (carrier frequency = 4 GHz) is applied for the evaluations of Indoor Hotspot – eMBB test environment for LTE.

5.4.2.1.1 Evaluation configuration A (CF = 4 GHz)

The evaluation results of DL spectral efficiency for LTE FDD and LTE TDD for evaluation configuration A with 12TRxP are provided in Table 5.4.2.1.1-1.

It is observed that both LTE FDD and TDD fulfill the DL spectral efficiency requirement for these configurations in evaluation configuration A.

**Table 5.4.2.1.1-1 DL spectral efficiency for LTE in Indoor Hotspot – eMBB
(Evaluation configuration A, CF=4 GHz)**

(a) LTE FDD

Scheme and antenna configuration	Sub-carrier spacing (kHz)	ITU Requirement		Channel model A		Channel model B	
				Number of samples	BW=10MHz	Number of samples	BW=10MHz
32x4 MU-MIMO Advanced CSI Codebook; gNB Config = (4,4,2,1,1;4,4)	15	Average [bit/s/Hz/TRxP]	9	1	9.81	1	9.86
		5 th -tile [bit/s/Hz]	0.3		0.35		0.40

(b) LTE TDD

Scheme and antenna configuration	Sub-carrier spacing (kHz)	Frame structure	ITU Requirement		Channel model A		Channel model B	
					Number of samples	BW=20MHz	Number of samples	BW=20MHz
64x2 MU-MIMO, Reciprocity based; 2T SRS; gNB Config = (8,16,2,1,1;4,8)	15	DSUDD	Average [bit/s/Hz/TRxP]	9	1	9.25	1	9.61
			5 th -tile [bit/s/Hz]	0.3		0.33		0.34
32x4 MU-MIMO, Advanced CSI Codebook; gNB Config = (4,4,2,1,1;1,4)	15	DSUUD	Average [bit/s/Hz/TRxP]	9	1	11.81	1	11.88
			5 th -tile [bit/s/Hz]	0.3		0.42		0.35
32x4 MU-MIMO, Reciprocity based; 4T SRS; gNB Config = (4,4,2,1,1;4,4)	15	DSUUD	Average [bit/s/Hz/TRxP]	9	1	11.76	1	11.78
			5 th -tile [bit/s/Hz]	0.3		0.40		0.39
32x2 MU-MIMO, Reciprocity based; 2T SRS; gNB Config = (4,4,2,1,1;4,4)	15	DSUUD	Average [bit/s/Hz/TRxP]	9	1	9.37	1	9.46
			5 th -tile [bit/s/Hz]	0.3		0.39		0.38

The evaluation results of UL spectral efficiency for LTE FDD and TDD for evaluation configuration A are provided in Table 5.4.2.1.1-2.

It is observed that both LTE FDD and TDD fulfill the UL spectral efficiency requirement for these configurations in evaluation configuration A.

**Table 5.4.2.1-2 UL spectral efficiency for LTE in Indoor Hotspot – eMBB
(Evaluation configuration A, CF=4 GHz)**

(a) LTE FDD

Scheme and antenna configuration	Sub-carrier spacing (kHz)	ITU Requirement		Channel model A		Channel model B	
				Number of samples	BW=10MHz	Number of samples	BW=10MHz
4x32 SU-MIMO, Codebook based, DFT-S-OFDM; gNB Config = (4,4,2,1,1;4,4)	15	Average [bit/s/Hz/TRxP]	6.75	1	8.47	1	7.96
		5 th -tile [bit/s/Hz]	0.21		0.51		0.49

(b) LTE TDD

Scheme and antenna configuration	Sub-carrier spacing (kHz)	Frame structure	ITU Requirement		Channel model A		Channel model B	
					Number of samples	BW=20MHz	Number of samples	BW=20MHz
2x64 SU-MIMO, Codebook based, DFT-S-OFDM; gNB Config = (8,16,2,1,1;4,8)	15	DSUDD	Average [bit/s/Hz/TRxP]	6.75	1	7.37	1	7.43
			5 th -tile [bit/s/Hz]	0.21		0.38		0.40
4x32 SU-MIMO, Codebook based, DFT-S-OFDM; gNB Config = (4,4,2,1,1;4,4)	15	DSUUD	Average [bit/s/Hz/TRxP]	6.75	1	8.05	1	7.74
			5 th -tile [bit/s/Hz]	0.21		0.54		0.49
2x32 SU-MIMO, Codebook based, DFT-S-OFDM; gNB Config = (16,8,2,1,1;4,4)	15	DSUUD	Average [bit/s/Hz/TRxP]	6.75	1	8.84	1	8.81
			5 th -tile [bit/s/Hz]	0.21		0.34		0.32

5.4.2.2 Dense Urban – eMBB

Evaluation configuration A (carrier frequency = 4 GHz) is applied for the evaluations of Dense Urban – eMBB test environment for LTE.

5.4.2.2.1 Evaluation configuration A (CF = 4 GHz)

The evaluation results of DL spectral efficiency for LTE FDD and LTE TDD for evaluation configuration A are provided in Table 5.4.2.2.1-1.

It is observed that both LTE FDD and TDD fulfill the DL spectral efficiency requirement for these configurations in evaluation configuration A.

**Table 5.4.2.2.1-1 DL spectral efficiency for LTE in Dense Urban – eMBB
(Evaluation configuration A, CF=4 GHz)**

(a) LTE FDD

Scheme and antenna configuration	Sub-carrier spacing (kHz)	ITU Requirement		Channel model A		Channel model B	
				Number of samples	BW=10MHz	Number of samples	BW=10MHz
32x4 MU-MIMO Advanced CSI Codebook; gNB Config = (8,8,2,1,1;2,8)	15	Average [bit/s/Hz/TRxP]	7.8	1	8.96	1	9.03
		5 th -tile [bit/s/Hz]	0.225		0.28		0.28
32x4 MU-MIMO Advanced CSI Codebook; gNB Config = (16,8,2,1,1;2,8)	15	Average [bit/s/Hz/TRxP]	7.8	1	9.31	1	9.18
		5 th -tile [bit/s/Hz]	0.225		0.29		0.29

(b) LTE TDD

Scheme and antenna configuration	Sub-carrier spacing (kHz)	Frame structure	ITU Requirement		Channel model A		Channel model B	
					Number of samples	BW=20MHz	Number of samples	BW=20MHz
64x2 MU-MIMO, Reciprocity based; 2T SRS; gNB Config = (12,8,2,1,1;4,8)	15	DSUDD	Average [bit/s/Hz/TRxP]	7.8	1	8.78	1	9.05
			5 th -tile [bit/s/Hz]	0.225		0.25		0.26
32x4 MU-MIMO, Reciprocity based; 4T SRS; gNB Config = (16,8,2,1,1;2,8)	15	DSUUD	Average [bit/s/Hz/TRxP]	7.8	1	12.25	1	12.15
			5 th -tile [bit/s/Hz]	0.225		0.39		0.38
64x4 MU-MIMO, Reciprocity based; 4T SRS; gNB Config = (12,8,2,1,1;4,8)	15	DSUUD	Average [bit/s/Hz/TRxP]	7.8	1	14.53	1	14.59
			5 th -tile [bit/s/Hz]	0.225		0.52		0.50
64x4 MU-MIMO, Reciprocity based; 4T SRS; gNB Config = (16,8,2,1,1;4,8)	15	DSUUD	Average [bit/s/Hz/TRxP]	7.8	1	14.91	1	14.89
			5 th -tile [bit/s/Hz]	0.225		0.52		0.52
32x2 MU-MIMO, Reciprocity based; 2T SRS; gNB Config = (12,8,2,1,1;4,4)	15	DSUUD	Average [bit/s/Hz/TRxP]	7.8	1	10.06	1	10.03
			5 th -tile [bit/s/Hz]	0.225		0.33		0.34

The evaluation results of UL spectral efficiency for LTE FDD and TDD for evaluation configuration A are provided in Table 5.4.2.2.1-2.

It is observed that both LTE FDD and TDD fulfill the UL spectral efficiency requirement for these configurations in evaluation configuration A.

**Table 5.4.2.2.1-2 UL spectral efficiency for LTE in Dense Urban – eMBB
(Evaluation configuration A, CF=4 GHz)**

(a) LTE FDD

Scheme and antenna configuration	Sub-carrier spacing (kHz)	ITU Requirement		Channel model A		Channel model B	
				Number of samples	BW=10MHz	Number of samples	BW=10MHz
4x32 SU-MIMO, Codebook based, DFT-S-OFDM; gNB Config = (16,8,2,1,1;2,8)	15	Average [bit/s/Hz/TRxP]	5.4	1	6.95	1	7.21
		5 th -tile [bit/s/Hz]	0.15		0.39		0.41

(b) LTE TDD

Scheme and antenna configuration	Sub-carrier spacing (kHz)	Frame structure	ITU Requirement		Channel model A		Channel model B	
					Number of samples	BW=20MHz	Number of samples	BW=20MHz
2x64 SU-MIMO, Codebook based, DFT-S-OFDM; gNB Config = (12,8,2,1,1;4,8)	15	DSUDD	Average [bit/s/Hz/TRxP]	5.4	1	6.65	1	6.59
			5 th -tile [bit/s/Hz]	0.15		0.33		0.30
4x32 SU-MIMO, Codebook based, DFT-S-OFDM; gNB Config = (16,8,2,1,1;2,8)	15	DSUUD	Average [bit/s/Hz/TRxP]	5.4	1	6.60	1	6.77
			5 th -tile [bit/s/Hz]	0.15		0.30		0.32
2x32 SU-MIMO, Codebook based, DFT-S-OFDM; gNB Config = (16,8,2,1,1;4,4)	15	DSUUD	Average [bit/s/Hz/TRxP]	5.4	1	7.68	1	7.66
			5 th -tile [bit/s/Hz]	0.15		0.38		0.37

5.4.2.3 Rural – eMBB

Evaluation configuration A (carrier frequency = 700 MHz), evaluation configuration B (carrier frequency = 4 GHz), and evaluation configuration C (LMLC) are applied for the evaluations of Rural – eMBB test environment for LTE.

5.4.2.3.1 Evaluation configuration A (CF = 700 MHz)

The evaluation results of DL spectral efficiency for LTE FDD and TDD for evaluation configuration A are provided in Table 5.4.2.3.1-1.

It is observed that both LTE FDD and TDD fulfill the DL spectral efficiency requirement for these configurations in evaluation configuration A.

Table 5.4.2.3.1-1 DL spectral efficiency for LTE in Rural – eMBB (Evaluation configuration A, CF=700 MHz)

(a) LTE FDD

Scheme and antenna configuration	Sub-carrier spacing (kHz)	ITU Requirement		Channel model A		Channel model B	
				Number of samples	BW=10MHz	Number of samples	BW=10MHz
8x2 MU-MIMO Advanced CSI Codebook; gNB Config = (8,4,2,1,1;1,4)	15	Average [bit/s/Hz/TRxP]	3.3	1	4.66	2	4.51
		5 th -tile [bit/s/Hz]	0.12		0.12		0.12
16x2 MU-MIMO Advanced CSI Codebook; gNB Config = (4,8,2,1,1;1,8)	15	Average [bit/s/Hz/TRxP]	3.3	1	6.45	1	6.46
		5 th -tile [bit/s/Hz]	0.12		0.16		0.15

(b) LTE TDD

Scheme and antenna configuration	Sub-carrier spacing (kHz)	Frame structure	ITU Requirement		Channel model A		Channel model B	
					Number of samples	BW=20MHz	Number of samples	BW=20MHz
16x2 MU-MIMO, Reciprocity based; 2T SRS; gNB Config = (4,8,2,1,1;1,8)	15	DSUUD	Average [bit/s/Hz/TRxP]	3.3	1	11.05	1	11.22
			5 th -tile [bit/s/Hz]	0.12		0.29		0.29
8x2 MU-MIMO, Reciprocity based; 2T SRS; gNB Config = (8,4,2,1,1;1,4)	15	DSUDD	Average [bit/s/Hz/TRxP]	3.3	1	5.00	1	5.52
			5 th -tile [bit/s/Hz]	0.12		0.18		0.19

The evaluation results of UL spectral efficiency for LTE FDD and TDD for evaluation configuration A are provided in Table 5.4.2.3.1-2.

It is observed that both LTE FDD and TDD fulfill the UL spectral efficiency requirement for these configurations in evaluation configuration A.

Table 5.4.2.3.1-1 UL spectral efficiency for LTE in Rural – eMBB (Evaluation configuration A, CF=700 MHz)

(a) LTE FDD

Scheme and antenna configuration	Sub-carrier spacing (kHz)	ITU Requirement		Channel model A		Channel model B	
				Number of samples	BW=10MHz	Number of samples	BW=10MHz
1x8 SU-MIMO, Codebook based, DFT-S-OFDM; gNB Config = (8,4,2,1,1;1,4)	15	Average [bit/s/Hz/TRxP]	1.6	1	3.59	1	3.59
		5 th -tile [bit/s/Hz]	0.045		0.10		0.10
2x8 SU-MIMO, Codebook based, DFT-S-OFDM; gNB Config = (8,4,2,1,1;1,4)	15	Average [bit/s/Hz/TRxP]	1.6	1	4.30	2	4.75
		5 th -tile [bit/s/Hz]	0.045		0.22		0.18

(b) LTE TDD

Scheme and antenna configuration	Sub-carrier spacing (kHz)	Frame structure	ITU Requirement		Channel model A		Channel model B	
					Number of samples	BW=20MHz	Number of samples	BW=20MHz
2x8 SU-MIMO, Codebook based, DFT-S-OFDM; gNB Config = (8,4,2,1,1;1,4)	15	DSUUD	Average [bit/s/Hz/TRxP]	1.6	1	3.78	1	3.80
			5 th -tile [bit/s/Hz]	0.045		0.15		0.13

5.4.2.3.2 Evaluation configuration B (CF = 4 GHz)

The evaluation results of DL spectral efficiency for LTE FDD and TDD for evaluation configuration B are provided in Table 5.4.2.3.2-1.

It is observed that both LTE FDD and TDD fulfill the DL spectral efficiency requirement for these configurations in evaluation configuration B.

**Table 5.4.2.3.2-1 DL spectral efficiency for LTE in Rural – eMBB
(Evaluation configuration B, CF=4 GHz)**

(a) LTE FDD

Scheme and antenna configuration	Sub-carrier spacing (kHz)	ITU Requirement		Channel model A		Channel model B	
				Number of samples	BW=10MHz	Number of samples	BW=10MHz
32x4 MU-MIMO Type II Codebook; gNB Config = (8,8,2,1,1;2,8)	15	Average [bit/s/Hz/TRxP]	3.3	1	9.65	1	9.63
		5 th -tile [bit/s/Hz]	0.12		0.28		0.28

(b) LTE TDD

Scheme and antenna configuration	Sub-carrier spacing (kHz)	Frame structure	ITU Requirement		Channel model A		Channel model B	
					Number of samples	BW=20MHz	Number of samples	BW=20MHz
32x4 MU-MIMO, Reciprocity based; 4T SRS; gNB Config = (8,8,2,1,1;2,8)	15	DSUUD	Average [bit/s/Hz/TRxP]	3.3	/	/	1	12.25
			5 th -tile [bit/s/Hz]	0.12		/		0.43
64x8 MU-MIMO, Reciprocity based; 8T SRS; gNB Config = (4,32,2,1,1;1,32)	15	DSUDD	Average [bit/s/Hz/TRxP]	3.3	1	14.75	/	/
			5 th -tile [bit/s/Hz]	0.12		0.36		/
32x4 MU-MIMO, Reciprocity based; 4T SRS; gNB Config = (8,8,2,1,1;2,8)	15	DSUDD	Average [bit/s/Hz/TRxP]	3.3	1	11.59	1	12.23
			5 th -tile [bit/s/Hz]	0.12		0.45		0.38

The evaluation results of UL spectral efficiency for LTE for evaluation configuration B are provided in Table 5.4.2.3.2-2.

It is observed that both LTE fulfill the UL spectral efficiency requirement for these configurations in evaluation configuration B.

**Table 5.4.2.3.2-2 UL spectral efficiency for LTE in Rural – eMBB
(Evaluation configuration B, CF=4 GHz)**

(a) LTE TDD

Scheme and antenna configuration	Sub-carrier spacing (kHz)	Frame structure	ITU Requirement		Channel model A		Channel model B	
					Number of samples	BW=20MHz	Number of samples	BW=20MHz
8x64 SU-MIMO, Codebook based, DFT-S-OFDM; gNB Config = (4,32,2,1,1;1,32)	15	DSUDD	Average [bit/s/Hz/TRxP]	1.6	1	10.15	/	/
			5 th -tile [bit/s/Hz]	0.045		0.07		/

5.4.2.3.3 Evaluation configuration C (LMLC)

LMLC (Low mobility large cell) is characterized by the large inter-site distance (ISD=6000m) and the low mobility users in Rural – eMBB test environment.

The evaluation results of DL spectral efficiency for LTE for evaluation configuration C are provided in Table 5.4.2.3.3-1.

It is observed that both LTE fulfills the DL spectral efficiency requirement for these configurations in evaluation configuration C.

**Table 5.4.2.3.3-1 DL spectral efficiency for LTE in Rural – eMBB
(Evaluation configuration C, LMLC)**

(a) LTE FDD

Scheme and antenna configuration	Sub-carrier spacing (kHz)	ITU Requirement ¹		Channel model A		Channel model B	
				Number of samples	BW=10MHz	Number of samples	BW=10MHz
8x4 MU-MIMO, Type II Codebook; gNB Config = (8,4,2,1,1;1,4)	15	Average [bit/s/Hz/TRxP]	3.3	1	5.96	1	5.97
		5 th -tile [bit/s/Hz]			0.15		0.15
Note 1: According to Report ITU-R M.2410 [4], the 5 th percentile user spectral efficiency requirement is not applicable to LMLC. The value shown here is for information only.							

(b) LTE TDD

Scheme and antenna configuration	Sub-carrier spacing (kHz)	Frame structure	ITU Requirement ¹		Channel model A		Channel model B	
					Number of samples	BW=20MHz	Number of samples	BW=20MHz
8x4 MU-MIMO, Type II Codebook; gNB Config = (8,4,2,1,1;1,4)	15	DSUDD	Average [bit/s/Hz/TRxP]	1.6	1	6.86	1	6.68
			5 th -tile [bit/s/Hz]			0.30		0.27
Note 1: According to Report ITU-R M.2410 [4], the 5 th percentile user spectral efficiency requirement is not applicable to LMLC. The value shown here is for information only.								

The evaluation results of UL spectral efficiency for LTE for evaluation configuration C are provided in Table 5.4.2.3.3-2.

It is observed that both LTE fulfills the UL spectral efficiency requirement for these configurations in evaluation configuration C.

**Table 5.4.2.3.3-2 UL spectral efficiency for LTE in Rural – eMBB
(Evaluation configuration C, LMLC)**

(a) LTE FDD

Scheme and antenna configuration	Sub-carrier spacing (kHz)	ITU Requirement ¹		Channel model A		Channel model B	
				Number of samples	BW=10MHz	Number of samples	BW=10MHz
2x8 SU-MIMO, Codebook based, DFT-S-OFDM; gNB Config = (8,4,2,1,1;1,4);	15	Average [bit/s/Hz/TRxP]	1.6	1	3.36	1	3.31
		5 th -tile [bit/s/Hz]			0.07		0.06
Note 1: According to Report ITU-R M.2410 [4], the 5 th percentile user spectral efficiency requirement is not applicable to LMLC. The value shown here is for information only.							

5.5 User experienced data rate

As defined in Report ITU-R M.2410 [4], user experienced data rate is the 5% point of the cumulative distribution function (CDF) of the user throughput. User throughput (during active time) is defined as the number of correctly received bits, i.e. the number of bits contained in the service data units (SDUs) delivered to Layer 3, over a certain period of time.

5.5.1 NR

User experienced data rate for NR are evaluated under Dense Urban – eMBB test environment.

5.5.1.1 Dense Urban – eMBB

For Dense Urban – eMBB test environment, single-band single-layer case using evaluation configuration A (carrier frequency = 4 GHz), and multi-band case using evaluation configuration C as defined in Report ITU-R M.2412 [6] are considered in evaluation. Detailed evaluation assumptions for configuration A are based on spectral efficiency evaluation, and can be found in Annex B.4.1; detailed evaluation assumptions and results for configuration C can be found in Annex B.4.3.

5.5.1.1.1 Evaluation configuration A (CF = 4 GHz)

For evaluation configuration A (single-band case), user experienced data rate for NR is evaluated based on 5th percentile user spectral efficiency, using the analytical way as provided in Report ITU-R M.2412 [6].

The evaluation results of DL user experienced data rate for NR FDD and NR TDD for evaluation configuration A are provided in Table 5.5.1.1.1-1.

It is assumed that for FDD and TDD with 15 kHz SCS, a component carrier with 40 MHz is used; and for TDD with 30 kHz SCS, a component carrier with 100 MHz is used. Multiple component carriers are aggregated to achieve the DL target user experienced data rate. The assumed DL/UL aggregated system bandwidth (for FDD) or overall aggregated system bandwidth (for TDD) is given in Table 5.5.1.1.1-1.

It is observed that both NR FDD and TDD fulfill the DL user experienced data rate requirement in evaluation configuration A.

**Table 5.5.1.1.1-1 DL user experienced data rate for NR in Dense Urban – eMBB
(Evaluation configuration A, CF=4 GHz)**

(a) NR FDD

Scheme and antenna configuration	Sub-carrier spacing	ITU Requirement [Mbps]	Channel model A			Channel model B		
			Number of samples	Assumed DL system bandwidth [MHz]	User exp. data rate [Mbps]	Number of samples	Assumed DL system bandwidth [MHz]	User exp. data rate [Mbps]
32x4 MU-MIMO Type II Codebook; gNB Config = (8,8,2,1,1;2,8)	15	100	11	240	108.33	8	240	105.30
32x4 MU-MIMO Type I Codebook; gNB Config = (8,8,2,1,1;2,8)	15	100	2	280	112.86	/	/	/
32x4 MU-MIMO Type II Codebook; gNB Config = (8,16,2,1,1;1,16)	15	100	1	160	104.66	/	/	/
32x4 MU-MIMO Type II Codebook; gNB Config = (16,8,2,1,1;2,8)	15	100	1	200	107.02	1	200	105.81
4x4 MU-MIMO Type II Codebook; gNB Config = (8,8,2,1,1;2,1)	15	100	1	240	112.64	/	/	/
32x8 MU-MIMO Type II Codebook; gNB Config = (16,8,2,1,1;2,8)	15	100	1	280	111.68	/	/	/

(b) NR TDD

Scheme and antenna configuration	Sub-carrier spacing	Frame structure	ITU Requirement [Mbps]	Channel model A			Channel model B		
				Number of samples	Assumed system bandwidth [MHz]	User exp. data rate [Mbps]	Number of samples	Assumed system bandwidth [MHz]	User exp. data rate [Mbps]
32x4 MU-MIMO, Reciprocity based; 4T SRS; gNB Config = (8,8,2,1,1;2,8)	30	DDDSU, S slot =10DL:2GP:2UL	100	3	300	138.60	3	300	129.45
32x4 MU-MIMO, Reciprocity based; 4T SRS; gNB Config = (8,8,2,1,1;2,8)	30	DDDSU, S slot =11DL:1GP:2UL	100	1	300	137.16	/	/	/
32x4 MU-MIMO, Reciprocity based; 4T SRS; gNB Config = (8,8,2,1,1;2,8)	15	DDDSU, S slot =10DL:2GP:2UL	100	2	360	104.36	2	320	102.09
64x4 MU-MIMO, Reciprocity based; 4T SRS; gNB Config = (12,8,2,1,1;4,8)	30	DDDSU, S slot =10DL:2GP:2UL	100	1	300	144.34	2	200	102.80
64x4 MU-MIMO, Reciprocity based; 4T SRS; gNB Config = (12,8,2,1,1;4,8)	15	DDDSU, S slot =10DL:2GP:2UL	100	1	240	100.87	1	240	102.57
32x4 MU-MIMO, Type II Codebook; gNB Config = (8,16,2,1,1;1,16)	15	DSUUD S slot =6DL:2GP:6UL	100	1	400	105.37	/	/	/
32x4 MU-MIMO, Reciprocity based; 4T SRS; gNB Config = (16,8,2,1,1;2,8)	15	DSUUD S slot =11DL:1GP:2UL	100	1	400	107.44	1	400	104.60
32x4 MU-MIMO, Reciprocity based; 4T SRS; gNB Config = (8,8,2,1,1;2,8)	15	DSUUD S slot =11DL:1GP:2UL	100	2	440	101.81	2	400	104.16
32x4 MU-MIMO, Reciprocity based; 4T SRS; gNB Config = (16,8,2,1,1;2,8)	30	DSUUD S slot =11DL:1GP:2UL	100	1	400	123.50	1	400	116.27
64x4 MU-MIMO, Reciprocity based; 4T SRS; gNB Config = (12,8,2,1,1;4,8)	15	DSUUD S slot =11DL:1GP:2UL	100	1	280	107.37	1	280	103.20
64x4 MU-MIMO, Reciprocity based; 4T SRS; gNB Config = (16,8,2,1,1;4,8)	15	DSUUD S slot =11DL:1GP:2UL	100	1	280	107.91	1	280	110.81
64x4 MU-MIMO, Reciprocity based; 4T SRS; gNB Config = (12,8,2,1,1;4,8)	30	DSUUD S slot =11DL:1GP:2UL	100	1	300	126.31	1	300	126.74
64x4 MU-MIMO, Reciprocity based; 4T SRS; gNB Config = (12,8,2,1,1;4,8)	30	DSUUD S slot =6DL:2GP:6UL	100	1	300	114.97	1	300	109.22

64x4 MU-MIMO, Reciprocity based; 4T SRS; gNB Config = (16,8,2,1,1;4,8)	30	DSUUD S slot =11DL:1GP: 2UL	100	1	300	132.83	1	300	135.22
64x8 MU-MIMO, Reciprocity based; 4T SRS; gNB Config = (4,32,2,1,1;1,32)	15	DDDSU S slot =10DL:2GP: 2UL	100	1	400	108.73	/	/	/
64x4 MU-MIMO, Reciprocity based; 4T SRS; gNB Config = (12,8,2,1,1;4,8)	30	DDDDD DDSUU S slot =6DL:4GP:4 UL	100	1	300	124.58	/	/	/
32x8 MU-MIMO, Reciprocity based; 2T SRS; gNB Config = (16,8,2,1,1;2,8)	15	DSUUD S slot =6DL:2GP:6 UL	100	1	560	102.08	/	/	/
128x4, MU-MIMO, Reciprocity based; 4T SRS; gNB Config = (8,16,2,1,1;4,16)	30	DDSU S slot =10DL:2GP: 2UL	100	/	/	/	1	360	111.91
64x4 MU-MIMO, Reciprocity based; 4T SRS; gNB Config = (4,8,2,1,1;4,8)	30	DDDSU S slot =10DL:2GP: 2UL	100	1	200	119.46	1	200	104.18
16x4 MU-MIMO, Reciprocity based; 4T SRS; gNB Config = (8,8,2,1,1;2,8)	30	DDDSU S slot =10DL:2GP: 2UL	100	1	300	110.93	1	300	113.01
32x4 MU-MIMO, Reciprocity based; 4T SRS; gNB Config = (12,8,2,1,1;4,8)	30	DDDDDDD SUU S slot =6DL:4GP:6 UL	100	1	200	107.91	1	300	138.32
64x4 MU-MIMO, Reciprocity based; 4T SRS; gNB Config = (12,8,2,1,1;4,8)	30	DDDSUDDS UU S slot =10DL:2GP: 2UL	100	1	200	106.39	1	300	149.29

The evaluation results of UL user experienced data rate for NR FDD and NR TDD for evaluation configuration A are provided in Table 5.5.1.1.1-2.

It is assumed that for FDD with 15 kHz SCS, a component carrier with 40 MHz is used; for TDD with 15 kHz SCS, a component carrier with 50 MHz is used; and for TDD with 30 kHz SCS, a component carrier with 100 MHz is used. Multiple component carriers are aggregated to achieve the UL target user experienced data rate. The assumed aggregated system bandwidth is given in Table 5.5.1.1.1-2.

It is observed that both NR FDD and TDD fulfill the UL user experienced data rate requirement in evaluation configuration A.

**Table 5.5.1.1.1-2 UL user experienced data rate for NR in Dense Urban – eMBB
(Evaluation configuration A, CF=4 GHz)**

(a) NR FDD

Scheme and antenna configuration	Sub-carrier spacing	ITU Requirement [Mbps]	Channel model A			Channel model B		
			Number of samples	Assumed UL system bandwidth [MHz]	User exp. data rate [Mbps]	Number of samples	Assumed UL system bandwidth [MHz]	User exp. data rate [Mbps]
2x16 SU-MIMO, OFDMA; gNB Config = (8,8,2,1,1;1,8)	15	50	4	240	59.79	1	240	52.48
2x32 SU-MIMO, OFDMA; gNB Config = (8,8,2,1,1;2,8)	15	50	2	160	58.50	3	160	53.79
4x32 SU-MIMO, OFDMA; gNB Config = (8,8,2,1,1;2,8)	15	50	2	160	66.66	1	160	59.95
4x32 MU-MIMO, OFDMA; gNB Config = (8,16,2,1,1;1,16)	15	50	1	120	63.33	/	/	/
4x32 MU-MIMO, OFDMA; gNB Config = (16,8,2,1,1;2,8)	15	50	1	200	55.46	/	/	/
4x16 SU-MIMO, OFDMA; gNB Config = (8,8,2,1,1;1,8)	15	50	1	160	52.80	1	160	55.84
4x4 SU-MIMO, OFDMA; gNB Config = (8,8,2,1,1;2,1)	15	50	1	280	54.50	/	/	/

(b) NR TDD

Scheme and antenna configuration	Sub-carrier spacing	Frame structure	ITU Requirement [Mbps]	Channel model A			Channel model B		
				Number of samples	Assumed system bandwidth [MHz]	User exp. data rate [Mbps]	Number of samples	Assumed system bandwidth [MHz]	User exp. data rate [Mbps]
2x32 SU-MIMO, Codebook based, OFDMA; gNB Config = (8,8,2,1,1;2,8)	30	DDDSU S slot =10DL:2GP: 2UL	50	1	800	53.68	1	900	54.55
2x32 SU-MIMO, Codebook based, OFDMA; gNB Config = (8,8,2,1,1;2,8)	15	DDDSU S slot =10DL:2GP: 2UL	50	1	800	53.94	1	900	53.83
2x64 SU-MIMO, Codebook based, OFDMA; gNB Config = (12,8,2,1,1;4,8)	30	DDDSU S slot =10DL:2GP: 2UL	50	1	600	51.80	2	600	59.48
2x64 SU-MIMO, Codebook based, OFDMA; gNB Config = (12,8,2,1,1;4,8)	15	DDDSU S slot =10DL:2GP: 2UL	50	1	600	52.24	1	700	50.11
4x32 SU-MIMO, Codebook based, OFDMA; gNB Config = (8,8,2,1,1;2,8)	30	DDDSU S slot =10DL:2GP: 2UL	50	1	700	56.21	1	700	52.61
4x32 SU-MIMO, Codebook based, OFDMA; gNB Config = (8,8,2,1,1;2,8)	15	DDDSU S slot =10DL:2GP: 2UL	50	2	700	55.80	1	800	55.98
4x32 MU-MIMO, Codebook based, OFDMA; gNB Config = (8,16,2,1,1;1,16)	15	DSUUD S slot =6DL:2GP:6 UL	50	1	300	73.15	/	/	/
4x16 SU-MIMO, Non-codebook based, OFDMA; gNB Config = (8,8,2,1,1;1,8)	15	DSUUD S slot =11DL:1GP: 2UL	50	1	500	58.82	1	400	55.07
4x16 SU-MIMO, Non-codebook based, OFDMA; gNB Config = (8,8,2,1,1;1,8)	30	DSUUD S slot =11DL:1GP: 2UL	50	1	500	57.08	1	400	61.35
4x16 SU-MIMO, codebook based, OFDMA; gNB Config = (8,8,2,1,1;1,8)	15	DSUUD S slot =11DL:1GP: 2UL	50	1	500	54.90	1	500	60.35
4x16 SU-MIMO, codebook based, OFDMA; gNB Config = (8,8,2,1,1;1,8)	30	DSUUD S slot =11DL:1GP: 2UL	50	1	500	50.11	1	400	50.89
2x32 SU-MIMO, Codebook based, OFDMA; gNB Config = (12,8,2,1,1;4,4)	30	DSUUD S slot =6DL:2GP:6 UL	50	/	/	/	1	200	55.44
2x64 SU-MIMO, Codebook based, OFDMA; gNB Config = (12,8,2,1,1;4,8)	30	DSUUD S slot =6DL:2GP:6 UL	50	1	200	59.63	1	200	57.54

4x128, MU-MIMO, Codebook based, OFDMA; gNB Config = (8,16,2,1,1;4,16)	30	DDSU S slot =10DL:2GP: 2UL	50	/	/	/	1	1000	52.92
2x64 SU-MIMO, Codebook based, OFDMA; gNB Config = (12,8,2,1,1;4,8)	30	DDDSUDDS UU S slot =10DL:2GP: 2UL	50	1	300	53.56	1	300	53.77
2x64 SU-MIMO, Codebook based, OFDMA; gNB Config = (12,8,2,1,1;4,8)	30	DDDDDDDD SUU S slot =6DL:4GP:4 UL	50	1	500	56.53	1	500	56.77
4x32 SU-MIMO, Codebook based, OFDMA; gNB Config = (8,8,2,1,1;2,8)	15	DSUUD S slot =11DL:1GP: 2UL	50	/	/	/	1	300	50.06
4x32 SU-MIMO, Codebook based, OFDMA; gNB Config = (8,8,2,1,1;2,8)	15	DDDSU S slot =10DL:2GP: 2UL	50	/	/	/	1	800	54.59

5.5.1.1.2 Evaluation configuration B (CF = 30 GHz)

Void.

5.5.1.1.3 Evaluation configuration C

For evaluation configuration C (multi-band), the UL user experienced data rate is evaluated using a TDD band (on 30 GHz) and a supplementary uplink (SUL) band (on 4 GHz). System level simulation is used. The “cell edge” users on TDD band are offloaded to SUL band. The evaluation results of NR TDD+SUL are provided in Table 5.5.1.1.3-1.

In the evaluation, it is assumed that for FDD with 15 kHz SCS, a component carrier with 20 MHz is used; for TDD with 60 kHz SCS, a component carrier with 200 MHz is used. Multiple component carriers on either TDD band or SUL band are aggregated to achieve the UL target user experienced data rate. The assumed aggregated system bandwidth is given in Table 5.5.1.1.3-1.

It is observed that NR can fulfill UL user experienced data rate requirement for the above configurations in evaluation configuration C.

**Table 5.5.1.1.3-1 UL user experienced data rate for NR in Dense Urban – eMBB
(Evaluation configuration C)**

(a) NR TDD+SUL, Macro layer only

Scheme and antenna configuration	Sub-carrier spacing	Frame structure	ITU Requirement [Mbps]	Channel model A			Channel model B		
				Number of samples	Assumed system bandwidth [MHz]	User exp. data rate [Mbps]	Number of samples	Assumed system bandwidth [MHz]	User exp. data rate [Mbps]
4 GHz (SUL band): 2x32 SU-MIMO, Codebook based OFDMA gNB Config = (8,8,2,1,1; 2,8) 30 GHz (TDD band): 8x32 SU-MIMO, Codebook based, OFDMA (2 panel@UE) gNB Config = (4,8,2,2,2; 1,4) UE Config = (2,4,2,1,2; 1,2) 50% offload to SUL band	4 GHz: 15 30 GHz: 60	4 GHz: full uplink; 30 GHz: DDDSU S slot =10DL:2GP:2 UL	50	1	4 GHz: 100 (for UL) 30 GHz: 1200	53.13	1	4 GHz: 100 (for UL) 30 GHz: 1200	51.39

The DL user experienced data rate is evaluated using a TDD band (on 4GHz) with Macro layer and Micro layer. The evaluation results of NR are provided in Table 5.5.1.1.3-2.

In the evaluation, it is assumed that for TDD with 30 kHz SCS, a component carrier with 20 MHz is used. Multiple component carriers on TDD band are aggregated to achieve the DL target user experienced data rate. The assumed aggregated system bandwidth is given in Table 5.5.1.1.3-2.

It is observed that NR can fulfill DL user experienced data rate requirement for the above configurations in evaluation configuration C.

**Table 5.5.1.1.3-2 DL user experienced data rate for NR in Dense Urban – eMBB
(Evaluation configuration C)**

(a) NR TDD band (4GHz), Macro layer + Micro layer

Scheme and antenna configuration	Sub-carrier spacing	Frame structure	ITU Requirement [Mbps]	Channel model A			Channel model B		
				Number of samples	Assumed system bandwidth [MHz]	User exp. data rate [Mbps]	Number of samples	Assumed system bandwidth [MHz]	User exp. data rate [Mbps]
Macro and Micro layer : 32x4 MU-MIMO, 4T SRS; gNB Config = (8,8,2,1,1; 2,8)	Macro and Micro layer: 30	Macro and Micro layer: DDDSU S slot =10DL:2GP:2 UL	100	/	/	/	1	260	127.66

5.5.2 LTE

User experienced data rate for LTE are evaluated under Dense Urban – eMBB test environment.

5.5.2.1 Dense Urban – eMBB

For Dense Urban – eMBB test environment, single-band single-layer case using evaluation configuration A (carrier frequency = 4 GHz) as defined in Report ITU-R M.2412 [6] is considered in evaluation. Detailed evaluation assumptions for configuration A are based on spectral efficiency evaluation, and can be found in Annex B.4.1.

5.5.2.1.1 Evaluation configuration A (CF = 4 GHz)

For evaluation configuration A (single-band case), user experienced data rate for LTE is evaluated based on 5th percentile user spectral efficiency, using the analytical way as provided in Report ITU-R M.2412 [6].

The evaluation results of DL user experienced data rate for LTE FDD and NR TDD for evaluation configuration A are provided in Table 5.5.2.1.1-1.

It is assumed that for FDD and TDD with 15 kHz SCS, a component carrier with 20 MHz for FDD and TDD is used. Multiple component carriers are aggregated to achieve the DL target user experienced data rate. The assumed DL/UL aggregated system bandwidth (for FDD) or overall aggregated system bandwidth (for TDD) is given in Table 5.5.2.1.1-1.

It is observed that both NR FDD and TDD fulfill the DL user experienced data rate requirement in evaluation configuration A.

**Table 5.5.2.1.1-1 DL user experienced data rate for LTE in Dense Urban – eMBB
(Evaluation configuration A, CF=4 GHz)**

(a) LTE FDD

Scheme and antenna configuration	Sub-carrier spacing	ITU Requirement [Mbps]	Channel model A			Channel model B		
			Number of samples	Assumed DL system bandwidth [MHz]	User exp. data rate [Mbps]	Number of samples	Assumed DL system bandwidth [MHz]	User exp. data rate [Mbps]
32x4 MU-MIMO Advanced CSI Codebook; gNB Config = (8,8,2,1,1;2,8)	15	100	1	360	101.52	1	360	101.52
32x4 MU-MIMO Advanced CSI Codebook; gNB Config = (16,8,2,1,1;2,8)	15	100	1	360	105.48	1	360	103.68

(b) LTE TDD

Scheme and antenna configuration	Sub-carrier spacing	Frame structure	ITU Requirement [Mbps]	Channel model A			Channel model B		
				Number of samples	Assumed system bandwidth [MHz]	User exp. data rate [Mbps]	Number of samples	Assumed system bandwidth [MHz]	User exp. data rate [Mbps]
64x2 MU-MIMO, Reciprocity based; 2T SRS; gNB Config = (12,8,2,1,1;4,8)	15	DSUDD, S slot =10DL:2GP: 2UL	100	1	540	102.21	1	520	100.79
32x4 MU-MIMO, Reciprocity based; 4T SRS; gNB Config = (16,8,2,1,1;2,8)	15	DSUUD, S slot =11DL:1GP: 2UL	100	1	460	100.19	1	480	102.93
64x4 MU-MIMO, Reciprocity based; 4T SRS; gNB Config = (12,8,2,1,1;4,8)	15	DSUUD, S slot =11DL:1GP: 2UL	100	1	360	105.43	1	360	102.38
64x4 MU-MIMO, Reciprocity based; 4T SRS;	15	DSUUD, S slot =11DL:1GP:	100	1	340	100.53	1	340	100.34

gNB Config = (16,8,2,1,1;4,8)		2UL							
32x2 MU-MIMO, Reciprocity based; 2T SRS; gNB Config = (16,8,2,1,1;4,4)	15	DSUUD, S slot =6DL:2GP:6 UL	100	1	620	102.39	1	600	102.00

The evaluation results of UL user experienced data rate for LTE FDD and NR TDD for evaluation configuration A are provided in Table 5.5.2.1.1-2.

It is assumed that for FDD and TDD with 15 kHz SCS, a component carrier with 20 MHz for FDD and TDD is used. Multiple component carriers are aggregated to achieve the UL target user experienced data rate. The assumed DL/UL aggregated system bandwidth (for FDD) or overall aggregated system bandwidth (for TDD) is given in Table 5.5.2.1.1-2.

It is observed that both NR FDD and TDD fulfill the UL user experienced data rate requirement in evaluation configuration A.

Table 5.5.2.1.1-2 UL user experienced data rate for LTE in Dense Urban – eMBB (Evaluation configuration A, CF=4 GHz)

(a) LTE FDD

Scheme and antenna configuration	Sub-carrier spacing	ITU Requirement [Mbps]	Channel model A			Channel model B		
			Number of samples	Assumed UL system bandwidth [MHz]	User exp. data rate [Mbps]	Number of samples	Assumed UL system bandwidth [MHz]	User exp. data rate [Mbps]
4x32 SU-MIMO, DFT-S-OFDM; gNB Config = (16,8,2,1,1;2,8)	15	50	1	140	54.46	1	140	56.98

(b) LTE TDD

Scheme and antenna configuration	Sub-carrier spacing	Frame structure	ITU Requirement [Mbps]	Channel model A			Channel model B		
				Number of samples	Assumed system bandwidth [MHz]	User exp. data rate [Mbps]	Number of samples	Assumed system bandwidth [MHz]	User exp. data rate [Mbps]
4x32 SU-MIMO, Codebook based, DTF-S-OFDM; gNB Config = (16,8,2,1,1;2,8)	15	DSUUD S slot =11DL:1GP:2UL	50	1	380	50.00	1	360	50.19
2x32 SU-MIMO, Codebook based, DTF-S-OFDM; gNB Config = (16,8,2,1,1;4,4)	15	DSUUD S slot =6DL:2GP:6 UL	50	1	280	53.04	1	320	51.33

5.6 Area traffic capacity

As defined in Report ITU-R M.2410 [4], area traffic capacity is the total traffic throughput served per geographic area (in Mbit/s/m²). The throughput is the number of correctly received bits, i.e. the number of bits contained in the SDUs delivered to Layer 3, over a certain period of time.

5.6.1 NR

NR evaluation for area traffic capacity is conducted for Indoor Hotspot – eMBB test environment. A wide range of antenna configurations and transmission schemes are considered. Detailed evaluation assumptions are according to spectral efficiency evaluation, which can be found in Annex B.4.1.

5.6.1.1 Indoor Hotspot – eMBB

The area traffic capacity of NR is evaluated using analytical way based on the downlink average spectral efficiency evaluation for NR in Indoor Hotspot – eMBB test environment. The analytical way is defined in Report ITU-R M.2412 [6].

5.6.1.1.1 Evaluation configuration A (CF = 4 GHz)

The evaluation results of area traffic capacity for NR FDD and NR TDD for evaluation configuration A with 12TRxP are provided in Table 5.6.1.1.1-1.

It is assumed that for FDD and TDD with 15 kHz SCS, a component carrier with 40 MHz is used; and for TDD with 30 kHz SCS, a component carrier with 100 MHz is used. Multiple component carriers are aggregated to achieve the target area traffic capacity. The assumed aggregated DL system bandwidth (for FDD) and overall system bandwidth (for TDD) are given in Table 5.6.1.1.1-1.

**Table 5.6.1.1.1-1 Area traffic capacity for NR in Indoor Hotspot – eMBB
(Evaluation configuration A, CF=4 GHz, for 12TRxP)**

(a) NR FDD

Scheme and antenna configuration	Sub-carrier spacing	ITU Requirement [Mbps/m ²]	Channel model A			Channel model B		
			Number of samples	Assumed DL system bandwidth [MHz]	Area traffic capacity [Mbps/m ²]	Number of samples	Assumed DL system bandwidth [MHz]	Area traffic capacity [Mbps/m ²]
32x4 MU-MIMO Type II Codebook gNB Config = (4,4,2,1,1;4,4)	15	10	10	400	10.59	6	400	10.92
32x4 MU-MIMO Type I Codebook gNB Config = (4,4,2,1,1;4,4)	15	10	1	360	10.06	/	/	/
32x8 MU-MIMO Type II Codebook gNB Config = (4,4,2,1,1;4,4)	15	10	2	400	10.05	1	400	10.38

(b) NR TDD

Scheme and antenna configuration	Sub-carrier spacing	Frame structure	ITU Requirement [Mbps/m ²]	Channel model A			Channel model B		
				Number of samples	Assumed system bandwidth [MHz]	Area traffic capacity [Mbps/m ²]	Number of samples	Assumed system bandwidth [MHz]	Area traffic capacity [Mbps/m ²]
32x4 MU-MIMO, Reciprocity based; 4T SRS; gNB Config = (4,4,2,1,1;4,4)	30	DDDSU; S slot = (10DL:2GP: 2UL)	10	1	400	11.67	3	500	11.64
32x4 MU-MIMO, Reciprocity based; 4T SRS; gNB Config = (4,4,2,1,1;4,4)	15	DDDSU; S slot = (10DL:2GP: 2UL)	10	1	480	10.65	1	480	10.64

32x4 MU-MIMO, Type II Codebook based, gNB Config = (4,4,2,1,1;4,4)	15	DSUUD; S slot = (11DL:1GP :2UL)	10	1	600	10.28	1	600	10.50
32x4 MU-MIMO, Reciprocity based; 4T SRS, gNB Config = (4,4,2,1,1;4,4)	30	DSUUD; S slot = (11DL:1GP :2UL)	10	1	600	10.71	1	600	10.91
32x4 MU-MIMO, Reciprocity based; 4T SRS, gNB Config = (4,4,2,1,1;4,4)	30	DSUUD; S slot = (6DL:2GP :6UL)	10	1	700	10.04	1	700	10.46
32x4 MU-MIMO, Reciprocity based; 4T SRS, gNB Config = (4,4,2,1,1;4,4)	15	DSUUD; S slot = (11DL:1GP :2UL)	10	3	680	10.33	3	680	10.44
32x4 MU-MIMO, Reciprocity based; 4T SRS, gNB Config = (4,4,2,1,1;4,4)	15	DSUUD; S slot = (6DL:2GP :6UL)	10	/	/	/	1	760	10.00
32x4 MU-MIMO, Reciprocity based; 4T SRS, gNB Config = (4,4,2,1,1;4,4)	30	DDDDD DDSUU; S slot = (6DL:4GP:4 UL)	10	2	500	12.29	1	500	11.71
32x8 MU-MIMO, Reciprocity based; 8T SRS, gNB Config = (4,4,2,1,1;4,4)	15	DSUUD; S slot = (6DL:2GP :6UL)	10	1	800	10.20	/	/	/
32x4 MU-MIMO, Reciprocity based; 4T SRS, gNB Config = (4,4,2,1,1;4,4)	30	DDDSU DDSUU; S slot = (6DL:4GP:4 UL)	10	1	600	11.96	1	500	10.17
32x8 MU-MIMO, Type II Codebook based; gNB Config = (4,4,2,1,1;4,4)	30	DDDSU; S slot = (10DL:2GP :2UL)	10	1	600	11.52	1	600	11.94

The evaluation results of area traffic capacity for NR FDD and NR TDD for evaluation configuration A with 36TRxP are provided in Table 5.6.1.1.1-2.

It is assumed that for FDD and TDD with 15 kHz SCS, a component carrier with 40 MHz is used; and for TDD with 30 kHz SCS, a component carrier with 100 MHz is used. Multiple component carriers are aggregated to achieve the DL target user experienced data rate. The assumed aggregated system bandwidth is given in Table 5.5.1.1.1-2.

It is observed that both NR FDD and TDD fulfill the area traffic capacity requirement for all the above configurations in evaluation configuration A.

**Table 5.6.1.1.1-2 Area traffic capacity for NR in Indoor Hotspot – eMBB
(Evaluation configuration A, CF=4 GHz, for 36TRxP)**

(a) NR FDD

Scheme and antenna configuration	Sub-carrier spacing	ITU Requirement [Mbps/m ²]	Channel model A			Channel model B		
			Number of samples	Assumed DL system bandwidth [MHz]	Area traffic capacity [Mbps/m ²]	Number of samples	Assumed DL system bandwidth [MHz]	Area traffic capacity [Mbps/m ²]
32x4 MU-MIMO Type II Codebook gNB Config = (8,16,2,1,1;2,8)	15	10	7	120	10.66	4	120	11.42
32x4MU-MIMO Type I codebook gNB Config = (4,4,2,1,1;4,4)	15	10	1	160	10.91	/	/	/

(b) NR TDD

Scheme and antenna configuration	Sub-carrier spacing	Frame structure	ITU Requirement [Mbps/m ²]	Channel model A			Channel model B		
				Number of samples	Assumed system bandwidth [MHz]	Area traffic capacity [Mbps/m ²]	Number of samples	Assumed system bandwidth [MHz]	Area traffic capacity [Mbps/m ²]
32x4 MU-MIMO, Reciprocity based; 4T SRS gNB Config = (8,16,2,1,1;2,8)	30	DDDSU; S Slot = (10DL:2GP, 2UL)	10	2	200	14.85	2	200	15.04
32x4 MU-MIMO, Reciprocity based; 4T SRS gNB Config = (8,16,2,1,1;2,8)	15	DDDSU; S Slot = (10DL:2GP: 2UL)	10	1	160	12.15	1	160	12.24
32x4 MU-MIMO, Type II Codebook based; gNB Config = (8,16,2,1,1;2,8)	15	DSUUD; S Slot = (6DL:2GP:6 UL)	10	1	280	10.37	/	/	/
32x4 MU-MIMO, Reciprocity based; 4T SRS; gNB Config = (8,16,2,1,1;2,8)	15	DSUUD; S Slot = (11DL:1GP: 2UL)	10	2	240	11.28	2	240	11.47
32x4 MU-MIMO, Reciprocity based; gNB Config = (8,16,2,1,1;2,8)	30	DSUUD; S Slot = (11DL:1GP: 2UL)	10	1	200	11.28	1	200	11.43
32x4 MU-MIMO, Reciprocity based; 4T SRS; gNB Config = (8,8,2,1,1;2,8)	30	DDDSU; S Slot = (10DL:2GP: 2UL)	10	1	200	11.02	1	200	11.00

5.6.1.1.2 Evaluation configuration B (CF = 30 GHz)

The evaluation results of area traffic capacity for NR for evaluation configuration B with 12TRxP are provided in Table 5.6.1.1.2-1.

It is assumed that for TDD with 60 kHz SCS, a component carrier with 200 MHz is used; and for TDD with 120 kHz SCS, a component carrier with 400 MHz is used. Multiple component carriers are aggregated to achieve the target area traffic capacity. The assumed aggregated system bandwidth is given in Table 5.6.1.1.2-1.

**Table 5.6.1.1.2-1 Area traffic capacity for NR in Indoor Hotspot – eMBB
(Evaluation configuration B, CF=30 GHz, for 12TRxP)**

(a) NR TDD

Scheme and antenna configuration	Sub-carrier spacing	Frame structure	ITU Requirement [Mbps/m ²]	Number of samples	Assumed system bandwidth [MHz]	Area traffic capacity [Mbps/m ²]
32x8 MU-MIMO, 4T SRS (2 panel@UE), gNB Config = (4,4,2,1,1;4,4); UE Config = (2,4,2,1,2; 1,2)	120	DDDSU; S Slot = (10DL:2GP:2UL)	10	1	800	19.69
32x8 MU-MIMO, 4T SRS (2 panel@UE), gNB Config = (4,4,2,1,1;4,4); UE Config = (2,4,2,1,2; 1,2)	60	DDDSU; S Slot = (10DL:2GP:2UL)	10	1	600	13.05
32x8 MU-MIMO, 4T SRS (2 panel@UE), gNB Config = (4,4,2,1,1;4,4); UE Config = (2,4,2,1,2; 1,2)	60	DDDSU; S Slot = (11DL:1GP:2UL)	10	1	600	13.59
32x4 MU-MIMO, Type II Codebook based (2 panel@UE), gNB Config = (8,8,2,1,1;4,4); UE Config = (2,4,2,1,2; 1,1)	120	DSUUD; S Slot = (6DL:2GP:2UL)	10	1	1200	12.55
32x8 MU-MIMO, 4T SRS (2 panel@UE), gNB Config = (8,8,2,1,1;2,8); UE Config = (2,4,2,1,2; 1,2)	60	DSUUD; S Slot = (11DL:1GP:2UL)	10	1	600	11.57
32x8 MU-MIMO, 4T SRS (2 panel@UE), gNB Config = (8,8,2,1,1;2,8); UE Config = (2,4,2,1,2; 1,2)	60	DSUUD; S Slot = (6DL:2GP:6UL)	10	1	800	11.72
32x8 MU-MIMO, 4T SRS (2 panel@UE), gNB Config = (8,8,2,1,1;2,8); UE Config = (2,4,2,1,2; 1,2)	120	DSUUD; S Slot = (11DL:1GP:2UL)	10	1	800	15.93
64x8 MU-MIMO, Reciprocity based; 4T SRS (2 panel@UE), gNB Config = (8,16,2,1,1;2,16); UE Config = (2,4,2,1,2; 1,2)	60	DSUUD; S Slot = (11DL:1GP:2UL)	10	1	600	13.02
64x8 MU-MIMO, Reciprocity based; 4T SRS (2 panel@UE), gNB Config = (8,16,2,1,1;2,16); UE Config = (2,4,2,1,2; 1,2)	120	DSUUD; S Slot = (11DL:1GP:2UL)	10	1	800	17.98
8x2 MU-MIMO, Reciprocity based; 2T SRS (1 panel at UE), gNB Config = (16,8,2,1,1;2,2); UE Config = (4,4,2,1,1; 1,2)	120	DDDU	10	1	800	17.96
64x16 MU-MIMO, Reciprocity based; 4T SRS (2 panel@UE), gNB Config = (4,32,2,1,1;1,32); UE Config = (1,4,2,1,2; 1,4)	60	DDDSU S Slot = (10DL:2GP:2UL)	10	1	400	10.22
32x8 MU-MIMO, 4T SRS (2 panel@UE), gNB Config = (8,16,2,1,1;4,4); UE Config = (2,4,2,1,2; 1,2)	120	DDDSU S Slot = (10DL:2GP:2UL)	10	1	800	15.76

The evaluation results of area traffic capacity for NR for evaluation configuration B with 36TRxP are provided in Table 5.6.1.1.2-2.

It is assumed that for TDD with 60 kHz SCS, a component carrier with 200 MHz is used; and for TDD with 120 kHz SCS, a component carrier with 400 MHz is used. Multiple component carriers are aggregated to achieve the target area traffic capacity. The assumed aggregated system bandwidth is given in Table 5.6.1.1.2-2.

It is observed that both NR fulfills the area traffic capacity requirement for all the above configurations in evaluation configuration B.

**Table 5.6.1.1.2-2 Area traffic capacity for NR in Indoor Hotspot – eMBB
(Evaluation configuration B, CF=30 GHz, for 36TRxP)**

(a) NR TDD

Scheme and antenna configuration	Sub-carrier spacing	Frame structure	ITU Requirement [Mbps/m ²]	Number of samples	Assumed system bandwidth [MHz]	Area traffic capacity [Mbps/m ²]
32x4 MU-MIMO, Type II Codebook (2 panel@UE), gNB Config = (8,8,2,1,1;4,4); UE Config = (2,4,2,1,2; 1,1)	120	DSUUD; S Slot = (6DL:2GP:6UL)	10	1	400	12.86
32x8 MU-MIMO, Reciprocity based; 4T SRS (2 panel@UE), gNB Config = (8,8,2,1,1;2,8); UE Config = (2,4,2,1,2; 1,2)	60	DSUUD; S Slot = (11DL:1GP:2UL)	10	1	400	19.77
32x8 MU-MIMO, Reciprocity based; 4T SRS (2 panel@UE), gNB Config = (8,8,2,1,1;2,8); UE Config = (2,4,2,1,2; 1,2)	120	DSUUD; S Slot = (11DL:1GP:2UL)	10	1	400	19.39
64x8 MU-MIMO, Reciprocity based; 4T SRS (2 panel@UE), gNB Config = (8,16,2,1,1;2,16); UEConfig = (2,4,2,1,2; 1,2)	60	DSUUD; S Slot = (11DL:1GP:2UL)	10	1	200	11.54
64x8 MU-MIMO, Reciprocity based; 4T SRS (2 panel@UE), gNB Config = (8,16,2,1,1;2,16); UE Config = (2,4,2,1,2; 1,2)	120	DSUUD; S Slot = (11DL:1GP:2UL)	10	1	400	22.76

5.6.2 LTE

LTE evaluation for area traffic capacity is conducted for Indoor Hotspot – eMBB test environment. A wide range of antenna configurations and transmission schemes are considered. Detailed evaluation assumptions are according to spectral efficiency evaluation, which can be found in Annex B.4.1.

5.6.2.1 Indoor Hotspot – eMBB

The area traffic capacity of LTE is evaluated using analytical way based on the downlink average spectral efficiency evaluation for LTE in Indoor Hotspot – eMBB test environment. The analytical way is defined in Report ITU-R M.2412 [6].

5.6.2.1.1 Evaluation configuration A (CF = 4 GHz)

The evaluation results of area traffic capacity for LTE FDD and LTE TDD for evaluation configuration A with 12TRxP are provided in Table 5.6.2.1.1-1.

It is assumed that for FDD and TDD with 15 kHz SCS, a component carrier with 20 MHz for FDD and TDD is used. The assumed aggregated DL system bandwidth (for FDD) and overall system bandwidth (for TDD) are given in Table 5.6.2.1.1-1.

Table 5.6.2.1.1-1 Area traffic capacity for LTE in Indoor Hotspot – eMBB (Evaluation configuration A, CF=4 GHz, for 12TRxP)

(a) LTE FDD

Scheme and antenna configuration	Sub-carrier spacing	ITU Requirement [Mbps/m ²]	Channel model A			Channel model B		
			Number of samples	Assumed DL system bandwidth [MHz]	Area traffic capacity [Mbps/m ²]	Number of samples	Assumed DL system bandwidth [MHz]	Area traffic capacity [Mbps/m ²]
32x4 MU-MIMO Advanced CSI Codebook gNB Config = (4,4,2,1,1;4,4)	15	10	1	520	10.20	1	520	10.25

5.7 Latency

5.7.1 User plane latency

As defined in Report ITU-R M.2410 [4], user plane latency is the contribution of the radio network to the time from when the source sends a packet to when the destination receives it (in ms).

5.7.1.1 NR

The evaluation of NR user plane latency is based on the procedure illustrated in Figure 5.7.1.1-1.

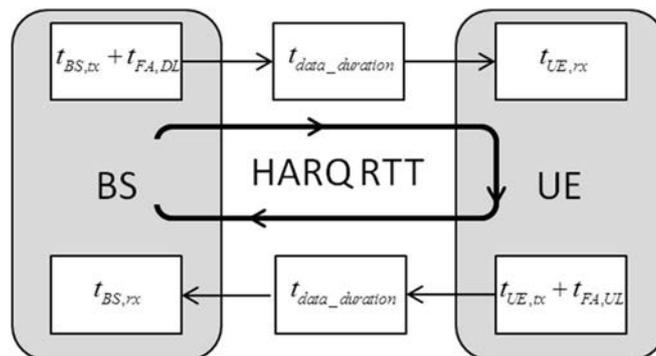

Figure 5.7.1.1-1 User plane procedure for evaluation

The detailed assumptions of each step are provided in Table 5.7.1.1.1-1 and Table 5.7.1.1.2-1 for downlink and uplink, respectively.

The additional assumptions to derive the evaluation results of NR user plane latency are listed as below.

- It is assumed that the packet arrives at any time of any OFDM symbol. In this case, the 0.5symbol length is added as the “average symbol alignment time” at the beginning of the procedure.
- The transmission of PDCCH, PDSCH, PUCCH, PUSCH cannot be across the slot. Otherwise the transmission will wait for the next slot.
- The PDSCH/PUSCH allocation (transmission duration) of 2/4/7/14-os non-slot or slot are evaluated.
 - If the evaluation is for 14 OFDM Symbol length slot, then slot based scheduling is used.
 - Otherwise non-slot based scheduling is used.
- The resource mapping type A and B are considered, which impact the start timing of a transmission. Details on resource mapping mechanism can be found in TS 38.214 [9].
- It is assumed that PDCCH monitoring occasion occurs at every OFDM symbol in the evaluation.

5.7.1.1.1 Downlink

The downlink procedure is abstracted in Table 5.7.1.1.1-1, where the assumptions of each step for evaluation are given.

Table 5.7.1.1.1-1 DL user plane procedure for NR

ID	Component	Notations	Value
1	DL data transfer	$T_1 = (t_{BS,tx} + t_{FA,DL}) + t_{DL_duration} + t_{UE,rx}$	
1.1	BS processing delay	$t_{BS,tx}$ The time interval between the data is arrived, and packet is generated.	$T_{proc,2}/2$, with $d_{2,1}= d_{2,2}= d_{2,3}=0$. ($T_{proc,2}$ is defined in Section 6.4 of TS38.214) (NOTE1, NOTE2)
1.2	DL Frame alignment (transmission alignment)	$t_{FA,DL}$ It includes frame alignment time, and the waiting time for next available DL slot	$T_{FA} + T_{wait}$, T_{FA} is the frame alignment time within the current DL slot; T_{wait} is the waiting time for next available DL slot if the current slot is not DL slot.
1.3	TTI for DL data packet transmission	$t_{DL_duration}$	Length of one slot (14 OFDM symbol length) or non-slot (2/4/7 OFDM symbol length), depending on slot or non-slot selected in evaluation.
1.4	UE processing delay	$t_{UE,rx}$ The time interval between the PDSCH is received and the data is decoded;	$T_{proc,1}/2$ ($T_{proc,1}$ is defined in Section 5.3 of TS38.214), $d_{1,1}=0$; $d_{1,2}$ should be selected according to resource mapping type and UE capability. N_1 =the value with "No additional PDSCH DM-RS configured". (NOTE3)
2	HARQ retransmission	$T_{HARQ} = T_1 + T_2$ $T_2 = (t_{UE,tx} + t_{FA,UL}) + t_{UL_duration} + t_{BS,rx}$ (For Steps 2.1 to 2.4)	
2.1	UE processing delay	$t_{UE,tx}$ The time interval between the data is decoded, and ACK/NACK packet is generated.	$T_{proc,1}/2$ ($T_{proc,1}$ is defined in Section 5.3 of TS38.214), $d_{1,1}=0$; $d_{1,2}$ should be selected according to resource mapping type and UE capability. N_1 =the value with "No additional PDSCH DM-RS configured". (NOTE4)
2.2	UL frame alignment (transmission alignment)	$t_{FA,UL}$ It includes frame alignment time, and the waiting time for the next available UL slot	$T_{FA} + T_{wait}$, T_{FA} is the frame alignment time within the current UL slot; T_{wait} is the waiting time for next available UL slot if the current slot is not UL slot
2.3	TTI for ACK/NACK transmission	$t_{UL_duration}$	1 OFDM symbol
2.4	BS processing delay	$t_{BS,rx}$ The time interval between the ACK is received and the ACK is decoded.	$T_{proc,2}/2$ with $d_{2,1}= d_{2,2}= d_{2,3}=0$. (NOTE1, NOTE5)
2.5	Repeat DL data transfer from 1.1 to 1.4	T_1	
-	Total one way user plane latency for DL	$T_{UP} = T_1 + n \times T_{HARQ}$ where n is the number of re-transmissions ($n \geq 0$)	
<p>Note:</p> <ol style="list-style-type: none"> The value is used for evaluation only; gNB processing delay may vary depending on implementation. For the case of a TDD band (30 kHz SCS) with an SUL band (15 kHz SCS), the value of this step is $T_{proc,2}(\mu = 30\text{kHz}) / 2$ for Initial transmission, and $T_{proc,2}(\mu = 15\text{kHz}) / 2$ for re-transmission. For the above case, the UE is processing PDSCH reception on TDD band with 30kHz SCS, and it is assumed that the value of this step is $T_{proc,1}(\mu = 30\text{kHz})/2$. For the above case, the value of this step is $T_{proc,1}(\mu = 15\text{kHz}) - T_{proc,1}(\mu = 30\text{kHz})/2$. For the above case, the value of this step is $T_{proc,2}(\mu = 15\text{kHz})/2$. 			

Based on the DL user plane procedure and assumptions given in Table 5.7.1.1.1-1, a variety of configurations and UE capabilities are evaluated for NR.

For NR FDD, the evaluation results assuming an initial transmission error probability of $p=0$ and $p=0.1$ are provided in Table 5.7.1.1.1-2.

Table 5.7.1.1.1-2 DL user plane latency for NR FDD (ms)

DL user plane latency – NR FDD			UE capability 1				UE capability 2		
			SCS				SCS		
			15 kHz	30 kHz	60 kHz	120 kHz	15 kHz	30 kHz	60 kHz
Resource mapping Type A	M=4 (4OS non-slot)	p=0	1.37	0.76	0.54	0.34	1.00	0.55	0.36
		p=0.1	1.58	0.87	0.64	0.40	1.12	0.65	0.41
	M=7 (7OS non-slot)	p=0	1.49	0.82	0.57	0.36	1.12	0.61	0.39
		p=0.1	1.70	0.93	0.67	0.42	1.25	0.71	0.44
	M=14 (14OS slot)	p=0	2.13	1.14	0.72	0.44	1.80	0.94	0.56
		p=0.1	2.43	1.29	0.82	0.51	2.00	1.04	0.63
Resource mapping Type B	M=2 (2OS non-slot)	p=0	0.98	0.56	0.44	0.29	0.49	0.29	0.23
		p=0.1	1.16	0.67	0.52	0.35	0.60	0.35	0.28
	M=4 (4OS non-slot)	p=0	1.11	0.63	0.47	0.31	0.66	0.37	0.27
		p=0.1	1.30	0.74	0.56	0.36	0.78	0.45	0.32
	M=7 (7OS non-slot)	p=0	1.30	0.72	0.52	0.33	0.93	0.51	0.34
		p=0.1	1.49	0.83	0.61	0.39	1.08	0.59	0.40

For NR TDD, the various DL/UL configurations are evaluated. The evaluation results of DDDSU (with S slot = 11DL:1GP:2UL), DSUUD (with S slot = 11DL:1GP:2UL), and DUDU (without GP) are provided in Table 5.7.1.1.1-3, Table 5.7.1.1.1-4, and Table 5.7.1.1.1-5, respectively.

**Table 5.7.1.1.1-3 DL user plane latency for NR TDD (ms)
(Frame structure: DDDSU)**

DL user plane latency – NR TDD (DDDSU)			UE capability 1			UE capability 2		
			SCS			SCS		
			15 kHz	30 kHz	60 kHz	15 kHz	30 kHz	60 kHz
Resource mapping Type A	M=4 (4OS non-slot)	p=0	1.57	0.86	0.58	1.18	0.65	0.40
		p=0.1	1.95	1.05	0.70	1.56	0.84	0.50
	M=7 (7OS non-slot)	p=0	1.69	0.92	0.61	1.30	0.71	0.43
		p=0.1	2.07	1.11	0.73	1.67	0.90	0.53
	M=14 (14OS slot)	p=0	2.38	1.26	0.78	1.99	1.06	0.60
		p=0.1	2,78	1.46	0.93	2,37	1.25	0.70
Resource mapping Type B	M=2 (2OS non-slot)	p=0	1.16	0.65	0.48	0.66	0.39	0.27
		p=0.1	1.52	0.83	0.59	1.02	0.57	0.36
	M=4 (4OS non-slot)	p=0	1.28	0.71	0.51	0.82	0.47	0.31
		p=0.1	1.64	0.90	0.63	1.17	0.65	0.40
	M=7 (7OS non-slot)	p=0	1.49	0.82	0.56	1.10	0.61	0.38
		p=0.1	1.86	1.01	0.69	1.47	0.80	0.47

**Table 5.7.1.1.1-4 DL user plane latency for NR TDD (ms)
(Frame structure: DSUUD)**

DL user plane latency – NR TDD (DSUUD)			UE capability 1				UE capability 2		
			SCS				SCS		
			15 kHz	30 kHz	60 kHz	120 kHz	15 kHz	30 kHz	60 kHz
Resource mapping Type A	M=4 (4OS non-slot)	p=0	1.93	1.04	0.68	0.41	1.56	0.82	0.48
		p=0.1	2.37	1.26	0.78	0.48	1.99	1.04	0.59
	M=7 (7OS non-slot)	p=0	2.05	1.1	0.71	0.43	1.69	0.88	0.53
		p=0.1	2.49	1.32	0.83	0.5	2.13	1.1	0.64
	M=14 (14OS slot)	p=0	2.74	1.44	0.88	0.51	2.39	1.23	0.7
		p=0.1	3.19	1.66	1	0.58	2.83	1.45	0.81
Resource mapping Type B	M=2 (2OS non-slot)	p=0	1.47	0.81	0.56	0.35	1.01	0.54	0.36
		p=0.1	1.9	1.02	0.67	0.41	1.43	0.75	0.47
	M=4 (4OS non-slot)	p=0	1.59	0.87	0.59	0.37	1.16	0.62	0.4
		p=0.1	2.01	1.08	0.7	0.43	1.58	0.83	0.5
	M=7 (7OS non-slot)	p=0	1.83	0.99	0.65	0.4	1.47	0.77	0.48
		p=0.1	2.26	1.2	0.76	0.46	1.9	0.99	0.58

**Table 5.7.1.1.1-5 DL user plane latency for NR TDD (ms)
(Frame structure: DUDU)**

DL user plane latency – NR TDD (DU)			UE capability 1				UE capability 2		
			SCS				SCS		
			15 kHz	30 kHz	60 kHz	120 kHz	15 kHz	30 kHz	60 kHz
Resource mapping Type A	M=4 (4OS non-slot)	p=0	1.83	1.00	0.64	0.40	1.47	0.77	0.48
		p=0.1	2.04	1.11	0.73	0.48	1.66	0.87	0.52
	M=7 (7OS non-slot)	p=0	1.94	1.04	0.65	0.41	1.59	0.83	0.50
		p=0.1	2.16	1.16	0.75	0.49	1.79	0.93	0.55
	M=14 (14OS slot)	p=0	2.61	1.38	0.83	0.50	2.29	1.18	0.68
		p=0.1	2.96	1.55	0.96	0.58	2.49	1.29	0.78
Resource mapping Type B	M=2 (2OS non-slot)	p=0	1.27	0.71	0.51	0.33	0.76	0.42	0.30
		p=0.1	1.46	0.81	0.61	0.39	0.99	0.53	0.36
	M=4 (4OS non-slot)	p=0	1.46	0.80	0.56	0.35	0.98	0.54	0.36
		p=0.1	1.65	0.91	0.66	0.41	1.22	0.65	0.41
	M=7 (7OS non-slot)	p=0	1.71	0.93	0.63	0.38	1.32	0.71	0.44
		p=0.1	1.91	1.03	0.73	0.46	1.55	0.81	0.50

In addition, NR supports X slot that can be flexibly configured based on the traffic pattern. The evaluation of DDDXU is provided for this capability, where ‘X’ slot = ‘D’ slot for DL data transmission, and ‘X’=‘U’ for ACK/NACK feedback for DL user plane latency evaluation. The evaluation results are provided in Table 5.7.1.1.1-6.

**Table 5.7.1.1.1-6 DL user plane latency for NR TDD (ms)
(Frame structure: DDDXU, with ‘X’=‘D’ for DL traffic)**

DL user plane latency – NR TDD (DDDXU)			UE capability 1				UE capability 2		
			SCS				SCS		
			15 kHz	30 kHz	60 kHz	120 kHz	15 kHz	30 kHz	60 kHz
Resource mapping Type A	M=14 (14OS slot)	p=0	2.34	1.24	0.79	0.46	2.02	1.04	0.61
		p=0.1	2.74	1.44	0.92	0.54	2.40	1.23	0.71
Resource mapping Type B	M=2 (2OS non-slot)	p=0	1.09	0.62	0.48	0.31	0.66	0.36	0.27
		p=0.1	1.37	0.80	0.59	0.37	0.88	0.47	0.34
	M=4 (4OS non-slot)	p=0	1.25	0.69	0.52	0.33	0.85	0.45	0.32
		p=0.1	1.61	0.88	0.63	0.39	1.09	0.58	0.41
	M=7 (7OS non-slot)	p=0	1.46	0.80	0.57	0.35	1.17	0.61	0.40
		p=0.1	1.83	0.99	0.68	0.42	1.42	0.74	0.49

NR also supports the use of supplementary uplink (SUL) band together with a TDD band, where continuous uplink transmission opportunity becomes possible. The evaluation is applied to a TDD band with DDDSU (with S slot = 11DL:1GP:2UL) together with an SUL band. The evaluation results are provided in Table 5.7.1.1.1-7.

**Table 5.7.1.1.1-7 DL user plane latency for NR TDD + SUL (ms)
(Frame structure for TDD carrier: DDDSU)**

DL user plane latency – NR TDD (DDDSU) + SUL			UE capability 1			UE capability 2		
			SCS			SCS		
			15 kHz (TDD) + 15 kHz (SUL)	30 kHz (TDD) + 15 kHz (SUL)	30 kHz (TDD) + 30 kHz (SUL)	15 kHz (TDD) + 15 kHz (SUL)	30 kHz (TDD) + 15 kHz (SUL)	30 kHz (TDD) + 30 kHz (SUL)
Resource mapping Type A	M=4 (4OS non-slot)	p=0	1.57	0.86	0.86	1.18	0.65	0.65
		p=0.1	1.79	1.03	0.97	1.30	0.76	0.76
	M=7 (7OS non-slot)	p=0	1.69	0.92	0.92	1.30	0.71	0.71
		p=0.1	1.91	1.13	1.04	1.44	0.82	0.82
	M=14 (14OS slot)	p=0	2.38	1.26	1.26	1.99	1.06	1.06
		p=0.1	2.70	1.48	1.42	2.21	1.22	1.17
Resource mapping Type B	M=2 (2OS non-slot)	p=0	1.16	0.65	0.65	0.66	0.39	0.39
		p=0.1	1.35	0.83	0.76	0.76	0.48	0.45
	M=4 (4OS non-slot)	p=0	1.28	0.71	0.71	0.82	0.47	0.47
		p=0.1	1.49	0.89	0.83	0.93	0.57	0.54
	M=7 (7OS non-slot)	p=0	1.49	0.82	0.82	1.10	0.61	0.61
		p=0.1	1.71	0.99	0.94	1.23	0.72	0.69

It is observed that NR fulfils DL user plane latency requirement in a wide range of configurations.

5.7.1.1.2 Uplink

The uplink procedure using a grant free transmission is abstracted in Table 5.7.1.1.2-1, where the assumptions of each step for evaluation are given.

Table 5.7.1.1.2-1 UL user plane procedure for NR

Step	Component	Notations	Value
1	UL data transfer	$T_1 = (\hat{t}_{UE,tx} + \hat{t}_{FA,UL}) + \hat{t}_{UL_duration} + \hat{t}_{BS,rx}$	
1.1	UE processing delay	$\hat{t}_{UE,tx}$ The time interval between the data is arrived, and packet is generated;	$T_{proc,2}/2$ ($T_{proc,2}$ is defined in Section 6.4 of TS38.214), with $d_{2,1}=d_{2,2}=d_{2,3}=0$
1.2	UL Frame alignment (transmission alignment)	$\hat{t}_{FA,UL}$ It includes frame alignment time, and the waiting time for next available UL slot	$T_{FA} + T_{wait}$, T_{FA} is the frame alignment time within the current UL slot, T_{wait} is the waiting time for next available UL slot if the current slot is not UL slot.
1.3	TTI for UL data packet transmission	$\hat{t}_{UL_duration}$	Length of one slot (14 OFDM symbol length) or non-slot (2/4/7 OFDM symbol length), depending on slot or non-slot selected in evaluation.
1.4	BS processing delay	$\hat{t}_{BS,rx}$ The time interval between the PUSCH is received and the data is decoded;	$T_{proc,1}/2$ ($T_{proc,1}$ is defined in Section 5.3 of TS38.214), $d_{1,1}=0$; $d_{1,2}$ should be selected according to resource mapping type and UE capability. N_1 =the value with "No additional PDSCH DM-RS configured"; It is assumed that BS processing delay is equal to UE processing delay as for PDSCH (Note1)
2	HARQ retransmission	$T_{HARQ} = T_2 + T_1$ $T_2 = (\hat{t}_{BS,tx} + \hat{t}_{FA,DL}) + \hat{t}_{DL_duration} + \hat{t}_{UE,rx}$ (For Steps 2.1 to 2.4)	
2.1	BS processing delay	$\hat{t}_{BS,tx}$ The time interval between the data is decoded, and PDCCH preparation	$T_{proc,1}/2$ ($T_{proc,1}$ is defined in Section 5.3 of TS38.214), $d_{1,1}=0$; $d_{1,2}$ should be selected according to resource mapping type and UE capability. N_1 =the value with "No additional PDSCH DM-RS configured".
2.2	DL Frame alignment (transmission alignment)	$\hat{t}_{FA,DL}$ It includes frame alignment time, and the waiting time for next available DL slot	$T_{FA} + T_{wait}$, T_{FA} is the frame alignment time within the current DL slot; T_{wait} is the waiting time for next available DL slot if the current slot is not DL slot;
2.3	TTI for PDCCH transmission	$\hat{t}_{DL_duration}$	1 OFDM symbols for PDCCH scheduling the retransmission.
2.4	UE processing delay	$\hat{t}_{UE,rx}$ The time interval between the PDCCH is received and decoded.	$T_{proc,2}/2$ ($T_{proc,2}$ is defined in Section 6.4 of TS38.214), with $d_{2,1}=d_{2,2}=d_{2,3}=0$
2.5	Repeat UL data transfer from 1.1 to 1.4	T_1	
	Total one way user plane latency for UL	$T_{UP} = T_1 + n \times T_{HARQ}$ where n is the number of re-transmissions ($n \geq 0$)	

Note:

1. The value is used for evaluation only; gNB processing delay may vary depending on implementation.

Note:

2. The grant free transmission is assumed to use the following start symbols:

For 2-symbol PUSCH, the start symbol can be symbols {0,2,4,6,8,10,12} for PUSCH resource mapping type B

For 4-symbol PUSCH, the start symbol can be:

For PUSCH resource mapping type B: symbols {0,7}

For PUSCH resource mapping type A: symbol 0;

For 7-symbol PUSCH, the start symbol can be:

For PUSCH resource mapping type B: symbols {0, 7}

For PUSCH resource mapping type A: symbol 0;

For 14-symbol PUSCH, the start symbol can be at symbol #0 for PUSCH resource mapping type A and B.

Based on the UL user plane procedure and assumptions given in Table 5.7.1.1.2-1, a variety of configurations and UE capabilities are evaluated for NR.

For NR FDD, the evaluation results assuming an initial transmission error probability of $p=0$ and $p=0.1$ are provided in Table 5.7.1.1.2-2.

Table 5.7.1.1.2-2 UL user plane latency for NR FDD with grant free transmission (ms)

UL user plane latency (Grant free) – NR FDD			UE capability 1				UE capability 2		
			SCS				SCS		
			15 kHz	30 kHz	60 kHz	120 kHz	15 kHz	30 kHz	60 kHz
Resource mapping Type A	M=4 (4OS non-slot)	p=0	1.57	0.86	0.59	0.37	1.20	0.65	0.41
		p=0.1	1.78	1.01	0.69	0.43	1.39	0.75	0.47
	M=7 (7OS non-slot)	p=0	1.68	0.91	0.61	0.38	1.30	0.70	0.43
		p=0.1	1.89	1.06	0.71	0.44	1.50	0.80	0.49
	M=14 (14OS slot)	p=0	2.15	1.15	0.73	0.44	1.80	0.94	0.56
		p=0.1	2.45	1.30	0.84	0.51	2.00	1.06	0.63
Resource mapping Type B	M=2 (2OS non-slot)	p=0	0.96	0.55	0.44	0.28	0.52	0.30	0.24
		p=0.1	1.14	0.65	0.52	0.34	0.62	0.36	0.28
	M=4 (4OS non-slot)	p=0	1.31	0.72	0.52	0.33	0.79	0.43	0.30
		p=0.1	1.50	0.84	0.61	0.39	0.96	0.55	0.37
	M=7 (7OS non-slot)	p=0	1.40	0.77	0.55	0.34	1.02	0.55	0.36
		p=0.1	1.60	0.89	0.63	0.40	1.19	0.64	0.42
	M=14 (14OS slot)	p=0	2.14	1.14	0.74	0.44	1.81	0.93	0.56
		p=0.1	2.44	1.30	0.84	0.51	2.01	1.03	0.63

For NR TDD, the various DL/UL configurations are evaluated. The evaluation results of DDDSU (with S slot = 11DL:1GP:2UL), DSUUD (with S slot = 11DL:1GP:2UL), and DUDU (without GP) are provided in Table 5.7.1.1.1-3, Table 5.7.1.1.1-4, and Table 5.7.1.1.1-5, respectively.

Table 5.7.1.1.2-3 UL user plane latency for NR TDD with grant free transmission (ms) (Frame structure: DDDSU)

UL user plane latency – NR TDD (DDDSU)			UE capability 1			UE capability 2		
			SCS			SCS		
			15 kHz	30 kHz	60 kHz	15 kHz	30 kHz	60 kHz
Resource mapping Type A	M=4 (4OS non-slot)	p=0	3.57	1.86	1.08	3.18	1.65	0.90
		p=0.1	-	2.11	1.21	3.68	1.90	1.03
	M=7 (7OS non-slot)	p=0	3.68	1.91	1.11	3.29	1.71	0.93
		p=0.1	-	2.16	1.23	3.79	1.96	1.05
	M=14 (14OS slot)	p=0	-	2.16	1.23	3.79	1.96	1.05
		p=0.1	-	2.41	1.36	-	2.21	1.18
Resource mapping Type B	M=2 (2OS non-slot)	p=0	2.58	1.36	0.83	2.08	1.10	0.63
		p=0.1	3.07	1.60	0.95	2.57	1.35	0.75
	M=4 (4OS non-slot)	p=0	3.12	1.63	0.97	2.66	1.39	0.77
		p=0.1	3.62	1.88	1.09	3.15	1.64	0.90
	M=7 (7OS non-slot)	p=0	3.23	1.69	0.99	2.84	1.48	0.82
		p=0.1	3.72	1.93	1.12	3.33	1.73	0.94

Table 5.7.1.1.2-4 UL user plane latency for NR TDD with grant free transmission (ms) (Frame structure: DSUUD)

UL user plane latency – NR TDD (DSUUD)			UE capability 1				UE capability 2		
			SCS				SCS		
			15 kHz	30 kHz	60 kHz	120 kHz	15 kHz	30 kHz	60 kHz
Resource mapping Type A	M=4 (4OS non-slot)	p=0	2.74	1.39	0.85	0.5	2.38	1.22	0.70
		p=0.1	3.22	1.64	0.97	0.56	2.77	1.46	0.82
	M=7 (7OS non-slot)	p=0	2.84	1.49	0.91	0.53	2.49	1.28	0.73
		p=0.1	3.34	1.74	1.03	0.59	2.97	1.52	0.85
	M=14 (14OS slot)	p=0	3.34	1.74	1.03	0.59	2.99	1.53	0.85
		p=0.1	3.84	1.99	1.15	0.67	3.47	1.77	0.98
Resource mapping Type B	M=2 (2OS non-slot)	p=0	1.86	1	0.66	0.4	1.39	0.73	0.46
		p=0.1	2.31	1.23	0.78	0.46	1.85	0.96	0.57
	M=4 (4OS non-slot)	p=0	2.34	1.24	0.78	0.46	1.91	0.99	0.58
		p=0.1	2.81	1.47	0.9	0.52	2.38	1.22	0.7
	M=7 (7OS non-slot)	p=0	2.44	1.29	0.81	0.47	2.09	1.08	0.63
		p=0.1	2.91	1.53	0.92	0.54	2.56	1.31	0.75
	M=14 (14OS slot)	p=0	3.34	1.74	1.03	0.59	2.99	1.53	0.85
		p=0.1	3.82	1.98	1.15	0.67	3.47	1.77	0.97

**Table 5.7.1.1.2-5 UL user plane latency for NR TDD with grant free transmission (ms)
(Frame structure: DUDU)**

UL user plane latency – NR TDD (DU)			UE capability 1				UE capability 2		
			SCS				SCS		
			15 kHz	30 kHz	60 kHz	120 kHz	15 kHz	30 kHz	60 kHz
Resource mapping Type A	M=4 (4OS non-slot)	p=0	2.04	1.09	0.71	0.42	1.68	0.87	0.53
		p=0.1	2.24	1.28	0.80	0.49	1.87	0.97	0.57
	M=7 (7OS non-slot)	p=0	2.14	1.14	0.73	0.42	1.79	0.93	0.55
		p=0.1	2.36	1.34	0.83	0.50	1.99	1.03	0.60
	M=14 (14OS slot)	p=0	2.64	1.39	0.86	0.50	2.29	1.18	0.68
		p=0.1	3.04	1.60	1.01	0.58	2.49	1.28	0.78
Resource mapping Type B	M=2 (2OS non-slot)	p=0	1.29	0.71	0.52	0.33	0.80	0.44	0.31
		p=0.1	1.47	0.82	0.62	0.39	1.00	0.54	0.36
	M=4 (4OS non-slot)	p=0	1.66	0.90	0.61	0.38	1.12	0.59	0.39
		p=0.1	1.86	1.04	0.72	0.44	1.42	0.75	0.47
	M=7 (7OS non-slot)	p=0	1.77	0.96	0.64	0.39	1.39	0.73	0.46
		p=0.1	1.97	1.09	0.75	0.45	1.60	0.83	0.51
	M=14 (14OS slot)	p=0	2.64	1.39	0.86	0.50	2.29	1.18	0.68
		p=0.1	3.04	1.59	1.01	0.58	2.49	1.28	0.78

In addition, NR supports X slot that can be flexibly configured based on the traffic pattern. The evaluation of DDDXU is provided for this capability, where ‘X’ slot = ‘U’ slot for UL data transmission and ‘X’=‘D’ for PDCCH transmission for UL user plane latency evaluation. The evaluation results are provided in Table 5.7.1.1.2-6.

**Table 5.7.1.1.2-6 UL user plane latency for NR TDD with grant free transmission (ms)
(Frame structure: DDDXU, with ‘X’=‘U’ for UL traffic)**

UL user plane latency – NR TDD (DDDXU)			UE capability 1				UE capability 2		
			SCS				SCS		
			15 kHz	30 kHz	60 kHz	120 kHz	15 kHz	30 kHz	60 kHz
Resource mapping Type A	M=14 (14OS slot)	p=0	3.34	1.74	1.04	0.59	3.02	1.54	0.86
		p=0.1	3.82	1.98	1.16	0.67	3.50	1.78	0.98
Resource mapping Type B	M=2 (2OS non-slot)	p=0	1.80	0.97	0.66	0.40	1.48	0.77	0.48
		p=0.1	2.04	1.10	0.77	0.45	1.64	0.86	0.54
	M=7 (7OS non-slot)	p=0	2.44	1.29	0.82	0.48	2.12	1.09	0.64
		p=0.1	2.91	1.53	0.93	0.54	2.35	1.20	0.76

NR also supports the use of supplementary uplink (SUL) band together with a TDD band, where continuous uplink transmission opportunity becomes possible. The evaluation is applied to a TDD band with DDDSU (with S slot = 11DL:1GP:2UL) together with an SUL band. The evaluation results are provided in Table 5.7.1.1.2-7.

**Table 5.7.1.1.2-7 UL user plane latency for NR TDD + SUL with grant free transmission (ms)
(Frame structure for TDD carrier: DDDSU)**

UL user plane latency – NR TDD (DDDSU)+SUL			UE capability 1			UE capability 2		
			SCS			SCS		
			15 kHz (TDD) + 15 kHz (SUL)	30 kHz (TDD) + 15 kHz (SUL)	30 kHz (TDD) + 30 kHz (SUL)	15 kHz (TDD) + 15 kHz (SUL)	30 kHz (TDD) + 15 kHz (SUL)	30 kHz (TDD) + 30 kHz (SUL)
Resource mapping Type A	M=4 (4OS non-slot)	p=0	1.57	1.57	0.86	1.18	1.18	0.65
		p=0.1	1.79	1.79	1.01	1.40	1.38	0.76
	M=7 (7OS non-slot)	p=0	1.68	1.68	0.91	1.29	1.29	0.71
		p=0.1	1.90	1.90	1.06	1.51	1.49	0.82
	M=14 (14OS slot)	p=0	2.18	2.18	1.16	1.80	1.79	0.96
		p=0.1	2.50	2.48	1.32	2.01	2.01	1.12
Resource mapping Type B	M=2 (2OS non-slot)	p=0	1.04	1.04	0.59	0.54	0.54	0.33
		p=0.1	1.23	1.22	0.70	0.64	0.63	0.39
	M=4 (4OS non-slot)	p=0	1.32	1.32	0.73	0.86	0.86	0.49
		p=0.1	1.53	1.52	0.85	0.97	0.97	0.56
	M=7 (7OS non-slot)	p=0	1.43	1.43	0.79	1.04	1.04	0.58
		p=0.1	1.64	1.63	0.91	1.17	1.17	0.66

It is observed that NR fulfils UL user plane latency requirement in a wide range of configurations.

5.7.1.2 LTE

For the user plane latency of LTE, the similar procedure to NR is used. The detailed assumptions are given in Table 5.7.1.2.1-1 and Table 5.7.1.2.2-1 for DL and UL, respectively.

5.7.1.2.1 Downlink

The downlink procedure is abstracted in Table 5.7.1.2.1-1, where the assumptions of each step for evaluation are given.

Table 5.7.1.2.1-1 DL user plane procedure for LTE

ID	Component	Notations	Value
1	DL data transfer	$T_1 = (t_{BS,tx} + t_{FA,DL}) + t_{DL_duration} + t_{UE,rx}$	
1.1	BS processing delay	$t_{BS,tx}$ The time interval between the data is arrived, and packet is generated.	1.5 TTI
1.2	DL Frame alignment (transmission alignment)	$t_{FA,DL}$ It includes frame alignment time, and the waiting time for next available DL slot	$T_{FA} + T_{wait}$, T_{FA} is the frame alignment time within the current DL slot; T_{wait} is the waiting time for next available DL slot if the current slot is not DL slot.
1.3	TTI for DL data packet transmission	$t_{DL_duration}$	1 TTI
1.4	UE processing delay	$t_{UE,rx}$ The time interval between the PDSCH is received and the data is decoded;	1.5 TTI
2	HARQ retransmission	$T_{HARQ} = T_1 + T_2$ $T_2 = (t_{UE,tx} + t_{FA,UL}) + t_{UL_duration} + t_{BS,rx}$ (For Steps 2.1 to 2.4)	
2.1	UE processing delay	$t_{UE,tx}$ The time interval between the data is decoded, and ACK/NACK packet is generated.	1.5 TTI
2.2	UL frame alignment (transmission alignment)	$t_{FA,UL}$ It includes frame alignment time, and the waiting time for the next available UL slot	$T_{FA} + T_{wait}$, T_{FA} is the frame alignment time within the current UL slot; T_{wait} is the waiting time for next available UL slot if the current slot is not UL slot
2.3	TTI for ACK/NACK transmission	$t_{UL_duration}$	1 OFDM symbol
2.4	BS processing delay	$t_{BS,rx}$ The time interval between the ACK is received and the ACK is decoded.	1.5 TTI
2.5	Repeat DL data transfer from 1.1 to 1.4	T_1	
-	Total one way user plane latency for DL	$T_{UP} = T_1 + n \times T_{HARQ}$ where n is the number of re-transmissions ($n \geq 0$) Average $T_{UP} = T_1 + p \times T_{HARQ}$ where p is the probability of re-transmissions	
NOTE: For short TTI, it is assumed that PDCCH and sPDCCH can both schedule sPDSCH such that there is no additional waiting time for PDCCH if the data arrives within the PDCCH region. In addition, sPDCCH and sPDSCH can be frequency multiplexed.			

Based on the procedure and assumptions, the DL user plane latency of LTE is derived for both FDD and TDD as provided in Table 5.7.1.2.1-2, and Table 5.7.1.2.1-3, respectively. It is observed that LTE can meet the DL user plane latency requirement.

Table 5.7.1.2.1-2 DL user plane latency for LTE FDD

TTI duration	Error probability	DL UP latency (ms)
20S	$p=0$	0.63
	$p=0.1$	0.73
30S	$p=0$	0.94
	$p=0.1$	1.10
<i>Mixed</i> 20S/30S	$p=0$	0.75
	$p=0.1$	0.88
70S	$p=0$	2.20
	$p=0.1$	2.58

Table 5.7.1.2.1-3 DL user plane latency for LTE TDD

TTI duration	Criterion	Error probability	DL UP latency (ms)	
			DSUDD (Cfg.1)	DSUUD (Cfg.2)
70S	Average case	$p=0$	2.55	2.69
		$p=0.1$	3.10	3.14
	<i>Best case</i>	$p=0$	2.00	2.00
		$p=0.1$	2.40	2.40

5.7.1.2.2 Uplink

The uplink procedure using a semi-persistent scheduling uplink transmission is abstracted in Table 5.7.1.2.2-1, where the assumptions of each step for evaluation are given.

Table 5.7.1.2.2-1 UL user plane procedure for LTE

Step	Component	Notations	Value
1	UL data transfer	$T_1 = (\hat{t}_{UE,tx} + \hat{t}_{FA,UL}) + \hat{t}_{UL_duration} + \hat{t}_{BS,rx}$	
1.1	UE processing delay	$\hat{t}_{UE,tx}$ The time interval between the data is arrived, and packet is generated;	1.5 TTI
1.2	UL Frame alignment (transmission alignment)	$\hat{t}_{FA,UL}$ It includes frame alignment time, and the waiting time for next available UL slot	$T_{FA} + T_{wait}$, T_{FA} is the frame alignment time within the current UL slot. T_{wait} is the waiting time for next available UL slot if the current slot is not UL slot.
1.3	TTI for UL data packet transmission	$\hat{t}_{UL_duration}$	1 TTI
1.4	BS processing delay	$\hat{t}_{BS,rx}$ The time interval between the PUSCH is received and the data is decoded;	1.5 TTI
2	HARQ retransmission	$T_{HARQ} = T_2 + T_1$ $T_2 = (\hat{t}_{BS,tx} + \hat{t}_{FA,DL}) + \hat{t}_{DL_duration} + \hat{t}_{UE,rx}$ (For Steps 2.1 to 2.4)	
2.1	BS processing delay	$\hat{t}_{BS,tx}$ The time interval between the data is decoded, and PDCCH preparation	1.5 TTI
2.2	DL Frame alignment (transmission alignment)	$\hat{t}_{FA,DL}$ It includes frame alignment time, and the waiting time for next available DL slot	$T_{FA} + T_{wait}$, T_{FA} is the frame alignment time within the current DL slot; T_{wait} is the waiting time for next available DL slot if the current slot is not DL slot
2.3	TTI for PDCCH transmission	$\hat{t}_{DL_duration}$	1 OFDM symbols for PDCCH scheduling the retransmission.
2.4	UE processing delay	$\hat{t}_{UE,rx}$ The time interval between the PDCCH is received and the decoded.	1.5 TTI
2.5	Repeat UL data transfer from 1.1 to 1.4	T_1	
	Total one way user plane latency for UL	$T_{UP} = T_1 + n \times T_{HARQ}$ where n is the number of re-transmissions ($n \geq 0$) Average $T_{UP} = T_1 + p \times T_{HARQ}$ where p is the probability of re-transmissions	

Based on the procedure and assumptions, the UL user plane latency of LTE is derived for both FDD and TDD as provided in Table 5.7.1.2.2-2, and Table 5.7.1.2.2-3, respectively.

Table 5.7.1.2.2-2 UL user plane latency for LTE FDD

TTI duration	Error probability	UL UP latency (ms)
20S	$p=0$	0.63
	$p=0.1$	0.73
30S	$p=0$	0.94
	$p=0.1$	1.10
Mixed 20S/30S	$p=0$	0.75
	$p=0.1$	0.88
70S	$p=0$	2.20
	$p=0.1$	2.58

Table 5.7.1.2.2-3 UL user plane latency for LTE TDD with semi-persistent scheduling (SPS)

TTI duration	Criterion	Error probability	UL UP latency (ms)	
			DSUDD (Cfg.1)	DSUUD (Cfg.2)
70S	Average case	$p=0$	-	3.26
		$p=0.1$	-	3.73
	Best case	$p=0$	2.00	2.00
		$p=0.1$	2.45	2.40

It is observed that LTE can meet the UL user plane latency requirement.

5.7.2 Control plane latency

As defined in Report ITU-R M.2410 [4], control plane latency refers to the transition time from a most “battery efficient” state (e.g. Idle state) to the start of continuous data transfer (e.g. Active state).

5.7.2.1 NR

For NR Rel-15, control plane latency is evaluated from RRC_INACTIVE state to RRC_CONNECTED state. Figure 5.7.2.1-1 provides an example control plane flow for NR Rel-15.

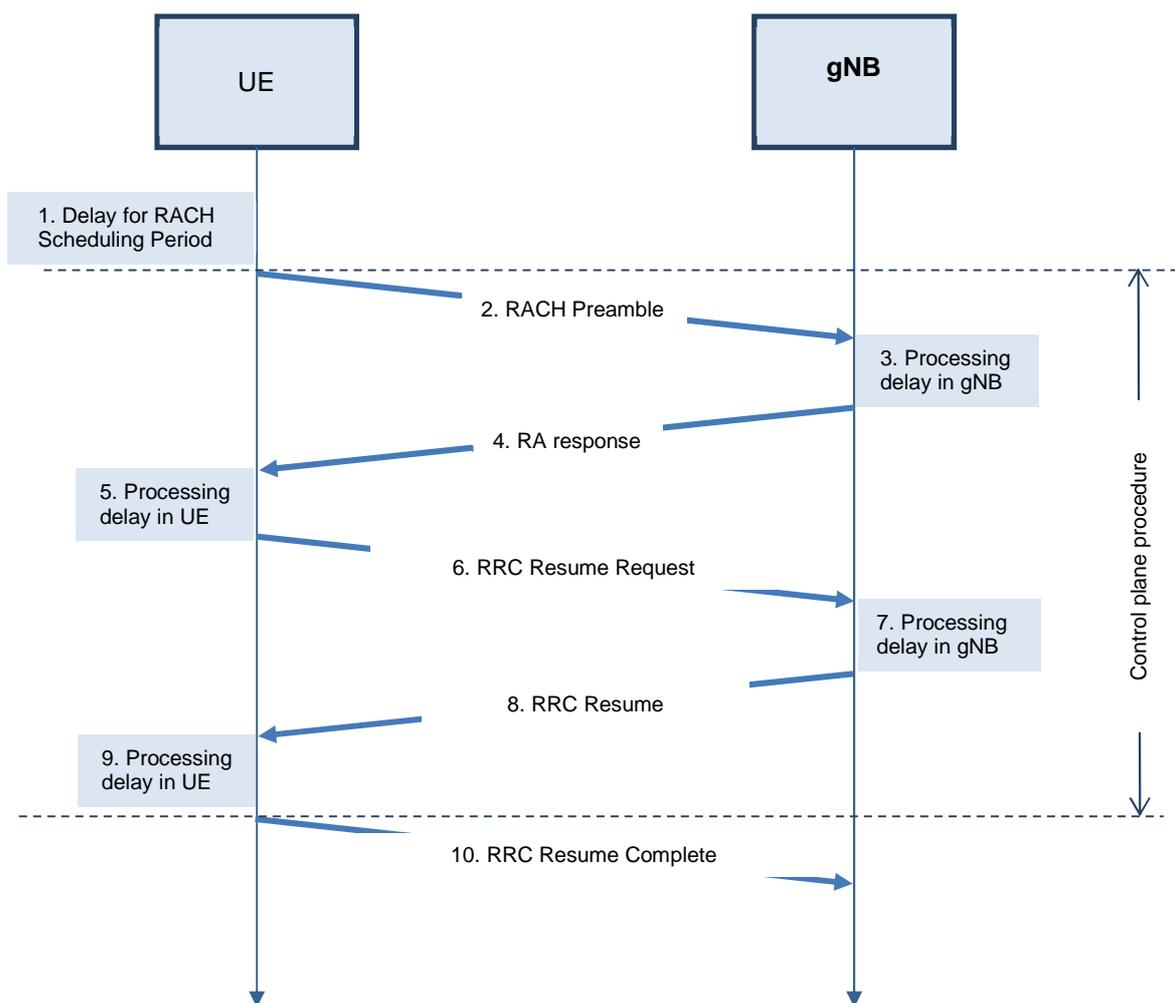

Figure 5.7.2.1-1 C-plane procedure (example for NR Rel-15)

The detailed assumption of each step as shown in Figure 5.7.2.1-1 is provided in Table 5.7.2.1-1. The evaluation is for UL data transfer. It is understood that the evaluation results for DL data transfer can be further reduced because UE processing delay in Step 9 for DL data transfer does not need to handle UL grant receiving, and therefore can be reduced compared to the case of UL data transfer.

NOTE: The delay values shown below do not include the waiting time for DL/UL subframe. It is only gNB or UE processing delay. The waiting time will be calculated and it depends on the detailed DL/UL configuration.

Table 5.7.2.1-1 Assumption of C-plane procedure for NR

Step	Description	CP Latency for UL data transfer [ms]
1	Delay due to RACH scheduling period (1TTI)	0
2	Transmission of RACH Preamble	Length of the preamble according to the PRACH format as specified in [6 38.211]
3	Preamble detection and processing in gNB	$T_{proc,2}$ (assuming $d_{2,1}=0$)
4	Transmission of RA response	T_s (the length of 1 slot / non-slot) NOTE: the length of 1 slot or 1 non-slot include PDCCH and PDSCH (the first OFDM symbol of PDSCH is frequency multiplexed with PDCCH).
5	UE Processing Delay (decoding of scheduling grant, timing alignment and C-RNTI assignment + L1 encoding of RRC Resume Request)	$N_{T,1}+N_{T,2}+0.5$ ms
6	Transmission of RRC Resume Request	T_s (the length of 1 slot / non-slot) NOTE: the length of 1 slot or 1 non-slot is equal to PUSCH allocation length.
7	Processing delay in gNB (L2 and RRC)	3
8	Transmission of RRC Resume	T_s (the length of 1 slot / non-slot)
9	Processing delay in UE of RRC Resume including grant reception	7
10	Transmission of RRC Resume Complete and UP data	0
<p>Notes:</p> <ol style="list-style-type: none"> For step 1, the procedure for <i>transition from a most "battery efficient" state</i> has yet not begun, hence this step is not relevant for the latency of the procedure which is illustrated by a '0' in the above. For step 3, the value of $T_{proc,2}$ is used only for evaluation. gNB processing delay may vary depending on implementation. For step 5, the latency of $N_{T,1}+N_{T,2}+0.5$ms is used according to Section 8.3 of TS 38.213. $N_{T,1}$ is a time duration of N_1 symbols corresponding to a PDSCH reception time for PDSCH processing capability 1 when additional PDSCH DM-RS is configured; and $N_{T,2}$ is a time duration of N_2 symbols corresponding to a PUSCH preparation time for PUSCH processing capability 1. The value of N_1 and N_2 are shown in Table 5.3-1 and Table 6.4-1 of TS38.214, respectively.. For step 7, the processing delay in gNB (L2 and RRC) has been reduced to 3 ms. The delays due to inside-gNB or inter-gNB communication are not included in Step 7. Such delays may exist depending on deployment, but are not within the scope of this evaluation. For step 9 for UL data transfer, the processing delay in the UE (L2 and RRC) is considered, i.e., from reception of RRC Connection Resume to the reception of UL grant. The transmission of UL grant by gNB and processing delay in the UE (processing of UL grant and preparing for UL tx) are also considered. The RRCConnectionResume message only includes MAC and PHY configuration. No DRX, SPS, CA, or MIMO re-configuration will be triggered by this message. Further, the UL grant for transmission of RRC Connection Resume Complete and the data is transmitted over common search space with DCI format 0. For step 10, the beginning of this subframe is considered to be "<i>the start of continuous data transfer</i>", hence this step is not relevant for the latency of the procedure which is illustrated by a '0' in the above. For the case of a TDD band (30 kHz SCS) with an SUL band (15 kHz SCS), the sub-carrier spacing of 15 kHz that results in larger delay is used in evaluating the latency for Step 3 and 5. 		

In addition, the following assumptions apply to the evaluation:

- The transmission duration of Step 2, 4, 6, and 8 cannot be crossing the boundary of a slot;
- The CP procedure can start from the OFDM symbols within the slot that PRACH preamble can be transmitted (assuming that the slot is UL slot; otherwise it will wait for the available UL slot).

Based on the control plane procedure and assumptions given in Table 5.7.2.1-1, a variety of configurations and UE capabilities are evaluated for NR for UL data transfer. For a specific configuration, the results are the average over the possible start timing of the control plane procedure.

For NR FDD, the evaluation results of different PRACH lengths are provided in Table 5.7.2.1-2. The evaluation is applied to various non-slot length and sub-carrier spacings. Resource mapping type A and B are considered. UE capability 1 and UE capability 2 are evaluated.

Table 5.7.2.1-2 Control plane latency for NR FDD (ms)

(a) PRACH length = 2 OFDM symbols

Resource mapping type	Non-slot duration	UE capability 1				UE capability 2		
		15kHz SCS	30kHz SCS	60kHz SCS	120kHz SCS	15kHz SCS	30kHz SCS	60kHz SCS
Type A	M=4 (4OS non-slot)	15.4	13.1	12.3	11.7	15.0	12.8	12.1
	M=7 (7OS non-slot)	15.6	13.4	12.4	11.7	15.2	13.2	12.2
Type B	M=2 (2OS non-slot)	13.3	12.0	11.8	11.3	13.0	11.9	11.6
	M=4 (4OS non-slot)	13.8	12.3	12.0	11.5	13.4	12.1	11.7
	M=7 (7OS non-slot)	14.7	12.8	12.2	11.6	14.3	12.6	12.0

(b) PRACH length = 6 OFDM symbols

Resource mapping type	Non-slot duration	UE capability 1				UE capability 2		
		15kHz SCS	30kHz SCS	60kHz SCS	120kHz SCS	15kHz SCS	30kHz SCS	60kHz SCS
Type A	M=4 (4OS non-slot)	15.6	13.5	12.4	11.7	15.1	13.0	12.1
	M=7 (7OS non-slot)	15.8	13.6	12.5	11.7	15.3	13.1	12.2
Type B	M=2 (2OS non-slot)	13.7	12.3	11.9	11.4	13.4	12.0	11.7
	M=4 (4OS non-slot)	14.2	12.5	12.0	11.5	13.9	12.3	11.8
	M=7 (7OS non-slot)	15.3	13.0	12.3	11.6	14.8	12.8	12.1

(c) PRACH length=1ms

Resource mapping type	Non-slot duration	UE capability 1		UE capability 2	
		15kHz SCS	30kHz SCS	15kHz SCS	30kHz SCS
Type A	M=4 (4OS non-slot)	16.3	13.6	16.3	13.6
	M=7 (7OS non-slot)	16.5	14.3	16.5	14.3
	M=14 (14OS slot)	17.0	14.5	17.0	14.5
Type B	M=2 (2OS non-slot)	14.1	12.9	13.8	12.7
	M=4 (4OS non-slot)	14.7	13.3	14.3	12.9
	M=7 (7OS non-slot)	15.8	13.8	15.0	13.3

For NR TDD, various DL/UL configurations are evaluated. The evaluation results of DDDSU (with S slot = 11DL: 1GP:2UL), DSUUD (with S slot = 11DL: 1GP:2UL), and DUDU (without GP) are provided. The evaluation is applied to various non-slot length and sub-carrier spacings. Resource mapping type A and B are considered. UE capability 1 and UE capability 2 are evaluated.

Table 5.7.2.1-3 provides the evaluation results for the frame structure of DDDSU for different PRACH length.

**Table 5.7.2.1-3 Control plane latency for NR TDD (ms)
(Frame structure: DDDSU, S slot = 11DL:1GP:2UL)**

(a) PRACH length = 2 OFDM symbols

Resource mapping type	Non-slot duration	UE capability 1		UE capability 2	
		15kHz SCS	30kHz SCS	15kHz SCS	30kHz SCS
Type A	$M=4$ (4OS non-slot)	17.9	14.0	17.9	14.0
	$M=7$ (7OS non-slot)	18.1	14.4	18.1	14.2
Type B	$M=2$ (2OS non-slot)	16.8	13.4	16.8	13.4
	$M=4$ (4OS non-slot)	17.2	13.6	17.2	13.6
	$M=7$ (7OS non-slot)	17.6	13.8	17.6	13.8

(b) PRACH length=1ms

Resource mapping type	Non-slot duration	UE capability 1	UE capability 2
		15kHz SCS	15kHz SCS
Type A	$M=4$ (4OS non-slot)	18.3	18.3
	$M=7$ (7OS non-slot)	18.5	18.5
Type B	$M=2$ (2OS non-slot)	17.1	17.1
	$M=4$ (4OS non-slot)	17.6	17.6
	$M=7$ (7OS non-slot)	18.0	18.0

In Table 5.7.2.1-4, the evaluation results of DSUUD with different PRACH length are provided.

**Table 5.7.2.1-4 Control plane latency for NR TDD (ms)
(Frame structure: DSUUD, S slot = 11DL:1GP:2UL)**

(a) PRACH length = 2 OFDM symbols

Resource mapping type	Non-slot duration	UE capability 1				UE capability 2		
		15kHz SCS	30kHz SCS	60kHz SCS	120kHz SCS	15kHz SCS	30kHz SCS	60kHz SCS
Type A	$M=4$ (4OS non-slot)	16.2	13.9	12.6	12.2	15.6	13.4	12.6
	$M=7$ (7OS non-slot)	16.4	14.0	12.7	12.2	15.8	13.5	12.7
Type B	$M=2$ (2OS non-slot)	14.3	12.6	12.3	11.5	14.3	12.6	12.3
	$M=4$ (4OS non-slot)	15.1	12.7	12.4	11.8	15.1	12.7	12.4
	$M=7$ (7OS non-slot)	16.3	13.0	12.5	12.2	15.5	12.9	12.5

(b) PRACH length = 6 OFDM symbols

Resource mapping type	Non-slot duration	UE capability 1				UE capability 2		
		15kHz SCS	30kHz SCS	60kHz SCS	120kHz SCS	15kHz SCS	30kHz SCS	60kHz SCS
Type A	$M=4$ (4OS non-slot)	16.3	14.3	12.6	12.2	15.6	13.3	12.6
	$M=7$ (7OS non-slot)	16.5	14.4	12.7	12.2	15.8	13.4	12.7
Type B	$M=2$ (2OS non-slot)	14.4	12.7	12.4	11.5	14.4	12.7	12.4
	$M=4$ (4OS non-slot)	14.9	12.8	12.5	11.8	14.9	12.8	12.5
	$M=7$ (7OS non-slot)	17.4	13.1	12.6	12.2	16.5	13.0	12.6

(c) PRACH length=1ms

Resource mapping type	Non-slot duration	UE capability 1	UE capability 2
		15kHz SCS	15kHz SCS
Type A	$M=4$ (4OS non-slot)	17.3	17.3
	$M=7$ (7OS non-slot)	17.5	17.5
Type B	$M=2$ (2OS non-slot)	14.7	14.6
	$M=4$ (4OS non-slot)	15.1	15.1
	$M=7$ (7OS non-slot)	17.3	15.5

Table 5.7.2.1-5 provides the evaluation results for the frame structure of DUDU for different PRACH length.

**Table 5.7.2.1-5 Control plane latency for NR TDD (ms)
(Frame structure: DUDU, without GP)**

(a) PRACH length = 2 OFDM symbols

Resource mapping type	Non-slot duration	UE capability 1				UE capability 2		
		15kHz SCS	30kHz SCS	60kHz SCS	120kHz SCS	15kHz SCS	30kHz SCS	60kHz SCS
Type A	$M=4$ (4OS non-slot)	17.0	14.1	12.7	11.7	16.1	13.6	12.5
	$M=7$ (7OS non-slot)	17.2	14.3	12.8	11.7	16.4	13.7	12.6
Type B	$M=2$ (2OS non-slot)	13.9	12.3	12.2	11.6	13.9	12.4	11.8
	$M=4$ (4OS non-slot)	14.2	12.6	12.2	11.6	14.1	12.4	11.9
	$M=7$ (7OS non-slot)	15.2	13.3	12.8	11.7	14.6	12.8	12.4

(b) PRACH length = 6 OFDM symbols

Resource mapping type	Non-slot duration	UE capability 1				UE capability 2		
		15kHz SCS	30kHz SCS	60kHz SCS	120kHz SCS	15kHz SCS	30kHz SCS	60kHz SCS
Type A	$M=4$ (4OS non-slot)	17.1	14.5	12.8	11.8	16.1	13.6	12.5
	$M=7$ (7OS non-slot)	17.3	14.6	12.8	11.8	16.3	13.6	12.6
Type B	$M=2$ (2OS non-slot)	14.1	12.5	12.2	11.6	14.1	12.5	11.7
	$M=4$ (4OS non-slot)	14.4	13.0	12.3	11.6	14.4	12.5	12.0
	$M=7$ (7OS non-slot)	15.8	13.6	12.8	11.7	14.8	13.1	12.6

(c) PRACH length=1ms

Resource mapping type	Non-slot duration	UE capability 1	UE capability 2
		15kHz SCS	15kHz SCS
Type A	M=4 (4OS non-slot)	18.3	18.3
	M=7 (7OS non-slot)	18.5	18.5
Type B	M=2 (2OS non-slot)	14.3	14.3
	M=4 (4OS non-slot)	14.7	14.6
	M=7 (7OS non-slot)	17.0	15.0

NR also supports the use of supplementary uplink (SUL) band together with a TDD band, where continuous uplink transmission opportunity becomes possible. The evaluation is applied to a TDD band with DDDSU (with S slot = 11DL:1GP:2UL) together with an SUL band. The evaluation results are provided in Table 5.7.2.1-6.

**Table 5.7.2.1-6 Control plane latency for NR TDD+SUL (ms)
(Frame structure for TDD carrier: DDDSU, S slot = 11DL:1GP:2UL)**

(a) PRACH length=2 OFDM symbols

Resource mapping type	Non-slot duration	UE capability1			UE capability2		
		15 kHz (TDD)+ 15 kHz (SUL)	30 kHz (TDD) + 15 kHz (SUL)	30 kHz (TDD) + 30 kHz (SUL)	15 kHz (TDD)+ 15 kHz (SUL)	30 kHz (TDD) + 15 kHz (SUL)	30 kHz (TDD) + 30 kHz (SUL)
Type A	M=4 (4OS non-slot)	15.9	13.9	13.1	15.0	13.6	12.8
	M=7 (7OS non-slot)	16.1	14.2	13.4	15.2	13.7	13.2
Type B	M=2 (2OS non-slot)	13.3	12.9	12.1	13.0	12.6	11.9
	M=4 (4OS non-slot)	13.8	13.5	12.3	13.4	12.9	12.1
	M=7 (7OS non-slot)	14.7	14.1	12.8	14.4	13.6	12.6

(b) PRACH length=1ms

Resource mapping type	Non-slot duration	UE capability1			UE capability2		
		15 kHz (TDD)+ 15 kHz (SUL)	30 kHz (TDD) + 15 kHz (SUL)	30 kHz (TDD) + 30 kHz (SUL)	15 kHz (TDD)+ 15 kHz (SUL)	30 kHz (TDD) + 15 kHz (SUL)	30 kHz (TDD) + 30 kHz (SUL)
Type A	M=4 (4OS non-slot)	17.3	15.6	13.6	17.3	14.6	13.6
	M=7 (7OS non-slot)	17.5	15.7	14.8	17.5	14.7	14.8
	M=14 (14OS slot)	18.8	17.2	15.6	18.8	17.0	15.6
Type B	M=2 (2OS non-slot)	14.1	13.8	12.9	13.8	13.4	12.8
	M=4 (4OS non-slot)	14.7	14.6	13.3	14.3	13.7	12.9
	M=7 (7OS non-slot)	15.8	15.2	13.8	15.0	14.7	13.3

It is observed that NR fulfils the control plane latency requirement of 20ms in a wide range of configurations. If, in control plane procedure, the latency of step 7 and step 9 can be further reduced, the 10ms target as encouraged by ITU-R can be achieved in some cases.

5.7.2.2 LTE

For LTE Rel-15, control plane latency is evaluated from IDLE state to CONNECTED state. It is noted that, for LTE, when RRC connection is suspended, RRC connection resume is permitted by E-UTRAN. Figure 5.7.2.2-1 provides an example control plane flow for the above-mentioned IDLE to CONNECTED state transition for LTE Rel-15.

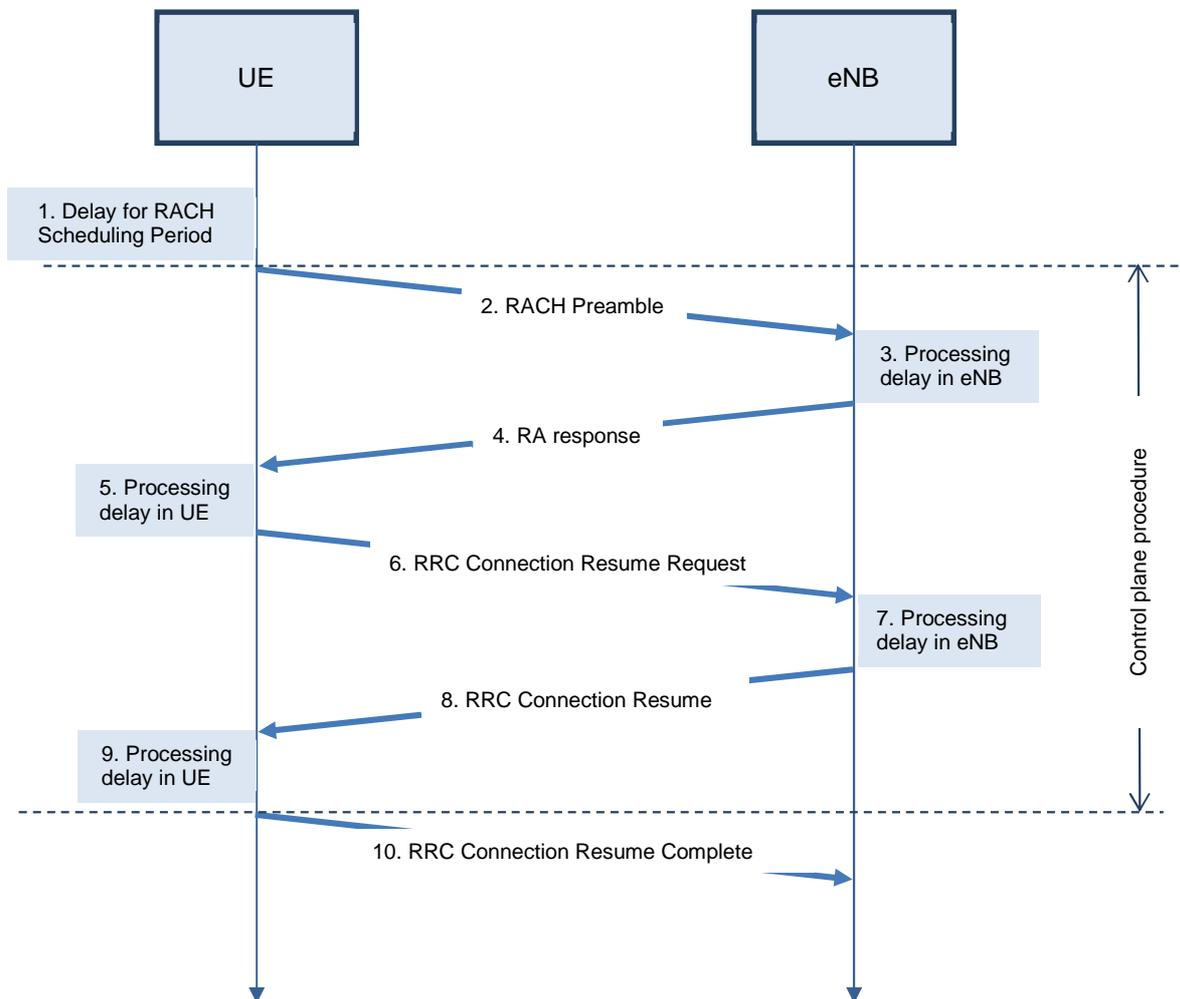

Figure 5.7.2.2-1 C-plane activation procedure (example for Rel-15)

It is noted that for Step 9, the processing delay in UE might be different for the start of DL and UL continuous data transfer. Therefore the evaluation of control plane latency is conducted for DL and UL, respectively.

The evaluation results of LTE FDD on control plane latency are provided in Table 5.7.2.2-1.

Table 5.7.2.2-1 Control plane latency of LTE FDD

Step	Description	CP Latency for UL data transfer [ms]
1	Delay due to RACH scheduling period (1TTI)	0
2	Transmission of RACH Preamble	1
3	Preamble detection and processing in eNB	2
4	Transmission of RA response	1
5	UE Processing Delay (decoding of scheduling grant, timing alignment and C-RNTI assignment + L1 encoding of RRC Connection Resume Request)	4
6	Transmission of RRC Connection Resume Request	1
7	Processing delay in eNB (L2 and RRC)	3
8	Transmission of RRC Connection Resume	1
9	Processing delay in UE of RRC Connection Resume including grant reception	7
10	Transmission of RRC Connection Resume Complete and UP data	0
Total delay [ms]		20
Notes:		
1.	For step 1, the procedure for <i>transition from a most "battery efficient" state</i> has yet not begun, hence this step is not relevant for the latency of the procedure which is illustrated by a '0' in the above.	
2.	For step 5, the latency of 4 ms has been agreed by RAN1, see LS in R2-1806411.	
3.	For step 7, the processing delay in eNB (L2 and RRC) has been reduced to 3 ms.	
4.	For step 9 for UL data transfer, the processing delay in the UE (L2 and RRC) is considered, i.e., from reception of RRC Connection Resume to the reception of UL grant. The transmission of UL grant by eNB and processing delay in the UE (processing of UL grant and preparing for UL tx) are also considered. The RRCConnectionResume message only includes MAC and PHY configuration. No DRX, SPS, CA, or MIMO re-configuration will be triggered by this message. Further, the UL grant for transmission of RRC Connection Resume Complete and the data is transmitted over common search space with DCI format 0.	
5.	For step 9 for DL data transfer, only the processing delay in the UE (L2 and RRC) is considered, i.e., from reception of RRC Connection Resume to the reception of DL grant. The RRCConnectionResume message only includes MAC and PHY configuration. No DRX, SPS, CA, or MIMO re-configuration will be triggered by this message. Further, the UL grant for transmission of RRC Connection Resume Complete and the data is transmitted over common search space with DCI format 0.	
6.	For step 10, the beginning of this subframe is considered to be " <i>the start of continuous data transfer</i> ", hence this step is not relevant for the latency of the procedure which is illustrated by a '0' in the above.	

For LTE TDD, the achieved latency will depend on when the procedure is initiated due to the TDD-pattern (i.e. in some cases the eNB and UE must wait for a subframe where DL and UL can be transmitted).

For DL data transfer, the evaluation results of LTE TDD are provided in Table 5.7.2.2-2.

Table 5.7.2.2-2 Control plane latency of LTE TDD for DL data transfer

Step	Average CP Latency for DL data transfer [ms]						
	Config 0	Config 1	Config 2	Config 3	Config 4	Config 5	Config 6
1	0	0	0	0	0	0	0
2	1	1	1	1	1	1	1
3	3	2	2	2.7	2	2	2.5
4	1	1	1	1	1	1	1
5	4.8	5.4	5.8	4.8	5.7	5.9	4.5
6	1	1	1	1	1	1	1
7	3	3	3	3	3	3	3.3
8	1	1	1	1	1	1	1
9	4	3	3	3	3	3	3.8
10	0	0	0	0	0	0	0
Total delay [ms]	18.8	17.4	17.8	17.5	17.7	17.9	18.1

Notes:

1. The description of each component is the same as in Table 5.7.2.2-1. TDD frame structure configuration 0–6 are defined in TS36.211.
2. For step 1, the procedure for transition from a most “battery efficient” state has yet not begun, hence this step is not relevant for the latency of the procedure which is illustrated by a '0' in the above.
3. For step 3, the eNB processing delay is 2ms as in FDD. Additional delay due to waiting for DL subframe is included. The delay value is the average delay taken over the starting subframes when the procedure is initiated under the corresponding TDD configuration.
4. For step 5, the UE processing delay is 4 ms as in FDD, see LS in R2-1806411. Additional delay due to waiting for UL subframe is included. The delay value is the average delay taken over the starting subframes when the procedure is initiated under the corresponding TDD configuration.
5. For step 7, the eNB processing delay (L2 and RRC) has been reduced to 3 ms as in FDD. Additional delay due to waiting for DL subframe is included. The delay value is the average delay taken over the starting subframes when the procedure is initiated under the corresponding TDD configuration.
6. For step 9 for DL data transfer, only the processing delay in the UE (L2 and RRC) is considered as in FDD. Additional delay due to waiting for DL subframe for receiving DL grant is included. The delay value is the average delay taken over the starting subframes when the procedure is initiated under the corresponding TDD configuration.
7. For step 10, the beginning of this subframe is considered to be "*the start of continuous data transfer*", hence this step is not relevant for the latency of the procedure which is illustrated by a '0' in the above.

For UL data transfer, the evaluation results of LTE TDD are provided in Table 5.7.2.2-3 for specific starting subframes for TDD frame structure configurations.

Table 5.7.2.2-3 Control plane latency of LTE TDD for UL data transfer

Step	Description	CP Latency for UL data transfer [ms] for the following cases
		Config 0, Starting Subframe = 2,7 Config 1, Starting Subframe = 2,7 Config 3, Starting Subframe = 1, 2 Config 4, Starting Subframe = 2 Config 6, Starting Subframe = 2,7
1	Delay due to RACH scheduling period (1TTI)	0
2	Transmission of RACH Preamble	1
3	Preamble detection and processing in eNB	2
4	Transmission of RA response	1
5	UE Processing Delay (decoding of scheduling grant, timing alignment and C-RNTI assignment + L1 encoding of RRC Connection Resume Request)	4
6	Transmission of RRC Connection Resume Request	1
7	Processing delay in eNB (L2 and RRC)	3
8	Transmission of RRC Connection Resume	1
9	Processing delay in UE of RRC Connection Resume including grant reception	7
10	Transmission of RRC Connection Resume Complete and UP data	0
	Total delay [ms]	20

Notes:

1. TDD frame structure configuration 0~6 are defined in TS36.211. The delay value is for the given starting subframes under the corresponding TDD configuration.
2. For step 1, the procedure for transition from a most "battery efficient" state has yet not begun, hence this step is not relevant for the latency of the procedure which is illustrated by a '0' in the above.
3. For step 3, the eNB processing delay is 2ms as in FDD. Additional delay due to waiting for DL subframe is 0 for the given starting subframes under the corresponding TDD configuration.
4. For step 5, the UE processing delay is 4 ms as in FDD, see LS in R2-1806411. Additional delay due to waiting for UL subframe is 0 for the given starting subframes under the corresponding TDD configuration.
5. For step 7, the eNB processing delay (L2 and RRC) has been reduced to 3 ms as in FDD. Additional delay due to waiting for DL subframe is 0 for the given starting subframes under the corresponding TDD configuration.
6. For step 9 for UL data transfer, the processing delay is considered as in FDD. Additional delay due to waiting for DL subframe for receiving UL grant is 0 for the given starting subframes under the corresponding TDD configuration.
7. For step 10, the beginning of this subframe is considered to be "*the start of continuous data transfer*", hence this step is not relevant for the latency of the procedure which is illustrated by a '0' in the above.

Based on the above analysis, 20ms control plane latency is fulfilled by LTE Rel-15 FDD, and for TDD for the above cases.

5.8 Energy efficiency

As defined in Report ITU-R M.2410 [4], network energy efficiency is the capability of a RIT/SRIT to minimize the radio access network energy consumption in relation to the traffic capacity provided. Device energy efficiency is the capability of the RIT/SRIT to minimize the power consumed by the device modem in relation to the traffic characteristics.

The RIT/SRIT shall have the capability to support a high sleep ratio and long sleep duration.

The sleep ratio is the fraction of unoccupied time resources (for the network) or sleeping time (for the device) in a period of time corresponding to the cycle of the control signaling (for the network) or the cycle of discontinuous reception (for the device) when no user data transfer takes place. The sleep duration is the continuous period of time with no transmission (for network and device) and reception (for the device).

5.8.1 Network side

5.8.1.1 NR

The sleep ratio and sleep duration for NR network under unloaded case are evaluated.

When no data transfer takes place, NR network will keep periodical transmission of SS/PBCH blocks and RMSI (remaining minimum system information), as well as paging signal in order for UEs to detect and access the radio network. The following mechanisms for SS/PBCH block, RMSI and paging are assumed for the evaluation.

For SS/PBCH block transmission, the following configurations are considered in evaluation.

- One SS/PBCH block occupies 4 OFDM symbols with 20 RBs in one slot.
- One or multiple SS/PBCH block(s) compose an "SS burst set" (SSB set).
 - Denote L as the number of SS/PBCH blocks in an SSB set, where L can be 1~ 64. For below 3 GHz, the maximum value of L is 4; for below 7.125 GHz, the maximum value of L is 8.
- One SSB set transmission is confined to a half radio frame (5 ms) window
- The SSB set periodicity (P_{SSB}) can be configured to be {5, 10, 20, 40, 80, 160} ms
- The following mapping is used in a half radio frame for 15, 30, 120 and 240kHz SCS
 - 2 SS/PBCH blocks is transmitted in one slot. And the L SS/PBCH blocks in an SSB set is transmitted in successive slots from the first slot in one SSB set period.

For RMSI transmission, the following configurations are considered in evaluation.

- One RMSI transmission occupies 2 OFDM symbols in one slot.
- RMSI is multiplexed with SS/PBCH block using the following ways:
 - For FR1, RMSI is time division multiplexed (TDMed) with SS/PBCH block.
 - For FR2, RMSI can be frequency division multiplexed (FDMed) with SS/PBCH block.
 - SS/PBCH block and RMSI could be transmitted in the same slot for both TDM and FDM.
- RMSI periodicity (P_{RMSI}) is assumed as follows:
 - 20ms for SSB set periodicity less than or equal to 20ms;
 - Otherwise RMSI periodicity equals to SSB set periodicity.
- The following mapping is used
 - One RMSI transmission corresponds to one SS/PBCH block
 - If L SS/PBCH block is transmitted, then L RMSI transmissions are required.
 - One slot accommodates 2 RMSI transmissions.
 - The offset of RMSI transmission can be set as {0, 2, 5, 7}ms with respect to every 20ms time point. In the evaluation, the offset value that allows the closest RMSI transmission to SS/PBCH block transmission is selected.

For paging occasion,

- The periodicity of paging occasion is the same as that of SSB set, and it is FDMed with an SS block.

Figure 5.8.1.1-1 illustrates NR SS/PBCH block and RMSI transmission which employs the above mentioned mechanism.

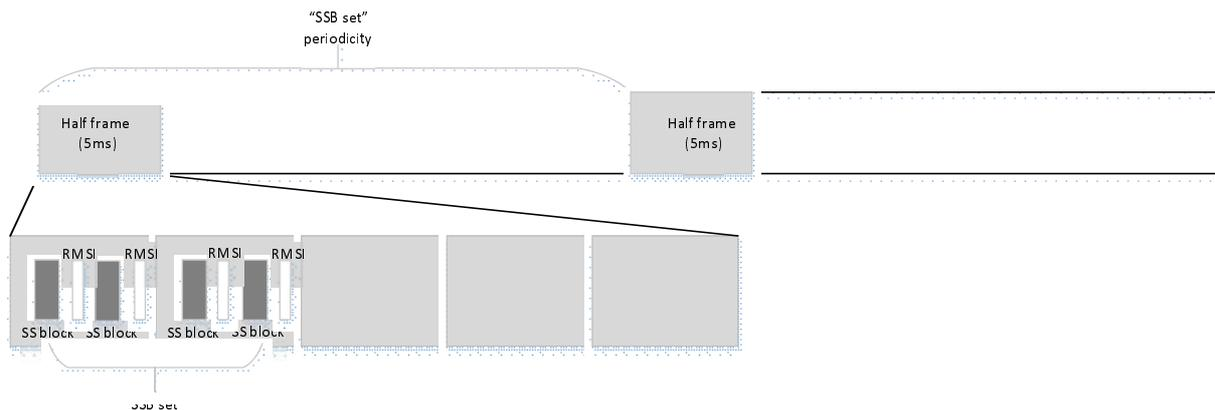

Figure 5.8.1.1-1 Illustration of NR SS/PBCH block and RMSI transmission

5.8.1.1.1 Evaluation of sleep ratio

Based on the above mechanisms, the sleep ratio per slot basis and per symbol basis are given as follows,

$$Sleep_ratio_{Slot_based} = 1 - \frac{\lceil L/2 \rceil}{2^\mu \times P_{SSB}}$$

$$Sleep_ratio_{Symbol_based} = 1 - \frac{L \times 2/7}{2^\mu \times P_{SSB}} - \alpha \cdot \frac{L/7}{2^\mu \times P_{RMSI}}$$

where $\lceil x \rceil$ indicates the ceiling of x , μ is the numerology (as defined in TS 38.211 [7], e.g., $\mu=0$ for 15 kHz SCS, $\mu=1$ for 30 kHz SCS, $\mu=3$ for 120 kHz SCS, and $\mu=4$ for 240 kHz SCS), L is the number of SS/PBCH blocks in one SSB set, P_{SSB} is the SSB set periodicity, P_{RMSI} is the RMSI periodicity, and α is the flag variable ($\alpha=1$ for FR1, and $\alpha=0$ for FR2).

Evaluation results are shown in Table 5.8.1.1.1-1 and Table 5.8.1.1.1-2, respectively, for slot level and symbol level sleep ratio. It is observed that with SSB set period of 5ms, more than 80% of sleep ratio can be obtained by NR network; with SSB set period of larger than 10ms, more than 90% of sleep ratio can be obtained by NR network. Higher sleep ratio is expected with finer sleep granularity, e.g., in symbol level. Note that a subset of configurations in terms of number of SSB per set is used to derive the results.

Therefore NR network can achieve high sleep ratio in unloaded case.

Table 5.8.1.1.1-1 NR network sleep ratio in slot level

SSB configuration		SSB set periodicity P_{SSB}					
SCS [kHz]	Number of SS/PBCH block per SSB set, L	5ms	10ms	20ms	40ms	80ms	160ms
15kHz	1	80.00%	90.00%	95.00%	97.50%	98.75%	99.38%
	2	80.00%	90.00%	95.00%	97.50%	98.75%	99.38%
30kHz	1	95.00%	97.50%	98.75%	99.38%	99.69%	99.84%
	4	80.00%	90.00%	95.00%	97.50%	98.75%	99.38%
120kHz	8	90.00%	95.00%	97.50%	98.75%	99.38%	99.69%
	16	80.00%	90.00%	95.00%	97.50%	98.75%	99.38%
240kHz	16	90.00%	95.00%	97.50%	98.75%	99.38%	99.69%
	32	80.00%	90.00%	95.00%	97.50%	98.75%	99.38%

Table 5.8.1.1.1-2 NR network sleep ratio in symbol level

SSB configuration		SSB set periodicity P_{SSB}					
SCS [kHz]	Number of SS/PBCH block per SSB set, L	5ms	10ms	20ms	40ms	80ms	160ms
15kHz	1	93.57%	96.43%	97.86%	98.93%	99.46%	99.73%
	2	87.14%	92.86%	95.71%	97.86%	98.93%	99.46%
30kHz	1	96.79%	98.21%	98.93%	99.46%	99.73%	99.87%
	4	87.14%	92.86%	95.71%	97.86%	98.93%	99.46%
120kHz	8	94.29%	97.14%	98.57%	99.29%	99.64%	99.82%
	16	88.57%	94.29%	97.14%	98.57%	99.29%	99.64%
240kHz	16	94.29%	97.14%	98.57%	99.29%	99.64%	99.82%
	32	88.57%	94.29%	97.14%	98.57%	99.29%	99.64%

5.8.1.1.2 Evaluation of sleep duration

Based on the above mechanisms, evaluation results of sleep duration is provided in Table 5.8.1.1.2-1. It is observed that with SSB set period of 160 ms, more than 150ms sleep duration can be obtained by NR network. Therefore NR network can achieve long sleep duration in unloaded case.

Therefore, NR meets network side energy efficiency requirement.

Table 5.8.1.1.2-1 NR network sleep duration (ms) in slot level

SSB configuration		SSB set periodicity P_{SSB}					
SCS [kHz]	Number of SS/PBCH block per SSB set, L	5ms	10ms	20ms	40ms	80ms	160ms
15kHz	1	4.00	9.00	19.00	39.00	79.00	159.00
	2	4.00	9.00	19.00	39.00	79.00	159.00
30kHz	1	4.50	9.50	19.50	39.50	79.50	159.50
	4	4.00	9.00	19.00	39.00	79.00	159.00
120kHz	8	4.50	9.72	18.92	39.03	78.97	158.99
	16	4.00	9.88	18.77	39.05	78.96	158.99
240kHz	16	4.50	9.86	18.90	39.04	78.97	158.99
	32	4.00	9.94	18.76	39.06	78.96	158.99

5.8.1.2 LTE

The sleep ratio and sleep duration for LTE network under unloaded case are evaluated.

For LTE, the FeMBMS/Unicast-mixed cell and MBMS-dedicated cell are employed in LTE network evaluation.

For FeMBMS/Unicast-mixed cell,

- Sub-frame 0 and 5 are always used as non-MBSFN sub-frame for synchronization and SI acquisition.
- Sub-frame 4 and 9 are assumed to be configured as MBSFN sub-frames.
- MBSFN sub-frames are assumed not to contain unicast control region.

The above mechanism is illustrated in Figure 5.8.1.2-1.

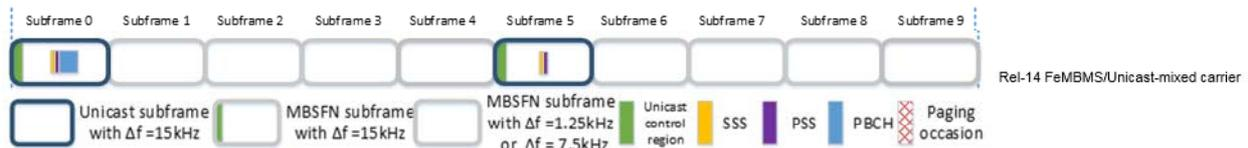

Figure 5.8.1.2-1 Illustration of LTE FeMBMS/Unicast-mixed cell transmission

For MBMS-dedicated cell,

- It is assumed that one non-MBSFN sub-frame is transmitted every 40ms.
- Other subframes do not contain synchronization signal, PBCH and control region for unicast in unloaded case.

The above mechanism is illustrated in Figure 5.8.1.2-2.

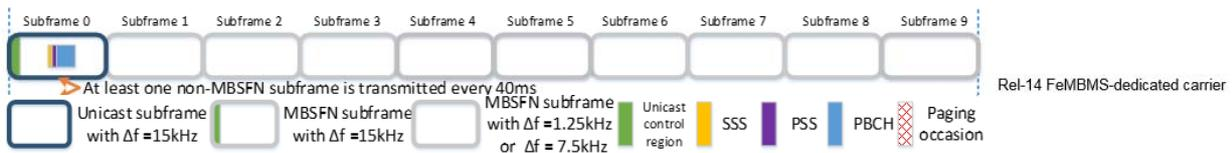

Figure 5.8.1.2-2 Illustration of LTE MBMS-dedicated cell transmission

5.8.1.2.1 Evaluation of sleep ratio

For FeMBMS/Unicast-mixed cell, 8 sub-frames are configured to be MBSFN sub-frames, and in the remaining 2 sub-frames, only PDCCH/SSS/PSS and PBCH are transmitted. Therefore the sleep ratio of FeMBMS/Unicast-mixed cell is $1-2/10=80\%$ for sub-frame level. Higher sleep ratio is expected with finer sleep granularity, e.g., in symbol level. To be specific, the sleep ratio of FeMBMS/Unicast-mixed cell is $1-(1+6+1+2)/14/10 = 92.86\%$ if only one symbol is configured for PDCCH in each unicast sub-frame.

For MBMS-dedicated cell, one-non-MBSFN sub-frame is transmitted every 40ms, thus the sleep ratio in subframe level is $1-1/40=97.5\%$. Similarly, in symbol level the sleep ratio can be further improved to $1-(1+6)/14/40 = 98.75\%$.

Table 5.8.1.2.1-1 demonstrates the evaluation results of sleep ratio for the above two cell types.

Therefore LTE network can achieve high sleep ratio for FeMBMS/Unicast-mixed cell and MBMS-dedicated cell in unloaded case.

Table 5.8.1.2.1-1 LTE network sleep ratio in subframe level

Cell type	Sleep ratio
FeMBMS/Unicast-mixed cell	80%
MBMS-dedicated cell	93.75%

5.8.1.2.2 Evaluation of sleep duration

For FeMBMS/Unicast-mixed cell, the longest sleep duration lasts from sub-frame #5 (after the PSS) to the start of next sub-frame #0 (before the PDCCH). In this case, the longest sleep duration is 4ms for sub-frame level sleep and $0.5+4 = 4.5\text{ms}$ for symbol level sleep, respectively.

For MBMS-dedicated cell, the longest sleep duration lasts from the end of PBCH in sub-frame#0 to the start of sub-frame#0 in the next 40ms cycle. In this case, the longest sleep duration of MBMS-dedicated cell is 39ms for sub-frame level sleep and $3/14+39 = 39.2\text{ms}$ for symbol level sleep, respectively.

Table 5.8.1.2.2-1 demonstrates the evaluation results of sleep duration for the above two cell types.

It is observed that MBMS-dedicated cell can achieve as long sleep duration as 39 ms in unloaded case.

Therefore LTE meets network side energy efficiency requirement for FeMBMS/Unicast-mixed cell and MBMS-dedicated cell.

Table 5.8.1.2.2-1 LTE network sleep duration (ms) in subframe level

Cell type	Sleep duration (ms)
FeMBMS/Unicast-mixed cell	4.00
MBMS-dedicated cell	39.00

5.8.2 Device side

5.8.2.1 NR

The sleep ratio and sleep duration for NR UEs under unloaded case are evaluated.

For NR, DRX is supported for UEs in idle, inactive and connected states.

5.8.2.1.1 Evaluation of sleep ratio

For idle state and inactive state, the UE should monitor one paging occasion per discontinuous reception (DRX) cycle (which equals to the paging cycle), and the UE can use DRX to reduce power consumption. Before paging receiving, the SSB monitoring is needed. Also RRM measurement(s), including intra- and inter-cell shall be performed.

The DRX cycle for idle state / inactive state UE consists of an "On Duration" during which the UE should perform SSB monitoring, paging monitoring and RRM measurement, and an "Off Duration" during which the UE can skip reception of downlink channels to save energy. It is illustrated in Figure 5.8.2.1.1-1.

Therefore the sleep ratio is determined by the length of "On Duration" and the length of one paging cycle.

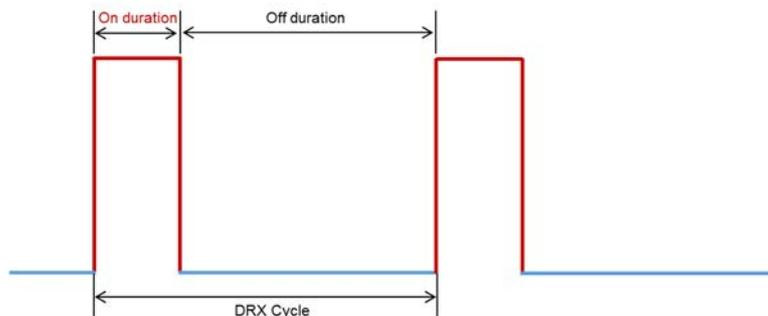

Figure 5.8.2.1.1-1 Illustration of DRX cycle in connected state

When DRX is used, the UE wakes up and receives SSB for synchronization, listens to PDCCH only on specific paging occasion defined in-terms of paging frame and subframe within period of N_{PC_RF} radio frames defined by the DRX cycle (paging cycle) of the cell and performs RRM measurement. The UE can remain in sleep mode for remaining duration within DRX cycle.

For synchronization, one SSB-burst set is assumed for short paging cycle (e.g., 320ms). Further, it is assumed that synchronization signal can be located in the same slot as paging-on slot and UE can finish network synchronization before paging monitoring. For longer paging cycle, one SSB-burst can still be assumed. In addition, to improve synchronization accuracy, the case of two SSB-burst sets is also evaluated. In this case, UE needs additional time up to one SSB cycle for SSB reception.

For paging monitoring, a paging occasion *can consist of multiple time slots (e.g. slot or OFDM symbol) where* paging DCI can be sent. In the evaluation, it is assumed that one paging occasion consists of one slot. On the other hand, one paging cycle consists of one or multiple Paging Frames. One Paging Frame may contain one or multiple paging occasion(s) or starting point of a PO. In the evaluation, it is assumed that one Paging Frame contains one paging occasion and time for paging monitoring is not longer than that of one SSB burst.

RRM measurement is based on SS/PBCH. In the evaluation, it is assumed that RRM measurement takes place in "On Duration" time, and the RRM measurement time is assumed to be 3.5ms for FR2 and 3ms for FR1 (see TS 38.133 [12]).

In addition to the above procedure, transition time is needed for UE to switch on / off its components. 10ms transition time is assumed for evaluation; but further reduced value is possible.

Based on the above analysis, the idle mode sleep ratio is evaluated with the configurations shown in Table 5.8.2.1.1-1. It is observed that more than 90% sleep ratio is achieved in idle mode by NR device.

Table 5.8.2.1.1-1 NR device sleep ratio in slot level (for idle / inactive mode)

	Paging cycle $N_{PC_RF} * 10$ (ms)	SCS(kHz)	SSB L	SSB reception time(ms)	SSB cycle (ms)	Number of SSB burst set	RRM measurement time per DRX (ms)	Transition time(ms)	Sleep ratio
RRC- Idle/Inactive	320	240	32	1	--	1	3.5	10	95.5%
	2560	15	2	1	--	1	3	10	99.5%
	2560	15	2	1	160	2	3	10	93.2%

NOTE: For SSB period, "--" is assumed that SSB reception is during DRX-On time.

For connected state, if there is no data transmission in either downlink or uplink direction, the DRX mode is switched on.

The DRX cycle for connected state UE consists of an "On Duration" during which the UE should perform SSB monitoring, PDCCH monitoring (reflected as *DRX-onDurationTimer*), and RRM measurement, and an "Off Duration" during which the UE can skip reception of downlink channels to save energy. Also, transition time is assumed in "On Duration". The connected mode sleep ratio for different DRX cycles is shown in Table 5.8.2.1.1-2. Therefore NR device can achieve high sleep ratio for both idle/inactive state and connected state in unloaded case.

Table 5.8.2.1.1-2 NR device sleep ratio in slot level (for connected mode)

	DRX cycle $T_{SC_ms} * M_{sc}$ (ms)	Number of SSB burst set	DRX- onDurationTi mer(ms)	RRM measureme nt time per DRX (ms)	Transition time(ms)	Sleep ratio
RRC-Connected	320	1	2	3.5	10	95.2%
	320	1	10	3	10	92.8%
	2560	1	100	3	10	95.6%
	10240	1	1600	3	10	84.2%

NOTE: For SSB period, "--" is assumed that SSB reception is during DRX-On time.

5.8.2.1.2 Evaluation of sleep duration

The sleep duration for NR UE in idle mode is 2546ms for paging cycle of 2560ms with the assumed parameters.

The sleep duration of NR UE in connected state is 8627ms for paging cycle of 10240ms with the assumed parameters.

Consequently NR device can achieve very long sleep duration in both idle mode and connected mode.

It is therefore concluded that NR meets device side energy efficiency requirement.

5.8.2.2 LTE

The sleep ratio and sleep duration for NR UEs under unloaded case are evaluated.

For LTE, DRX is supported for UE in both idle and connected modes.

5.8.2.2.1 Evaluation of sleep ratio

For idle mode, the UE should monitor one paging occasion per discontinuous reception (DRX) cycle (which equals to the paging cycle), and the UE can use DRX to reduce power consumption. Before paging receiving, the PSS/SSS monitoring is needed. Also RRM measurement(s), including intra- and inter-cell shall be performed.

The DRX cycle for idle state / inactive state UE consists of an "On Duration" during which the UE should perform PSS/SSS monitoring, paging monitoring and RRM measurement, and an "Off Duration" during which the UE can skip reception of downlink channels to save energy. It is illustrated in Figure 5.8.2.1.1-1.

Therefore the sleep ratio is determined by the length of "On Duration" and the length of one paging cycle.

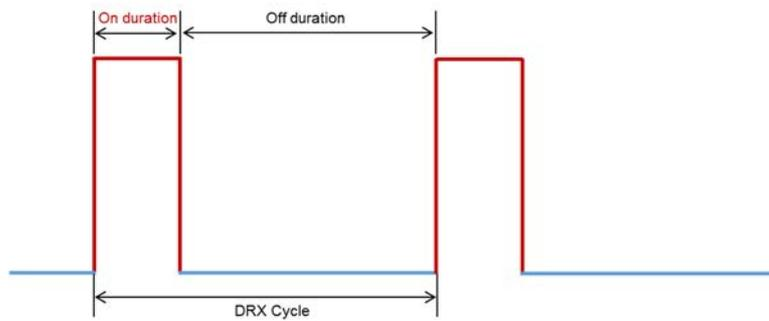

Figure 5.8.2.2.1-1 Illustration of DRX cycle

When DRX is used, the UE wakes up and receives PSS/SSS for synchronization, listens to PDCCH only on specific paging occasion defined in-terms of paging frame and subframe within period of N_{PC_RF} radio frames defined by the DRX cycle (paging cycle) of the cell and performs RRM measurement. The UE can remain in sleep mode for remaining duration within DRX cycle.

For synchronization, one PSS/SSS reception is assumed for short paging cycle (e.g., 320ms). Further, it is assumed that synchronization signal can be located in the same subframe as paging-on slot and UE can finish network synchronization before paging monitoring. Although 10ms is needed for one synchronization cycle, 6ms is assumed for calculation of sleep ratio and sleep duration when both SSS and PSS are received. For longer paging cycle, one PSS/SSS reception can still be assumed. In addition, to improve synchronization accuracy, the case with two-PSS/SSS receptions is also evaluated. In this case, UE needs additional time up to one synchronization cycle for PSS/SSS reception.

For paging monitoring, in LTE, the similar configurations to NR can be assumed. Therefore the idle mode sleep ratio in subframe level is given by $1 - 1/(10 \times N_{PC_RF})$, where N_{PC_RF} is the paging cycle (number of radio frames). The default paging cycle (either cell-specific or UE-specific) includes {32, 64, 128, 256} radio frames.

It is assumed that RRM measurement takes place in "On Duration" time, and the RRM measurement time is assumed to be 6ms (see TS 36.133 [13]).

In addition to the above procedure, transition time is needed for UE to switch on / off its components. 10ms transition time is assumed for evaluation; but further reduced value is possible.

Based on the above analysis, the idle mode sleep ratio is evaluated with the configurations shown in Table 5.8.2.2.1-1. It is observed that more than xx% sleep ratio is achieved in idle mode by LTE device.

Table 5.8.2.2.1-1 LTE device sleep ratio in subframe level (for idle mode)

	Paging cycle $N_{PC_RF} * 10$ (ms)	Synchronization reception time per cycle(ms)	Synchronization cycle(ms)	Number of synchronization	RRM measurement time per DRX (ms)	Transition time (ms)	DL/UL subframe ratio	Sleep ratio
RRC-Idle	320	2	10*	1	6	10	1	93.1%
	320	2	10*	2	6	10	1	90.0%
	2560	2	10*	1	6	10	1	99.1%
	2560	2	10*	2	6	10	1	98.8%

*6ms is assumed in the calculation when SSS and PSS have both been received.

For LTE UE in RRC connected mode, if there is no data transmission in either downlink or uplink direction, the DRX mode is switched on. The DRX cycle consists of an "On Duration" during which the UE should monitor PSS/SSS, the PDCCH and perform RRM measurement, and an "Off Duration" during which the UE can skip reception of downlink channels to save energy. Also, transition time is assumed in "On Duration". The DRX cycle is configured by the LTE network in RRC Connection Setup request and RRC Connection Reconfiguration request.

The connected mode sleep ratio for different DRX cycles is shown in Table 5.8.2.2.1-2. Therefore NR device can achieve high sleep ratio for both idle/inactive state and connected state in unloaded case.

Table 5.8.2.1-2 LTE device sleep ratio in subframe level (for connected mode)

	DRX cycle $T_{\text{CYCLE_SF}}$ (ms)	Synchronization reception time(ms)	Synchronization cycle(ms)	Number of synchronization	PDCCH reception time(ms)	RRM measurement time per DRX (ms)	DL/UL subframe ratio	Sleep ratio
RRC- Connected	320	2	--	1	10	6	1	91.9%
	320	2	10	2	10	6	0.5	85.6%
	2560	2	--	1	100	6	1	95.5%
	2560	2	10	2	100	6	0.5	91.2%
	10240	2	--	1	1600	6	1	84.2%

5.8.2.2.2 Evaluation of sleep duration

Based on LTE DRX mechanism for idle mode and connected mode, the sleep duration for idle mode is 2538ms for paging cycle of 2560ms with the assumed parameters, and for connected mode, it is 8624ms for paging cycle of 10240ms with the assumed parameters.

Consequently LTE device can achieve very long sleep duration in both idle mode and connected mode.

It is therefore concluded that LTE meets device side energy efficiency requirement.

5.9 Mobility

As defined in Report ITU-R M.2410 [4], Mobility is the maximum mobile station speed at which a defined QoS can be achieved (in km/h). The QoS is defined as normalized traffic channel link data rate.

5.9.1 NR

A wide range of antenna configurations and transmission schemes are considered for NR. Detailed evaluation assumptions and results can be found in Annex B.4.2.

5.9.1.1 Indoor Hotspot – eMBB

Evaluation configuration A (carrier frequency = 4 GHz) and evaluation configuration B (carrier frequency = 30 GHz) with either 12TRxP or 36TRxP cases are applied for the evaluations of Indoor Hotspot– eMBB test environment for NR. Both NR FDD and TDD are evaluated.

5.9.1.1.1 Evaluation configuration A (CF = 4 GHz)

The evaluation results of mobility for NR FDD and NR TDD for evaluation configuration A with 12TRxP are provided in Table 5.9.1.1.1-1.

**Table 5.9.1.1.1-1 NR mobility in Indoor Hotspot – eMBB
(Evaluation configuration A, CF=4 GHz, for 12TRxP)**

(a) NR FDD

Scheme and antenna configuration	Sub-carrier spacing (kHz)	ITU Requirement (bit/s/Hz)	Channel model A			Channel model B		
			Channel condition	Number of samples	Normalized traffic channel link data rate (bit/s/Hz)	Channel condition	Number of samples	Normalized traffic channel link data rate (bit/s/Hz)
1x8 SIMO	15	1.5	LOS	3	1.97	LOS	3	2.13
			NLOS	4	1.78	NLOS	4	1.84
1x2 SIMO	30		LOS	1	2.8	LOS	1	2.8
			NLOS	1	2.5	NLOS	1	2.5
2x8 SU-MIMO	30		LOS	/	/	LOS	/	/
			NLOS	1	3.85	NLOS	/	/
1x1 SU-SISO	30		LOS	/	/	LOS	/	/
			NLOS	1	2.18	NLOS	/	/
2x8 SU-MIMO	15		NLOS	1	3.21	NLOS	/	/
2x8 SU-MIMO	30		NLOS	1	2.99	NLOS	/	/
1x16 SIMO	15		LOS	1	2.27	LOS	1	2.43
			NLOS	1	1.65	NLOS	1	1.72

(b) NR TDD

Scheme and antenna configuration	Sub-carrier spacing (kHz)	Frame structure	ITU Requirement (bit/s/Hz)	Channel model A			Channel model B		
				Channel condition	Number of samples	Normalized traffic channel link data rate (bit/s/Hz)	Channel condition	Number of samples	Normalized traffic channel link data rate (bit/s/Hz)
1x8 SIMO	30	DDDSU	1.5	LOS	1	1.94	LOS	1	1.95
				NLOS	1	1.59	NLOS	1	1.60
1x8 SIMO	15	DSUUD		LOS	1	2.07	LOS	1	2.08
				NLOS	1	1.78	NLOS	1	1.79
1x2 SIMO	30	UUUUU		LOS	1	2.3	LOS	1	2.3
				NLOS	1	2.0	NLOS	1	2.0
2x8 SU-MIMO	30	DDDDDDDSUU		NLOS	1	3.85	NLOS	/	/
11 SU-SISO	30	UUUUU		NLOS	1	1.78	NLOS	/	/

The evaluation results of mobility for NR FDD and NR TDD for evaluation configuration A with 36TRxP are provided in Table 5.9.1.1.1-2.

It is observed that NR fulfill the mobility requirement in evaluation configuration A.

**Table 5.9.1.1.1-2 NR mobility in Indoor Hotspot – eMBB
(Evaluation configuration A, CF=4 GHz, for 36TRxP)**

(a) NR FDD

Scheme and antenna configuration	Sub-carrier spacing (kHz)	ITU Requirement (bit/s/Hz)	Channel model A			Channel model B		
			Channel condition	Number of samples	Normalized traffic channel link data rate (bit/s/Hz)	Channel condition	Number of samples	Normalized traffic channel link data rate (bit/s/Hz)
2x8 SU-MIMO	15	1.5	NLOS	1	1.78	NLOS	/	/
2x8 SU-MIMO	30		NLOS	1	1.77	NLOS	/	/

5.9.1.1.2 Evaluation configuration B (CF = 30 GHz)

The evaluation results of mobility for NR FDD and NR TDD for evaluation configuration B with 12TRxP are provided in Table 5.9.1.1.2-1.

**Table 5.9.1.1.2-1 NR mobility in Indoor Hotspot – eMBB
(Evaluation configuration B, CF=30 GHz, for 12TRxP)**

(a) NR FDD

Scheme and antenna configuration	Sub-carrier spacing (kHz)	ITU Requirement (bit/s/Hz)	Channel condition	Number of samples	Normalized traffic channel link data rate (bit/s/Hz)
1x4 SIMO	60	1.5	NLOS	1	2.84
4x8 SU-MIMO	120		LOS	1	4.76
			NLOS	1	3.01

(b) NR TDD

Scheme and antenna configuration	Sub-carrier spacing (kHz)	Frame structure	ITU Requirement (bit/s/Hz)	Channel condition	Number of samples	Normalized traffic channel link data rate (bit/s/Hz)
2x8 SU-MIMO	60	UUUUU	1.5	NLOS	1	4.48
2x8 SU-MIMO	120	UUUUU		NLOS	1	4.27
1x8 SIMO	120	DDDSU		LOS	1	2.15
				NLOS	1	2.14

The evaluation results of mobility for NR for evaluation configuration B with 36TRxP are provided in Table 5.9.1.1.2-2.

It is observed that NR fulfills the mobility requirement in evaluation configuration B.

**Table 5.9.1.1.2-2 NR mobility in Indoor Hotspot – eMBB
(Evaluation configuration B, CF=30 GHz, for 36TRxP)**

(a) NR TDD

Scheme and antenna configuration	Sub-carrier spacing (kHz)	Frame structure	ITU Requirement (bit/s/Hz)	Channel condition	Number of samples	Normalized traffic channel link data rate (bit/s/Hz)
2x8 SU-MIMO	60	UUUUU	1.5	NLOS	1	4.13
2x8 SU-MIMO	120	UUUUU		NLOS	1	3.91

5.9.1.2 Dense Urban – eMBB

Evaluation configuration A (carrier frequency = 4 GHz) and evaluation configuration B (carrier frequency = 30 GHz) are applied for the evaluations of Dense Urban – eMBB test environment for NR.

5.9.1.2.1 Evaluation configuration A (CF = 4 GHz)

The evaluation results of mobility for NR FDD and NR TDD for evaluation configuration A are provided in Table 5.9.1.2.1-1.

It is observed that NR fulfills the mobility requirement in evaluation configuration A.

**Table 5.9.1.2.1-1 NR mobility in Dense Urban – eMBB
(Evaluation configuration A, CF=4 GHz)**

(a) NR FDD

Scheme and antenna configuration	Sub-carrier spacing (kHz)	ITU Requirement (bit/s/Hz)	Channel model A			Channel model B		
			Channel condition	Number of samples	Normalized traffic channel link data rate (bit/s/Hz)	Channel condition	Number of samples	Normalized traffic channel link data rate (bit/s/Hz)
1x8 SIMO	15	1.12	LOS	4	2.07	LOS	4	2.19
			NLOS	5	1.87	NLOS	5	1.97
1x2 SIMO	30		LOS	1	2.6	LOS	1	2.6
			NLOS	1	1.8	NLOS	1	1.8
1x4 SIMO	30		NLOS	1	1.14	NLOS	2	1.41
			LOS	1	1.37	LOS	1	1.47
2x8 SU-MIMO	30		NLOS	3	3.79	NLOS	1	3.55
2x8 SU-MIMO	15		NLOS	1	1.92	NLOS	/	/
1x1 SISO	30		NLOS	1	1.56	NLOS	/	/

(b) NR TDD

Scheme and antenna configuration	Sub-carrier spacing (kHz)	Frame structure	ITU Requirement (bit/s/Hz)	Channel model A			Channel model B		
				Channel condition	Number of samples	Normalized traffic channel link data rate (bit/s/Hz)	Channel condition	Number of samples	Normalized traffic channel link data rate (bit/s/Hz)
1x8 SIMO	30	DDDSU	1.12	LOS	1	2.17	LOS	1	2.06
				NLOS	1	1.82	NLOS	1	1.79
1x8 SIMO	15	DSUUD		LOS	1	2.33	LOS	1	2.29
				NLOS	1	2.03	NLOS	1	2.00
1x2 SIMO	30	UUUUU		LOS	1	2.2	LOS	1	2.2
				NLOS	1	1.5	NLOS	1	1.5
2x8 SU-MIMO	30	DDDDDD SUU		NLOS	1	4.58	NLOS	/	/
1x1 SISO	30	UUUUU		NLOS	1	1.28	NLOS	/	/
1x4 SIMO	30	UUUUU		NLOS	/	/	NLOS	1	1.57

5.9.1.2.2 Evaluation configuration B (CF = 30 GHz)

The evaluation results of mobility for NR FDD and NR TDD for evaluation configuration B are provided in Table 5.9.1.2.2-1.

It is observed that NR fulfills the mobility requirement in evaluation configuration B.

**Table 5.9.1.2.2-1 NR mobility in Dense Urban – eMBB
(Evaluation configuration B, CF=30 GHz)**

(a) NR FDD

Scheme and antenna configuration	Sub-carrier spacing (kHz)	ITU Requirement (bit/s/Hz)	Channel condition	Number of samples	Normalized traffic channel link data rate (bit/s/Hz)
1x4 SIMO	60	1.12	NLOS	1	1.24
2x8 MIMO	60		NLOS	1	3.22
2x8 MIMO	120		NLOS	1	2.67
1x8 SIMO	60		LOS	1	1.62
			NLOS	1	1.3
4x8 MIMO	120		LOS	1	2.09
			NLOS	1	1.23

5.9.1.3 Rural – eMBB

Evaluation configuration A (carrier frequency = 700 MHz) and evaluation configuration B (carrier frequency = 4 GHz) are applied for the evaluations of Rural – eMBB test environment for NR. Both NR FDD and TDD are evaluated. The mobility class of 120km/h and 500km/h are considered.

5.9.1.3.1 Evaluation configuration A (CF = 700 MHz)

The evaluation results of mobility for NR FDD and NR TDD for evaluation configuration A for mobility class of 120km/h are provided in Table 5.9.1.3.1-1.

**Table 5.9.1.3.1-1 NR mobility in Rural – eMBB
(Evaluation configuration A, CF=700 MHz, Mobility class of 120km/h)**

(a) NR FDD

Scheme and antenna configuration	Sub-carrier spacing (kHz)	ITU Requirement (bit/s/Hz)	Channel model A			Channel model B		
			Channel condition	Number of samples	Normalized traffic channel link data rate (bit/s/Hz)	Channel condition	Number of samples	Normalized traffic channel link data rate (bit/s/Hz)
1x4 SIMO (Scheduler 1)	15	0.8	LOS	3	2.49	LOS	3	3.0
			NLOS	5	1.71	NLOS	5	2.14
1x2 SIMO	15		LOS	1	1.80	LOS	1	1.80
			NLOS	1	1.00	NLOS	1	1.00
1x4 SIMO (Scheduler 2)	15		NLOS	/	/	NLOS	1	1.75
2x2 SU-MIMO	15		NLOS	2	1.79	NLOS	1	1.54
1x8 SIMO	15		LOS	1	2.89	LOS	1	2.91
			NLOS	1	2.86	NLOS	1	2.90
2x8 SU-MIMO	15		NLOS	1	2.46	NLOS	/	/
2x8 SU-MIMO	30		NLOS	1	2.46	NLOS	/	/

(b) NR TDD

Scheme and antenna configuration	Sub-carrier spacing (kHz)	Frame structure	ITU Requirement (bit/s/Hz)	Channel model A			Channel model B		
				Channel condition	Number of samples	Normalized traffic channel link data rate (bit/s/Hz)	Channel condition	Number of samples	Normalized traffic channel link data rate (bit/s/Hz)
1x4 SIMO	15	DDDSU	0.8	LOS	1	2.63	LOS	1	2.63
				NLOS	1	2.10	NLOS	1	2.09
1x2 SIMO	15	UUUUU		LOS	1	1.60	LOS	1	1.60
				NLOS	1	0.85	NLOS	1	0.85
2x2 SU-MIMO	15	DDDSU		NLOS	1	2.01	NLOS	/	/
1x8 SIMO	15	DSUUD		LOS	1	2.81	LOS	1	2.82
				NLOS	1	2.77	NLOS	1	2.81

The evaluation results of mobility for NR FDD and NR TDD for evaluation configuration A for mobility class of 500km/h are provided in Table 5.9.1.3.1-2.

It is observed that NR fulfills the mobility requirement under both 120km/h and 500km/h.

Table 5.9.1.3.1-2 NR mobility in Rural – eMBB
(Evaluation configuration A, CF=700 MHz, Mobility class of 500km/h)

(a) NR FDD

Scheme and antenna configuration	Sub-carrier spacing (kHz)	ITU Requirement (bit/s/Hz)	Channel model A			Channel model B		
			Channel condition	Number of samples	Normalized traffic channel link data rate (bit/s/Hz)	Channel condition	Number of samples	Normalized traffic channel link data rate (bit/s/Hz)
1x4 SIMO	30	0.45	LOS	2	2.53	LOS	2	2.53
			NLOS	4	1.53	NLOS	4	1.54
1x2 SIMO	15		LOS	1	1.40	LOS	1	1.40
			NLOS	1	0.70	NLOS	1	0.70
1x4 SIMO	15		NLOS	/	/	NLOS	1	0.86
			NLOS	1	1.92	NLOS	/	/
2x2 SU-MMO	15		NLOS	1	1.28	NLOS	1	1.21
2x2 SU-MMO	30		LOS	1	2.40	LOS	1	2.43
1x8 SIMO	30		NLOS	1	2.39	NLOS	1	2.40
			NLOS	1	2.73	NLOS	/	/
2x8 SU-MIMO	15		NLOS	1	2.46	NLOS	/	/
2x8 SU-MIMO	30		NLOS	1		NLOS	/	/

(b) NR TDD

Scheme and antenna configuration	Sub-carrier spacing (kHz)	Frame structure	ITU Requirement (bit/s/Hz)	Channel model A			Channel model B		
				Channel condition	Number of samples	Normalized traffic channel link data rate (bit/s/Hz)	Channel condition	Number of samples	Normalized traffic channel link data rate (bit/s/Hz)
1x4 SIMO	30	DDDSU	0.45	LOS	1	2.39	LOS	1	2.39
				NLOS	1	1.88	NLOS	1	1.87
1x2 SIMO	15	UUUUU		LOS	1	1.10	LOS	1	1.10
				NLOS	1	0.60	NLOS	1	0.60
2x2 SU-MIMO	15	DDDSU		LOS	/	/	LOS	/	/
				NLOS	1	1.92	NLOS	/	/
1x8 SIMO	30	DSUUD		LOS	1	2.30	LOS	1	2.33
				NLOS	1	2.28	NLOS	1	2.29

5.9.1.3.2 Evaluation configuration B (CF = 4 GHz)

The evaluation results of mobility for NR FDD and NR TDD for evaluation configuration B for mobility class of 120km/h are provided in Table 5.9.1.3.2-1.

Table 5.9.1.3.2-1 NR mobility in Rural – eMBB
(Evaluation configuration B, CF=4 GHz, Mobility class of 120km/h)

(a) NR FDD

Scheme and antenna configuration	Sub-carrier spacing (kHz)	ITU Requirement (bit/s/Hz)	Channel model A			Channel model B		
			Channel condition	Number of samples	Normalized traffic channel link data rate (bit/s/Hz)	Channel condition	Number of samples	Normalized traffic channel link data rate (bit/s/Hz)
1x4 SIMO (Scheduler 1)	30	0.8	LOS	2	2.08	LOS	3	2.13
			NLOS	5	1.56	NLOS	5	1.6
1x4 SIMO (Scheduler 2)	30		NLOS	/	/	NLOS	1	1.08
1x8 SIMO	30		LOS	1	1.87	LOS	1	1.86
			NLOS	1	1.74	NLOS	1	1.73
2x8 SU-MIMO	15		NLOS	1	2.75	NLOS	/	/
2x8 SU-MIMO	30		NLOS	2	2.57	NLOS	1	2.41
1x1 SISO	30		LOS	1	1.32	LOS	/	/

(b) NR TDD

Scheme and antenna configuration	Sub-carrier spacing (kHz)	Frame structure	ITU Requirement (bit/s/Hz)	Channel model A			Channel model B		
				Channel condition	Number of samples	Normalized traffic channel link data rate (bit/s/Hz)	Channel condition	Number of samples	Normalized traffic channel link data rate (bit/s/Hz)
1x4 SIMO	30	DDDSU	0.8	LOS	1	1.57	LOS	1	1.52
				NLOS	1	1.18	NLOS	1	1.16
1x8 SIMO	30	DSUUD		LOS	1	1.79	LOS	1	1.78
				NLOS	1	1.66	NLOS	1	1.65
1x1 SISO	30	UUUUU		LOS	1	1.02	LOS	/	/

The evaluation results of mobility for NR FDD and NR TDD for evaluation configuration B for mobility class of 500km/h are provided in Table 5.9.1.3.2-2.

It is observed that NR fulfills the mobility requirement under both 120km/h and 500km/h.

Table 5.9.1.3.2-2 NR mobility in Rural – eMBB
(Evaluation configuration B, CF=4 GHz, Mobility class of 500km/h)

(a) NR FDD

Scheme and antenna configuration	Sub-carrier spacing (kHz)	ITU Requirement (bit/s/Hz)	Channel model A			Channel model B		
			Channel condition	Number of samples	Normalized traffic channel link data rate (bit/s/Hz)	Channel condition	Number of samples	Normalized traffic channel link data rate (bit/s/Hz)
1x4 SIMO	60	0.45	LOS	2	1.35	LOS	2	1.37
			NLOS	4	0.91	NLOS	4	0.91
1x8 SIMO	30		LOS	1	1.43	LOS	1	1.38
			NLOS	1	1.11	NLOS	1	1.08
2x8 SU-MIMO	15		NLOS	1	2.09	NLOS	/	/
2x8 SU-MIMO	30		NLOS	2	2.01	NLOS	/	/
1x1 SISO	30		LOS	1	0.82	LOS	/	/

(b) NR TDD

Scheme and antenna configuration	Sub-carrier spacing (kHz)	Frame structure	ITU Requirement (bit/s/Hz)	Channel model A			Channel model B		
				Channel condition	Number of samples	Normalized traffic channel link data rate (bit/s/Hz)	Channel condition	Number of samples	Normalized traffic channel link data rate (bit/s/Hz)
1x4 SIMO	60	DDDSU	0.45	LOS	1	1.22	LOS	1	1.22
				NLOS	1	0.84	NLOS	1	0.83
1x8 SIMO	30	DSUUD		LOS	1	1.37	LOS	1	1.31
				NLOS	1	1.06	NLOS	1	1.03
1x1 SISO	30	UUUUU		LOS	1	0.64	LOS	/	/

5.9.2 LTE

Several configurations are evaluated for LTE. Detailed evaluation assumptions and results can be found in Annex B.4.2.

5.9.2.1 Indoor Hotspot – eMBB

Evaluation configuration A (carrier frequency = 4 GHz) is applied for the evaluations of Indoor Hotspot – eMBB test environment for LTE. LTE FDD is evaluated. The mobility class of 10 km/h is considered.

5.9.2.1.1 Evaluation configuration A (CF = 4 GHz)

The evaluation results of mobility for LTE FDD for evaluation configuration A are provided in Table 5.9.2.1.1-1.

It is observed that LTE fulfills the mobility requirement in evaluation configuration A.

**Table 5.9.2.1.1-1 LTE mobility in Indoor Hotspot – eMBB
(Evaluation configuration A, CF=4 GHz)**

(a) LTE FDD

Scheme and antenna configuration	Sub-carrier spacing (kHz)	ITU Requirement (bit/s/Hz)	Channel model A			Channel model B		
			Channel condition	Number of samples	Normalized traffic channel link data rate (bit/s/Hz)	Channel condition	Number of samples	Normalized traffic channel link data rate (bit/s/Hz)
1x2 SIMO	15	1.5	LOS	1	2.6	LOS	1	2.6
			NLOS	1	1.9	NLOS	1	1.9

5.9.2.2 Dense Urban – eMBB

Evaluation configuration A (carrier frequency = 4 GHz) is applied for the evaluations of Dense Urban – eMBB test environment for LTE. Both LTE FDD and TDD are evaluated. The mobility class of 30 km/h is considered.

5.9.2.2.1 Evaluation configuration A (CF = 4 GHz)

The evaluation results of mobility for LTE FDD and TDD for evaluation configuration A are provided in Table 5.9.2.2.1-1.

It is observed that LTE fulfills the mobility requirement in evaluation configuration A.

**Table 5.9.2.2.1-1 LTE mobility in Dense Urban – eMBB
(Evaluation configuration A, CF=4 GHz)**

(a) LTE FDD

Scheme and antenna configuration	Sub-carrier spacing (kHz)	ITU Requirement (bit/s/Hz)	Channel model A			Channel model B		
			Channel condition	Number of samples	Normalized traffic channel link data rate (bit/s/Hz)	Channel condition	Number of samples	Normalized traffic channel link data rate (bit/s/Hz)
1x8 SIMO	15	1.12	LOS	1	1.99	LOS	1	1.88
			NLOS	1	1.81	NLOS	1	1.77

(b) LTE TDD

Scheme and antenna configuration	Sub-carrier spacing (kHz)	Frame structure	ITU Requirement (bit/s/Hz)	Channel model A			Channel model B		
				Channel condition	Number of samples	Normalized traffic channel link data rate (bit/s/Hz)	Channel condition	Number of samples	Normalized traffic channel link data rate (bit/s/Hz)
1x8 SIMO	15	DSUUD	1.12	LOS	1	1.91	LOS	1	1.81
				NLOS	1	1.74	NLOS	1	1.70

5.9.2.3 Rural – eMBB

Evaluation configuration A (carrier frequency = 700 MHz) is applied for the evaluations of Rural – eMBB test environment for LTE. Both LTE FDD and TDD are evaluated. The mobility class of 120 km/h and 500 km/h are considered.

5.9.2.3.1 Evaluation configuration A (CF = 700 MHz)

The evaluation results of mobility for LTE FDD and TDD for evaluation configuration A for mobility class of 120km/h are provided in Table 5.9.2.3.1-1.

**Table 5.9.2.3.1-1 LTE mobility in Rural – eMBB
(Evaluation configuration A, CF=700 MHz, Mobility class of 120km/h)**

(a) LTE FDD

Scheme and antenna configuration	Sub-carrier spacing (kHz)	ITU Requirement (bit/s/Hz)	Channel model A			Channel model B		
			Channel condition	Number of samples	Normalized traffic channel link data rate (bit/s/Hz)	Channel condition	Number of samples	Normalized traffic channel link data rate (bit/s/Hz)
1x4 SIMO	15	0.8	LOS	1	2.79	LOS	1	2.79
			NLOS	1	2.20	NLOS	1	2.19
1x2 SIMO	15		LOS	1	1.70	LOS	1	1.70
			NLOS	1	1.00	NLOS	1	1.00
1x8 SIMO	15		LOS	1	2.91	LOS	1	2.90
			NLOS	1	2.75	NLOS	1	2.73

(b) LTE TDD

Scheme and antenna configuration	Sub-carrier spacing (kHz)	Frame structure	ITU Requirement (bit/s/Hz)	Channel model A			Channel model B		
				Channel condition	Number of samples	Normalized traffic channel link data rate (bit/s/Hz)	Channel condition	Number of samples	Normalized traffic channel link data rate (bit/s/Hz)
1x4 SIMO	15	DSUDD	0.8	LOS	1	2.49	LOS	1	2.49
				NLOS	1	1.96	NLOS	1	1.94
1x8 SIMO	15	DSUUD		LOS	1	2.79	LOS	1	2.79
				NLOS	1	2.64	NLOS	1	2.63

The evaluation results of mobility for LTE FDD and TDD for evaluation configuration A for mobility class of 500km/h are provided in Table 5.9.2.3.1-2.

It is observed that LTE fulfills the mobility requirement under both 120km/h and 500km/h.

**Table 5.9.2.3.1-2 LTE mobility in Rural – eMBB
(Evaluation configuration A, CF=700 MHz, Mobility class of 500km/h)**

(a) LTE FDD

Scheme and antenna configuration	Sub-carrier spacing (kHz)	ITU Requirement (bit/s/Hz)	Channel model A			Channel model B		
			Channel condition	Number of samples	Normalized traffic channel link data rate (bit/s/Hz)	Channel condition	Number of samples	Normalized traffic channel link data rate (bit/s/Hz)
1x4 SIMO	15	0.45	LOS	1	2.59	LOS	1	2.59
			NLOS	1	1.94	NLOS	1	1.93
1x2 SIMO	15		LOS	1	1.05	LOS	1	1.05
			NLOS	1	0.60	NLOS	1	0.60
1x8 SIMO	15		LOS	1	2.39	LOS	1	2.38
			NLOS	1	1.82	NLOS	1	1.82

(b) LTE TDD

Scheme and antenna configuration	Sub-carrier spacing (kHz)	Frame structure	ITU Requirement (bit/s/Hz)	Channel model A			Channel model B		
				Channel condition	Number of samples	Normalized traffic channel link data rate (bit/s/Hz)	Channel condition	Number of samples	Normalized traffic channel link data rate (bit/s/Hz)
1x4 SIMO	15	DSUDD	0.45	LOS	1	2.31	LOS	1	2.31
				NLOS	1	1.73	NLOS	1	1.72
1x8 SIMO	15	DSUUD		LOS	1	2.29	LOS	1	2.29
				NLOS	1	1.75	NLOS	1	1.75

5.10 Mobility interruption time

As defined in Report ITU-R M.2410 [4], mobility interruption time is the shortest time duration supported by the system during which a user terminal cannot exchange user plane packets with any base station during mobility transitions.

The mobility interruption time includes the time required to execute any radio access network procedure, radio resource control signalling protocol, or other message exchanges between the mobile station and the radio access network, as applicable to the candidate RIT/SRIT.

5.10.1 NR

5.10.1.1 Scenarios

For NR Rel-15, the mobility interruption time is evaluated for the following scenarios:

- Beam mobility;
- CA mobility.

5.10.1.2 Beam mobility

When moving within the same cell, the transmit-receive beam pair of the UE may need to be changed.

For DL data transmission during UE mobility, gNB can configure different beams for this UE at different slots. It ensures appropriate transmit beam allocation to the UE for continuous DL transmission. Therefore DL data packet transmission is kept during beam pair switching at different slots.

For UL data transmission, PUSCH is sent using the beam configured by SRI (SRS resource indicator) by gNB. Accordingly, an appropriate gNB-side beam is selected for UL data reception. gNB may select different beams at different slots depending on the UE mobility. Therefore UL data packet transmission is kept during beam pair switching at different slots.

Based on the above analysis, the UE can always exchange user plane packets with gNB during the mobility transitions. Therefore, 0ms mobility interruption time is achieved by NR for this scenario.

5.10.1.3 CA Mobility

When moving within the same PCell with CA enabled, the set of configured SCells of the UE may change. The SCell addition procedure and SCell release procedures can occur.

During these procedures, the UE can always exchange user plane packets with the gNB during transitions, because the data transmission between the UE and the PCell is kept. Therefore, 0ms mobility interruption time is achieved by NR for this case.

5.10.2 LTE

5.10.2.1 Scenarios

For LTE Rel-15, the mobility interruption time is evaluated under the following scenarios.

- PCell mobility;
- DC mobility.

5.10.2.2 PCell mobility

In Make-Before-Break handover, the connection to the source eNB is not released until DL synchronization is completed at the target eNB. For intra-frequency handover case, a dual RX UE can receive data from the source eNB and tracking RS from the target at the same time, while synchronizing with target eNB. Nevertheless, the UE releases the serving cell before performing the RACH procedure.

On the other hand, if the source eNB, target eNB and UE are synchronized, the UE may be able to obtain the target eNB timing advance (TA) without explicit TA command, so that a RACH-less handover can be applied: in some scenarios such as no or negligible UE TA difference between the source and target eNB, the UE can use its original TA for the source eNB to transmit the data to the target eNB. In this case, the delay of the RACH procedure can be avoided.

Therefore, by combining Make-Before-Break and RACH-less handover for a dual RX UE in the scenario where there is no or negligible UE TA difference between the source and the target cell, the 0ms mobility interruption time is achieved by LTE for the PCell mobility scenario.

5.10.2.3 DC Mobility

When moving within the same MeNB with DC enabled, the SeNB of the UE may change. The SeNB addition procedure and SeNB release procedure are shown below (see also Section 10.1.2.8 in 3GPP TS 36.300 [14]).

It is observed that during these procedures, the UE can always exchange user plane packets with MeNB during transitions. Therefore 0ms mobility interruption time is achieved by LTE for the DC mobility scenario.

SeNB Addition

The SeNB Addition procedure is initiated by the MeNB and is used to establish a UE context at the SeNB in order to provide radio resources from the SeNB to the UE. This procedure is used to add at least the first cell (PSCell) of the SCG. Figure 5.10.2.2-1 shows the SeNB Addition procedure. The detailed description of each step is found in Section 10.1.2.8.1 in 3GPP TS 36.300 [14]

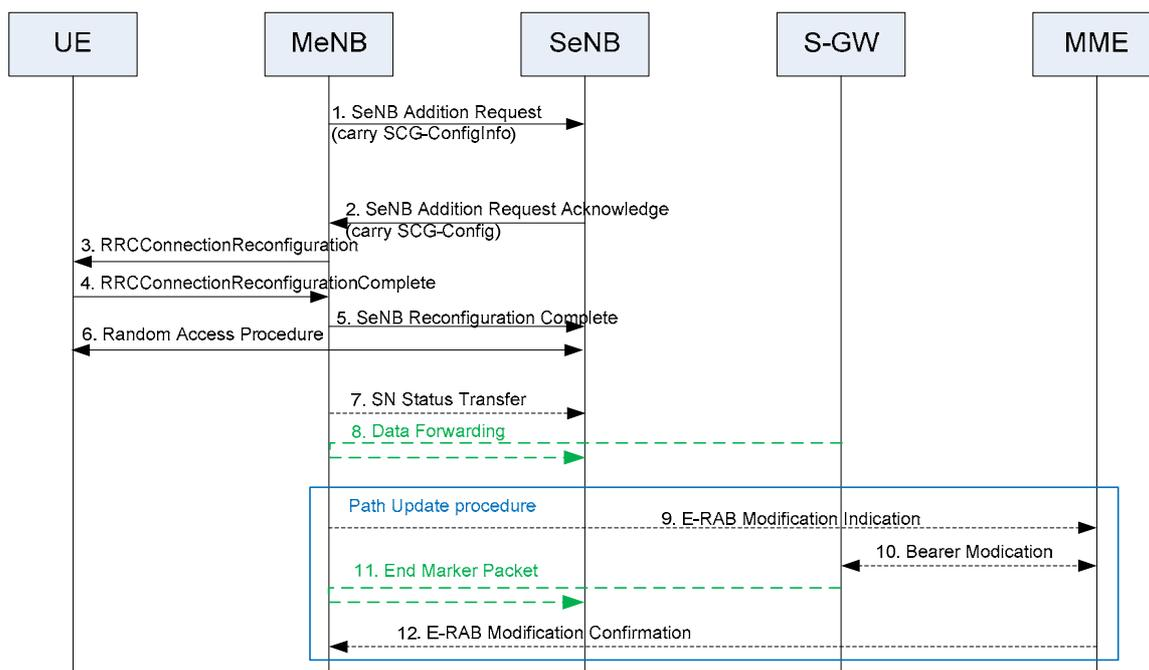

Figure 5.10.2.2-1: SeNB Addition procedure

SeNB Release

The SeNB Release procedure may be initiated either by the MeNB or by the SeNB and is used to initiate the release of the UE context at the SeNB.

It does not necessarily need to involve signalling towards the UE, e.g., RRC connection re-establishment due to Radio Link Failure in MeNB.

MeNB initiated SeNB Release

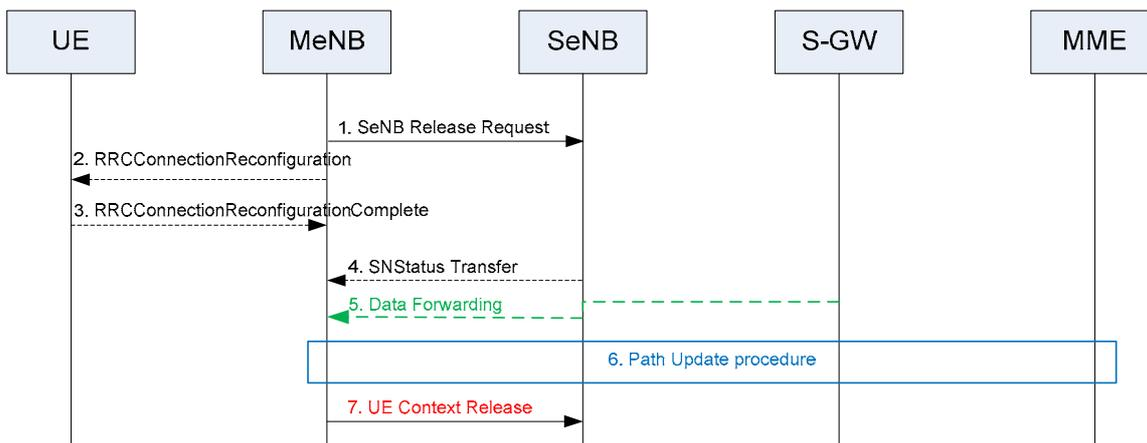

Figure 5.10.2.2-2: SeNB Release procedure – MeNB initiated

Figure 5.10.2.2-2 shows an example signalling flow for the MeNB initiated SeNB Release procedure. The detailed description of each step is found in Section 10.1.2.8.3 in 3GPP TS 36.300 [14].

SeNB initiated SeNB Release

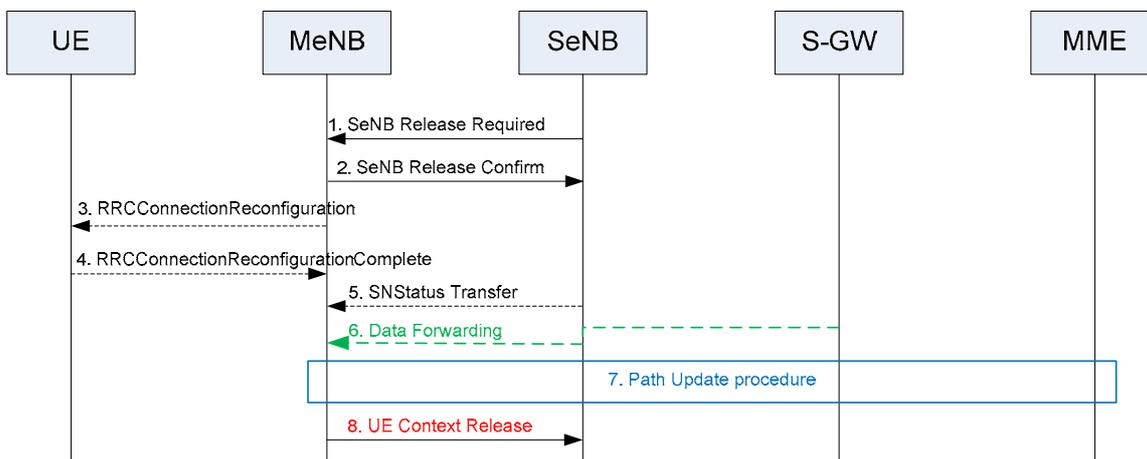

Figure 5.10.2.2-3: SeNB Release procedure – SeNB initiated

Figure 5.10.2.2-3 shows an example signalling flow for the SeNB initiated SeNB Release procedure. The detailed description of each step is found in Section 10.1.2.8.3 in 3GPP TS 36.300 [14].

6 Self evaluation of URLLC technical performance

6.1 Reliability

As defined in Report ITU-R M.2412 [6], reliability is the success probability of transmitting a layer 2/3 packet within a required maximum time, which is the time it takes to deliver a small data packet from the radio protocol layer 2/3 SDU ingress point to the radio protocol layer 2/3 SDU egress point of the radio interface at a certain channel quality.

6.1.1 NR

NR Reliability is evaluated under Urban Macro – URLLC test environment. Both downlink and uplink are evaluated. A variety of configurations are considered. Detailed assumptions and results are provided in Annex B.z.4.

6.1.1.1 DL reliability

For downlink reliability, both evaluation configuration A (carrier frequency = 4 GHz) and evaluation configuration B (carrier frequency = 700 MHz) are evaluated.

The evaluation results of NR FDD for downlink reliability are provided in Table 6.1.1.1-1. All the evaluation results are derived with less than 100 MHz and 40 MHz bandwidth for evaluation configuration A (CF = 4 GHz) and B (CF = 700 MHz), respectively. It is observed that NR FDD fulfils the reliability requirement for downlink in a wide range of configurations.

Table 6.1.1.1-1 Evaluation results of downlink reliability for NR FDD

(a) Evaluation configuration A (CF = 4 GHz)

Scheme and antenna configuration	Sub-carrier spacing [kHz]	ITU Requirement	Channel condition	Channel model A		Channel model B	
				Number of samples	Reliability	Number of samples	Reliability
2x2 SU-MIMO 14os ¹ slot, Slot aggregation, (1 PDCCH + 2 PDSCH)	60	99.999%	NLOS	1	99.999899%	1	99.99991%
2x2 SU-MIMO, 4os non-slot, HARQ re-tx (2 PDCCH + 2 PDSCH)	30	99.999%	NLOS	1	99.999898%	1	99.99995%
2x2 SU-MIMO, 4os non-slot, One shot (1 PDCCH + 1 PDSCH)	30	99.999%	NLOS	1	99.99965%	1	99.99969%
2x4 SU-MIMO 7os non-slot, One shot, (1 PDCCH + 1 PDSCH)	30	99.999%	NLOS	1	> 99.9999%	1	> 99.9999%
32x8 SU-MIMO 14os slot, One shot (1 PDCCH + 1 PDSCH)	30	99.999%	NLOS	1	99.9999%	/	/
4x2 SU-MIMO 7os slot, Slot aggregation, (1 PDCCH+2 PDSCH)	30	99.999%	NLOS	/	/	1	99.99999%
8x4 SU-MIMO 14os one-shot (1 PDCCH+1 PDSCH)	30	99.999%	NLOS	1	>99.9999%	1	>99.9999%

NOTE1: os = OFDM symbol

(b) Evaluation configuration B (CF = 700 MHz)

Scheme and antenna configuration	Sub-carrier spacing [kHz]	ITU Requirement	Channel condition	Channel model A		Channel model B	
				Number of samples	Reliability	Number of samples	Reliability
2x2 SU-MIMO 14os slot, One shot (1 PDCCH+1 PDSCH)	30	99.999%	NLOS	1	99.9998%	2	99.9994%
2x2 SU-MIMO 7os non-slot, one-shot (1 PDCCH+1 PDSCH)	30	99.999%	NLOS	4	99.9995%	4	99.9995%
2x2 SU-MIMO, 4os non-slot, Slot aggregation (1 PDCCH + 2 PDSCH)	30	99.999%	NLOS	2	99.9997%	2	99.9998%
16x4 SU-MIMO, 14os slot, One shot (1PDCCH + 1 PDSCH)	30	99.999%	NLOS	1	99.9999%	/	/
2x2 SU-MIMO 7os non-slot, One shot (1 PDCCH+2 PDSCH)	30	99.999%	NLOS	/	/	1	99.9999991%
2x2 SU-MIMO 14os slot, One-shot (1 PDCCH+1 PDSCH)	30	99.999%	NLOS	1	>99.9999%	1	>99.9999%

6.1.1.2 UL reliability

For uplink reliability, both evaluation configuration A (carrier frequency = 4 GHz) and evaluation configuration B (carrier frequency = 700 MHz) are evaluated.

The evaluation results of NR FDD for uplink reliability are provided in Table 6.1.1.2-1. All the evaluation results are derived with less than 100 MHz and 40 MHz bandwidth for evaluation configuration A (CF = 4 GHz) and B (CF = 700 MHz), respectively.

Table 6.1.1.2-1 Evaluation results of uplink reliability for NR FDD

(a) Evaluation configuration A (CF = 4 GHz)

Scheme and antenna configuration	Sub-carrier spacing [kHz]	ITU Requirement	Channel model A			Channel model B		
			Channel condition	Number of samples	Reliability	Channel condition	Number of samples	Reliability
1x16 SIMO, OFDMA, 14os slot, Grant free, One shot (1 PUSCH)	60	99.999%	NLOS	1	99.9999%	NLOS	1	99.99999%
8x32 SU-MIMO, OFDMA, 14os slot, Grant based, (1 PDCCH + 1 PUSCH)	30	99.999%	LOS	1	99.9999%	LOS	/	/
1x8 SIMO, OFDMA, 7os non-slot Grant free One short (1 PUSCH)	30	99.999%	NLOS	1	> 99.9999%	NLOS	2	99.9999%
1x2 SIMO, OFDMA, 4os non-slot Grant free, 2 repetitions (2 PUSCH)	30	99.999%	NLOS	1	99.999999992%	NLOS	1	99.9999999887%
1x8 SIMO, OFDMA, 14os slot, Grant free One shot (1 PUSCH)	30	99.999%	NLOS	/	/	NLOS	1	99.9992%
2x2 SU-MIMO, OFDMA, 4os non-slot Grant free, One shot (1 PUSCH)	30	99.999%	NLOS	1	99.99928%	NLOS	1	99.99974%
1x4 SIMO, OFDMA, 7os, Grant free, One-shot (1 PUSCH)	30	99.999%	NLOS	/	/	NLOS	1	99.9999999%
1x8 SIMO, OFDMA, 14os, Grant free, 2 repetitions (2 PUSCH)	30	99.999%	NLOS	1	99.999984%	NLOS	1	99.9999964%
1x8 SIMO, OFDMA, 14os, Grant free, One shot (1 PUSCH)	30	99.999%	NLOS	1	>99.9999%	NLOS	1	>99.9999%

(b) Evaluation configuration B (CF = 700 MHz)

Scheme and antenna configuration	Sub-carrier spacing [kHz]	ITU Requirement	Channel model A			Channel model B		
			Channel condition	Number of samples	Reliability	Channel condition	Number of samples	Reliability
1x8 SIMO, OFDMA, 14os slot, Grant free One shot (1 PUSCH)	30	99.999%	NLOS	1	99.99999%	NLOS	1	99.9999997%
1x2 SIMO, OFDMA, 7os non-slot, Grant free, 2 repetitions (2 PUSCH)	30	99.999%	NLOS	/	/	NLOS	1	99.999998%
2x2 SU-MIMO, OFDMA, 4os non-slot, Grant free, 2 repetitions (2 PUSCH)	30	99.999%	NLOS	1	99.99982%	NLOS	1	99.99979%
4x16 SU-MIMO, OFDMA, 14os slot, Grant based (1 PDCCH + 1 PUSCH)	30	99.999%	NLOS	1	99.9999%	NLOS	/	/
1x8 SIMO, OFDMA, 7os non-slot, Grant free, One shot (1 PUSCH)	30	99.999%	NLOS	1	> 99.9999%	NLOS	1	> 99.9999%
1x2 SIMO, OFDMA, 4os non-slot, Grant free, 2 repetitions (2 PUSCH)	30	99.999%	NLOS	1	99.99999999%	NLOS	1	99.99999999%
1x8 SIMO, OFDMA, 14os slot, Grant free, One shot (1 PUSCH, 8RB)	30	99.999%	NLOS	1	99.9993%	NLOS	1	99.9993%
1x8 SIMO, OFDMA, 14os slot, Grant free, One shot (1 PUSCH, 12RB)	30	99.999%	NLOS	1	99.9992%	NLOS	1	99.9992%
1x8 SIMO, OFDMA, 7os non-slot, One shot (1 PUSCH, 12RB)	30	99.999%	NLOS	1	99.9993%	NLOS	1	99.9993%
1x8 SIMO, OFDMA, 14os slot, Grant free, One shot (1 PUSCH)	30	99.999%	NLOS	/	/	NLOS	1	99.99967%
1x8 SIMO, OFDMA, 14os slot, Grant free, 2 repetitions (2 PUSCH)	30	99.999%	NLOS	1	99.9999999%	NLOS	/	/

1x2 SIMO, OFDMA, 14os one slot, Grant free, One shot(1 PUSCH)	30	99.999%	NLOS	/	>99.9999%	NLOS	1	>99.9999%
--	----	---------	------	---	-----------	------	---	-----------

The evaluation results of NR TDD for uplink reliability are provided in Table 6.1.1.2-2. All the evaluation results are derived with less than 100 MHz and 40 MHz bandwidth for evaluation configuration A (CF = 4 GHz) and B (CF = 700 MHz), respectively.

It is observed that NR fulfils the reliability requirement for uplink in a wide range of configurations.

Table 6.1.1.2-2 Evaluation results of uplink reliability for NR TDD

(a) Evaluation configuration A (CF = 4 GHz)

Scheme and antenna configuration	Sub-carrier spacing [kHz]	Frame structure	ITU Requirement	Channel model A			Channel model B		
				Channel condition	Number of samples	Reliability	Channel condition	Number of samples	Reliability
2x8 MIMO, OFDMA, 4os non-slot, Grant free, 2 repetitions (2 PUSCH)	60	0.5ms periodicity DL:UL=1:1	99.999%	NLOS	1	99.99999%	NLOS	/	/

(b) Evaluation configuration B (CF = 700 MHz)

Scheme and antenna configuration	Sub-carrier spacing [kHz]	Frame structure	ITU Requirement	Channel model A			Channel model B		
				Channel condition	Number of samples	Reliability	Channel condition	Number of samples	Reliability
2x8 MIMO, OFDMA, 4os non-slot, Grant free, 2 repetitions (2 PUSCH)	60	0.5ms periodicity DL:UL=1:1	99.999%	NLOS	1	99.9999958%	NLOS	/	/

6.2 Latency

6.2.1 User plane latency

6.2.1.1 NR

NR user plane latency for URLLC is evaluated based on the procedures and parameters as described in Section 5.7.1.1.

The evaluation results are shown in Section 5.7.1.1. It is observed that under a wide range of configurations NR fulfills both downlink and uplink user plane latency requirement of 1 ms for URLLC.

6.2.1.2 LTE

LTE user plane latency for URLLC is evaluated based on the procedures and parameters as described in Section 5.7.1.2.

The evaluation results are shown in Section 5.7.1.2. It is observed that LTE fulfills downlink and uplink user plane latency requirement of 1 ms for URLLC with FDD using 2 OFDM symbol and 3 OFDM symbol TTI duration.

6.2.2 Control plane latency

Based on the evaluation results shown in Section 5.7.2, the control plane latency requirement is fulfilled by NR and LTE.

6.3 Mobility interruption time

Based on the evaluation results shown in Section 5.10, the mobility interruption time requirement is fulfilled by NR and LTE.

7 Self evaluation of mMTC technical performance

7.1 Connection density

As specified in Report ITU-R M.2410 [4], connection density is the system capacity metric defined as the total number of devices fulfilling a specific quality of service (QoS) per unit area (per km²) with 99% grade of service (GoS).

In Report ITU-R M.2412 [6], the required QoS is that a 32-byte packet is successfully received within 10 s.

The connection density can be evaluated using one or both of two alternative methods: The Full-buffer system-level simulation followed by link level simulation, and the Non-full-buffer system level simulation. These are defined in section 7.1.3 of Report ITU-R M.2412 [6]. The detailed assumptions for these approaches, including system level configurations and traffic model, are defined in Table 5 – d) in Report ITU-R M.2412 [6].

7.1.1 NR

The connection density of NR is evaluated by using the full buffer system level simulation followed by link level simulation (referred to as “full buffer system level simulation” below).

In a first step this evaluation method employs a full buffer system level simulation to derive the uplink SINR distribution for a candidate technology. In a second step link level simulation are performed to determine the uplink spectral efficiency and data rate as functions of SINR. When combined these three functions supports the calculation of the expected long-term time-frequency resources required for each SINR to support the specified traffic model.

Connection density is in a final step conceptually derived by the system bandwidth, declared for the candidate technology, divided by the average required frequency resource. The requirement is fulfilled if the recorded connection density exceeds the 1.000.000 devices/km², while the time resource, i.e. the packet delay, at the 99th percentile SINR is less than 10 s.

This evaluation method is targeted to evaluate the connection density in terms of the capability of uplink data transmission. The capacity calculation is based on an assumption of ideal resource allocation among the multiple packets and users (e.g., there is no collision on resource allocation). The packet delay calculation does not consider the delays introduced by the connection access procedure.

Under this evaluation method, NR FDD is evaluated. The Urban Macro – mMTC test environment is used for evaluation. Both evaluation configuration A (ISD=500 m) and evaluation configuration B (ISD=1732 m) are considered.

The evaluation results of NR FDD are shown in Table 7.1.1-1 expressed as the average performance presented by the contributing companies. It is observed that NR fulfills connection density requirement under full buffer system level simulation followed by link level simulation. Detailed simulation assumptions and results can be found in Annex B.4.5.

**Table 7.1.1-1 Evaluation results of connection density for NR FDD
(Full buffer system level simulation followed by link level simulation
packet arrival rate: 1 packet / 2 hour / device)**

(a) Evaluation configuration A (ISD=500 m)

Scheme and antenna configuration	Sub-carrier spacing	ITU Requirement (device/km ²)	Channel model A			Channel model B		
			Number of samples	Connection density (device/km ²)	Required bandwidth (kHz)	Number of samples	Connection density (device/km ²)	Required bandwidth (kHz)
1x2 SIMO OFDMA	15 kHz	1,000,000	4	36,323,844	180	4	36,007,832	180

(b) Evaluation configuration B (ISD=1 732 m)

Scheme and antenna configuration	Sub-carrier spacing	ITU Requirement (device/km ²)	Channel model A			Channel model B		
			Number of samples	Connection density (device/km ²)	Required bandwidth (kHz)	Number of samples	Connection density (device/km ²)	Required bandwidth (kHz)
1x2 SIMO OFDMA	15 kHz	1,000,000	4	1,267,406	180	4	1,503,394	180

7.1.2 LTE

The connection density of NB-IoT and eMTC are evaluated using both the full buffer, and the non-full buffer system level simulation as defined in Report ITU-R M.2412 [6].

As indicated in Section 7.1.1, the full buffer system level simulation method targets to evaluate the connection density in terms of the capability of uplink data transmission. It does also not model synchronization and system information acquisition, control channel and downlink data channel performance. It assumes ideal resource allocation among the multiple uplink packets and users (e.g., there is no collision on resource allocation), and the delays introduced by access procedure are not considered.

In the non-full buffer system level simulation, the idle mode synchronization and system information acquisition performance and delays are taken into account. The chosen system access procedure, the uplink data transmission and the connection release procedures are modelled. The link level performance of all relevant physical channels and signals are modelled, and the system level resource allocation and the delays associated with the modeled protocols are considered. The connection density is recorded at the user arrival rate at which 99% of all uplink packet is successfully received within 10s.

Since the non-full buffer system level simulation provides a more detailed level of modelling the evaluation results are, as expected, different from the full buffer system level simulation.

For both evaluation methods, the Urban Macro – mMTC test environment is used. Both evaluation configuration A (ISD=500 m) and evaluation configuration B (ISD=1732 m) are considered.

The evaluation results of NB-IoT and eMTC are shown in Table 7.1.2-1 for full buffer system level simulation, and in Table 7.1.2-2 for non-full buffer system level simulation, respectively. For non-full buffer system level simulation, both the Early Data Transmission (EDT) and the RRC Resume procedures are evaluated. Since EDT procedure is shortened compared to RRC Resume procedure, the evaluation results are different.

In addition to the required bandwidths presented in Table 7.1.2-1 and Table 7.1.2-2, eMTC requires 2 PRBs to be configured at the edges of the configured LTE system bandwidth for supporting PUCCH transmissions. Overhead from (N)PSS, (N)SSS, (N)PBCH or (N)PDSCH system information broadcast is also not accounted for in the reported bandwidths. For NB-IoT a reasonable assumption is that the overhead from NPSS, NSSS, NPBCH and SIB1-NB transmissions constitutes ~30% of one downlink PRB. For LTE-M the corresponding overhead is approximately ~40% of one downlink narrowband.

It is observed that both NB-IoT and eMTC fulfill connection density requirement under either evaluation method, using either system access procedures.

Detailed simulation assumptions and results can be found in Annex B.4.5.

**Table 7.1.2-1 Evaluation results of connection density for NB-IoT and eMTC
(Full buffer system level simulation followed by link level simulation
packet arrival rate: 1 packet / 2 hour / device)**

(a) Evaluation configuration A (ISD=500 m)

Technical feature	Scheme and antenna configuration	Sub-carrier spacing	ITU Requirement (device/km ²)	Channel model A			Channel model B		
				Number of samples	Connection density (device/km ²)	Required bandwidth (kHz)	Number of samples	Connection density (device/km ²)	Required bandwidth (kHz)
NB-IoT	1x2 SIMO	15 kHz	1,000,000	2	43,691,789	180	2	43,626,653	180
eMTC	1x2 SIMO	15 kHz	1,000,000	3	35,235,516	180	3	34,884,438	180

(b) Evaluation configuration B (ISD=1 732 m)

Technical feature	Scheme and antenna configuration	Sub-carrier spacing	ITU Requirement (device/km ²)	Channel model A			Channel model B		
				Number of samples	Connection density (device/km ²)	Required bandwidth (kHz)	Number of samples	Connection density (device/km ²)	Required bandwidth (kHz)
NB-IoT	1x2 SIMO	15 kHz	1,000,000	3	2,335,319	180	3	2,332,680	180
eMTC	1x2 SIMO	15 kHz	1,000,000	3	1,212,909	180	3	1,511,989	180

**Table 7.1.2-2 Evaluation results of connection density for NB-IoT and eMTC
(Non-full buffer system level simulation
packet arrival rate: 1 packet / 2 hour / device)**

(a) Evaluation configuration A (ISD=500 m)

Technical feature	Scheme and antenna configuration	Sub-carrier spacing	ITU Requirement (device/km ²)	Channel model A			Channel model B		
				Number of samples	Connection density (device/km ²)	Required bandwidth (kHz)	Number of samples	Connection density (device/km ²)	Required bandwidth (kHz)
NB-IoT (EDT)	1x2 SIMO, Single-tone	15 kHz	1,000,000	1	8,047,087	180	1	8,077,017	180
NB-IoT (EDT)	1x2 SIMO, Multi-tone	15 kHz	1,000,000	-	-	-	1	16,000,000	180
NB-IoT (RRC Resume)	1x2 SIMO Multi-tone	15 kHz	1,000,000	1	1,233,000	180	1	1,225,000	180
eMTC (RRC Resume)	1x2 SIMO	15 kHz	1,000,000	1	5,680,000	1080	1	5,680,000	1080

(b) Evaluation configuration B (ISD=1 732m)

Technical feature	Scheme and antenna configuration	Sub-carrier spacing	ITU Requirement (device/km ²)	Channel model A			Channel model B		
				Number of samples	Connection density (device/km ²)	Required bandwidth (kHz)	Number of samples	Connection density (device/km ²)	Required bandwidth (kHz)
NB-IoT (EDT)	1x2 SIMO, Single-tone	15 kHz	1,000,000	1	1,198,000	360	1	1,203,880	360
NB-IoT (EDT)	1x2 SIMO Multi-tone	15 kHz	1,000,000	-	-	-	1	1,250,000	360
NB-IoT (RRC Resume)	1x2 SIMO Multi-tone	15 kHz	1,000,000	1	1,018,000	2700	1	1,034,000	1980
eMTC (EDT)	1x2 SIMO	15 kHz	1,000,000	1	1,107,000	540	1	1,140,000	540
eMTC (RRC Resume)	1x2 SIMO	15 kHz	1,000,000	1	1,026,000	3240	1	1,335,000	3240

8 Self evaluation of generic requirements

8.1 Bandwidth and scalability

As defined in Report ITU-R M.2410 [4], bandwidth is the maximum aggregated system bandwidth. The bandwidth may be supported by single or multiple radio frequency (RF) carriers.

Scalable bandwidth is the ability of the candidate RIT/SRIT to operate with different bandwidths.

8.1.1 NR

The capability of bandwidth and bandwidth scalability for NR are evaluated.

According to Section 5.3.2 of TS 38.104 [15], the maximum bandwidth related to specific sub-carrier spacing (SCS) and frequency range (FR) for a component carrier is provided in Table 8.1.1-1. Besides, according to Section 6.4 of TS38.331 [16], carrier aggregation of up to sixteen component carriers is supported by NR Rel-15. Accordingly, the NR capability of maximum aggregated system bandwidth is presented in Table 8.1.1-1. It is observed that the maximum aggregated bandwidth for FR 1 is 800 MHz to 1 600 MHz; while for FR 2, the maximum aggregated bandwidth is 3 200 MHz to 6 400 MHz. Therefore the bandwidth requirement of at least 100 MHz is met by NR Rel-15 under all frequency ranges for all sub-carrier spacing values.

Table 8.1.1-1 NR capability on bandwidth

	SCS [kHz]	Maximum bandwidth for one component carrier (MHz)	Maximum number of component carriers for carrier aggregation	Maximum aggregated bandwidth (MHz)
FR1	15	50	16	800
	30	100	16	1600
	60	100	16	1600
FR2	60	200	16	3200
	120	400	16	6400

According to Section 5.3.2 of TS 38.104 [15], different bandwidths are supported for a component carrier at given SCS as listed in Table 8.1.1-2. Accordingly, the bandwidth scalability capability of NR Rel-15 is summarized in Table 8.1.1-3. It is observed that up to 12 different bandwidths are supported for FR 1, and up to 4 different bandwidths are supported for FR 2. Therefore bandwidth scalability capability is fulfilled by NR Rel-15.

Table 8.1.1-2 Transmission bandwidth configuration N_{RB} in NR

(a) For FR1

SCS (kHz)	5MHz	10MHz	15MHz	20 MHz	25 MHz	30 MHz	40 MHz	50MHz	60 MHz	70 MHz	80 MHz	90 MHz	100 MHz
	N_{RB}	N_{RB}	N_{RB}	N_{RB}	N_{RB}	N_{RB}	N_{RB}	N_{RB}	N_{RB}	N_{RB}	N_{RB}	N_{RB}	N_{RB}
15	25	52	79	106	133	160	216	270	N/A	N.A	N/A	N/A	N/A
30	11	24	38	51	65	78	106	133	162	189	217	245	273
60	N/A	11	18	24	31	38	51	65	79	93	107	121	135

(b) For FR2

SCS [kHz]	50 MHz	100 MHz	200 MHz	400 MHz
	N_{RB}	N_{RB}	N_{RB}	N_{RB}
60	66	132	264	N.A
120	32	66	132	264

Table 8.1.1-3 Bandwidth scalability capability for NR

	SCS [kHz]	Minimum component carrier bandwidth (MHz)	Maximum component carrier bandwidth (MHz)	Maximum Number of supported bandwidth for a component carrier
FR1	15	5	50	8
	30	5	100	13

	60	10	100	12
FR2	60	50	200	3
	120	50	400	4

8.1.2 LTE

The capability of bandwidth and bandwidth scalability for LTE are evaluated.

According to Section 5.6 of TS 36.101 [17], the maximum bandwidth of a component carrier is 20 MHz for LTE. Besides, according to Section 6.4 of TS 36.331 [18], carrier aggregation of up to thirty-two component carriers is supported by LTE Rel-15. Accordingly, LTE Rel-15 reaches the capability of maximum aggregated system bandwidth of 640 MHz. Therefore the bandwidth requirement of at least 100 MHz is met by LTE Rel-15.

Table 8.1.2-1 LTE capability on bandwidth

Maximum bandwidth for one component carrier (MHz)	Maximum number of component carriers for carrier aggregation	Maximum aggregated bandwidth (MHz)
20	32	640

According to Section 5.6 of TS 36.101 [17], six different bandwidths are supported for a component carrier, as shown in Table 8.1.2-2. Therefore bandwidth scalability capability is fulfilled by LTE Rel-15.

Table 8.1.2-2: Transmission bandwidth configuration N_{RB} in LTE

Channel bandwidth $BW_{Channel}$ [MHz]	1.4	3	5	10	15	20
Transmission bandwidth configuration N_{RB}	6	15	25	50	75	100

8.2 Spectrum

As defined in Report ITU-R M.2411 [5], spectrum requirement include

- The capability of being able to utilize at least one frequency band identified for IMT in the ITU Radio Regulations, and
- The capability of being able to utilize the higher frequency range/band(s) above 24.25 GHz (NOTE: In the case of the candidate SRIT, at least one of the component RITs need to fulfil this requirement.).

8.2.1 NR

The bands in which NR can be deployed are given in Table 8.2.1-1 and Table 8.2.1-2 according to TS 38.104 [15]. It is observed that NR Rel-15 can support at least one frequency band for IMT, as well as to utilize the higher frequency range/bands above 24.25 GHz. Therefore NR Rel-15 fulfils spectrum requirement.

Table 8.2.1-1: NR operating bands in FR1

NR operating band	Uplink (UL) operating band BS receive / UE transmit	Downlink (DL) operating band BS transmit / UE receive	Duplex Mode
	F _{UL_low} – F _{UL_high}	F _{DL_low} – F _{DL_high}	
n1	1920 MHz – 1980 MHz	2110 MHz – 2170 MHz	FDD
n2	1850 MHz – 1910 MHz	1930 MHz – 1990 MHz	FDD
n3	1710 MHz – 1785 MHz	1805 MHz – 1880 MHz	FDD
n5	824 MHz – 849 MHz	869 MHz – 894 MHz	FDD
n7	2500 MHz – 2570 MHz	2620 MHz – 2690 MHz	FDD
n8	880 MHz – 915 MHz	925 MHz – 960 MHz	FDD
n12	699 MHz – 716 MHz	729 MHz – 746 MHz	FDD
n20	832 MHz – 862 MHz	791 MHz – 821 MHz	FDD
n25	1850 MHz – 1915 MHz	1930 MHz – 1995 MHz	FDD
n28	703 MHz – 748 MHz	758 MHz – 803 MHz	FDD
n34	2010 MHz – 2025 MHz	2010 MHz – 2025 MHz	TDD
n38	2570 MHz – 2620 MHz	2570 MHz – 2620 MHz	TDD
n39	1880 MHz – 1920 MHz	1880 MHz – 1920 MHz	TDD
n40	2300 MHz – 2400 MHz	2300 MHz – 2400 MHz	TDD
n41	2496 MHz – 2690 MHz	2496 MHz – 2690 MHz	TDD
n51	1427 MHz – 1432 MHz	1427 MHz – 1432 MHz	TDD
n66	1710 MHz – 1780 MHz	2110 MHz – 2200 MHz	FDD
n70	1695 MHz – 1710 MHz	1995 MHz – 2020 MHz	FDD
n71	663 MHz – 698 MHz	617 MHz – 652 MHz	FDD
n75	N/A	1432 MHz – 1517 MHz	SDL
n76	N/A	1427 MHz – 1432 MHz	SDL
n77	3300 MHz – 4200 MHz	3300 MHz – 4200 MHz	TDD
n78	3300 MHz – 3800 MHz	3300 MHz – 3800 MHz	TDD
n79	4400 MHz – 5000 MHz	4400 MHz – 5000 MHz	TDD
n80	1710 MHz – 1785 MHz	N/A	SUL
n81	880 MHz – 915 MHz	N/A	SUL
n82	832 MHz – 862 MHz	N/A	SUL
n83	703 MHz – 748 MHz	N/A	SUL
n84	1920 MHz – 1980 MHz	N/A	SUL
n86	1710 MHz – 1780 MHz	N/A	SUL

Table 8.2.1-2: NR operating bands in FR2

NR operating band	Uplink (UL) and Downlink (DL) operating band BS transmit/receive UE transmit/receive	Duplex Mode
	F _{UL_low} – F _{UL_high} F _{DL_low} – F _{DL_high}	
n257	26500 MHz – 29500 MHz	TDD
n258	24250 MHz – 27500 MHz	TDD
n260	37000 MHz – 40000 MHz	TDD
n261	27500 MHz – 28350 MHz	TDD

8.2.2 LTE

The bands in which LTE can be deployed are given in Table 8.2.2-1 according to TS 36.101 [17]. It is observed that LTE Rel-15 can support at least one frequency band for IMT. Therefore LTE Rel-15 fulfils the spectrum requirement of being able to utilize at least one frequency band identified for IMT in the ITU Radio Regulations.

Table 8.2.2-1 LTE (E-UTRA) operating bands

E-UTRA Operating Band	Uplink (UL) operating band BS receive UE transmit	Downlink (DL) operating band BS transmit UE receive	Duplex Mode
	F _{UL_low} – F _{UL_high}	F _{DL_low} – F _{DL_high}	
1	1920 MHz – 1980 MHz	2110 MHz – 2170 MHz	FDD
2	1850 MHz – 1910 MHz	1930 MHz – 1990 MHz	FDD
3	1710 MHz – 1785 MHz	1805 MHz – 1880 MHz	FDD
4	1710 MHz – 1755 MHz	2110 MHz – 2155 MHz	FDD
5	824 MHz – 849 MHz	869 MHz – 894MHz	FDD
6 ¹	830 MHz – 840 MHz	875 MHz – 885 MHz	FDD
7	2500 MHz – 2570 MHz	2620 MHz – 2690 MHz	FDD
8	880 MHz – 915 MHz	925 MHz – 960 MHz	FDD
9	1749.9 MHz – 1784.9 MHz	1844.9 MHz – 1879.9 MHz	FDD
10	1710 MHz – 1770 MHz	2110 MHz – 2170 MHz	FDD
11	1427.9 MHz – 1447.9 MHz	1475.9 MHz – 1495.9 MHz	FDD
12	699 MHz – 716 MHz	729 MHz – 746 MHz	FDD
13	777 MHz – 787 MHz	746 MHz – 756 MHz	FDD
14	788 MHz – 798 MHz	758 MHz – 768 MHz	FDD
15	Reserved	Reserved	FDD
16	Reserved	Reserved	FDD
17	704 MHz – 716 MHz	734 MHz – 746 MHz	FDD
18	815 MHz – 830 MHz	860 MHz – 875 MHz	FDD
19	830 MHz – 845 MHz	875 MHz – 890 MHz	FDD
20	832 MHz – 862 MHz	791 MHz – 821 MHz	FDD
21	1447.9 MHz – 1462.9 MHz	1495.9 MHz – 1510.9 MHz	FDD
22	3410 MHz – 3490 MHz	3510 MHz – 3590 MHz	FDD
23 ¹	2000 MHz – 2020 MHz	2180 MHz – 2200 MHz	FDD
24	1626.5 MHz – 1660.5 MHz	1525 MHz – 1559 MHz	FDD
25	1850 MHz – 1915 MHz	1930 MHz – 1995 MHz	FDD
26	814 MHz – 849 MHz	859 MHz – 894 MHz	FDD
27	807 MHz – 824 MHz	852 MHz – 869 MHz	FDD
28	703 MHz – 748 MHz	758 MHz – 803 MHz	FDD
29	N/A	717 MHz – 728 MHz	FDD ²
30 ¹⁵	2305 MHz – 2315 MHz	2350 MHz – 2360 MHz	FDD
31	452.5 MHz – 457.5 MHz	462.5 MHz – 467.5 MHz	FDD
32	N/A	1452 MHz – 1496 MHz	FDD ²
33	1900 MHz – 1920 MHz	1900 MHz – 1920 MHz	TDD
34	2010 MHz – 2025 MHz	2010 MHz – 2025 MHz	TDD
35	1850 MHz – 1910 MHz	1850 MHz – 1910 MHz	TDD
36	1930 MHz – 1990 MHz	1930 MHz – 1990 MHz	TDD
37	1910 MHz – 1930 MHz	1910 MHz – 1930 MHz	TDD
38	2570 MHz – 2620 MHz	2570 MHz – 2620 MHz	TDD
39	1880 MHz – 1920 MHz	1880 MHz – 1920 MHz	TDD
40	2300 MHz – 2400 MHz	2300 MHz – 2400 MHz	TDD
41	2496 MHz – 2690 MHz	2496 MHz – 2690 MHz	TDD
42	3400 MHz – 3600 MHz	3400 MHz – 3600 MHz	TDD
43	3600 MHz – 3800 MHz	3600 MHz – 3800 MHz	TDD
44	703 MHz – 803 MHz	703 MHz – 803 MHz	TDD
45	1447 MHz – 1467 MHz	1447 MHz – 1467 MHz	TDD
46	5150 MHz – 5925 MHz	5150 MHz – 5925 MHz	TDD ⁸
47	5855 MHz – 5925 MHz	5855 MHz – 5925 MHz	TDD ¹¹
48	3550 MHz – 3700 MHz	3550 MHz – 3700 MHz	TDD
49	3550 MHz – 3700 MHz	3550 MHz – 3700 MHz	TDD ¹⁶
50	1432 MHz - 1517 MHz	1432 MHz - 1517 MHz	TDD ¹³
51	1427 MHz - 1432 MHz	1427 MHz - 1432 MHz	TDD ¹³
52	3300 MHz - 3400 MHz	3300 MHz - 3400 MHz	TDD
...			

64	Reserved				
65	1920 MHz – 2010 MHz	2110 MHz – 2200 MHz		FDD	
66	1710 MHz – 1780 MHz	2110 MHz – 2200 MHz		FDD ⁴	
67	N/A	738 MHz – 758 MHz		FDD ²	
68	698 MHz – 728 MHz	753 MHz – 783 MHz		FDD	
69	N/A	2570 MHz – 2620 MHz		FDD ²	
70	1695 MHz – 1710 MHz	1995 MHz – 2020 MHz		FDD ¹⁰	
71	663 MHz – 698 MHz	617 MHz – 652 MHz		FDD	
72	451 MHz – 456 MHz	461 MHz – 466 MHz		FDD	
73	450 MHz – 455 MHz	460 MHz – 465 MHz		FDD	
74	1427 MHz – 1470 MHz	1475 MHz – 1518 MHz		FDD	
75	N/A	1432 MHz – 1517 MHz		FDD ²	
76	N/A	1427 MHz – 1432 MHz		FDD ²	
85	698 MHz – 716 MHz	728 MHz – 746 MHz		FDD	
<p>NOTE 1: Band 6, 23 is not applicable</p> <p>NOTE 2: Restricted to E-UTRA operation when carrier aggregation is configured. The downlink operating band is paired with the uplink operating band (external) of the carrier aggregation configuration that is supporting the configured Pcell.</p> <p>NOTE 3: A UE that complies with the E-UTRA Band 65 minimum requirements in this specification shall also comply with the E-UTRA Band 1 minimum requirements.</p> <p>NOTE 4: The range 2180-2200 MHz of the DL operating band is restricted to E-UTRA operation when carrier aggregation is configured.</p> <p>NOTE 5: A UE that supports E-UTRA Band 66 shall receive in the entire DL operating band</p> <p>NOTE 6: A UE that supports E-UTRA Band 66 and CA operation in any CA band shall also comply with the minimum requirements specified for the DL CA configurations CA_66B, CA_66C and CA_66A-66A.</p> <p>NOTE 7: A UE that complies with the E-UTRA Band 66 minimum requirements in this specification shall also comply with the E-UTRA Band 4 minimum requirements.</p> <p>NOTE 8: This band is an unlicensed band restricted to licensed-assisted operation using Frame Structure Type 3</p> <p>NOTE 9: In this version of the specification, restricted to E-UTRA DL operation when carrier aggregation is configured.</p> <p>NOTE 10: The range 2010-2020 MHz of the DL operating band is restricted to E-UTRA operation when carrier aggregation is configured and TX-RX separation is 300 MHz The range 2005-2020 MHz of the DL operating band is restricted to E-UTRA operation when carrier aggregation is configured and TX-RX separation is 295 MHz.</p> <p>NOTE 11: This band is unlicensed band used for V2X communication. There is no expected network deployment in this band so both Frame Structure Type 1 and Frame Structure Type 2 can be used.</p> <p>NOTE 12: A UE that complies with the E-UTRA Band 74 minimum requirements in this specification shall also comply with the E-UTRA Band 11 and Band 21 minimum requirements.</p> <p>NOTE 13: UE that complies with the E-UTRA Band 50 minimum requirements in this specification shall also comply with the E-UTRA Band 51 minimum requirements.</p> <p>NOTE 14: A UE that complies with the E-UTRA Band 75 minimum requirements in this specification shall also comply with the E-UTRA Band 76 minimum requirements.</p> <p>NOTE 15: Uplink transmission is not allowed at this band for UE with external vehicle-mounted antennas.</p> <p>NOTE 16: This band is restricted to licensed-assisted operation using Frame Structure Type 3</p>					

8.3 Service

According to Report ITU-R M.2411 [5], the support for wide range of services should be inspected by the following questions:

- Is the proposal able to support a range of services across different usage scenarios (eMBB, URLLC, and mMTC)?
- Specify which usage scenarios (eMBB, URLLC, and mMTC) the candidate RIT or candidate SRIT can support.

The evaluation method is defined in Report ITU-R M.2412 [6], and the support of a wide range of services is verified by inspection of the candidate RITs/SRITs ability to meet the minimum technical performance requirements for various usage scenarios and their associated test environments.

Based on the self evaluation results in Section 5 to 7, it is observed that NR RIT can meet the minimum technical performance requirements for the five test environments in eMBB, URLLC and mMTC, and LTE RIT can at least meet the minimum technical performance requirements for the four test environments in eMBB and mMTC. Therefore, both NR and LTE RIT can fulfil the service requirements.

9 Conclusion

Based on the self evaluation results presented through Section 5 to 8, NR RIT fulfils all technical performance requirements in the five test environments: Indoor Hotspot – eMBB, Dense Urban – eMBB, Rural – eMBB, Urban Macro – URLLC and Urban Macro – mMTC. LTE RIT fulfils the technical performance requirements in at least four test environments: Indoor Hotspot – eMBB, Dense Urban – eMBB, Rural – eMBB, Urban Macro – mMTC.

Both NR RIT and LTE RIT fulfils the spectrum requirement. NR RIT can support the frequency bands identified for IMT in the ITU Radio Regulations, as well as the higher frequency range/band(s) above 24.25 GHz. LTE RIT can support the frequency bands identified for IMT in the ITU Radio Regulations.

Both NR RIT and LTE RIT fulfils service requirements.

It is therefore concluded that

- 3GPP's 5G SRIT can meet IMT-2020 requirements.
- 3GPP's 5G NR RIT can meet IMT-2020 requirements

Annex A: Calibration for self evaluation

To facilitate the self evaluation towards IMT-2020 submission, the system level simulators have been calibrated to ensure the results from different 3GPP entities are comparable.

The following metrics are selected for calibration of self evaluation:

- DL Geometry (wideband SINR)
- Coupling gain

The cell association mechanisms as defined in calibration assumptions are used to derive the above metrics, including multi-path based UE attachment model, and analog beamforming (BF) model, etc. Detailed calibration parameters and assumptions are found in Section 4 of RP-180524. It should be noted that these parameters are used for calibration purpose only.

The calibration was conducted to the corresponding evaluation configurations of Indoor Hotspot – eMBB, Dense Urban – eMBB, Rural – eMBB, Urban Macro – mMTC, and Urban Macro - URLLC test environment as defined in Report ITU-R M.2412 [6]. The two channel model variants (channel model A and channel model B) are applied in the calibration.

Twenty-one 3GPP entities provided the calibration results, including CATR, CATT, CEWiT, China Telecom, CMCC, Ericsson, Huawei, Intel, ITRI, LG Electronics, MediaTek, Motorola Mobility/Lenovo, NEC, Nokia, NTT DOCOMO, OPPO, Qualcomm, Samsung, Sharp, vivo and ZTE.

The calibration results for the five test environments are shown through Figure A.1 to Figure A.5, respectively. The results are based on the average of the independent results from the simulators of the contributing entities. The results of DL geometry (wideband SINR) from the independent samples are typically within 1~2 dB of the average SINR.

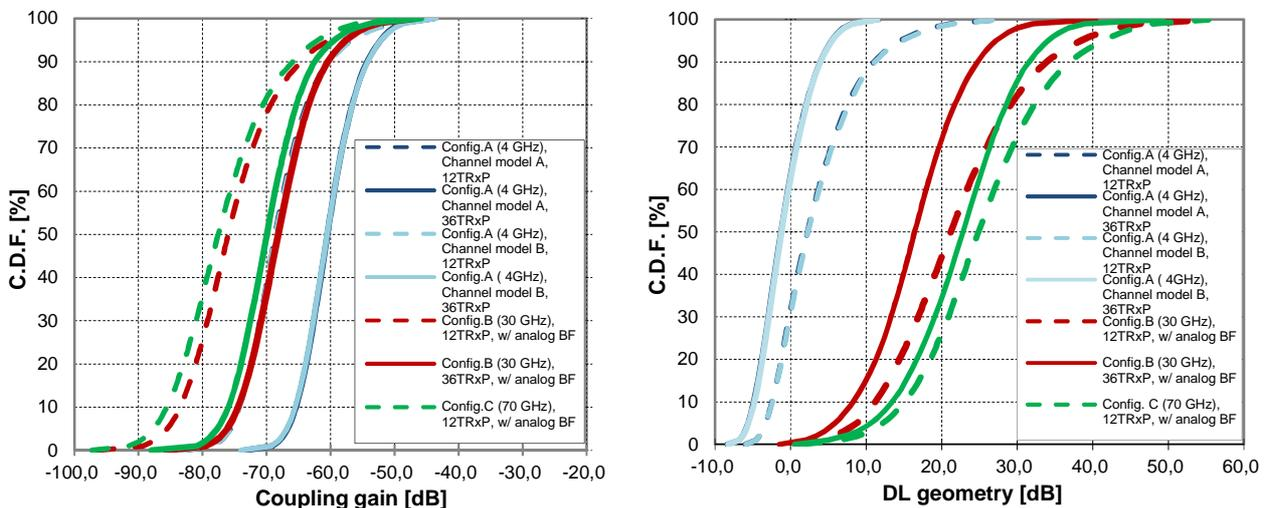

Figure A.1 Coupling gain and DL geometry of Indoor Hotspot - eMBB test environment

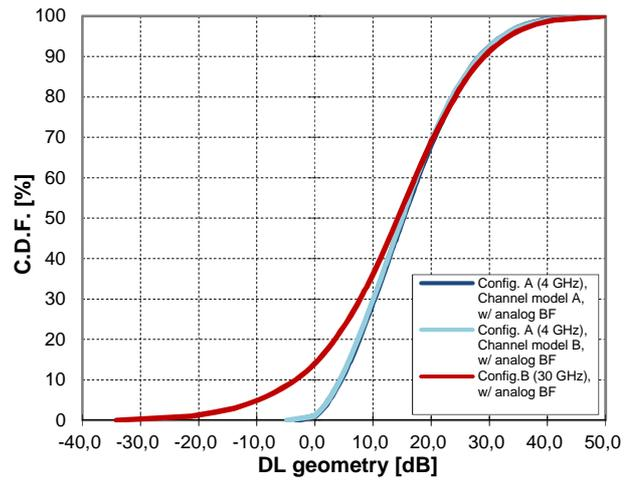
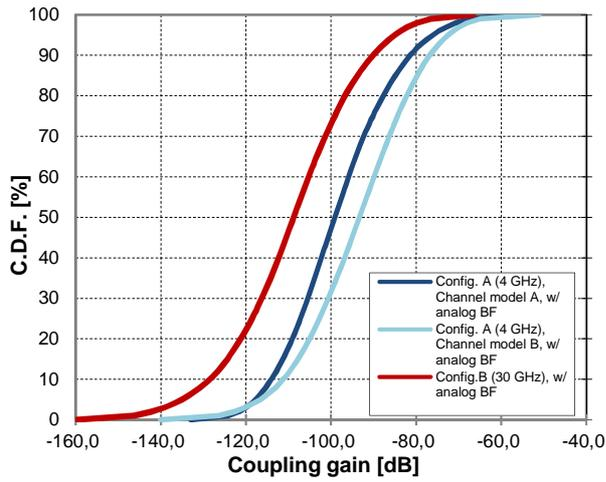

Figure A.2 Coupling gain and DL geometry of Dense Urban - eMBB test environment

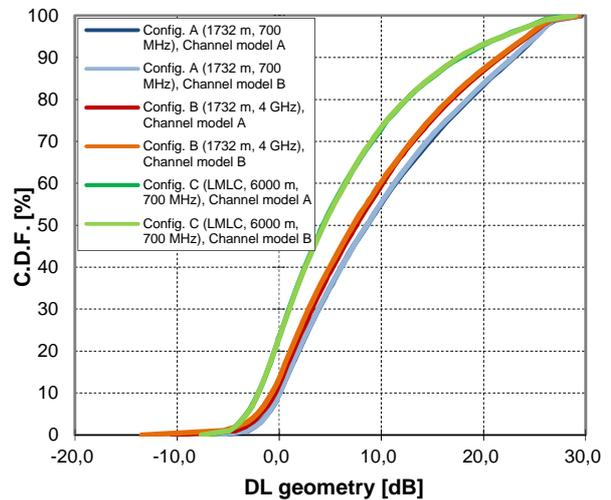
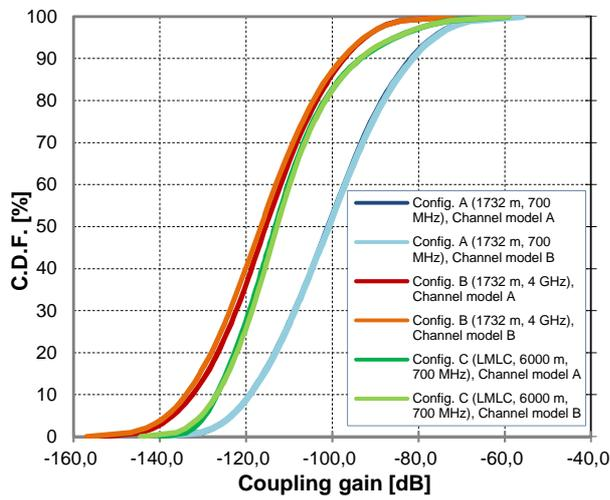

Figure A.3 Coupling gain and DL geometry of Rural - eMBB test environment

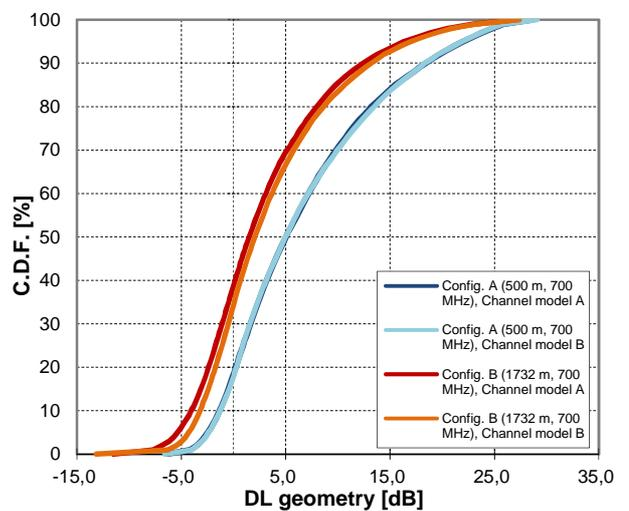
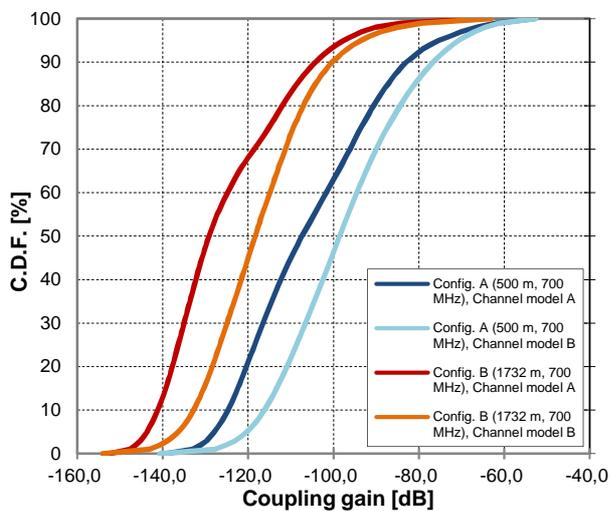

Figure A.4 Coupling gain and DL geometry of Urban Macro - mMTC test environment

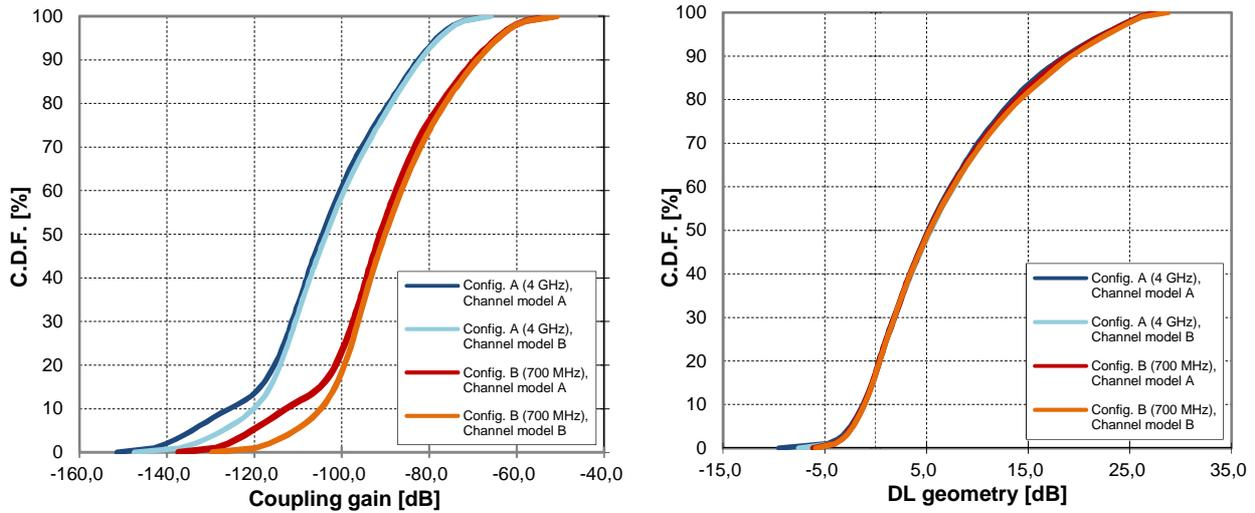

Figure A.5 Coupling gain and DL geometry of Urban Macro - URLLC test environment

A summary of the collected samples for calibration of each test environment and evaluation configuration is shown in Table A.1.

Table A.1 Sample statistics for ITU-R test environments

Test environment	Evaluation configuration	Channel model / Topology		Number of samples	DL wideband SINR difference compared to average SINR (at 50%-tile CDF point)
		Channel model	Topology		
Indoor Hotspot - eMBB	Config. A (4 GHz)	Channel model A	12TRxP	16	<0.8 dB
			36TRxP	15	<0.5 dB
	Config. B (30 GHz)	Channel model A/B	12TRxP	17	<2.2 dB
			36TRxP	14	<2.2 dB
	Config. C (70 GHz)	Channel model A/B	12TRxP	16	<1.6 dB
			36TRxP	12	<1.9 dB
Dense Urban - eMBB	Config. A (4 GHz)	Channel model A	16	<1.3 dB	
		Channel model B	18	<1.3 dB	
	Config. B (30 GHz)	Channel model A/B	18	<2.4 dB	
Rural - eMBB	Config. A (1732 m, 700 MHz)	Channel model A	18	<0.8 dB	
		Channel model B	20	<0.9 dB	
	Config. B (1732 m, 4 GHz)	Channel model A	18	<0.9 dB	
		Channel model B	20	<1.2 dB	
	Config. C (LMLC, 6000 m, 700 MHz)	Channel model A	15	<0.9 dB	
		Channel model B	16	<1.0 dB	
Urban Macro - mMTC	Config. A (500 m, 700 MHz)	Channel model A	15	<0.9 dB	
		Channel model B	16	<0.6 dB	
	Config. B (1732 m, 700 MHz)	Channel model A	15	<1.2 dB	
		Channel model B	16	<0.6 dB	
Urban Macro - URLLC	Config. A (4 GHz)	Channel model A	15	<0.9 dB	
		Channel model B	17	<1.0 dB	
	Config. B (700 MHz)	Channel model A	15	<0.9 dB	
		Channel model B	16	<1.3 dB	

Annex B: Simulation models and assumptions

B.1 Calculation of pre-processing SINR

Pre-processing SINR is used for mobility evaluation for SU-MIMO.

The pre-processing SINR is defined on an Rx antenna port with respect to a Tx antenna port.

The following pre-processing SINR formula can be used for a system comprising of S Tx antenna ports (TXRUs) and U Rx antenna ports (TXRUs),

$$SINR_{pre-proc} = \frac{\bar{P}_r}{\bar{P}_{I+N}} \quad (\text{B.1-1})$$

where \bar{P}_r is the average received signal power as given by (B.1-2), and \bar{P}_{I+N} is the average interference plus noise power as given by (B.1-3).

The average received signal power \bar{P}_r is over the S Tx antenna ports and U Rx antenna ports (similar to (8.1-1) in TR 36.873 [19]) that are expressed as

$$\bar{P}_r \approx \frac{1}{S} \sum_{p=1}^S RSRP_p = \frac{1}{S} \sum_{p=1}^S \left(PL \cdot SF \cdot \sum_{u=1}^U \left(|\alpha_{0,u,p}|^2 + \sum_{n=1}^N \sum_{m=1}^M |\alpha_{n,m,u,p}|^2 \right) \cdot \frac{TX_{power}}{U} \right) \quad (\text{B.1-2})$$

where N is the number of paths and M is the number of sub-paths within one path; for NLOS path for $n=1, \dots, N$,

$$\alpha_{n,m,u,p} = \sqrt{\frac{P_n}{M(K_R + 1)}} \begin{bmatrix} F_{rx,u,\theta}(\theta_{n,m,ZOA}, \phi_{n,m,AOA}) \\ F_{rx,u,\phi}(\theta_{n,m,ZOA}, \phi_{n,m,AOA}) \end{bmatrix}^T \begin{bmatrix} \exp(j\Phi_{n,m}^{\theta\theta}) & \sqrt{\kappa_{n,m}^{-1}} \exp(j\Phi_{n,m}^{\theta\phi}) \\ \sqrt{\kappa_{n,m}^{-1}} \exp(j\Phi_{n,m}^{\phi\theta}) & \exp(j\Phi_{n,m}^{\phi\phi}) \end{bmatrix} \begin{bmatrix} F_{tx,p,\theta}(\theta_{n,m,ZOD}, \phi_{n,m,AOD}) \\ F_{tx,p,\phi}(\theta_{n,m,ZOD}, \phi_{n,m,AOD}) \end{bmatrix}$$

with the notations P_n , $\theta_{n,m,ZOA}$, $\phi_{n,m,AOA}$, $\theta_{n,m,ZOD}$, $\phi_{n,m,AOD}$, $\Phi_{n,m}^{\theta\theta}$, $\Phi_{n,m}^{\theta\phi}$, $\Phi_{n,m}^{\phi\theta}$, $\Phi_{n,m}^{\phi\phi}$ and $\kappa_{n,m}$ being according to equation (7.3-22) in TR 36.873 [19], and K_R is the Ricean K-factor;

and for LOS path

$$\alpha_{0,u,p} = \sqrt{\frac{K_R}{K_R + 1}} \begin{bmatrix} F_{rx,u,\theta}(\theta_{LOS,ZOA}, \phi_{LOS,AOA}) \\ F_{rx,u,\phi}(\theta_{LOS,ZOA}, \phi_{LOS,AOA}) \end{bmatrix}^T \begin{bmatrix} \exp(j\Phi_{LOS}) & 0 \\ 0 & -\exp(j\Phi_{LOS}) \end{bmatrix} \begin{bmatrix} F_{tx,p,\theta}(\theta_{LOS,ZOD}, \phi_{LOS,AOD}) \\ F_{tx,p,\phi}(\theta_{LOS,ZOD}, \phi_{LOS,AOD}) \end{bmatrix}$$

with the notations $\theta_{LOS,ZOA}$, $\phi_{LOS,AOA}$, $\theta_{LOS,ZOD}$, $\phi_{LOS,AOD}$, and Φ_{LOS} being according to equation (7.3-27) in TR 36.873 [19];

and $F_{tx,p,\theta}$ and $F_{tx,p,\phi}$ are the field patterns of Tx antenna port p in the direction of the spherical basis vectors, $\hat{\theta}$ and $\hat{\phi}$ respectively, $F_{rx,u,\theta}$ and $F_{rx,u,\phi}$ are the field patterns of Rx antenna port u in the direction of the spherical basis vectors, $\hat{\theta}$ and $\hat{\phi}$ respectively; they are given by

$$\begin{aligned}
F_{tx,p,\theta}(\theta_{n,m,ZOD}, \varphi_{n,m,AOD}) &= \sum_{k=1}^{N_T} w_k \exp\left(j2\pi\lambda_0^{-1}(\hat{r}_{tx,n,m}^T \cdot \bar{d}_{tx,k})\right) F_{tx,k,\theta}(\theta_{n,m,ZOD}, \varphi_{n,m,AOD}) \\
F_{tx,p,\varphi}(\theta_{n,m,ZOD}, \varphi_{n,m,AOD}) &= \sum_{k=1}^{N_T} w_k \exp\left(j2\pi\lambda_0^{-1}(\hat{r}_{tx,n,m}^T \cdot \bar{d}_{tx,k})\right) F_{tx,k,\varphi}(\theta_{n,m,ZOD}, \varphi_{n,m,AOD}) \\
F_{rx,u,\theta}(\theta_{n,m,ZOA}, \varphi_{n,m,AOA}) &= \sum_{l=1}^{N_R} g_l \exp\left(j2\pi\lambda_0^{-1}(\hat{r}_{rx,n,m}^T \cdot \bar{d}_{rx,l})\right) F_{rx,l,\theta}(\theta_{n,m,ZOA}, \varphi_{n,m,AOA}) \\
F_{rx,u,\varphi}(\theta_{n,m,ZOA}, \varphi_{n,m,AOA}) &= \sum_{l=1}^{N_R} g_l \exp\left(j2\pi\lambda_0^{-1}(\hat{r}_{rx,n,m}^T \cdot \bar{d}_{rx,l})\right) F_{rx,l,\varphi}(\theta_{n,m,ZOA}, \varphi_{n,m,AOA})
\end{aligned}$$

where N_T is the number of antenna elements that virtualizes the Tx antenna port p , N_R is the number of antenna elements that virtualizes the Rx antenna port u ; w_k ($k=1, \dots, N_T$) represents a complex weight vector used for virtualization of Tx antenna port p , g_l ($l=1, \dots, N_R$) represents a complex weight vector used for virtualization of Rx antenna port u , $F_{tx,k,\theta}$ and $F_{tx,k,\varphi}$ are the k th transmit antenna element's field patterns in the direction of the spherical basis vectors, $\hat{\theta}$ and $\hat{\varphi}$ respectively, $F_{rx,l,\theta}$ and $F_{rx,l,\varphi}$ are the l th receive antenna element's field patterns in the direction of the spherical basis vectors, $\hat{\theta}$ and $\hat{\varphi}$ respectively;

and TX_{power} is the total transmit power (over the S Tx antenna ports) per RE.

The average interference plus noise power \bar{P}_{I+N} is over U Rx antenna ports that are expressed as

$$\bar{P}_{I+N} = \frac{1}{U} \text{tr}(\mathbf{R}_{I+N}) \quad (\text{B.1-3})$$

where $\mathbf{R}_{I+N} = \mathbf{Q} + \mathbf{N}$ is the $U \times U$ covariance matrix of interference and noise on the same RE as TX_{power} is computed, \mathbf{Q} and \mathbf{N} are the covariance matrix of the interference and the noise, respectively, and are modeled according to section A.2.1.8 in TR36.814, and $\text{tr}(\mathbf{R}_{I+N})$ represents the trace of \mathbf{R}_{I+N} .

B.2 Link level assumption for mobility evaluation

B.2.1 Scaling factor for link level channel model

According to Report ITU-R M.2412 [6], for the link level simulation part for mobility, reliability, and connection density evaluation, the delay spreads and angular spreads (for AoA, AoD, ZoA, and ZoD) in link-level channel model are scaled to the median values for the environment and channel type (LOS/NLOS) evaluated, and system-level channel model variant (model A or model B) selected.

According to system-level channel model defined in Report ITU-R M.2412 [6], the scaling parameters of delay spreads and angular spreads are given in Table B.2.1-1.

Table B.2.1-1 Scaling parameters for delay spreads and angular spreads for related test environments

Parameters	Indoor Hotspot-eMBB						Dense Urban-eMBB				Rural-eMBB	
	Config A (4 GHz)		Config B (30 GHz)		Config C (70 GHz)		Config A (4 GHz)		Config B (30 GHz)		Config A/B (700 MHz/4 GHz)	
Link-level Channel model	LOS: CDL/TDL-iv	NLOS: CDL/TDL-i	LOS: CDL/TDL-iv	NLOS: CDL/TDL-i	LOS: CDL/TDL-iv	NLOS: CDL/TDL-i	LOS: CDL/TDL-v	NLOS: CDL/TDL-iii	LOS: CDL/TDL-v	NLOS: CDL/TDL-iii	LOS: CDL/TDL-v	NLOS: CDL/TDL-iii
Delay spread scaling parameter $DS_{desired}$ (ns)	20	39	19.5	26	19.5	20	93	363	79	263	32	37
AoA angular spreads scaling parameter $AS_{desired}$ (degree)	42	59	32	50	27	46	65	74	65	48	33	33
AoD angular spreads scaling parameter $AS_{desired}$ (degree)	40	42	40	42	40	42	14	26	17	22	8	9
ZoA angular spreads scaling parameter $AS_{desired}$ (degree)	17	18	11	14	9	13	9	18	9	11	3	4
ZoD angular spreads scaling parameter $AS_{desired}$ (degree)	10	12	1	12	0.4	12	(NOTE 1)	(NOTE 1)	(NOTE 1)	(NOTE 1)	(NOTE 1)	(NOTE 1)
K-factor (dB)	13.3	-	13.3	-	13.3	-	22	-	22	-	22	-

NOTE 1: This value is derived by the 50%-tile point of CDF of the mean value of ZoD spread (as defined in system level channel model) of all UEs based on UE dropping in system level simulation. The mean value of ZoD spread of a UE is calculated according to the formula given in Table B.2.1-2 and Table B.2.1-3 for Dense Urban – eMBB and Rural – eMBB test environment, respectively, where d_{2D} and h_{UT} of a UE is determined by the UE dropping.

Table B.2.1-2 Mean value calculation for UMa ZoD spread

	Frequency	Parameters	UMa_x	
			LOS LOS O-to-I	NLOS NLOS O-to-I
UMa_A	0.5 GHz $\leq f_c \leq$ 6 GHz	μ_{gZSD}	$\max[-0.5, -2.1(d_{2D}/1000) - 0.01(h_{UT} - 1.5) + 0.75]$	$\max[-0.5, -2.1(d_{2D}/1000) - 0.01(h_{UT} - 1.5) + 0.9]$
	6 GHz $< f_c \leq$ 100 GHz	μ_{gZSD}	$\max[-0.5, -2.1(d_{2D}/1000) - 0.01(h_{UT} - 1.5) + 0.75]$	$\max[-0.5, -2.1(d_{2D}/1000) - 0.01(h_{UT} - 1.5) + 0.9]$
UMa_B	0.5 GHz $\leq f_c \leq$ 100 GHz	μ_{gZSD}	$\max[-0.5, -2.1(d_{2D}/1000) - 0.01(h_{UT} - 1.5) + 0.75]$	$\max[-0.5, -2.1(d_{2D}/1000) - 0.01(h_{UT} - 1.5) + 0.9]$

Table B.2.1-3 Mean value calculation for RMa ZoD spread

	Frequency	Parameters	RMa_x	
			LOS	NLOS / O-to-I
RMa_A RMa_B	RMa_A: 0.5 GHz $\leq f_c \leq$ 6 GHz, RMa_B: 0.5 GHz $\leq f_c \leq$ 7 GHz	μ_{gZSD}	$\max(-1, -0.17*(d_{2D}/1000) - 0.01*(h_{UT} - 1.5) + 0.22)$	$\max(-1, -0.19*(d_{2D}/1000) - 0.01*(h_{UT} - 1.5) + 0.28)$

B.2.2 TXRU pattern and inter-port spacing in link level simulation

The companies report the antenna port pattern used in link level simulation (LLS). If the CDL channel model is used in LLS, the following three options can be used for reference.

- Option 1: 0dBi omni-directional gain is assumed for Tx and Rx antenna ports
- Option 2: 0dBi gain (linear gain = 1) for the paths within the 3dB beamwidth; linear gain = 0 (-∞ dB gain) for the paths outside the 3dB beamwidth.
- Option 3: Use the pattern defined in Section 8.5 in Report ITU-R M.2412 [6] for BS and UE side with maximum directional gain of 0dBi for related test environments.

The inter-port spacing calculation is reported by the companies. The calculation method given by equation (B.2.2-1) and (B.2.2-2) as shown below can be used for reference.

The Tx horizontal and vertical inter-port spacing (for the same polarization) can be calculated by

$$d_{tx_port,H} = d_{tx_element,H} \times N_T^H \tag{B.2.2-1}$$

$$d_{tx_port,V} = d_{tx_element,V} \times N_T^V \tag{B.2.2-2}$$

where $d_{tx_element,H}$ and $d_{tx_element,V}$ are the Tx inter-element spacing on horizontal and vertical domain, respectively, and N_T^H and N_T^V are the number of antenna elements on the same polarization that virtualizes the Tx antenna port on horizontal and vertical domain, respectively. An illustration is given in Figure B.2.2-1.

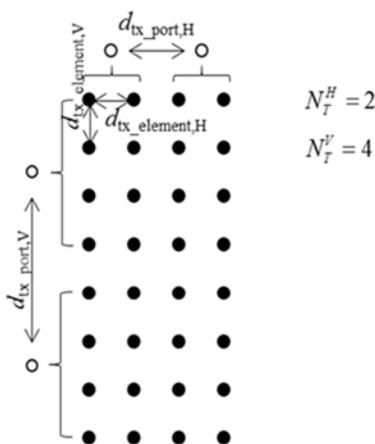

Figure B.2.2-1 Illustration of inter-port spacing

B.3 Evaluation assumption for peak spectral efficiency and peak data rate

B.3.1 Evaluation assumption for NR

B.3.1.1 NR downlink

Evaluation parameters for NR DL peak spectral efficiency and peak data rate is shown in Table B.3.1.1-1. The notations can be found in equation (5.1.1-1) in Section 5.1.1.

Table B.3.1.1-1 NR Parameters for DL peak spectral efficiency and peak data rate evaluation

Parameters	Values	Remarks
Max. number of layers $v_{Layers}^{(j)}$	For FR1: 8 For FR2: 6, 8	
Highest modulation order $Q_m^{(j)}$	8	256QAM
Scaling factor of modulation $f^{(j)}$	1	
Max. coding rate R_{max}	948/1024 = 0.9258	
μ	0, 1, 2, 3	SCS = $2^\mu \times 15$ kHz
$N_{PRB}^{BW(j),\mu}$	See Table 8.1.1-2 for FR1 and FR2 for specific component carrier bandwidth and SCS.	The maximum number of RBs for the specific component carrier bandwidth and SCS is used.

The overhead assumption used in the NR DL evaluation is shown in Table B.3.1.1-2.

Table B.3.1.1-2 Overhead assumption for NR DL evaluation

	Applied duplexing	FR1	FR2
OH1	FDD, TDD (DDDSU)	<ul style="list-style-type: none"> PDCCH: CORESET of 24 PRBs (4 CCE) in every slot <ul style="list-style-type: none"> ◆ 12 RE/PRB/slot TRS burst of 2 slots with periodicity of 20ms and occupies 52 PRBs <ul style="list-style-type: none"> ◆ 12 RE/PRB/20 ms DMRS: Type 2, 16 RE/PRB/slot for 8 layers CSI-RS: 8 CSI-RS ports with periodicity of 20ms <ul style="list-style-type: none"> ◆ 8 RE/PRB/20 ms 1 SS/PBCH blocks (SSB) per 20ms; one SSB occupies 960REs = 4 OFDM symbols \times 20 PRB \times 12 REs/PRB <p>NOTE1: if the channel bandwidth is less than the bandwidth of SSB, then SSB is not transmitted and the overhead of SS/PBCH block is zero. NOTE2: If the channel bandwidth is less than TRS bandwidth, the TRS bandwidth is assumed to be equal to the channel bandwidth.</p>	<ul style="list-style-type: none"> PDCCH: CORESET of 24 PRBs (4 CCE) in every slot <ul style="list-style-type: none"> - 12 RE/PRB/slot TRS burst of 2 slots with periodicity of 10ms and occupies 52 PRBs <ul style="list-style-type: none"> - 12 RE/PRB/slot DMRS: Type 2, 12 RE/PRB/slot for 6 layers CSI-RS: 8 CSI-RS ports with periodicity of 10ms <ul style="list-style-type: none"> ◆ 8 RE/PRB/10 ms 8 SSB per 20ms; one SSB occupies 960REs = 4 OFDM symbols \times 20 PRB \times 12 REs/PRB PTRS: 1 port, frequency density is 4 PRB, and time domain density is 1 symbol CSI-RS for BM: 1 CSI-RS port with periodicity of 10ms <ul style="list-style-type: none"> - 2 RE/PRB/10ms <p>NOTE: If the channel bandwidth is less than TRS bandwidth, the TRS bandwidth is assumed to be equal to the channel bandwidth.</p>
OH2	FDD, TDD (DDDSU)	<ul style="list-style-type: none"> PDCCH: 2 CEE <ul style="list-style-type: none"> ◆ 144 RE/slot TRS burst of 2 slots with periodicity of 80ms and occupies 52 PRBs 	-

		<ul style="list-style-type: none"> ◆ 12 RE/PRB/80 ms • DMRS: Type 2, 16 RE/PRB/slot • CSI-RS: 8 CSI-RS ports with periodicity of 20ms ◆ 8 RE/PRB/20 ms • CSI-IM: 4 CSI-RS ports with periodicity of 20ms ◆ 4 RE/PRB/20 ms • 1 SSB <p>960 RE/20 ms</p>	
OH3	FDD, TDD (DSUUD, S slot = 11DL:1GP:2UL)	<ul style="list-style-type: none"> • PDCCH: 4 CCE in every slot • TRS: min(52, N_{RB}^{BWP}) PRB wide, occurs every 80 ms • DMRS: Type 2, 16 RE/PRB/slot • CSI-RS: 8 CSI-RS ports with 1 RE/RB/port, with periodicity of 20ms • CSI-IM: 4 RE/PRB, with periodicity of 20ms • 1 SSB per 20ms <p>NOTE1: If the number of REs is less than 240 at the evaluated channel bandwidth and SCS, the SSB is assumed transmitted by lower SCS and the overhead of SS/PBCH block is 1 SSB per 20ms.</p>	<ul style="list-style-type: none"> • PDCCH: 4 CCE in every slot • TRS: min(52, N_{RB}^{BWP}) PRB wide, occurs every 10 ms • DMRS: Type 2, 12 RE/PRB/slot • CSI-RS: 8 CSI-RS ports with 1 RE/RB/port, with periodicity of 2.5ms • CSI-IM: 4 RE/PRB, with periodicity of 2.5ms • 8 SSB per 20ms • PTRS: 1 port, frequency density is 4 PRB, and time domain density is 1 symbol
OH4	FDD, TDD (DSUUD, S slot = 6DL:2GP:6UL)	<p>Overhead is adapted to 0.14 to match the capability of TS38.306</p> <p>For FDD:</p> <ul style="list-style-type: none"> • PDCCH: 4 CCE + 1 symbol per slot ◆ 12*24 RE/slot • TRS ◆ 2x4 RE/PRB/20 slots • DMRS: 2 symbol Type 2 FL DMRS with RS on 2 combs ◆ 16 RE/PRB/slot • CSI-RS: 8-port CSI-RS resources ◆ 8 RE/PRB/10 slots • 1 SSB ◆ 960 RE/20 slots <p>For TDD:</p> <ul style="list-style-type: none"> • PDCCH: 2 CCE + 1 symbol per slot ◆ 12*12 RE/slot • TRS ◆ 2x4 RE/PRB/40 slots • DMRS: 2 symbol Type 2 FL DMRS with RS on 2 combs ◆ 16 RE/PRB/slot • CSI-RS: 8-port CSI-RS resources ◆ 8 RE/PRB/20 slots • 1 SSB ◆ 960 RE/20 slots 	<p>Overhead is adapted to 0.18 to match the capability of TS38.306</p> <ul style="list-style-type: none"> • PDCCH: 4 CCE + 1 symbol per slot ◆ 12*24 RE/slot • TRS ◆ 8 RE/PRB/16 slots • DMRS: 2 symbol Type 2 FL DMRS with RS on 2 combs ◆ 16 RE/PRB/slot • CSI-RS: 8-port CSI-RS resources ◆ 8 RE/PRB/16 slots • 8 SSB ◆ 8x960 RE/PRB/80 slots

B.3.1.2 NR uplink

Evaluation parameters for NR UL peak spectral efficiency and peak data rate is shown in Table B.3.1.2-1. The notations can be found in equation (5.1.1-1) in Section 5.1.1.

Table B.3.1.2-1 NR Parameters for UL peak spectral efficiency and peak data rate evaluation

Parameters	Values	Remarks
Max. number of layers $v_{Layers}^{(j)}$	4	
Highest modulation order $Q_m^{(j)}$	8	256QAM
Scaling factor of modulation $f^{(j)}$	1	
Max. coding rate R_{max}	948/1024 = 0.9258	
μ	0, 1, 2, 3	SCS = 2 ^{μ} × 15 kHz

$N_{PRB}^{BW(j),\mu}$	See Table 8.1.1-2 for FR1 and FR2 for specific component carrier bandwidth and SCS.	The maximum number of RBs for the specific component carrier bandwidth and SCS is used.
-----------------------	---	---

The overhead assumption used in the NR UL evaluation is shown in Table B.3.1.1-2.

Table B.3.1.2-2 Overhead assumption for NR UL evaluation

	Applied duplexing	FR1	FR2
OH1	FDD, TDD (DDDSU)	<ul style="list-style-type: none"> PUCCH: short PUCCH with 1 PRB and 1 symbol in every UL slot; 12 RE/slot DMRS: Type I, one complete symbol; 12 RE/PRB/slot SRS: 1 symbol with periodicity of 10ms for FDD; 1 symbol with periodicity of 20ms for TDD 	<ul style="list-style-type: none"> PUCCH: short PUCCH with 1 PRB and 1 symbol in every UL slot; 12 RE/slot DMRS: Type I, one complete symbol; 12 RE/PRB/slot SRS: 1 symbol with periodicity of 5ms PTRS: 2 ports PTRS, frequency density is 4 PRB, and time domain density is 1 symbol
OH2	FDD, TDD (DDDSU)	<ul style="list-style-type: none"> PUCCH: short PUCCH with 1 PRB and 1 symbol in every UL slot; 12 RE/slot DMRS: Type II, 8 RE/PRB/slot SRS: 1 symbol with periodicity of 20ms 	-
OH3	FDD, TDD (DSUUD, S slot = 11DL:1GP:2UL)	<ul style="list-style-type: none"> PUCCH: short PUCCH with 1 PRB over 1 symbol in every slot; DMRS: Type II, 8 RE/PRB/slot for slot carrying SRS; otherwise 12 RE/PRB/slot. SRS: Resources ensuring the whole bandwidth measured within 20ms 	<ul style="list-style-type: none"> PUCCH: short PUCCH with 1 PRB over 1 symbol in every slot; DMRS: Type I, 12 RE/PRB/slot SRS: Resources ensuring the whole bandwidth measured within 2.5ms PTRS: 2 ports, frequency density is 4 RB, and time domain density is 1 symbol
OH4	FDD, TDD (DSUUD, S slot = 6DL:2GP:6UL)	<p>Overhead is adapted to 0.08 to match the capability of TS38.306.</p> <p>For FDD:</p> <ul style="list-style-type: none"> PUCCH: short PUCCH with 2 symbols and 8 PRBs; <ul style="list-style-type: none"> ◆ 192 RE per slot DMRS: 1 symbol Type 2 FL DMRS in each slot with RS on 2 combs; <ul style="list-style-type: none"> ◆ 8 RE/PRB/slot SRS <ul style="list-style-type: none"> ◆ 12 RE/PRB/5 slots <p>For TDD:</p> <ul style="list-style-type: none"> PUCCH: short PUCCH with 2 symbols and 8 PRBs; <ul style="list-style-type: none"> ◆ 192 RE/2 slots DMRS: 1 symbol Type 2 FL DMRS in each slot with RS on 2 combs; <ul style="list-style-type: none"> ◆ 8 RE/PRB/slot SRS <ul style="list-style-type: none"> ◆ 12 RE/PRB/10 slots 	<p>Overhead is adapted to 0.1 to match the capability of TS38.306.</p> <ul style="list-style-type: none"> PUCCH: short PUCCH with 2 symbols and 8 PRBs; <ul style="list-style-type: none"> ◆ 192 RE/2 slots DMRS: 1 symbol Type 2 FL DMRS in each slot with RS on 2 combs; <ul style="list-style-type: none"> ◆ 8 RE/PRB/slot SRS <ul style="list-style-type: none"> ◆ 12 RE/PRB/5 slots

B.3.2 Evaluation assumption for LTE

B.3.2.1 LTE downlink

Evaluation parameters for LTE DL peak spectral efficiency and peak data rate is shown in Table B.3.2.1-1. The notations can be found in equation (5.1.1-1) in Section 5.1.1.

Table B.3.2.1-1 LTE Parameters for DL peak spectral efficiency and peak data rate evaluation

Parameters	Values	Remarks
Max. number of layers $v_{Layers}^{(j)}$	8	
Highest modulation order $Q_m^{(j)}$	8 10	256QAM 1024QAM
Scaling factor of modulation $f^{(j)}$	1	

Max. coding rate R_{max}	According to Transport block size (TBS) table defined in TS36.213	
$N_{PRB}^{BW(j)}$	See Table 8.1.2-2 for specific component carrier bandwidth.	The maximum number of RBs for the specific component carrier bandwidth is used.

The overhead assumption used in the LTE DL evaluation is shown in Table B.3.2.1-1.

Table B.3.2.1-2 Overhead assumption for LTE DL evaluation

	Applied duplexing	FR1
OH1	FDD, TDD	<ul style="list-style-type: none"> - PBCH: 240 RE per 10ms (not including CRS) - PSS/SSS: 288 RE per 10ms - PDCCH: 1 complete symbols - CRS: 1 port for non-MBSFN; 6 RE/PRB; 0 port for MBSFN. - DMRS: 8 ports, 24RE per PRB - CSI-RS: 8 CSI-RS ports with periodicity of 40ms; 8 - RE/PRB/40ms. - MBSFN: 6 subframes per radio frame for MBSFN for FDD; 4 subframes per radio frame for MBSFN for TDD with DSUDD; 2 subframes per radio frame for MBSFN for TDD with DSUUD.

B.3.2.2 LTE uplink

Evaluation parameters for LTE DL peak spectral efficiency and peak data rate is shown in Table B.3.2.2-1. The notations can be found in equation (5.1.1-1) in Section 5.1.1.

Table B.3.2.2-1 LTE Parameters for UL peak spectral efficiency and peak data rate evaluation

Parameters	Values	Remarks
Max. number of layers $v_{Layers}^{(j)}$	4	
Highest modulation order $Q_m^{(j)}$	8	256QAM
Scaling factor of modulation $f^{(j)}$	1	
Max. coding rate R_{max}	According to Transport block size (TBS) table defined in TS36.213	
$N_{PRB}^{BW(j)}$	See Table 8.1.2-2 for specific component carrier bandwidth.	The maximum number of RBs for the specific component carrier bandwidth is used.

The overhead assumption used in the LTE UL evaluation is shown in Table B.3.2.1-2.

Table B.3.2.1-2 Overhead assumption for LTE UL evaluation

	Applied duplexing	FR1
OH1	FDD, TDD	<ul style="list-style-type: none"> - PUCCH: 2 PRBs in every uplink subframe - DMRS: 2 complete symbols, 24 RE per PRB - SRS: 1 symbol per 10ms

B.4 Detailed assumptions and evaluation results for simulation related technical performance requirements

B.4.1 Detailed assumptions and results for average and 5th percentile user spectral efficiency

The detailed assumptions and results for average and 5th percentile user spectral efficiency can be found in the attached document "**B.4.1_eMBB_SE.zip**".

B.4.2 Detailed assumptions and results for mobility

The detailed assumptions and results for mobility can be found in the attached document "**B.4.2_Mobility.zip**".

B.4.3 Detailed assumptions and results for user experienced data rate

The detailed assumptions and results for user experienced data rate for multi-band/layer can be found in the attached document "**B.4.3_UserExpDataRate.zip**".

B.4.4 Detailed assumptions and results for reliability

The detailed assumptions and results for reliability can be found in the attached document "**B.4.4_Reliability.zip**".

B.4.5 Detailed assumptions and results for connection density

The detailed assumptions and results for connection density can be found in the attached document "**B.4.5_ConnectionDensity.zip**".

B.5 Simulation results of spectral efficiency for Configuration B in Dense Urban – eMBB with modified ITU-R assumptions (for information only)

The evaluation results of average spectral efficiency and the 5th percentile spectral efficiency of evaluation configuration B in Dense Urban – eMBB test environment with modified ITU-R parameters/assumptions are shown in this section for information. The detailed assumptions for the evaluations shown in this section can be found in Appendix B.4.1.

The evaluation results of DL spectral efficiency for NR TDD with 100% low-loss penetration assumption are provided in Table B.5-1. It should be noted that Report ITU-R M.2412 [6] defines 80% low loss and 20% high loss for configuration B.

Note that the capability of NR in larger bandwidth are evaluated for DL spectral efficiency. The values of the larger bandwidths are shown together with the evaluation results.

Table B.5-1 DL spectral efficiency for NR in Dense Urban – eMBB (Evaluation configuration B, CF=30 GHz, 100% low-loss penetration)

a) NR TDD

Scheme and antenna configuration	Sub-carrier spacing (kHz)	Frame structure	ITU Requirement		Number of samples	BW= 80MHz / 100 MHz	BW= 200MHz	BW= 400MHz
			Average [bit/s/Hz/TRxP]	5th-tile [bit/s/Hz]				
128x8 MU-MIMO, Reciprocity based; 4T SRS (2 panel@UE) gNB Config = (8,16,2,1,1;4,16); UE Config = (2,4,2,1,2; 1,2)	120	DDDSU	Average [bit/s/Hz/TRxP]	7.8	1	21.6	24.2	25.4
			5th-tile [bit/s/Hz]	0.225		0.58	0.65	0.68
128x8 MU-MIMO, Type I codebook; Wideband (2 panel@UE) gNB Config = (8,16,2,1,1;4,16); UE Config = (2,4,2,1,2; 1,2)	120	DDDSU	Average [bit/s/Hz/TRxP]	7.8	1	16.90	18.90	19.80
			5th-tile [bit/s/Hz]	0.225		0.44	0.49	0.51

The evaluation results of UL spectral efficiency for NR TDD with 100% low loss penetration assumption are provided in Table B.5-2. It should be noted that Report ITU-R M.2412 [6] defines 80% low loss and 20% high loss penetration for configuration B.

Table B.5-2 UL spectral efficiency for NR in Dense Urban – eMBB (Evaluation configuration B, CF=30 GHz, 100% low-loss penetration)

(a) NR TDD

Scheme and antenna configuration	Sub-carrier spacing (kHz)	Frame structure	ITU Requirement		Number of samples	BW=80MHz / 100MHz
			Average [bit/s/Hz/TRxP]	5 th -tile [bit/s/Hz]		
8x128 MU-MIMO, Codebook based, OFDMA, (2 panel@UE); gNB Config = (8,16,2,1,1;4,16) UE Config = (2,4,2,1,2; 1,2)	120	DDDSU	Average [bit/s/Hz/TRxP]	5.4	1	11.3
			5 th -tile [bit/s/Hz]	0.15		0.41

The evaluation results with admission control are provided in Tables B.5-3 and B.5-4. For admission control, it means the users with the pathloss value larger than a given threshold is not admitted to access the network, and they are excluded in the derivation of the 5th percentile user spectral efficiency, instead of estimating the 5th percentile user spectral efficiency from all possible user locations, as defined in Report ITU-R M.2412 [6].

The evaluation results of DL spectral efficiency for NR TDD with admission control are provided in Table B.5-3.

**Table B.5-3 DL spectral efficiency for NR in Dense Urban – eMBB
(Evaluation configuration B, CF=30 GHz, with admission control)**

(a) NR TDD

Scheme and antenna configuration	Sub-carrier spacing (kHz)	Frame structure	ITU Requirement		Number of samples	BW= 80MHz / 100 MHz	BW= 200MHz	BW= 400MHz
			Average [bit/s/Hz/TRxP]	7.8				
8x4 MU-MIMO, Reciprocity based; 4T SRS (2 panel@UE) gNB Config = (8,16,2,1,1,4,16); UE Config = (2,4,2,1,2; 1,1)	120	DDDSU	Average [bit/s/Hz/TRxP]	7.8	1	8.37	9.62	10.15
			5 th -tile [bit/s/Hz]	0.225		0.26	0.30	0.32
8x2 MU-MIMO, Reciprocity based; 2T SRS (2 panel@UE) gNB Config = (16,8,2,1,1,2,2); UE Config = (2,4,2,1,2; 1,1)	120	DDDSU	Average [bit/s/Hz/TRxP]	7.8	1	9.38	10.77	11.36
			5 th -tile [bit/s/Hz]	0.225		0.28	0.32	0.34

The evaluation results of UL spectral efficiency for NR TDD with admission control are provided in Table B.5-4.

**Table B.5-4 UL spectral efficiency for NR in Dense Urban – eMBB
(Evaluation configuration B, CF=30 GHz, with admission control)**

(a) NR TDD

Scheme and antenna configuration	Sub-carrier spacing (kHz)	Frame structure	ITU Requirement		Number of samples	BW=80MHz / 100MHz
			Average [bit/s/Hz/TRxP]	5.4		
4x8 MU-MIMO, Codebook based, OFDMA, (2 panel@UE); gNB Config = (4,8,2,2,2;1,1) UE Config = (2,4,2,1,2; 1,1)	120	DDDSU	Average [bit/s/Hz/TRxP]	5.4	1	5.75
			5 th -tile [bit/s/Hz]	0.15		0.22
2x2 MU-MIMO, Codebook based, OFDMA, (2 panel@UE); gNB Config = (16,8,2,1,1;1,1) UE Config = (4,4,2,1,2; 1,1)	120	DDDU	Average [bit/s/Hz/TRxP]	5.4	1	5.52
			5 th -tile [bit/s/Hz]	0.15		0.16

B.6 Simulation results of Configuration C for Indoor Hotspot – eMBB test environment (for information only)

The evaluation results of spectral efficiency and area traffic capacity of evaluation configuration C (carrier frequency = 70 GHz) in Indoor Hotspot – eMBB test environment are shown in this section for information only.

Frequency ranges corresponding to Configuration C are not supported in 3GPP NR Rel-15 and 16 specifications.

Some preliminary evaluations were provided by a few companies for configuration C by using existing numerologies specified for FR2 in 3GPP NR Rel-15 and 16 specifications. 3GPP will be developing the specifications for the frequency range from 52.6 GHz to 114 GHz carrier frequencies after Rel-16. The evaluation for Configuration C took an ideal assumption that the physical layer abstraction for FR2 can be also used for 70 GHz CF. Therefore, there is no agreement in 3GPP that the same waveform, numerologies, or simulation assumptions as in existing FR2 can be also used for 70 GHz CF.

The detailed assumptions for the evaluations shown in this section can be found in Appendix B.4.1.

B.6.1 Evaluation configuration C (CF = 70 GHz) for spectral efficiency

The evaluation results of DL average and the 5th percentile user spectral efficiency spectral efficiency for NR for evaluation configuration C with 12TRxP are provided in Table B.6.1-1. The sub-carrier spacing of 60 kHz and 120 kHz are employed.

Similar to the evaluation of NR in Section 5.4, it is noted that the component carrier bandwidth of NR can be larger than the simulation bandwidth as defined in Report ITU-R M.2412 [6]. For those larger bandwidth cases, the guard band ratio can be further decreased; and the OFDM symbol occupation by PDCCH is expected to be reduced, even to less than one OFDM symbol due to the capability of PDCCH resource sharing with PDSCH.

Such capabilities are evaluated for DL spectral efficiency. The values of the assumed bandwidths are shown together with the evaluation results.

**Table B.6.1-1 DL spectral efficiency for NR in Indoor Hotspot – eMBB
(Evaluation configuration C, CF=70 GHz, for 12TRxP)**

(a) NR FDD

Scheme and antenna configuration	Sub-carrier spacing (kHz)	ITU Requirement		Number of samples	BW=40 MHz
32x8 MU-MIMO Type II codebook (2 panel@UE) gNB Config = (4,4,2,1,1;4,4) UE Config = (2,4,2,1,2; 1,1)	60	Average [bit/s/Hz/TRxP]	9	1	12.87
		5 th -tile [bit/s/Hz]	0.3		0.47
32x8 MU-MIMO Type II codebook (2 panel@UE) gNB Config = (4,4,2,1,1;4,4) UE Config = (2,4,2,1,2; 1,1)	120	Average [bit/s/Hz/TRxP]	9	1	11.43
		5 th -tile [bit/s/Hz]	0.3		0.41

(b) NR TDD

Scheme and antenna configuration	Sub-carrier spacing (kHz)	Frame structure	ITU Requirement		Number of samples	BW= 80MHz / 100MHz	BW= 200MHz	BW= 400MHz
			Average [bit/s/Hz/TRxP]	5th-tile [bit/s/Hz]				
32x4 MU-MIMO, 4T SRS (2 panel@UE) gNB Config = (8,16,2,1,1;4,4) UE Config = (2,4,2,1,2; 1,1)	60	DDDSU	Average [bit/s/Hz/TRxP]	9	1	9.61	11.03	/
			5th-tile [bit/s/Hz]	0.3				
32x8 MU-MIMO, 4T SRS (2 panel@UE) gNB Config = (16,8,2,1,1;4,4) UE Config = (2,4,2,1,2; 1,1)	60	DDDSU	Average [bit/s/Hz/TRxP]	9	1	10.41	12.17	/
			5th-tile [bit/s/Hz]	0.3				
32x8 MU-MIMO, 4T SRS (2 panel@UE) gNB Config = (4,4,2,1,1;4,4) UE Config = (2,4,2,1,2; 1,1)	120	DDDSU	Average [bit/s/Hz/TRxP]	9	1	12.77	14.27	14.97
			5th-tile [bit/s/Hz]	0.3				
32x8 MU-MIMO, 4T SRS (2 panel@UE) gNB Config = (4,4,2,1,1;4,4) UE Config = (2,4,2,1,2; 1,1)	60	DDDSU	Average [bit/s/Hz/TRxP]	9	1	12.63	14.11	/
			5th-tile [bit/s/Hz]	0.3				
8x4 MU-MIMO, 4T SRS (2 panel@UE) gNB Config = (8,16,2,1,1;2,2) UE Config = (2,4,2,1,2; 1,1)	120	DDDSU	Average [bit/s/Hz/TRxP]	9	1	9.98	11.12	11.56
			5th-tile [bit/s/Hz]	0.3				

The evaluation results of UL spectral efficiency for NR for evaluation configuration C with 12TRxP are provided in Table B.6.1-2. The sub-carrier spacing of 60 kHz and 120 kHz are employed.

Table B.6.1-2 UL spectral efficiency for NR in Indoor Hotspot – eMBB (Evaluation configuration C, CF=70 GHz, for 12TRxP)

(a) NR TDD

Scheme and antenna configuration	Sub-carrier spacing (kHz)	Frame structure	ITU Requirement		Number of samples	BW= 80MHz
			Average [bit/s/Hz/TRxP]	5th-tile [bit/s/Hz]		
8x32 SU-MIMO, Codebook based, OFDMA (2 panel@UE); gNB Config = (8,16,2,1,1;4,4); UE Config = (2,4,2,1,2; 1,2)	60	DDDSU	Average [bit/s/Hz/TRxP]	6.75	1	7.37
			5th-tile [bit/s/Hz]	0.21		0.37
4x32 MU-MIMO, Codebook based, OFDMA (2 panel@UE); gNB Config = (16,8,2,1,1;4,4); UE Config = (2,4,2,1,2; 1,1)	60	DDDSU	Average [bit/s/Hz/TRxP]	6.75	1	6.94
			5th-tile [bit/s/Hz]	0.21		0.23
4x8 MU-MIMO, Non-Codebook based, OFDMA (2 panel@UE); gNB Config = (8,16,2,1,1;2,2); UE Config = (2,4,2,1,2; 1,2)	120	DDDSU	Average [bit/s/Hz/TRxP]	6.75	1	6.85
			5th-tile [bit/s/Hz]	0.21		0.31

B.6.2 Evaluation configuration C (CF = 70 GHz) for area traffic capacity

The evaluation results of area traffic capacity for NR for evaluation configuration C with 12TRxP are provided in Table B.6.2-1. The sub-carrier spacing of 60 kHz and 120 kHz are employed.

It is assumed that for TDD with 60 kHz SCS, a component carrier with 200 MHz is used; and for TDD with 120 kHz SCS, a component carrier with 400 MHz is used. Multiple component carriers are aggregated to achieve the target area traffic capacity. The assumed aggregated system bandwidth is given in Table B.6.2-1.

**Table B.6.2-1 Area traffic capacity for NR in Indoor Hotspot – eMBB
(Evaluation configuration C, CF=70 GHz, for 12TRxP)**

(a) NR TDD

Scheme and antenna configuration	Sub-carrier spacing	Frame structure	ITU Requirement [Mbps/m ²]	Number of samples	Assumed system bandwidth [MHz]	Area traffic capacity [Mbps/m ²]
32x8 MU-MIMO, 4T SRS (2 panel@UE), gNB Config = (8,16,2,1,1,4,4); UE Config = (2,4,2,1,2; 1,2)	60	DDDSU; S Slot = (10DL:2GP:2UL)	10	1	600	10.02
32x8 MU-MIMO, 4T SRS (2 panel@UE), gNB Config = (16,8,2,1,1,4,4); UE Config = (2,4,2,1,2; 1,2)	60	DDDSU; S Slot = (6DL:2GP:6UL)	10	1	600	10.23
32x8 MU-MIMO, 4T SRS (2 panel@UE), gNB Config = (4,4,2,1,1,4,4); UE Config = (2,4,2,1,2; 1,2)	120	DDDSU; S Slot = (10DL:2GP:2UL)	10	1	800	18.14
32x8 MU-MIMO, 4T SRS (2 panel@UE), gNB Config = (4,4,2,1,1,4,4); UE Config = (2,4,2,1,2; 1,2)	60	DDDSU; S Slot = (10DL:2GP:2UL)	10	1	600	12.82
8x4 MU-MIMO, 4T SRS (2 panel@UE), gNB Config = (8,16,2,1,1,2,2); UE Config = (2,4,2,1,2; 1,1)	120	DDDSU; S Slot = (10DL:2GP:2UL)	10	1	800	14.00

Annex C: ITU-R Submission Templates for IMT-2020

C.1 Description template – characteristics

The characteristics template can be found in the attached document "**C.1_CharacteristicsTemplate.zip**".

C.2 Description template – link budget

The link budget template can be found in the attached document "**C.2_LinkBudgetTemplate.zip**".

C.3 Compliance templates for services, for spectrum, for technical performance

The compliance template can be found in the attached document "**C.3_ComplianceTemplate.zip**".

Annex D: Change history

Change history							
Date	Meeting	TDoc	CR	Rev	Cat	Subject/Comment	New version
2017-12	RAN#78	RP-172539				Skeleton	0.0.1
2018-03	RAN#79	RP-180523				Calibration results are included in Annex A.	0.1.0
2018-06	RAN#80	RP-181320				Capture LTE CP latency evaluation results in Section 5.7.2; and capture evaluation models and assumptions for mobility in Annex B.	0.2.0
2018-09	RAN#81	RP-182057				Capture all agreed pCRs: RP-181803, RP-181807, RP-181808, RP-181813, RP-182024, RP-182026, RP-182027, RP-182028, RP-182029, RP-182054, RP-182055, RP-182056, RP-182096.	0.3.0
2018-09	RAN#81	RP-182102				Accept revision marks of v0.3.0 and add editor's note in Clauses 8.3 and 9.	1.0.0
2018-12	RAN#82	RP-182786				Capture agreed pCR RP-182540.	1.1.0
2019-06	RAN#84	RP-191521				Capture agreed pCR RP-191532.	2.0.0
2019-06	RAN #84	-				Approved by RAN #84 and put under CR control	16.0.0
2019-09	RP-85	RP-191749				Editorial corrections to TR 37.910 Study on Self Evaluation towards IMT-2020 Submission	16.1.0
2022-03	RP-95e	-	-	-	-	Upgrade to the Release 17- no technical change	17.0.0
2024-03	RP-103	-	-	-	-	Upgrade to the Release 18- no technical change	18.0.0

History

Document history		
V18.0.0	May 2024	Publication