

Universal Mobile Telecommunications System (UMTS); Channel coding and multiplexing examples (3GPP TR 25.944 version 3.5.0 Release 1999)



Reference

RTR/TSGR-0125944UR5

Keywords

UMTS

ETSI

650 Route des Lucioles
F-06921 Sophia Antipolis Cedex - FRANCE

Tel.: +33 4 92 94 42 00 Fax: +33 4 93 65 47 16

Siret N° 348 623 562 00017 - NAF 742 C
Association à but non lucratif enregistrée à la
Sous-Préfecture de Grasse (06) N° 7803/88

Important notice

Individual copies of the present document can be downloaded from:

<http://www.etsi.org>

The present document may be made available in more than one electronic version or in print. In any case of existing or perceived difference in contents between such versions, the reference version is the Portable Document Format (PDF). In case of dispute, the reference shall be the printing on ETSI printers of the PDF version kept on a specific network drive within ETSI Secretariat.

Users of the present document should be aware that the document may be subject to revision or change of status. Information on the current status of this and other ETSI documents is available at <http://www.etsi.org/tb/status/>

If you find errors in the present document, send your comment to:
editor@etsi.fr

Copyright Notification

No part may be reproduced except as authorized by written permission.
The copyright and the foregoing restriction extend to reproduction in all media.

© European Telecommunications Standards Institute 2001.

All rights reserved.

Intellectual Property Rights

IPRs essential or potentially essential to the present document may have been declared to ETSI. The information pertaining to these essential IPRs, if any, is publicly available for **ETSI members and non-members**, and can be found in ETSI SR 000 314: "*Intellectual Property Rights (IPRs); Essential, or potentially Essential, IPRs notified to ETSI in respect of ETSI standards*", which is available from the ETSI Secretariat. Latest updates are available on the ETSI Web server (<http://www.etsi.org/ipr>).

Pursuant to the ETSI IPR Policy, no investigation, including IPR searches, has been carried out by ETSI. No guarantee can be given as to the existence of other IPRs not referenced in ETSI SR 000 314 (or the updates on the ETSI Web server) which are, or may be, or may become, essential to the present document.

Foreword

This Technical Report (TR) has been produced by the ETSI 3rd Generation Partnership Project (3GPP).

The present document may refer to technical specifications or reports using their 3GPP identities, UMTS identities or GSM identities. These should be interpreted as being references to the corresponding ETSI deliverables.

The cross reference between GSM, UMTS, 3GPP and ETSI identities can be found under www.etsi.org/key.

Contents

Foreword	4
1 Scope.....	5
2 References.....	5
3 Abbreviations.....	5
4 Channel coding and multiplexing examples.....	6
4.1 FDD mode.....	6
4.1.1 Downlink	6
4.1.1.1 BCH	6
4.1.1.2 Example for PCH and FACH	8
4.1.1.3 Example for DCH.....	10
4.1.1.3.1 DCH-> Radio frame segmentation.....	10
4.1.1.3.2 TrCh multiplexing -> Physical channel mapping.....	19
4.1.2 Uplink	26
4.1.2.1 Example for RACH	26
4.1.2.2 Example for DCH.....	27
4.1.2.2.1 DCH -> Radio frame segmentation.....	27
4.1.2.2.2 TrCH multiplexing -> Physical channel mapping.....	33
4.2 TDD mode.....	39
4.2.1 Downlink	39
4.2.1.1 BCH	39
4.2.1.2 Example for PCH and FACH	40
4.2.1.3 Example for DCH.....	41
4.2.1.3.1 DCH-> Radio frame segmentation.....	41
4.2.1.3.2 TrCH multiplexing -> Physical channel mapping.....	49
4.2.2 Uplink	57
4.2.2.1 RACH	57
4.2.2.2 Example for DCH.....	57
4.2.2.2.1 DCH-> Radio frame segmentation.....	57
4.2.2.2.2 TrCH multiplexing -> Physical channel mapping.....	58
Annex A (informative): Change history.....	64

Foreword

This Technical Report (TR) has been produced by the 3rd Generation Partnership Project (3GPP).

The contents of the present document are subject to continuing work within the TSG and may change following formal TSG approval. Should the TSG modify the contents of the present document, it will be re-released by the TSG with an identifying change of release date and an increase in version number as follows:

Version x.y.z

where:

- x the first digit:
 - 1 presented to TSG for information;
 - 2 presented to TSG for approval;
 - 3 or greater indicates TSG approved document under change control.
- y the second digit is incremented for all changes of substance, i.e. technical enhancements, corrections, updates, etc.
- z the third digit is incremented when editorial only changes have been incorporated in the document.

1 Scope

The present document describes examples of channel coding and multiplexing for physical channels of FDD mode and TDD mode.

2 References

The following documents contain provisions which, through reference in this text, constitute provisions of the present document.

- References are either specific (identified by date of publication, edition number, version number, etc.) or non-specific.
- For a specific reference, subsequent revisions do not apply.
- For a non-specific reference, the latest version applies. In the case of a reference to a 3GPP document (including a GSM document), a non-specific reference implicitly refers to the latest version of that document *in the same Release as the present document*.

- | | |
|------|---|
| [1] | 3GPP TS 25.211: "Physical channels and mapping of transport channels onto physical channels (FDD)". |
| [2] | 3GPP TS 25.212: "Multiplexing and channel coding (FDD)". |
| [3] | 3GPP TS 25.213: "Spreading and modulation (FDD)". |
| [4] | 3GPP TS 25.214: "Physical layer procedures (FDD)". |
| [5] | 3GPP TS 25.215: "Physical layer – Measurements (FDD)". |
| [6] | 3GPP TS 25.221: "Physical channels and mapping of transport channels onto physical channels (TDD)". |
| [7] | 3GPP TS 25.222: "Multiplexing and channel coding (TDD)". |
| [8] | 3GPP TS 25.223: "Spreading and modulation (TDD)". |
| [9] | 3GPP TS 25.224: "Physical layer procedures (TDD)". |
| [10] | 3GPP TS 25.225: "Physical layer – Measurements (TDD)". |

3 Abbreviations

For the purposes of the present document, the following abbreviations apply:

BCH	Broadcast Channel
CC	Convolutional coding
CCPCH	Common Control Physical Channel
CRC	Cyclic Redundancy Code
DCH	Dedicated Channel
DCCH	Dedicated Control Channel
DL	Downlink
DPCH	Dedicated Physical Channel
DPCCH	Dedicated Physical Control Channel
DPDCH	Dedicated Physical Data Channel
FACH	Forward Access Channel
FDD	Frequency Division Duplex
MA	Midamble
Mcps	Mega Chip Per Second

PCCPCH	Primary Common Control Physical Channel
PCH	Paging Channel
PRACH	Physical Random Access Channel
RACH	Random Access Channel
SF	Spreading Factor
SCCPCH	Secondary Common Control Physical Channel
TDD	Time Division Duplex
TFCI	Transport Format Combination Indicator
TPC	Transmit Power Control
TrBk	Transport Block
TrCh	Transport Channel
TTI	Transmission Time Interval
UL	Uplink

4 Channel coding and multiplexing examples

Following examples of channel coding and multiplexing is according to reference [2] and [7]. If there are any contradictions between following examples and the references, the present document should be corrected according to the references unless it is clear that the contradiction comes from error in the references.

Number and variables in following figures show the number of bits in corresponding fields.

4.1 FDD mode

4.1.1 Downlink

4.1.1.1 BCH

Table 1: Parameters for BCH

Transport block size	246
CRC	16 bits
Coding	CC, coding rate = 1/2
TTI	20 ms
The number of codes	1
SF	256

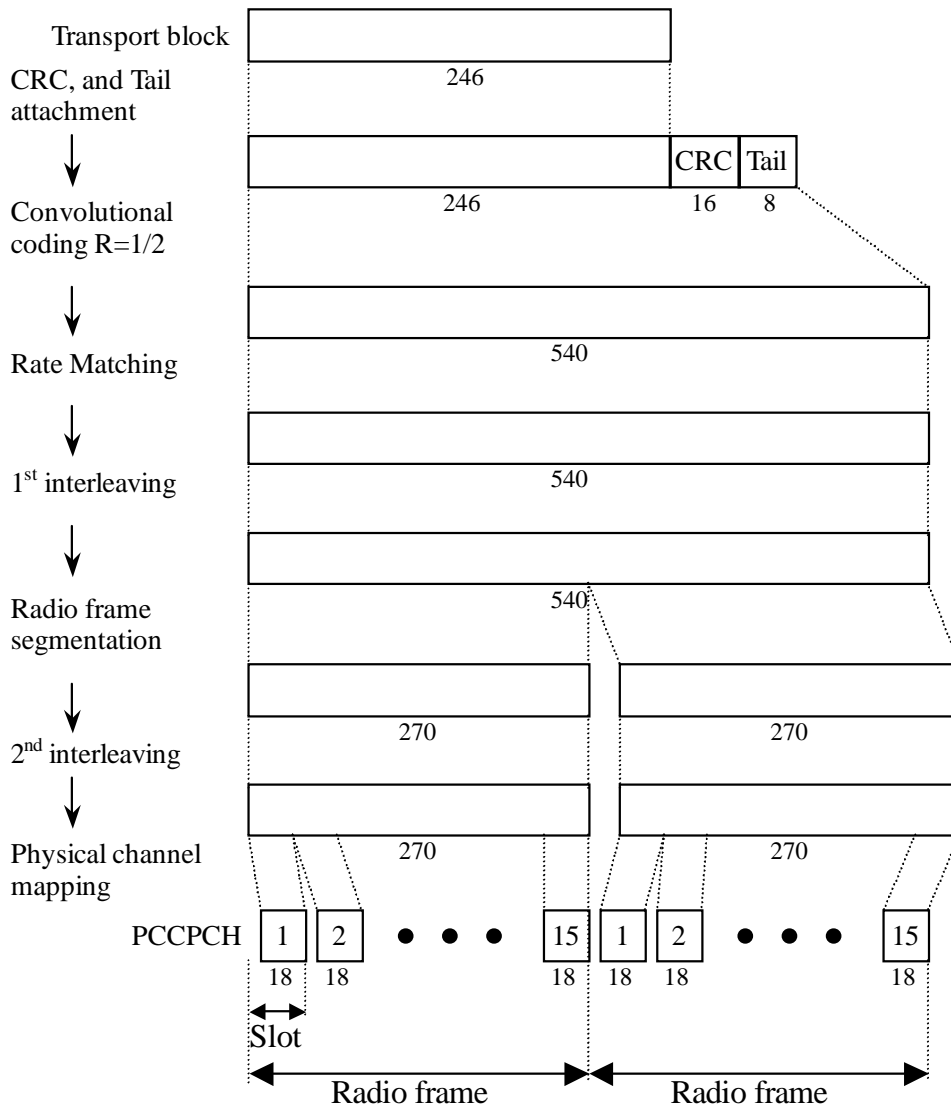

Figure 1: Channel coding for BCH

4.1.1.2 Example for PCH and FACH

Table 2: Parameter examples for PCH and FACH

Transport block size	PCH	$N_{PCH}=80$ or 240 bits
	FACH1	360 bits
	FACH2	168 bits
Transport block set size	PCH	$80 \cdot B_{PCH}$ or $240 \cdot B_{PCH}$ bits ($B_{PCH}=0, 1$)
	FACH1	$360 \cdot B_{FACH1}$ bits ($B_{FACH1}=0, 1$)
	FACH2	$168 \cdot B_{FACH2}$ bits ($B_{FACH2}=0, 1, 2$)
Coding	PCH, FACH2	CC, coding rate = 1/2
	FACH1	TC
TTI		10 ms
The numbers of codes		1
SF		64

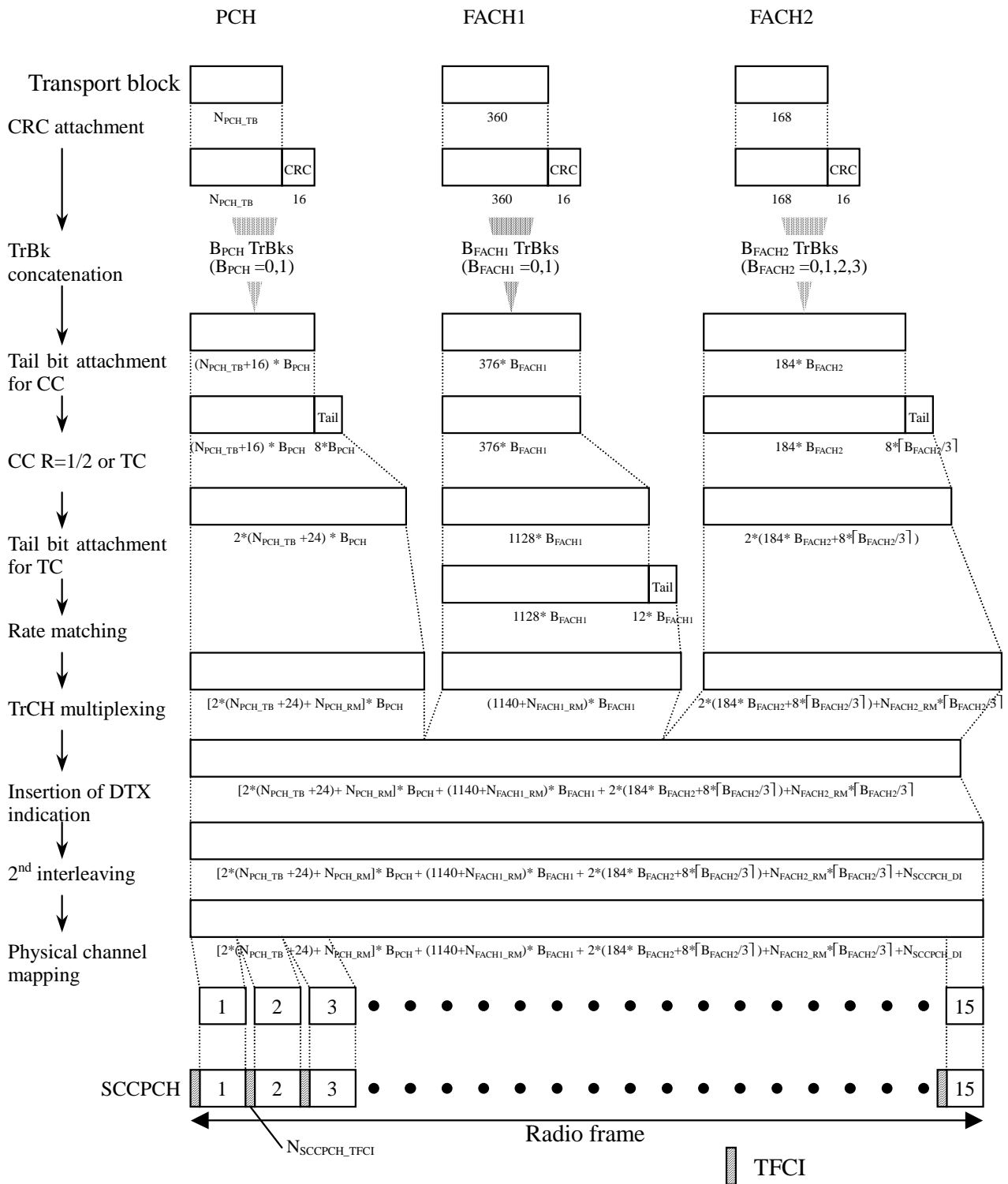

Figure 2: Channel coding and multiplexing example for PCH and FACH

4.1.1.3 Example for DCH

4.1.1.3.1 DCH-> Radio frame segmentation

4.1.1.3.1.1 Example for 3.4 kbps data

NOTE: This example can be applied to DCCH.

NOTE: In this example, it is assumed that maximum data rate of RLC payload is 3.4 kbps, and that MAC and RLC overhead in a transport block is 12 bits.

Table 3: Parameter examples for 3.4 kbps data

Transport block size	148 bits
Transport block set size	148*B bits (B=0, 1)
CRC	16 bits
Coding	CC, coding rate = 1/3
TTI	40 ms

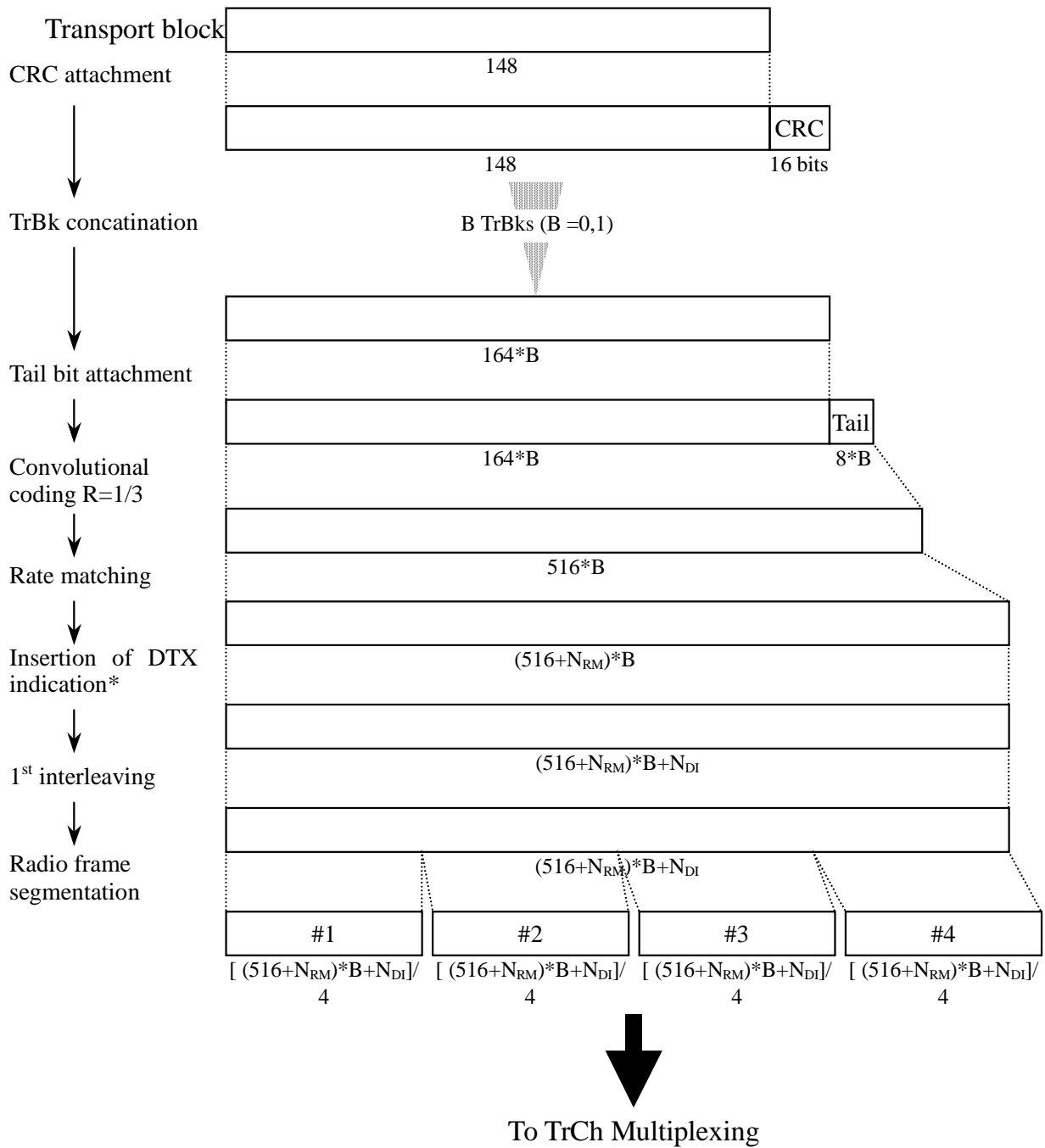

* Insertion of DTX indication is used only if the position of the TrCHs in the radio frame is fixed.

Figure 3: Channel coding and multiplexing example for 3.4 kbps data

4.1.1.3.1.2 Example for 12.2 kbps data

NOTE: This example can be applied to AMR speech.

Table 4: Parameter examples for 12.2 kbps data

The number of TrChs	3	
Transport block size	TrCH#a	0, 39 or 81bits
	TrCH#b	103 bits
	TrCH#c	60 bits
TFCS	#1	$N_{TrCHa}=1*81, N_{TrCHb}=1*103, N_{TrCHc}=1*60$ bits
	#2	$N_{TrCHa}=1*39, N_{TrCHb}=0*103, N_{TrCHc}=0*60$ bits
	#3	$N_{TrCHa}=1*0, N_{TrCHb}=0*103, N_{TrCHc}=0*60$ bits
CRC	12 bits (attached only to TrCh#a)	
CRC parity bit attachment for 0 bit transport block	Applied only to TrCH#a	
Coding	CC, coding rate = 1/3 for TrCh#a, b coding rate = 1/2 for TrCh#c	
TTI	20 ms	

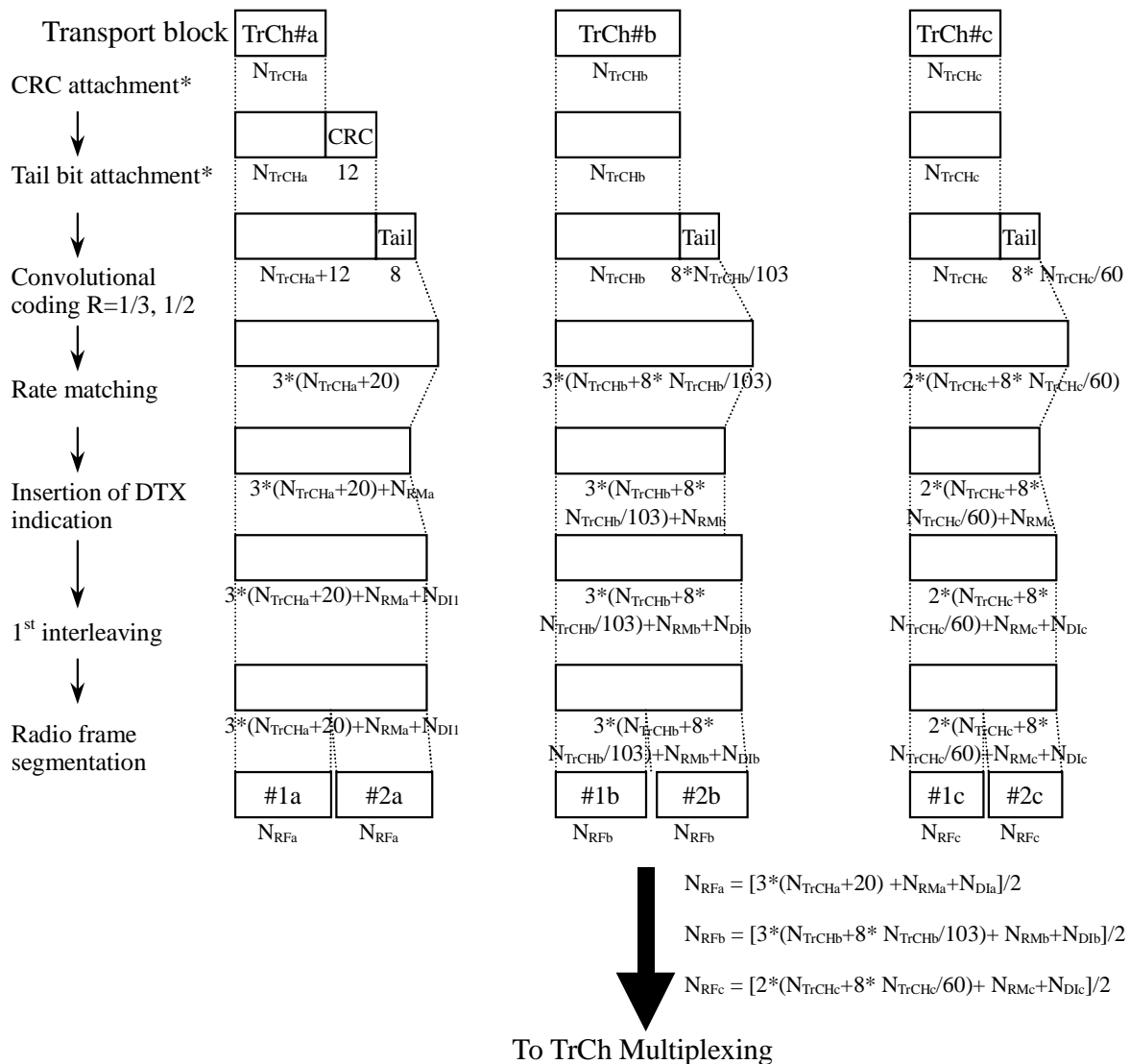

* CRC and tail bits for TrCH#a is attached even if $N_{TrCHa}=0$ bits since CRC parity bit attachment for 0 bit transport block is applied.

Figure 4: Channel coding and multiplexing example for 12.2 kbps data

4.1.1.3.1.3 Example for 28.8/57.6 kbps data

NOTE: This example can be applied to Modem or FAX.

Table 5: Parameters for 28.8/57.6 kbps data

The number of TrChs		1
Transport block size		576 bits
Transport block	28.8 kbps	576*B bits (B = 0, 1, 2)
	57.6 kbps	576*B bits (B = 0, 1, 2, 3, 4)
CRC		16 bits
Coding		Turbo coding, coding rate = 1/3
TTI		40 ms

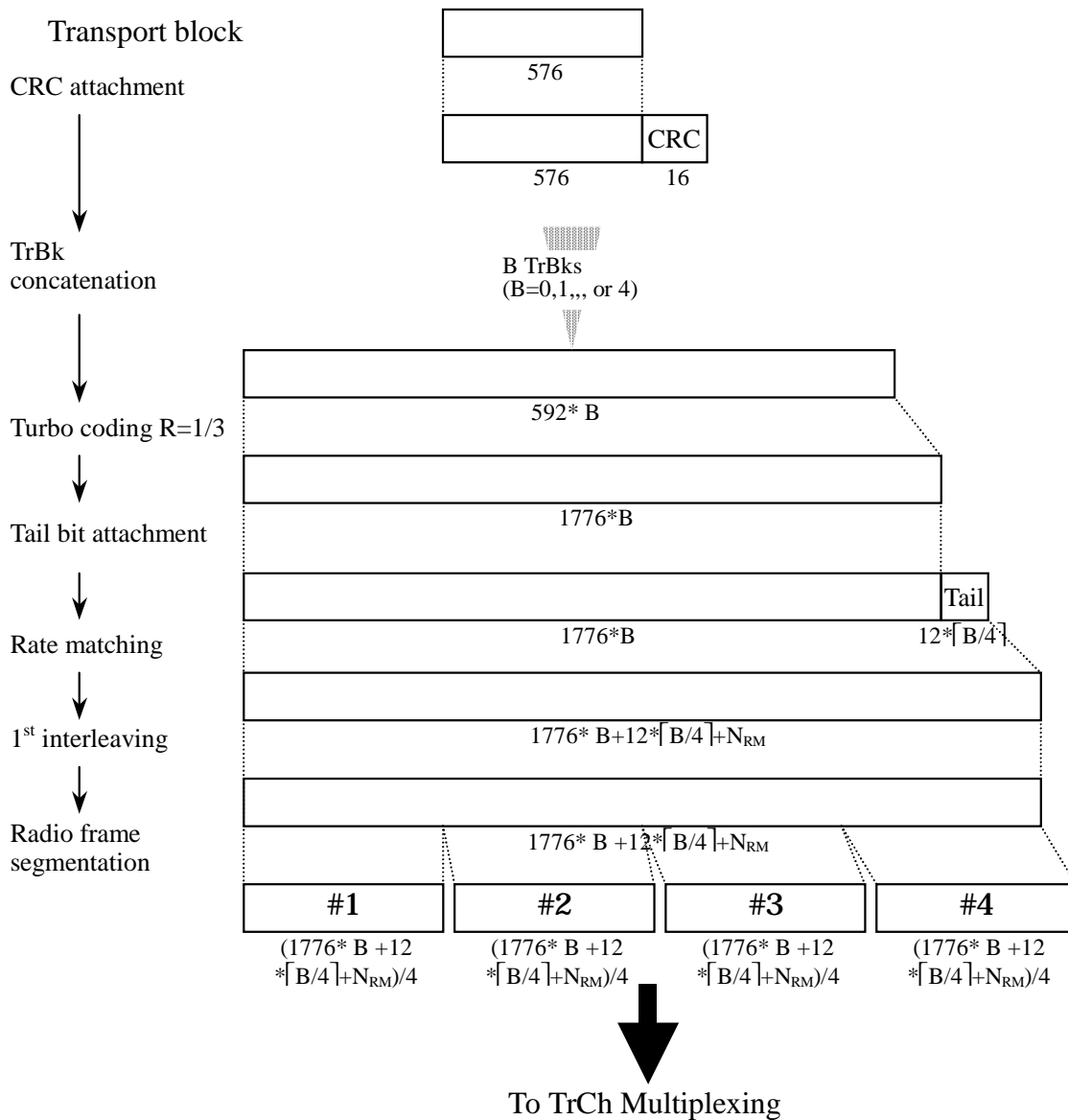

Figure 5: Channel coding and multiplexing example for 28.8/57.6 kbps data

4.1.1.3.1.4 Example for 64/128/144 kbps packet data

NOTE: In this example, it is assumed that maximum data rate of RLC payload is 64/128/144 kbps, and MAC and RLC overhead in a transport block is 16 bits.

Table 6: Parameters for 64/128/144 kbps packet data

The number of TrChs	1	
Transport block size	336 bits	
Transport block Set size	64 kbps	336*B bits (B = 0, 1, 2, 3, 4)
	128 kbps	336*B bits (B = 0, 1, 2, 4, 8)
	144 kbps	336*B bits (B = 0, 1, 2, 4, 8, 9)
CRC	16 bits	
Coding	Turbo coding, coding rate = 1/3	
TTI	20 ms	

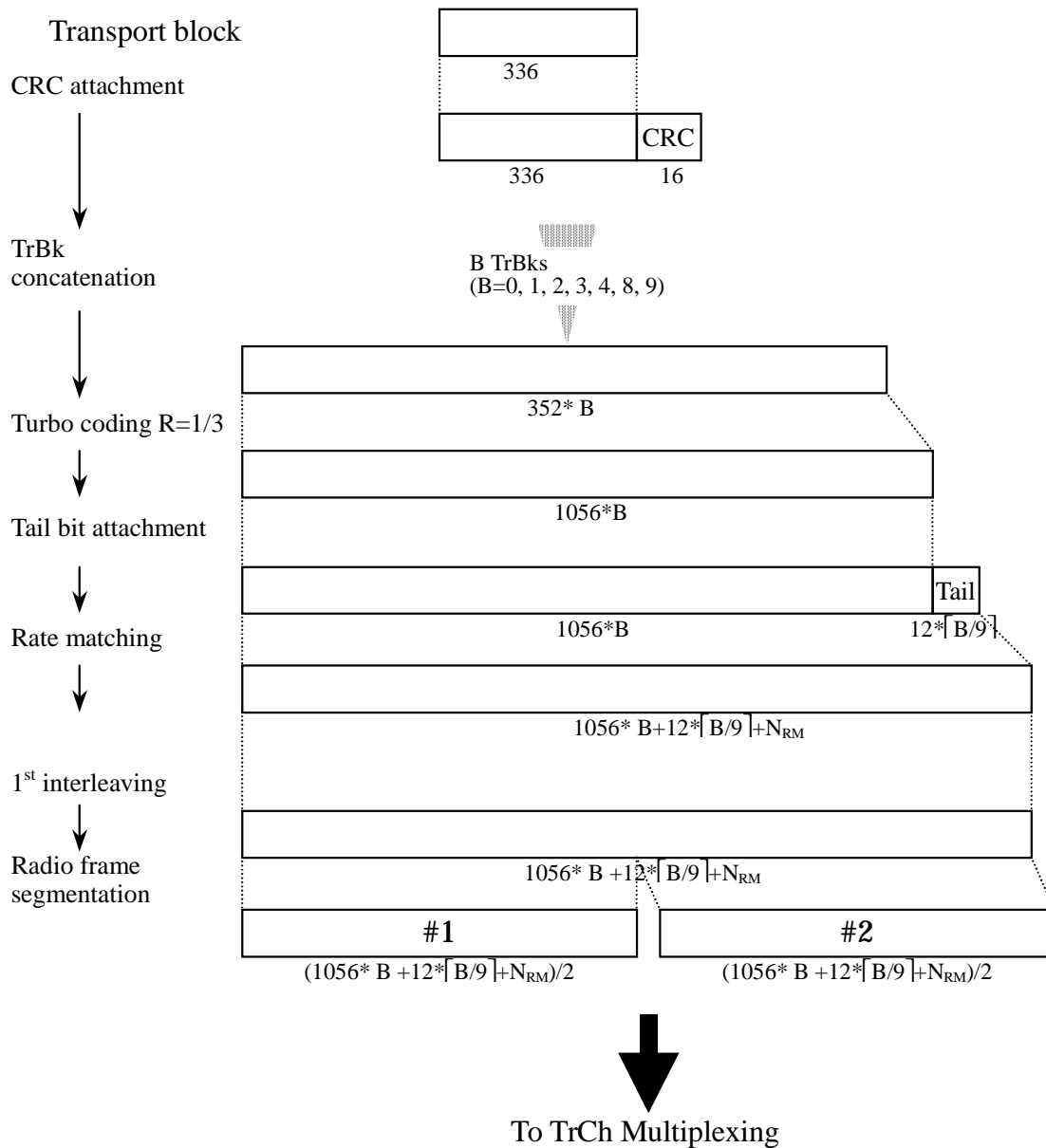

Figure 6: Channel coding and multiplexing example for 64/128/144 kbps packet data

4.1.1.3.1.5 Example for 384 kbps packet data

NOTE: In this example, it is assumed that maximum data rate of RLC payload is 384kbps, and MAC and RLC overhead in a transport block is 16 bits.

Table 7: Parameters for 384 kbps packet data

The number of TrChs	1
Transport block size	336 bits
Transport block Set size	336*B bits (B = 0, 1, 2, 4, 8, 12 for TTI=10 ms, B = 0, 1, 2, 4, 8, 12, 16, 20, 24 for TTI=20 ms)
CRC	16 bits
Coding	Turbo coding, coding rate = 1/3
TTI	10 or 20 ms

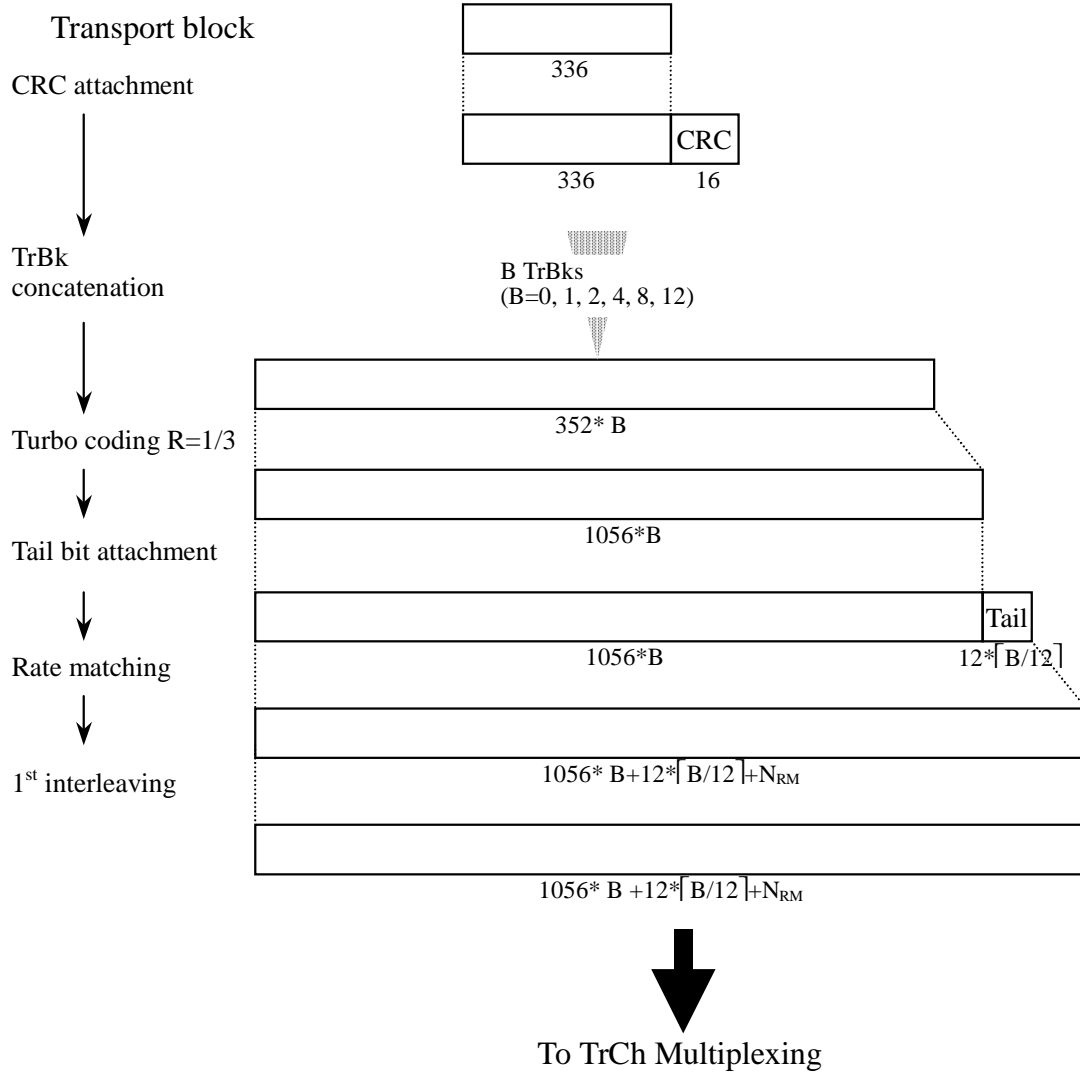

Figure 7: Channel coding and multiplexing example for 384 kbps packet data in case of TTI=10 ms

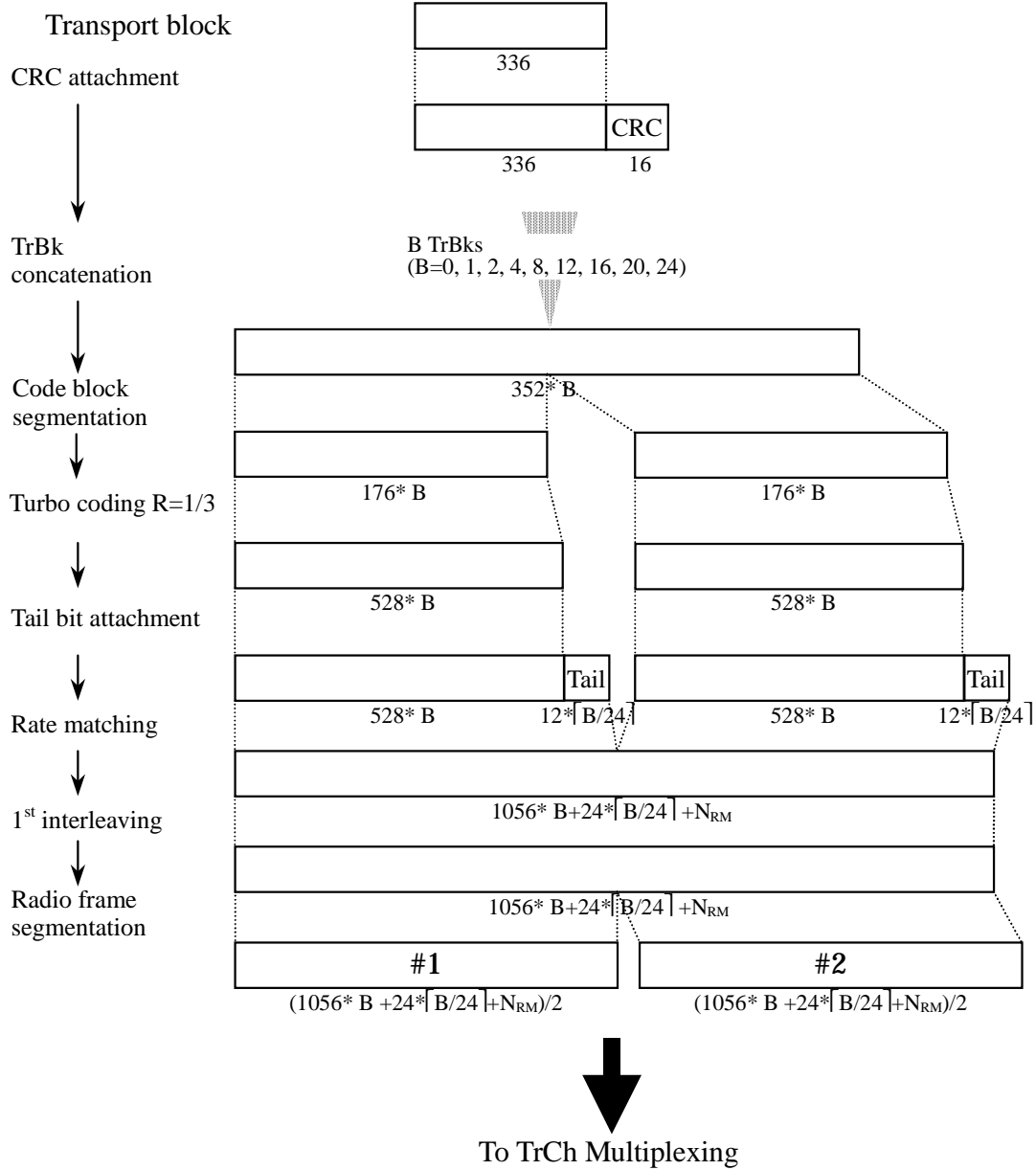

Figure 8: Channel coding and multiplexing example for 384 kbps packet data in case of TTI=20 ms

4.1.1.3.1.6 Example for 64 kbps data

NOTE: This example can be applied to ISDN service.

Table 8: Parameters for 64 kbps data

The number of TrChs	1
Transport block size	640 bits
Transport block set size	4*640 bits
CRC	16 bits
Coding	Turbo coding, coding rate = 1/3
TTI	40 ms

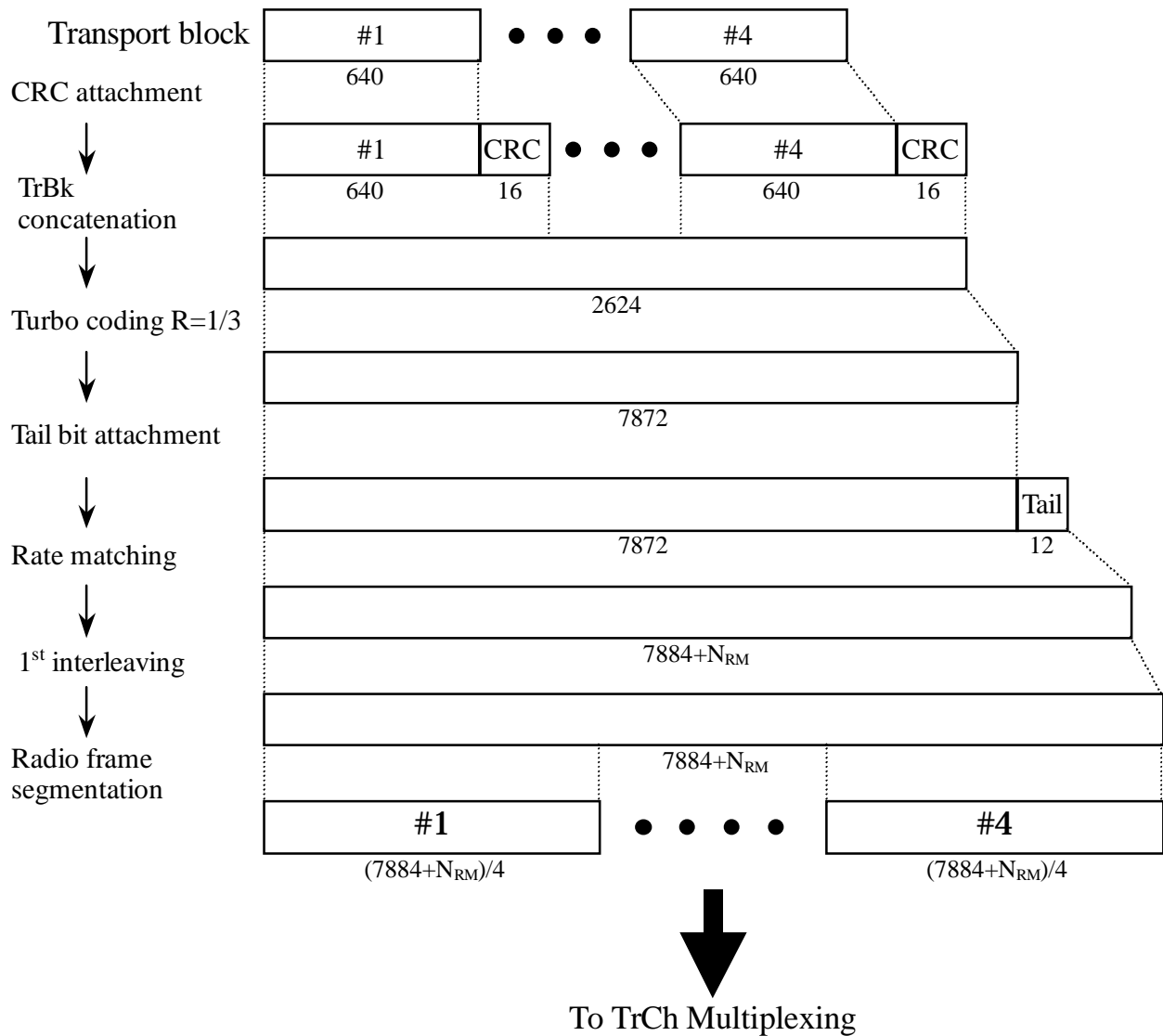

Figure 9: Channel coding and multiplexing example for 64 kbps data

4.1.1.3.2 TrCh multiplexing -> Physical channel mapping

4.1.1.3.2.1 Example for Stand-alone mapping of 3.4 kbps data

NOTE: This example can be applied to Stand-alone mapping of DCCH.

Table 9 shows example of physical channel parameters for stand-alone mapping of 3.4 kbps data.

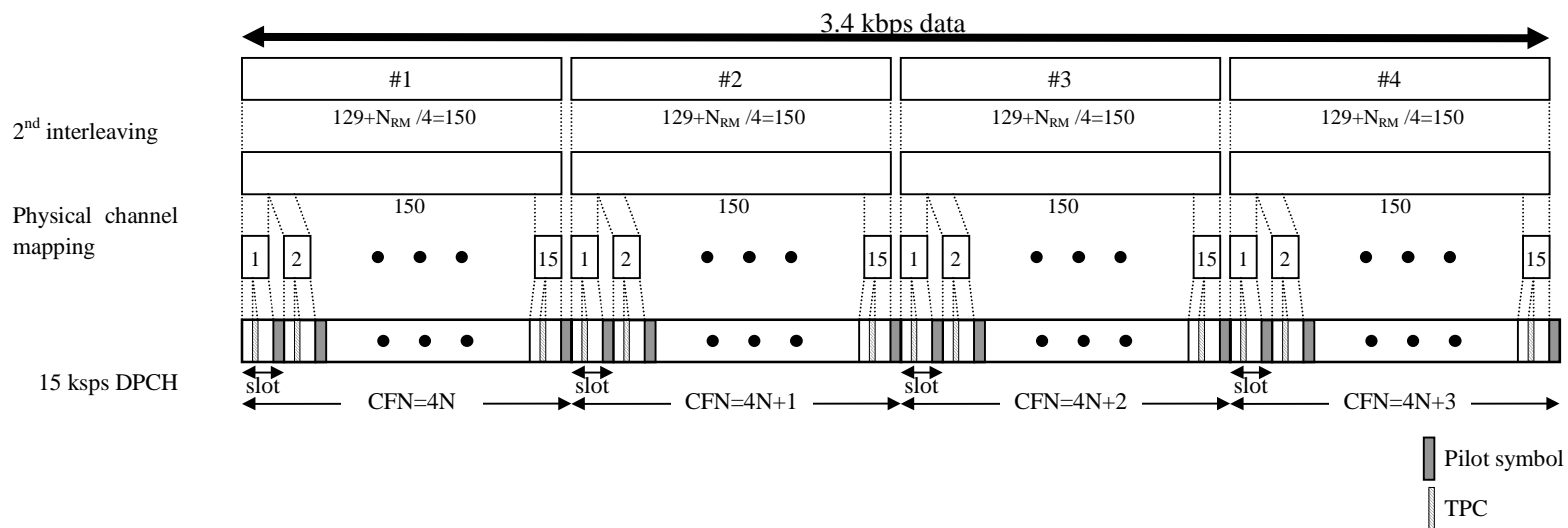

Figure 10: Channel coding and multiplexing example for stand-alone mapping of 3.4 kbps data

Table 9: Physical channel parameters for stand-alone mapping of 3.4 kbps data

Symbol rate (kps)	N _{pilot} (bits)	N _{TFCI} (bits)	N _{TPC} (bits)	N _{data1} (bits)	N _{data2} (bits)
15	4	0	2	2	12

4.1.1.3.2.2 Example for multiplexing of 12.2 kbps data and 3.4 kbps data

NOTE: This example can be applied to multiplexing AMR speech and DCCH.

Table 10 shows example of physical channel parameters for multiplexing of 12.2 kbps data and 3.4 kbps data.

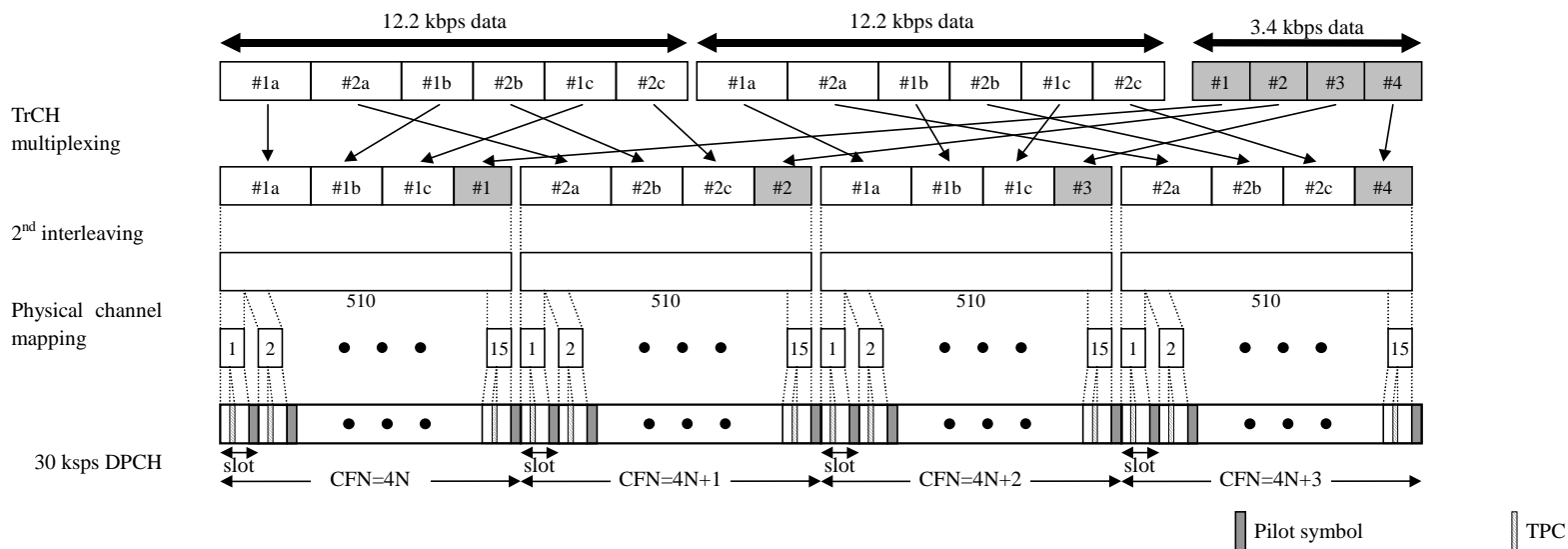

Figure 11: Channel coding and multiplexing example for multiplexing of 12.2 kbps data and 3.4 kbps data

Table 10: Physical channel parameters for multiplexing of 12.2 kbps data and 3.4 kbps data

Symbol rate (kps)	N_{pilot} (bits)	N_{TFCI} (bits)	N_{TPC} (bits)	N_{data1} (bits)	N_{data2} (bits)
30	4	0	2	6	28

4.1.1.3.2.3 Example for multiplexing of 28.8/57.6 kbps data and 3.4 kbps data

NOTE: This example can be applied to multiplexing of Modem/FAX and DCCH.

Table 11 shows example of physical channel parameters for multiplexing of 28.8/57.6 kbps data and 3.4 kbps data.

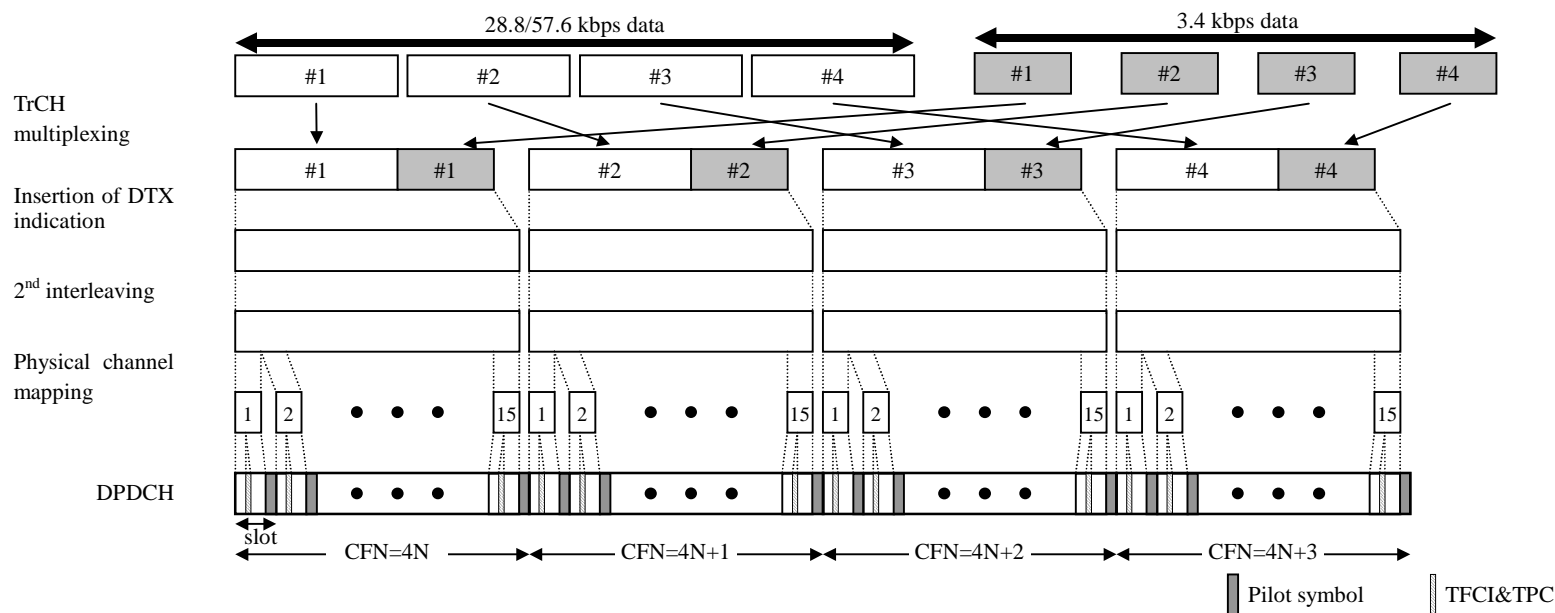

Figure 12: Channel coding and multiplexing example for multiplexing of 28.8/57.6 kbps data and 3.4 kbps data

Table 11: Physical channel parameters for multiplexing of 28.8/57.6 kbps data and 3.4 kbps data

Data rate (kbps)	Symbol rate (ksps)	No. of physical channel: P	N_{pilot} (bits)	N_{TFCI} (bits)	N_{TPC} (bits)	N_{data1} (bits)	N_{data2} (bits)
28.8	60	1	8	8	4	12	48
57.6	120	1	8	8	4	28	112

4.1.1.3.2.4 Example for multiplexing of 64/128/144/384 kbps packet data and 3.4 kbps data

NOTE: This example can be applied to multiplexing 64/128/144/384 kbps packet data and DCCH.

Table 12 shows example of physical channel parameters for multiplexing of 64/128/144/384 kbps packet data and 3.4 kbps data.

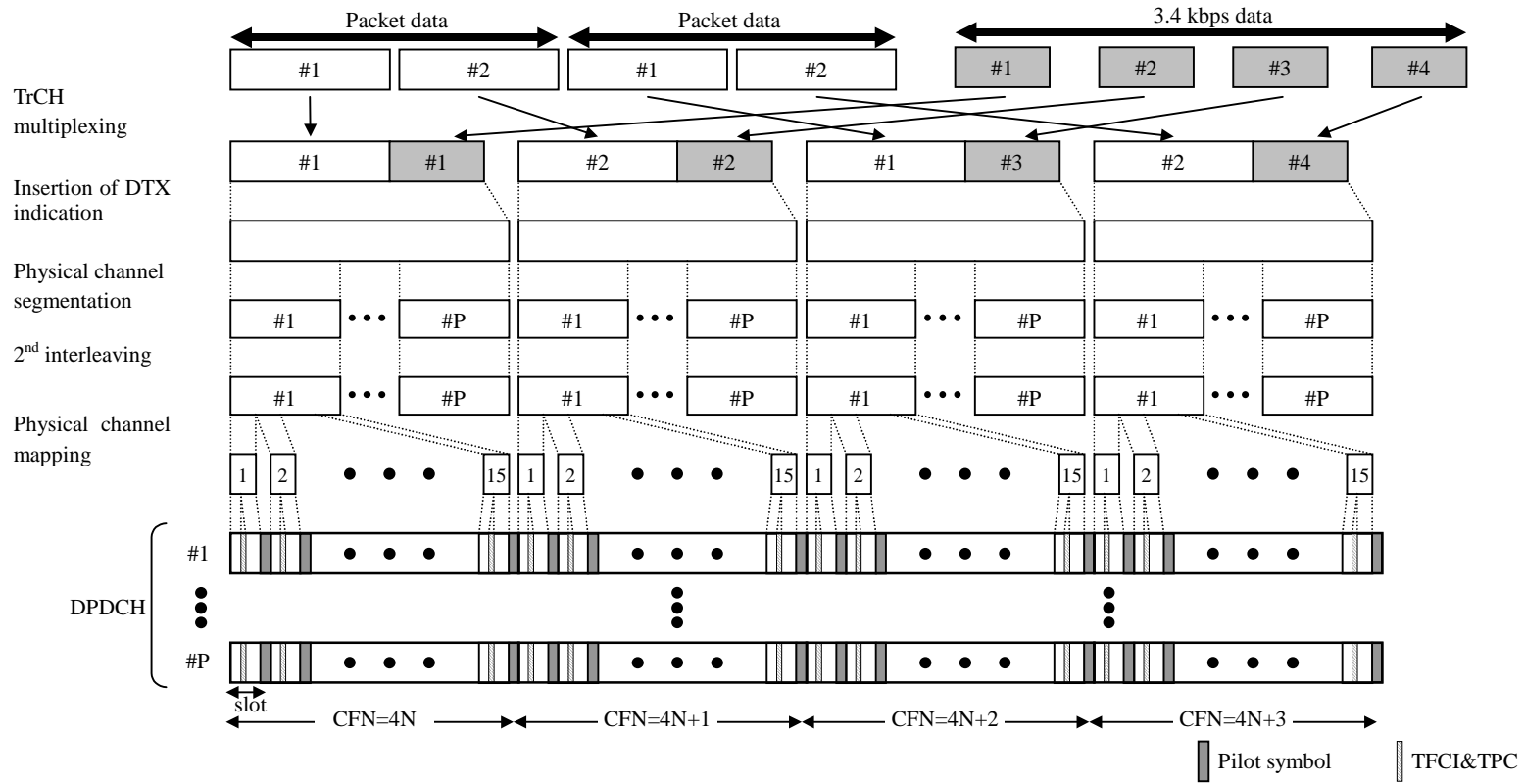

Figure 13: Channel coding and multiplexing example for multiplexing of 64/128/144/384 kbps packet data and 3.4 kbps data

Table 12: Physical channel parameters for multiplexing of 64/128/144/384 kbps packet data and 3.4 kbps data

Data rate (kbps)	Symbol rate (ksps)	No. of physical channel: P	N _{pilot} (bits)	N _{TFCI} (bits)	N _{TPC} (bits)	N _{data1} (bits)	N _{data2} (bits)
64	120	1	8	8	4	28	112
128	240	1	16	8	8	56	232
144	240	1	16	8	8	56	232
384	240	3	16	8	8	56	232
	480	1	16	8	8	120	488

4.1.1.3.2.5 Example for multiplexing of 64 kbps data and 3.4 kbps data

NOTE: This example can be applied to multiplexing ISDNs data and DCCH.

Table 13 shows example of physical channel parameters for multiplexing of 64 kbps data and 3.4 kbps data.

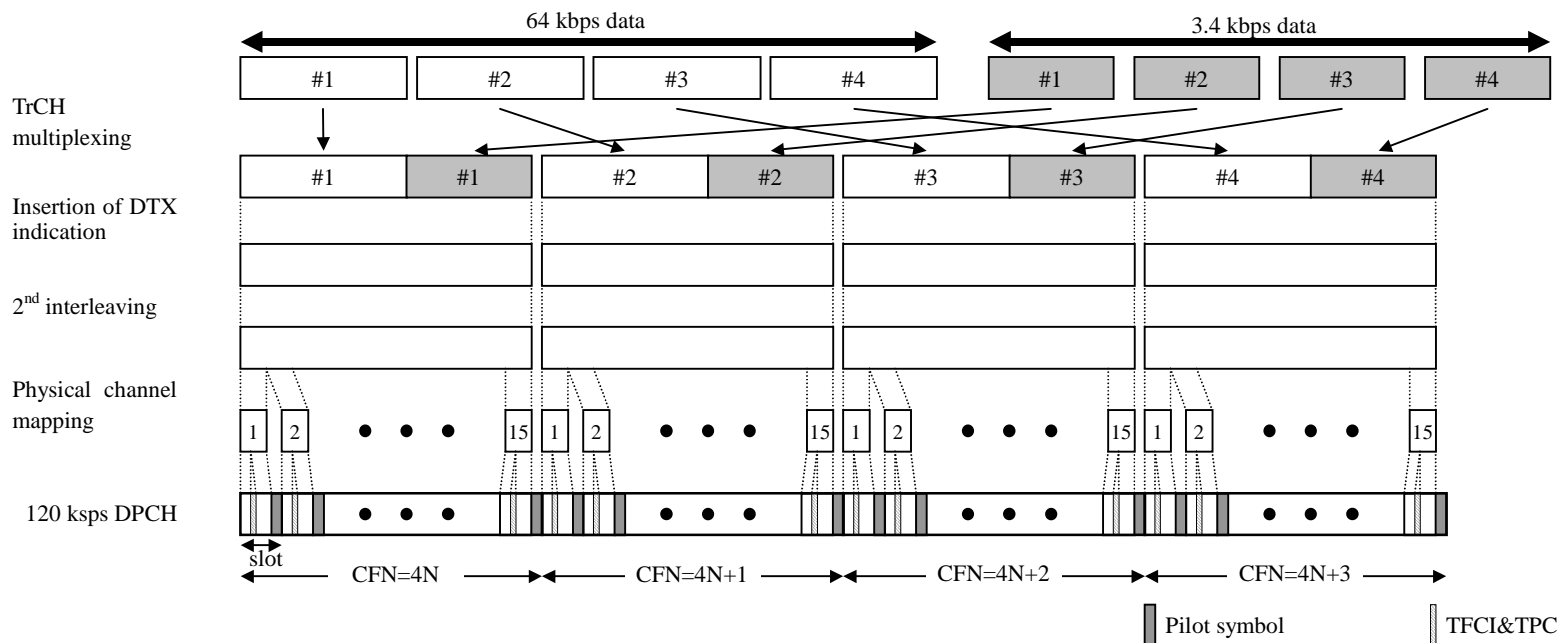

Figure 14: Channel coding and multiplexing example for multiplexing of 64 kbps data and 3.4 kbps data

Table 13: Physical channel parameters for multiplexing of 64 kbps data and 3.4 kbps data

Symbol rate (ksps)	No. of physical channel	N_{pilot} (bits)	N_{TFCI} (bits)	N_{TPC} (bits)	N_{data1} (bits)	N_{data2} (bits)
120	1	8	8*	4	28	112

4.1.1.3.2.6 Example for multiplexing of 12.2 kbps data, 64/128/144/384 kbps packet data and 3.4 kbps data

NOTE: This example is corresponding to multiplexing of AMR speech, 64/128/144/384 kbps packet and DCCH.

Table 14 shows example of physical channel parameters for multiplexing of 12.2 kbps data, 64/128/144/384 kbps packet data and 3.4 kbps data.

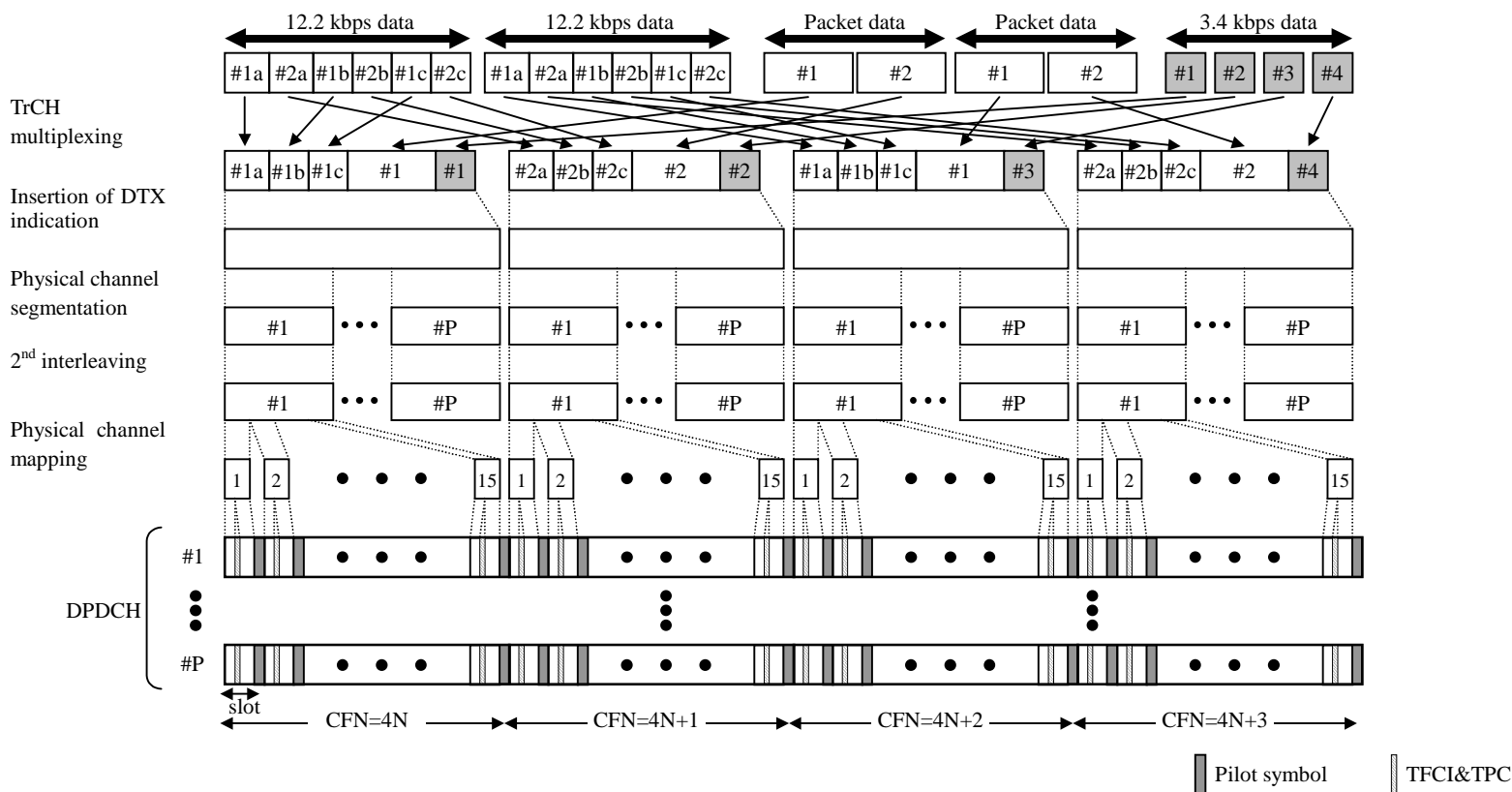

Figure 15: Channel coding and multiplexing example for multiplexing of 12.2 kbps data, 64/128/144/384 kbps packet data and 3.4 kbps data

Table 14: Physical channel parameters for multiplexing of 12.2 kbps data, 64/128/144/384 kbps packet data and 3.4 kbps data

Data rate (kbps)	Symbol rate (ksps)	No.of physical channel: P	N _{pilot} (bits)	N _{TFCI} (bits)	N _{TPC} (bits)	N _{data1} (bits)	N _{data2} (bits)
64	120	1	8	8	4	28	112
128	240	1	16	8	8	56	232
144	240	1	16	8	8	56	232
384	240	3	16	8	8	56	232
	480	1	16	8	8	120	488

4.1.2 Uplink

4.1.2.1 Example for RACH

Table 15: Parameter examples for RACH

Transport block size	$N_{RACH}=168$ or 360 bits
CRC	16 bits
Coding	CC, coding rate = $1/2$
TTI	20 ms
Minimum spreading factor	32

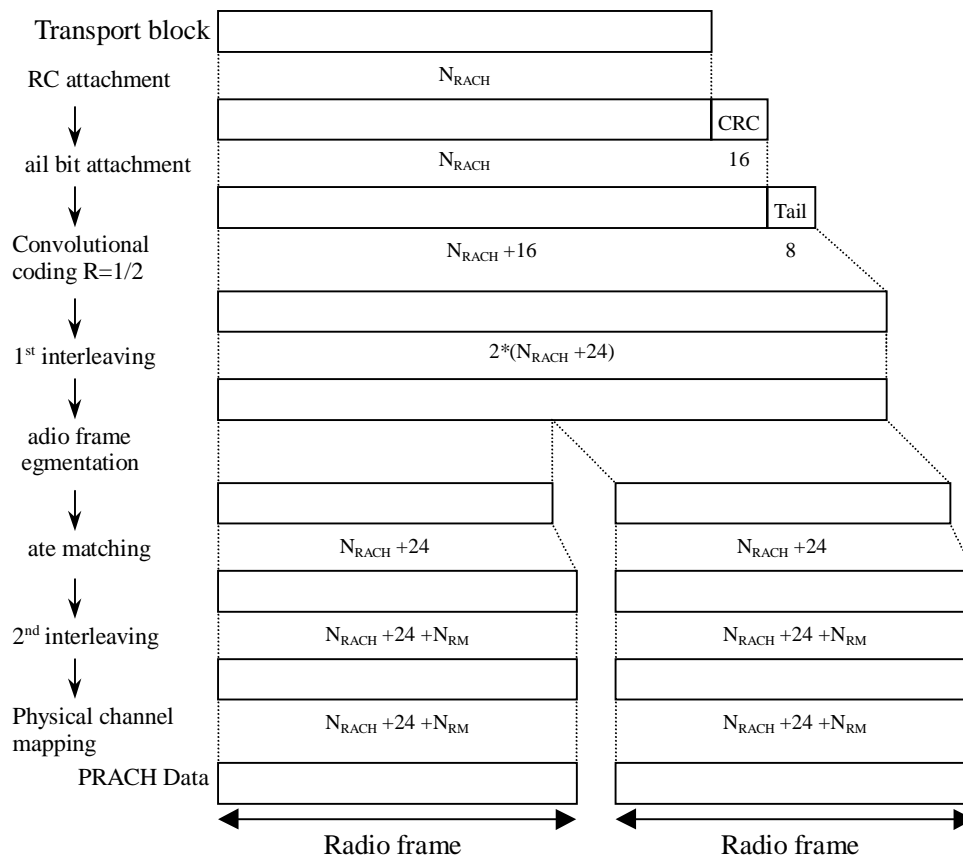

Figure 16: Channel coding and multiplexing example for PRACH

4.1.2.2 Example for DCH

4.1.2.2.1 DCH -> Radio frame segmentation

4.1.2.2.1.1 Example for 3.4 kbps data

NOTE: This example can be applied to DCCH.

NOTE: In this example, it is assumed that maximum data rate of RLC payload is 3.4 kbps, and that MAC and RLC overhead in a transport block is 12 bits.

Table 16: Parameter examples for 3.4 kbps data

Transport block size	148 bits
Transport block set size	0, 148 bits
CRC	16 bits
Coding	CC, coding rate = 1/3
TTI	40 ms

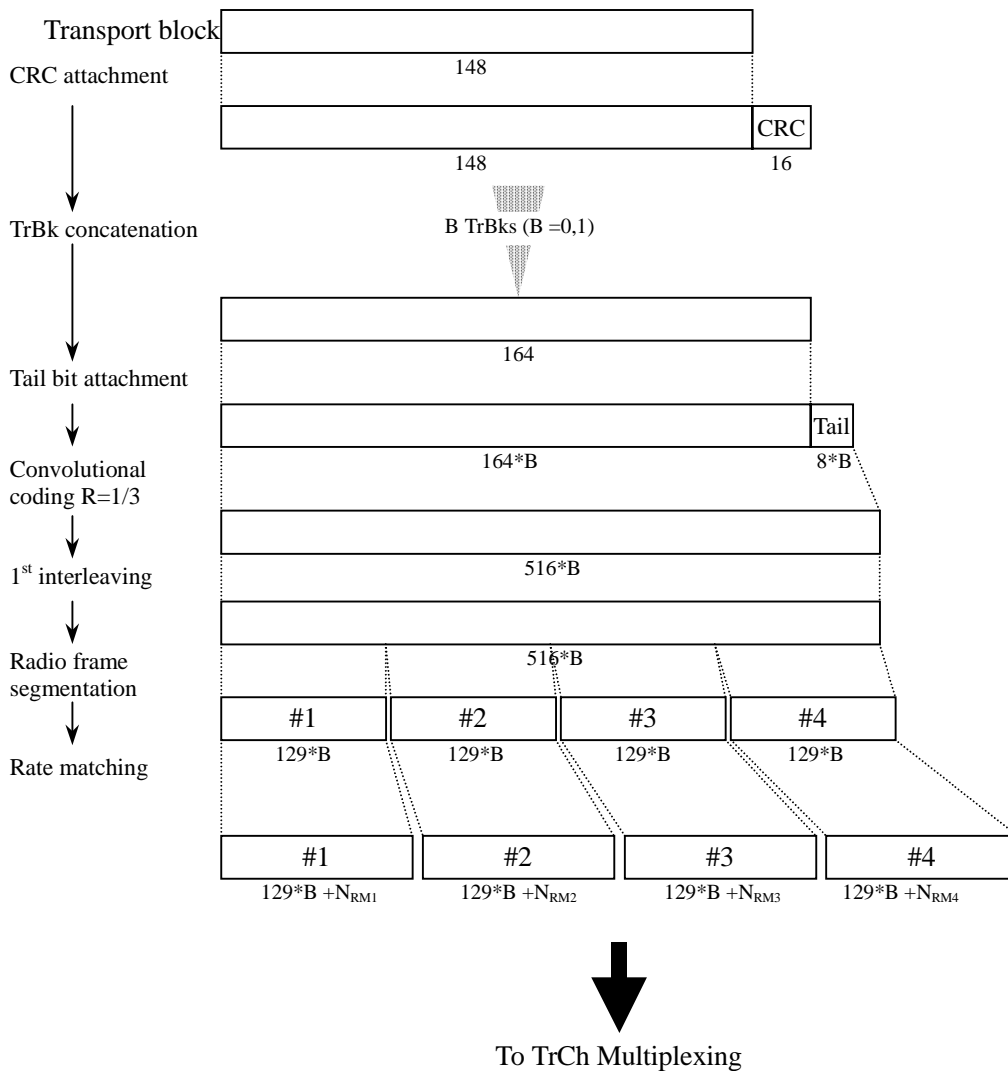

Figure 17: Channel coding and multiplexing example for 3.4 kbps data

4.1.2.2.1.2 Example for 12.2 kbps data

NOTE: This example can be applied to AMR speech.

Table 17: Parameter examples for 12.2 kbps data

The number of TrChs		3
Transport block size	TrCH#a	39 or 81 bits
	TrCH#b	103 bits
	TrCH#c	60 bits
TFCS	#1	$N_{TrCHa}=1*81, N_{TrCHb}=1*103, N_{TrCHc}=1*60$ bits
	#2	$N_{TrCHa}=1*39, N_{TrCHb}=0*103, N_{TrCHc}=0*60$ bits
	#3	$N_{TrCHa}=0*81, N_{TrCHb}=0*103, N_{TrCHc}=0*60$ bits
CRC		12 bits (attached only to TrCh#a)
Coding		CC, coding rate = 1/3 for TrCh#a, b coding rate = 1/2 for TrCh#c
TTI		20 ms

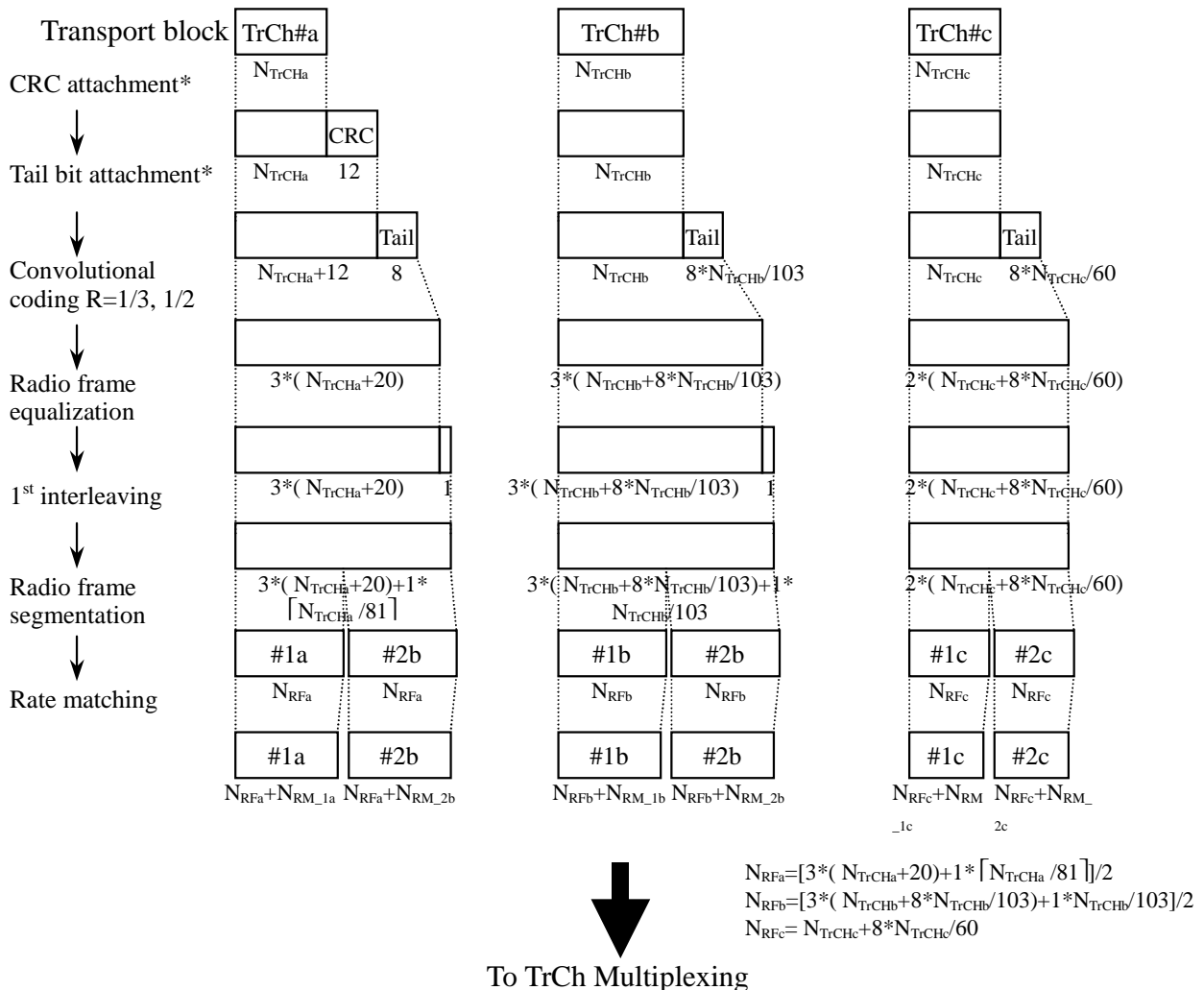

Figure 18: Channel coding and multiplexing example for 12.2 kbps data

4.1.2.2.1.3 Example for 28.8/57.6 kbps data

NOTE: This example can be applied to Modem or FAX.

Table 18: Parameters for 28.8/57.6 kbps packet data

The number of TrChs		1
Transport block size		576 bits
Transport block	28.8 kbps	576*B bits (B = 0, 1, 2)
Set size	57.6 kbps	576*B bits (B = 0, 1, 2, 3, 4)
CRC		16 bits
Coding		Turbo coding, coding rate = 1/3
TTI		40 ms

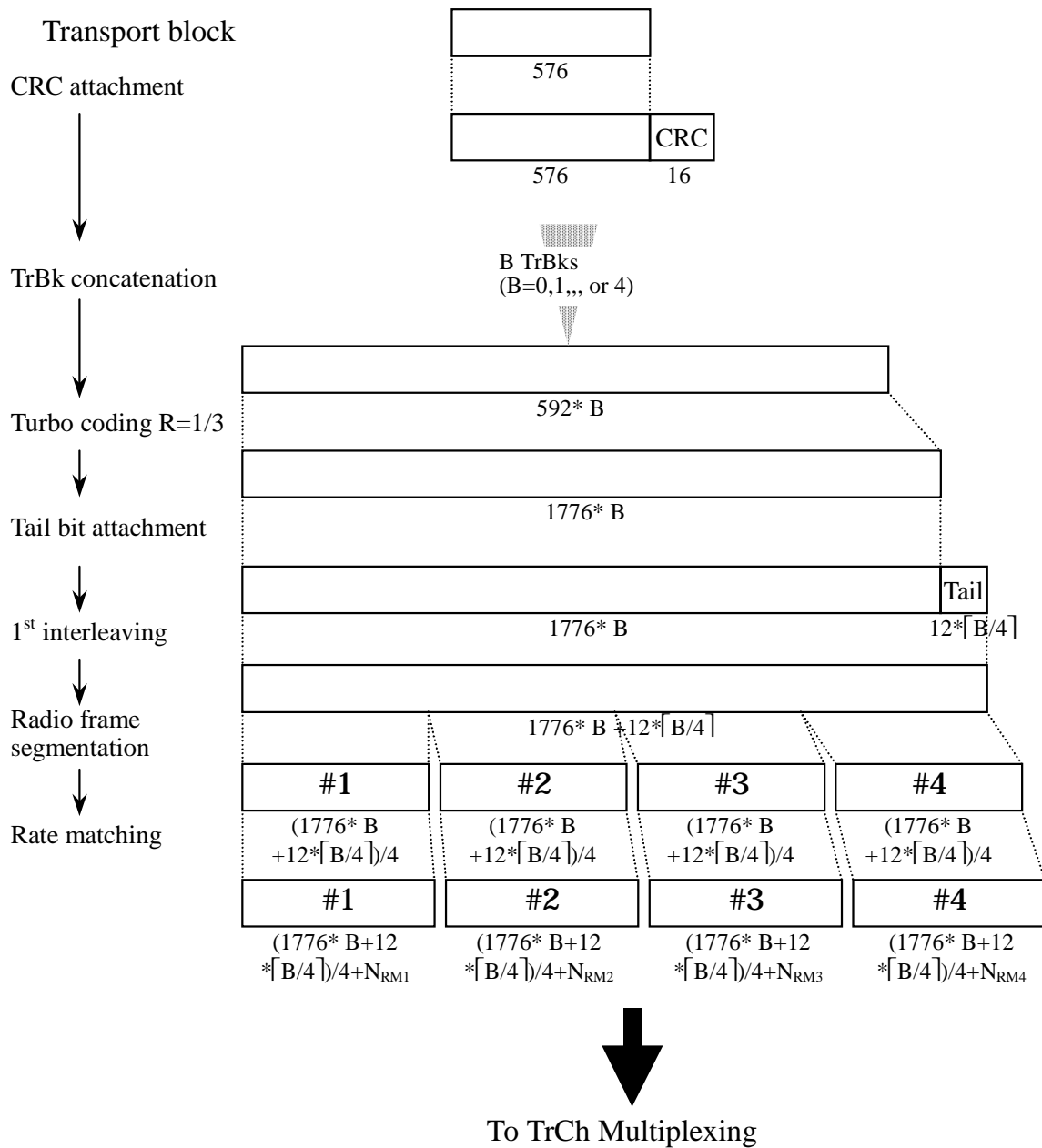

Figure 19: Channel coding and multiplexing example for 28.8/57.6 kbps data

4.1.2.2.1.4 Example for 64/128/144 kbps packet data

NOTE: In this example, it is assumed that maximum data rate of RLC payload is 64/128/144 kbps, and MAC and RLC overhead in a transport block is 16 bits.

Table 19: Parameters for 64/128/144 kbps packet data

The number of TrChs	1	
Transport block size	336 bits	
Transport block Set size	64 kbps	$336 \cdot B$ bits ($B = 0, 1, 2, 3, 4$)
	128 kbps	$336 \cdot B$ bits ($B = 0, 1, 2, 4, 8$)
	144 kbps	$336 \cdot B$ bits ($B = 0, 1, 2, 4, 8, 9$)
CRC	16 bits	
Coding	Turbo coding, coding rate = 1/3	
TTI	20 ms	

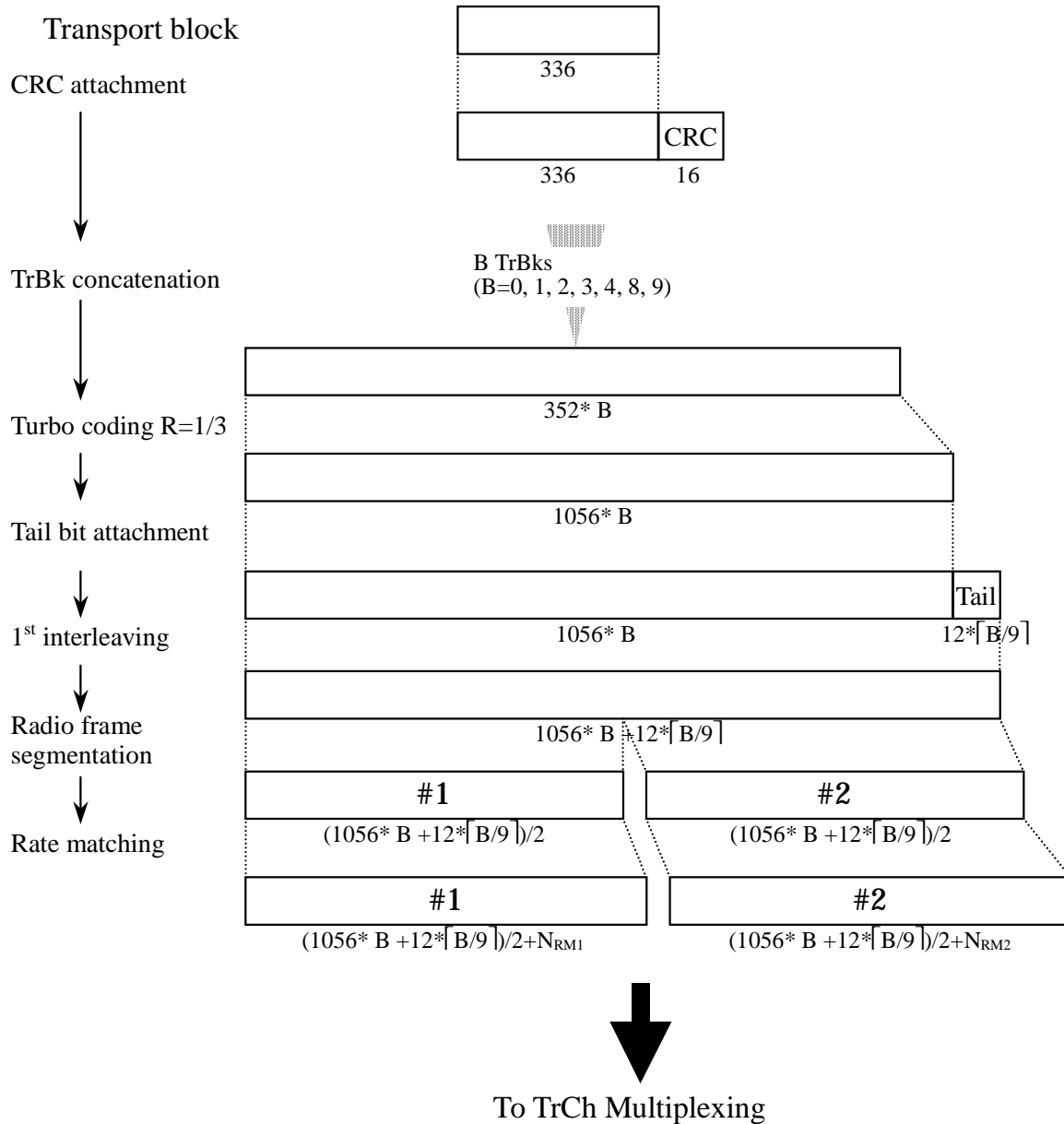

Figure 20: Channel coding and multiplexing example for 64/128/144 kbps packet data

4.1.2.2.1.5 Example for 384 kbps packet data

NOTE: In this example, it is assumed that maximum data rate of RLC payload is 384kbps, and MAC and RLC overhead in a transport block is 16 bits.

Table 20: Parameters for 384 kbps packet data

The number of TrChs	1
Transport block size	336 bits
Transport block Set size 384 kbps	336*B bits (B = 0, 1, 2, 4, 8, 12, 16, 20, 24)
CRC	16 bits
Coding	Turbo coding, coding rate = 1/3
TTI	20 ms

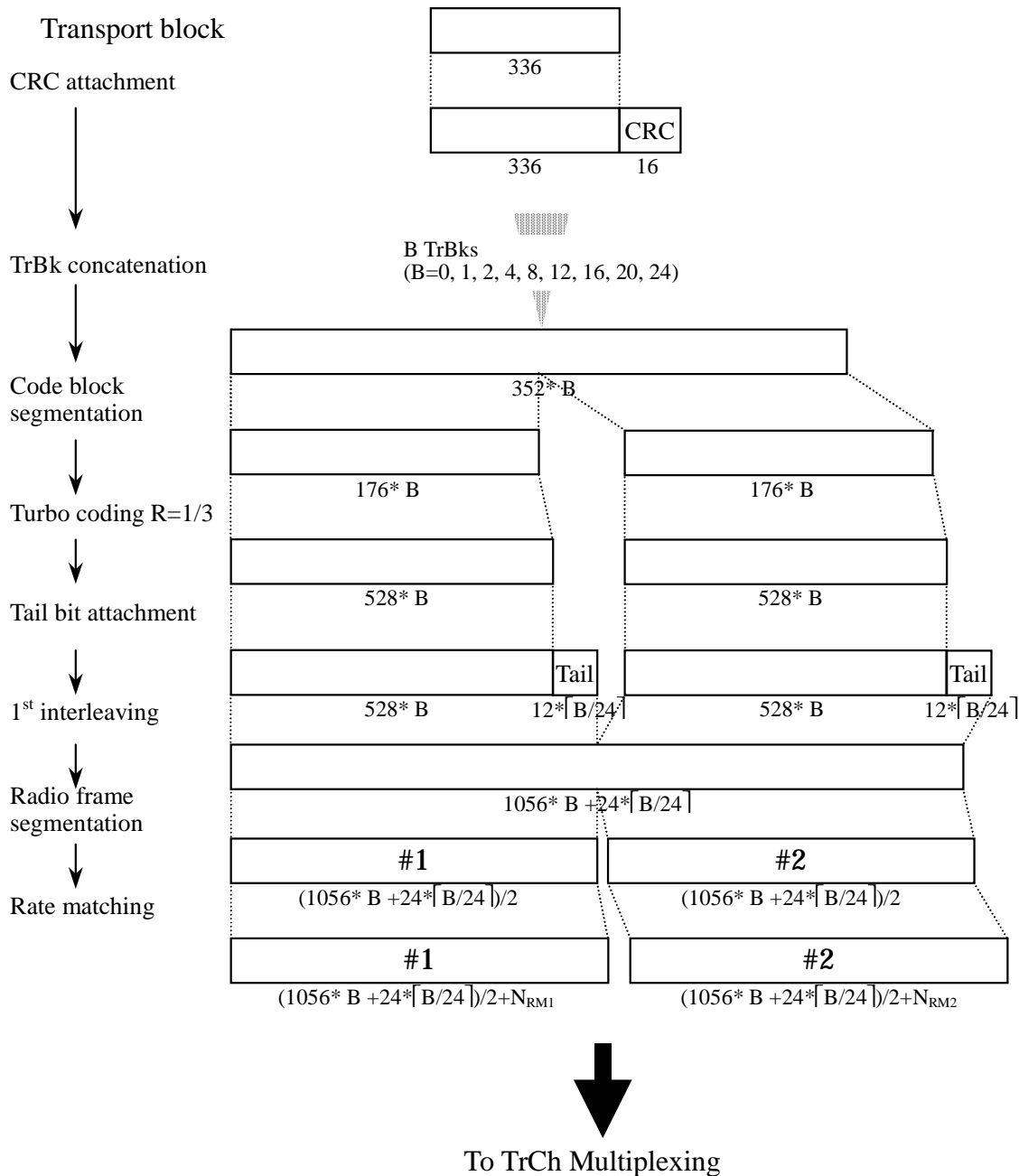

Figure 21: Channel coding and multiplexing example for 384 kbps packet data

4.1.2.2.1.6 Example for 64 kbps data

NOTE: This example can be applied to ISDN service.

Table 21: Parameters for 64 kbps data

The number of TrChs	1
Transport block size	640 bits
Transport block set size	4*640 bits
CRC	16 bits
Coding	Turbo coding, coding rate = 1/3
TTI	40 ms

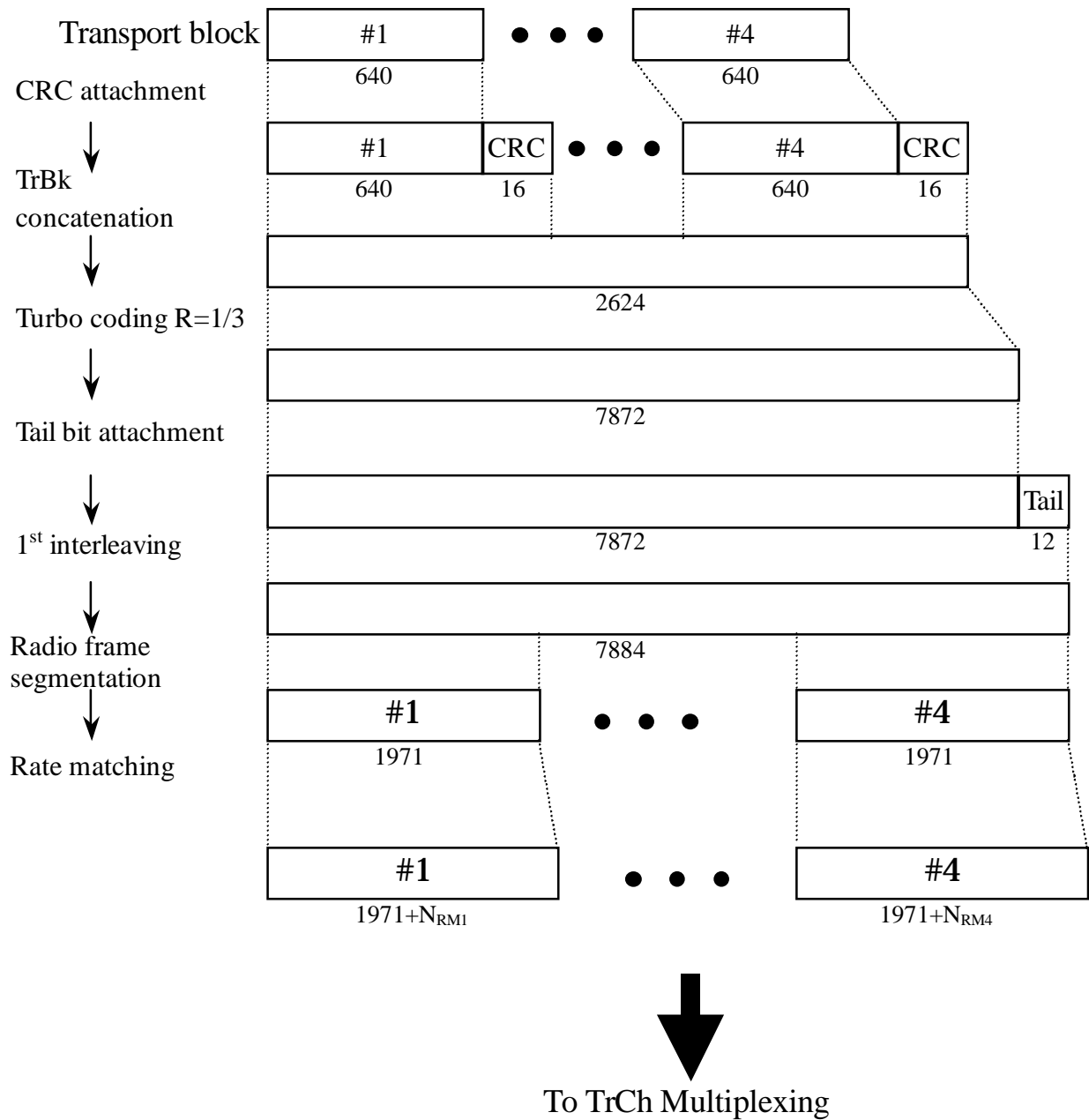

Figure 22: Channel coding and multiplexing example for 64 kbps data

4.1.2.2.2 TrCH multiplexing -> Physical channel mapping

4.1.2.2.2.1 Example for Stand-alone mapping of 3.4 kbps data

NOTE: This example can be applied to Stand-alone mapping of DCCH.

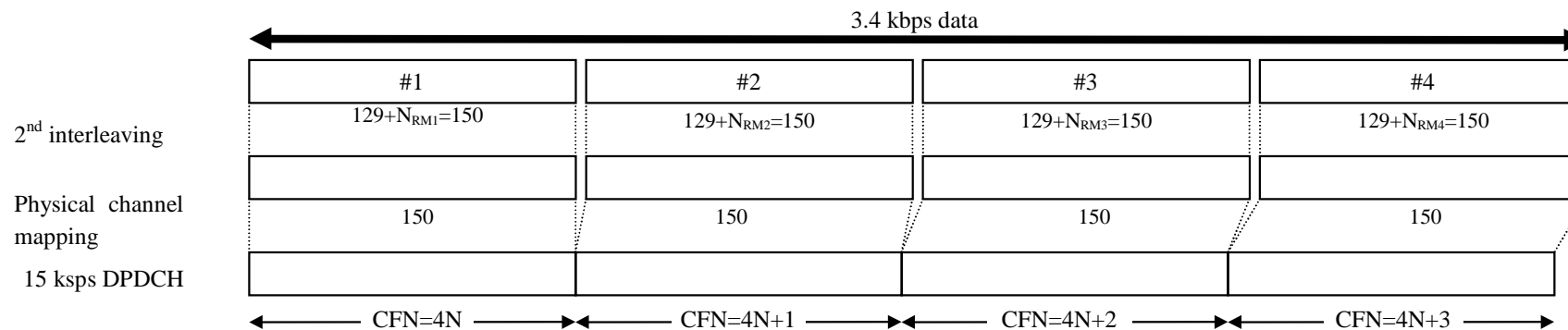

Figure 23: Channel coding and multiplexing example for stand-alone mapping of 3.4 kbps data

4.1.2.2.2.2 Example for multiplexing of 12.2 kbps data and 3.4 kbps data

NOTE: This example can be applied to multiplexing AMR speech and DCCH.

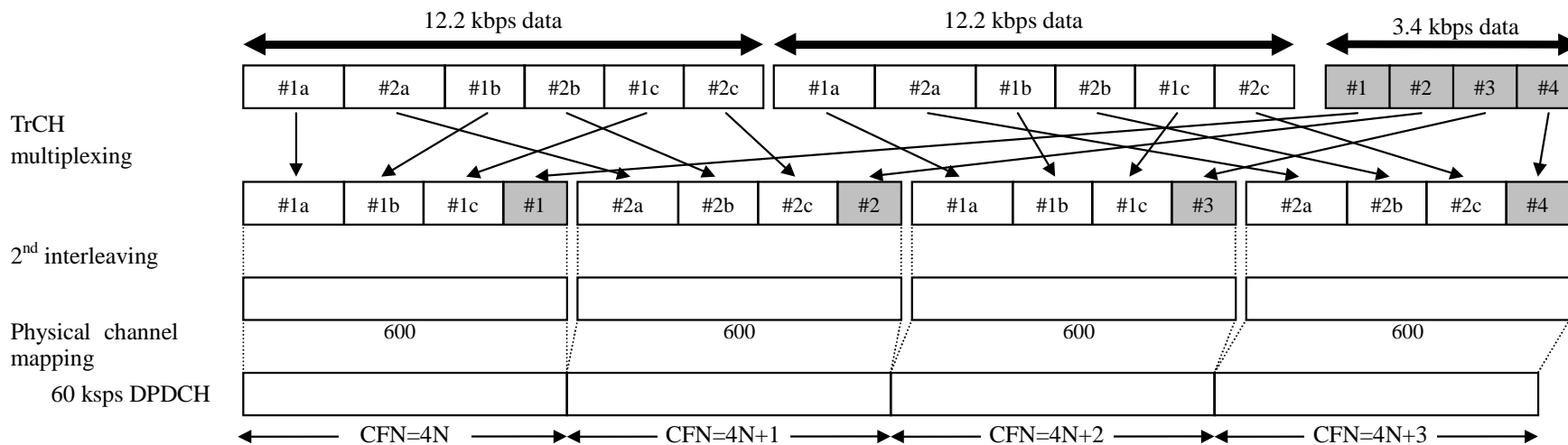

Figure 24: Channel coding and multiplexing example for multiplexing of 12.2 kbps data and 3.4 kbps data

4.1.2.2.2.3 Example for multiplexing of 28.8/57.6 kbps data and 3.4 kbps data

NOTE: This example can be applied to multiplexing Modem/FAX and DCCH.

Table 22 shows example of physical channel parameters for multiplexing of 28.8/57.6 kbps data and 3.4 kbps data.

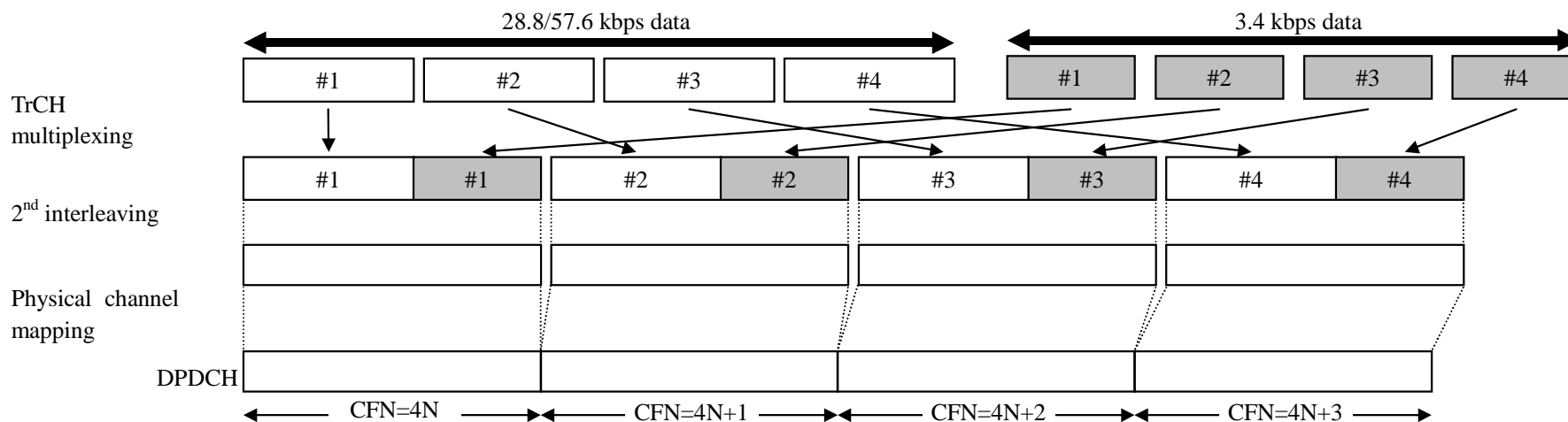

Figure 25: Channel coding and multiplexing example for multiplexing of 28.8/57.6 kbps packet data and 3.4 kbps data

Table 22: Physical channel parameters for multiplexing of 28.8/57.6 kbps packet data and 3.4 kbps data

Data rate (kbps)	Maximum symbol rate (ksps)	No. of physical channel
28.8	120	1
57.6	240	1

4.1.2.2.2.4 Example for multiplexing of 64/128/144/384 kbps packet data and 3.4 kbps data

NOTE: This example can be applied to multiplexing 64/128/144/384 kbps packet data and DCCH.

Table 23 shows example of physical channel parameters for multiplexing of 64/128/144/384 kbps packet data and 3.4 kbps data.

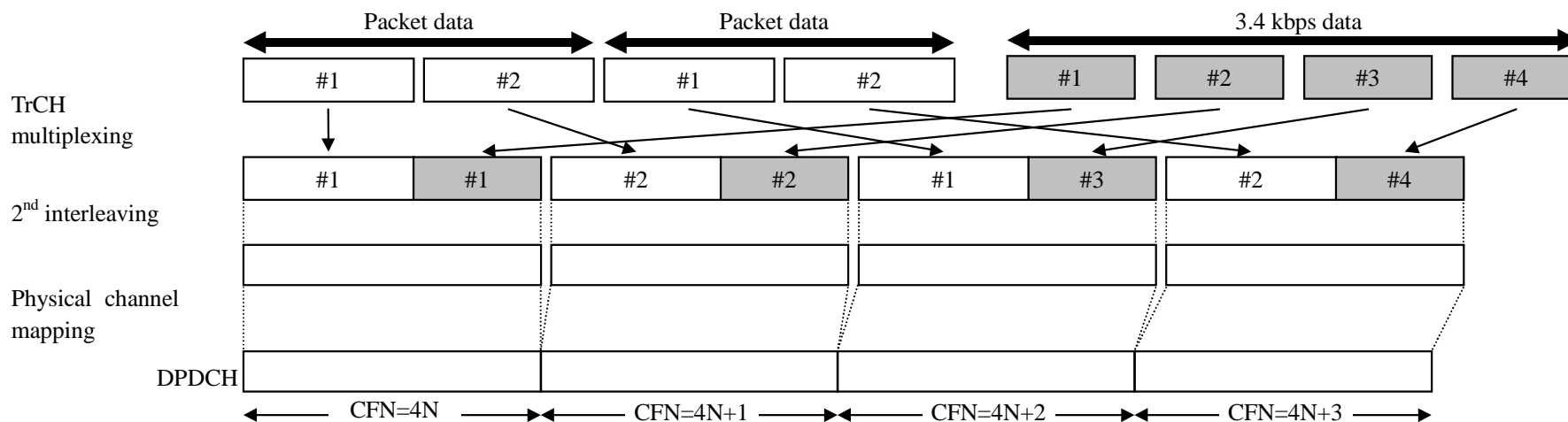

Figure 26: Channel coding and multiplexing example for multiplexing of 64/128/144/384 kbps packet data and 3.4 kbps data

Table 23: Physical channel parameters for multiplexing of 64/128/144/384 kbps packet data and 3.4 kbps data

Data rate (kbps)	Maximum symbol rate (ksps)	No. of physical channel
64	240	1
128	480	1
144	480	1
384	960	1

4.1.2.2.2.5 Example for multiplexing of 64 kbps data and 3.4 kbps data

NOTE: This example can be applied to multiplexing ISDNs data and DCCH.

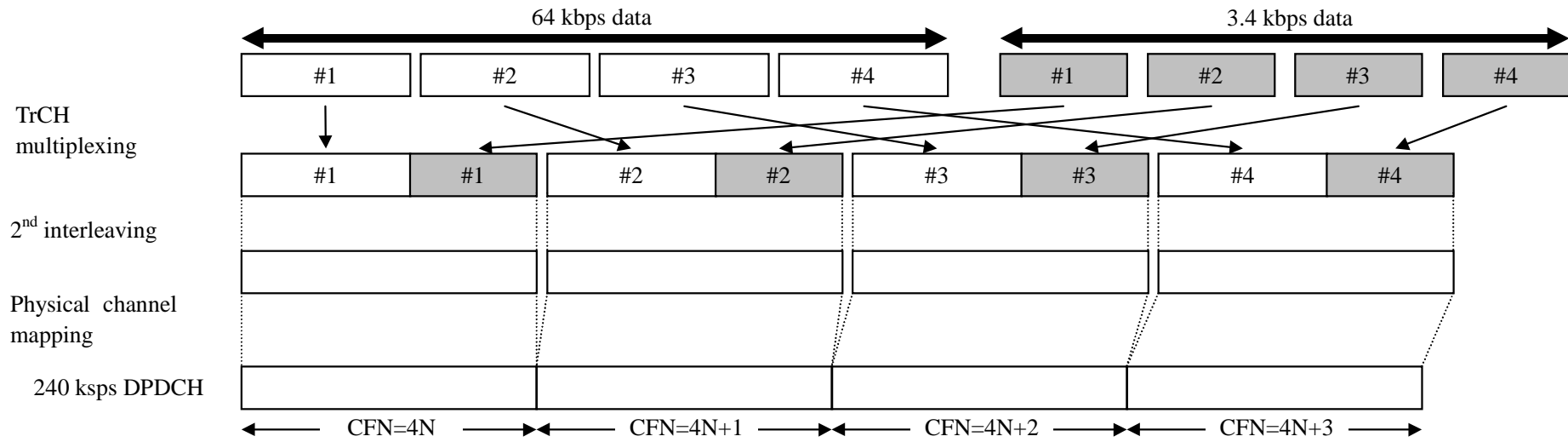

Figure 27: Channel coding and multiplexing example for multiplexing of 64 kbps data and 3.4 kbps data

4.1.2.2.6 Example for multiplexing of 12.2 kbps data, 64/128/144/384 kbps packet data and 3.4 kbps data

NOTE: This example is corresponding to multiplexing of AMR speech, 64/128/144/384 kbps packet and DCCH.

Table 24 shows example of physical channel parameters for multiplexing of 12.2 kbps data, 64/128/144/384 kbps packet data and 3.4 kbps data.

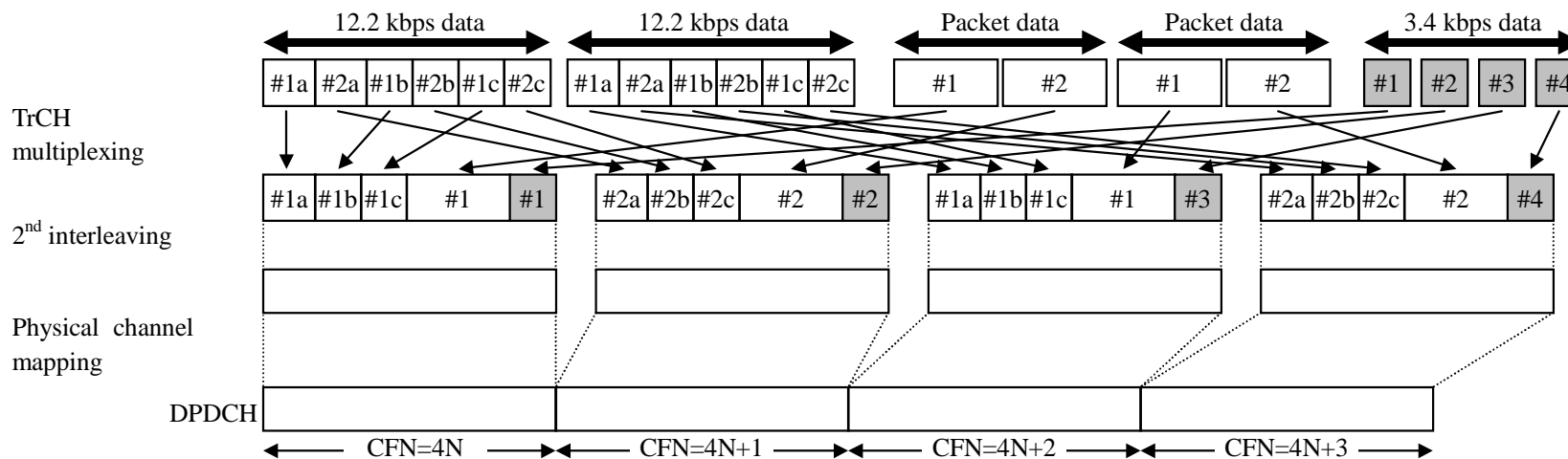

Figure 28: Channel coding and multiplexing example for multiplexing of 12.2 kbps data, 64/128/144/384 kbps packet data and 3.4 kbps data

Table 24: Physical channel parameters for multiplexing of 12.2 kbps data, 64/128/144/384 kbps packet data and 3.4 kbps data

Data rate (kbps)	Maximum symbol rate (ksps)	No. of physical channel
64	240	1
128	480	1
144	480	1
384	960	1

4.2 TDD mode

4.2.1 Downlink

4.2.1.1 BCH

Table 25: Parameters for BCH

Transport block size	246 bit
CRC	16 bit
Coding	CC, coding rate = 1/2
TTI	20 ms
Midamble	512 chips
Codes and time slots	SF = 16 x 1 x 1 time slot
TFCI	0 bit
TPC	0 bit

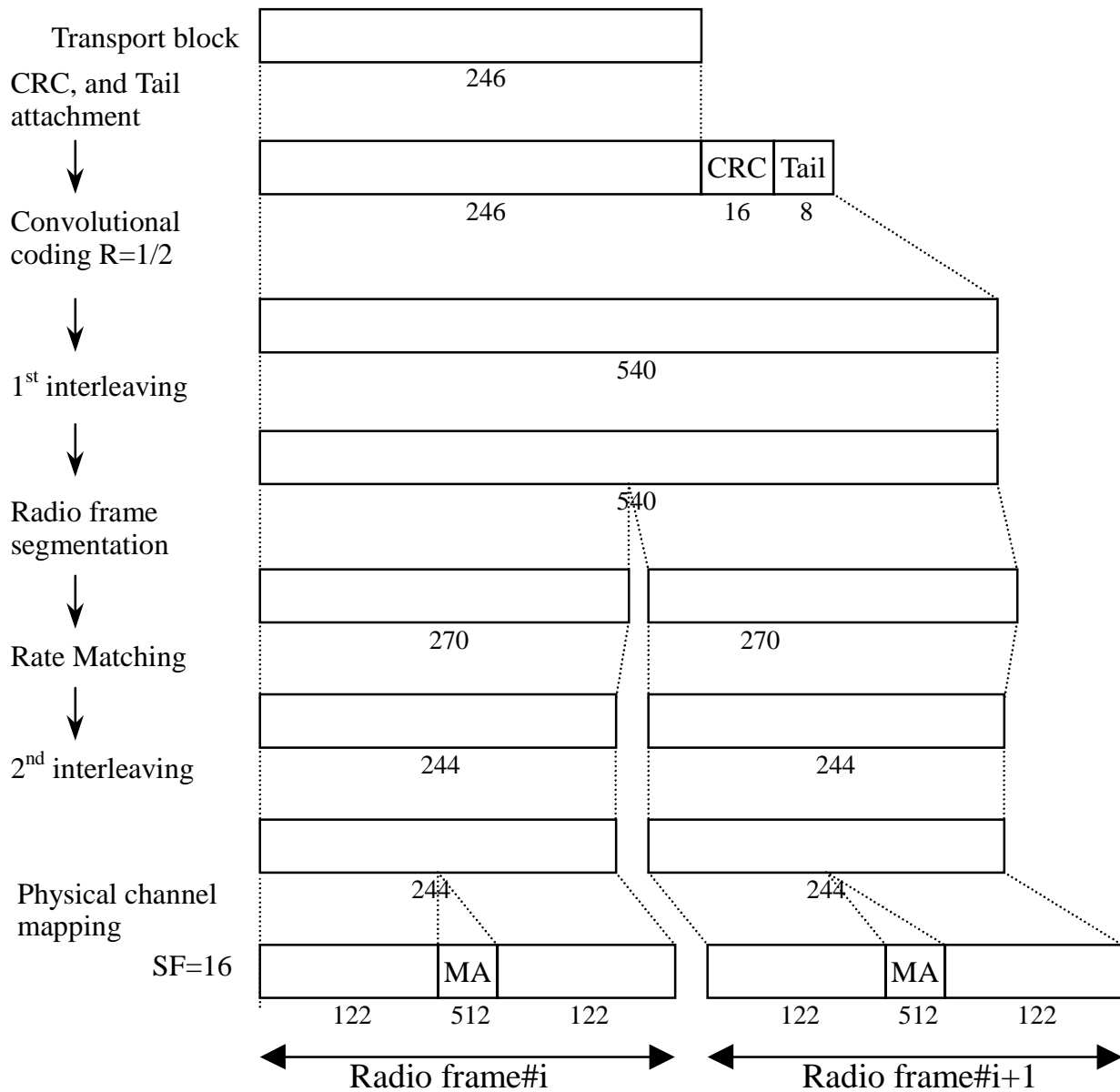

Figure 29: Channel coding for BCH

4.2.1.2 Example for PCH and FACH

Table 26: Parameters for PCH and FACH

Transport block size	PCH	$N_{PCH}=80$ or 240 bit
	FACH1	363 bit
	FACH2	171 bit
Transport block set size	PCH	$80 \cdot B_{PCH}$ or $240 \cdot B_{PCH}$ bit ($B_{PCH}=0,1$)
	FACH1	$363 \cdot B_{FACH1}$ bit ($B_{FACH1}=0,1$)
	FACH2	$171 \cdot B_{FACH2}$ bit ($B_{FACH2}=0,1,2$)
Coding	PCH, FACH2	CC, coding rate = 1/2
	FACH1	TC
TTI		20 ms
Midamble		512 chips
Codes and time slots		SF = 16 x 1 x 1 time slot
TFCI		16 bit
TPC		0 bit

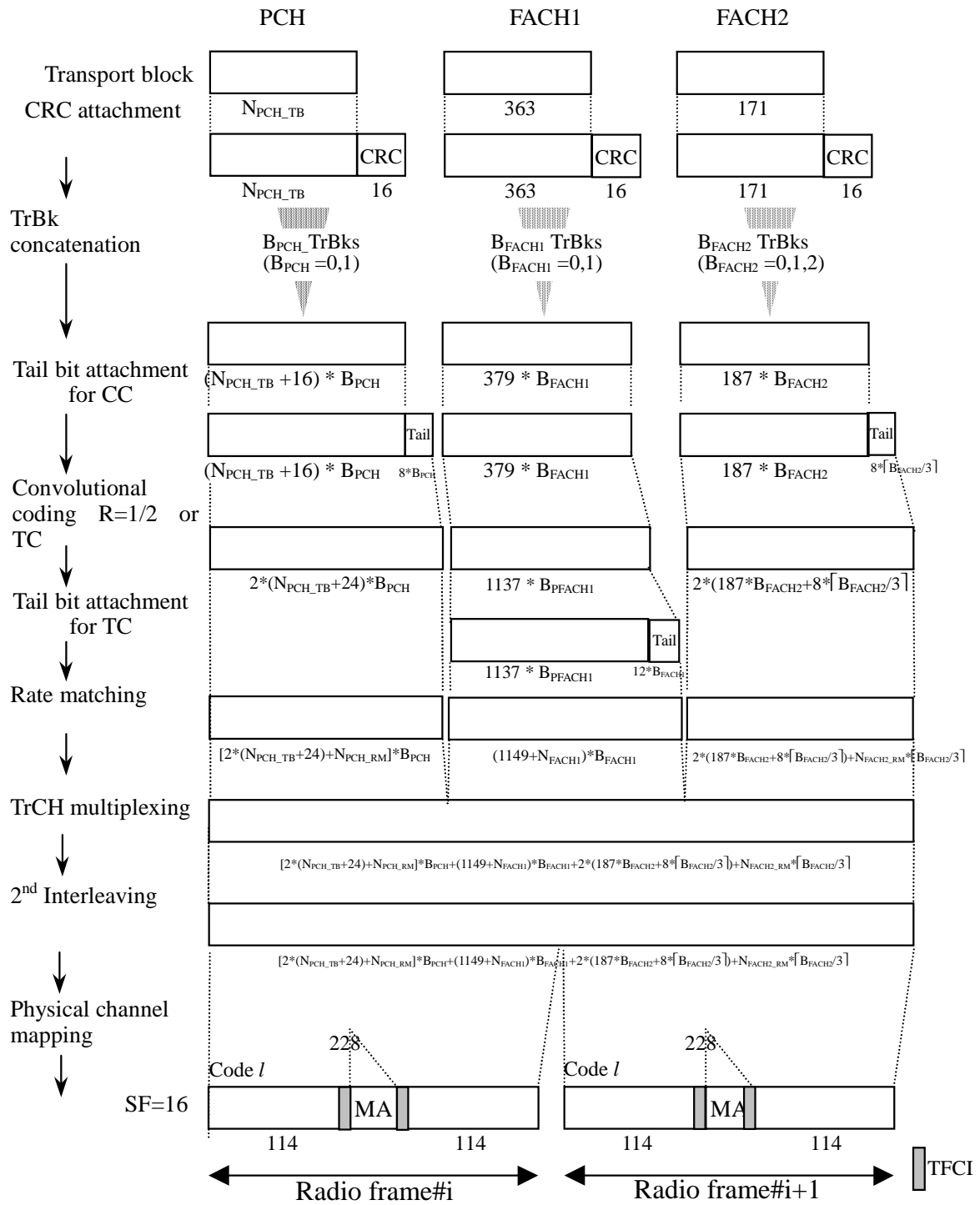

Figure 30: Channel coding and multiplexing example for PCH and FACH

4.2.1.3 Example for DCH

4.2.1.3.1 DCH-> Radio frame segmentation

4.2.1.3.1.1 Example for 3.4 kbps data

NOTE: This example can be applied to DCCH.

NOTE: In this example, it is assumed that maximum data rate of RLC payload is 3.4kbps, and that MAC and RLC overhead in a transport block is 12 bits.

Table 27: Parameter examples for 3.4 kbps data

Transport block size	148 bits
Transport block set size	148*B bits (B=0,1)
CRC	16 bits
Coding	CC, coding rate = 1/3
TTI	40 ms

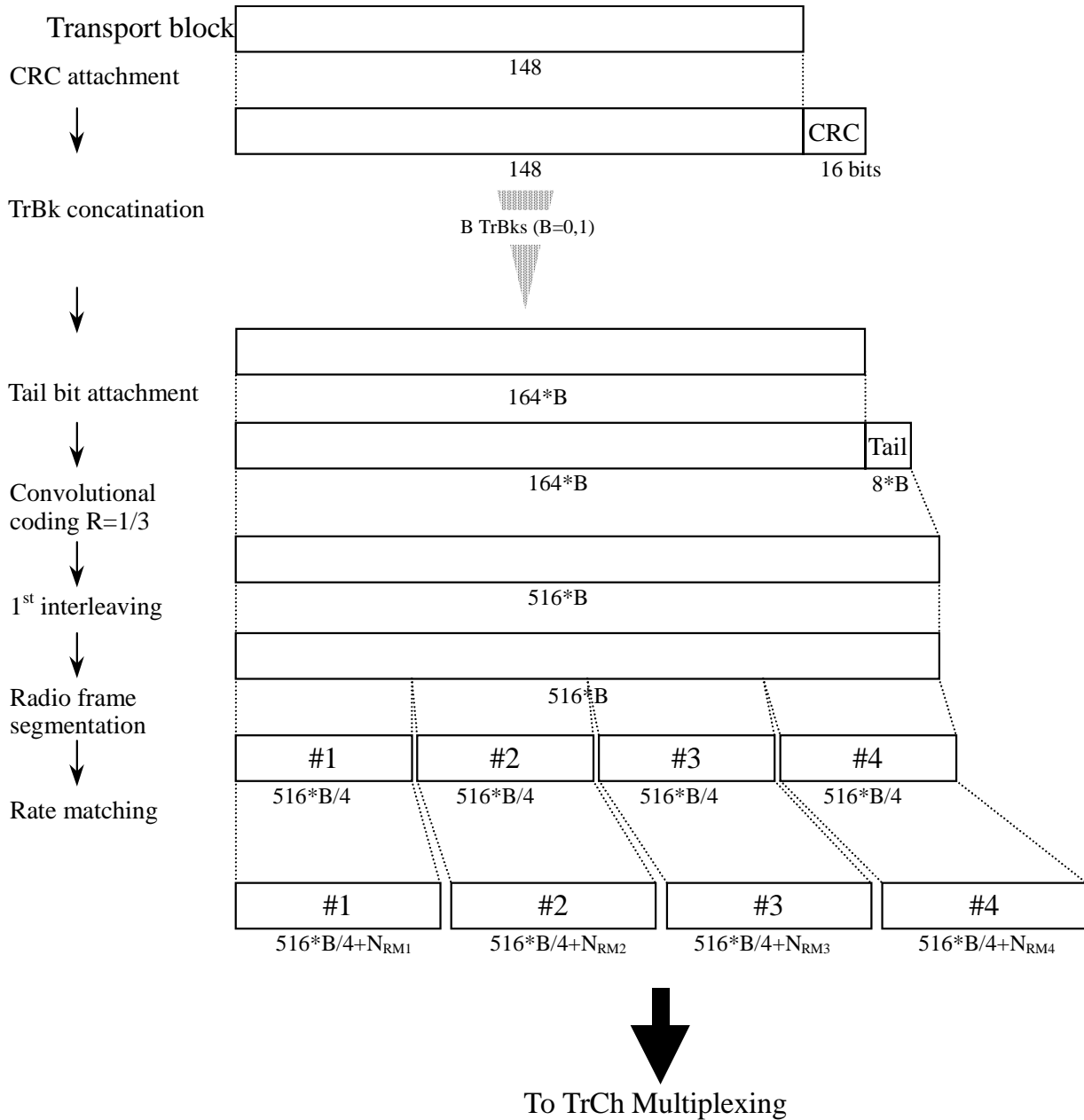

Figure 31: Channel coding and multiplexing example for 3.4 kbps data

4.2.1.3.1.2 Example for 12.2 kbps data

NOTE: This example can be applied to AMR speech.

Table 28: Parameter examples for 12.2 kbps data

The number of TrChs		3
Transport block size	TrCH#a	39 or 81 bits
	TrCH#b	103 bits
	TrCH#c	60 bits
Transport block set size	#1	$N_{TrCHa}=1*81, N_{TrCHb}=1*103, N_{TrCHc}=1*60$ bits
	#2	$N_{TrCHa}=1*39, N_{TrCHb}=0*103, N_{TrCHc}=0*60$ bits
	#3	$N_{TrCHa}=0*81, N_{TrCHb}=0*103, N_{TrCHc}=0*60$ bits
CRC	12 bits (attached only to TrCh#a)	
Coding	CC,	
TTI	coding rate = 1/3 for TrCh#a, b coding rate = 1/2 for TrCh#c	
	20 ms	

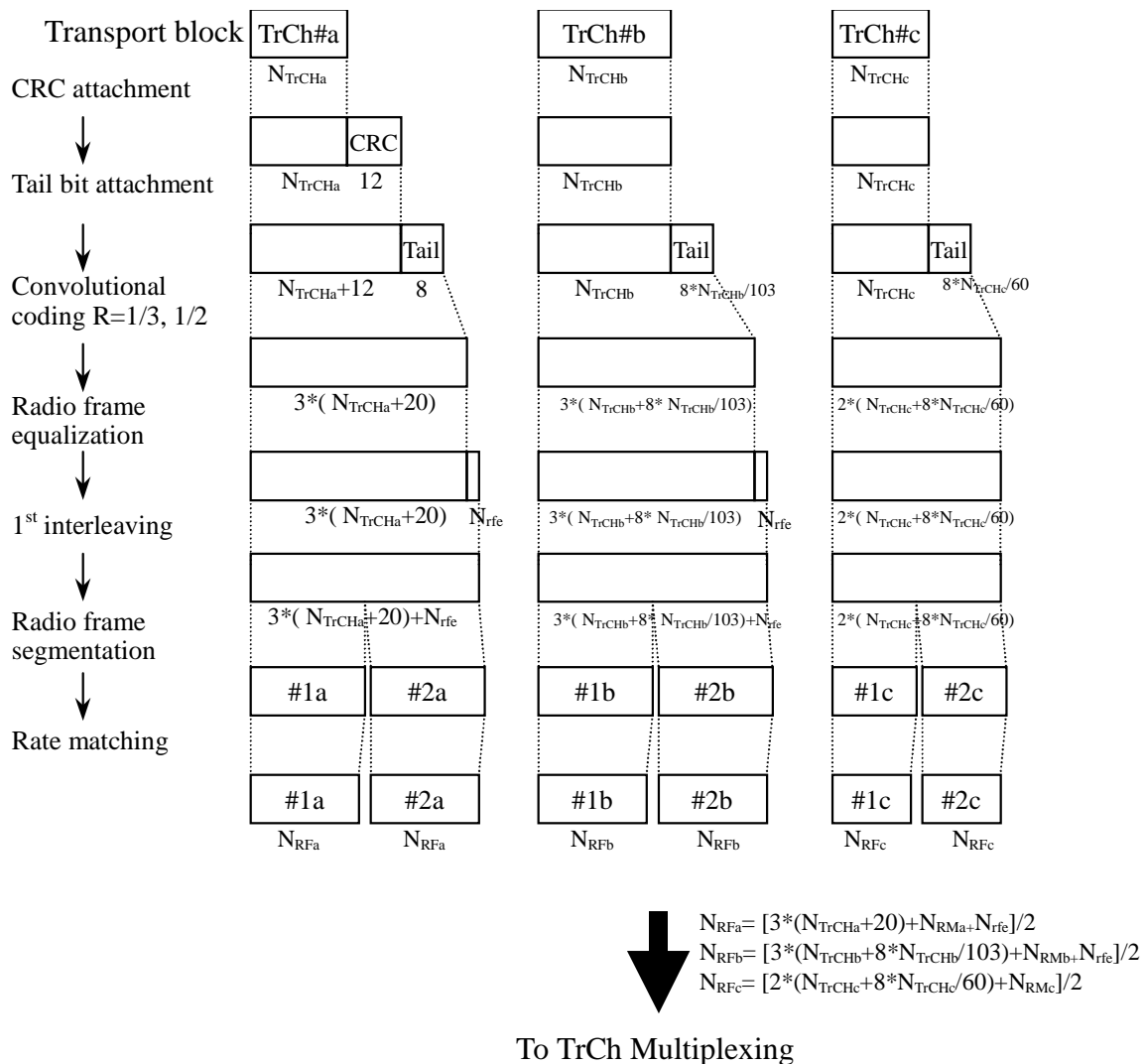

Figure 32: Channel coding and multiplexing example for 12.2 kbps data

4.2.1.3.1.3 Example of 28.8/57.6 kbps data

NOTE: This example can be applied to Modem or FAX.

Table 29: Parameters for 28.8/57.6 kbps data

The number of TrChs		1
Transport block size		576 bits
Transport block set size	28.8 kbps	576*B bits (B=0, 1, 2)
	57.6 kbps	576*B bits (B=0, 1, 2, 3, 4)
CRC		16 bits
Coding		Turbo coding, coding rate = 1/3
TTI		40 ms

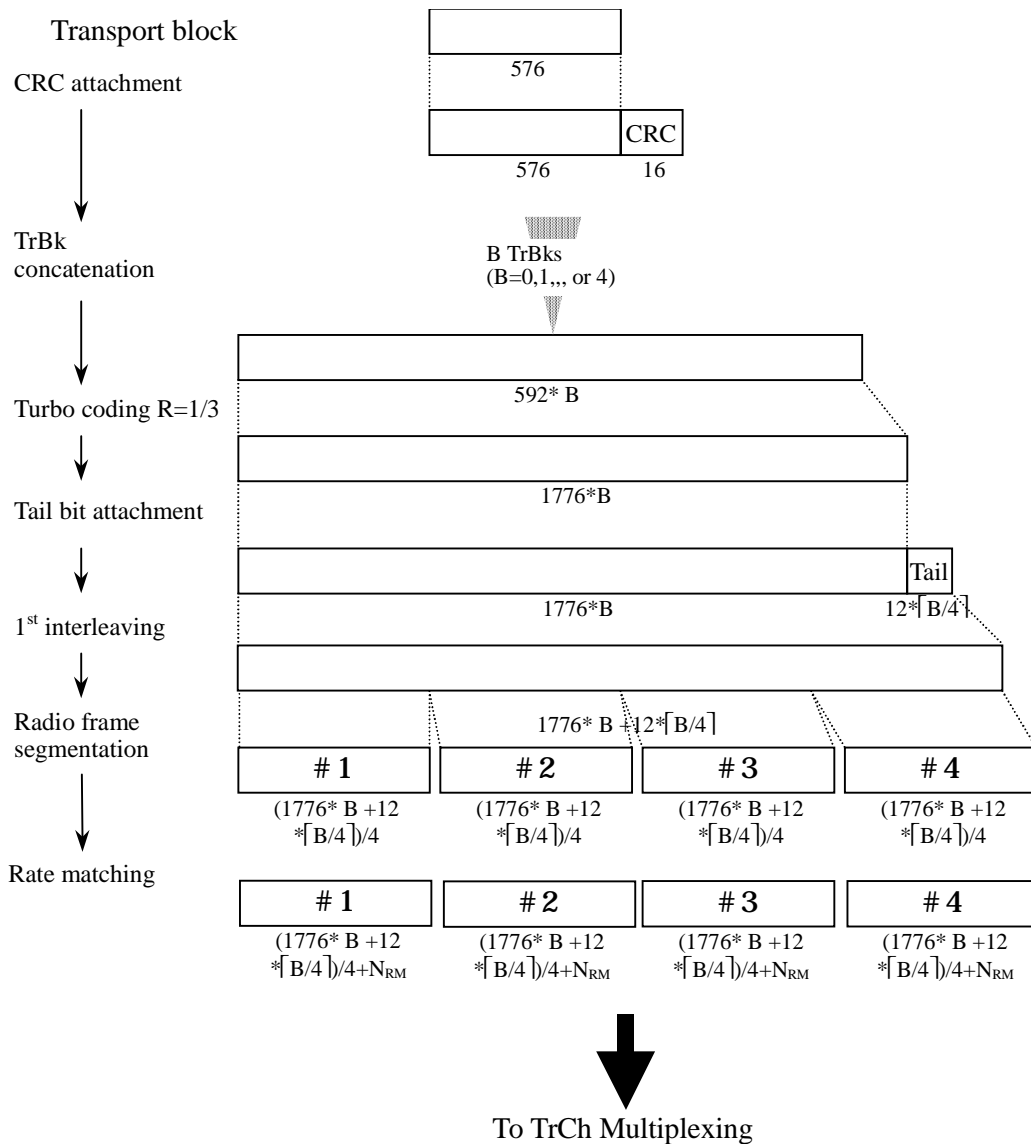

Figure 33: Channel coding and multiplexing example for 28.8/57.6 kbps data

4.2.1.3.1.4 Example of 64/128/144 kbps packet data

NOTE: In this example it is assumed, that maximum data rate of RLC payload is 64/128/144 kbps, and MAC and RLC overhead in a transport block is 16 bits.

Table 30: Parameters for 64/128/144 kbps packet data

The number of TrChs		1
Transport block size		336 bits
Transport block set size	64 kbps	$336 \cdot B$ bits ($B = 0, 1, 2, 3, 4$)
	128 kbps	$336 \cdot B$ bits ($B = 0, 1, 2, 4, 8$)
	144 kbps	$336 \cdot B$ bits ($B = 0, 1, 2, 4, 8, 9$)
CRC		16 bits
Coding		Turbo coding, coding rate = 1/3
TTI		20 ms

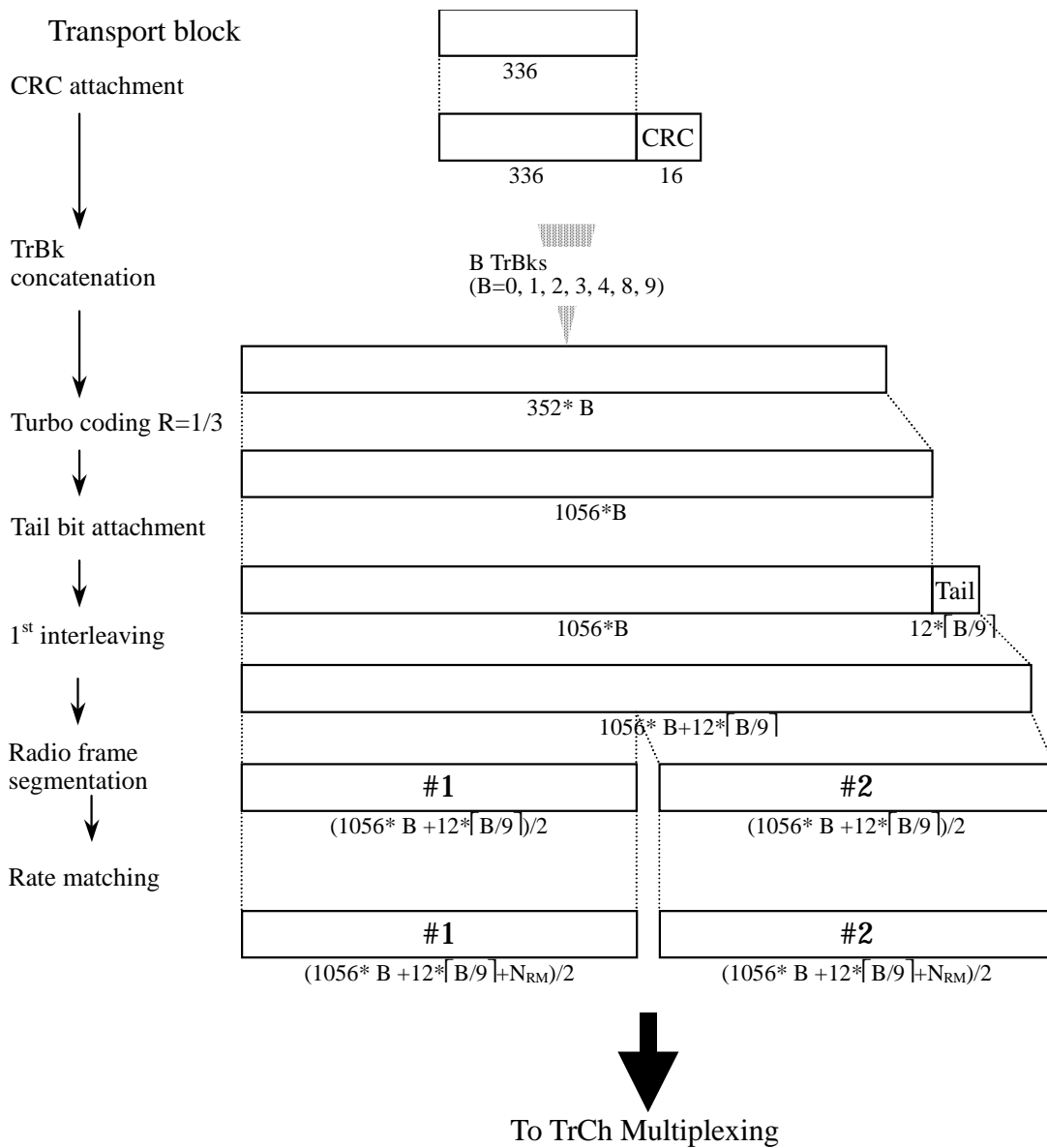

Figure 34: Channel coding and multiplexing example for 64/128/144 kbps packet data

4.2.1.3.1.5 Example of 384 kbps packet data

NOTE: In this example it is assumed, that the maximum data rate of RLC payload is 384 kbps, and MAC and RLC overhead in a transport block is 16 bits.

Table 31: Parameters for 384 kbps packet data

The number of TrChs	1
Transport block size	336 bits
Transport block set size	336*B bits (B = 0, 1, 2, 4, 8, 12 for TTI=10ms, B = 0, 1, 2, 4, 8, 12, 16, 20, 24 for TTI=20ms)
CRC	16 bits
Coding	Turbo coding, coding rate = 1/3
TTI	10 or 20 ms

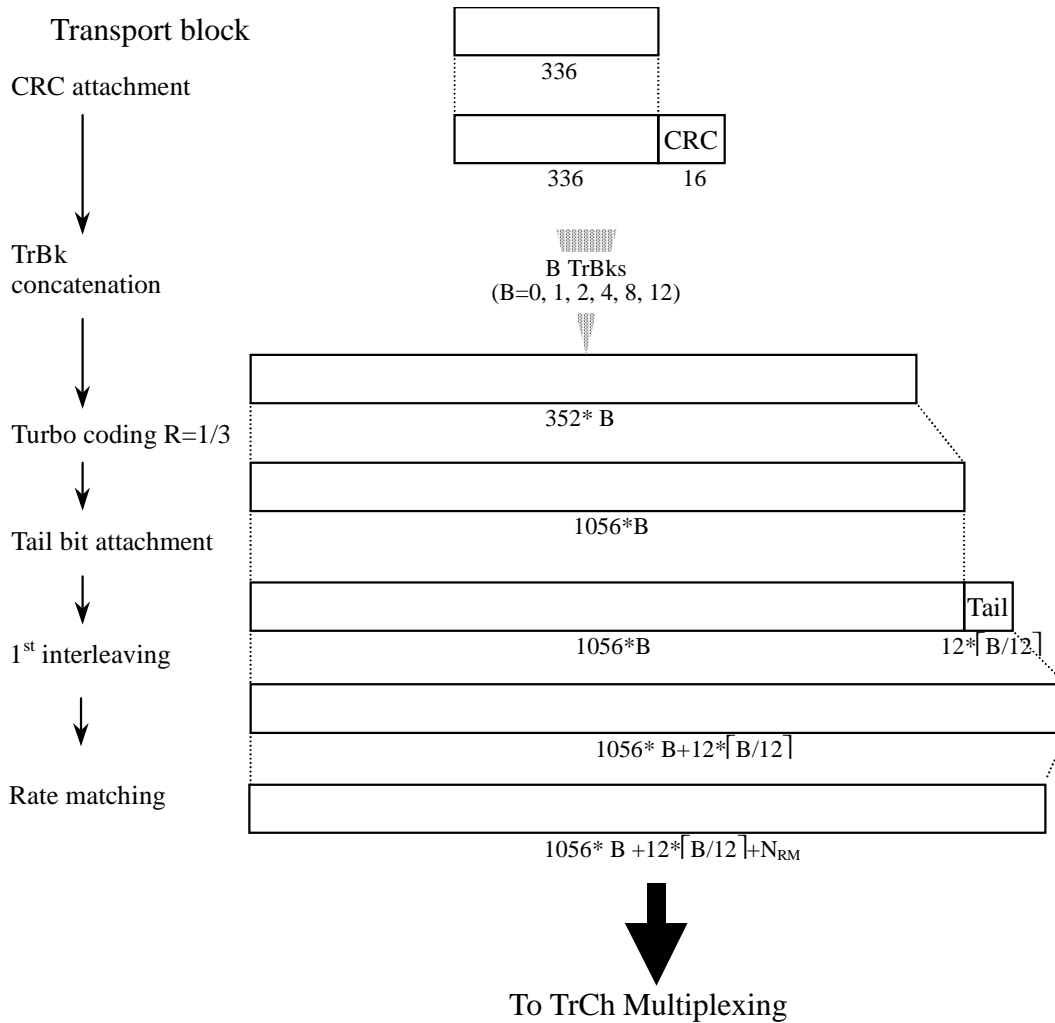

Figure 35: Channel coding and multiplexing example for 384 kbps packet data in case of TTI=10ms

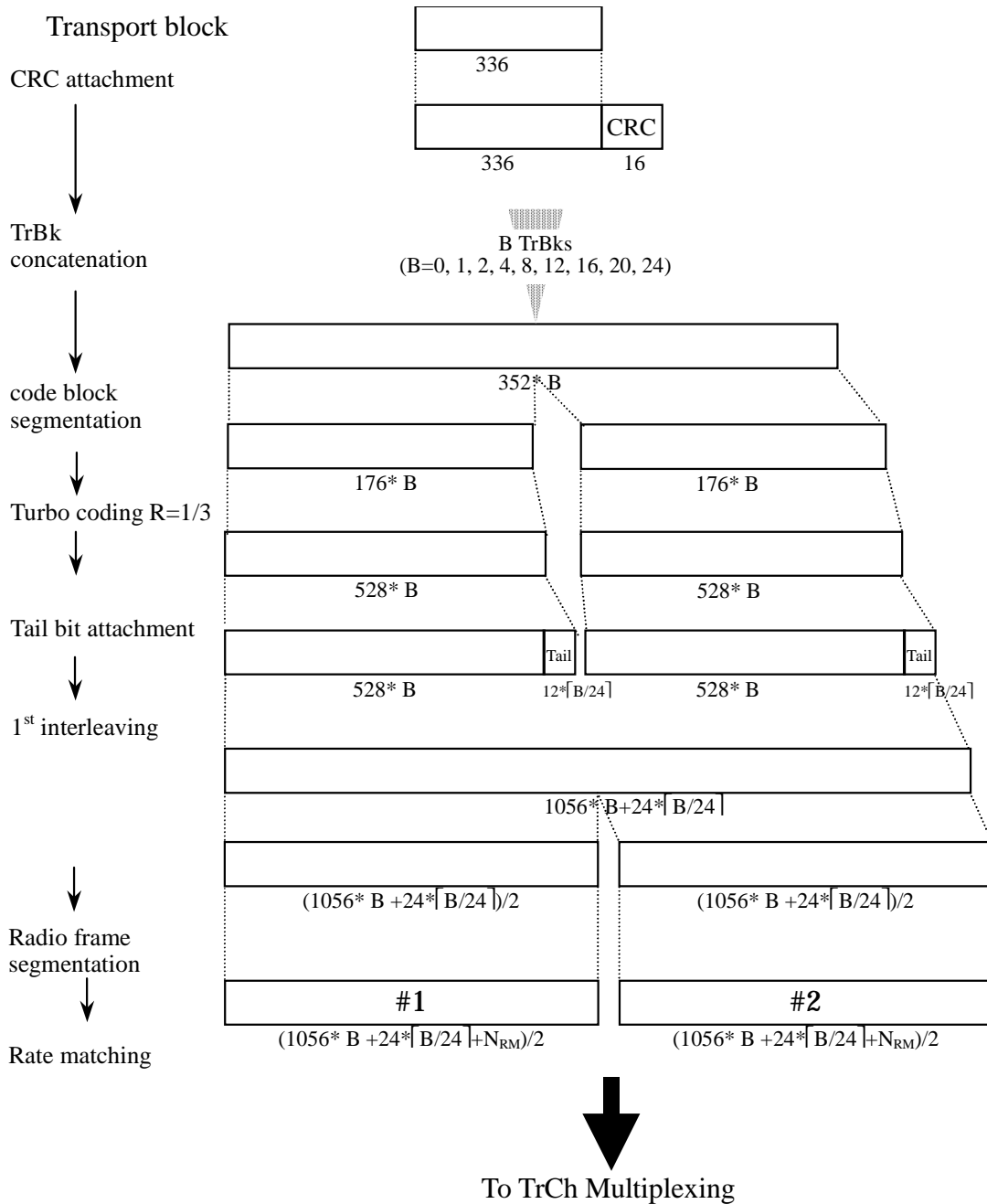

Figure 36: Channel coding and multiplexing example for 384 kbps packet data in case of TTI=20ms

4.2.1.3.1.6 Example for 64 kbps data

NOTE: This example can be applied to ISDN service.

Table 32: Parameters for 64 kbps data

The number of TrChs	1
Transport block size	640 bits
Transport block set size	4*640 bits
CRC	16 bits
Coding	Turbo coding, coding rate = 1/3
TTI	40 ms

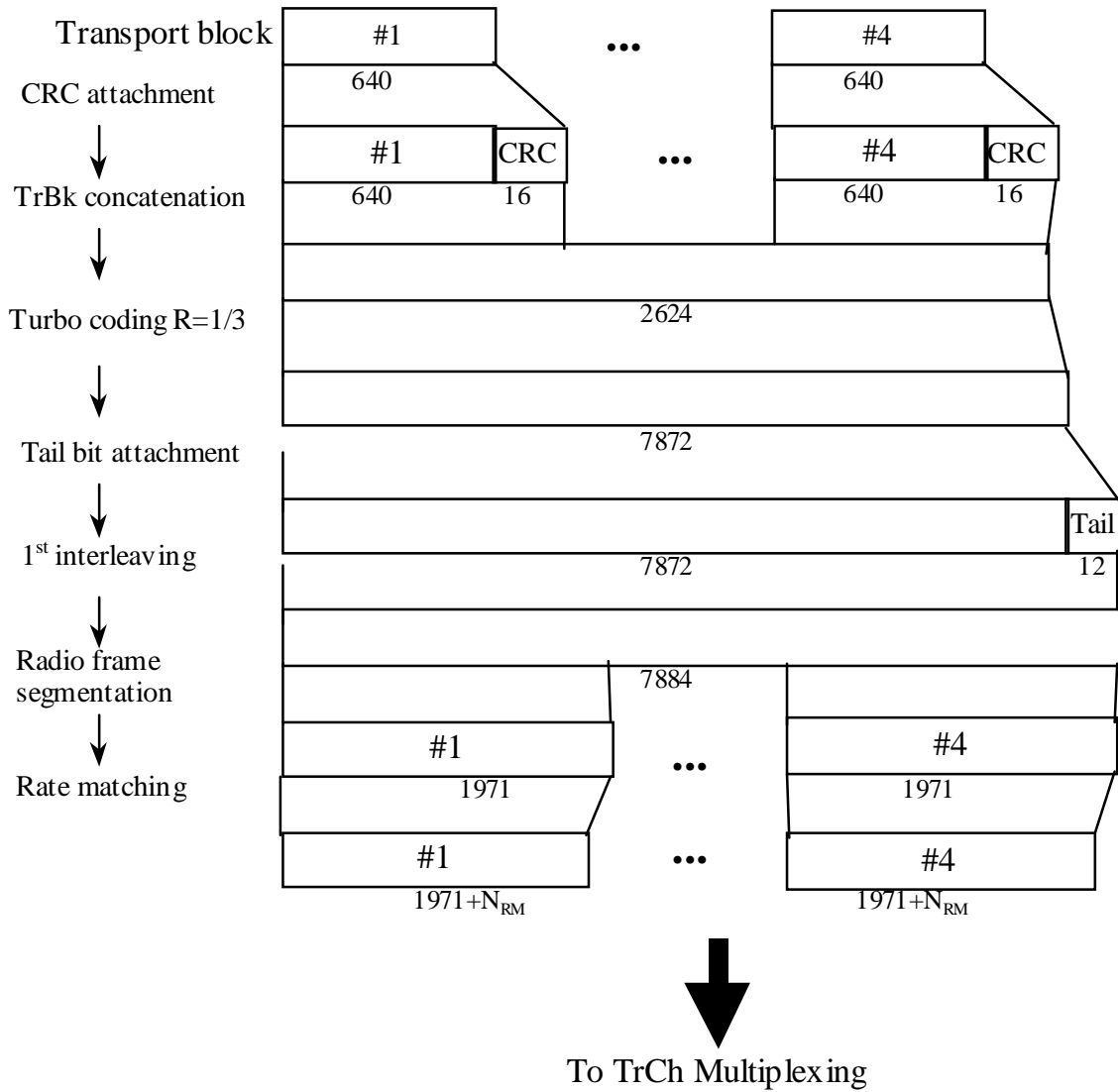

Figure 37: Channel coding and multiplexing example for 64 kbps data

4.2.1.3.2 TrCH multiplexing -> Physical channel mapping

4.2.1.3.2.1 Example for Stand-alone mapping of 3.4 kbps data

NOTE: This example can be applied to Stand-alone mapping of DCCH.

Table 33 shows example of physical channel parameters for Stand-alone mapping of 3.4 kbps data.

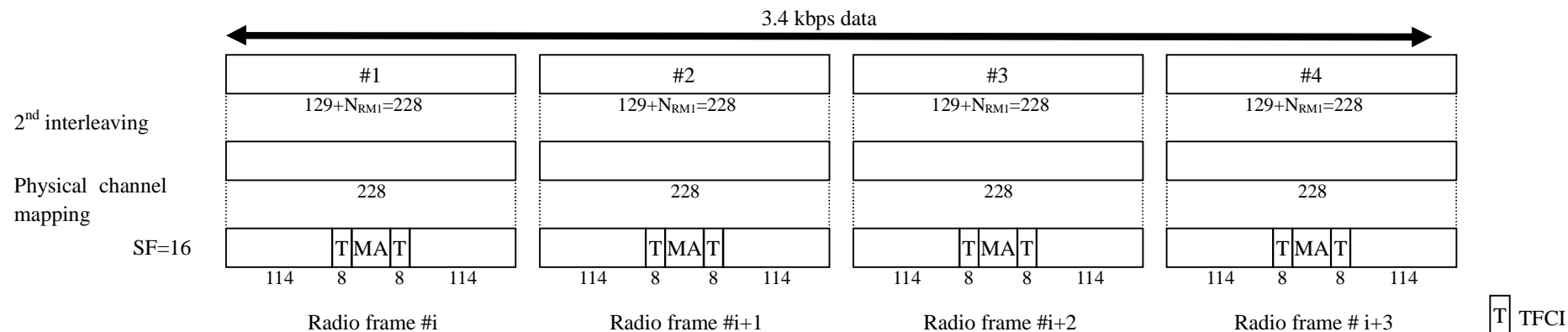

Figure 38: Channel coding and multiplexing example for Stand-alone mapping of 3.4 kbps data

Table 33: Physical channel parameters for Stand-alone mapping of 3.4 kbps data

Midamble	512 chips
Codes and time slots	SF16 x 1 code x 1 time slot
TFCI	16 bit
TPC	0 bit

4.2.1.3.2.2 Example for multiplexing of 12.2 kbps data and 3.4 kbps data

NOTE: This example can be applied to multiplexing AMR speech and DCCH.

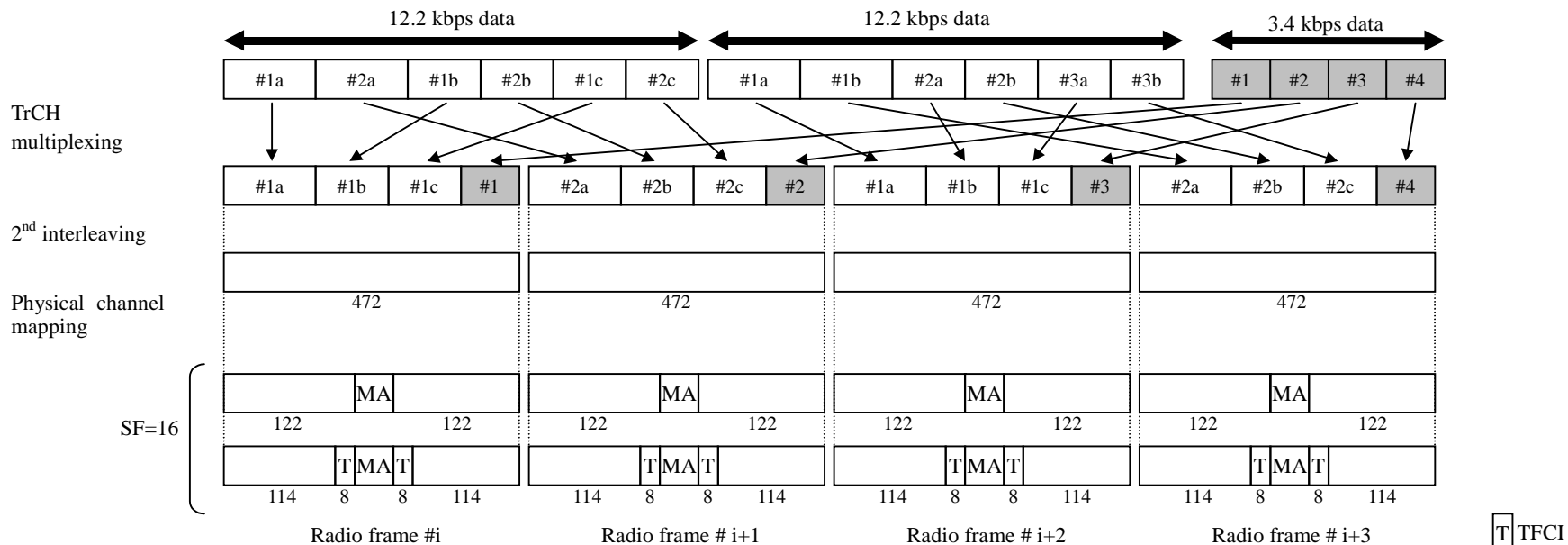

Figure 39: Channel coding and multiplexing example for multiplexing of 12.2 kbps data and 3.4 kbps data

Table 34: Physical channel parameters for multiplexing of 12.2 kbps data and 3.4 kbps data

Midamble	512 chips
Codes and time slots	SF16 x 2 code x 1 time slot
TFCI	16 bit
TPC	0 bit

4.2.1.3.2.3 Example for multiplexing of 28.8/57.6 kbps data 3.4 kbps data

NOTE: This example can be applied to multiplexing of Modem/FAX and DCCH.

Table 35 shows example of physical channel parameters for multiplexing of 28.8/57.6 kbps data and 3.4 kbps data.

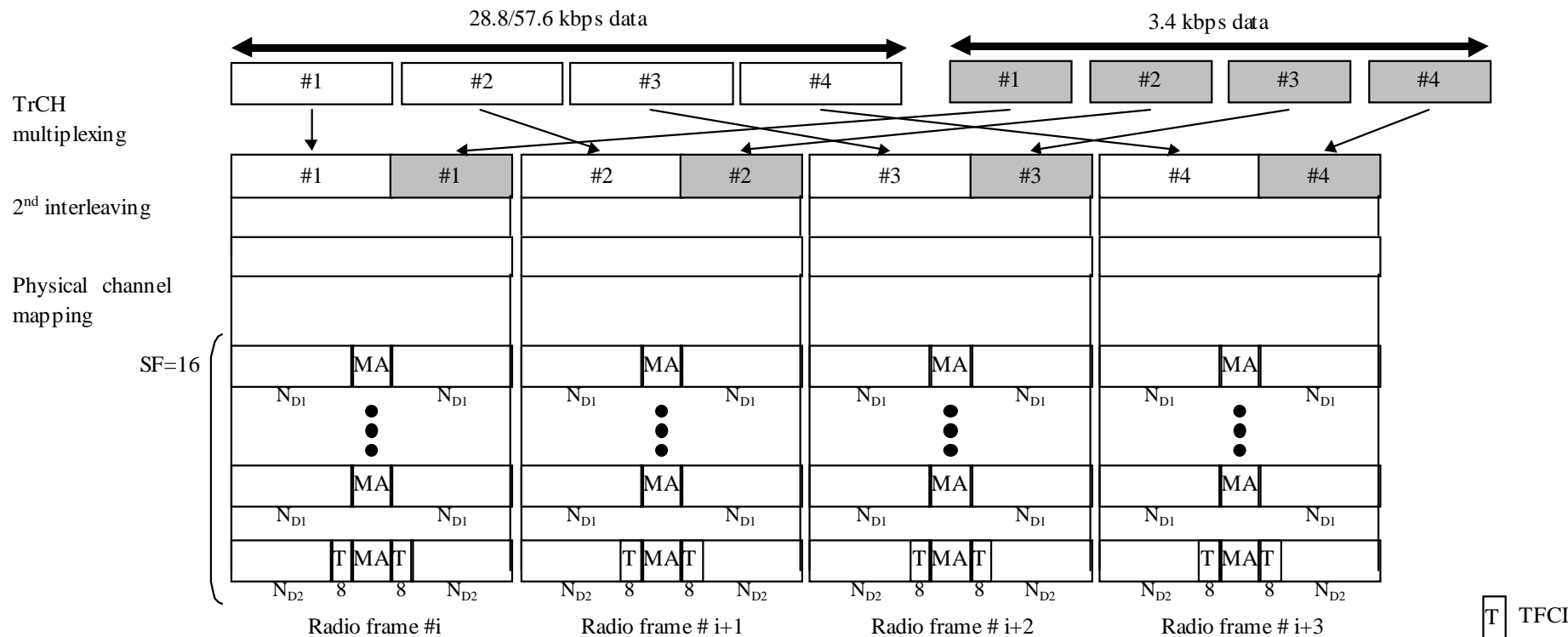

Figure 40: Channel coding and multiplexing example for multiplexing 28.8/57.6 kbps data and 3.4 kbps data

Table 35: Physical channel parameters for multiplexing of 28.8/57.6 kbps packet data and 3.4 kbps data

Midamble	28.8/57.6 kbps	512 chips
N _{D1} , N _{D2}	28.8/57.6 kbps	122 bit, 114 bit
Code & time	28.8 kbps	SF16 x 2 codes x 1 time slot
slots	57.6 kbps	SF16 x 4 codes x 1 time slot
TFCI		16 bit
TPC		0 bit

4.2.1.3.2.4 Example for multiplexing of 64/128/144/384 kbps packet data and 3.4 kbps data

NOTE: This example can be applied to multiplexing 64/128/144/384 kbps packet data and DCCH.

Table 36 shows example of physical channel parameters for multiplexing of 64/128/144/384 kbps packet data and 3.4 kbps data.

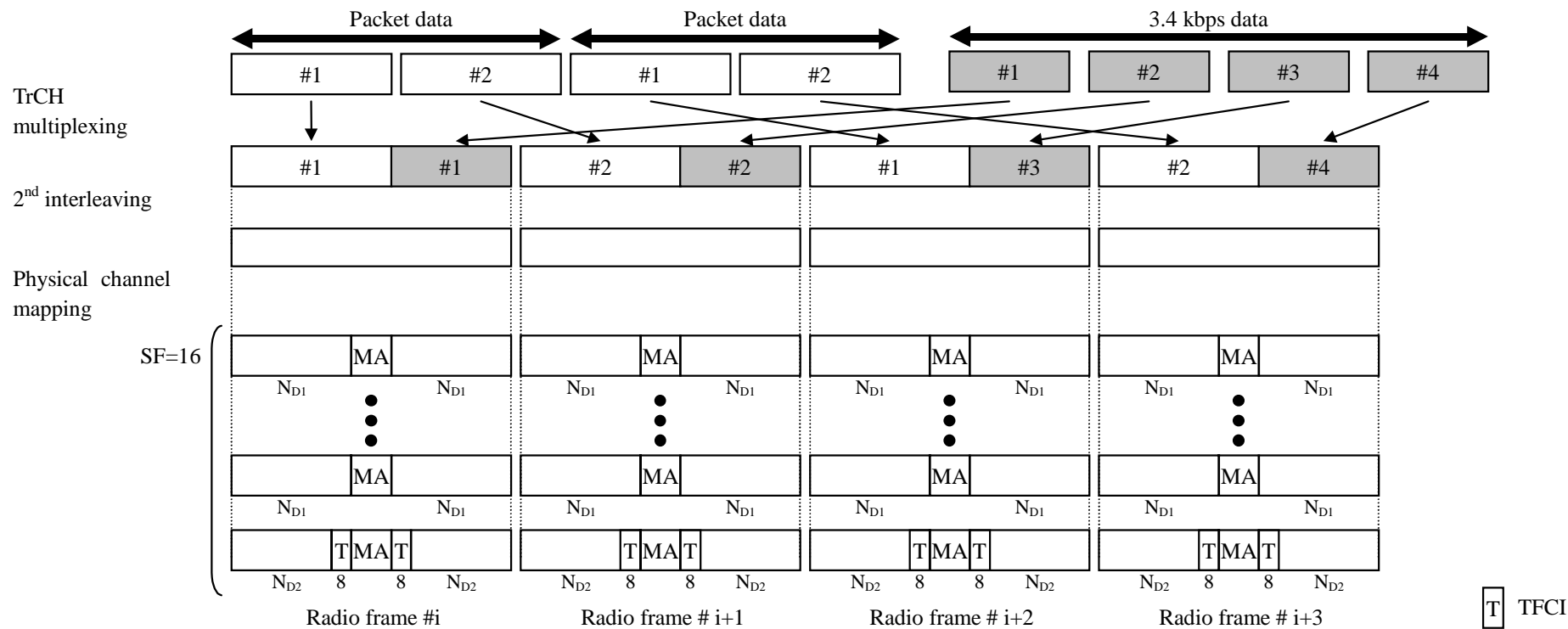

Figure 41: Channel coding and multiplexing example for multiplexing of 64/128/144/384 kbps packet data and 3.4 kbps data

Table 36: Physical channel parameters for multiplexing of 64/128/144/384 kbps packet data and 3.4 kbps data

Midamble	64 kbps	512 chips
	128 & 144 & 384 kbps	256 chips
N _{D1} , N _{D2}	64 kbps	122 bit, 114 bit
	128 & 144 & 384 kbps	138 bit, 130 bit
Code & time	64 kbps	SF16 x 5 codes x 1 time slot
slots	128 kbps	SF16 x 8 codes x 1 time slot
	144 kbps	SF16 x 9 codes x 1 time slot
	384 kbps	SF16 x 8 codes x 3 time slots
TFCI		16 bit
TPC		0 bit

4.2.1.3.2.5 Example for multiplexing of 64 kbps data and 3.4 kbps data

NOTE: This example can be applied to multiplexing ISDNs data and DCCH.

Table 37 shows example of physical channel parameters for multiplexing of 64 kbps data and 3.4 kbps data.

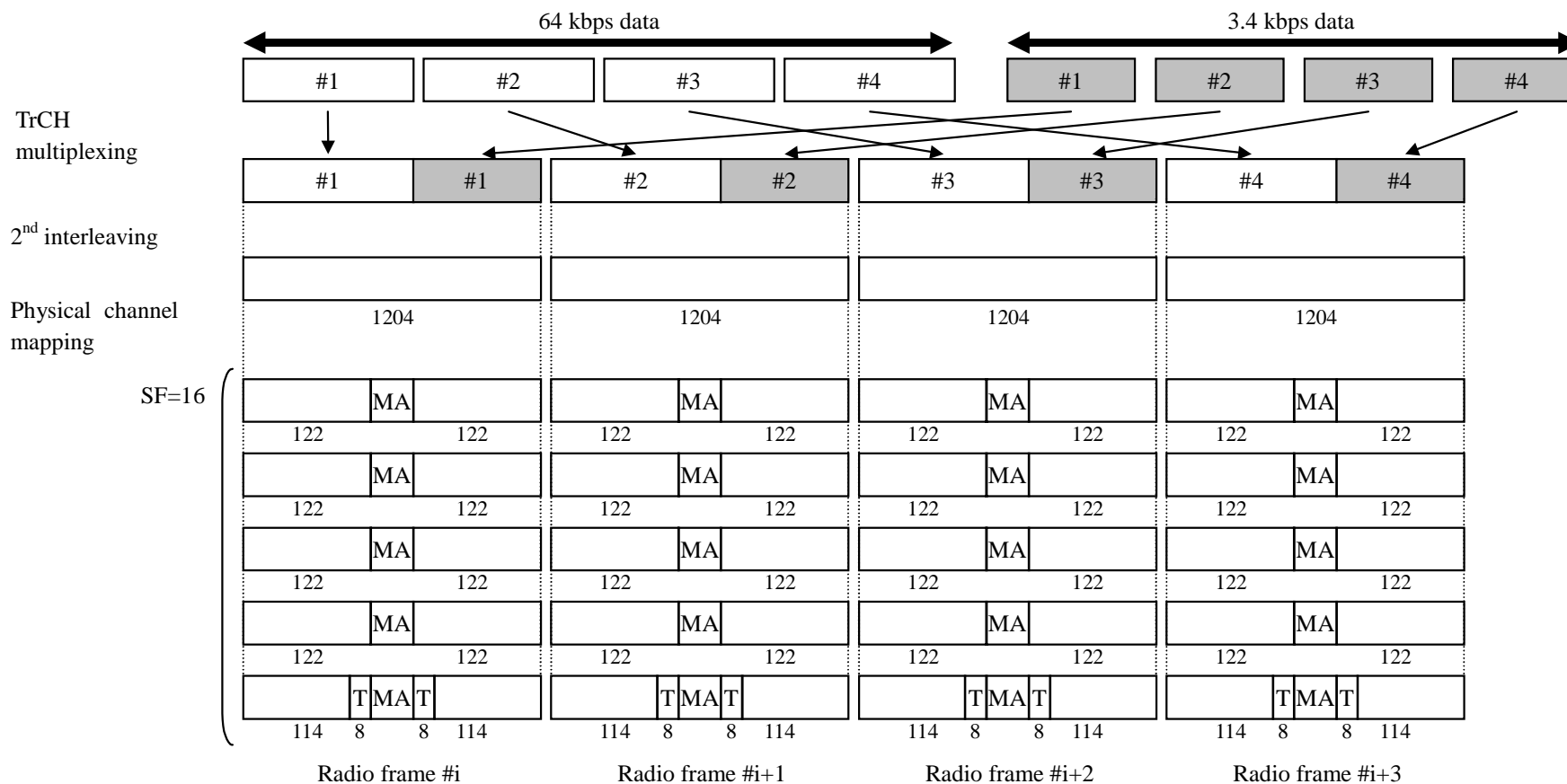

Figure 42: Channel coding and multiplexing example for multiplexing of 64 kbps data and 3.4 kbps data

Table 37: Physical channel parameters for multiplexing of 64 kbps packet data and 3.4 kbps data

Midamble	512 chips
Code & time slots	SF16 x 5 codes x 1 time slot
TFCI	16 bit
TPC	0 bit

4.2.1.3.2.6 Example for multiplexing of 12.2 kbps data, 64/128/144/384 kbps packet data and 3.4 kbps data

NOTE: This example is corresponding to multiplexing of AMR speech, 64/128/144/384 kbps packet and DCCH.

Table 38 shows example of physical channel parameters for multiplexing of 12.2 kbps data, 64/128/144/384 kbps packet data and 3.4 kbps data.

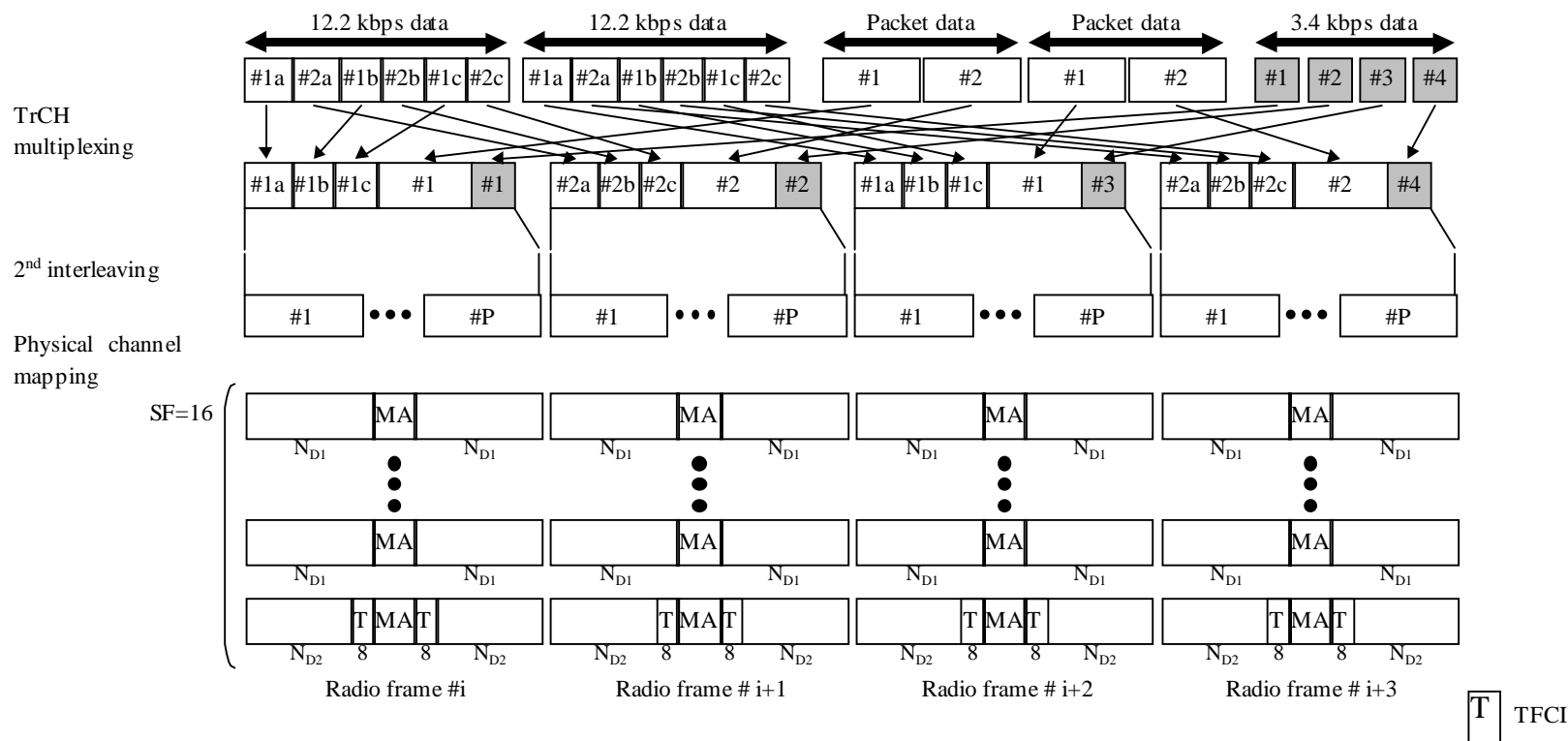

Figure 43: Channel coding and multiplexing example for multiplexing of 12.2 kbps data, 64/128/144/384 kbps packet data and 3.4 kbps data

Table 38 Physical channel parameters for multiplexing of 12.2 kbps data, 64/128/144/384 kbps packet data and 3.4 kbps data

Data rate (kbps)	No. of timeslots	No. of physical channels with SF16 per used TS	Midamble length	N_{TFCI}	N_{TPC}
64	1	5	512 chips	16	0
128	1	8	256 chips	16	0
144	1	9	256 chips	16	0
384	3	8	256 chips	16	0

4.2.2 Uplink

4.2.2.1 RACH

Table 39: Parameters for RACH

Transport block size	$N_{RACH}=168$ bit
CRC	16 bit
Coding	CC, coding rate = 1/2
TTI	10 ms
Midamble	512 chips
Codes and time slots	SF = 16 x 1 x 1 time slot or SF = 8 x 1 x 1 time slot
TFCI	0 bit
TPC	0 bit

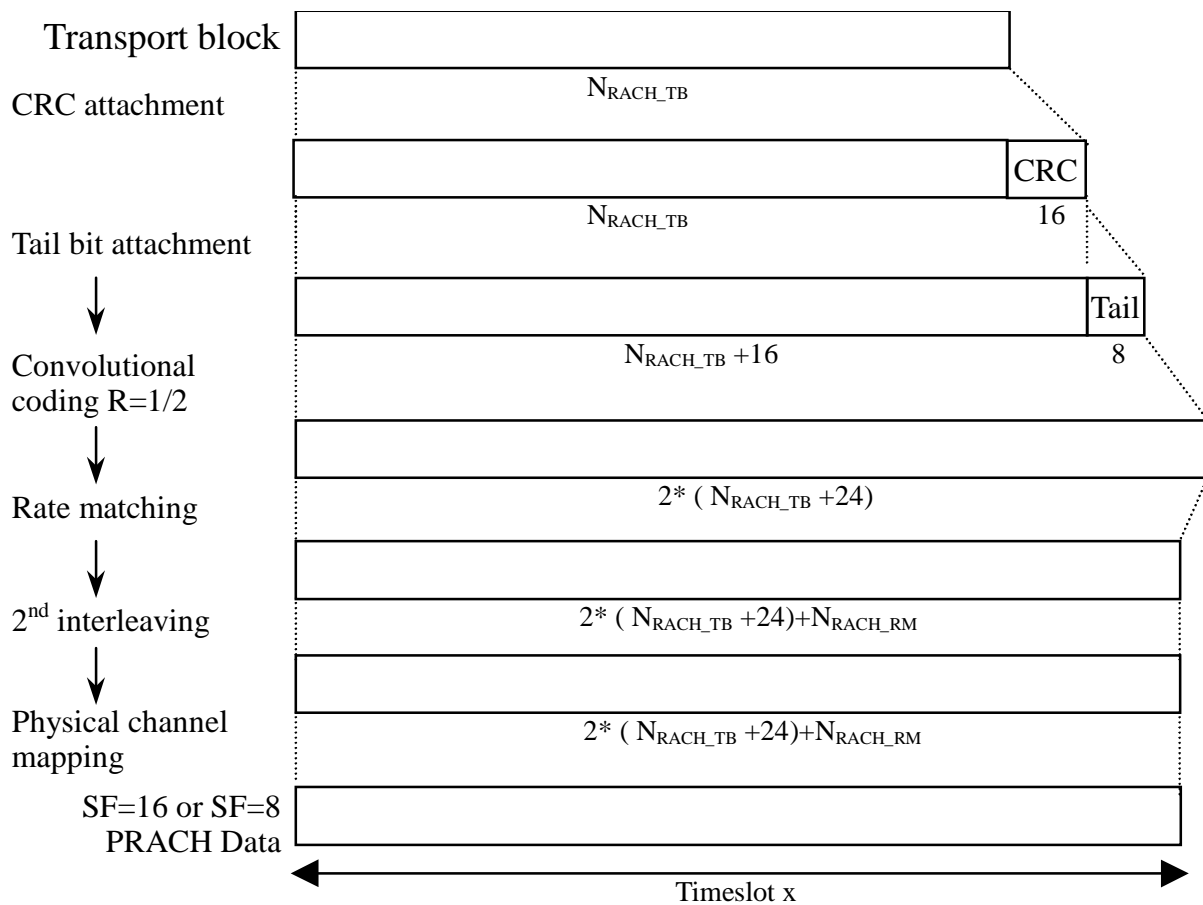

Figure 44: Channel coding and multiplexing example for PRACH

4.2.2.2 Example for DCH

4.2.2.2.1 DCH-> Radio frame segmentation

See 4.2.1.4.2.

4.2.2.2.2 TrCH multiplexing -> Physical channel mapping

4.2.2.2.2.1 Example for Stand-alone mapping of 3.4 kbps data

NOTE: This example can be applied to Stand-alone mapping of DCCH.

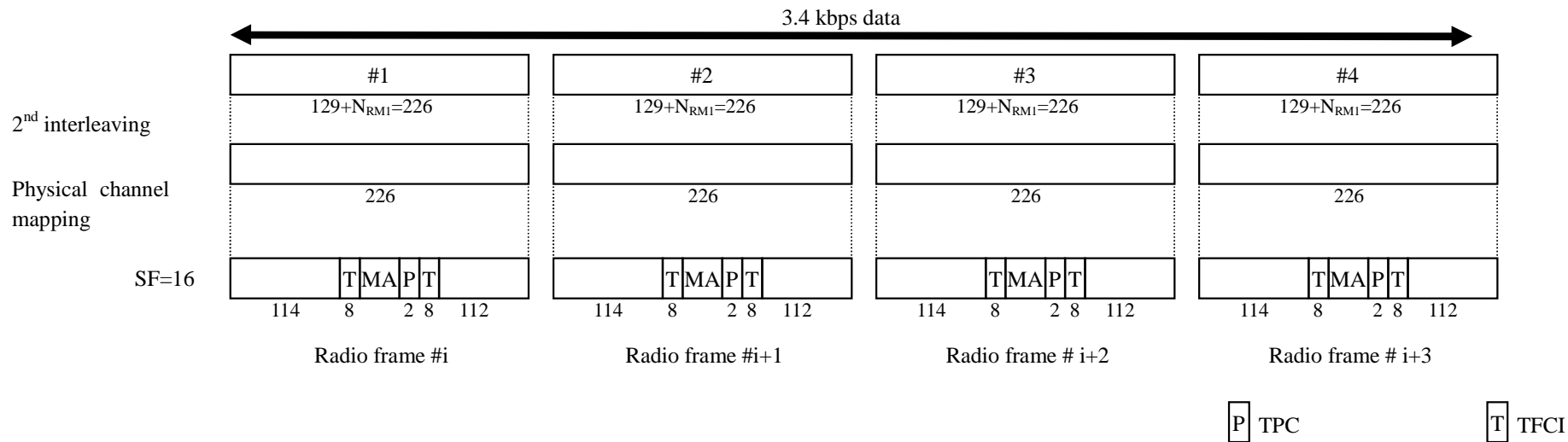

Figure 45: Channel coding and multiplexing example for Stand-alone mapping of 3.4 kbps data

4.2.2.2.2.2 Example for multiplexing of 12.2 kbps data and 3.4 kbps data

NOTE: This example can be applied to multiplexing AMR speech and DCCH.

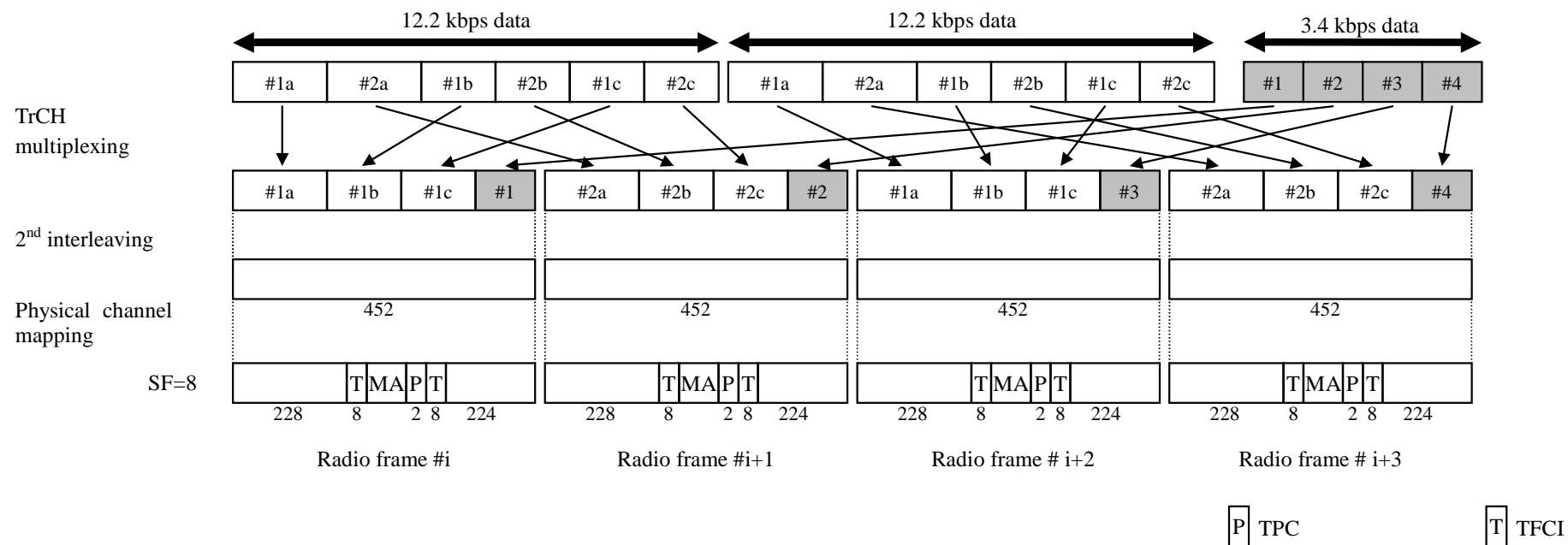

Figure 46: Channel coding and multiplexing example for multiplexing of 12.2 kbps data and 3.4 kbps data

Table 40: Physical channel parameters for multiplexing of 12.2 kbps data and 3.4 kbps data

Midamble	512 chips
Codes and time slots	SF8 x 1 code x 1 time slot
TFCI	16 bit
TPC	2 bit

4.2.2.2.3 Example for multiplexing of 28.8/57.6 kbps data and 3.4 kbps data

NOTE: This example can be applied to multiplexing of Modem/FAX and DCCH.

Table 41 shows example of physical channel parameters for multiplexing of 28.8/57.6 kbps data and 3.4 kbps data.

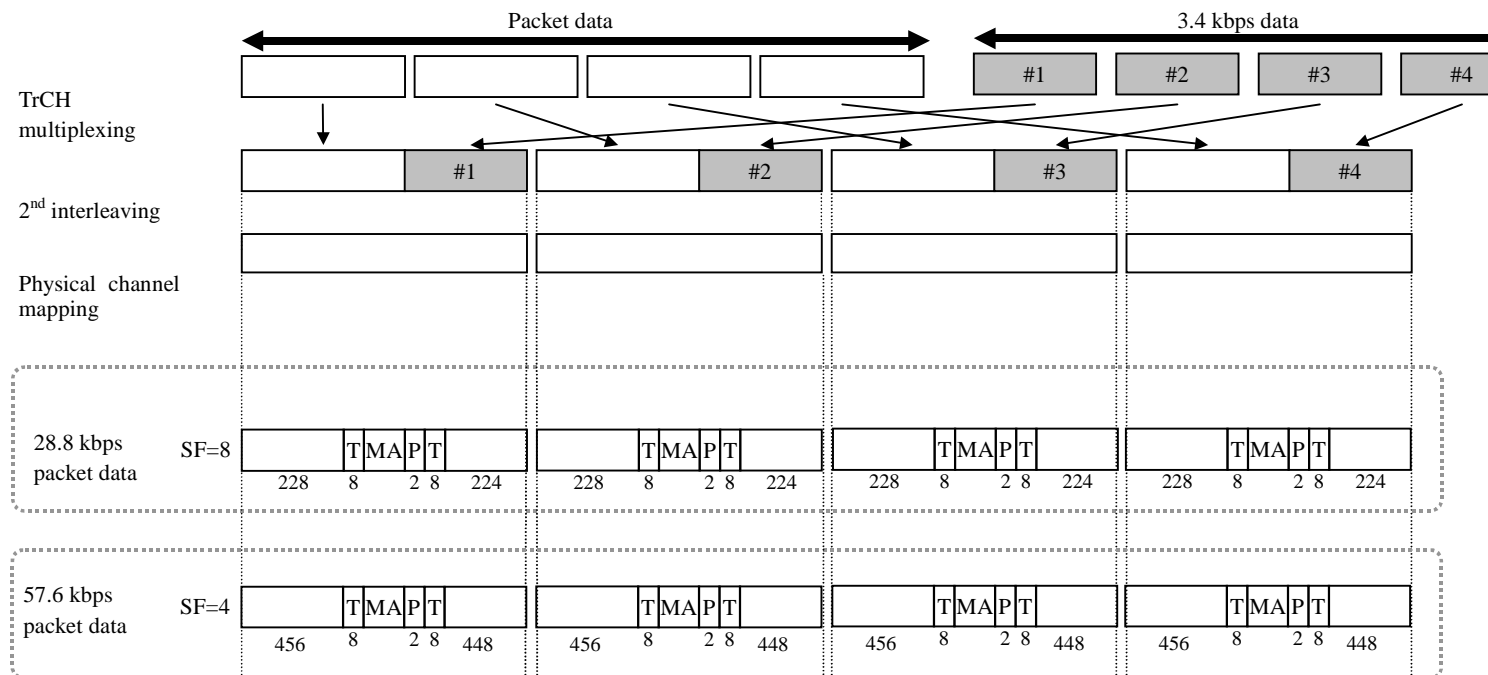

Figure 47: Channel coding and multiplexing example for multiplexing of 28.8/57.6 kbps data and 3.4 kbps data

Table 41: Physical channel parameters for multiplexing of 28.8/57.6 kbps data and 3.4 kbps data

Midamble	28.8/57.6 kbps	512 chips
Codes & time slots	28.8 kbps	(SF8 x 1 code) x 1 time slot
	57.6 kbps	(SF4 x 1 code) x 1 time slot
TFCI		16 bit
TPC		2 bit

4.2.2.2.4 Example for multiplexing of 64/128/144/384 kbps packet data and 3.4 kbps data

NOTE: This example can be applied to multiplexing 64/128/144/384 kbps packet data and DCCH.

Table 42 shows example of physical channel parameters for multiplexing of 64/128/144/384 kbps packet data and 3.4 kbps data.

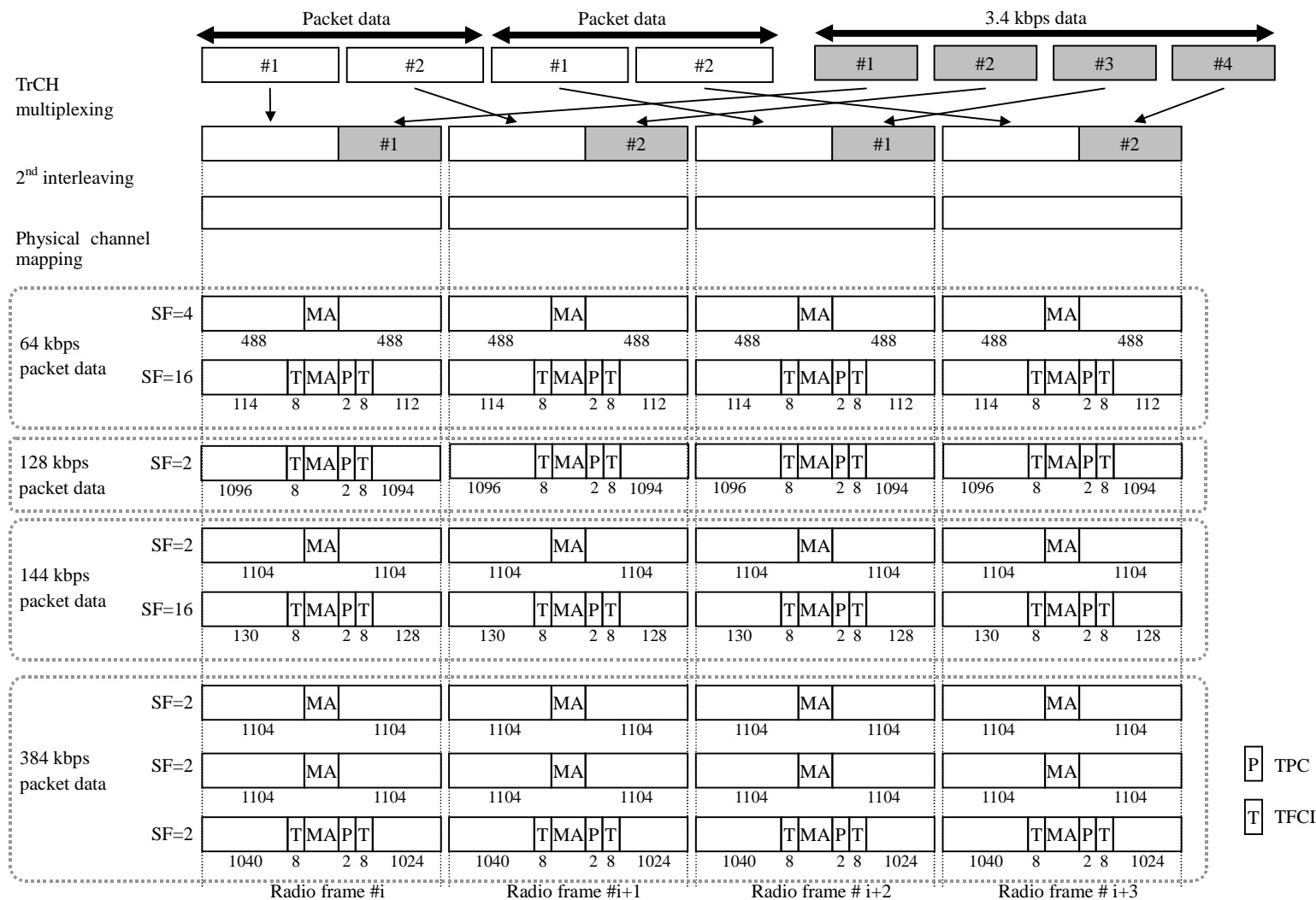

Figure 48: Channel coding and multiplexing example for multiplexing of 64/128/144/384 kbps packet data and 3.4 kbps data

Table 42: Physical channel parameters for multiplexing of 64/128/144/384 kbps packet data and 3.4 kbps data

Midamble	64 kbps	512 chips
	128 & 144 & 384 kbps	256 chips
Codes & time slots	64 kbps	{{(SF16 x 1 code) + (SF4 x 1 code)} x 1 time slot
	128 kbps	(SF2 x 1 code) x 1 time slot
	144 kbps	{{(SF16 x 1 code) + (SF2 x 1 code)} x 1 time slot
	384 kbps	SF2 x 1 code x 3 time slot
TFCI		16 bit
TPC		2 bit

NOTE: As an additional example, physical channels can also be mapped without using multicode per timeslot, e.g.:

for 64kbps: (SF16 x 1 code x 1 timeslot) + (SF4x 1 code x 1 timeslot)

for 64kbps: (SF2 x 1 code x 1 timeslot)

for 144kbps: (SF16 x 1 code x 1 timeslot) + (SF2x 1 code x 1 timeslot)

for 144kbps: (SF1 x 1 code x 1 timeslot)

4.2.2.2.5 Example for multiplexing of 64 kbps data and 3.4 kbps data

NOTE: This example can be applied to multiplexing ISDNs data and DCCH.

Table 43 shows example of physical channel parameters for multiplexing of 64 kbps data and 3.4 kbps data.

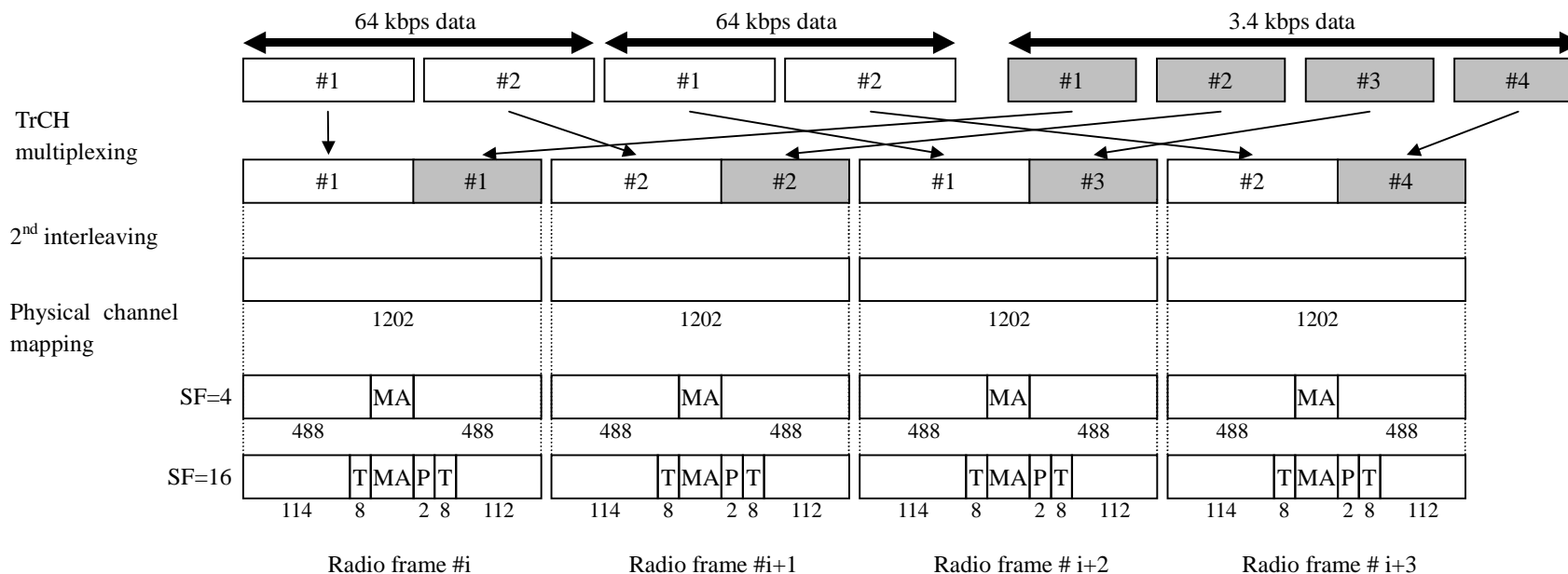

Figure 49: Channel coding and multiplexing example for multiplexing of 64 kbps packet data and 3.4 kbps data

Table 43: Physical channel parameters for multiplexing of 64 kbps packet data and 3.4 kbps data

Midamble	512 chips
Codes & time slots	{(SF16 x 1 code) + (SF4 x 1 code)} x 1 time slot
TFCI	16 bit
TPC	2 bit

NOTE: As an additional example, physical channels can also be mapped without using multicode per timeslot, e.g.

for 64kbps: (SF16 x 1 code x 1 timeslot) + (SF4 x 1 code x 1 timeslot)

for 64kbps: (SF2 x 1 code x 1 timeslot)

Annex A (informative): Change history

Change history							
Date	TSG #	TSG Doc.	CR	Rev	Subject/Comment	Old	New
13/03/00	RAN_07	RP-000093	-	-	Approved at TSG RAN #7 and placed under Change Control	-	3.0.0
26/06/00	RAN_08	RP-000276	001	2	Corrections to align with "Typical radio parameter sets" from ISG	3.0.0	3.1.0
23/09/00	RAN_09	RP-000349	002	2	TDD related changes for TR25.944	3.1.0	3.2.0
15/12/00	RAN_10	RP-000546	003	2	Corrections for FDD part of TR 25.944	3.2.0	3.3.0
15/12/00	RAN_10	RP-000546	004	-	TDD related changes for TR25.944, update	3.2.0	3.3.0
16/03/01	RAN_11	RP-010067	006	-	Corrections for TDD sections	3.3.0	3.4.0
09/04/01	-	-	-	-	Removal of the revision marks in figures	3.4.0	3.4.1
15/06/01	RAN_12	RP-010340	007	-	Correction of TTI for PCH	3.4.1	3.5.0

History

Document history		
V3.0.0	May 2001	Publication
V3.1.0	August 2000	Publication
V3.2.0	November 2000	Publication
V3.3.0	February 2001	Publication
V3.4.1	April 2001	Publication
V3.5.0	July 2001	Publication