

# ETSI TR 125 903 V18.0.0 (2024-05)



TECHNICAL REPORT

## **Universal Mobile Telecommunications System (UMTS); Continuous connectivity for packet data users (3GPP TR 25.903 version 18.0.0 Release 18)**



---

**Reference**

RTR/TSGR-0025903vi00

---

**Keywords**

UMTS

**ETSI**

---

650 Route des Lucioles  
F-06921 Sophia Antipolis Cedex - FRANCE

Tel.: +33 4 92 94 42 00 Fax: +33 4 93 65 47 16

Siret N° 348 623 562 00017 - APE 7112B  
Association à but non lucratif enregistrée à la  
Sous-Préfecture de Grasse (06) N° w061004871

---

**Important notice**

The present document can be downloaded from:

<https://www.etsi.org/standards-search>

The present document may be made available in electronic versions and/or in print. The content of any electronic and/or print versions of the present document shall not be modified without the prior written authorization of ETSI. In case of any existing or perceived difference in contents between such versions and/or in print, the prevailing version of an ETSI deliverable is the one made publicly available in PDF format at [www.etsi.org/deliver](http://www.etsi.org/deliver).

Users of the present document should be aware that the document may be subject to revision or change of status.

Information on the current status of this and other ETSI documents is available at

<https://portal.etsi.org/TB/ETSIDeliverableStatus.aspx>

If you find errors in the present document, please send your comment to one of the following services:

<https://portal.etsi.org/People/CommitteeSupportStaff.aspx>

If you find a security vulnerability in the present document, please report it through our  
Coordinated Vulnerability Disclosure Program:

<https://www.etsi.org/standards/coordinated-vulnerability-disclosure>

---

**Notice of disclaimer & limitation of liability**

The information provided in the present deliverable is directed solely to professionals who have the appropriate degree of experience to understand and interpret its content in accordance with generally accepted engineering or other professional standard and applicable regulations.

No recommendation as to products and services or vendors is made or should be implied.

No representation or warranty is made that this deliverable is technically accurate or sufficient or conforms to any law and/or governmental rule and/or regulation and further, no representation or warranty is made of merchantability or fitness for any particular purpose or against infringement of intellectual property rights.

In no event shall ETSI be held liable for loss of profits or any other incidental or consequential damages.

Any software contained in this deliverable is provided "AS IS" with no warranties, express or implied, including but not limited to, the warranties of merchantability, fitness for a particular purpose and non-infringement of intellectual property rights and ETSI shall not be held liable in any event for any damages whatsoever (including, without limitation, damages for loss of profits, business interruption, loss of information, or any other pecuniary loss) arising out of or related to the use of or inability to use the software.

---

**Copyright Notification**

No part may be reproduced or utilized in any form or by any means, electronic or mechanical, including photocopying and microfilm except as authorized by written permission of ETSI.

The content of the PDF version shall not be modified without the written authorization of ETSI.

The copyright and the foregoing restriction extend to reproduction in all media.

© ETSI 2024.  
All rights reserved.

---

# Intellectual Property Rights

## Essential patents

IPRs essential or potentially essential to normative deliverables may have been declared to ETSI. The declarations pertaining to these essential IPRs, if any, are publicly available for **ETSI members and non-members**, and can be found in ETSI SR 000 314: "*Intellectual Property Rights (IPRs); Essential, or potentially Essential, IPRs notified to ETSI in respect of ETSI standards*", which is available from the ETSI Secretariat. Latest updates are available on the ETSI Web server (<https://ipr.etsi.org/>).

Pursuant to the ETSI Directives including the ETSI IPR Policy, no investigation regarding the essentiality of IPRs, including IPR searches, has been carried out by ETSI. No guarantee can be given as to the existence of other IPRs not referenced in ETSI SR 000 314 (or the updates on the ETSI Web server) which are, or may be, or may become, essential to the present document.

## Trademarks

The present document may include trademarks and/or tradenames which are asserted and/or registered by their owners. ETSI claims no ownership of these except for any which are indicated as being the property of ETSI, and conveys no right to use or reproduce any trademark and/or tradename. Mention of those trademarks in the present document does not constitute an endorsement by ETSI of products, services or organizations associated with those trademarks.

**DECT™**, **PLUGTESTS™**, **UMTS™** and the ETSI logo are trademarks of ETSI registered for the benefit of its Members. **3GPP™** and **LTE™** are trademarks of ETSI registered for the benefit of its Members and of the 3GPP Organizational Partners. **oneM2M™** logo is a trademark of ETSI registered for the benefit of its Members and of the oneM2M Partners. **GSM®** and the GSM logo are trademarks registered and owned by the GSM Association.

---

# Legal Notice

This Technical Report (TR) has been produced by ETSI 3rd Generation Partnership Project (3GPP).

The present document may refer to technical specifications or reports using their 3GPP identities. These shall be interpreted as being references to the corresponding ETSI deliverables.

The cross reference between 3GPP and ETSI identities can be found under <https://webapp.etsi.org/key/queryform.asp>.

---

# Modal verbs terminology

In the present document "**should**", "**should not**", "**may**", "**need not**", "**will**", "**will not**", "**can**" and "**cannot**" are to be interpreted as described in clause 3.2 of the [ETSI Drafting Rules](#) (Verbal forms for the expression of provisions).

"**must**" and "**must not**" are **NOT** allowed in ETSI deliverables except when used in direct citation.

# Contents

|                                                                                                                    |    |
|--------------------------------------------------------------------------------------------------------------------|----|
| Intellectual Property Rights .....                                                                                 | 2  |
| Legal Notice .....                                                                                                 | 2  |
| Modal verbs terminology.....                                                                                       | 2  |
| Foreword.....                                                                                                      | 6  |
| Introduction .....                                                                                                 | 6  |
| 1 Scope .....                                                                                                      | 7  |
| 2 References .....                                                                                                 | 7  |
| 3 Definitions, symbols and abbreviations .....                                                                     | 8  |
| 3.1 Definitions .....                                                                                              | 8  |
| 3.2 Symbols.....                                                                                                   | 8  |
| 3.3 Abbreviations .....                                                                                            | 8  |
| 4 Technical concepts .....                                                                                         | 9  |
| 4.1 New DPCCCH slot format.....                                                                                    | 10 |
| 4.1.1 Description of the concept .....                                                                             | 10 |
| 4.1.1.1 General description .....                                                                                  | 10 |
| 4.1.1.2 Detailed proposals.....                                                                                    | 12 |
| 4.1.1.2.1 SIR target adjustment .....                                                                              | 13 |
| 4.1.1.2.2 CPC initiation and termination .....                                                                     | 13 |
| 4.1.2 Analysis of the concept.....                                                                                 | 14 |
| 4.1.2.1 Simulation results on UL TPC error rate.....                                                               | 14 |
| 4.1.2.2 Simulation results on other UL channels .....                                                              | 17 |
| 4.1.2.2.1 CQI transmission .....                                                                                   | 19 |
| 4.1.2.2.2 HARQ-ACK transmission.....                                                                               | 26 |
| 4.1.2.2.3 Observations from simulations of HS-DPCCCH performance in sub-clauses 4.1.2.2.1 and 4.1.2.2.2 .....      | 31 |
| 4.1.2.3 Conclusions from TPC performance (sub-clause 4.1.2.1) and HS-DPCCCH performance (sub-clause 4.1.2.2) ..... | 32 |
| 4.1.2.4 Power control delay.....                                                                                   | 32 |
| 4.1.3 Benefits of the concept .....                                                                                | 33 |
| 4.1.4 Open issues of the concept.....                                                                              | 33 |
| 4.2 Uplink DPCCCH gating.....                                                                                      | 33 |
| 4.2.1 Description of the concept .....                                                                             | 33 |
| 4.2.1.1 General principle .....                                                                                    | 34 |
| 4.2.1.2 Basic packet traffic example .....                                                                         | 34 |
| 4.2.1.3 VoIP traffic example .....                                                                                 | 34 |
| 4.2.1.4 Operation of the uplink DPCCCH gating .....                                                                | 35 |
| 4.2.2 Analysis of the concept.....                                                                                 | 37 |
| 4.2.2.1 Power control stability .....                                                                              | 37 |
| 4.2.2.2 F-DPCH performance .....                                                                                   | 40 |
| 4.2.2.3 Uplink link performance .....                                                                              | 44 |
| 4.2.2.3.1 Additional link level results.....                                                                       | 46 |
| 4.2.2.3.2 Link level results for CQI decoding and for large TB sizes .....                                         | 54 |
| 4.2.2.3.3 Preamble detection link level result for uplink DPCCCH gating with long gating gap .....                 | 60 |
| 4.2.2.4 System performance.....                                                                                    | 62 |
| 4.2.2.4.1 Simulation assumptions .....                                                                             | 62 |
| 4.2.2.4.2 VoIP results with and without gating – 2 ms TTI.....                                                     | 62 |
| 4.2.2.4.3 VoIP results with and without gating – 10 ms TTI and packet bundling .....                               | 64 |
| 4.2.2.4.4 VoIP results - Summary .....                                                                             | 66 |
| 4.2.2.4.5 Impact of inactive users to cell throughput.....                                                         | 66 |
| 4.2.2.4.6 System-level performance with high-velocity UEs .....                                                    | 68 |
| 4.2.2.5 UE battery saving calculations .....                                                                       | 70 |
| 4.2.3 Benefits of the concept .....                                                                                | 73 |
| 4.2.4 Open issues of the concept.....                                                                              | 73 |

|            |                                                                            |     |
|------------|----------------------------------------------------------------------------|-----|
| 4.3        | SIR_target reduction.....                                                  | 73  |
| 4.3.1      | Description of the concept .....                                           | 73  |
| 4.3.1.1    | L1 signalling approach.....                                                | 73  |
| 4.3.1.1.1  | Interworking aspects.....                                                  | 75  |
| 4.3.1.1.2  | Handling of VoIP traffic.....                                              | 75  |
| 4.3.1.2    | L2 signalling approach.....                                                | 76  |
| 4.3.1.2.1  | New parameters for L2 signalling approach.....                             | 77  |
| 4.3.1.3    | Approach with predefined/configured rules.....                             | 77  |
| 4.3.2      | Analysis of the concept.....                                               | 78  |
| 4.3.2.1    | Simulation of the concept.....                                             | 78  |
| 4.3.2.1.1  | Simulation assumptions.....                                                | 78  |
| 4.3.2.1.2  | Simulation results.....                                                    | 79  |
| 4.3.2.2    | Noise rise caused by UL DPCCH.....                                         | 81  |
| 4.3.2.3    | Potential gain in terms of number of additional users & UL noise rise..... | 82  |
| 4.3.2.4    | Reactivation delay.....                                                    | 83  |
| 4.3.2.5    | Signalling load.....                                                       | 83  |
| 4.3.2.6    | CQI Performance for boosting HS-DPCCH power offset to DPCCH.....           | 83  |
| 4.3.2.6.1  | Simulations assumptions.....                                               | 83  |
| 4.3.2.6.2  | Simulations results.....                                                   | 84  |
| 4.3.3      | Benefits of the concept.....                                               | 85  |
| 4.3.4      | Open issues of the concept.....                                            | 86  |
| 4.4        | CQI reporting reduction.....                                               | 86  |
| 4.4.1      | Description of the concept.....                                            | 86  |
| 4.4.1.1    | L1 signalling approach for CQI off.....                                    | 86  |
| 4.4.1.1.1  | Interworking aspects.....                                                  | 87  |
| 4.4.1.2    | L2 signalling approach for CQI off.....                                    | 87  |
| 4.4.1.2.1  | New parameters for L2 signalling approach for CQI off.....                 | 88  |
| 4.4.1.3    | Predefined/configured rules for CQI reporting reduction.....               | 88  |
| 4.4.2      | Analysis of the concept.....                                               | 89  |
| 4.4.2.1    | Gain in terms of number of additional users & UL noise rise.....           | 89  |
| 4.4.2.2    | Signalling load.....                                                       | 89  |
| 4.4.3      | Benefits of the concept.....                                               | 89  |
| 4.4.4      | Open issues of the concept.....                                            | 90  |
| 4.5        | DRX at the UE.....                                                         | 90  |
| 4.5.1      | Description of the concept.....                                            | 90  |
| 4.5.2      | Analysis of the concept.....                                               | 90  |
| 4.5.2.1    | Timing, with 2 ms E-DCH TTI.....                                           | 90  |
| 4.5.2.1.1  | Background.....                                                            | 90  |
| 4.5.2.1.2  | DRX mode 2/8.....                                                          | 91  |
| 4.5.2.1.3  | DRX mode 1/8.....                                                          | 92  |
| 4.5.2.1.4  | DRX mode 1/16 and beyond.....                                              | 93  |
| 4.5.2.1.5  | DRX mode 2/8, in a 2 way soft handover.....                                | 93  |
| 4.5.2.1.6  | DRX mode 1/8, in a 2 way soft handover.....                                | 94  |
| 4.5.2.1.7  | DRX mode 1/16, in a 2 way soft handover.....                               | 94  |
| 4.5.2.2    | Downlink scheduler performance.....                                        | 95  |
| 4.5.2.2A   | Timing, with 10 ms E-DCH TTI.....                                          | 96  |
| 4.5.2.2A.1 | Background.....                                                            | 96  |
| 4.5.2.2A.2 | DRX mode 1/2.....                                                          | 97  |
| 4.5.2.2A.3 | DRX mode 1/3.....                                                          | 97  |
| 4.5.2.2A.4 | DRX mode 1/4.....                                                          | 97  |
| 4.5.2.2A.5 | DRX mode 1/4, in a 2 way soft handover.....                                | 98  |
| 4.5.2.3    | Impact of DRX in demodulation performance.....                             | 99  |
| 4.5.2.3.1  | Simulation assumptions.....                                                | 99  |
| 4.5.2.3.2  | Simulation results.....                                                    | 101 |
| 4.5.3      | Benefits of the concept.....                                               | 102 |
| 4.5.4      | Open issues of the concept.....                                            | 102 |
| 4.6        | Restricted HS-SCCH.....                                                    | 102 |
| 4.6.1      | Description of the concept.....                                            | 102 |
| 4.6.1.1    | HARQ Operation and Signalling.....                                         | 103 |
| 4.6.1.2    | Signalling of transport format.....                                        | 103 |
| 4.6.1.3    | Coding for HS-SCCH.....                                                    | 104 |
| 4.6.1.4    | HS-SCCH physical channel structure.....                                    | 105 |

|                               |                                                                                      |            |
|-------------------------------|--------------------------------------------------------------------------------------|------------|
| 4.6.1.5                       | UE reception of the restricted HS-SCCH.....                                          | 106        |
| 4.6.2                         | Analysis of the concept.....                                                         | 106        |
| 4.6.3                         | Benefits of the concept .....                                                        | 107        |
| 4.6.4                         | Open issues of the concept.....                                                      | 107        |
| 4.6.4.1                       | Unexpected and Erroneous Events.....                                                 | 107        |
| 4.6.4.1.1                     | ACK/NACK not received in response to a new transmission .....                        | 107        |
| 4.6.4.1.2                     | Buffer corruption .....                                                              | 107        |
| 4.6.4.1.3                     | HS-SCCH misdetection followed by ACK false alarm.....                                | 108        |
| 4.6.4.1.4                     | HS-SCCH misdetection followed by NACK false alarm.....                               | 108        |
| 4.7                           | HS-SCCH-less operation.....                                                          | 108        |
| 4.7.1                         | Description of the Concept .....                                                     | 108        |
| 4.7.2                         | Analysis of the concept.....                                                         | 109        |
| 4.7.2.1                       | Transmission waveform and timing.....                                                | 109        |
| 4.7.2.2                       | UE complexity discussion.....                                                        | 110        |
| 4.7.2.3                       | CRC discussion .....                                                                 | 111        |
| 4.7.2.4                       | VoIP and best effort capacity simulations.....                                       | 112        |
| 4.7.2.4.1                     | Simulation assumptions.....                                                          | 112        |
| 4.7.2.4.2                     | Simulation results .....                                                             | 114        |
| 4.7.3                         | Benefits of the concept .....                                                        | 116        |
| 4.7.4                         | Open issues of the concept.....                                                      | 116        |
| 4.8                           | Reduced complexity HS-SCCH-less operation.....                                       | 116        |
| 4.8.1                         | Description of the concept .....                                                     | 116        |
| 4.8.1.1                       | HS-SCCH for retransmissions with the reduced complexity HS-SCCH-less operation ..... | 117        |
| 4.8.2                         | Analysis of the concept.....                                                         | 118        |
| 4.8.2.1                       | Timing and operation .....                                                           | 118        |
| 4.8.2.2                       | UE Complexity discussion .....                                                       | 118        |
| 4.8.2.3                       | Simulation Results .....                                                             | 118        |
| 4.8.2.3.1                     | Simulation assumptions.....                                                          | 122        |
| 4.8.3                         | Benefits of the concept .....                                                        | 124        |
| 4.8.4                         | Open Issues of the concept .....                                                     | 125        |
| 4.A                           | Summary of technical concepts and possible combinations.....                         | 126        |
| 4.A.1                         | Overview of the technical concepts .....                                             | 126        |
| 4.A.2                         | Overview of possible combinations of technical concepts .....                        | 130        |
| 5                             | Technical solution .....                                                             | 132        |
| 5.1                           | Overview of the selected solution .....                                              | 132        |
| 5.1.1                         | New UL DPCCH slot format.....                                                        | 133        |
| 5.1.2                         | Discontinuous transmission and reception in CELL_DCH .....                           | 133        |
| 5.1.3                         | HS-SCCH less operation .....                                                         | 135        |
| 5.2                           | Impact on RAN1 specifications.....                                                   | 136        |
| 5.3                           | Impact on RAN2 specifications.....                                                   | 137        |
| 5.4                           | Impact on RAN3 specifications.....                                                   | 138        |
| 5.5                           | Impact on RAN4 specifications.....                                                   | 140        |
| 5.6                           | Change requests related to CPC .....                                                 | 140        |
| <b>Annex A (informative):</b> | <b>Change history .....</b>                                                          | <b>142</b> |
| History .....                 |                                                                                      | 144        |

---

# Foreword

This Technical Report has been produced by the 3<sup>rd</sup> Generation Partnership Project (3GPP).

The contents of the present document are subject to continuing work within the TSG and may change following formal TSG approval. Should the TSG modify the contents of the present document, it will be re-released by the TSG with an identifying change of release date and an increase in version number as follows:

Version x.y.z

where:

- x the first digit:
  - 1 presented to TSG for information;
  - 2 presented to TSG for approval;
  - 3 or greater indicates TSG approved document under change control.
- y the second digit is incremented for all changes of substance, i.e. technical enhancements, corrections, updates, etc.
- z the third digit is incremented when editorial only changes have been incorporated in the document.

---

# Introduction

Packet-oriented features like HSDPA and E-DCH in WCDMA/UMTS systems will promote the subscribers' desire for continuous connectivity, where the user stays connected over a long time span with only occasional active periods of data transmission, and avoiding frequent connection termination and re-establishment with its inherent overhead and delay.

This is the perceived mode a subscriber is used to in fixed broadband networks (e.g. DSL) and a precondition to attract users from fixed broadband networks.

To support a high number of HSDPA users in the code limited downlink the feature F-DPCH was introduced in REL-6.

In the uplink, the limiting factor for supporting a similarly high number of E-DCH users is the noise rise.

For such a high number of users in the cell it can be assumed that many users are not transmitting any user data for some time (e.g. for reading during web browsing or in between packets for periodic packet transmission such as VoIP). The corresponding overhead in the noise rise caused by maintained control channels will significantly limit the number of users that can be efficiently supported.

As completely releasing dedicated channels during periods of traffic inactivity would cause considerable delays for reestablishing data transmission and a corresponding bad user perception, this WI is intended to reduce the impact of control channels on uplink noise rise while maintaining the connections and allowing a much faster reactivation for temporarily inactive users.

---

# 1 Scope

The present document summarizes the work done under the WI "Continuous Connectivity for Packet Data Users" defined in [1] by listing technical concepts addressing the objectives of the work item (see below), analysing these technical concepts and selecting the best solution (which might be a combination of technical concepts).

“The objective of this work item is to reduce the uplink noise rise from physical control channels of packet data users, e.g. for users which have temporarily no data transmission.

This is intended to significantly increase the number of packet data users (i.e. HS-DSCH/E-DCH users without UL DPDCH) in the UMTS FDD system that can stay in CELL\_DCH state over a long time period, without degrading cell throughput, and that can restart transmission after a period of inactivity with a much shorter delay (<50ms) than would be necessary for reestablishment of a new connection

The objective covers also schemes which could allow improving the achievable UL capacity for VoIP users with its inherent periodic transmission through reducing the overhead of the control channels.

Mobility and downlink transmission should not be impacted for these users.”

The present document provides the base for the following preparation of change requests to the corresponding RAN specifications.

---

# 2 References

The following documents contain provisions which, through reference in this text, constitute provisions of the present document.

- References are either specific (identified by date of publication, edition number, version number, etc.) or non-specific.
- For a specific reference, subsequent revisions do not apply.
- For a non-specific reference, the latest version applies. In the case of a reference to a 3GPP document (including a GSM document), a non-specific reference implicitly refers to the latest version of that document *in the same Release as the present document*.

- [1] 3GPP Tdoc RP-050429: "Proposal for a WI description for 'Continuous connectivity for packet data users'", TSG RAN #29, Aug./Sep. 2005, Tallinn, Estonia.
- [2] 3GPP TR 21.905: "Vocabulary for 3GPP Specifications".
- [3] 3GPP TS 25.211: "Physical channels and mapping of transport channels onto physical channels (FDD)".
- [4] 3GPP TS 25.212: "Multiplexing and channel coding (FDD)".
- [5] 3GPP TS 25.213: "Spreading and modulation (FDD)".
- [6] 3GPP TS 25.214: " Physical layer procedures (FDD)".
- [7] 3GPP TS 25.215: "Physical layer – Measurements (FDD)".
- [8] 3GPP TS 25.306: "UE Radio Access Capabilities".
- [9] 3GPP TS 25.308: "UTRA High Speed Downlink Packet Access (HSDPA); Overall description; Stage 2".
- [10] 3GPP TS 25.309: "FDD Enhanced Uplink; Overall description; Stage 2". (for REL-7 see [23])
- [11] 3GPP TS 25.321: "Medium Access Control (MAC) protocol specification".
- [12] 3GPP TS 25.331: "Radio Resource Control (RRC) Protocol Specification".



- [13] 3GPP TS 25.433: "UTRAN Iub Interface NBAP Signalling".
- [14] 3GPP TS 25.133: "Requirements for Support of Radio Resource Management (FDD)".
- [15] 3GPP Tdoc RP-050427: "Status report of SI 'Continuous connectivity for packet data users' to TSG RAN #29", TSG RAN #29, Aug./Sep. 2005, Tallinn, Estonia.
- [16] 3GPP Tdoc RP-050670: "Status report of WI 'Continuous connectivity for packet data users' to TSG RAN #30", TSG RAN #30, Nov./Dec. 2005, Saint Julian, Malta.
- [17] 3GPP Tdoc RP-050870: " Update of WI description for 'Continuous connectivity for packet data users'", TSG RAN #30, Nov./Dec. 2005, Saint Julian, Malta.
- [18] 3GPP Tdoc RP-060019: "Status report of WI 'Continuous connectivity for packet data users' to TSG RAN #31", TSG RAN #31, March 2006, Sanya/Hainan, China.
- [19] 3GPP TS 25.101: "User Equipment (UE) radio transmission and reception (FDD)".
- [20] 3GPP Tdoc RP-060241: "Status report of WI 'Continuous connectivity for packet data users' to TSG RAN #32", TSG RAN #32, May/June 2006, Warsaw, Poland.
- [21] 3GPP Tdoc RP-060454: "Status report of WI 'Continuous connectivity for packet data users' to TSG RAN #33", TSG RAN #33, Sep. 2006, Palm Springs, USA.
- [22] 3GPP Tdoc RP-060454: "Status report of WI 'Continuous connectivity for packet data users' to TSG RAN #34", TSG RAN #34, Nov./Dec. 2006, Budapest, Hungary.
- [23] 3GPP TS 25.319: "Enhanced Uplink; Overall description; Stage 2 (Release 7)".
- [24] 3GPP Tdoc RP-070033: "Status report of WI 'Continuous connectivity for packet data users' to TSG RAN #35", TSG RAN #35, March 2007, Lemesos, Cyprus.

---

## 3 Definitions, symbols and abbreviations

### 3.1 Definitions

For the purposes of the present document, the [following] terms and definitions [given in ... and the following] apply.

**example:** text used to clarify abstract rules by applying them literally.

### 3.2 Symbols

For the purposes of the present document, the following symbols apply:

<symbol>            <Explanation>

### 3.3 Abbreviations

For the purposes of the present document, the following abbreviations apply:

|       |                                                                 |
|-------|-----------------------------------------------------------------|
| ACK   | Acknowledgement                                                 |
| CQI   | Channel Quality Indicator                                       |
| CPC   | Continuously Packet Connected or Continuous Packet Connectivity |
| CRC   | Cyclic Redundancy Check                                         |
| DCH   | Dedicated Channel                                               |
| DL    | Downlink                                                        |
| DPCCH | Dedicated Physical Control Channel                              |
| DPCH  | Dedicated Physical Channel                                      |
| DPDCH | Dedicated Physical Data Channel                                 |
| DTX   | Discontinuous Transmission                                      |
| E-DCH | Enhanced Dedicated Channel                                      |

|          |                                                     |
|----------|-----------------------------------------------------|
| E-DPCCH  | E-DCH Dedicated Physical Control Channel            |
| E-DPDCH  | E-DCH Dedicated Physical Data Channel               |
| E-AGCH   | E-DCH Absolute Grant Channel                        |
| E-HICH   | E-DCH HARQ Acknowledgement Indicator Channel        |
| E-RGCH   | E-DCH Relative Grant Channel                        |
| F-DPCH   | Fractional Dedicated Physical Channel               |
| HSDPA    | High Speed Downlink Packet Access                   |
| HS-DSCH  | High Speed Downlink Shared Channel                  |
| HS-PDSCH | High Speed Physical Downlink Shared Channel         |
| HS-SCCH  | High Speed Physical Downlink Shared Control Channel |
| NACK     | Negative Acknowledgement                            |
| P-CCPCH  | Primary Common Control Physical Channel             |
| RL       | Radio Link                                          |
| S-CCPCH  | Secondary Common Control Physical Channel           |
| SCH      | Synchronisation Channel                             |
| SIR      | Signal-to-Interference Ratio                        |
| TFC      | Transport Format Combination                        |
| TPC      | Transmit Power Control                              |
| TPC CER  | TPC Command Error Rate                              |
| TTI      | Transmission Time Interval                          |
| UE       | User Equipment                                      |
| UL       | Uplink                                              |
| UTRAN    | UMTS Terrestrial Radio Access Network               |

---

## 4 Technical concepts

This section describes and analyses the suggested technical concepts addressing the problem described by the work item “Continuous Connectivity for Packet Data Users” defined in [1]. This section 4 includes feasible concepts to address the WI without claiming that the concepts are complete or restricting the addition of alternatives.

The following **common base for all concepts** can be assumed:

- Packet data users in CELL\_DCH state using HSDPA and E-DCH as described in REL-6 are addressed.
- The UE is and will remain in the CELL\_DCH RRC state whatever continuous connectivity concept will be applied.
- The signalling radio bearers (SRBs) are assumed to be mapped on HS-DSCH in downlink (as is necessary for F-DPCH, anyway) and on E-DCH in uplink.
- UL channels present in this case: UL DPCCH, HS-DPCCH, E-DPCCH, E-DPDCH (E-DPCCH, E-DPDCH are DTXed when no data (or rate requests) needs to be transmitted on E-DPDCH).
- DL channels present in this case: F-DPCH, HS-SCCH, HS-PDSCH, E-AGCH, E-RGCH, E-HICH. To avoid DL channelization code limitations F-DPCH instead of DL DPCCH is considered.

Different **phases during the stay in the CELL\_DCH state** can be distinguished by the activity of the data channels:

- Packet on HS-PDSCH is transmitted to the UE in the TTI.
- inactive DL: No packet is transmitted on HS-PDSCH to the UE in the TTI.
- Packet on E-DPDCH is transmitted to the Node B in the TTI.
- inactive UL: No packet is transmitted on E-DPDCH to the Node B in the TTI.

It is the aim that the application of a continuous connectivity concept will not affect the performance of a transmission in an active TTI.

The description of the active and inactive phases does not preclude the way and whether or not CELL\_DCH substates should be introduced.

The continuous connectivity concepts are addressing the control channels (i.e. one or more) during inactive phases in UL and/or DL.

The triggers for initiating and terminating the use of a continuous connectivity concept relative to the start and end of active and inactive phases depend on the considered concept. For example:

- whether the concept is triggered when there is inactivity in just one direction (i.e. only DL, only UL) or in both directions (UL & DL);
- whether a transition from activity to inactivity will directly trigger the application of the concept or whether there is a short period of inactive phase without applying the concept (e.g. if a timer is used to trigger the concept);
- whether very short periods of DL and/or UL inactivity (e.g. during transmission of VoIP packets or where a UE is not scheduled but data is waiting in the scheduler queue) could also be addressed by a continuous connectivity concept.
- whether during an inactive phase the concept is used during transmission of physical layer signalling (e.g. on HS-DPCCH or HS-SCCH).

The period during which a continuous connectivity concept is applied is called "Continuously Packet Connected mode" or shorter "CPC mode".

#### **Transitions between the different phases:**

The following transitions are called "CPC initiation":

- active phase **to** CPC mode
- inactive phase where REL-6 is applied as usual **to** CPC mode

while the transition back is called "CPC termination":

- CPC mode **to** active phase.
- CPC mode **to** inactive phase where REL-6 is applied as usual

Triggers for the transitions and a description of the signalling (e.g. L1 or L2 signalling) or the implicit rules/blind detection (if no signalling is required) for the transitions has to be described in the different continuous connectivity concepts.

Nevertheless, three general transition control approaches (i.e. who will have the final decision about the transition) could be distinguished:

- transition is controlled by the UE
- transition is controlled by the Node B
- transition is controlled by predefined rules applied by both UE and Node B

This includes also the possibility to have a combination for different links (i.e. UL/DL) or transitions (i.e. CPC initiation/termination).

Another aspect to be described for each concept is the question of how reliable is the control of the CPC initiation and termination.

## **4.1 New DPCCH slot format**

### **4.1.1 Description of the concept**

#### **4.1.1.1 General description**

The primary purpose of the continuous DPCCH when data is not being transmitted is to maintain synchronisation and power control ready for a rapid resumption of data transmission when needed.

This is different from the case when data is being transmitted, when the DPCCH also has to act as the phase reference for the data, and possibly also carry TFCI and/or FBI.

The DPCCH slot formats which are available up to Release 6 are primarily adapted to the case when data is being transmitted, but are not necessarily suitable for minimising the overhead when the DPCCH is the only uplink channel. In particular, none of the existing DPCCH slot formats have more than 2 TPC bits, while the pilot field occupies between 5 and 8 bits, reflecting the need for sufficient pilot energy to give a reliable channel estimate for decoding data.

One way to reduce the DPCCH overhead could therefore be to introduce a new DPCCH slot format which is better suited to the case when effectively the only data bits are the TPC bits. Typically this would involve reducing the pilot energy per slot.

Some possible new slot formats are shown in Figure 4.1.1.1-1 to Figure 4.1.1.1-3.

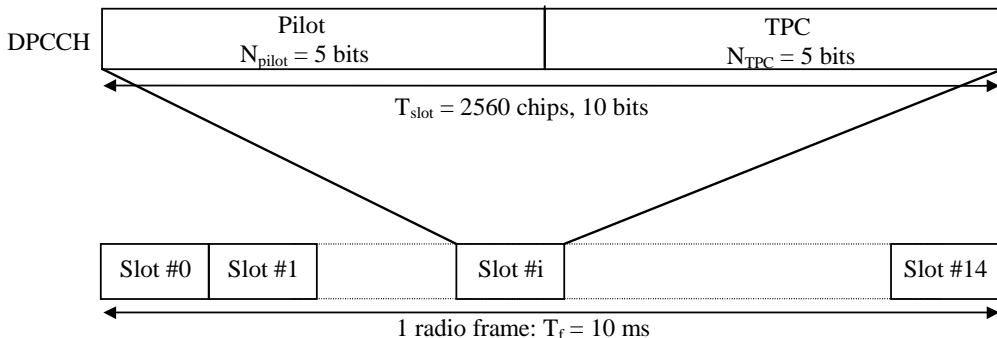

Figure 4.1.1.1-1: One possible new DPCCH slot format (Format a)

The slot format shown in figure 4.1.1.1-1 has an equal number of pilot and TPC bits. Typically this optimises the pilot-to-TPC ratio if the channel phase estimation is being carried out over a single slot.

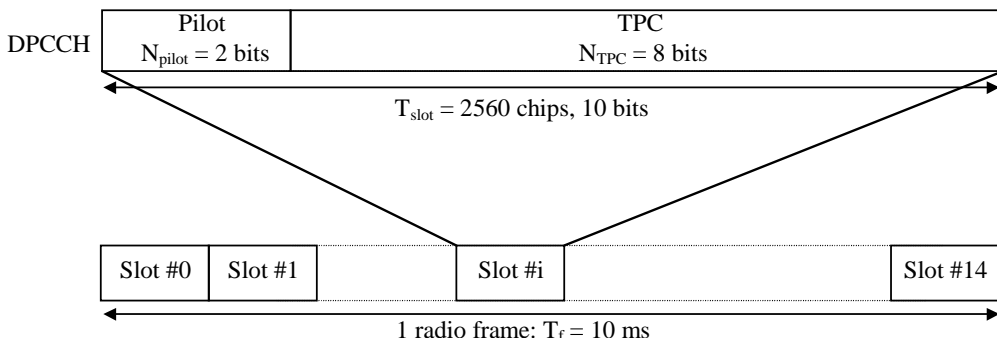
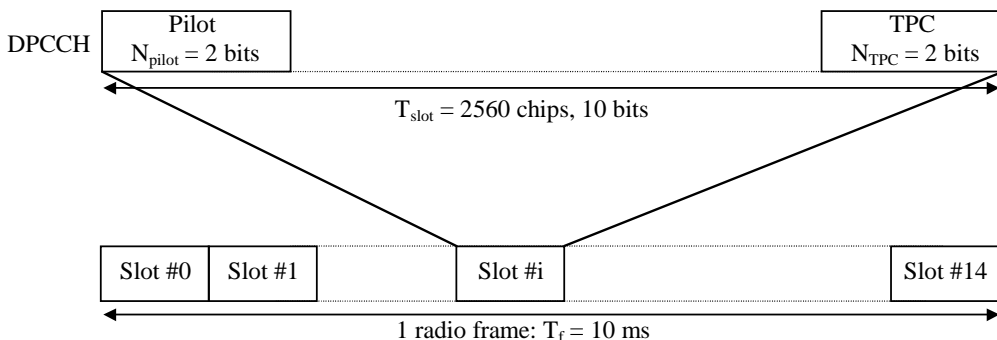

Figure 4.1.1.1-2: A second possible new slot format (Format b)

Figure 4.1.1.1-2 shows an example which may be better suited to a slowly-changing channel when the channel phase estimation may be averaged over a number of consecutive slots. Here the TPC field is increased in size even more than in figure 4.1.1.1-1, thus enabling a larger reduction in DPCCH transmit power.

A reduction in SIR target would be applied at the Node B when a slot format like those in figure 4.1.1.1-1 or figure 4.1.1.1-2 was being used. A power step on the DPCCH could also be applied in order for the power control loop to converge quickly.

Reducing the DPCCH power in this way enables the uplink control channel overhead to be reduced, and hence more inactive users to be supported in CELL\_DCH state.



**Figure 4.1.1.1-3: A third possible new slot format (Format c)**

Figure 4.1.1.1-3 shows a slot format where the number of pilot bits is reduced to a suitable number for the current size of the TPC field. DTX would be used between the pilot and TPC fields. This type of slot format would give a reduction in the average overhead, with the noise rise from an individual user being discontinuous.

Other possibilities, for example with 4 or 6 pilot bits, could also be considered, but the number of new slot formats should be minimised, preferably to a single new slot format.

### 4.1.1.2 Detailed proposals

In this section specific proposals are described in more detail.

As an example, a new slot format may be introduced into 25.211 as shown in Table 4.1.1.2-1, where the new format 1\* is associated with the existing slot format 1. When slot format 1\* is configured by the RNC, the slot format could switch to slot format 1 during certain periods when more pilot energy is required. The switching between slot formats 1 and 1\* could be according to predefined rules. This is discussed further in sub-clause 4.1.2.3. Configuring the new slot format under the control of the RNC in this way also allows compatibility with Node B's that do not support the new slot format.

**Table 4.1.1.2-1: New slot format: Proposal A**

| Slot Form at #1 | Channel Bit Rate (kbps) | Channel Symbol Rate (ksps) | SF  | Bits/ Frame | Bits/ Slot | N <sub>pilot</sub> | N <sub>TPC</sub> | N <sub>TFCl</sub> | N <sub>FBI</sub> | Transmitted slots per radio frame |
|-----------------|-------------------------|----------------------------|-----|-------------|------------|--------------------|------------------|-------------------|------------------|-----------------------------------|
| 0               | 15                      | 15                         | 256 | 150         | 10         | 6                  | 2                | 2                 | 0                | 15                                |
| 0A              | 15                      | 15                         | 256 | 150         | 10         | 5                  | 2                | 3                 | 0                | 10-14                             |
| 0B              | 15                      | 15                         | 256 | 150         | 10         | 4                  | 2                | 4                 | 0                | 8-9                               |
| 1               | 15                      | 15                         | 256 | 150         | 10         | 8                  | 2                | 0                 | 0                | 8-15                              |
| 1*              | 15                      | 15                         | 256 | 150         | 10         | 5                  | 5                | 0                 | 0                | 8-15                              |
| 2               | 15                      | 15                         | 256 | 150         | 10         | 5                  | 2                | 2                 | 1                | 15                                |
| 2A              | 15                      | 15                         | 256 | 150         | 10         | 4                  | 2                | 3                 | 1                | 10-14                             |
| 2B              | 15                      | 15                         | 256 | 150         | 10         | 3                  | 2                | 4                 | 1                | 8-9                               |
| 3               | 15                      | 15                         | 256 | 150         | 10         | 7                  | 2                | 0                 | 1                | 8-15                              |

As a further example, a new slot format may be introduced as shown in Table 4.1.1.2-2, where the use of the new format 4 can only be configured by the RNC in the normal way (i.e. its use does not depend on transmission activity on other channels).

Table 4.1.1.2-2: New slot format: Proposal B

| Slot Form at #1 | Channel Bit Rate (kbps) | Channel Symbol Rate (ksps) | SF  | Bits/ Frame | Bits/ Slot | N <sub>pilot</sub> | N <sub>TPC</sub> | N <sub>TFCI</sub> | N <sub>FBI</sub> | Transmitted slots per radio frame |
|-----------------|-------------------------|----------------------------|-----|-------------|------------|--------------------|------------------|-------------------|------------------|-----------------------------------|
| 0               | 15                      | 15                         | 256 | 150         | 10         | 6                  | 2                | 2                 | 0                | 15                                |
| 0A              | 15                      | 15                         | 256 | 150         | 10         | 5                  | 2                | 3                 | 0                | 10-14                             |
| 0B              | 15                      | 15                         | 256 | 150         | 10         | 4                  | 2                | 4                 | 0                | 8-9                               |
| 1               | 15                      | 15                         | 256 | 150         | 10         | 8                  | 2                | 0                 | 0                | 8-15                              |
| 2               | 15                      | 15                         | 256 | 150         | 10         | 5                  | 2                | 2                 | 1                | 15                                |
| 2A              | 15                      | 15                         | 256 | 150         | 10         | 4                  | 2                | 3                 | 1                | 10-14                             |
| 2B              | 15                      | 15                         | 256 | 150         | 10         | 3                  | 2                | 4                 | 1                | 8-9                               |
| 3               | 15                      | 15                         | 256 | 150         | 10         | 7                  | 2                | 0                 | 1                | 8-15                              |
| 4               | 15                      | 15                         | 256 | 150         | 10         | 6                  | 4                | 0                 | 0                | 8-15                              |

#### 4.1.1.2.1 SIR target adjustment

In order to gain maximum benefit from a new slot format used during periods of with no uplink data transmission, at least the serving Node B should reduce its SIR target by a specified amount during the period with no uplink data, and the following behaviour should also occur:

- At the start of usage of the new slot format, the UE should reduce its DPCCH transmit power by a specified amount.
- At the end of usage of the new slot format, the UE should increase its DPCCH transmit power by a specified amount.

As an example, the methods described for SIR target reduction in section 4.3 could be used.

#### 4.1.1.2.2 CPC initiation and termination

The initiation and termination of CPC operation would be different for the two proposals given in sub-clause 4.1.1.2.

For **Proposal A** (Table 4.1.1.2-1), CPC initiation would comprise configuring the use of slot format #1\* by RRC signalling in the usual way. Predefined rules for switching between slot format #1\* and slot format #1 could then be used, for example comprising using slot format #1 in all DPCCH slots which start at the beginning of or during either HS-DPCCH transmission, DPDCH transmission or E-DPCCH transmission, and using slot format #1\* in all other DPCCH slots.

The HS-DSCH Serving Node B can predict exactly when HS-DPCCH transmissions will occur, and can therefore predict whether slot format #1 or slot format #1\* is being used. The serving Node B can therefore derive the channel estimate and decode the DPCCH correctly in this case. Other Node Bs do not have to decode the HS-DPCCH transmissions, but could nonetheless use detected HS-DPCCH energy to help determine which of slot formats 1 and 1\* was being used.

For E-DPCCH/E-DPDCH transmission, the change of slot format could be detected on the basis of detected E-DPCCH/E-DPDCH energy (similar to blind transport format detection using received power ratio). The E-DCH Serving RLS also has knowledge of the Serving Grant and UE buffer status, and can therefore make a more reliable estimate of when E-DPCCH is transmitted.

These possibilities are discussed further in sub-clause 4.1.2.3, where conclusions are also drawn in the light of the simulation results.

Depending on the choice of pilot pattern, Node Bs could also use differences in bit pattern to detect a change of DPCCH slot format. However, in order to avoid blind slot-format detection in non-serving Node Bs in soft handover, it seems preferable to set the pilot pattern for the new slot format 1\* to be the same as the first bits of the pilot pattern for the associated slot format 1. This is illustrated in Table Y for a new slot format 1\* with 5 pilot bits and 5 TPC bits. The existing Rel-99 pilot pattern for slot format 1 (8 pilot bits) is also shown for comparison.

| Bit #  | N <sub>pilot</sub> = 5 (slot format 1*) |   |   |   |   | N <sub>pilot</sub> = 8 (slot format 1) |   |   |   |   |   |   |   |
|--------|-----------------------------------------|---|---|---|---|----------------------------------------|---|---|---|---|---|---|---|
|        | 0                                       | 1 | 2 | 3 | 4 | 0                                      | 1 | 2 | 3 | 4 | 5 | 6 | 7 |
| Slot#0 | 1                                       | 1 | 1 | 1 | 1 | 1                                      | 1 | 1 | 1 | 1 | 1 | 1 | 0 |
| 1      | 1                                       | 0 | 1 | 0 | 1 | 1                                      | 0 | 1 | 0 | 1 | 1 | 1 | 0 |
| 2      | 1                                       | 0 | 1 | 1 | 1 | 1                                      | 0 | 1 | 1 | 1 | 0 | 1 | 1 |
| 3      | 1                                       | 0 | 1 | 0 | 1 | 1                                      | 0 | 1 | 0 | 1 | 0 | 1 | 0 |
| 4      | 1                                       | 1 | 1 | 0 | 1 | 1                                      | 1 | 1 | 0 | 1 | 0 | 1 | 1 |
| 5      | 1                                       | 1 | 1 | 1 | 1 | 1                                      | 1 | 1 | 1 | 1 | 1 | 1 | 0 |
| 6      | 1                                       | 1 | 1 | 1 | 1 | 1                                      | 1 | 1 | 1 | 1 | 0 | 1 | 0 |
| 7      | 1                                       | 1 | 1 | 0 | 1 | 1                                      | 1 | 1 | 0 | 1 | 0 | 1 | 0 |
| 8      | 1                                       | 0 | 1 | 1 | 1 | 1                                      | 0 | 1 | 1 | 1 | 1 | 1 | 0 |
| 9      | 1                                       | 1 | 1 | 1 | 1 | 1                                      | 1 | 1 | 1 | 1 | 1 | 1 | 1 |
| 10     | 1                                       | 0 | 1 | 1 | 1 | 1                                      | 0 | 1 | 1 | 1 | 0 | 1 | 1 |
| 11     | 1                                       | 1 | 1 | 0 | 1 | 1                                      | 1 | 1 | 0 | 1 | 1 | 1 | 1 |
| 12     | 1                                       | 1 | 1 | 0 | 1 | 1                                      | 1 | 1 | 0 | 1 | 0 | 1 | 0 |
| 13     | 1                                       | 0 | 1 | 0 | 1 | 1                                      | 0 | 1 | 0 | 1 | 1 | 1 | 1 |
| 14     | 1                                       | 0 | 1 | 0 | 1 | 1                                      | 0 | 1 | 0 | 1 | 1 | 1 | 1 |

This enables the non-serving Node Bs always to decode two TPC bits at the end of each slot using a channel estimate derived from the first 5 pilot bits, without needing to do any blind detection of the change of slot format.

For **Proposal B** (Table 4.1.1.2-2), Slot Format #4 would be configured by the RNC in the normal way, so fast switching would not occur.

A combination of Proposals A and B could also be considered, by adding both slot format #1\* and slot format #4 to the slot formats table for UL DPCCH. In this case, it would be possible for the RNC to configure the new slot format either to be used in all slots (by configuring slot format #4), or only in inactive slots (by configuring slot format #1 and enabling the use of slot format #1\*).

## 4.1.2 Analysis of the concept

### 4.1.2.1 Simulation results on UL TPC error rate

The performance results here show the UL DPCCH  $E_b/N_0$  required to achieve a given UL TPC error rate for some different DPCCH slot formats. These would be applicable for the case where only the UL DPCCH is present.

The simulation assumptions are as follows:

- 2GHz carrier frequency
- DPCCH SF = 256
- Non-SHO
- UL power control using PCA1 and a 1dB step size, with a 4% error rate on DL TPC commands
- DL power control using DPC\_MODE= 0 is assumed
- Dual-antenna receive-diversity at Node B
- Uplink channel phase estimation averaged over either 1 or 3 slots
- UL channel model: PA, PB or VA
- UE speed 3 or 120km/h

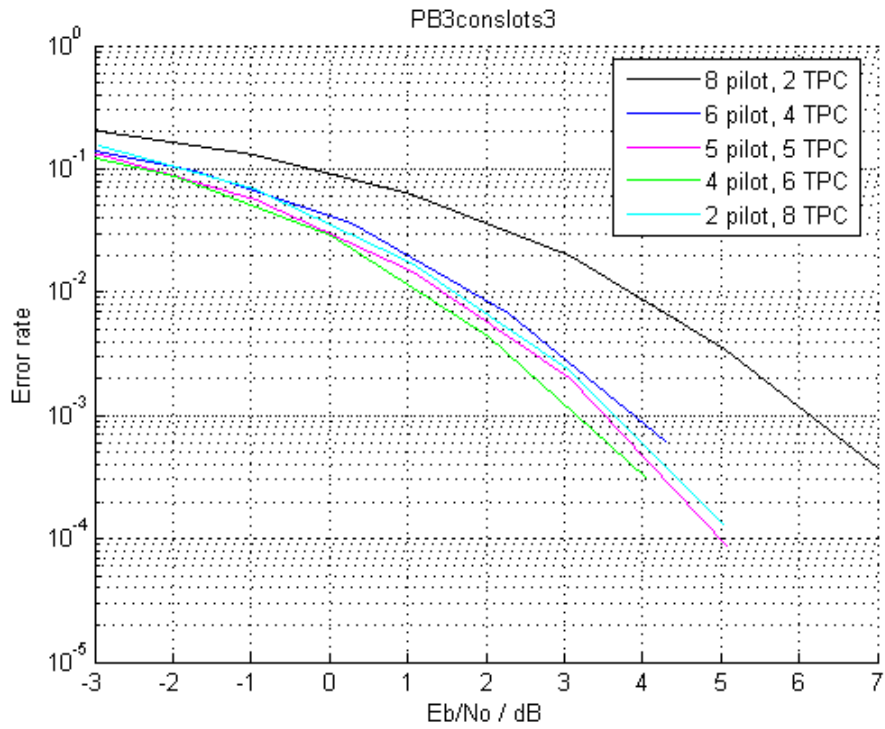

Figure 4.1.2.1-1: UL TPC error rate for PB3 with 3-slot channel estimate

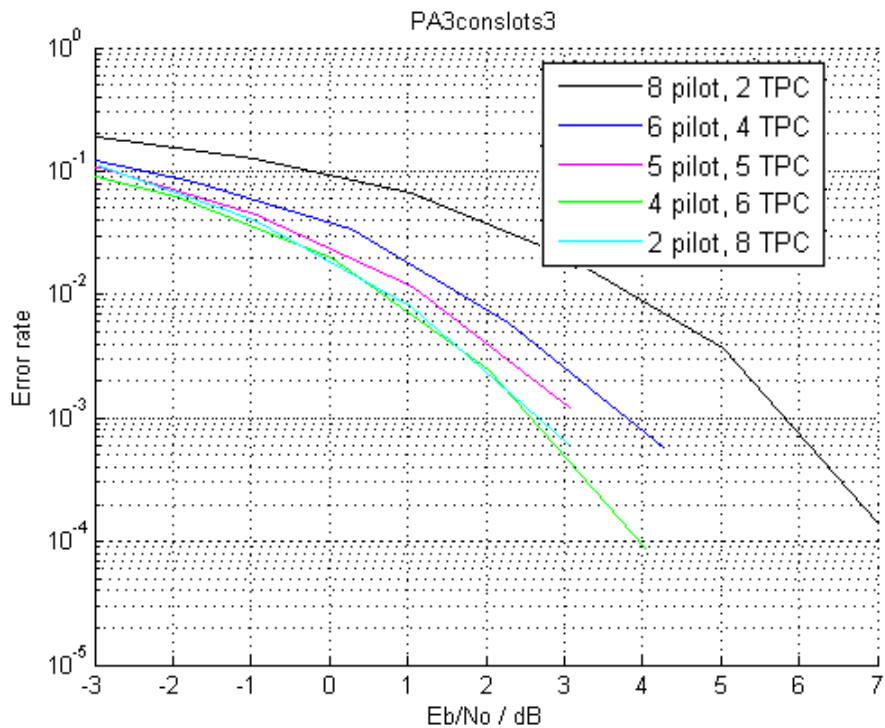

Figure 4.1.2.1-2: UL TPC error rate for PA3 with 3-slot channel estimate



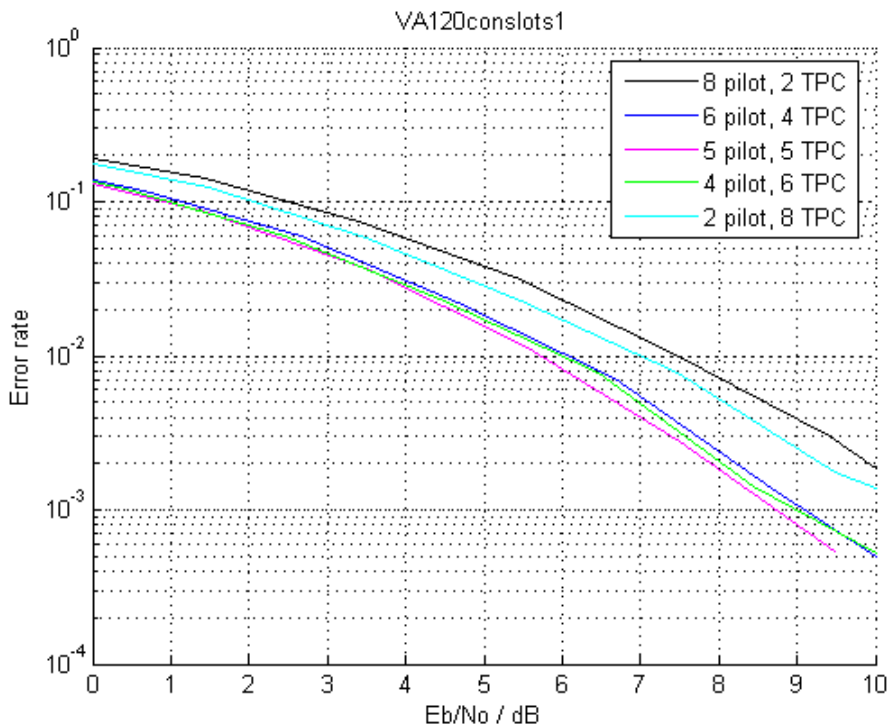

Figure 4.1.2.1-3: UL TPC error rate for VA120 with 1-slot channel estimate

The simulation results presented above for PA, PB and VA channels at UE speeds from 3km/h to 120km/h show that the  $E_b/N_0$  required for the UL DPCCH can be reduced for a given TPC error rate by changing the ratio of pilot to TPC bits per slot. The gains are typically in the region 2-3dB.

Considering the simulations above showing the TPC error rate, a slot format with 4 pilot bits and 6 TPC bits seems to give robust performance regardless of the averaging period of the channel estimate.

Another set of simulations was run with different algorithms. The simulation parameters are listed in Table 4.1.2.1-1 and the results are shown in Figure 4.1.2.1-4.

Table 4.1.2.1-1: Simulation parameters for simulations with realistic algorithms

| Parameter            | Value                                                                                                                                              | Comment                                     |
|----------------------|----------------------------------------------------------------------------------------------------------------------------------------------------|---------------------------------------------|
| Simulation time      | 5000 frames (25000 TTIs)                                                                                                                           |                                             |
| E-DCH data rate      | 160 kbps (2ms TTI, 320 bits TB size)                                                                                                               | Full buffer                                 |
| E-DPDCH/DPCCH        | 8 dB                                                                                                                                               |                                             |
| E-DPCCH/DPCCH        | 0 dB                                                                                                                                               |                                             |
| HS-DPCCH/DPCCH       | 0 dB                                                                                                                                               |                                             |
| DPDCH                | OFF                                                                                                                                                |                                             |
| DPCCH slot formats   | 8 pilots + 2 TPC (slot format 1)<br>6 pilots + 4 TPC (new slot format)<br>5 pilots + 5 TPC (new slot format)<br>4 pilots + 6 TPC (new slot format) |                                             |
| Channel models       | AWGN<br>Pedestrian A, 3 km/h<br>Vehicular A, 30 km/h<br>Vehicular A, 120 km/h                                                                      |                                             |
| UL power control     | ON                                                                                                                                                 | 0% error rate, 1-dB step size, 2-slot delay |
| Node B Rx antennas   | 2                                                                                                                                                  |                                             |
| Channel estimation   | Realistic                                                                                                                                          | TPC-aided 2-slot sliding average            |
| SIR estimation       | Realistic                                                                                                                                          |                                             |
| Path delay search    | Realistic                                                                                                                                          |                                             |
| Frequency estimation | Ideal                                                                                                                                              |                                             |
| HARQ                 | ON                                                                                                                                                 | Max 4 transmissions                         |

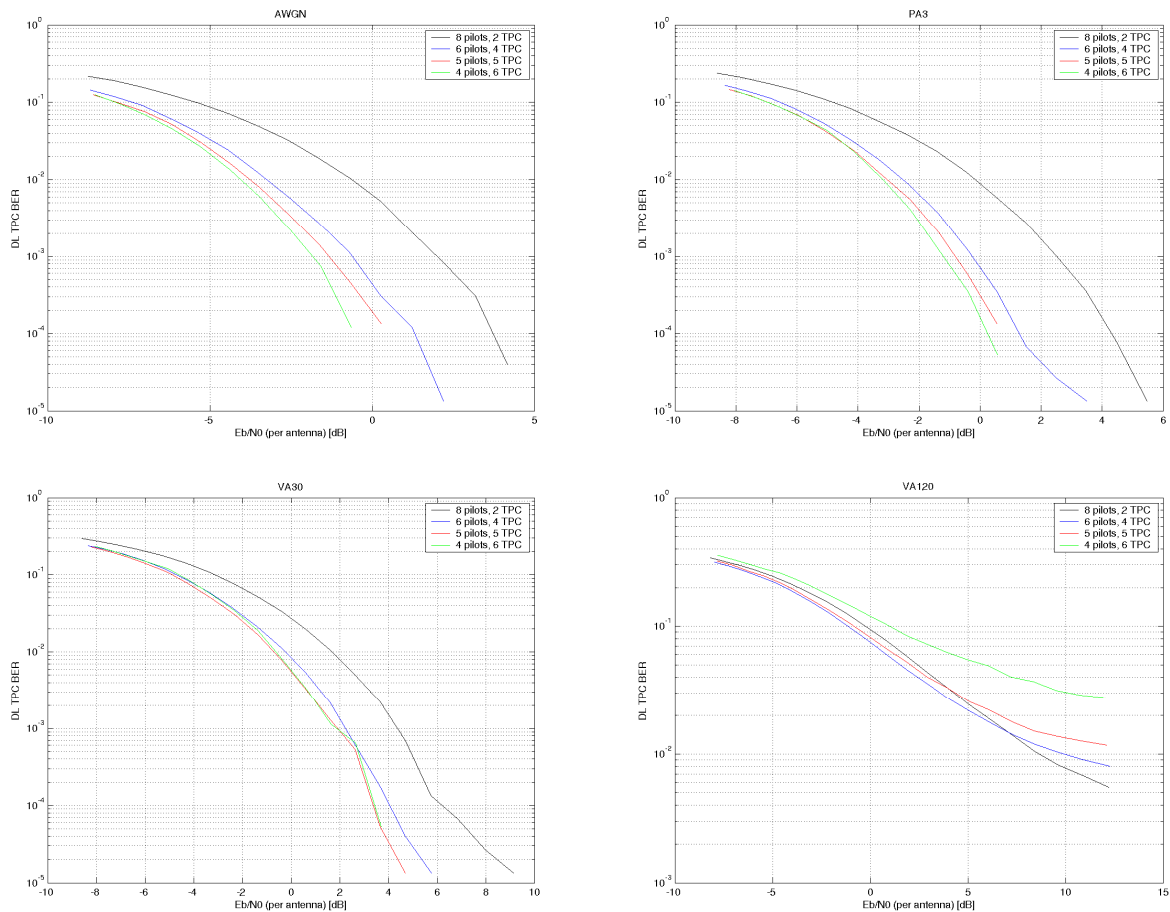

Figure 4.1.2.1-4: DL TPC BER for different UL DPCCH slot formats and various channel models

### 4.1.2.2 Simulation results on other UL channels

The basic simulation assumptions here are as follows:

- 2GHz carrier frequency
- DPCCH SF = 256
- Non-SHO
- UL power control using PCA1 and a 1dB step size, with a 4% error rate on DL TPC commands
- Dual-antenna receive-diversity at Node B
- Uplink channel phase estimation averaged over 1 to 3 slots, TPC-aided where shown
- UL channel model: PA, PB or VA
- UE speed 3, 30 or 120km/h

The case of HS-DPCCH being transmitted in parallel with the DPCCH is considered, to examine the effect of changing the DPCCH slot format on the decoding of the HS-DPCCH. For the HS-DPCCH, the following assumptions are used:

- $\beta_{hs} = \beta_c$  ( $\Delta_{ACK} = \Delta_{NACK} = \Delta_{CQI}$ )
- $N_{cqi\_transmit} = 1$  (i.e. no repetition)
- $N_{acknack\_transmit} = 1$  (i.e. no repetition)
- Node B detection threshold for ACK configured to give  $P(ACK|DTX) = 0.1$  (assuming the probability of missed detection for HS-SCCH at the UE is  $10e-2$ ).

Under these conditions, the CQI and ACK error rates are measured, using two different types of channel estimation:

- Channel estimation using DPCCH pilot bits only
- TPC-aided channel estimation (using both pilot bits and TPC bits)

MLSE decoding is used for CQI.

The following DPCCH slot formats are evaluated:

| Slot Form at #1 | Channel Bit Rate (kbps) | Channel Symbol Rate (ksps) | SF  | Bits/ Frame | Bits/ Slot | $N_{pilot}$ | $N_{TPC}$ | $N_{TFCI}$ | $N_{FBI}$ |
|-----------------|-------------------------|----------------------------|-----|-------------|------------|-------------|-----------|------------|-----------|
| 1               | 15                      | 15                         | 256 | 150         | 10         | 8           | 2         | 0          | 0         |
| New 1           | 15                      | 15                         | 256 | 150         | 10         | 5           | 5         | 0          | 0         |
| New 2           | 15                      | 15                         | 256 | 150         | 10         | 4           | 6         | 0          | 0         |

4.1.2.2.1 CQI transmission

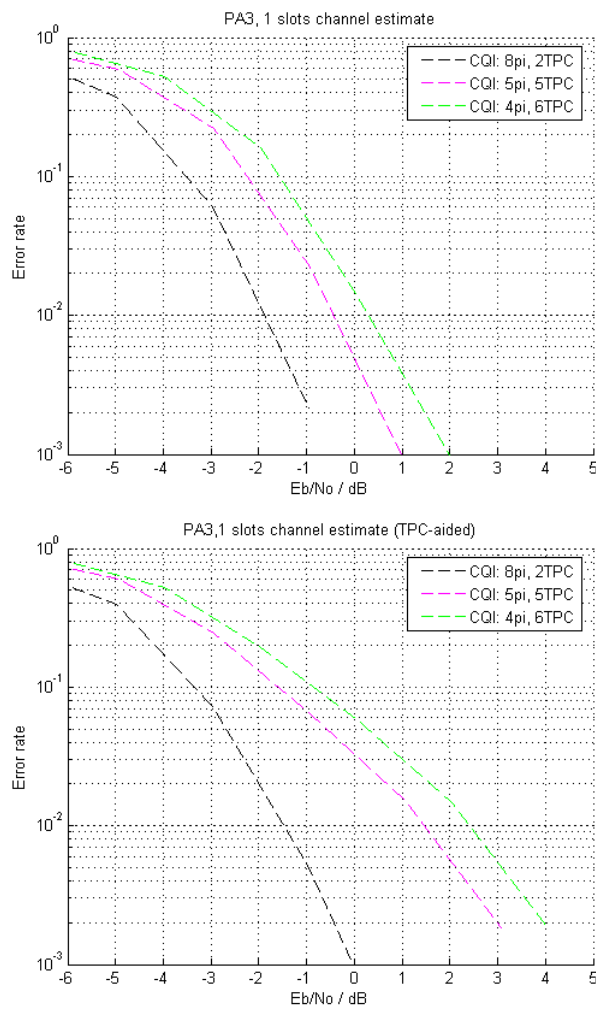

Figure 4.1.2.2.1-1: CQI performance in PA3, 1 slot channel estimation, with and without TPC-assistance

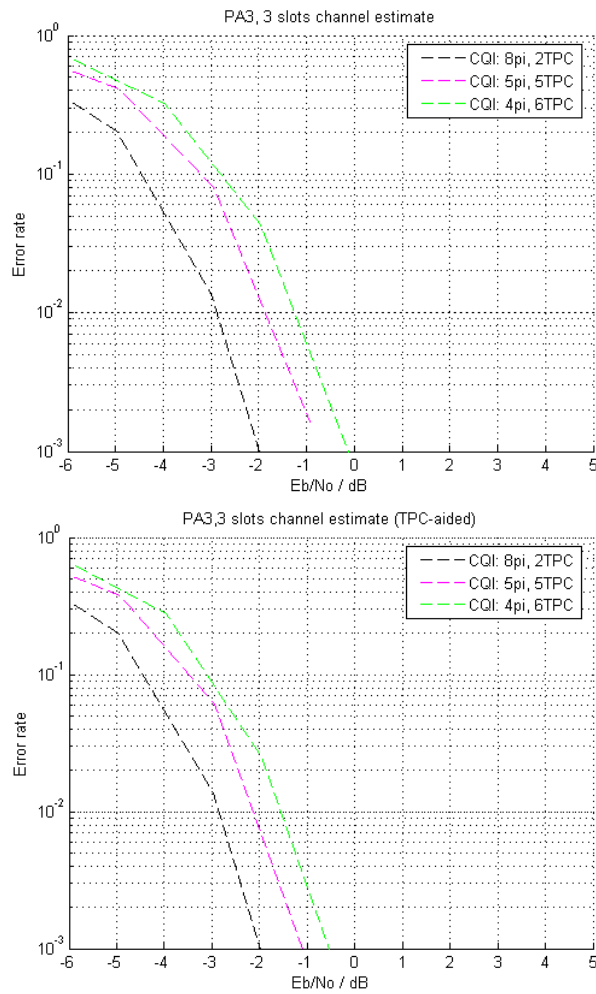

Figure 4.1.2.1-2: CQI performance in PA3, 3 slot channel estimation, with and without TPC-assistance

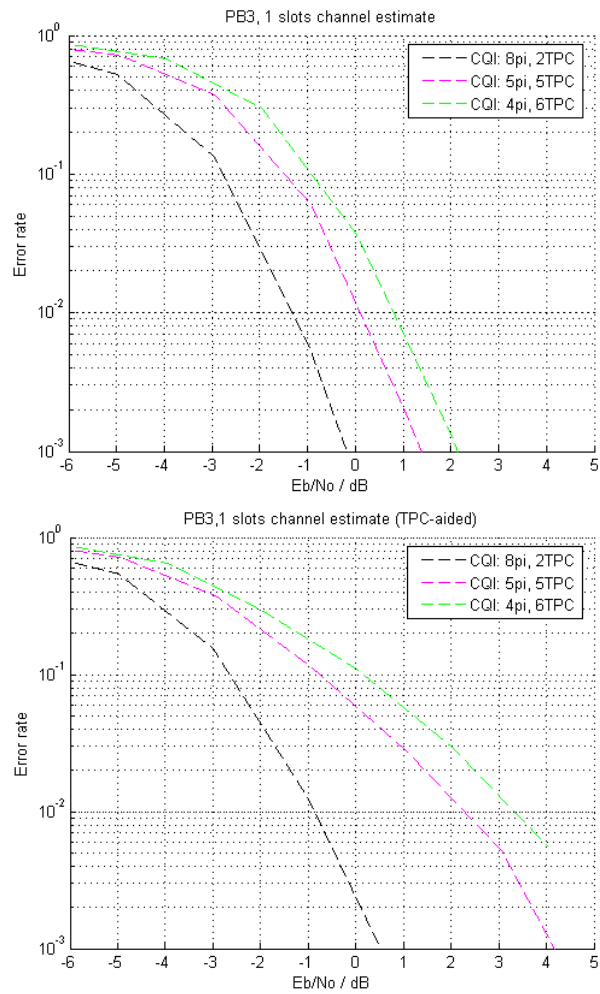

Figure 4.1.2.1-3: CQI performance in PB3, 1 slot channel estimation, with and without TPC-assistance

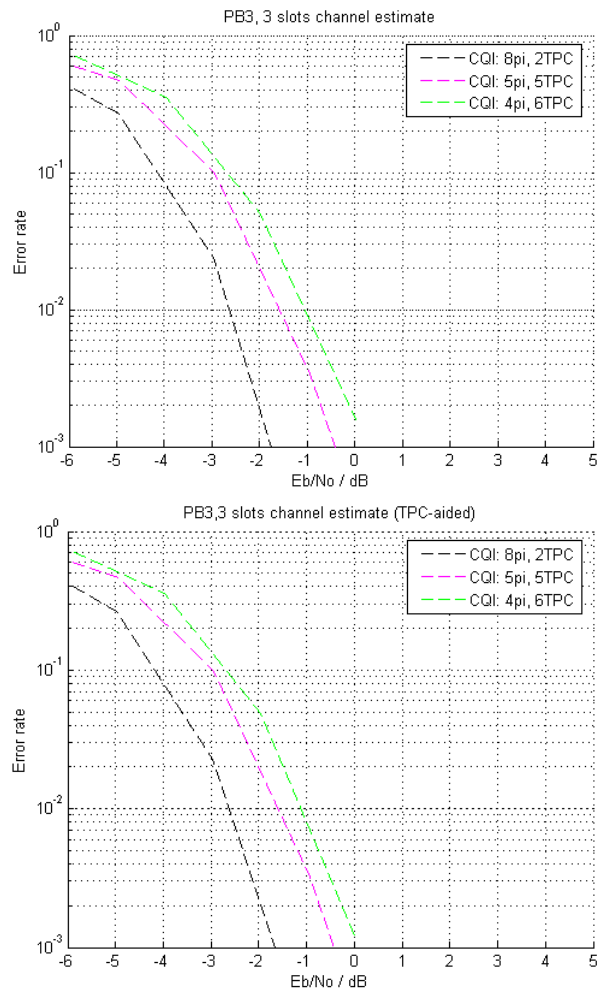

Figure 4.1.2.1-4: CQI performance in PB3, 3 slot channel estimation, with and without TPC-assistance

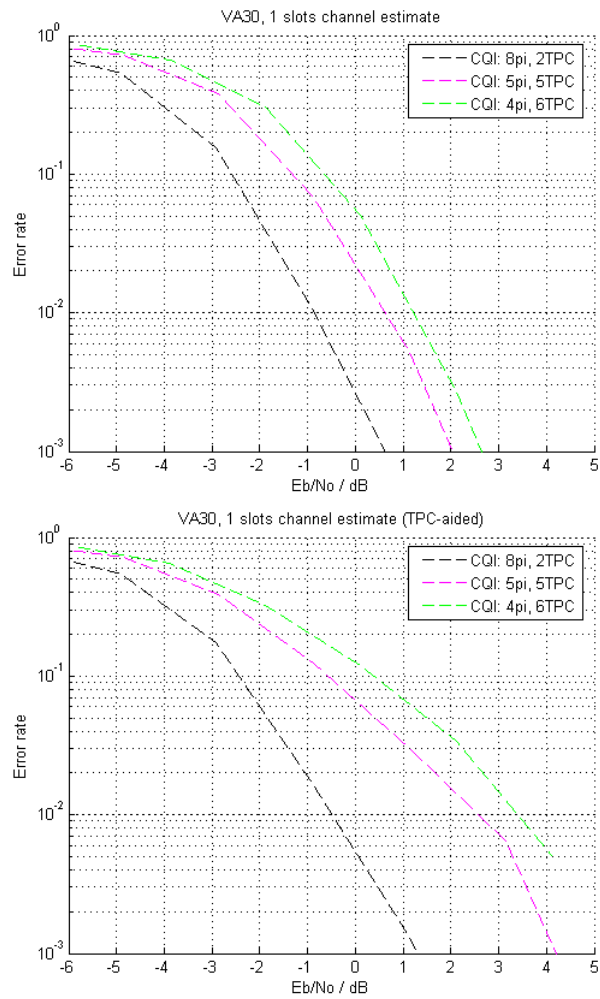

Figure 4.1.2.2.1-5: CQI performance in VA30, 1 slot channel estimation, with and without TPC-assistance



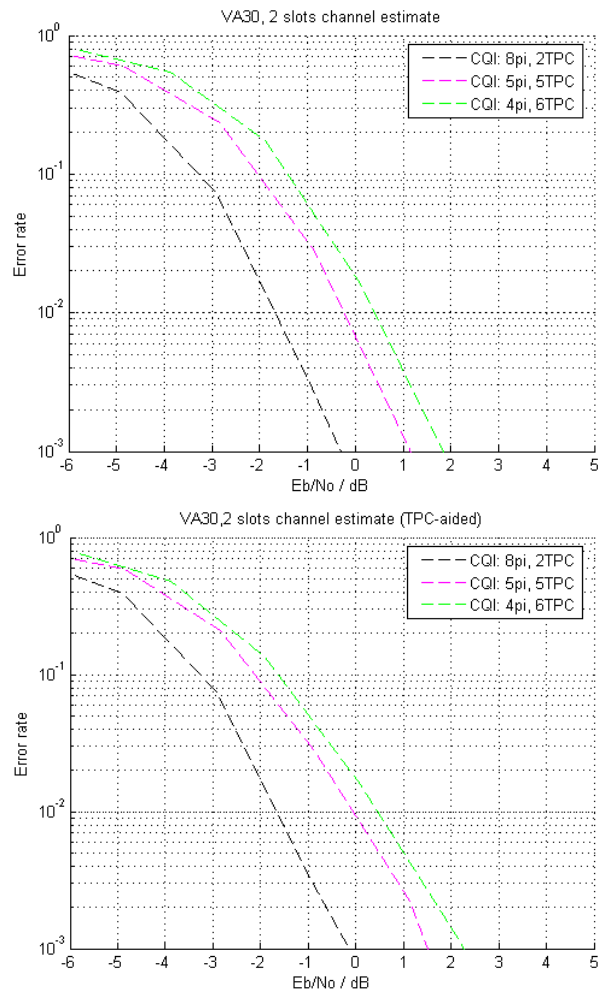

Figure 4.1.2.1-6: CQI performance in VA30, 2 slot channel estimation, with and without TPC-assistance

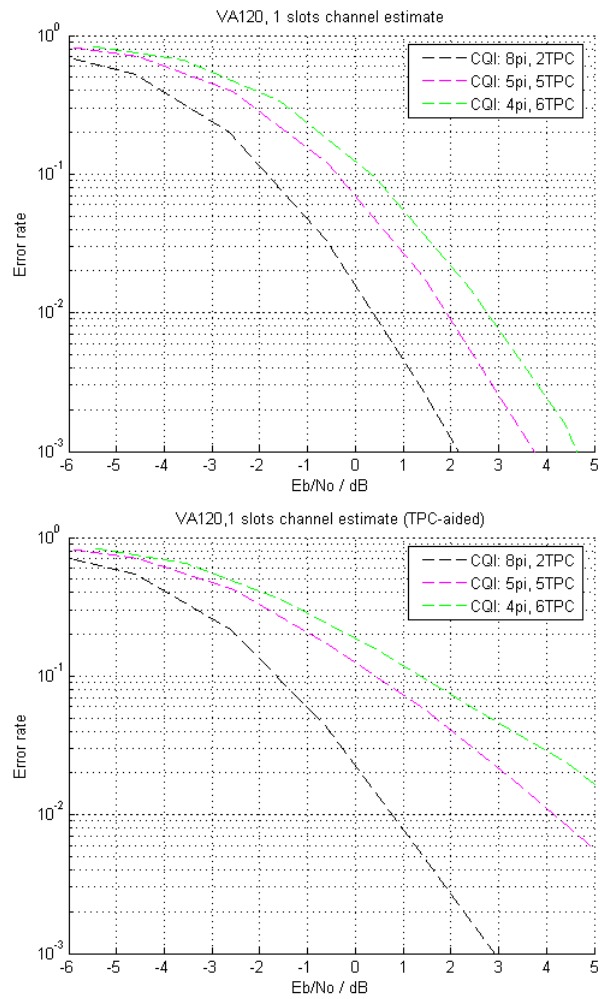

Figure 4.1.2.2.1-7: CQI performance in VA120, 1 slot channel estimation, with and without TPC-assistance

4.1.2.2.2 HARQ-ACK transmission

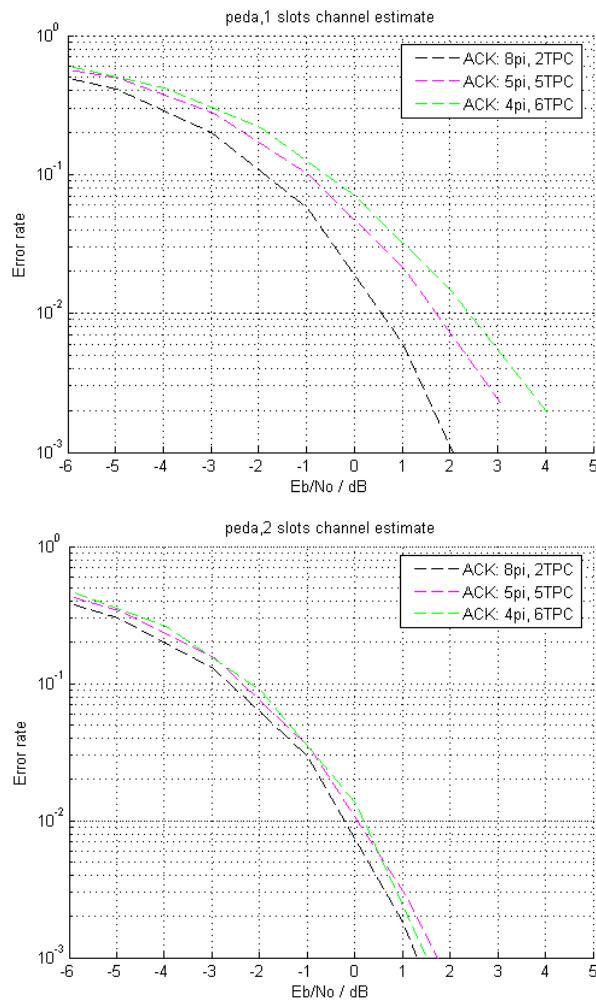

Figure 4.1.2.2.2-1: ACK performance in PA3, 1 and 2 slot channel estimation, with TPC-assistance

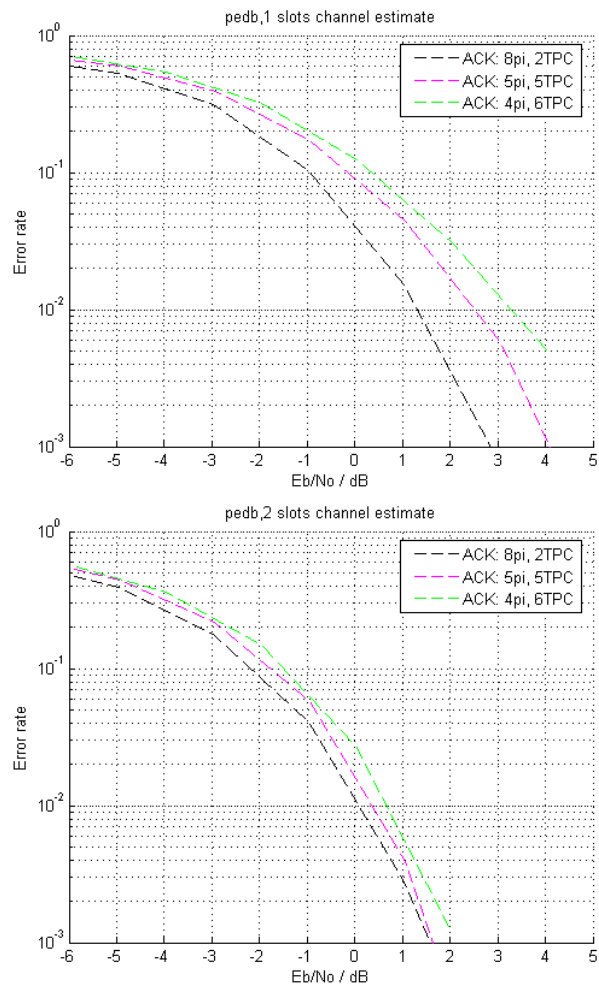
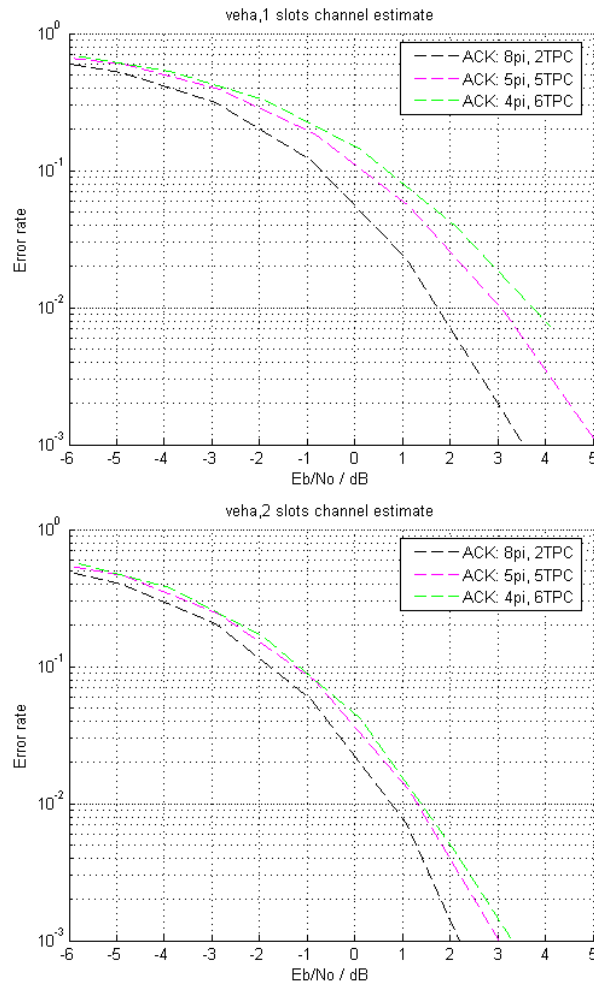
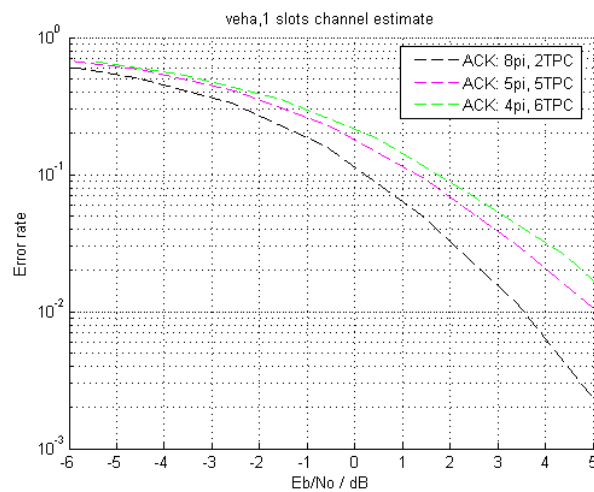

Figure 4.1.2.2-2: ACK performance in PB3, 1 and 2 slot channel estimation, both with TPC-assistance



**Figure 4.1.2.2-3: ACK performance in VA30, 1 and 2 slot channel estimation, both with TPC-assistance**



**Figure 4.1.2.2-4: ACK performance in VA120, 1 slot channel estimation, with TPC-assistance**

The E-DCH and HS-DPCCH performance was also simulated with the simulation parameters listed in Table 4.1.2.1-1. The results are shown in Figures 4.1.2.2-5, 4.1.2.2-6 and 4.1.2.2-7.

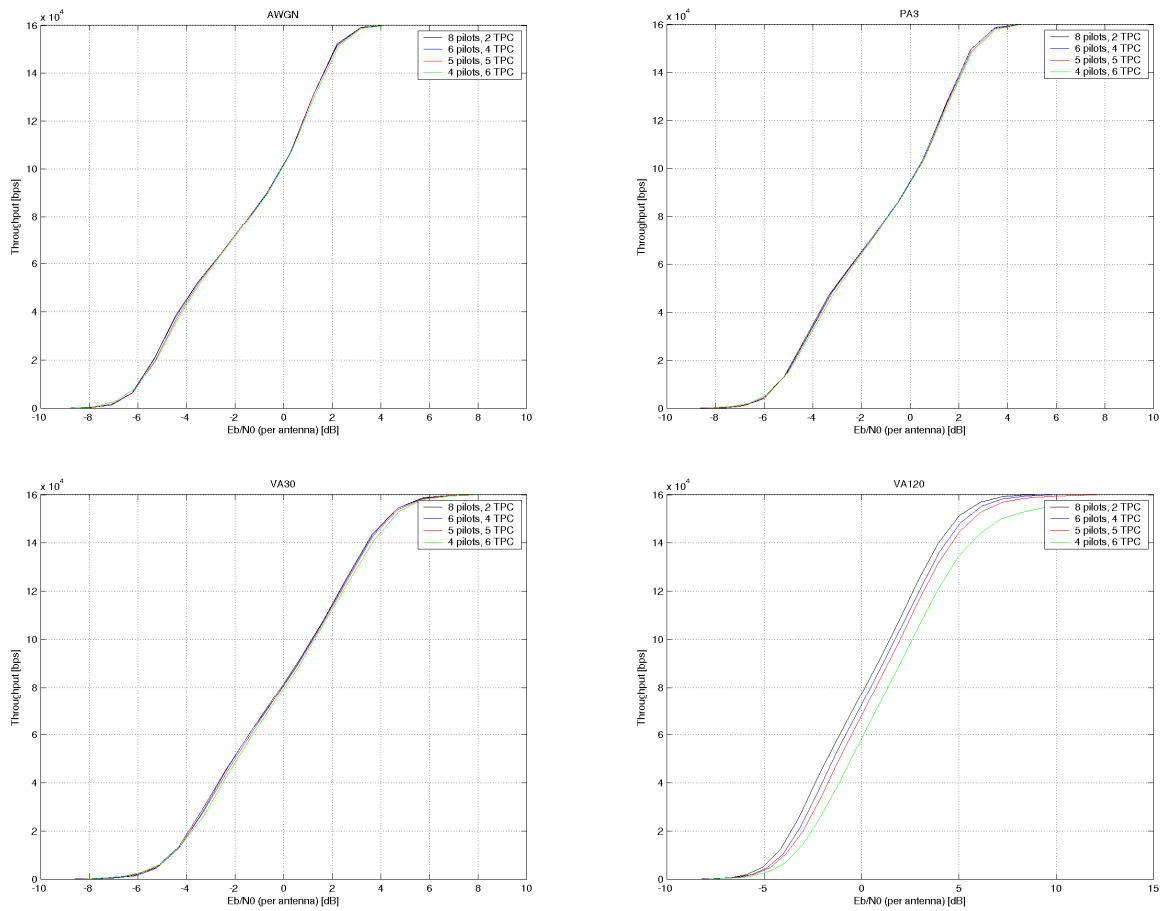

Figure 4.1.2.2-5: Throughput for different UL DPCCH slot formats and various channel models

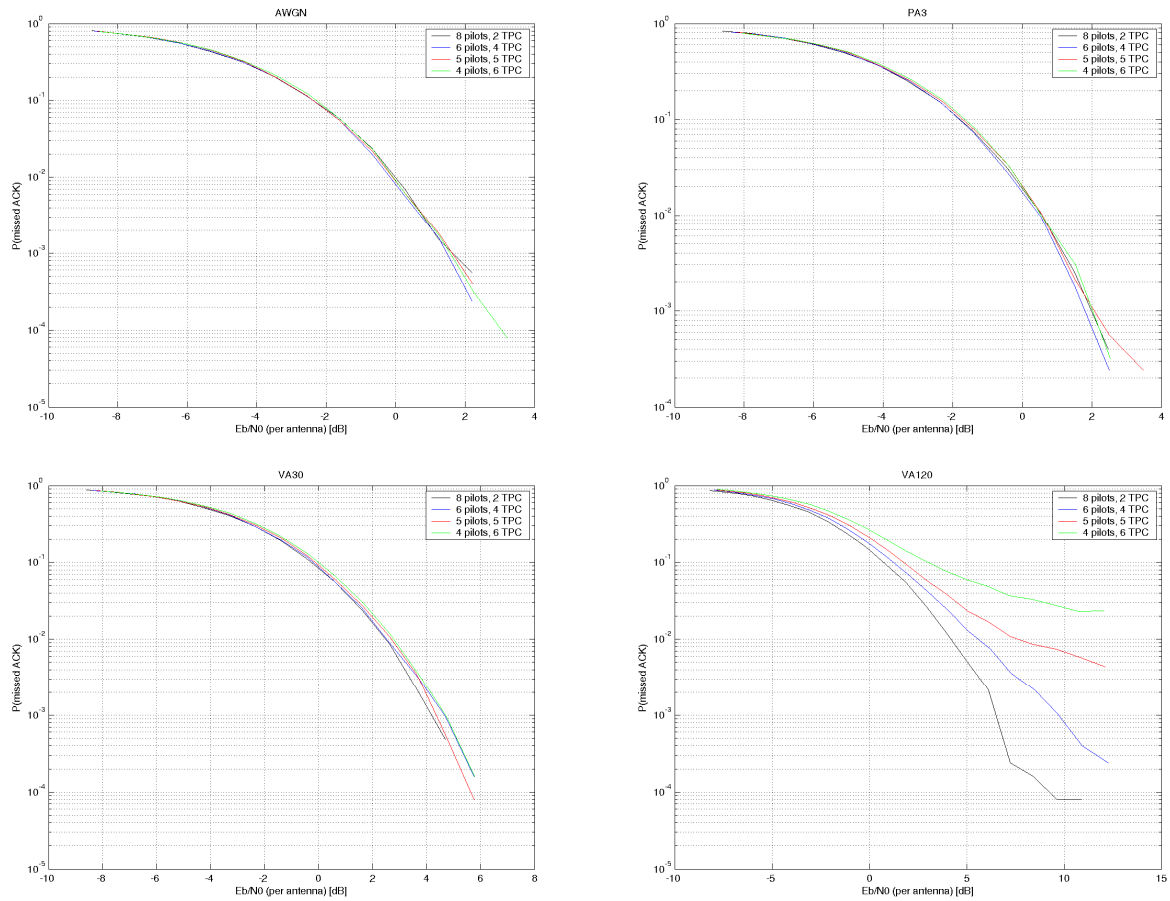
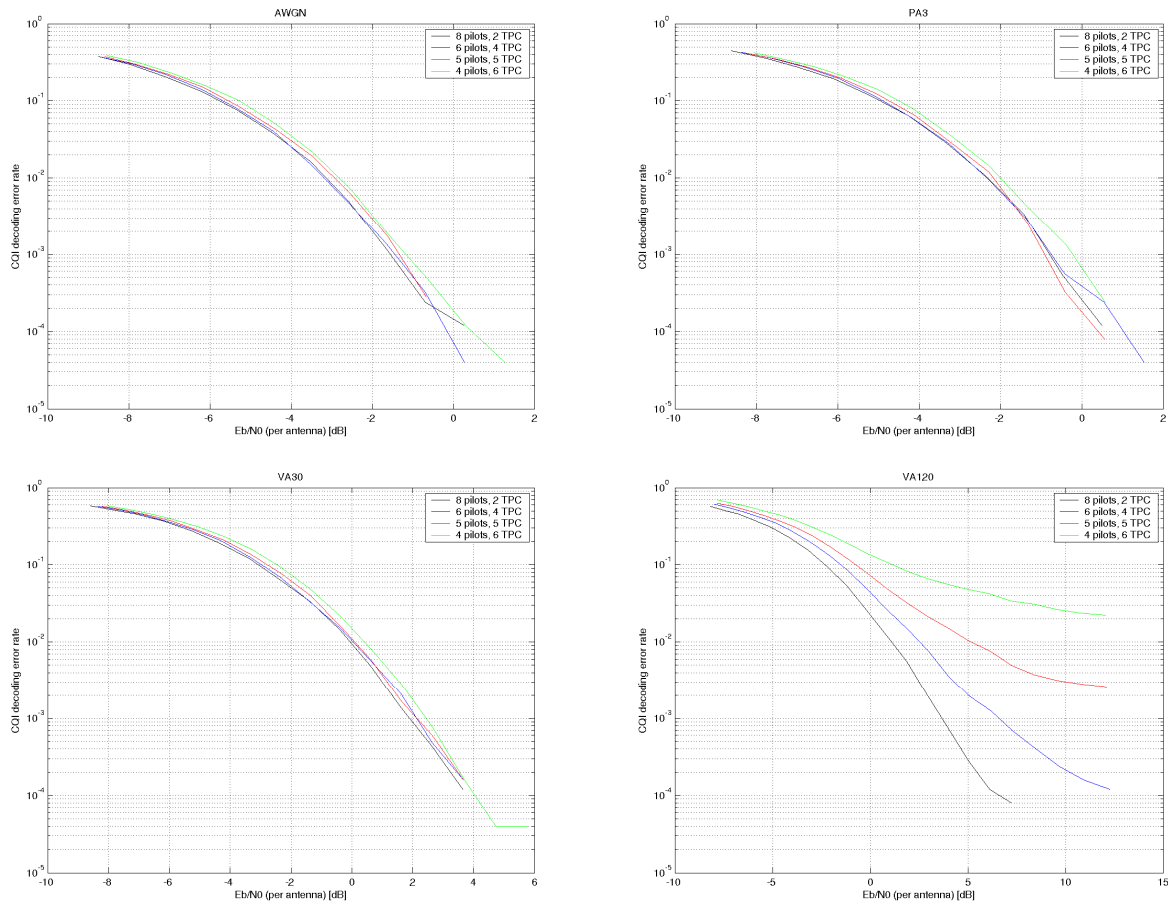

Figure 4.1.2.2-6: Probability of missed ACK for different UL DPCCH slot formats and various channel models



**Figure 4.1.2.2.2-7: CQI decoding error rate for different UL DPCCH slot formats and various channel models**

#### 4.1.2.2.3 Observations from simulations of HS-DPCCH performance in sub-clauses 4.1.2.2.1 and 4.1.2.2.2

From the simulation results presented above, it is observed that:

1. If a new DPCCH slot format with fewer pilot bits is used during HS-DPCCH transmissions, there is degradation in HS-DPCCH performance for CQI (typically around 2dB).
2. The degradation in HS-DPCCH performance can be reduced slightly by using TPC-aided channel estimation, but only if the channel is sufficiently static for the channel estimate to be averaged over a few slots. When the coherence time of the channel is shorter, so that the channel estimate has to be derived from only 1 slot, use of TPC-aiding for the channel estimation further degrades the HS-DPCCH performance.
3. When using TPC-aided channel estimation, the ACK error rate degradation from DPCCH slot formats with more TPC bits is smaller than for CQI.
4. The degradation in ACK error rate is larger for a new slot format with 4 pilot bits than for a new slot format with 5 pilot bits.
5. In terms of throughput, a new slot format with fewer pilot bits but more TPC bits gives similar performance as slot format 1. However, for VA120, slot format 1 performs better, but a slot format with 6 pilot bits and 4 TPC bits performs decently also for VA120.



### 4.1.2.3 Conclusions from TPC performance (sub-clause 4.1.2.1) and HS-DPCCH performance (sub-clause 4.1.2.2)

In the light of the observed performance of TPC and HS-DPCCH, the following behaviour could be useful:

- A new slot format is configured by RRC signalling in the same way as Rel-99 slot formats;
- The new slot format uses 5 pilot bits and 5 TPC bits;
- In DPCCH slots that overlap a CQI transmission, the slot format switches dynamically to format 1 (8 pilots + 2 TPC) in order to avoid degrading the HS-DSCH performance.
- Note that the Serving Node B knows exactly when to expect transmissions on the HS-DPCCH, so with this proposal there is no need for the Serving Node B to blind-detect the change of DPCCH slot format.
- In other DPCCH slots, including those where E-DCH is transmitted (unless HS-DPCCH is also transmitted), the new slot format continues to be used. (As the Node B does not have full knowledge of when E-DCH will be transmitted, keeping the slot format the same avoids any need for blind detection of the DPCCH slot format at the Node B).
- In slots where E-DCH is transmitted, the UE can apply a DPCCH power offset if more pilot energy is needed. As the E-DPDCH transmission power will typically be considerably greater than the HS-DPCCH transmission power, the relative impact on total power of increasing the DPCCH power would be smaller in this case.
- Alternatively, if it were to be decided that the new slot format should be semi-static (“Proposal B” in sub-clause 4.1.1.2), the new slot format would need more than 5 pilot bits in order to reduce the degradation to CQI transmission.

### 4.1.2.4 Power control delay

Assuming that the downlink uses F-DPCH, the minimum loop delay for the uplink power control is 1 slot, while the minimum loop delay for the downlink power control is 2 slots. This is shown in Figure 4.1.2.4-1.

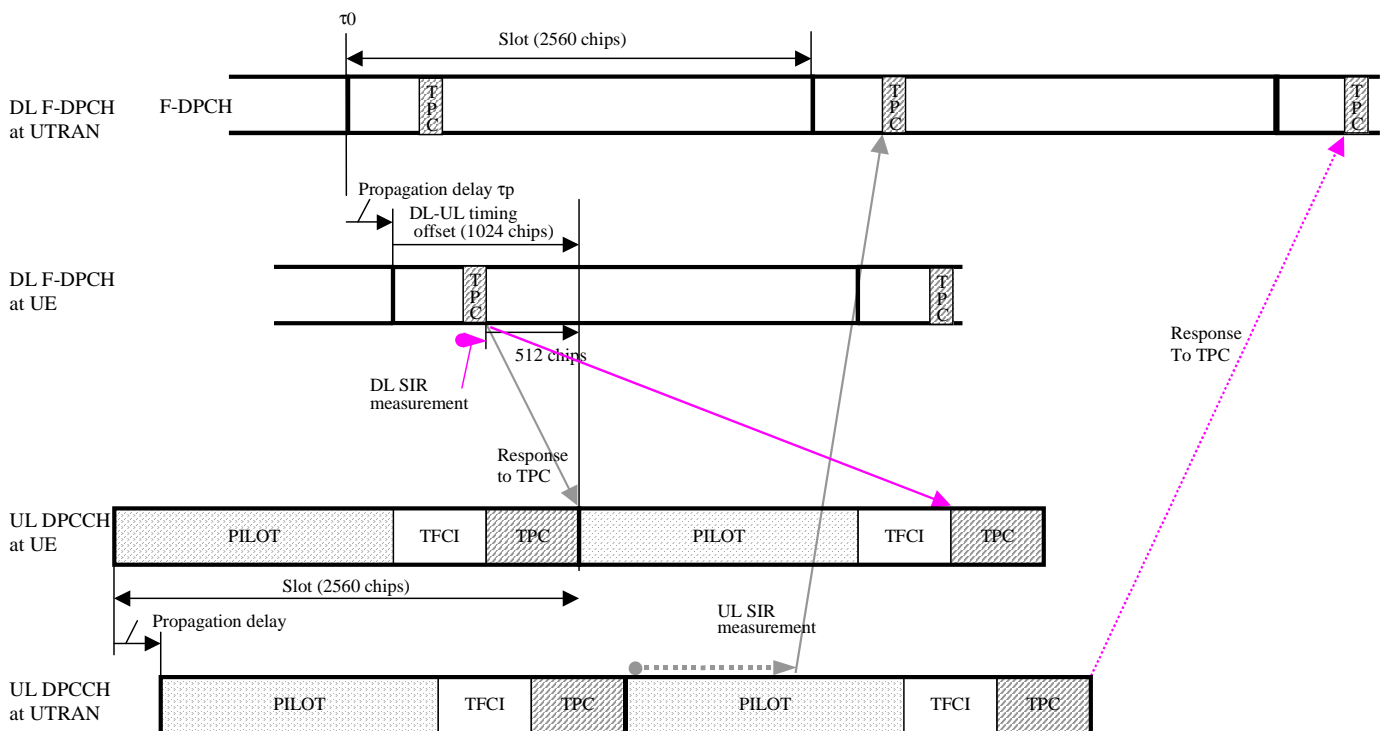

**Figure 4.1.2.4-1: Power control loop delays with normal F-DPCH operation**

The power control loop delays with any of the new UL DPCCH slot formats proposed above are the same as with normal F-DPCH operation. Figure 4.1.2.4-2 shows an example for a slot format with 4 pilot bits and 6 TPC bits.

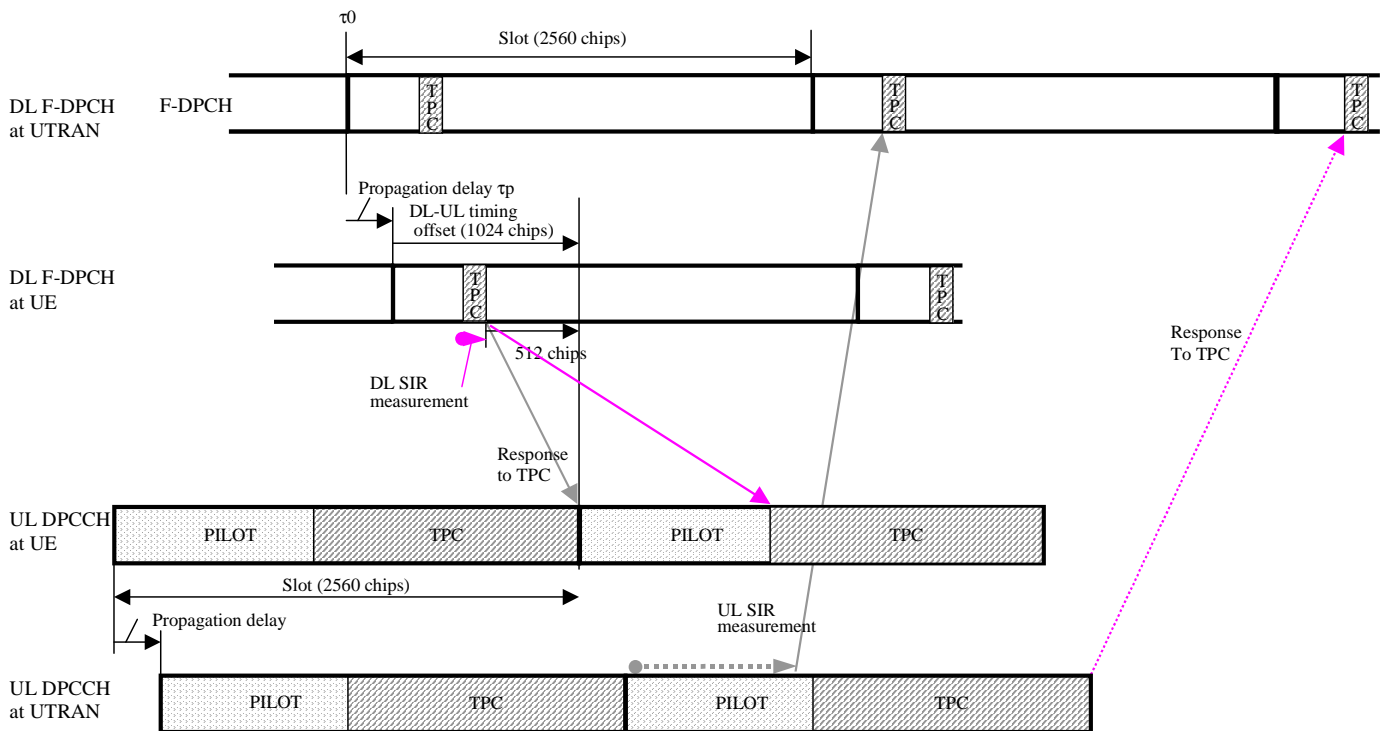

Figure 4.1.2.4-2: Example of power control loop delays with new UL DPCCH slot format

### 4.1.3 Benefits of the concept

The concept “New UL DPCCH slot format” could be combined with the concept “SIR\_target lowering & CQI off” as well as with the concept of “UL DPCCH gating”.

- For a given TPC reliability the required DPCCH power would be reduced by around 2-4dB compared to existing UL DPCCH slot formats, thus reducing UL DPCCH noise contribution and also increasing UE battery life time compared to REL-6.
- Compared to REL-6: Increased number of temporarily inactive users that can stay in CELL\_DCH and that can therefore get active in a very short time avoiding frequent transitions to CELL\_FACH.
- There is no impact on TPC loop delay.

### 4.1.4 Open issues of the concept

- Suitable mechanisms (e.g. triggers and/or signalling) for changing the slot format? (considering how frequently it may be beneficial to change the slot format.)
- The use of the new slot format in soft handover needs to be investigated.

## 4.2 Uplink DPCCH gating

### 4.2.1 Description of the concept

The Uplink DPCCH Gating concept applies to a HSDPA/HSUPA scenario only, with no DCHs configured in either direction. The uplink TPC commands sent in the downlink are assumed to be carried over F-DPCH, but one could use associated DPCCH as well.

### 4.2.1.1 General principle

The optimal solution for reducing DPCCH overhead of packet data users is turning off the DPCCH transmission when no data or HS-DPCCH is being transmitted. With such an ideal solution the idle packet data users would not consume any uplink air interface resources and the network resource allocation would set the limit on how many idle users could be kept in the CELL\_DCH state. Due to practical reasons there may be a limit on the length of the DPCCH gating period as during long inactivity the Node B could not any more know whether the uplink synchronisation is lost or if there just is a very long inactivity period.

In order to support longer uplink DPCCH gating gaps, the transmission after a gap is proposed to be preceded by a DPCCH preamble of sufficient length in order to facilitate the detection of the signal. Also, in order to save Node B receiver resources, DRX in the uplink is proposed to be allowed during the uplink DPCCH gating gaps.

The basic principle in short is that if there is neither E-DCH nor HS-DPCCH transmission, the UE automatically stops the continuous DPCCH transmission and applies a known DPCCH activity (DPCCH on/off) pattern. When an E-DCH or HS-DPCCH transmission takes place also the DPCCH is transmitted regardless of the activity pattern.

I.e. during the E-DCH and HS-DPCCH inactivity the UE would activate a known DPCCH transmission pattern that would be e.g. a few DPCCH slots transmitted every few radio frames and no DPCCH transmission during other times. If E-DCH or HS-DPCCH is transmitted the DPCCH would be transmitted normally regardless of the pattern. Depending on the length of the DPCCH transmission gap, a DPCCH power control preamble of few slots may be needed before E-DCH/HS-DPCCH transmission may start. Reception of the downlink HS-SCCH/HS-PDSCH would be active and possible at all times. During the periods when UL DPCCH is not transmitted, Node B will not be able to perform UL SIR estimation and has no information on which to base the UL TPC commands sent on F-DPCH. Therefore the F-DPCH should also be gated during the periods of UL DPCCH gating.

### 4.2.1.2 Basic packet traffic example

Figure 4.2.1.2-1 depicts the basic idea, where during data traffic activity (e.g. web page is being transmitted in the downlink and TCP acknowledgements as well as HSDPA acknowledgements are transmitted in the uplink) everything operates as with Release 6 specifications. When the data traffic stops the continuous DPCCH transmission in the uplink is shut down too. Occasionally during the data inactivity the DPCCH is transmitted in a predetermined pattern so that the Node B always knows to expect some slots of DPCCH transmission and can still follow the uplink presence and quality.

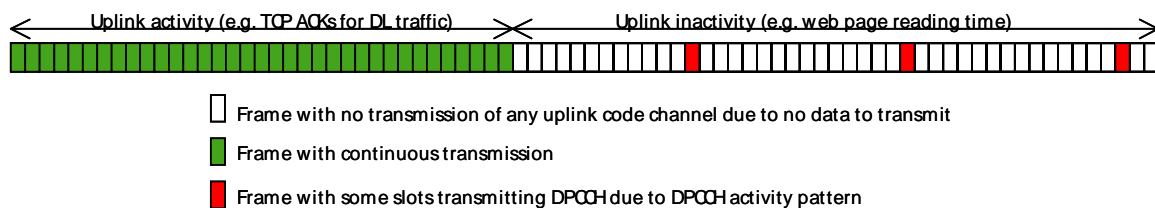

**Figure 4.2.1.2-1: Uplink DPCCH transmission with gating**

Whenever the uplink has anything to transmit on E-DCH or HS-DPCCH the DPCCH transmission will be automatically reinitiated.

More generally, during any packet session with any packet activity/inactivity ratio, when the user is transmitting data in the uplink, the DPCCH is continuously active as long as the data or HS-DPCCH transmission is taking place and during the 'reading time', when the uplink is inactive, the DPCCH gating pattern would be applied reducing the consumed uplink capacity to a fraction compared to continuous DPCCH. In addition to reduced uplink capacity consumption the UE talk times would be increased due to lowered battery consumption.

The actual savings would be heavily depending on the activity factor of the uplink transmission as well as the time before dropping inactive users from CELL\_DCH.

### 4.2.1.3 VoIP traffic example

With VoIP it would be possible also to benefit from the fact that the data transmission timing even during the active phase of VoIP would be known and could be matched with DPCCH gating period. During the active speech phase the

UE would transmit the VoIP packet transmissions and retransmissions with DPCCH and between the packets DPCCH would not be transmitted either.

**Example: Gated DPCCH**  
**3 slots on, 45 off**  
**Transmitted always**

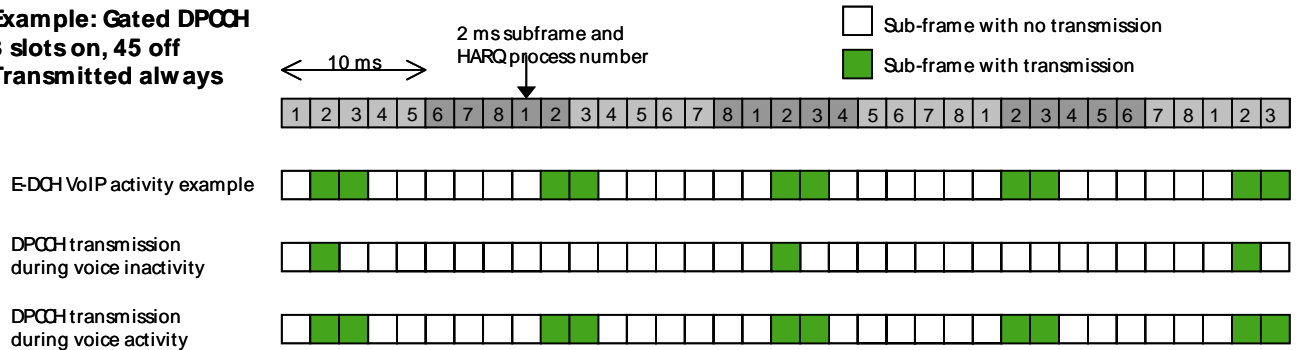

**Figure 4.2.1.3-1: DPCCH transmission with gating & 2 ms E-DCH TTI. HS-DPCCH impact not shown**

In Figure 4.2.1.3-1 an example DPCCH gating with 2 ms E-DCH TTI and VoIP traffic (with average transmission rate of 2.5 transmission per packet) mapped to HARQ processes 1 and 2 is shown with DPCCH activity pattern during E-DCH inactivity as 2 ms burst every 32 ms. Note that this is a simplified example; the transmissions and retransmissions do not need to follow this regular pattern in order to get the desired benefits from the DPCCH gating. With such parametrisation the DPCCH overhead would be reduced to ~6% during voice inactivity and to ~25% during voice activity. Assuming 50% voice activity the DPCCH overhead would be reduced to ~16% of the overhead from continuous DPCCH. HS-DPCCH activity and possible power control preambles would reduce the actual gains, but with good parametrisation and possible improvements to CQI reporting, the impact of HS-DPCCH is not dominant.

**Example: Gated DPCCH**  
**3 slots on, 27 off**  
**Transmitted always**

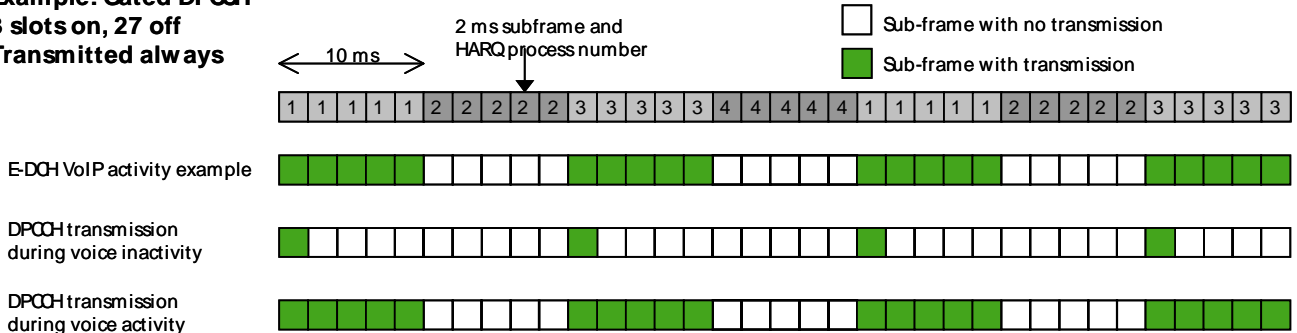

**Figure 4.2.1.3-2: DPCCH transmission with gating & 10 ms E-DCH TTI. HS-DPCCH impact not shown**

In Figure 4.2.1.3-2 an example DPCCH gating with 10 ms E-DCH TTI and VoIP traffic (no retransmissions shown, low retransmission rate) mapped to HARQ processes 1 and 3 is shown with DPCCH activity pattern during E-DCH inactivity as 2 ms burst every 20 ms. With such parametrisation the DPCCH overhead would be reduced to 10% during voice inactivity and to ~50% during voice activity. Assuming 50% voice activity the DPCCH overhead would be reduced to ~30% of the overhead from continuous DPCCH. HS-DPCCH activity and potential power control preambles would reduce the actual gains.

**4.2.1.4 Operation of the uplink DPCCH gating**

**The role of the RNC**

The RNC would control the activation and deactivation of the Uplink DPCCH Gating feature the same way the RNC controls the Preamble/Postamble transmission for HSDPA ACK/NACK transmission. This is essential to guarantee the functionality in the SHO; gating can be used only if all Node B's in the active set support it. RNC should also decide what kind of gating parameters would be used, and signal the information to the Node B(s) and UE. If a Node B in the UE's active set does not support gating the RNC must disable the Uplink DPCCH Gating.

When the Uplink DPCCH Gating feature is enabled by the RNC the UE would transmit the DPCCH continuously when E-DCH or HS-DPCCH is transmitted and transmit the DPCCH discontinuously during the inactivity of E-DCH and HS-DPCCH according to parameters provided by the RNC.

### Criteria for transmitting the uplink DPCCH

The uplink DPCCH transmission would be resumed if at least one of the following criteria is fulfilled.

1. The DPCCH transmission pattern defines the time to transmit the DPCCH for synchronisation and power control purposes.
2. A HS-DPCCH transmission is triggered in the UE.
  - a. As in Release 5 the HS-SCCH triggers the need for HARQ ACK/NACK feedback on HS-DPCCH.
  - b. As in Release 5 the CQI reporting criteria triggers sending a CQI report on HS-DPCCH.
3. An E-DCH transmission is triggered in the UE as in Release 6.

It could be possible to align some or all the cases of 1,2,3 e.g. allow the E-DCH transmission to start only when the DPCCH transmission pattern would anyway activate the DPCCH transmission, or align the DPCCH transmission pattern's active phase and the CQI reporting.

### Criteria for stopping the uplink DPCCH transmission

The uplink DPCCH transmission would be turned off if all the following criteria are fulfilled.

1. The DPCCH transmission pattern defines when not to transmit the DPCCH if no other reason requires the DPCCH transmission.
2. The HS-SCCH has not triggered the need for HARQ ACK/NACK feedback on HS-DPCCH.
3. There is no immediate CQI report to be sent on HS-DPCCH.
4. There is no immediate E-DPCCH/E-DPDCH transmission taking place
5. There hasn't been any HS-DPCCH or E-DPCCH/E-DPDCH transmission in the last N slots. (N could be 0)

I.e. the uplink DPCCH is not transmitted if the DPCCH transmission pattern is not in the active phase and there is no need for HS-DPCCH and/or E-DPCCH/E-DPDCH transmission.

### Signalling between the UE and the Node B

The Node B to UE signalling is not necessarily required, but e.g. for purposes of controlling the CQI reporting or the timing when the UE may initiate the uplink E-DCH transmission, the Node B could use e.g. techniques described in chapters 4.3.1 and 4.4.1. As in Release 6, The E-AGCH and E-RGCH signalling can be used to control the UE's ability to transmit E-DCH.

The UE to Node B signalling is not necessarily required, but e.g. if the UE is allowed to send E-DCH TTIs whenever it likes, the presence of a DPCCH or a DPCCH preamble can be seen as an implicit signal indicating that an E-DCH transmission is taking place.

## 4.2.2 Analysis of the concept

### 4.2.2.1 Power control stability

**Table 4.2.2.1-1: Simulation parameters**

| Parameter          | Value                                               | Comment                                                                       |
|--------------------|-----------------------------------------------------|-------------------------------------------------------------------------------|
| Channel model      | Pedestrian A, 3 km/h<br>Vehicular A, 30 km/h        |                                                                               |
| Data rates         | 160 kbps (2ms TTI, SF8)<br>320 kbps (2 ms TTI, SF4) | 1 VoIP packet every 20ms<br>2 VoIP packets every 40 ms                        |
| E-DPDCH/DPCCH      | 8 dB                                                | $A_{ed} = 38/15$                                                              |
| E-DPCCH/DPCCH      | 0dB                                                 | $A_{ec} = 15/15$                                                              |
| Power Control      | ON (error: 4%)                                      | 1 dB step size                                                                |
| Channel Estimation | Ideal / realistic                                   | Ideal channel estimation used in order to isolate the impact to power control |
| Rx Antennas        | 2                                                   |                                                                               |
| $E_b/N_0$ dB       | E-DP <sub>x</sub> CH+DPCCH                          | Average over all antennas                                                     |
| HARQ               | Off / on                                            | When HARQ on, average number of transmissions ~2.2                            |
| Traffic model      | VoIP with 100% voice activity                       | 320 bits every 20 ms                                                          |

#### HARQ off, Ideal channel estimation

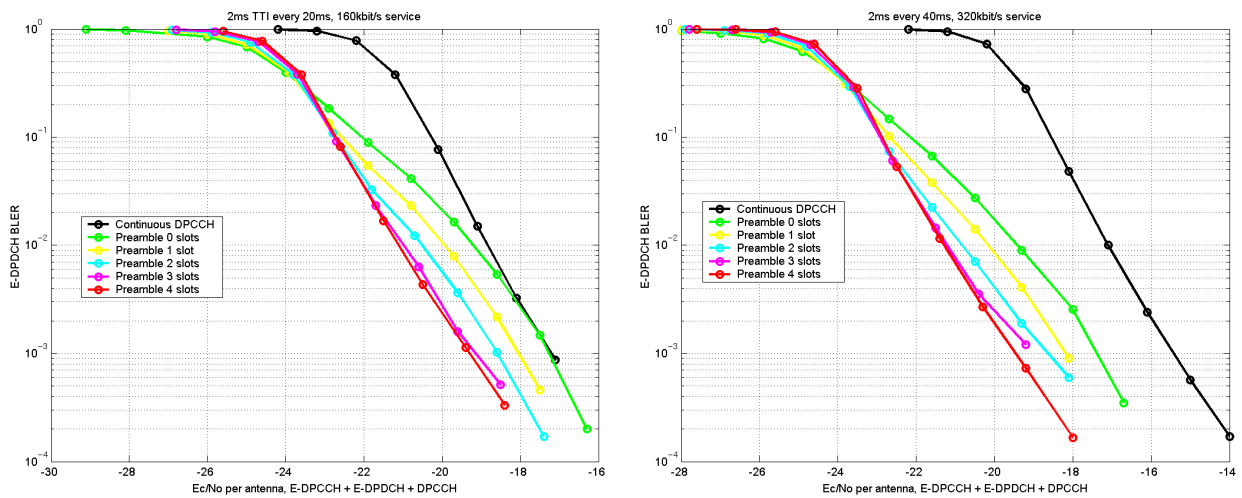

**Figure 4.2.2.1-1: BLER vs.  $E_c/N_0$  for different preamble lengths. Vehicular A, 30 km/h**

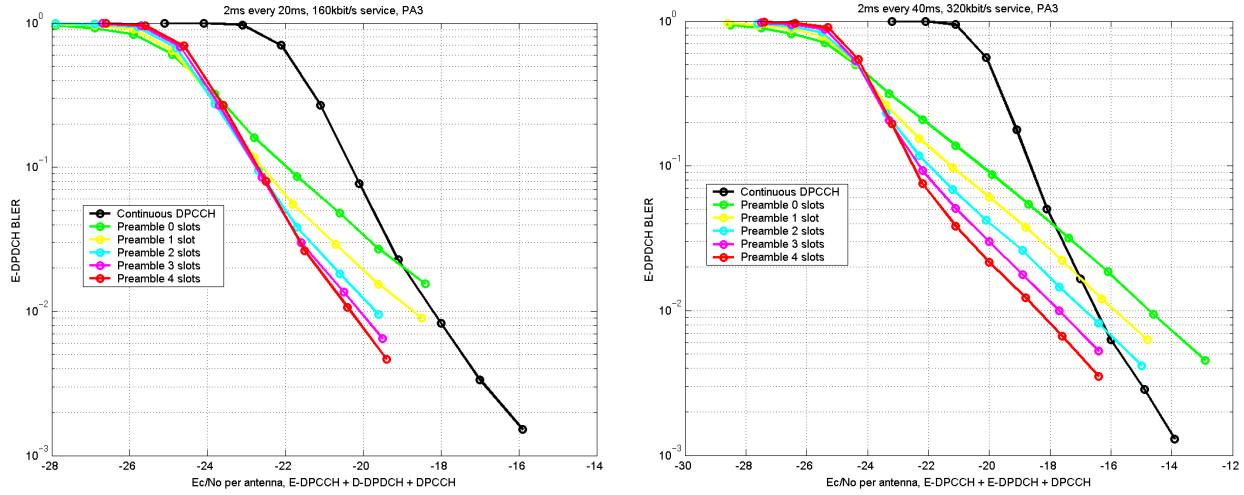

Figure 4.2.2.1-2: BLER vs. Ec/No for different preamble lengths. Pedestrian A, 3 km/h

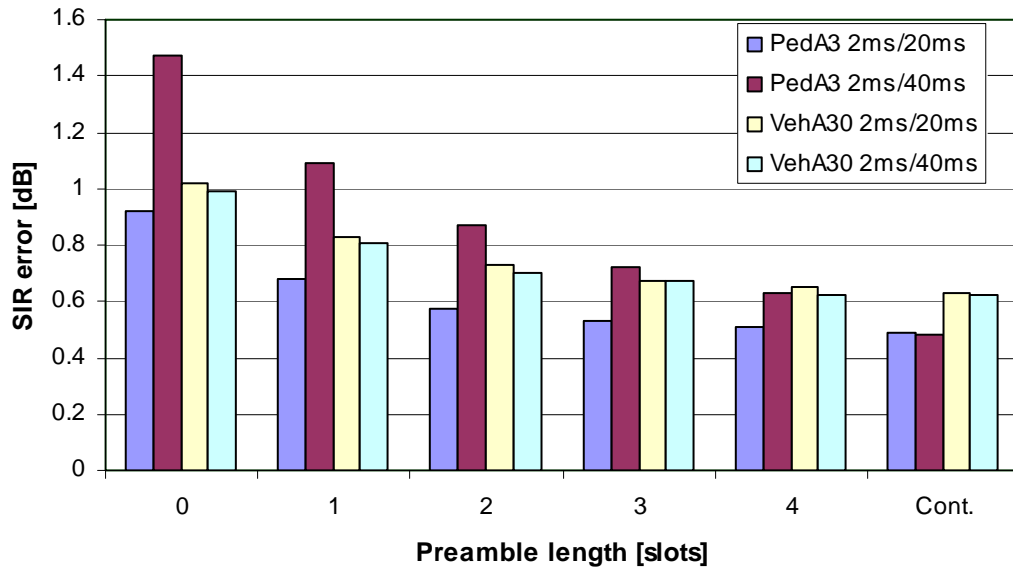
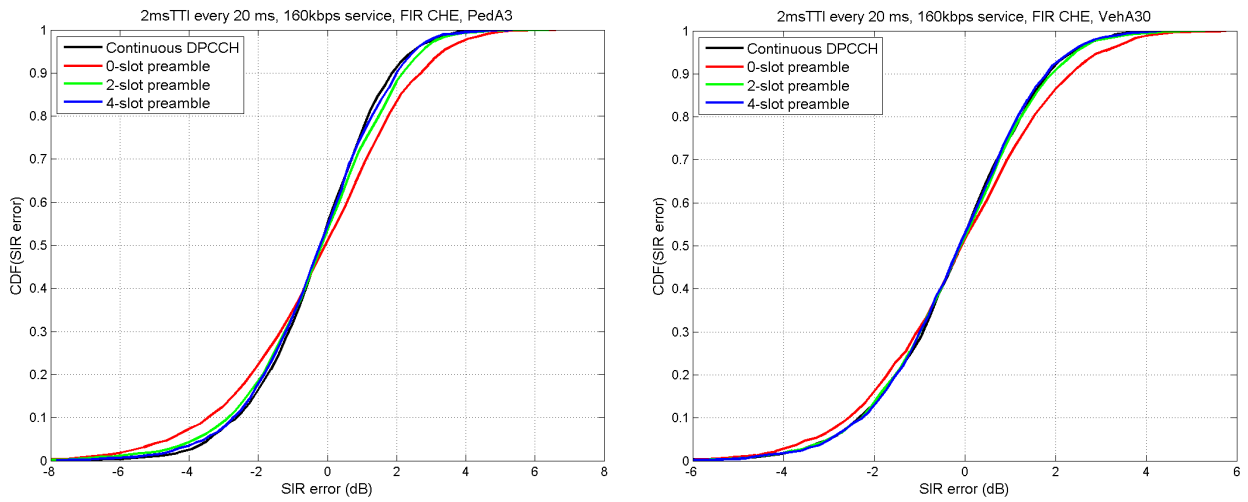

Figure 4.2.2.1-3: Average SIR error for different preamble lengths and for continuous DPCCH for one E-DCH transmitted every 20 and every 40 ms.

The SIR error in figure 4.2.2.1-3 was defined as  $SIR_{error} = |SIR_{target} - SIR_{received}|$  and calculated over those slots where E-DPCCH/E-DPDCH were transmitted.

**HARQ off, Realistic channel estimation**



**Figure 4.2.2.1-4: SIR error of the 1<sup>st</sup> E-DCH slot after the gap for different preamble lengths and for continuous DPCCH for one E-DCH TTI transmitted every 20 ms.**

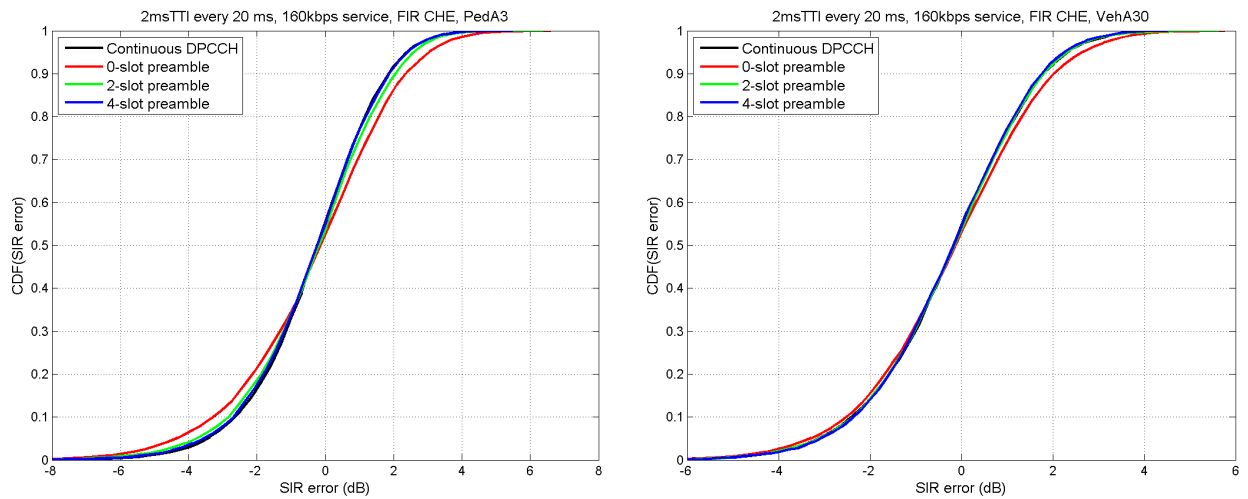

**Figure 4.2.2.1-5: SIR error over all E-DCH slots for different preamble lengths and for continuous DPCCH for one E-DCH TTI transmitted every 20 ms.**



**HARQ on, Realistic channel estimation**

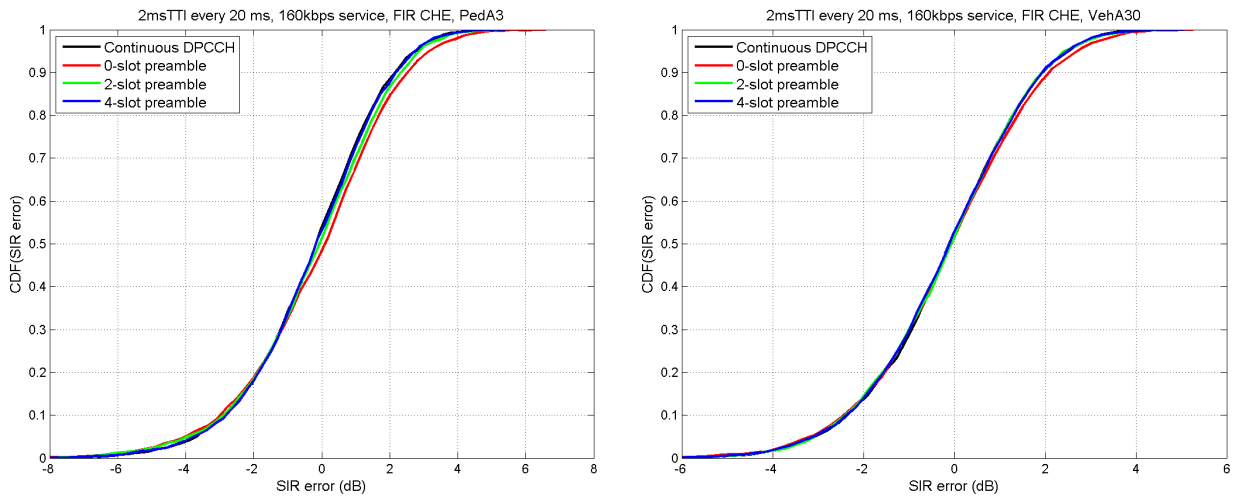

**Figure 4.2.2.1-6: SIR error of the 1<sup>st</sup> E-DCH slot after the gap for different preamble lengths and for continuous DPCCH for one E-DCH TTI transmitted every 20 ms with retransmissions**

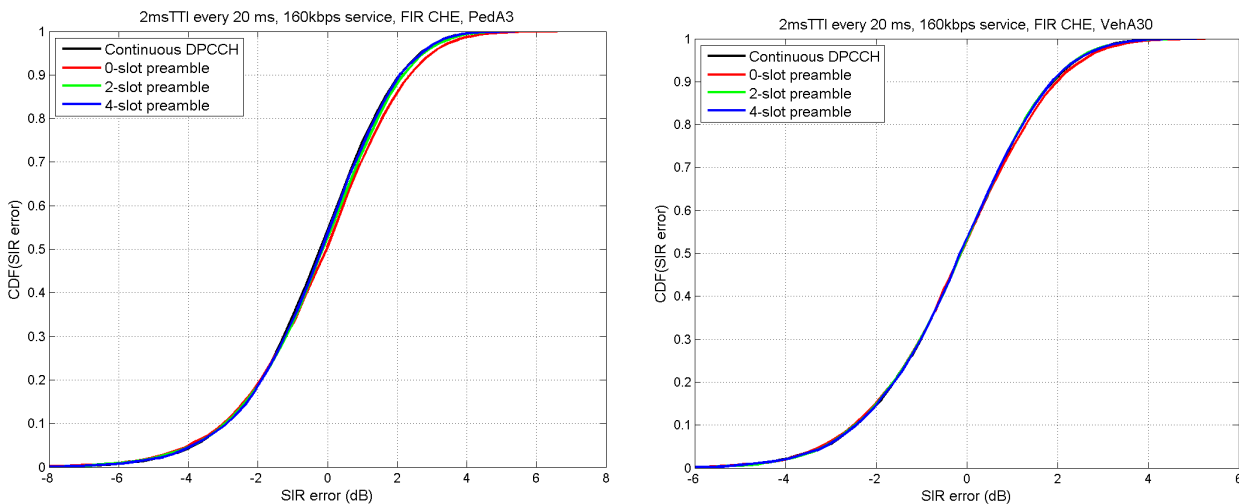

**Figure 4.2.2.1-7: SIR error over all E-DCH slots for different preamble lengths and for continuous DPCCH for one E-DCH TTI transmitted every 20 ms with retransmissions**

**4.2.2.2 F-DPCH performance**

Table 4.2.2.2-1 shows the assumptions used for F-DPCH simulations. In case of discontinuous uplink DPCCH transmission (UL DPCCH gating), the TPC commands are not transmitted in all UL slots. Thus, the closed loop power control operation is slower than in case of continuous UL DPCCH. In the simulations, the F-DPCH power has been kept unchanged during UL DPCCH transmission gaps (F-DPCH closed loop PC OFF periods) and updated normally during UL DPCCH transmission activity. The outer loop power control in UE is not run, i.e., SIR target is not updated, during the F-DPCH closed loop PC OFF periods.

**Table 4.2.2.2-1 Simulation assumptions**

| Parameter                                   | Explanation/Assumption                                   |
|---------------------------------------------|----------------------------------------------------------|
| Simulation length                           | 100 000 frames                                           |
| Closed loop Power Control                   | ON (when ON, also DL Outer Loop PC ON)                   |
| Uplink TPC error rate                       | 0%                                                       |
| PC step size                                | 1.0dB                                                    |
| PC additional upper limit                   | max -3.0 dB of total BS power (as specified in TS25.101) |
| Downlink Physical Channels and Power Levels | As specified in TS25.101                                 |
| Other L1 parameters                         | As Specified in latest L1 specifications.                |
| Channel estimation                          | Non perfect                                              |

The results for continuous UL DPCCH with power control, for both DPC\_MODE = 0 and DPC\_MODE = 1, and for UL DPCCH transmission pattern 3 slots UL DPCCH transmission (F-DPCH closed loop PC ON both DPC\_MODE = 0 and DPC\_MODE = 1), 27 slots UL DPCCH DTX (F-DPCH closed loop PC OFF) are shown in Figure 4.2.2.2-1 for pedestrian A 3km/h (G=3dB) and in Figure 4.2.2.2-2 for vehicular A 30km/h (G=3dB). The performance is the worst with fast (slot rate) power control: the slower the closed loop PC, the better the performance.

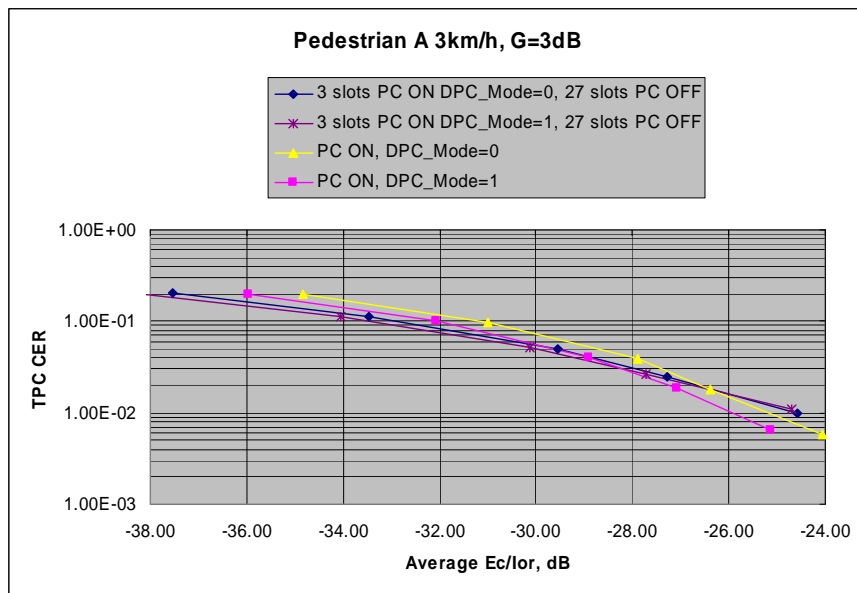

Figure 4.2.2.2-2 F-DPCH performance with different PC modes and discontinuous PC, pedestrian A 3km/h, G=3dB.

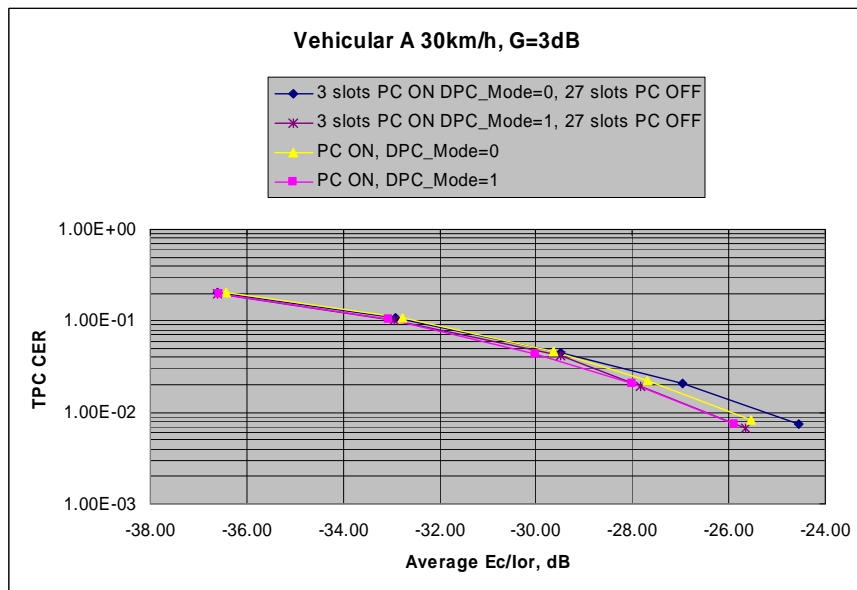

Figure 4.2.2.2-3 F-DPCH performance with different PC modes and discontinuous PC, vehicular A 30km/h, G=3dB.

The results with different UL DPCCH transmission patterns (3 slots UL DPCCH transmission & 27 slots UL DPCCH DTX, 3 slots UL DPCCH transmission & 57 slots UL DPCCH DTX, 6 slots UL DPCCH transmission & 24 slots UL DPCCH DTX, 6 slots UL DPCCH transmission & 54 slots UL DPCCH DTX) are shown in Figure 4.2.2.2-3 for pedestrian A 3km/h (G=3dB) and in Figure 4.2.2.2-4 for vehicular A 30km/h (G=3dB), DPC\_MODE=0. There are no significant differences in the F-DPCH performance with the different patterns. The performance with slowest power control (3 slots PC ON & 57 slots PC OFF pattern) is slightly better than with the other patterns and the performance with more power control (6 slots PC ON & 24 slots PC OFF pattern) is slightly worse than with the other patterns. Thus, the performance seems to be the better the slower the power control is (i.e., the lower the number of the power controlled slots compared to the number of not power controlled slots is).

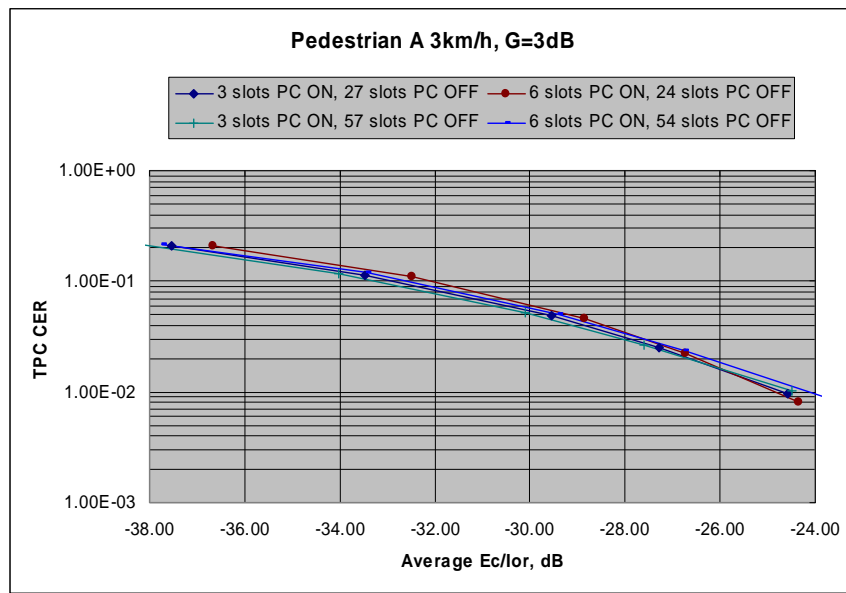

Figure 4.2.2.2-4 F-DPCH performance with different discontinuous PC patterns, pedestrian A 3km/h, G=3dB.

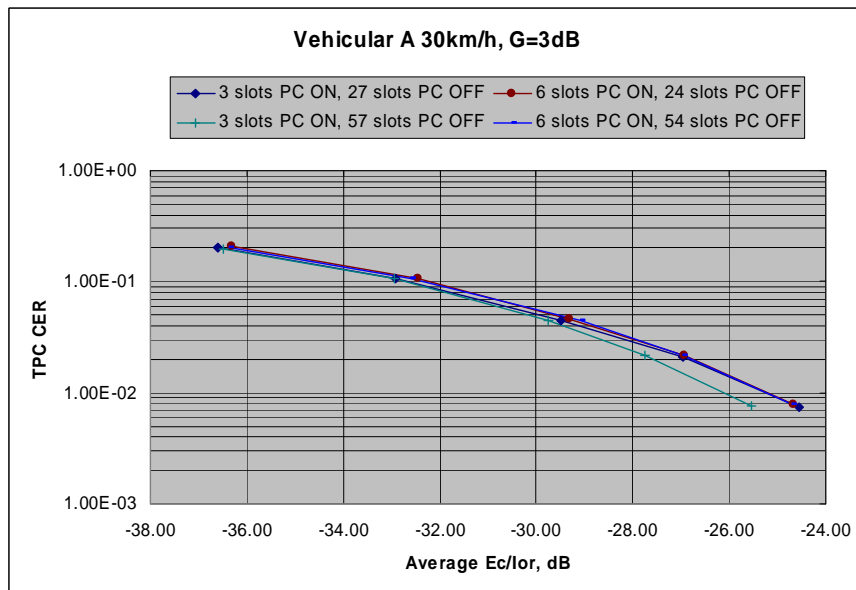

Figure 4.2.2.2-5 F-DPCH performance with different discontinuous PC patterns, vehicular A 30km/h, G=3dB.

It can be concluded from the results, that the F-DPCH performance would not be degraded due to the UL DPCCCH gating (relatively low transmit power required for reasonable TPC CERs) and that with discontinuous UL DPCCCH transmission (i.e., discontinuous F-DPCH power control) the UL DPCCCH transmission (F-DPCH power control ON/OFF) pattern has only minor impact on the performance (the performance seems to be slightly better for patterns with shorter PC ON periods).

4.2.2.3 Uplink link performance

Table 4.2.2.3-1: Simulation parameters

| Parameter          | Value                                                | Comment                                                 |
|--------------------|------------------------------------------------------|---------------------------------------------------------|
| Channel model      | Pedestrian A, 3 km/h<br>Vehicular A, 30 km/h         |                                                         |
| Data rates         | 160 kbps (2ms TTI, SF8)<br>64 kbps (10 ms TTI, SF16) | 1 VoIP packet every 20 ms<br>2 VoIP packets every 40 ms |
| E-DPDCH/DPCCH      | 8 dB                                                 |                                                         |
| E-DPCCH/DPCCH      | 0dB                                                  |                                                         |
| Power Control      | ON (error: 4%)                                       | 1 dB step size                                          |
| Channel Estimation | Realistic                                            |                                                         |
| Rx Antennas        | 2                                                    |                                                         |
| Eb/N0 dB           | E-DP <sub>x</sub> CH+DPCCH                           | Average over both antennas                              |
| HARQ               | On                                                   |                                                         |
| Traffic model      | VoIP with 100% voice activity                        | 320 bits every 20 ms / 640 bits every 40 ms             |

The results below simulate gated DPCCH with 0,1,2,3 and 4 slot preamble and with a continuous (R'6) DPCCH as a reference scenario.

Simulation results for 10 ms TTI and 64 kbps instantaneous data rate (two new VoIP packets transmitted every 40 ms).

Simulation results for 2 ms TTI and 160 kbps instantaneous data rate (a new VoIP packets transmitted every 20 ms).

Y-axis of the figures 4.2.2.3-1 and 4.2.2.3-3 correspond to the HARQ operating point indicating the throughput of an individual packet. Instantaneous data rate / throughput = average # of transmissions per packet.

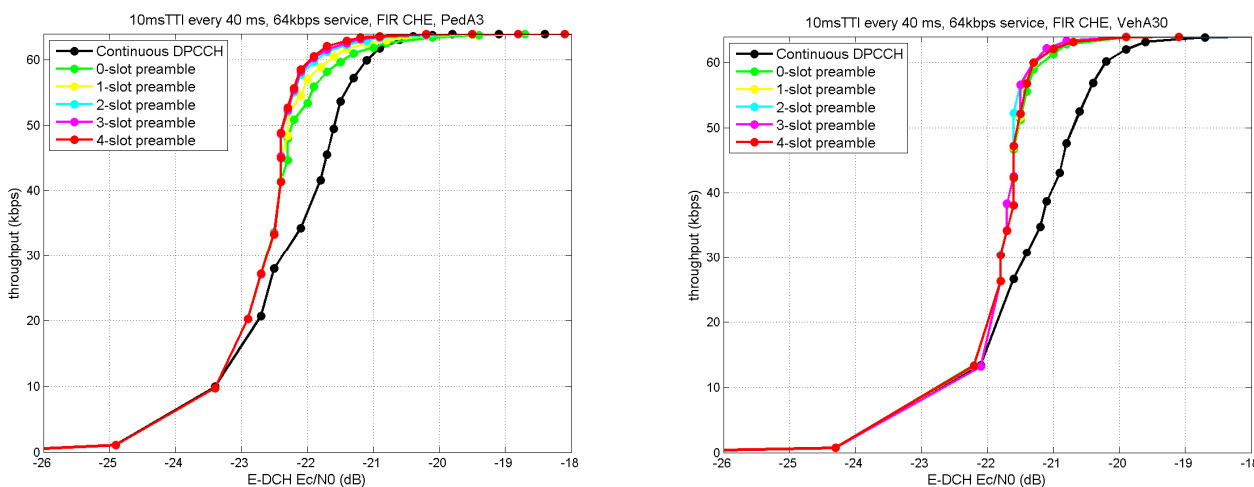

Figure 4.2.2.3-1: E-DCH performance with Gating, 10 ms TTI, 64 kbps instantaneous, 16 kbps average data rate

Y-axis of the figures above correspond to the HARQ operating point indicating the throughput of an individual packet. Instantaneous data rate / throughput = average # of transmissions per packet.

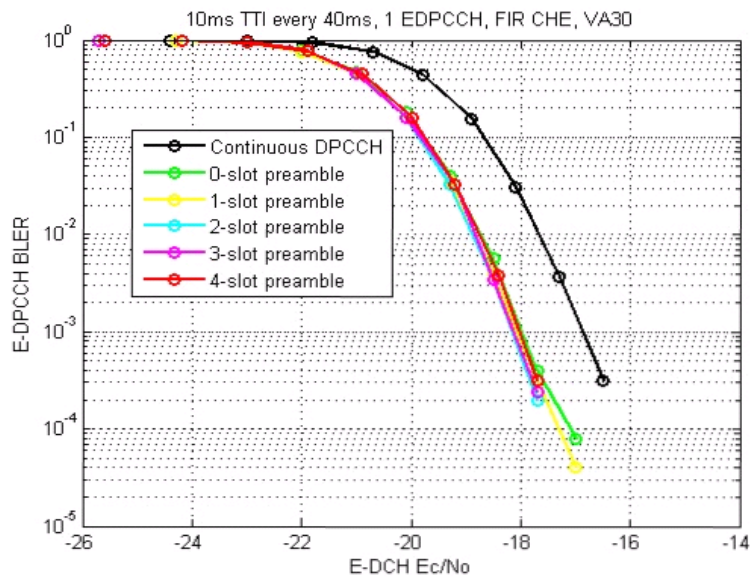

Figure 4.2.2.3-2: E-DPCCH performance with gating, 10 ms TTI transmitted every 40 ms, HARQ on.

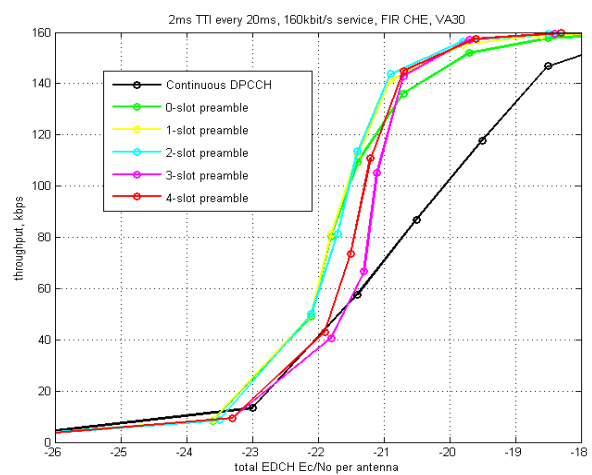
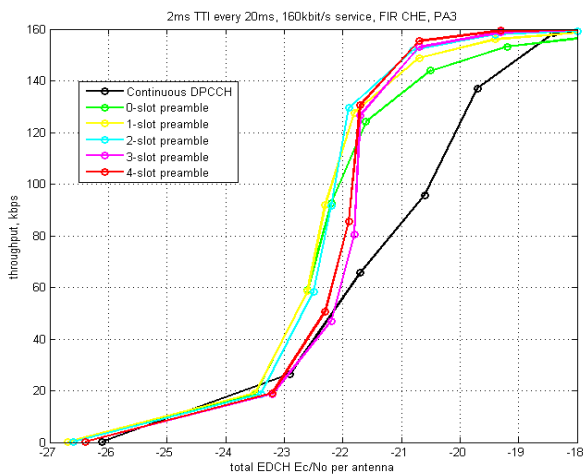

Figure 4.2.2.3-3: E-DCH performance with Gating, 2 ms TTI, 160 kbps instantaneous, 16 kbps average data rate

Y-axis of the figures above correspond to the HARQ operating point indicating the throughput of an individual packet. Instantaneous data rate / throughput = average # of transmissions per packet.

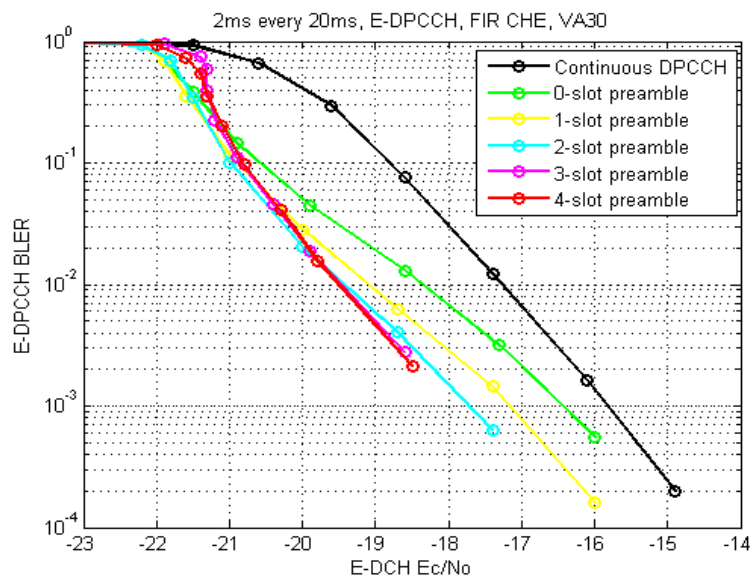

Figure 4.2.2.3-4: E-DPCCH performance with gating, 2 ms TTI transmitted every 20 ms, HARQ on.

#### 4.2.2.3.1 Additional link level results

This section goes over the link level impact of gating the DPCCH in the UL of UTRA over active and inactive data transfers. Results in this section further elaborate on the characterization of link level impact of DPCCH gating by assessing the demodulation performance with HARQ enabled, realistic channel estimation and with time-tracking (TTL) as well as frequency-tracking loops (FTL).

Incorporating the TTL and FTL into the simulations gives a clearer indication on whether or not synchronization issues may appear from the gating of the UL DPCCH.

##### 4.2.2.3.1.1 Simulation assumptions

- **Channel estimation:** Realistic. Non-causal FIR filter over 4 slots: same channel estimation used for non-gated DPCCH simulations as well as DPCCH gated simulations.
- **Time Tracking:** 1<sup>st</sup> order loop. Same loop gain for DPCCH non-gated simulations as well as DPCCH gated simulations. The time tracking loop in the simulations for inactive data periods takes into consideration the code Doppler to assess any synchronization issue for long gating periods.
- **Frequency Tracking:** 1<sup>st</sup> order loop. Same loop gain for DPCCH non-gated simulations as well as DPCCH gated simulations. The initial frequency error is set to 200 Hz.
- **UL Power Control:** UE transmit power adjusted just over the non-gated periods, over the gated periods the transmit power is on hold.
  - Outer loop:
    - Enabled with 1% residual BLER target for simulations over active data periods.
    - Enabled and based on a target Pilot symbol error rate over inactive data periods.
- **Channel models:** AWGN (for simulation cross-check), PA3, VA120.
- **Transmission block size (data rate):** 296 bits block size i.e., 148 kbps over single transmission (49.33 kbps after 3 transmissions).
- **E-DCH Beta factors:** from 0 to 20 dB

- **Data activity:** 100% over one HARQ process (when a packet is positively acknowledged, a new packet is transmitted).
- **DPCCH slot format:** 0, (6 pilot symbols out of 10 symbols)
- **Gating patterns:**
  - 0% gating: continuous DPCCH transmission as illustrated by Figure 1.
  - 50% gating: DPCCH transmitted over 2 HARQ processes every 8. Transmitted with 2-slot preamble and 1-slot postamble as illustrated by Figure 2.
  - 75% gating: DPCCH transmitted over 1 HARQ process every 8. Transmitted with 2-slot preamble and 1-slot postamble as illustrated by Figure 3.
  - 87.5% gating: DPCCH transmitted over 1 HARQ process every 16. Transmitted with 2-slot preamble and 1-slot postamble.

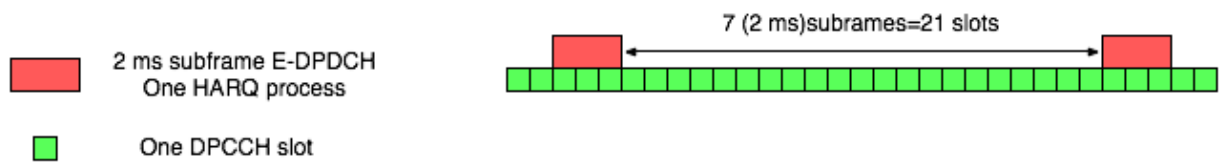

Figure 4.2.2.3.1.1-1: Baseline reference with continuous DPCCH transmission.

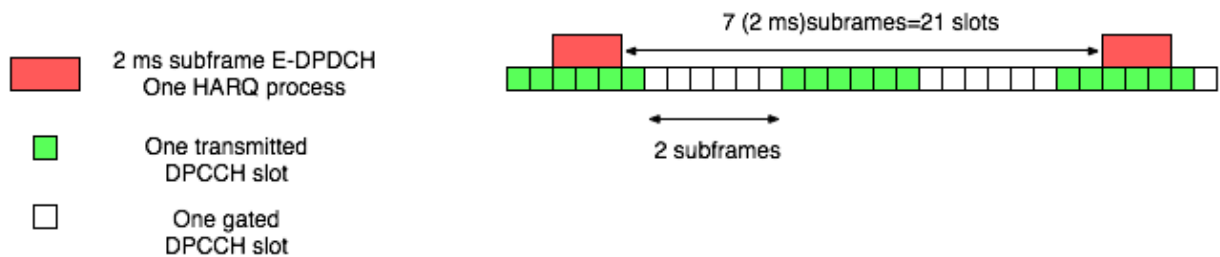

Figure 4.2.2.3.1.1-2: 50% gated DPCCH.

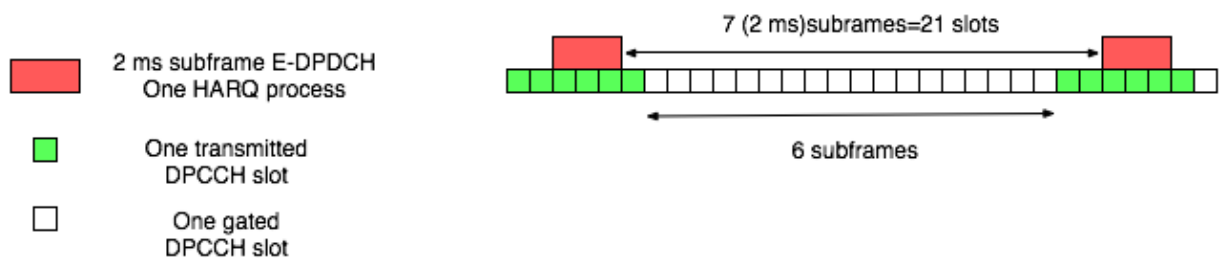

Figure 4.2.2.3.1.1-3: 75% gated DPCCH.

- Rx antennas: 2.
- Max number of transmissions: 3.



4.2.2.3.1.2 Simulation results

4.2.2.3.1.2.1 Simulations results over data active periods

Figures 4.2.2.3.1.2.1-1 to 4.2.2.3.1.2.1-6 present results for the scenarios considered. The figures show:

- Combined Eb/Nt (per antenna) - figures at the left. DPCCH overhead taken into account just when E-DCH is active.
- Effective combined Eb/Nt (per antenna) – figures at the right. DPCCH overhead taken into account regardless E-DCH is active or not.

To isolate the power control impact, results without TTL and FTL are shown for all channels.

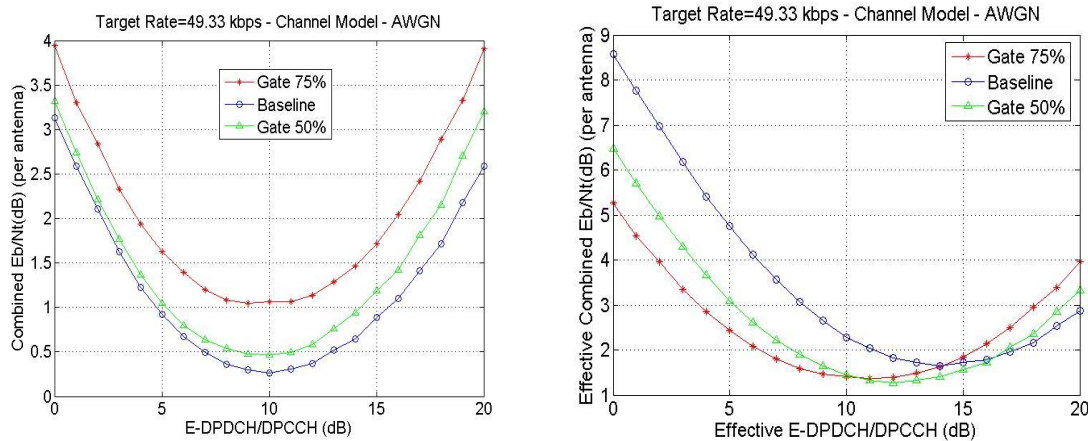

**Figure 4.2.2.3.1.2.1-1: AWGN channel, different gating patterns, combined Eb/Nt per antenna with TTL and FTL, target rate 49.3kbps.**

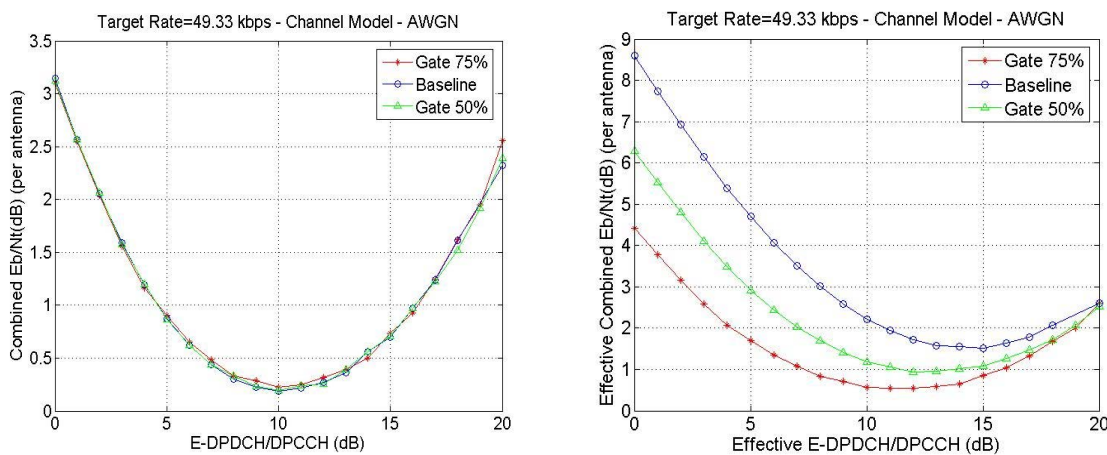

**Figure 4.2.2.3.1.2.1-2: AWGN channel, different gating patterns, combined Eb/Nt per antenna without TTL and FTL, target rate 49.3kbps.**

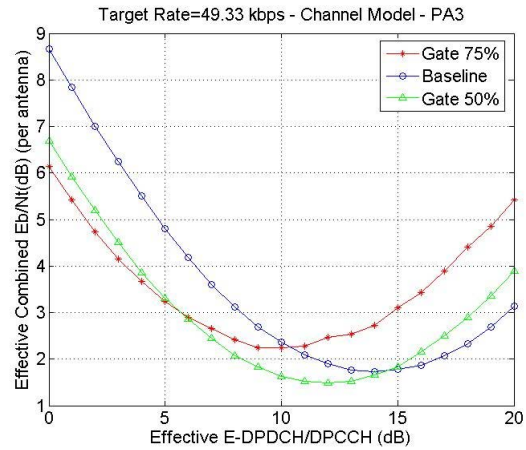
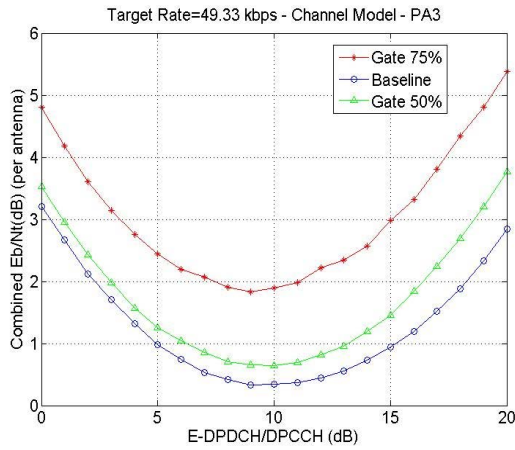

Figure 4.2.2.3.1.2.1-3: PA3 channel, different gating patterns, combined Eb/Nt per antenna with TTL and FTL, target rate 49.3kbps.

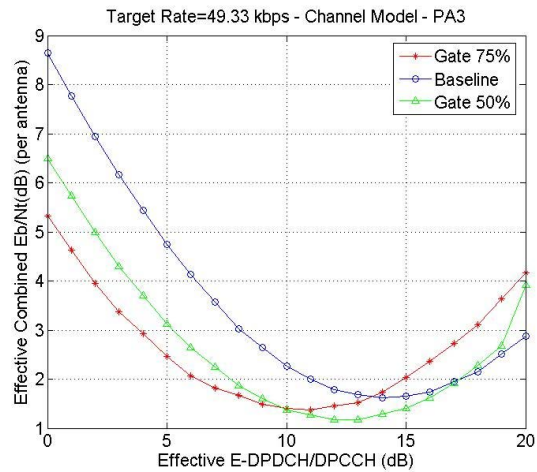
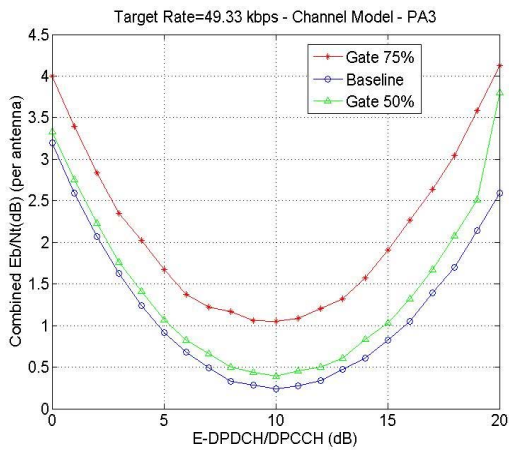

Figure 4.2.2.3.1.2.1-4: PA3 channel, different gating patterns, combined Eb/Nt per antenna without TTL and FTL, target rate 49.3kbps.

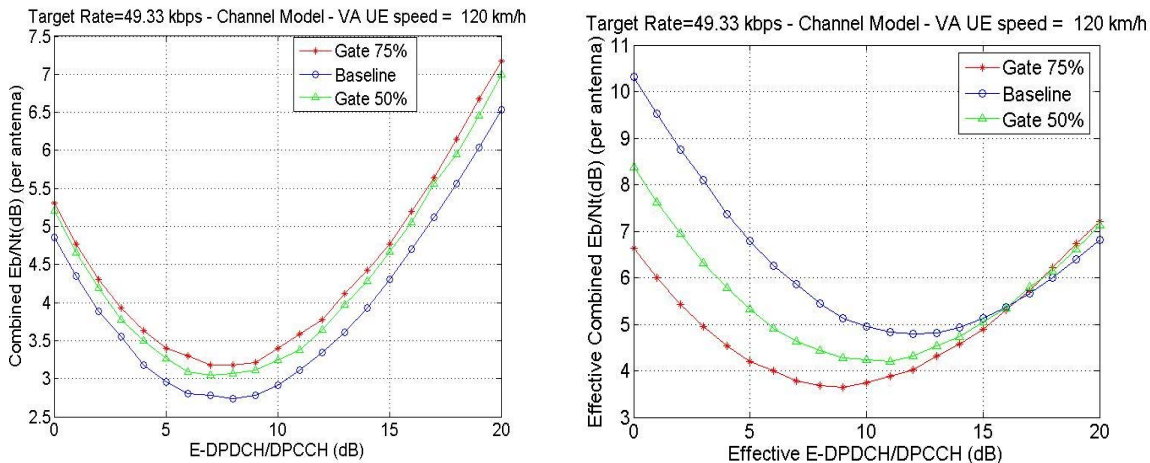

Figure 4.2.2.3.1.2.1-5: VA120 channel, different gating patterns, combined Eb/Nt per antenna with TTL and FTL, target rate 49.3kbps.

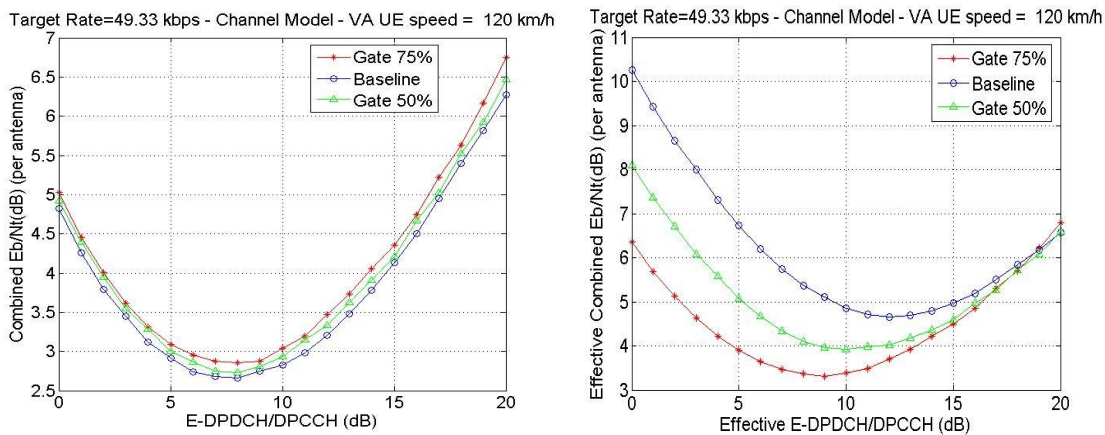

Figure 4.2.2.3.1.2.1-6: VA120 channel, different gating patterns, combined Eb/Nt per antenna without TTL and FTL, target rate 49.3kbps.

Tables 4.2.2.3.1.2.1-1 to 4.2.2.3.1.2.1-3 summarize the results with FTL and TTL enabled.

Table 4.2.2.3.1.2.1-1: AWGN with TTL FTL target rate 49.3kbps

|                                                      | No Gating        | Gating 50%       | Gating 75%       |
|------------------------------------------------------|------------------|------------------|------------------|
| MinEbnT @ opt T/P /<br>Effective MinEbnT @ opt T/P   | 0.26<br>1.65     | 0.47<br>1.27     | 1.04<br>1.36     |
| MinEcpnT @ opt T/P /<br>Effective MinEcpnT @ opt T/P | -24.73<br>-27.31 | -24.49<br>-25.73 | -22.85<br>-24.12 |
| Optimal T/P /<br>Effective Optimal T/P               | 10<br>14         | 10<br>12         | 9<br>11          |
| Effective Ec/Nt                                      | -12              | -12.79           | -12.54           |

Table 4.2.2.3.1.2.1-2: PA3 with FTL TTL target rate 49.3kbps

|                                                      | No Gating        | Gating 50%    | Gating 75%    |
|------------------------------------------------------|------------------|---------------|---------------|
| MinEbnT @ opt T/P /<br>Effective MinEbnT @ opt T/P   | 0.33<br>1.73     | 0.64<br>1.50  | 1.80<br>2.42  |
| MinEcpnT @ opt T/P /<br>Effective MinEcpnT @ opt T/P | -23.92<br>-27.02 | -23.83<br>-25 | -21<br>-21.66 |
| Optimal T/P /<br>Effective Optimal T/P               | 9<br>14          | 10<br>12      | 9<br>10       |
| Effective Ec/Nt                                      | -11.68           | -12.13        | -10.69        |

Table 4.2.2.3.1.2.1-3: VA120 with TTL FTL target rate 49.3kbps

|                                                     | No Gating        | Gating 50%       | Gating 75%       |
|-----------------------------------------------------|------------------|------------------|------------------|
| MinEbnT @ opt T/P /<br>Effective MinEbnT @opt T/P   | 2.73<br>4.80     | 3.05<br>4.20     | 3.18<br>3.64     |
| MinEcpnT @ opt T/P /<br>Effective MinEcpnT @opt T/P | -19.89<br>-22.30 | -18.79<br>-21.35 | -19.36<br>-20.18 |
| Optimal T/P /<br>Effective Optimal T/P              | 8<br>12          | 7<br>11          | 8<br>9           |
| Effective Ec/Nt                                     | -8.10            | -8.88            | -9.78            |

Table 4.2.2.3.1.2.1-4 presents the gains of the two considered gating schemes (50% and 75%) with respect to no-gating. For the transport block size of the evaluation i.e., 296 bits, the 50% gating provides gains between 0.45dB and 0.79dB. The gains range much more for the 75% gating where we go from a 1.68dB gain for the VA120 case to an actual loss of 0.99dB for the PA3 case.

Table 4.2.2.3.1.2.1-4: Summary of Results for target rate 16kbps

|       | 50% gating gain over<br>0% gating | 75% gating gain over<br>0% gating |
|-------|-----------------------------------|-----------------------------------|
| AWGN  | 0.79                              | 0.54                              |
| PA3   | 0.45                              | -0.99                             |
| VA120 | 0.78                              | 1.68                              |

In general, the gains provided by the 50% gating are higher than 75% for AWGN and PA3 channel models.

These gains at the link level directly yield a reduction in the contribution to the interference rise and therefore help into the overall system capacity improvement.

#### 4.2.2.3.1.2.2 Simulations results over data inactive periods

For the simulations over inactive data periods and due to lack of data blocks, a power control loop based on Pilot symbol error rate is used. Tables 4.2.2.3.1.2.2-1 to 4.2.2.3.1.2.2- 4 show the results of calibrating this outer loop power control method with the regular outer loop power control method based on E-DPDCH BLER. The verification is performed for a number of channel models and T/P operating points.

**Table 4.2.2.3.1.2.2-1: PedA3 channel model without TTL FTL, Max 3ReTX target rate 49.3 kbps, T/P=9**

|                                   | <b>Eb/Nt</b> | <b>Pilot Ec/Nt</b> | <b>E-DPDCH BLER</b> | <b>Pilot SER</b> |
|-----------------------------------|--------------|--------------------|---------------------|------------------|
| <b>BLER based outer loop</b>      | 0.28         | -23.86             | 0.0104              | 0.0588           |
| <b>Pilot SER based outer loop</b> | 0.22         | -24.08             | 0.0113              | 0.0613           |

**Table 4.2.2.3.1.2.2-2: PedA3 channel model without TTL FTL, Max 4ReTX target rate 16 kbps, T/P=7**

|                                   | <b>Eb/Nt</b> | <b>Pilot Ec/Nt</b> | <b>E-DPDCH BLER</b> | <b>Pilot SER</b> |
|-----------------------------------|--------------|--------------------|---------------------|------------------|
| <b>BLER based outer loop</b>      | 1.18         | -25.91             | 0.01030             | 0.090754         |
| <b>Pilot SER based outer loop</b> | 1.16         | -25.98             | 0.01080             | 0.092509         |

**Table 4.2.2.3.1.2.2-3: Va120 channel model without TTL FTL, Max 4ReTX target rate 16 kbps, T/P=7**

|                                   | <b>Eb/Nt</b> | <b>Pilot Ec/Nt</b> | <b>E-DPDCH BLER</b> | <b>Pilot SER</b> |
|-----------------------------------|--------------|--------------------|---------------------|------------------|
| <b>BLER based outer loop</b>      | 3.82         | -22.48             | 0.01040             | 0.01275          |
| <b>Pilot SER based outer loop</b> | 3.83         | -22.52             | 0.00801             | 0.01277          |

**Table 4.2.2.3.1.2.2-4: Va120 channel model without TTL FTL, Max 3ReTX target rate 49.3 kbps, T/P=9**

|                                   | <b>Eb/Nt</b> | <b>Pilot Ec/Nt</b> | <b>E-DPDCH BLER</b> | <b>Pilot SER</b> |
|-----------------------------------|--------------|--------------------|---------------------|------------------|
| <b>BLER based outer loop</b>      | 2.73         | -20.59             | 0.0104              | 0.00735          |
| <b>Pilot SER based outer loop</b> | 2.71         | -20.58             | 0.0073              | 0.00712          |

From the results above, we can see that the outer-loop power control method based on Pilot SER yields practically the same result as the traditional outer-loop power control method based on E-DPDCH BLER. Therefore, given that over inactive periods there will not be sufficient packets to base the outer-loop power control on the E-DPDCH BLER, the Pilot SER method appears to be a viable alternative.

Tables present results for the scenarios considered. The Tables show:

- Pilot Ec/Nt (Ecp/Nt).
- Effective Pilot Ec/Nt (Eff. Ecp/Nt): normalized to the effective transmission ratio of DPCCH.

### **Results with no Code Doppler**

The results in this subsection assume the paths of the traffic models under investigation to remain at a fixed time offset for the entire simulation length. Note that this is an unrealistic assumption as the UE speed will create Code Doppler that will skew in time the receive chips. Performance with Code Doppler is investigated in the next subsection.

Tables 4.2.2.3.1.2.2-5 and 4.2.2.3.1.2.2-6 present the performance of DPCCH demodulation for continuous reception (no gating) and three DPCCH gating levels.

**Table 4.2.2.3.1.2.2-5: PedA3 channel model with TTL FTL, no code Doppler**

| Results in dB      | <b>No gating</b> | <b>Gating 50%</b> | <b>Gating 75%</b> | <b>Gating 87.5%</b> |
|--------------------|------------------|-------------------|-------------------|---------------------|
| <b>Ecp/Nt</b>      | -24.83           | -24.72            | -24.29            | -23.50              |
| <b>Eff. Ecp/Nt</b> | -24.83           | -27.72            | -30.29            | -32.50              |

**Table 4.2.2.3.1.2.2-6: VA120 channel model with TTL FTL, no code Doppler**

| Results in dB      | No gating | Gating 50% | Gating 75% | Gating 87.5% |
|--------------------|-----------|------------|------------|--------------|
| <b>Ecp/Nt</b>      | -21.27    | -21.18     | -21.11     | -21.03       |
| <b>Eff. Ecp/Nt</b> | -21.27    | -24.18     | -27.11     | -30.03       |

Table 4.2.2.3.1.2.2-7 summarizes the performance gain of DPCCH gating for the three different DPCCH gatings.

**Table 4.2.2.3.1.2.2-7: DPCCH gating gain with TTL FTL, no code Doppler**

| Results in dB | Gain gating 50%<br>over 0% gating | Gain gating 75%<br>over 0% gating | Gain gating 87.5%<br>over 0% gating |
|---------------|-----------------------------------|-----------------------------------|-------------------------------------|
| <b>PA3</b>    | 2.89                              | 5.46                              | 7.67                                |
| <b>VA120</b>  | 2.91                              | 5.84                              | 8.76                                |

From the results in Table 4.2.2.3.1.2.2-7, the gains of DPCCH gating over inactive periods grow for larger gating periods. As we can see the gains for VA120 are very close to the ideal gains of 3dB, 6dB and 9dB for 50%, 75% and 87.5 gating respectively.

### **Results with Code Doppler**

The results in this subsection assume take into account Code Doppler and therefore the DPCCH chips will skew over time.

Tables 4.2.2.3.1.2.2-8 and 4.2.2.3.1.2.2-9 present the performance of DPCCH demodulation for continuous reception (no gating) and three DPCCH gating levels.

**Table 4.2.2.3.1.2.2-8: PedA3 channel model with TTL FTL, code Doppler**

| Results in dB      | No gating | Gating 50% | Gating 75% | Gating 87.5% |
|--------------------|-----------|------------|------------|--------------|
| <b>Ecp/Nt</b>      | -24.83    | -24.69     | -23.87     | -23.39       |
| <b>Eff. Ecp/Nt</b> | -24.83    | -27.69     | -29.87     | -32.39       |

**Table 4.2.2.3.1.2.2-9: VA120 channel model with TTL FTL, code Doppler**

| Results in dB      | No gating | Gating 50% | Gating 75% | Gating 87.5% |
|--------------------|-----------|------------|------------|--------------|
| <b>Ecp/Nt</b>      | -20.92    | -20.29     | -20.06     | -19.17       |
| <b>Eff. Ecp/Nt</b> | -20.92    | -23.29     | -26.06     | -28.17       |

Table 4.2.2.3.1.2.2-10 summarizes the performance gain of DPCCH gating for the three different DPCCH gatings.

**Table 4.2.2.3.1.2.2-10: DPCCH gating gain with TTL FTL, code Doppler**

| Results in dB | Gain gating 50%<br>over 0% gating | Gain gating 75%<br>over 0% gating | Gain gating 87.5%<br>over 0% gating |
|---------------|-----------------------------------|-----------------------------------|-------------------------------------|
| <b>PA3</b>    | 2.86                              | 5.03                              | 7.56                                |
| <b>VA120</b>  | 2.37                              | 5.14                              | 7.25                                |

From the results in Table 4.2.2.3.1.2.2-10, the gains of DPCCH gating over inactive periods grow for larger gating periods. As we can see, now the gains are further away from the ideal gains of 3dB, 6dB and 9dB for 50%, 75% and 87.5 gating respectively.

## 4.2.2.3.2 Link level results for CQI decoding and for large TB sizes

## 4.2.2.3.2.1 Simulation assumptions

Common parameters for an ideal simulation setting and a more realistic simulation setting are found in Table 4.2.2.3.2.1-1 below. Parameters specific for the two cases are found in Table 4.2.2.3.2.1-2. Note that all simulations have been run without retransmissions.

**Table 4.2.2.3.2.1-1: Simulation parameters common for the two simulated cases**

| Parameter          | Value                                                                         | Comment                                                                                  |
|--------------------|-------------------------------------------------------------------------------|------------------------------------------------------------------------------------------|
| Gating pattern     | See Figure 4.2.2.3.2.1-1                                                      | Basic pattern is 1 sub-frame E-DCH transmission followed by 9 sub-frames E-DCH "silent". |
| DPDCH              | OFF                                                                           |                                                                                          |
| DPCCH slot format  | 8 pilots + 2 TPC                                                              |                                                                                          |
| Channel models     | AWGN<br>Pedestrian A, 3 km/h<br>Vehicular A, 30 km/h<br>Vehicular A, 120 km/h |                                                                                          |
| UL power control   | ON                                                                            | 0% error rate, 1-dB step size                                                            |
| Node B Rx antennas | 2                                                                             |                                                                                          |
| HARQ               | OFF                                                                           | One transmission                                                                         |

**Table 4.2.2.3.2.1-2: Parameters specific for the two simulated cases**

| Parameter            | Value, ideal                                                                    | Value, realistic                                                               |
|----------------------|---------------------------------------------------------------------------------|--------------------------------------------------------------------------------|
| TTI                  | 2 ms                                                                            | 2 ms                                                                           |
| E-DCH data rate      | 160 kbps (2 ms TTI, 320 bits TB size)<br>1.0 Mbps (2 ms TTI, 2000 bits TB size) | 160 kbps (2ms TTI, 320 bits TB size)<br>1.0 Mbps (2 ms TTI, 2000 bits TB size) |
| E-DPDCH/DPCCH        | 8 dB (2 ms TTI, 320 bits TB)<br>11.5 dB (2 ms TTI, 2000 bits TB)                | 8 dB (2 ms TTI, 320 bits TB)<br>13 dB (2 ms TTI, 2000 bits TB)                 |
| E-DPCCH/DPCCH        | 0 dB                                                                            | 0 dB                                                                           |
| HS-DPCCH/DPCCH       | HS-DPCCH off                                                                    | 0 dB (2 ms TTI, 320 and 2000 bits TB)                                          |
| Simulation time      | 10 000 frames (320 bits TB)<br>5 000 frames (2000 bits TB)                      | 5 000 frames                                                                   |
| Channel estimation   | Ideal                                                                           | TPC-aided 3-slot sliding average                                               |
| SIR estimation       | Realistic                                                                       | Realistic                                                                      |
| Path delay search    | Ideal                                                                           | Realistic                                                                      |
| Frequency estimation | Ideal                                                                           | Ideal                                                                          |
| TPC loop delay       | 1 slot                                                                          | 2 slots                                                                        |
| Physical channels    | DPCCH + E-DPCCH + E-DPDCH                                                       | DPCCH + E-DPCCH + E-DPDCH + HS-DPCCH                                           |

The simulated transmission patterns are continuous DPCCH transmission, gating, gating with a 3-slot preamble, and gating with a 6-slot preamble (although the 6-slot preamble has only been simulated with the ideal parameter setting). The repetition period of the transmission pattern is 2 frames (30 slots). The simulated transmission pattern can be found in Figure 4.2.2.3.2.1-1. The transmission patterns for the realistic simulation setting are the same as for the ideal simulation setting, except that the HS-DPCCH is also transmitted whenever the E-DCH is active. Consequently, the HS-DPCCH is active in one sub-frame out of ten sub-frames.

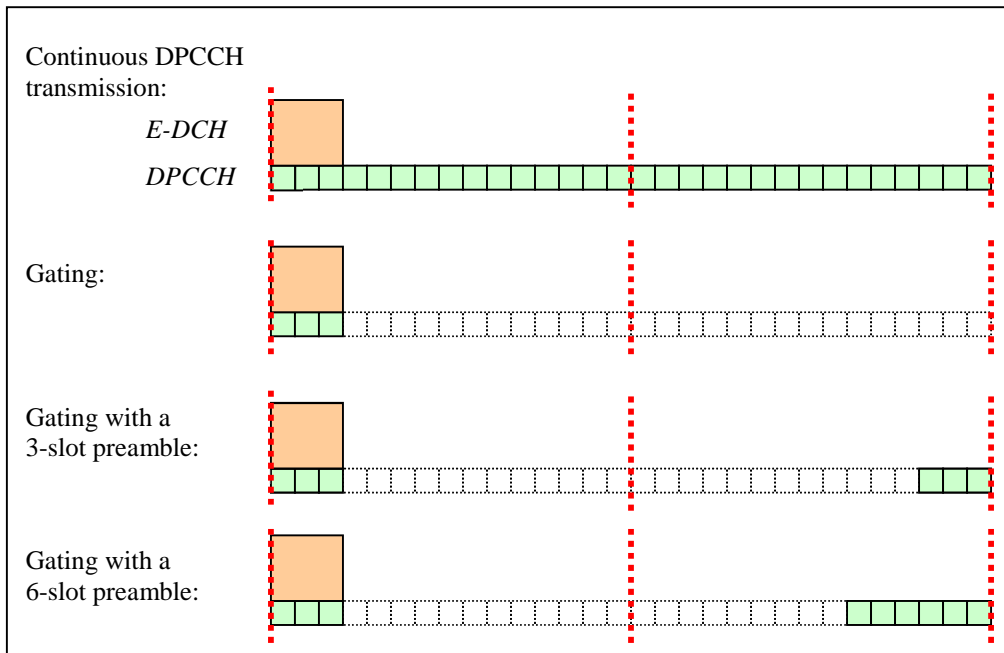
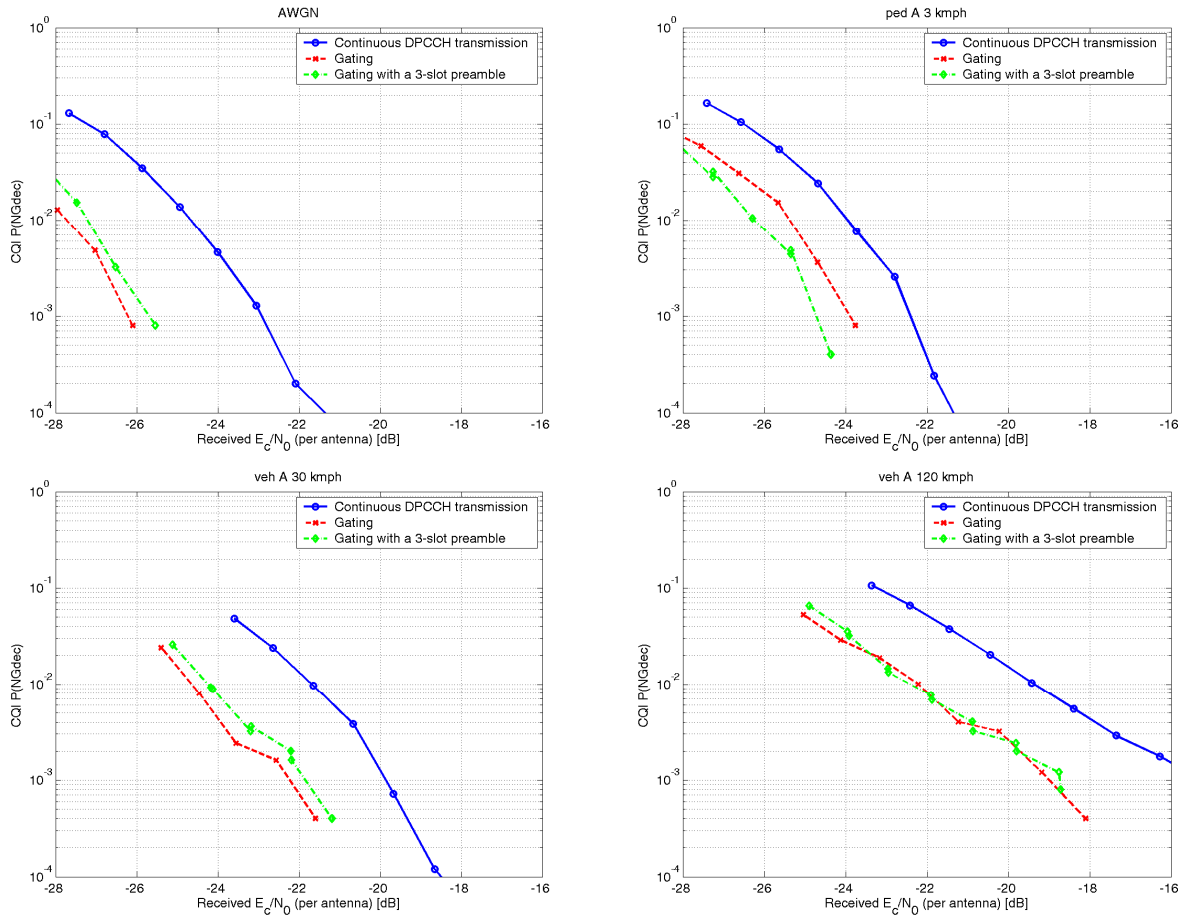

**Figure 4.2.2.3.2.1-1. Simulated transmission patterns for the 2 ms TTI**

4.2.2.3.2.2 CQI decoding simulation results

Results for CQI decoding performance are shown only for the realistic simulation setting.





**Table 4.2.2.3.2-1: CQI performance results. Gain in dB compared to the continuously transmitted DPCCH, 2ms TTI, 320 bit TB.**

| Channel                    | Realistic   |                 |
|----------------------------|-------------|-----------------|
|                            | No preamble | 3-slot preamble |
| AWGN<br>- 1 % P(NGdec)     | 3.0         | 2.5             |
| PedA 3<br>- 1 % P(NGdec)   | 1.4         | 2.2             |
| VehA 30<br>- 1 % P(NGdec)  | 2.9         | 2.6             |
| VehA 120<br>- 1 % P(NGdec) | 2.8         | 3.0             |

No unexpected results are found, but rather the findings are in line with the E-DCH results. However, the gains from gating are less pronounced for the CQI than for E-DCH, and it is likely that  $\beta_{hs}$  needs to be increased slightly resulting in a minor degradation of the overall gating gain.

4.2.2.3.2.3 Simulation results with 2000-bit TB size

The figures below provide simulation results for the ideal and the realistic simulations. Four channels have been simulated: AWGN, Pedestrian A 3 km/h, Vehicular A 30 km/h, and Vehicular A 120 km/h. Two figures are shown for each simulation, BLER vs. received  $E_b/N_0$  (per antenna), and throughput vs. received  $E_c/N_0$  (per antenna).

Simulation results for the ideal parameter setting:

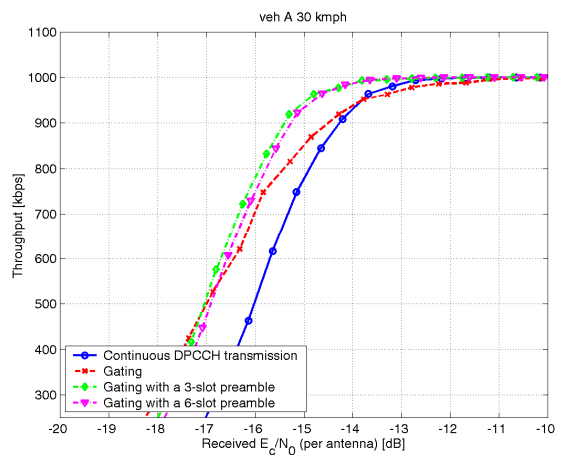
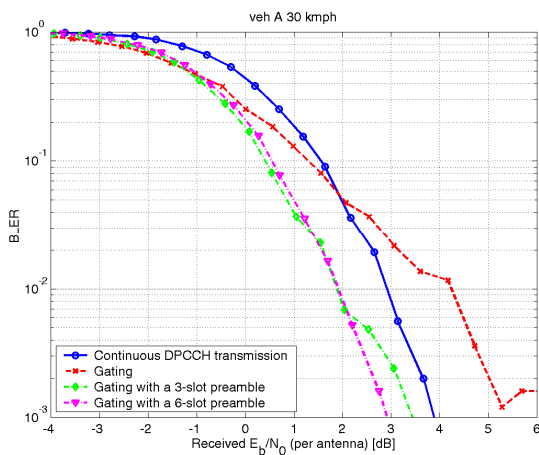
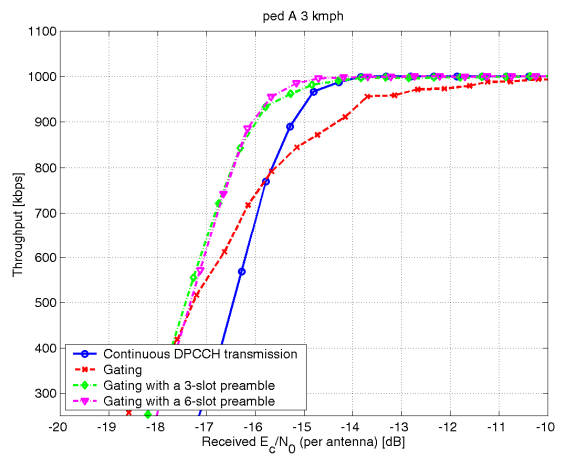
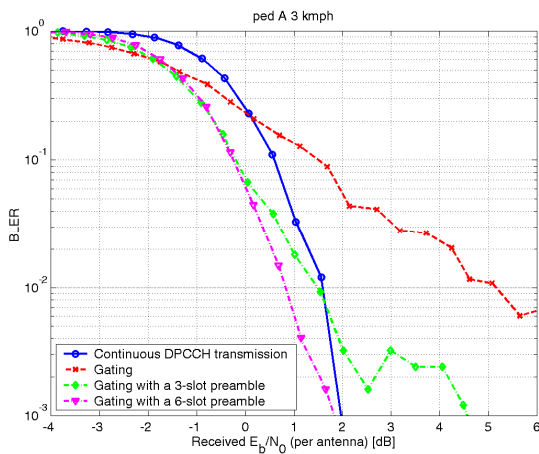
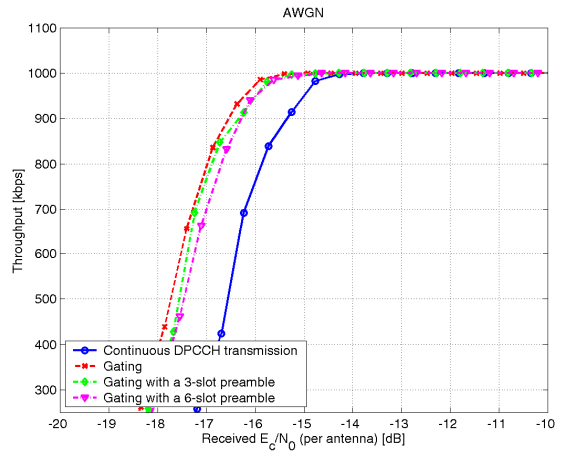
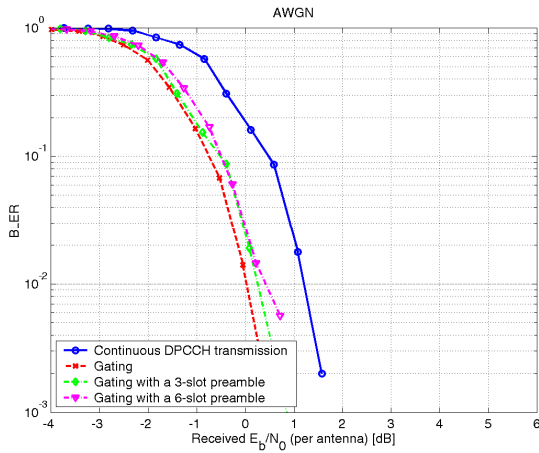

**Simulation results for the realistic parameter setting:**

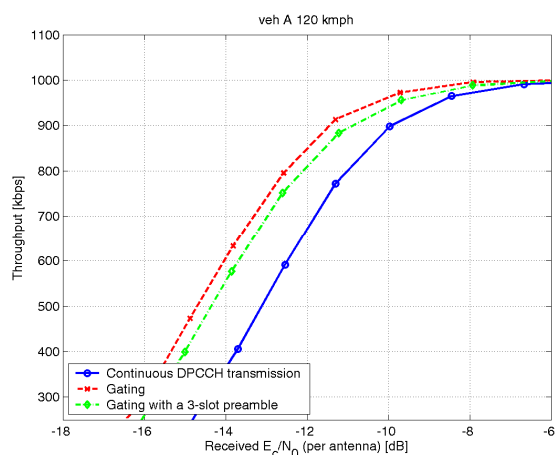
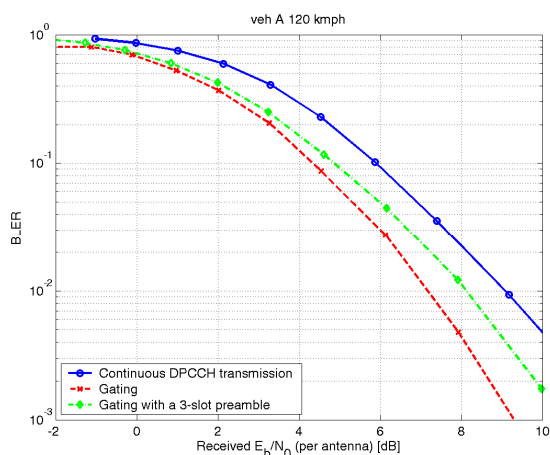
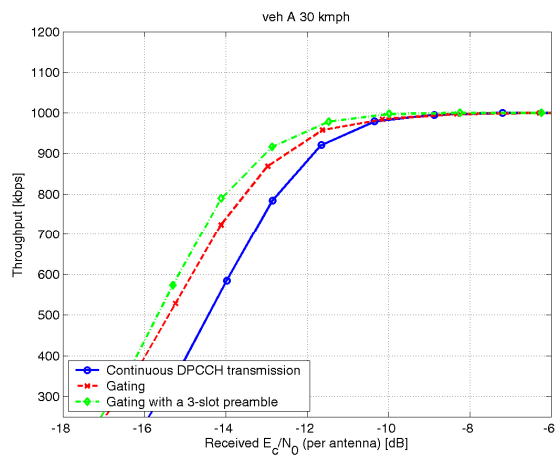
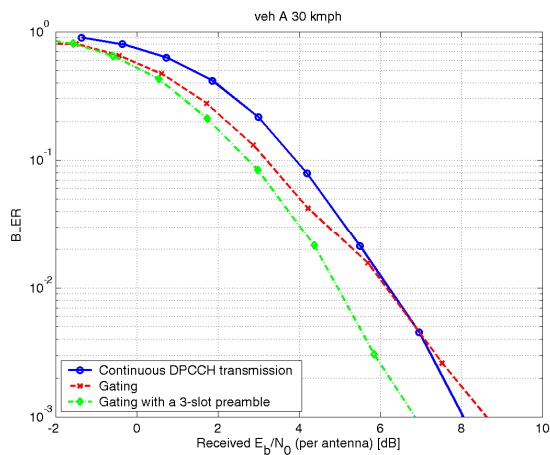
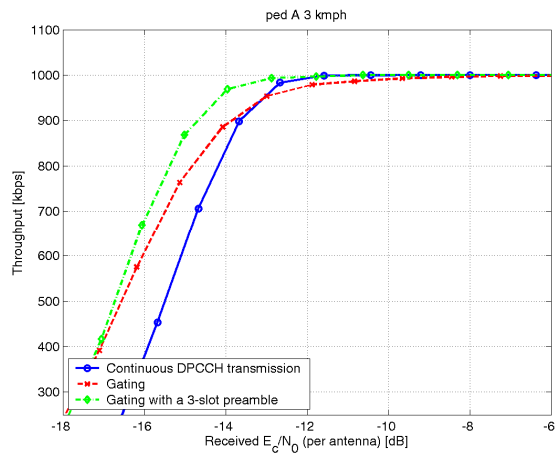
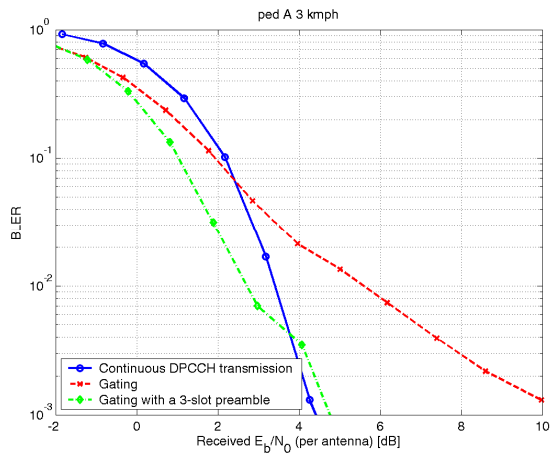
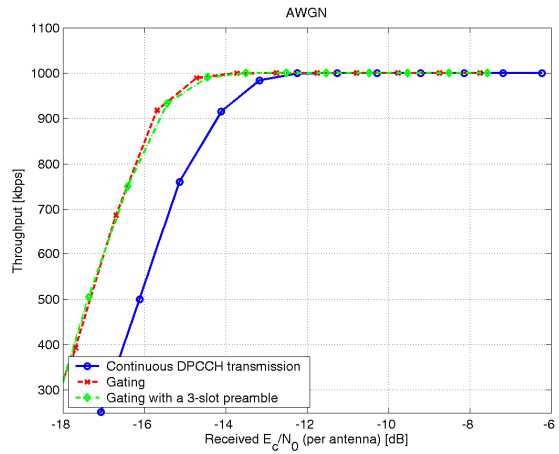
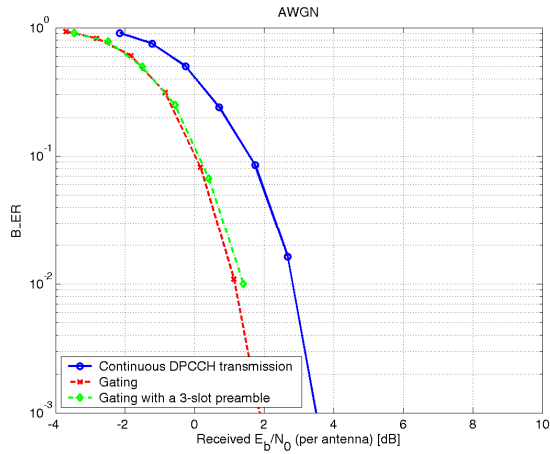

**Table 4.2.2.3.2.3-1: Gain dB compared to the continuously transmitted DPCCH, 2ms TTI, 2000 bit TB**

| Channel    | Ideal       |                 |                 | Realistic   |                 |                 |
|------------|-------------|-----------------|-----------------|-------------|-----------------|-----------------|
|            | No preamble | 3-slot preamble | 6-slot preamble | No preamble | 3-slot preamble | 6-slot preamble |
| AWGN       |             |                 |                 |             |                 |                 |
| - 50% BLER | 1.1         | 1.0             | 0.9             | 1.3         | 1.2             | -               |
| - 5% BLER  | 1.2         | 1.0             | 1.0             | 1.6         | 1.4             | -               |
| PedA 3     |             |                 |                 |             |                 |                 |
| - 50% BLER | 0.8         | 0.9             | 1.0             | 1.1         | 1.3             | -               |
| - 5% BLER  | -1.2        | 0.5             | 0.7             | -0.5        | 0.8             | -               |
| VehA 30    |             |                 |                 |             |                 |                 |
| - 50% BLER | 1.0         | 1.0             | 0.9             | 1.0         | 1.3             | -               |
| - 5% BLER  | 0.0         | 1.2             | 1.0             | 0.7         | 1.2             | -               |
| VehA 120   |             |                 |                 |             |                 |                 |
| - 50% BLER | -           | -               | -               | 1.6         | 1.3             | -               |
| - 5% BLER  | -           | -               | -               | 1.6         | 0.9             | -               |

From the figures and the table above it is clear that the gains from gating are less for higher data rates compared to small and moderate data rates. This is expected since the power ratio between E-DPDCH and DPCCH increases as a function of the data rate. However, the trends are the same here as for lower data rates, but the preamble seems to be more important in this case.

This case (2000 bits transmitted every 20 ms) might be somewhat artificial, but it indicates that the E-DCH performance can be robust after a gating gap also for traffic with higher data rates than VoIP.

#### 4.2.2.3.3 Preamble detection link level result for uplink DPCCH gating with long gating gap

This section presents preamble detection performance simulation results on uplink DPCCH gating with long gating gap.

##### 4.2.2.3.3.1 Simulation assumptions

**Table 4.2.2.3.3.1-1: Simulation parameters**

| Parameter         | Value                    | Comment                           |
|-------------------|--------------------------|-----------------------------------|
| Channel model     | PA3, PB3,VA30,VA120      |                                   |
| Rx Antennas       | 2                        |                                   |
| Path Search       | Real                     |                                   |
| Ec/N0 dB          | DPCCH                    |                                   |
| DPCCH slot format | 1                        | 8 pilot symbols out of 10 symbols |
| DPCCH gap length  | 1 sec                    |                                   |
| Preamble length   | 9,12,15, 18 and 21 slots |                                   |
| Inner loop PC     | Off                      |                                   |
| Outer loop PC     | Off                      |                                   |
| False Alarm       | 0.1%                     |                                   |
| Statistics number | 5000 for each case       |                                   |

4.2.2.3.3.2 Simulation results

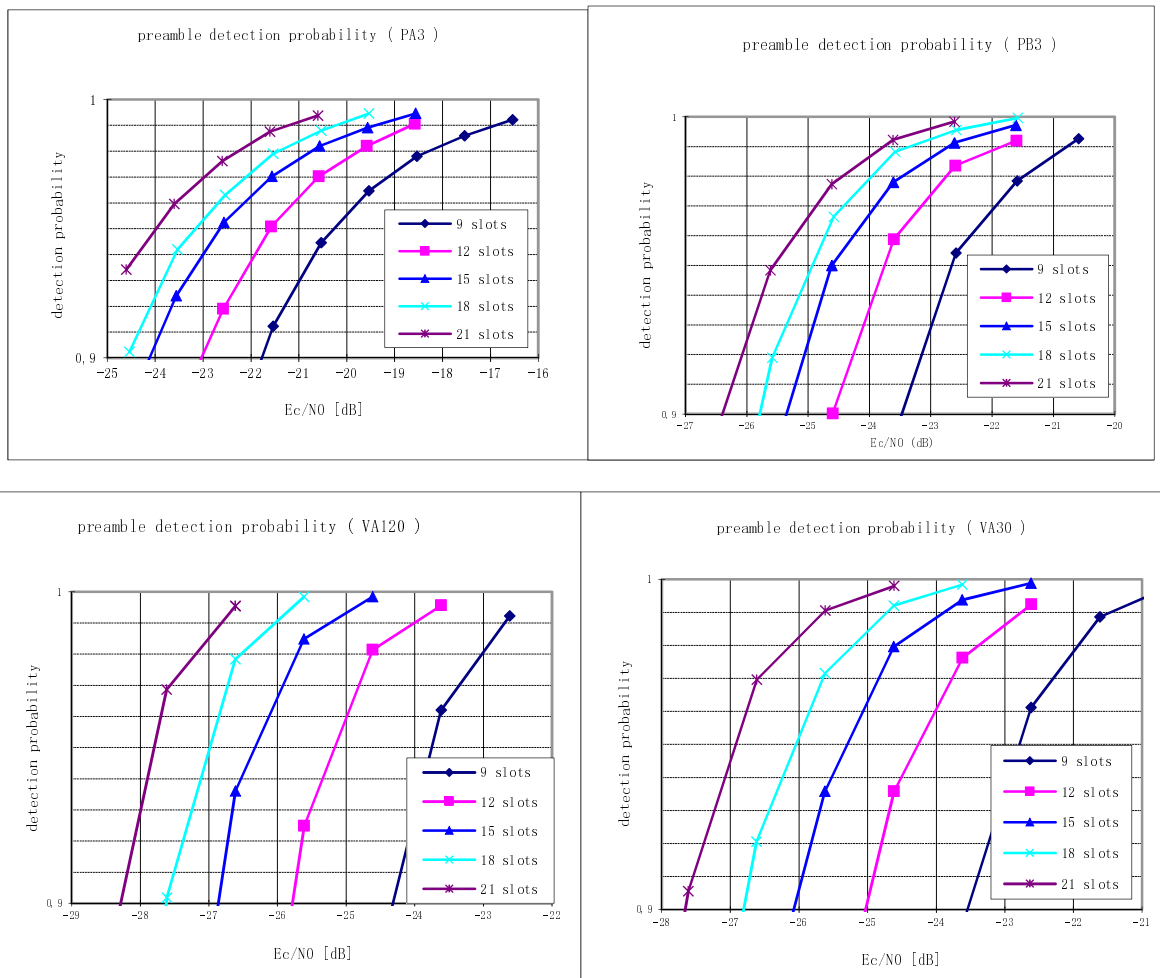

Fig 4.2.2.3.3.2-1. Preamble Detection Probability for different preamble length and various channel models

## 4.2.2.4 System performance

## 4.2.2.4.1 Simulation assumptions

Table 4.2.2.4.1-1: Simulation parameters

| Parameter                           | Value                | comments                                                                         |
|-------------------------------------|----------------------|----------------------------------------------------------------------------------|
| Frame Size                          | 2ms TTI / 10 ms TTI  |                                                                                  |
| Inter site distance                 | 2.8 km               |                                                                                  |
| Cell configuration                  | ITU Veh-A, Macrocell |                                                                                  |
| Voice call mean length              | 60 seconds           |                                                                                  |
| Voice on/off mean length            | 3 seconds            |                                                                                  |
| Header compressed VoIP packet size  | 31+7= 38 bytes       |                                                                                  |
| UE speed                            | 3 kmph               |                                                                                  |
| VoIP packet arrival interval        | 20 ms                | With 10 ms TTI 2 VoIP packets transmitted every 40 ms.                           |
| Outage observation window length    | 10 seconds           |                                                                                  |
| Cell outage threshold               | 5% FER               |                                                                                  |
| Soft handover Window_Add            | 1 dB / 4 dB          |                                                                                  |
| Number of HARQ channels             | 8 / 4                | 2 ms TTI / 10 ms TTI respectively                                                |
| Max number of L1 transmissions      | 4 / 2                | 2 ms TTI / 10 ms TTI respectively                                                |
| E-DPCCH                             | Error free           |                                                                                  |
| HS-DPCCH                            |                      | CQI sent every 10 ms<br>ACK/NACK sent every 40 ms                                |
| E-DCH Bitrate                       | 160 kbps / 64 kbps   | 2 ms TTI / 10 ms TTI respectively                                                |
| Beta_ed                             | 8 dB                 |                                                                                  |
| Beta_ec                             | 3 dB / -6 dB         | 2 ms TTI / 10 ms TTI respectively                                                |
| Beta_hs                             | 0 dB                 |                                                                                  |
| Voice activity                      | 0.5                  | DPCCH transmitted in every 10 <sup>th</sup> sub-frame during voice inactivity    |
| Mean transmissions                  | 3                    | Only used for semi-analytical study, and collected from system level simulations |
| Other cell to own cell interference | 0.65                 | Only used for semi-analytical study                                              |

## 4.2.2.4.2 VoIP results with and without gating – 2 ms TTI

33% throughput in the figures refer to HARQ operating point of 3 transmissions per packet, or more generally:  $1/\text{throughput-\%} = \text{average number of transmissions per transmitted packet}$ .

In Figure 4.2.2.4.2-1 the cell noise rise is shown as a function of the number of voice users. The two solid lines are from semi-analytical calculations with continuous (blue) and gated (red) DPCCH representing the theoretical upper bound of the system capacity with the given assumptions. The four simulated curves (sims) represents continuous and gated DPCCH with HS-DPCCH transmitted simultaneously with E-DCH (OFF=0) and HS-DPCCH not transmitted simultaneously with E-DCH (OFF=3).

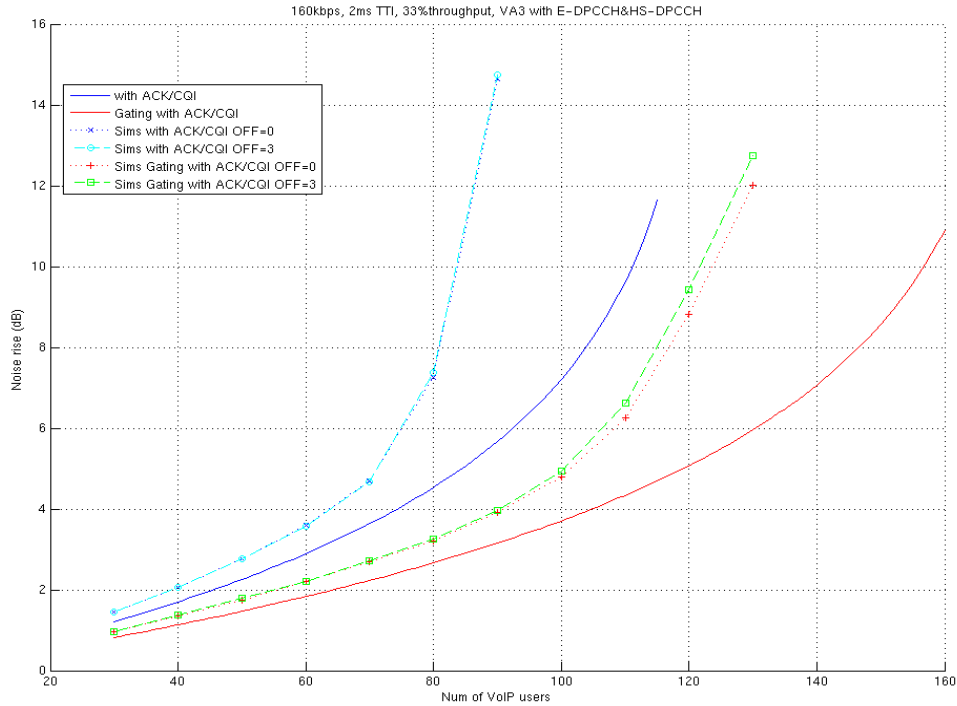

Figure 4.2.2.4.2-1: Noise rise as a function of # of VoIP users, calculated and simulated

In Figure 4.2.2.4.2-2 the same four simulation cases as in Figure 4.2.2.4.2-1 are presented showing this time the cell outage as a function of a number of VoIP users.

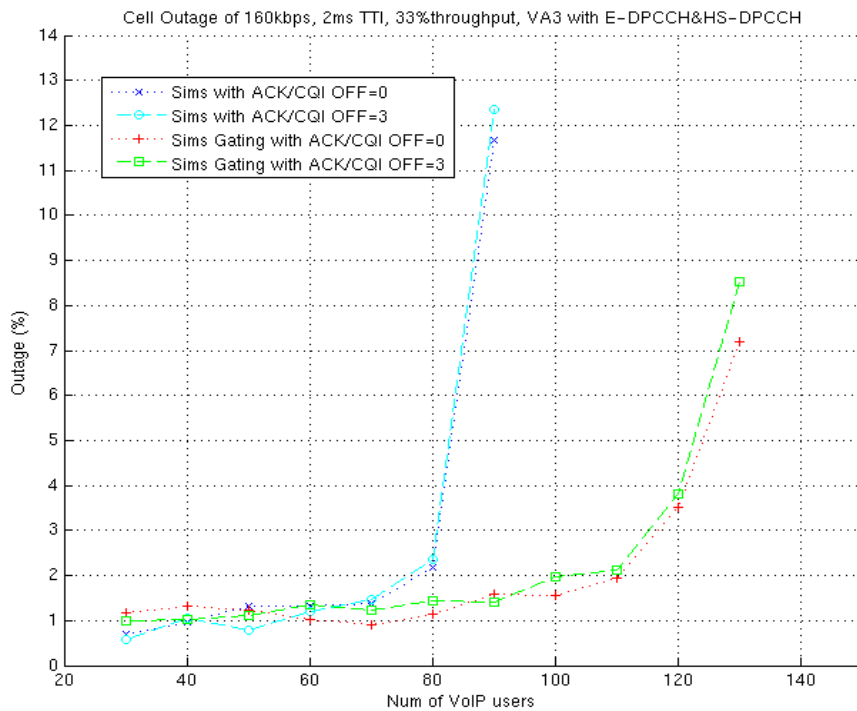
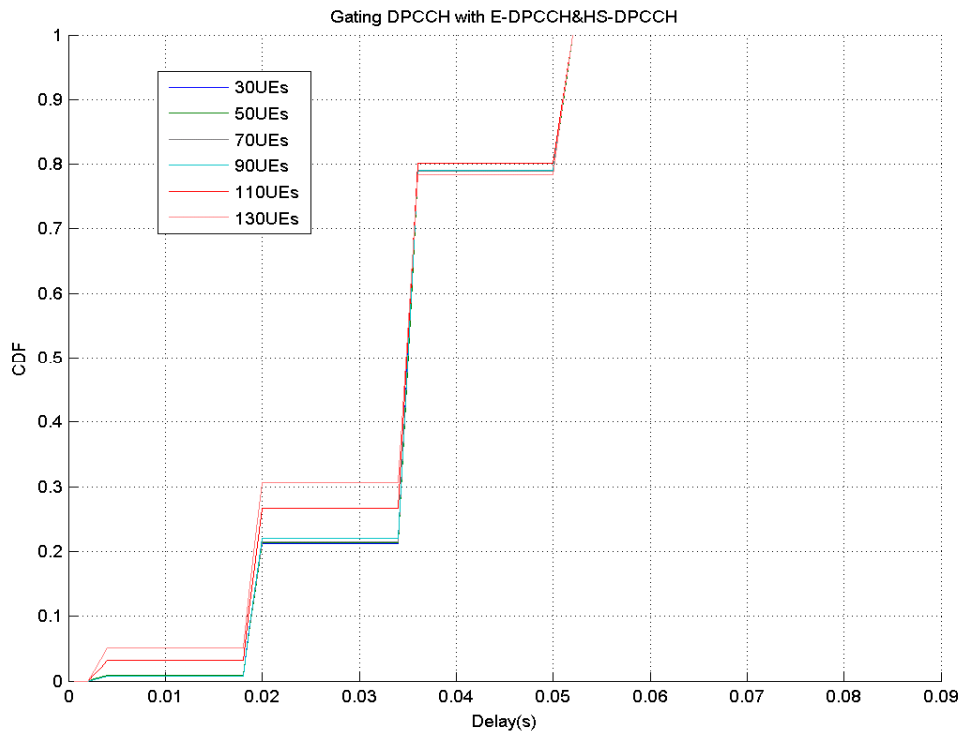

Figure 4.2.2.4.2-2: Cell outage % as a function of # of VoIP users, simulated

Figure 4.2.2.4.2-3 shows the VoIP packet delay distribution with the gated DPCCH. The steps in the curves represent different number of retransmissions required.



With the assumptions used in the simulations the UE transmitter could be off 73% of the time when gating is applied.



**Figure 4.2.2.4.2-3: Packet delay distribution of the simulations**

#### 4.2.2.4.3 VoIP results with and without gating – 10 ms TTI and packet bundling

The results in figures 4.2.2.4.3-4...-6 are simulated with outer loop power control operating after the first transmission. The HARQ operating points of 25% and 67% initial transmission BLER have been investigated with and without uplink DPCCH gating. The used traffic model is VoIP with bundling of two packets, i.e. in all the cases 2 VoIP packets have been bundled to a single TTI and new initial transmission occurs every 40 ms when the user is in the active speech cycle.

- Figure 4.2.2.4.3-4 shows the RoT curves for the simulated cases,
- Figure 4.2.2.4.3-5 shows the cell outage curves for the simulated cases,
- Figure 4.2.2.4.3-6 shows the residual FER curves for the simulated cases.

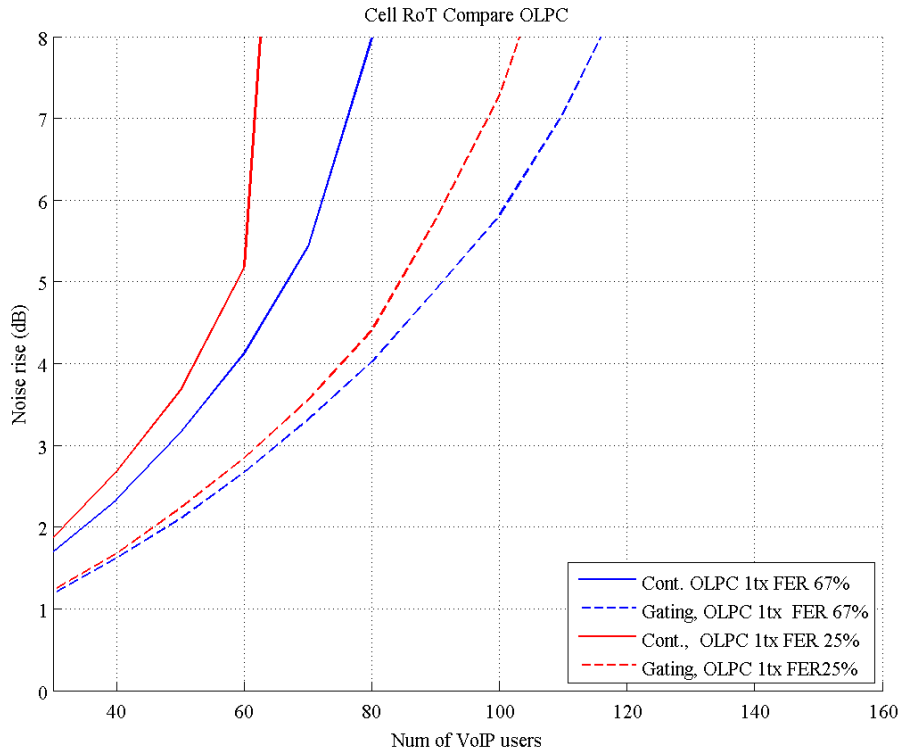

Figure 4.2.2.4.3-4: Noise rise as a function of # of VoIP users

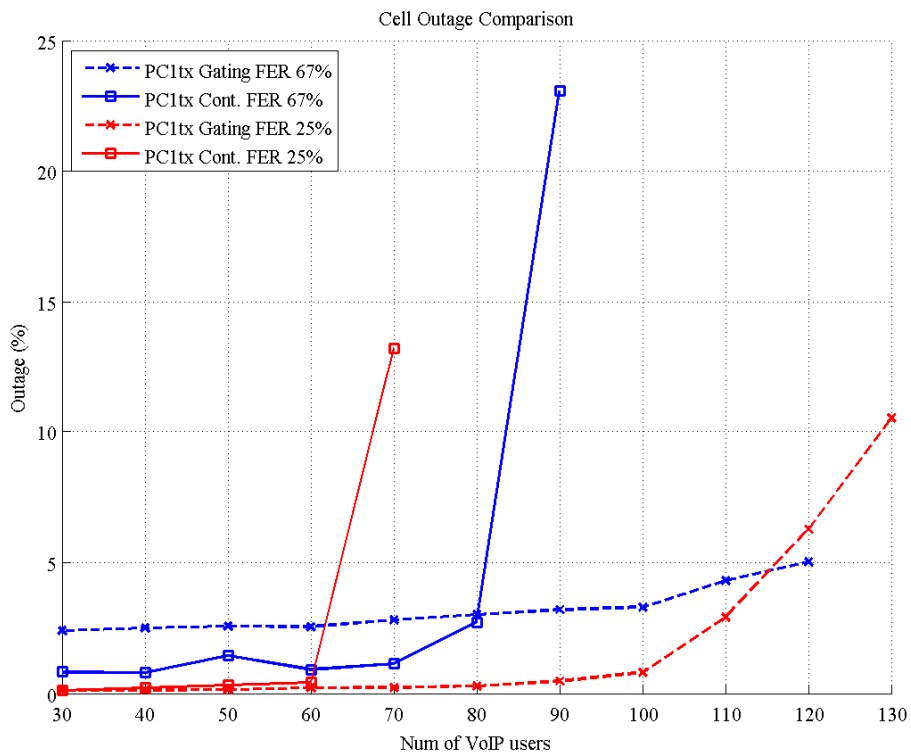

Figure 4.2.2.4.3-5: Cell outage % as a function of # of VoIP users

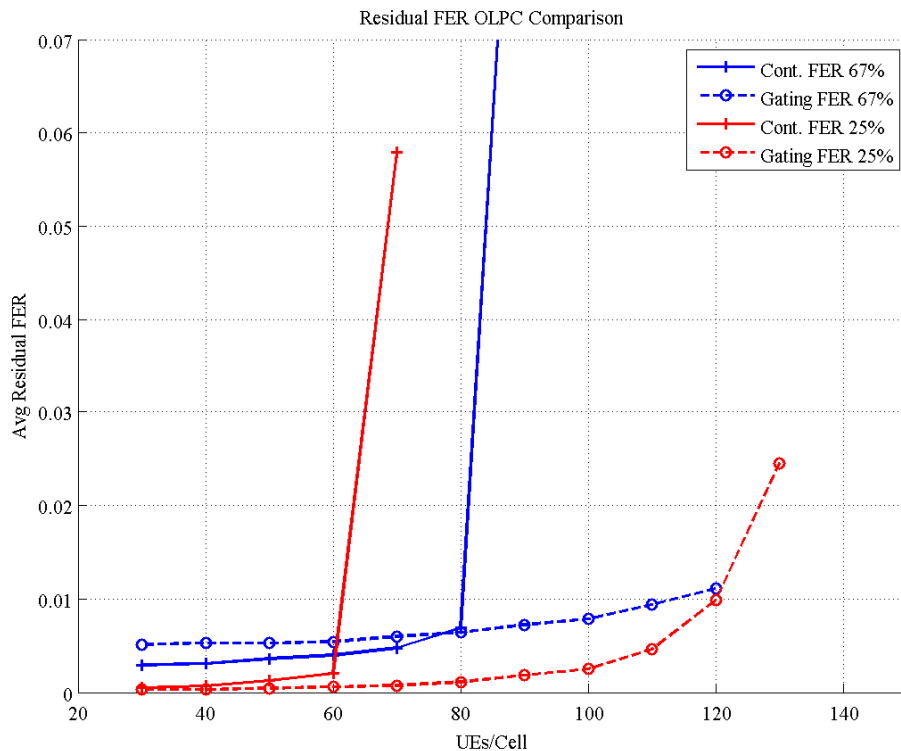

Figure 4.2.2.4.3-6: Residual FER as a function of # of VoIP users

With the assumptions used in the simulations the UE transmitter could be off 72% or 67% of the time with outer loop power control targeting for 25% or 67% BLER after the first transmission respectively.

4.2.2.4.4 VoIP results - Summary

Table 4.2.2.4.4-1: Summary of the VoIP capacity results with uplink DPCCH gating

| TTI    | Average number of transmissions | Capacity criteria: 5% FER over 10 s |             |             | Capacity criteria: Noise rise 6 dB |             |             |
|--------|---------------------------------|-------------------------------------|-------------|-------------|------------------------------------|-------------|-------------|
|        |                                 | Continuous DPCCH                    | Gated DPCCH | Gating Gain | Continuous DPCCH                   | Gated DPCCH | Gating Gain |
| 2 ms   | ~3                              | 82 users                            | 123 users   | 50%         | 75 users                           | 106 users   | 41%         |
| 10 ms* | 1.25                            | 65 users                            | 115 users   | 77%         | 61 users                           | 93 users    | 52%         |
|        | 1.67                            | 80 users                            | 120 users   | 50%         | 73 users                           | 103 users   | 41%         |

\* 10 ms TTI results using bundling of 2 VoIP frames in a single TTI

For 2 ms TTI case the transmitter was off 73% of the time when gating was applied

For 10 ms TTI cases the transmitter was off 72% and 67% of the time for 1.25 and for 1.67 average transmissions per packet respectively.

4.2.2.4.5 Impact of inactive users to cell throughput

Table 4.2.2.4.5-1: Further simulation parameters used in figures 4.2.2.4.5-1...3

| Parameter          | Value            | comments |
|--------------------|------------------|----------|
| Cell configuration | ITU Ped-A, Veh-A |          |

| Parameter                              | Value                                        | comments                                                                      |
|----------------------------------------|----------------------------------------------|-------------------------------------------------------------------------------|
| UE speed                               | Ped-A 3 kmph, Veh-A 30 kmph                  |                                                                               |
| Traffic model                          | Full buffer, no data                         | 6 full buffer users, rest with no data                                        |
| E-DCH Bitrate                          | {64, 128, 256, 384, 512, 1024} kbps          |                                                                               |
| DPCCH CIR target                       | -18.1 dB                                     |                                                                               |
| Load target                            | 6 dB                                         |                                                                               |
| DPCCH gating pattern for no-data users | {12, 9, 0} slots gated in every radio frame. | 0 gated slots equals to no gating.<br>Full buffer users transmit continuously |
| Other parameters                       | As in table 4.2.2.4-1                        |                                                                               |

In figures 4.2.2.4.5-1 and 4.2.2.4.5-2 the impact of large number of inactive users in CELL\_DCH on the cell throughput has been shown. An ideal reference curve for gating patterns has been calculated simply by scaling the continuous DPCCH curve with the gating-%.

Figure 4.2.2.4.5-3 shows the RoT overshoot probability for the same cases.

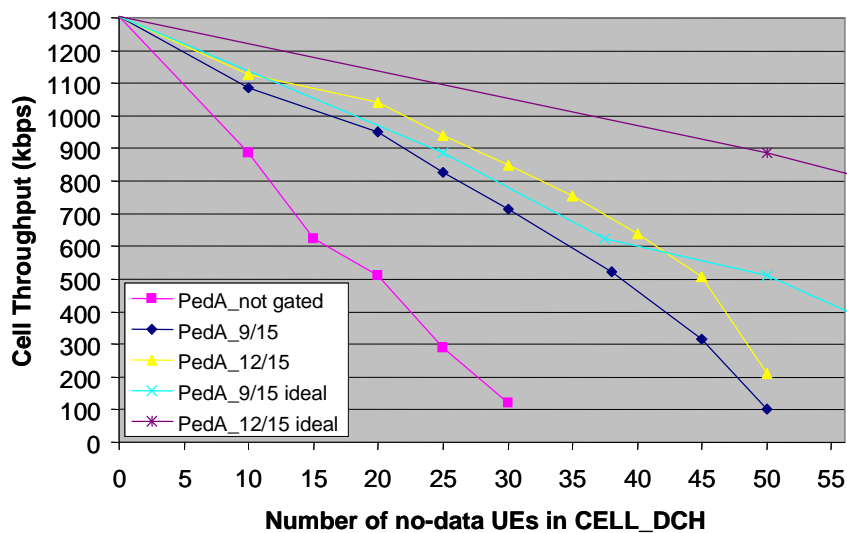

Figure 4.2.2.4.5-1: Cell throughput as a function of no-data users, different gating patterns vs. ideal gating, PA3

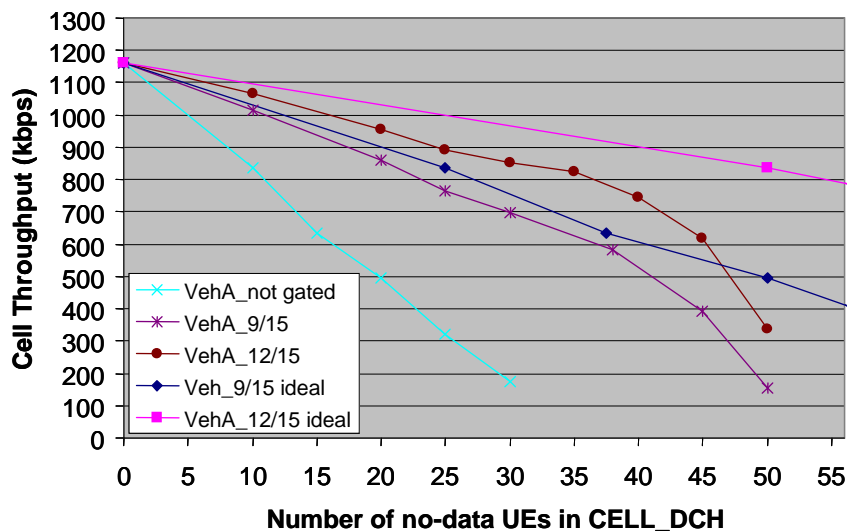

Figure 4.2.2.4.5-2: Cell throughput as a function of no-data users, different gating patterns vs. ideal gating, VA30

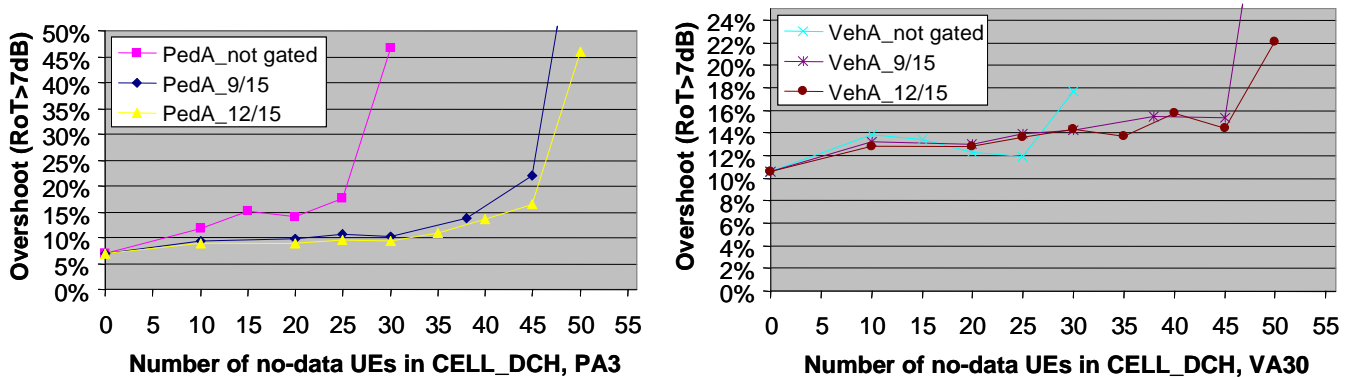

Figure 4.2.2.4.5-3: RoT Overshoot as a function of no-data users, different gating patterns and channel models

#### 4.2.2.4.6 System-level performance with high-velocity UEs

The simulated radio network consists of 12 three-sector sites (36 cells) with 1.5 km site-to-site distance deployed in an ordinary hexagonal layout. Wrap-around is used to prevent border effects. Standard models for distance attenuation ( $29+35*\log(d)$  where  $d$  is distance [m]), shadow fading (lognormal with standard deviation of 8 dB) and, multi-path fading (3GPP Typical Urban) are used.

A comprehensive WCDMA system model is used. The physical layer models, comprising quality models, measurement models and power control models, have slot-level time resolution. Hybrid ARQ with 8 parallel processes and Chase combining are included. An RLC protocol configured in unacknowledged mode is modeled in detail.

The speech codec is AMR12.2 and the speech activity is 50%, with on and off periods distributed exponentially.

Headers are compressed using RoHC (for VoIP) and we assume a constant state where the remaining header size is 3 bytes throughout the simulation. The scheduler is QoS-aware and determines priority based on delay (after a packet has arrived at the buffer). The total time for scheduling and HARQ retransmissions is maximum 100ms.

Some simulation parameters are given in Table 4.2.2.4.6-1.

**Table 4.2.2.4.6-1: Simulation parameters used in Figure 4.2.2.4.6-1**

| Parameter                         | Value                                           | comments                                                                 |
|-----------------------------------|-------------------------------------------------|--------------------------------------------------------------------------|
| Path loss Model: COST 231         | $-29.03 - 35.22 \cdot \log_{10}(d)$             |                                                                          |
| Shadowing standard deviation [dB] | 8                                               |                                                                          |
| Propagation Channel               | 3GPP Typical Urban                              |                                                                          |
| Number of cells                   | 36                                              |                                                                          |
| Cell layout                       | 3-Cell Clover Leaf                              |                                                                          |
| Inter-site Distance [m]           | 1500                                            |                                                                          |
| Frequency                         | 2 GHz                                           |                                                                          |
| EUL TTI length                    | 2 ms                                            |                                                                          |
| Receiver Type                     | RAKE                                            |                                                                          |
| Max UL HARQ attempts              | 5                                               |                                                                          |
| Max UL delay threshold            | 75 ms                                           |                                                                          |
| E-DPCCH                           | Fixed                                           |                                                                          |
| UL DPCCH CIR target               | -22 dB                                          |                                                                          |
| E-DPCCH power offset              | 0 dB                                            |                                                                          |
| E-DPDCH power offset              | 10 dB                                           |                                                                          |
| HS-DPCCH power offset             | 0 dB*                                           | *Sends every 5 <sup>th</sup> TTI for 3 km/h<br>Not modelled for 100 km/h |
| EUL Outer Loop                    | Not modelled                                    |                                                                          |
| Voice call mean length            | 30 seconds                                      |                                                                          |
| Voice on/off mean length          | 2 seconds                                       |                                                                          |
| RLC SDU size                      | 280 bits                                        | AMR12.2 + ROHC 3 bytes                                                   |
| UE velocity                       | 3 km/h (for all UEs)<br>100 km/h (for all UEs)* | *HS-DPCCH not modelled for 100 km/h case                                 |
| VoIP packet arrival interval      | 20 ms                                           |                                                                          |
| Voice activity                    | 50%                                             |                                                                          |
| Satisfied user single link        | Max 1% PLR @ 95%                                |                                                                          |

Figure 4.2.2.4.6-1 depicts the capacity gain with gating mechanism at the velocities 3 km/h and 100 km/h. The DPCCH update interval is set to every 8<sup>th</sup> TTI. A 3-slot DPCCH preamble is used before actual data is transmitted. Note that HS-DPCCH is not modeled here. **The relative capacity gain with gating is in the order of 80% for 3 km/h and in the order of 70% for 100 km/h.**

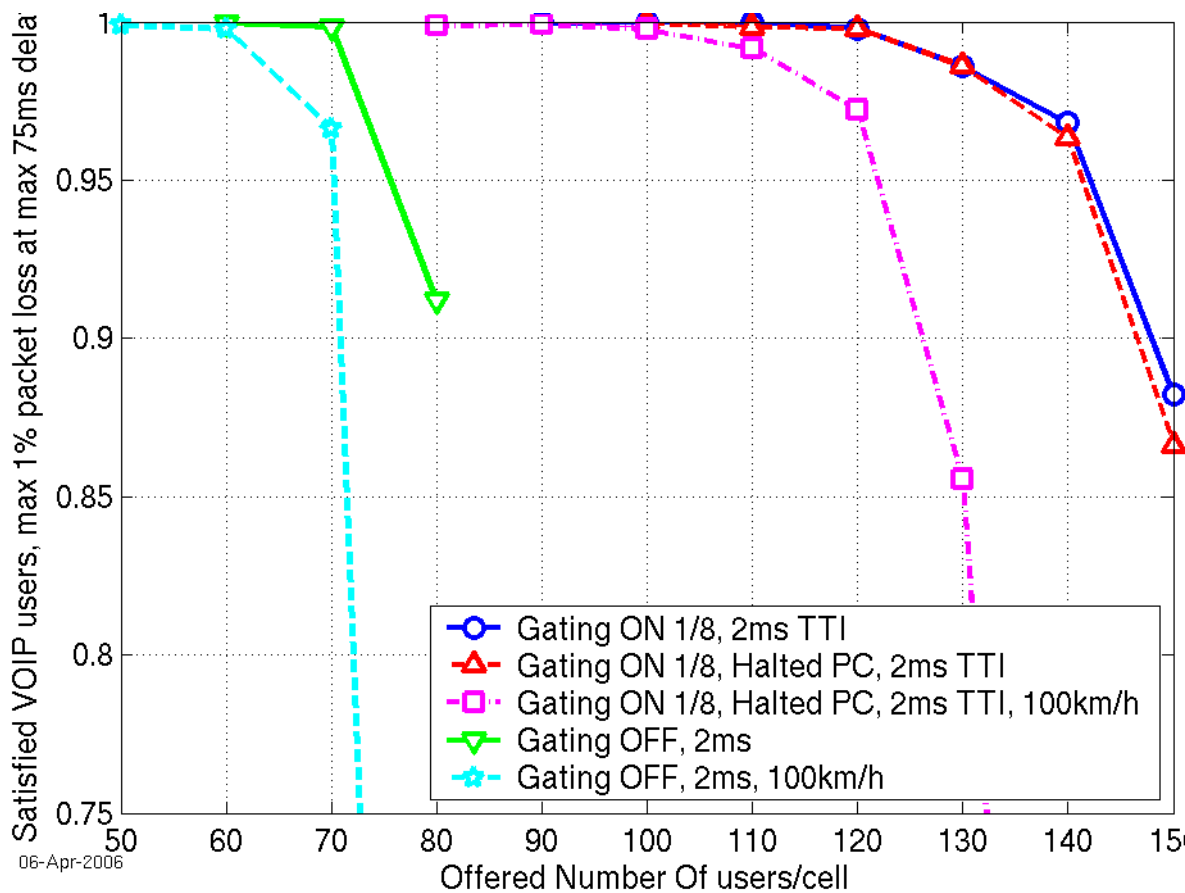

Figure 4.2.2.4.6-1: Capacity gain with gating. HS-DPCCH not modeled.

(The solid blue curve represents the capacity obtained with UL DPCCH gating if the UL TPC loop could be fully functional also during the gaps.)

#### 4.2.2.5 UE battery saving calculations

Following assumptions are used in the simplified UE power saving calculations.

1) The percentage of power saving of tx side and rx side, respectively, for certain tx power level, txpwr, when gating is not used:

- tx side consumes N1 mA @ txpwr
- rx side consumes N2 mA

No specific data rates were assumed here either in uplink or downlink, for simplification.

2) The tx side power consumption, if tx gating is used:

- tx side consumes N1\_gating mA, during gating @ txpwr

3) The rx side power consumption, if discontinuous reception possibility is utilised:

- rx side consumes N2\_gating mA, during gating

4) The savings for tx and rx parts power consumption:

$$Tx\_and\_Rx\_power\_saving = 1 - \frac{N1\_total\_new + N2\_total\_new}{N1 + N2}$$

where:

$$N1\_total\_new = (1-DPCCH\_gating\_%)*N1 + DPCCH\_gating\_%*N1\_gating$$

$$N2\_total\_new = (1-DRX\_%)*N2 + DRX\_%*N2\_gating$$

Tables 4.2.2.5-1, 4.2.2.5-2 and 4.2.2.5-3 show the UE tx and rx parts power saving for VoIP and inactive user (in CELL\_DCH) case, for assumptions N1 = 30%, 50% and 70% of the (N1+N2), respectively. Inactive user meaning user that is in CELL\_DCH state, but neither transmitting nor receiving any data. Thus the only difference in calculating the UE tx and rx parts power saving for VoIP with different TTI lengths and inactive user case, is the value used for DPCCH\_gating\_% value.

0% would mean no saving (same power consumption as with continuous transmission and reception) and 100% would mean that all power is saved and no power consumed.

**Table 4.2.2.5-1 UE tx and rx parts power saving due to UL DPCCH gating and discontinuous reception in the UE, with assumption of N1=30%\*(N1+N2).**

|                                | DPCCH_gating_%<br>(E-DCH inactivity) | DPCCH activity<br>during E-DCH<br>inactivity | DRX_% | UE tx and rx parts<br>power saving |
|--------------------------------|--------------------------------------|----------------------------------------------|-------|------------------------------------|
| VoIP 2ms TTI                   | 85 %                                 | 0%                                           | 0%    | 25%                                |
|                                |                                      |                                              | 20%   | 39%                                |
|                                |                                      |                                              | 60%   | 68%                                |
|                                |                                      |                                              | 80%   | 82%                                |
|                                |                                      | 10%                                          | 0%    | 22%                                |
|                                |                                      |                                              | 20%   | 36%                                |
|                                |                                      |                                              | 60%   | 65%                                |
|                                |                                      |                                              | 80%   | 78%                                |
| VoIP 10ms TTI                  | 80%                                  | 0%                                           | 0%    | 24%                                |
|                                |                                      |                                              | 20%   | 38%                                |
|                                |                                      |                                              | 50%   | 59%                                |
|                                |                                      |                                              | 80%   | 80%                                |
|                                |                                      | 10%                                          | 0%    | 21%                                |
|                                |                                      |                                              | 20%   | 35%                                |
|                                |                                      |                                              | 50%   | 56%                                |
|                                |                                      |                                              | 80%   | 77%                                |
| Inactive user<br>(in CELL_DCH) | 100 %                                | 10%                                          | 0%    | 27%                                |
|                                |                                      |                                              | 50%   | 62%                                |
|                                |                                      |                                              | 60%   | 69%                                |
|                                |                                      |                                              | 80%   | 83%                                |
|                                |                                      | 20%                                          | 0%    | 24%                                |
|                                |                                      |                                              | 50%   | 59%                                |
|                                |                                      |                                              | 60%   | 66%                                |
|                                |                                      |                                              | 80%   | 80%                                |



**Table 4.2.2.5-2 UE tx and rx parts power saving due to UL DPCCH gating and discontinuous reception in the UE, with assumption of  $N1=50\%*(N1+N2)$ .**

|                                | DPCCH_gating_%<br>(E-DCH inactivity) | DPCCH activity during E-DCH inactivity | DRX_% | UE tx and rx parts power saving |
|--------------------------------|--------------------------------------|----------------------------------------|-------|---------------------------------|
| VoIP 2ms TTI                   | 85 %                                 | 0%                                     | 0%    | 43%                             |
|                                |                                      |                                        | 20%   | 53%                             |
|                                |                                      |                                        | 60%   | 73%                             |
|                                |                                      |                                        | 80%   | 82%                             |
|                                |                                      | 10%                                    | 0%    | 38%                             |
|                                |                                      |                                        | 20%   | 47%                             |
|                                |                                      |                                        | 60%   | 68%                             |
|                                |                                      |                                        | 80%   | 77%                             |
| VoIP 10ms TTI                  | 80%                                  | 0%                                     | 0%    | 40%                             |
|                                |                                      |                                        | 20%   | 50%                             |
|                                |                                      |                                        | 50%   | 65%                             |
|                                |                                      |                                        | 80%   | 80%                             |
|                                |                                      | 10%                                    | 0%    | 35%                             |
|                                |                                      |                                        | 20%   | 45%                             |
|                                |                                      |                                        | 50%   | 60%                             |
|                                |                                      |                                        | 80%   | 75%                             |
| Inactive user<br>(in CELL_DCH) | 100 %                                | 10%                                    | 0%    | 45%                             |
|                                |                                      |                                        | 50%   | 70%                             |
|                                |                                      |                                        | 60%   | 75%                             |
|                                |                                      |                                        | 80%   | 85%                             |
|                                |                                      | 20%                                    | 0%    | 40%                             |
|                                |                                      |                                        | 50%   | 65%                             |
|                                |                                      |                                        | 60%   | 70%                             |
|                                |                                      |                                        | 80%   | 80%                             |

**Table 4.2.2.5-3 UE tx and rx parts power saving to UL DPCCH gating and discontinuous reception in the UE, with assumption of  $N1=70\%*(N1+N2)$ .**

|                                | DPCCH_gating_%<br>(E-DCH inactivity) | DPCCH activity during E-DCH inactivity | DRX_% | UE tx and rx parts power saving |
|--------------------------------|--------------------------------------|----------------------------------------|-------|---------------------------------|
| VoIP 2ms TTI                   | 85 %                                 | 0%                                     | 0%    | 60%                             |
|                                |                                      |                                        | 20%   | 66%                             |
|                                |                                      |                                        | 60%   | 77%                             |
|                                |                                      |                                        | 80%   | 83%                             |
|                                |                                      | 10%                                    | 0%    | 53%                             |
|                                |                                      |                                        | 20%   | 59%                             |
|                                |                                      |                                        | 60%   | 71%                             |
|                                |                                      |                                        | 80%   | 77%                             |
| VoIP 10ms TTI                  | 80%                                  | 0%                                     | 0%    | 56%                             |
|                                |                                      |                                        | 20%   | 62%                             |
|                                |                                      |                                        | 50%   | 71%                             |
|                                |                                      |                                        | 80%   | 80%                             |
|                                |                                      | 10%                                    | 0%    | 49%                             |
|                                |                                      |                                        | 20%   | 55%                             |
|                                |                                      |                                        | 50%   | 64%                             |
|                                |                                      |                                        | 80%   | 73%                             |
| Inactive user<br>(in CELL_DCH) | 100 %                                | 10%                                    | 0%    | 63%                             |
|                                |                                      |                                        | 50%   | 78%                             |
|                                |                                      |                                        | 60%   | 81%                             |
|                                |                                      |                                        | 80%   | 87%                             |
|                                |                                      | 20%                                    | 0%    | 56%                             |
|                                |                                      |                                        | 50%   | 71%                             |
|                                |                                      |                                        | 60%   | 74%                             |
|                                |                                      |                                        | 80%   | 80%                             |

### 4.2.3 Benefits of the concept

- Less air interface capacity consumption per UE due to reduced UL DPCCH and F-DPCH noise contribution and therefore also increased UE battery life time compared to REL-6.\*
- Compared to REL-6: Increased number of temporarily inactive users that can stay in CELL\_DCH and that can therefore get active in a very short time avoiding frequent transitions to CELL\_FACH.\*
- Concept is intended to address also VoIP users between packet transmissions.

\*: Better than for "SIR\_target reduction" the more UL DPCCH is gated.

### 4.2.4 Open issues of the concept

- Impact on inner loop power control in UL & DL.
- How often/when will UL DPCCH and F-DPCH be sent for inactive users (how are the activity patterns designed?) in order to maintain power control stability and synchronisation status.
- How is reactivation started and the UL DPCCH power set after each UL DPCCH and F-DPCH gating gap? Longer power ramping needed?
- Modifying the CQI reporting for HSDPA from Release 6 could enable higher gains for Uplink DPCCH Gating.
- DL & UL have to be inactive at the same time during UL DPCCH gating.
- Impact on power balancing mechanism. (Note: This is not an issue if TPC based power control is not applied to F-DPCH/DPCCH.)

## 4.3 SIR\_target reduction

### 4.3.1 Description of the concept

The proposed concept has the goal of substantially reducing the Tx power of the UL DPCCH (and thus, the generated noise rise) by reducing SIR\_target during idle traffic periods, i.e. when nothing needs to be transmitted in UL on the E-DPDCH.

It is an important characteristic of the concept that these changes do not involve the RNC, so that the long delays of RRC or NBAP procedures (>> 100ms) are avoided and the user is staying in CELL\_DCH state.

The "SIR\_target reduction" could be carried out by e.g.:

- L1 signalling: Serving Node B controls when a UE is going into an inactive phase with a lower SIR\_target and corresponding L1 signalling is used to trigger deactivation & reactivation.
- L2 signalling: The UE controls by L2 MAC-e signalling when the SIR\_target in the NodeBs of the active RLS is reduced, i.e. deactivation & reactivation.
- Predefined/configured rules: Serving NodeB detects inactivity and activity based on pre-defined or configured rules and reduces the SIR target by a pre-defined or configured offset during periods of inactivity.

#### 4.3.1.1 L1 signalling approach

##### **Traffic inactivity detection:**

The absence of data to be transmitted on E-DCH in the UL can be detected by observing the current occupation of the MAC-e buffer which is known by the MAC-e scheduler in the Node B through scheduling information received from the UE. A deactivation start timer/timeout (starting when a buffer runs empty) can be used to avoid unnecessary switching between active and inactive mode during very short traffic intermissions.

**SIR\_target reduction:**

When detecting the inactivity condition in the UL, the serving Node B reduces the target SIR for the UL power control from the last RNC-configured value to a pre-determined target value (for reliable TPC detection). The inner loop power control for the uplink will automatically reduce the Tx power of the UE on the UL DPCCH (by a sequence of 'power down' steps) to adjust to the new target. This autonomous reduction of the SIR target is not in conflict with the outer loop power control of the SRNC, as the transmitted power will not be permitted to become higher than the RNC-configured value. In the following text such a phase of reduced Tx power on UL DPCCH during the inactive traffic phase is also called 'reduced power mode'.

The serving Node B informs the UE about the change by physical layer signalling. This can be implemented as a new signalling message on the HS-SCCH, using one of the 8 unused bit combinations within the 7 bits assigned to the channelization code set.

The SIR\_target reduction with L1 signalling is considered applicable even when a transmission on HSDPA is still active (and therefore the transmission of the HS-DPCCH takes place). To assure the reliable operation of HSDPA after the SIR\_target reduction, a mechanism to compensate the UL DPCCH TX power lowering should be introduced. The application of a power offset on HS-DPCCH is analyzed for non-SHO and for CQI reports in section 4.3.2.6.x. An application of a power offset on UL DPCCH is ffs.

One of the methods to inform UE about HS-DPCCH power offset to DPCCH value change is to utilize HS-SCCH signalling. In this approach the Node B has the possibility to send the new and exact value of the power offset to the UE. This procedure will assure a reliable transmission on the HS-DPCCH while applying the SIR\_target reduction concept to DPCCH.

**Triggering reactivation:**

When a UE is in a 'reduced power mode' a reactivation is triggered by the arrival of new data in the MAC queue. New data for UL in the MAC-e buffer will first be detected in the UE and must be brought to the attention of the serving Node B. 2 alternatives are (preference for the second):

1. HARQ with possible UL power offset:

The UE immediately transmits a MAC-e PDU as it would do in the normal E-DCH configuration. Note that the E-DPCCH and E-DPDCH are transmitted with a given power offset from the DPCCH power, and will therefore be power-reduced, when the DPCCH is power-reduced. As a mere trigger for reactivation it is, however, not necessary that the initial transmission can be correctly detected in the receiving Node B. It is sufficient that signal presence is recognized by the Node B at all, since this would trigger the Node B to restore the usual UL power control and the corresponding HARQ would avoid any loss of data.

For even better robustness of this reactivation trigger a power offset could be applied for the first transmission on E-DPCCH and E-DPDCH at the end of the 'reduced power mode'. This would give the first MAC-e PDU a fair chance to be correctly decoded, in which case no reactivation delay would occur at all.

2. Reactivation signal on E-DPCCH:

Another option is that the UEs are not allowed to transmit E-DPDCH and E-DPCCH in 'reduced power mode' at all, except for a reactivation signal on the E-DPCCH. For instance, the UE just sets the 'Happy Bit', or it transmits a predefined 10-bit sequence on the entire E-DPCCH. The Node B restores the SIR target and initiates the reactivation via HS-SCCH signalling. Such a trigger via E-DPCCH would be very easy and reliable to detect (if required, a power offset as aforementioned could also be applied). As soon as the UE receives the HS-SCCH confirmation from the Node B (will take less than 10ms) the UE returns back to normal operation.

**Restoring normal power control for data transmission:**

When the serving Node B recognizes a new transmission on E-DPCCH and/or E-DPDCH from the UE in 'reduced power mode', it starts the reactivation by resetting the target SIR for the UL power control to the last RNC-configured value. The inner loop PC will automatically re-adjust the Tx power on the UL DPCCH to the new target within a few time slots.

Depending on the considered reactivation improvements (see Triggering reactivation above), the Node B will also send a reactivation message to the UE (via HS-SCCH), and the UE will restart regular transmissions.

Retransmission(s) of the first packet, and possible transmissions of subsequent (non-scheduled) MAC-e PDUs will be automatically executed by the normal HARQ and E-DCH protocols in the UE and serving Node B. Depending on the TTI length, it may take one (for 10ms TTI) or a few TTIs (for 2ms TTI) before the power control has settled on the normal level (if no power offset is applied). In such a case the Node B may delay large rate grants to the UE, until the

received signal power has reached the target SIR, in order to avoid early erroneous transmission of large scheduled PDUs.

#### 4.3.1.1.1 Interworking aspects

##### Cell changes and Soft Handover:

Measurement reports from the UE and RNC-triggered signalling of changes in the active set and changes of the serving Node B will be transmitted on SRB over E-DCH and HS-DSCH, and thereby trigger reactivation. Therefore the highest gain of this concept is achieved when the reporting interval of such mobility measurements is well above the timeout parameter that triggers the deactivation.

SHO may be applied on UL DPCCH. Nevertheless, either the serving cell will dominate the UL power control due to the SIR target reduction or a change of the serving cell will be initiated by the RNC in the normal way (i.e. as in the current specifications) and trigger a reactivation of the UE.

In case of SHO, the radio links of non-serving NodeBs would not reduce their SIR target (as done in the serving NodeB) and these radio links might cause a RL FAILURE. As a RL\_FAILURE report will not occur before T\_RLFAILURE timer has elapsed (ranged from around 10ms to 28 sec), this problem occurs only for longer inactivity periods than T\_RLFAILURE setting, which is configured by RNC. For such cases the following options are considered to address the problem:

- (A) The SIR target during the reduced power mode is periodically boosted in the serving Node B to a pre-determined value (less than or equal to a 'normal' SIR target) in order to achieve sufficient in-sync indications of radio links from non-serving NodeBs and to avoid RL FAILURE indications. The length of these temporary boosting periods (e.g. a few radio frames) and the periodicity (e.g. similar value to "T\_RLFAILURE" setting) of the temporary boosting periods is indicated by RNC. The ranges of those parameters as well as the definition of the boosted SIR target are FFS.
- (B) RNC is allowed to set a limit of the lowered SIR target (minimum SIR target) and NodeB can decide about the value of the lowered SIR target in the range between the minimum SIR\_target and the 'normal' SIR target. With the setting of a minimum SIR target, the RL\_FAILURE probability from non-serving NodeB can be reduced. As a special setting for SHO, the minimum SIR target could be set to the normal target SIR, which means that RNC could restrict the applicability of the SIR target reduction for SHO. The definition of a limit set by RNC is FFS.
- (C) RNC could ignore RL\_FAILURE from non-serving NodeB(s) when the RL\_FAILURE is assumed to be triggered due to the SIR target reduction by serving NodeB. The RNC could decide this based on the information available at the RNC such as Node B and UE ability to apply CPC mode, whether the considered UE is in SHO or not, whether the link(s) of the serving Node B have no RL FAILURE and UL/DL traffic activity of the UE. Note that although the radio link(s) for non-serving NodeB can be maintained by ignoring RL\_FAILURE, the radio link may be kept in out-of-sync state at non-serving NodeB.

##### Reporting power gains to RNC:

As it is the goal of the proposed concept to allow more users to get and remain connected (without the need for intermediate RRC state switching), it is necessary that the RNC is made aware of the savings in the received noise rise, so that these can be taken into account in decisions e.g. for call admission and RRC state switching. These gains will, however, automatically be reflected in the measurements of "total received wideband power", which are periodically reported from Node B to CRNC, anyway. Thus, no changes to the standard measurement reporting are required for this purpose.

#### 4.3.1.1.2 Handling of VoIP traffic

VoIP traffic in UL is assumed to follow a predictable pattern of voice packets and silence descriptors (SID) and also the timing of HARQ retransmissions is under control of the Node B.

By setting a standard rule that the UL DPCCH SIR\_target reduction is applied in the Node B between voice packets, between SIDs, as well as between voice packets and SIDs, the same SIR\_target reduction scheme as in section 4.3.1.1 can be applied for VoIP services but with a reduced L1 signalling.

Note: For HARQ retransmissions the SIR\_target would also be set back to normal as for voice packets and SIDs.

Only for restarting VoIP transmissions at the UE after longer speech pauses L1 signalling in form of an E-DPCCH sequence would be used which would be confirmed by HS-SCCH signalling from the Node B.

For the case that DL is active and UL is temporarily inactive a power offset on HS-DPCCH and/or DPCCH might be applied to compensate for SIR\_target reduction. The details of this power offset application are ffs."

Parallel smaller unscheduled transmissions like SRBs should be started directly before or after a voice packet or a SID where SIR\_target is almost unchanged.

For other packet traffic in addition to VoIP the SIR\_target reduction as described above would only be applied by the Node B if this other packet traffic is inactive, i.e. if no packets for the other packet traffic are transmitted.

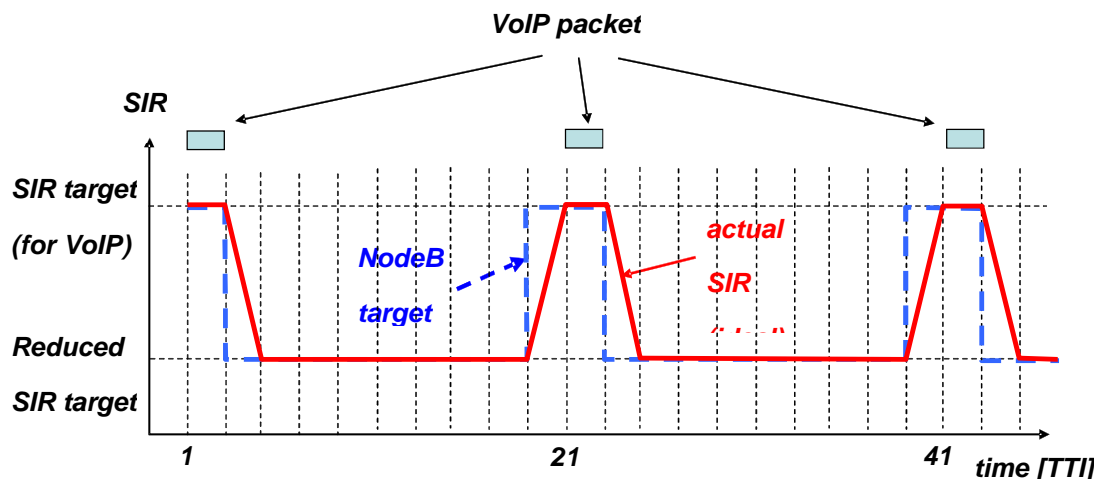

Figure 4.3.1.1.2-1 Illustration of an ideal SIR\_target reduction profile for VoIP packets every 20ms (HARQ retransmission and inactive phases with SIDs are not shown in this example)

#### 4.3.1.2 L2 signalling approach

##### Traffic inactivity detection:

The UE detects autonomously the conditions for a transition into the idle traffic mode, i.e. inactivity in the UL. The conditions for a transition into the idle traffic mode could involve no activity for a certain minimum period of time in UL (and DL).

When the UE has detected a transition from active mode into "idle traffic mode" or vice versa, it can instantaneously apply the corresponding power control parameters with respect to DPC\_MODE and power control stepsize (see below). The NodeBs in the active RLS need to be notified by the UE of the idle traffic mode so that the NodeBs can operate with the changed parameter settings in this mode, i.e. changed inner loop power control parameters with respect to SIR target and DPC\_MODE and power control stepsize.

The UE will inform the NodeBs about a change from active mode into idle traffic mode and vice versa by means of a short MAC-e PDU consisting of scheduling information (SI). For the change from active mode into idle traffic mode, a specific SI reserved for that purpose is transmitted and repeated through HARQ retransmissions until all NodeBs in serving and non-serving RLS have acknowledged receipt of the transition or the maximum number of transmissions is reached.

##### SIR\_target reduction:

Upon transition of the UE into the idle traffic mode, the target SIR in the Node Bs of the active RLS for the UL power control is reduced from the last RNC-configured value to a pre-determined target value (for reliable TPC detection).

The inner loop power control for the uplink will automatically reduce the Tx power of the UE on the UL DPCCH (by a sequence of 'power down' steps) to adjust to the new target SIR.

The robustness of the connection with a particular UE in idle traffic mode can be improved as follows:

- a) The UE modifies its UL power control by applying a higher step size when receiving a 'power up' TPC command on the DL DPCCH. This will keep the power control more stable when the error rate on the UL DPCCH increases.
- b) The UE uses DPC\_MODE=1, i.e. the TPC commands on the UL DPCCH (for the downlink) are repeated in 3 successive timeslots. This achieves higher detection reliability in the Node B at the expense of a slower power adjustment to match changing channel conditions, which is assumed to be acceptable during idle traffic periods. The resulting reduction in the rate for forward link power control of the F-DPCH (from 1500 Hz down to 500 Hz) is not considered to be crucial.

When the NodeB has detected a transition from active mode into "idle traffic mode" or vice versa, it can instantaneously apply the corresponding power control parameters with respect to SIR target and DPC\_MODE and continue.

#### Triggering reactivation:

When the UE is in idle traffic mode, it is required that the NodeB watches for a reactivation of the UE, i.e. a transition from idle traffic mode into the active mode.

The UE can trigger autonomously the reactivation when data is to be transmitted in the uplink. For the change from idle traffic mode into active mode, the actual SI is transmitted and repeated through HARQ retransmissions until all NodeBs in serving and non-serving RLS have acknowledged receipt of the transition.

For a reliable transmission of the SI while the UE is still in the idle traffic mode, the UE could temporarily increase the DPCCH power (and, hence, also the E-DCH power) in an open loop power adjustment for the time of the SI transmission.

#### Specific L2 signalling aspects:

The reserved MAC-e SI for indicating a transition can have its own HARQ profile with an additional power offset to ensure reliable detection by all NodeBs in the active set with reasonable latency. The SI word specific for the transition from active mode into idle traffic mode conveys UE buffer occupancy of 0 (9 bits), maximum possible power ratio versus DPCCH (5 bits) and a pre-defined logical channel ID (4 bits). While a pre-defined logical channel ID is given in the SI word specific for the transition from active mode into idle traffic mode, it may be noted that the transition is valid for all logical channel IDs.

#### 4.3.1.2.1 New parameters for L2 signalling approach

| Parameter                                | Description                                                                                                                                                                                           |
|------------------------------------------|-------------------------------------------------------------------------------------------------------------------------------------------------------------------------------------------------------|
| Inactivity time                          | minimum time of inactivity on UL and DL before the UE can trigger a transition into the idle traffic mode                                                                                             |
| Power offset                             | 1) difference in Target SIR between active and idle traffic mode<br>2) UE open loop power adjustment for the transmission of the SI for triggering a transition from idle traffic mode to active mode |
| SI for transition into idle traffic mode | Dedicated and reserved SI that is only used to signal the transition into the idle traffic mode                                                                                                       |

#### 4.3.1.3 Approach with predefined/configured rules

Instead of relying on signalling, predefined (and standardized) rules can be used to control the UE and Node B behaviour, i.e., the UE and Node B could by applying these rules have a consistent view of whether 'normal' or 'reduced' activity transmission should be used.

In uplink, the (serving) Node B will notice whether the UE is transmitting any data in the uplink or not. When the UE has not transmitted any data within a predefined time interval  $\Delta T$ , the (serving) Node B can estimate that the UE has no

data in the buffer and lower the SIR target by  $z$  dB in the power control loop to reduce the interference from that UE. In order to reach the lower, more efficient SIR level faster, the UE could simultaneously apply a negative power offset  $w_1$  (possibly but not necessarily equal to  $-z$  dB) to its transmission.

Note: In the special case that the transmission follows an entirely predictable pattern, which might be the case for VoIP traffic (this is FFS),  $\Delta T$  could be set to zero, resulting in an immediate SIR target reduction after each VoIP packet.

If data enters the UE buffer when the SIR target is lowered, the UE will according to the current specification transmit scheduling information in the uplink. A power offset  $w_2$  can be used for the transmission of uplink scheduling information to compensate for the lowered SIR target. This is possible already in Rel6 using the HARQ profiles.

Note: The need for Node B receiver resources could be reduced. Methods are FFS; see e.g. Tdoc R1-051448, 'Opportunities for resource saving in the Node B receiver'.

The Node B will detect the presence of scheduling information after one or a few HARQ retransmissions (if the power offset  $w_2$  is appropriately set, the first attempt is likely to succeed). Once the Node B detects the presence of the scheduling information, the SIR target is restored to its normal level and the inner power control loop will ensure that the UE after a couple of slots has adjusted its transmission power to meet the target.

Note: In the special case that the transmission follows an entirely predictable pattern, which might be the case for VoIP traffic (this is FFS), the Node B knows when to restore the SIR target without detecting the presence of scheduling information.

The SIR\_target reduction is considered applicable even when a transmission on HSDPA is still active (and therefore the transmission of the HS-DPCCH takes place). To assure the reliable operation of HSDPA after the SIR\_target reduction, a mechanism to compensate the UL DPCCH TX power lowering should be introduced. The introduction of a new power offset for DPCCH and/or HS-DPCCH is FFS.

For example, the SIR level could be temporarily restored during the transmission of a CQI report (possibly also during a few slots before the CQI report for e.g. improved channel estimation). Thus, when the CQI reporting pattern dictates that the UE should transmit a CQI and that Node B should receive a CQI, the UE could apply a positive power offset to its transmission and Node B could apply the same offset to its SIR target.

The ways of handling cell changes and soft handover described for the L1 signalling approach in sub-clause 4.3.1.1.1 are equally applicable for the approach with predefined/configured rules.

To implement the above mechanisms, higher layer signalling between the RNC and the UE is required to configure the time interval  $\Delta T$  and the power offsets  $w_1$  and  $w_2$ . This signalling typically only takes place once at call setup and thus does not lead to a significant increase in interference. Signalling is also required between the RNC and Node B to configure the SIR target reduction  $z$ .

## 4.3.2 Analysis of the concept

### 4.3.2.1 Simulation of the concept

The aim of this analysis is to show to which value the SIR target of the UL DPCCH can be reduced during the inactivity phase without losing the stability of the inner loop power control (IL PC).

Reducing the SIR target for the UL in the Node B could make the reception of the power control commands (TPC) on the UL DPCCH more erroneous, which in turn could make the DL power control less reliable. Therefore the reception of the TPC on the F-DPCH may be more erroneous, requiring extra downlink power. Thus, the criterion to identify the maximum UL SIR target reduction is given by the increase of DL power per F-DPCH, required to maintain a desired F-DPCH TPC error rate (4% is usually considered).

Furthermore the simulation results show the expected time required to ramp up the UL DPCCH power to the initial SIR target when detecting the user activity.

#### 4.3.2.1.1 Simulation assumptions

The assumed channels are: AWGN, Vehicular A at 3km/h, 30km/h and 120km/h and a Rayleigh channel with one path at 3km/h. All the considered channels are at the carrier frequency of 2GHz and channel estimation is applied in the receiver.

The power control timing follows the 25.214 v6.7.0 Annex B, operation with F-DPCH. It is assumed that the UE is able to react to a TPC command with a power adjustment in the immediate next slot and the Node B reacts with an extra slot delay (it is assumed here that the F-DPCH is used in the DL). It is also assumed that the UE and Node B are capable of generating a TPC command in the immediate next slot (in UL/DL) according to the SIR measurements of the previous slot in the DL or UL, respectively.

The simulation assumption for UL and DL are listed in Table 4.3.2.1.1-1 and 4.3.2.1.1-2 respectively.

**Table 4.3.2.1.1-1 Uplink simulation assumptions**

| Parameter                                                   | Value                                            |
|-------------------------------------------------------------|--------------------------------------------------|
| DPCCH_Ec_MAX – maximum transmitted DPCCH energy per PN chip | Not limited                                      |
| DPCCH_Ec_MIN – minimum transmitted DPCCH energy per PN chip | Not limited                                      |
| Slot format                                                 | 2 TPC bits, 8 Pilot bits-(slot format 1), SF 256 |
| Inner loop PC                                               | On, minimum delay 1 slot (PC algorithm 1)        |
| Inner loop PC range                                         | Not limited                                      |
| Inner loop PC step size                                     | 1dB                                              |
| Outer loop PC                                               | Off                                              |
| RX diversity                                                | Reception with two antennas                      |
| Channel estimation                                          | From dedicated pilots                            |

**Table 4.3.2.1.1-2 Downlink simulation assumptions**

| Parameter                                                   | Value                                  |
|-------------------------------------------------------------|----------------------------------------|
| geometry                                                    | 3dB                                    |
| I <sub>OR</sub> – cell total transmit power                 | 43dBm                                  |
| DPCH_Ec_MAX - maximum transmitted F-DPCH energy per PN chip | 30dBm                                  |
| DPCH_Ec_MIN - minimum transmitted F-DPCH energy per PN chip | 5dBm                                   |
| Slot format                                                 | F-DPCH - 2 TPC bits, SF 256            |
| Inner loop PC                                               | On, minimum delay 2 slots (DPC_MODE 0) |
| Inner loop PC range                                         | 25dB                                   |
| Inner loop PC step size                                     | 1dB                                    |
| TPC error rate target                                       | 4%                                     |
| Outer loop PC                                               | On (based on DL TPC errors)            |
| Outer loop PC step size                                     | 0.3dB                                  |
| Outer loop PC frequency                                     | 100Hz                                  |
| Channel estimation                                          | From CPICH                             |

#### 4.3.2.1.2 Simulation results

From Figure 4.3.2.1.2-1 which shows F-DPCH\_Ec/I<sub>or</sub> vs. the UL DPCCH SIR target it can be seen that when lowering the UL DPCCH SIR target down to -5dB, the transmitted F-DPCH energy per PN chip required to maintain the DL TPC error rate at 4% increases by a very small amount (<0.6dB) in presence of different propagation conditions and channel estimation. This means that despite of UL TPC errors of about 15% (for flat fading, AWGN – Figure 4.3.2.1.2-2) and 20% (for Veh A3, Veh A30 – Figure 4.3.2.1.2-2) the DL inner loop power control is kept stable although the SIR target for the UL DPCCH is reduced. The SIR\_target before applying a reduction depends on the considered type of service. The higher the data rate of the service the higher the SIR\_target and the larger can be the SIR\_target reduction. So for higher data rates (SIR\_target >0dB) SIR\_target reductions of even more than 6dB are possible.



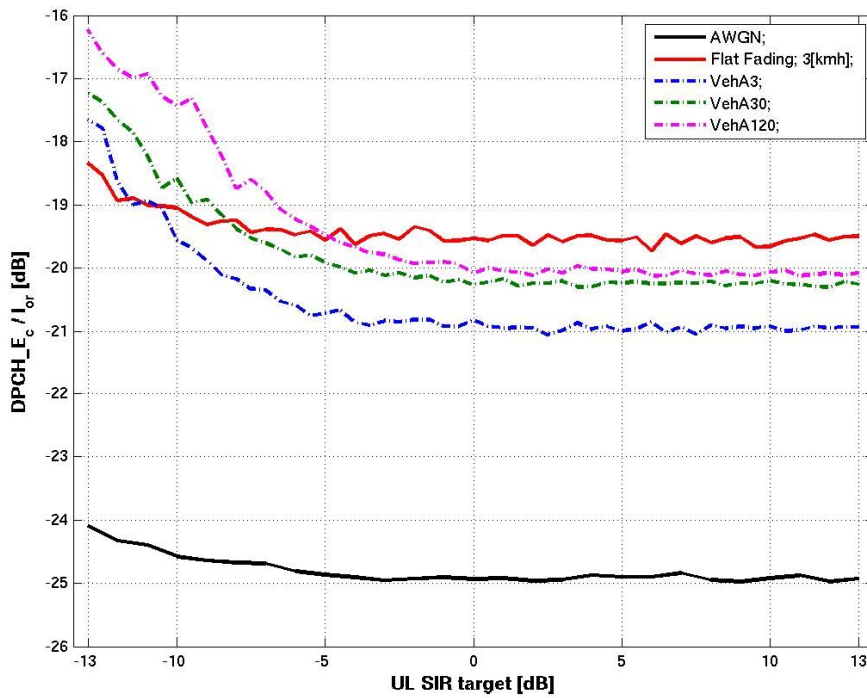

Figure 4.3.2.1.2-1 DL F-DPCH\_Ec/I\_0R vs. UL DPCCH SIR target

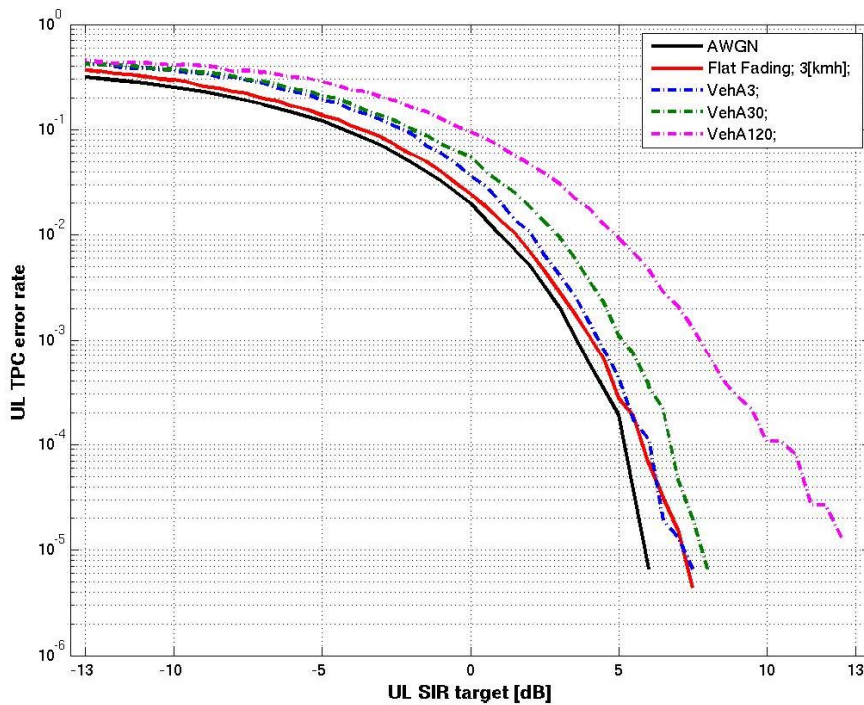

Figure 4.3.2.1.2-2 UL TPC error rate vs. UL DPCCH SIR target

The simulation result depicted in Figure 4.3.2.1.2-3 shows that the UL DPCCH ramp up time, when restoring the UL SIR target lowered to -3dB, is on average well below 12ms (depending on the initial UL SIR target). For realistic UL SIR target reductions (e.g. about 6dB) it can be assumed that this ramp up is finalized well before the first HARQ retransmission. This means that the considered requirement for the reactivation delay (lower than 50ms) can be fulfilled.

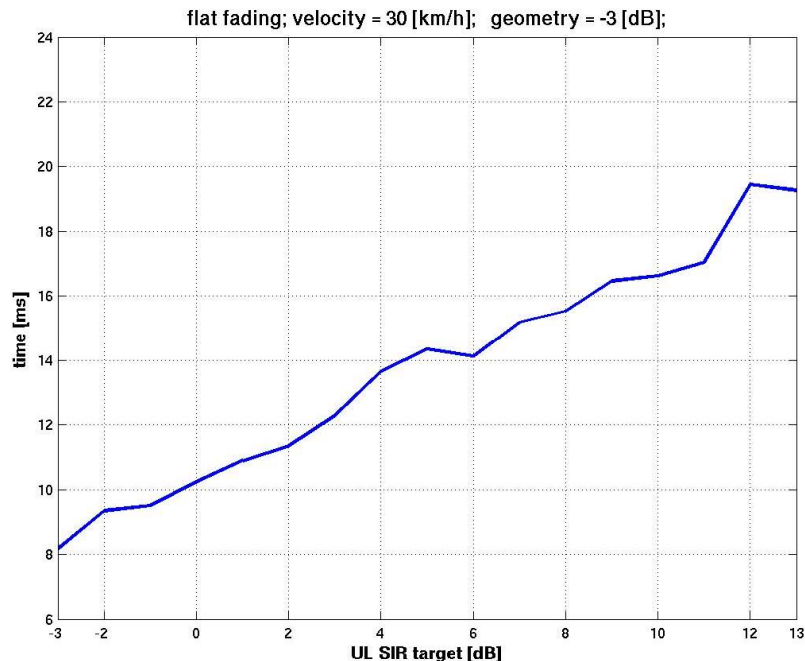

Figure 4.3.2.1.2-3 Reactivation time vs. initial UL DPCCH SIR target

#### 4.3.2.2 Noise rise caused by UL DPCCH

The goal of this section is to assess the portion of the UL noise rise due to the UL DPCCH in typical E-DCH configurations.

The analysis is based on the recent E-DPDCH demodulation performance tests, introduced in RAN4 (see e.g. R4-050547). The results include the total receiver  $E_c/N_0$  (including DPCCH, E-DPDCH and E-DPCCH), required to achieve 70% of the maximum bit rate for a number of fixed reference channels (FRCs). This corresponds to BLER of 30%.

Table 4.3.2.2-1 shows SIR target for UL DPCCH for each FRC and the value  $p$  which is the percentage of own cell noise rise which is caused by one user's UL DPCCH.  $p$  is calculated for two usually considered RoT budgets: 3dB and 6dB, what corresponds to the 50% and 75% of the pole capacity.

The following can be observed:

- The tendency is for  $p$  to increase as throughput increases.
- The DPCCH uses between about 0.8% and 4.6% of the UL resources, depending on FRC and RoT budget.

**Table 4.3.2.2-1 Numerical results for  $p$  (=UL noise rise percentage per UL DPCCH) and SIR target for different fixed reference channels (FRC), which are to be defined in TS 25.104.**

| FRC#                                        | 1      | 2      | 3      | 4     | 5     | 6      | 7     |
|---------------------------------------------|--------|--------|--------|-------|-------|--------|-------|
| max. bit rate [kbps]                        | 1353.0 | 2706.0 | 4059.0 | 507.6 | 979.8 | 1959.6 | 69.0  |
| results for 70% of max. bit rate (30% BLER) |        |        |        |       |       |        |       |
| total $E_c/N_0$ [dB]                        | -4.7   | -1.5   | -0.2   | -9.7  | -7.3  | -4.4   | -18.1 |
| SIR_DPCCH [dB]                              | 9.7    | 11.9   | 12.8   | 7.6   | 7.4   | 9.4    | 1.2   |
| $p$ [%] for 3dB noise rise                  | 3.72   | 4.44   | 4.62   | 2.97  | 2.56  | 3.38   | 0.78  |
| $p$ [%] for 6dB noise rise                  | 2.48   | 2.96   | 3.08   | 1.98  | 1.70  | 2.26   | 0.52  |

### 4.3.2.3 Potential gain in terms of number of additional users & UL noise rise

The potential gain that can be achieved by a power reduction of the uplink control channels for inactive users can best be measured by the number of inactive user connections that can be maintained within a fixed fraction of the allowed noise rise. This fraction must be small, as it limits the resources available for user data transmission, but it also must be large enough to accommodate a sufficient number of temporarily inactive users that can be quickly scheduled when resources become free.

Example scenario: 5 active users and a control channel configuration with 1% of the max. allowed noise rise per UL DPCCH, plus 0.67% per HS-DPCCH at full CQI rate. These 5 active users will occupy 8.35% (= 5 x 1.67%) of the noise rise budget with their uplink control channels and thus, would have a maximum of 91.65% available for data traffic – if no inactive users were allowed.

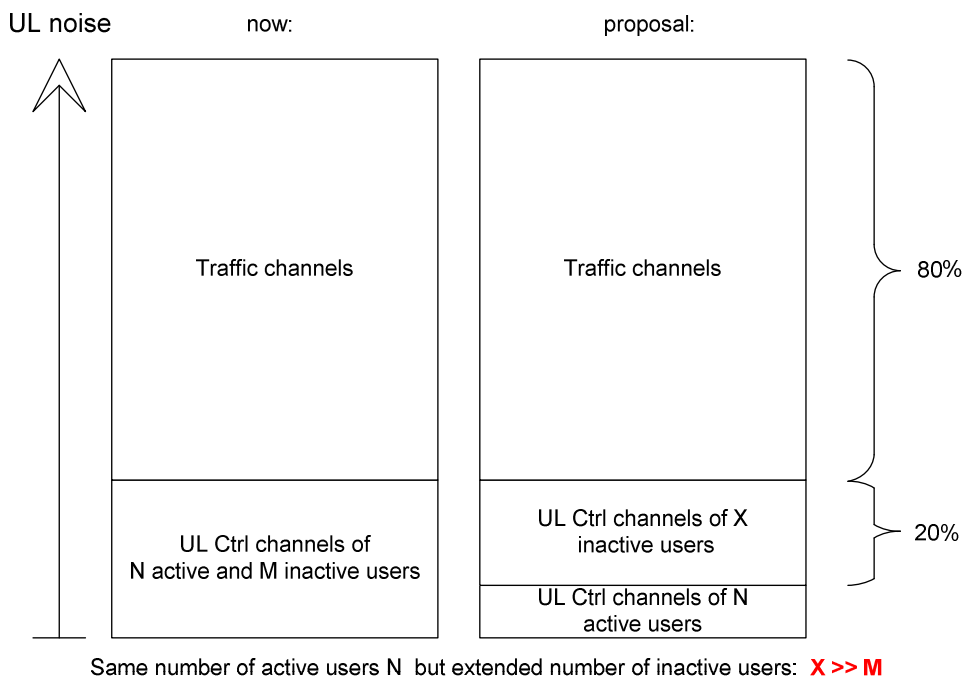

**Figure 4.3.2.3-1 UL noise situation with the current standard (now) and with the proposed scheme assuming a limited UL noise for control (Ctrl) channels**

In the reference scenario (see Figure 4.3.2.3-1) it is assumed, that 20% of these traffic resources (i.e.  $20\% \times 91,65\% = 18,33\%$  of the max. allowed noise rise) are reserved for uplink control channels of additional inactive users. This would allow for a maximum of 11 ( $18,33\% / 1,67\%$ ) inactive users with CQI reporting per 2ms TTI.

By reducing the control channel power for these inactive users, a substantially larger number of inactive users can be supported with the same amount of resources, i.e. without degrading the maximum total throughput of the 5 active users.

In case of an SIR target reduction by 6dB, the number of inactive users that can be supported within the given noise rise budget increases from 11 to 44, i.e. by a factor of 4. In a more conservative scenario – SIR target reduction by 4.5dB and a CQI reporting cycle of 4 TTIs – the number of inactive users can still be increased from 16 to 44, i.e. a gain factor of 2.75.

#### 4.3.2.4 Reactivation delay

Although the first transmission after reactivation is much faster with this concept than it would be considering an RRC state change, it includes a small reactivation delay compared to an always active user (note: Due to the UL noise rise limitation the number of the active users is limited.)

A simple analysis shows that this additional delay (before normal scheduling and transmission behavior of E-DCH or HS-DSCH applies) is well below 50 ms even in the worst case, when the extra retransmission is needed.

The time for uplink reactivation comprises the transmission of the initial MAC-e PDU or E-DPCCH trigger signal, the transmission of the reactivation message on HS-SCCH, the power ramping to the original target SIR at the Node B, and the time for the first transmission (or retransmission) at the full power level.

In the worst case (10 ms EDCH TTI), the total delay is dominated by the HARQ cycle, which allows a retransmission only after 40 ms. The HS-SCCH signalling message and the subsequent power ramping takes only a few power control slots and will therefore be finished well before the retransmission time.

With the 2 ms EDCH TTI, the HARQ retransmission cycle is only 16 ms, thus the reactivation can be achieved much faster.

#### 4.3.2.5 Signalling load

Considering the L1 signalling approach:

- the HS-SCCH capacity of 500 messages per sec (1 every 2ms),
- the fact that a UE has to be able to read 4 HS-SCCHs in parallel,
- the case that one HS-SCCH message would be used for deactivation and a second HS-SCCH message would be used for reactivation,
- an average inactivity period of 5sec,

even a high number of inactive users (e.g. 80) would have only a smaller impact on the HS-SCCH signalling load ( $80 \times (2 \text{ msg}/5\text{sec}) / (2000\text{msg}/\text{sec}) = 1,6\%$ ).

#### 4.3.2.6 CQI Performance for boosting HS-DPCCH power offset to DPCCH

This section presents some CQI over the HS-DPCCH link level results in non-SHO, and further discusses the feasibility of beta boosting and the possibility to keep the HSDPA downlink active during SIR target reduction.

##### 4.3.2.6.1 Simulations assumptions

Table 4.3.2.6.1-1 lists the most important simulations conditions of the evaluation. In the simulation the SIR target is swept and, the CQI error rate is examined for various HS-DPCCH power offsets to the DPCCH. The SIR target is the operation point of uplink inner loop power control [6], inner loop power control uses SIR measurements as per [7].

**Table 4.3.2.6.1-1 Simulation assumption**

| Parameter                       | Value                                                                               |
|---------------------------------|-------------------------------------------------------------------------------------|
| SIR target                      | Variable                                                                            |
| $A_{hs} = \beta_{hs} / \beta_c$ | 15/15, 24/15, 30/15 – this gives HS-DPCCH power offset to DPCCH of 0 dB, 4 dB, 6 dB |
| $N_{cqi\_transmit}$             | 1 (i.e. no repetition)                                                              |
| CQI reporting interval          | 2 ms                                                                                |
| Slot format                     | 2 TPC bits, 8 Pilot bits, SF 256                                                    |
| Channel estimation              | Real, TPC-aided                                                                     |
| Inner loop PC                   | On, minimum delay 1 slot (PC algorithm 1)                                           |
| Inner loop PC step size         | 1dB                                                                                 |
| Outer loop PC                   | Off                                                                                 |
| RX diversity                    | Reception with two antennas                                                         |
| Channel Model                   | Vehicular A                                                                         |
| UE velocity                     | 3 km/h, 30 km/h                                                                     |

**4.3.2.6.2 Simulations results**

Figure 4.3.2.6.2-1 and Figure 4.3.2.6.2-2 present CQI link performance for the Vehicular A channel at the UE velocity of 3 km/h and 30 km/h respectively.

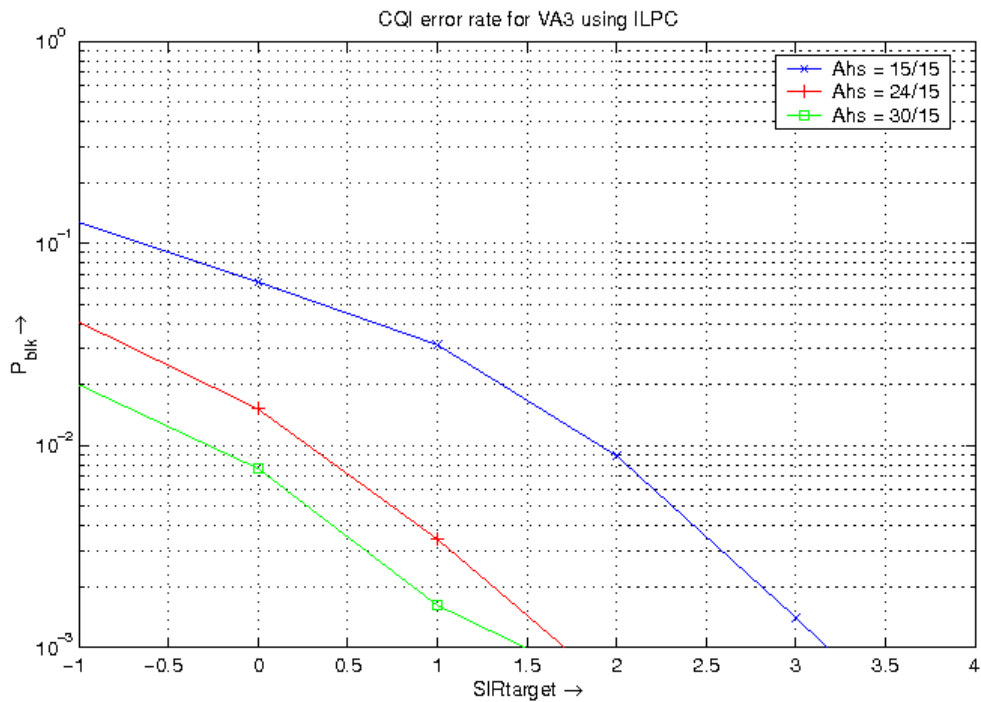

**Figure 4.3.2.6.2-1 CQI error rate vs. SIR target for VehA3**

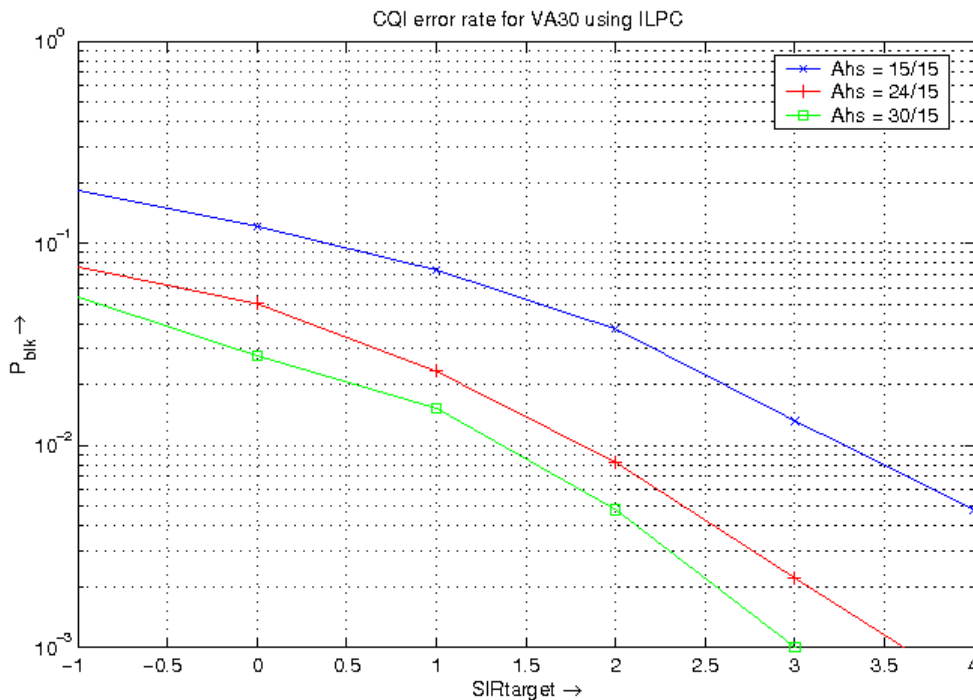

Figure 4.3.2.6.2-2 CQI error rate vs. SIR target for VehA30

Table 4.3.2.6.2-1 captures the results of CQI error rates at the SIR target of 0 dB.

Table 4.3.2.6.2-1 CQI error rate results at SIR target 0 dB

| HS-DPCCH to DPCCH power offset | CQI error rate @ 0 dB SIR target and Veh A3 | CQI error rate @ 0 dB SIR target and Veh A30 |
|--------------------------------|---------------------------------------------|----------------------------------------------|
| 0 dB                           | 6.5 %                                       | 10.1 %                                       |
| 4 dB                           | 1.5 %                                       | 5%                                           |
| 6 dB                           | 0.8 %                                       | 3 %                                          |

Based on the above results and taking as an example an operating point of 4% for the CQI error rate it is observed that:

- If the HS-DPCCH power offset to the DPCCH is configured relatively high (e.g. 6 dB) then reliable detection of CQI with a reduced SIR target is possible in non-SHO even without increasing the HS-DPCCH power offset to the DPCCH.
- If the HS-DPCCH power offset to the DPCCH is configured relatively low (e.g. 0 dB), then high SIR target reduction (e.g. to 0 dB) may deteriorate CQI performance. The presented simulation results prove that beta boosting, i.e. increasing the HS-DPCCH power offset to the DPCCH, would then improve the CQI error rate.

The UE can be DL active (receive HSDPA channels) and reliably transmit CQI on the HS-DPCCH when it is in CPC mode, and the SIR target is reduced. Depending on the configuration of the HS-DPCCH power offset to the DPCCH, beta boosting may be useful to keep the desired CQI error rate.

### 4.3.3 Benefits of the concept

- Less air interface capacity consumption per UE due to reduced UL DPCCH noise contribution and therefore also increased UE battery life time compared to REL-6.

- Compared to REL-6: Increased number of temporarily inactive users that can stay in CELL\_DCH and that can therefore get active in a very short time avoiding frequent transitions to CELL\_FACH.
- Power control loop is maintained for UL and DL.
- For L1 signalling approach: no extra UL E-DPDCH transmission needed, fast signalling and low processing effort.
- For L2 signalling approach: reliable due to CRC for the MAC-e PDU and HARQ retransmission mechanism, applicable in SHO.
- For predefined/configured rules: further signalling reduction (especially for CPC initiation).

#### 4.3.4 Open issues of the concept

- Need for modification of HS-SCCH signalling (spare values exist).
- Details of power offset on HS-DPCCH and/or UL DPCCH to compensate SIR\_target reduction in case of DL active and UL inactive.
- Automatic DPCCH power offset or reduction by the UE might be considered for reactivation or deactivation respectively to reduce convergence time of the power control.
- Handling of VoIP and non-VoIP together.
- Decision on how to address/avoid possible RL\_FAILURE messages of non-serving Node Bs in case of soft handover.

### 4.4 CQI reporting reduction

#### 4.4.1 Description of the concept

The proposed concept has the goal to reduce the Tx power of the UE by reducing the CQI reporting (thus eliminating the interference from HS-DPCCH in UL) when no data is transmitted on HS-PDSCH in downlink. This could be achieved by switching the CQI reporting off ("CQI off") or by just a reduction of CQI reporting ("Reduced CQI") which does not switch off the CQI reporting completely.

It is an important characteristic of the concept that these changes do not involve the RNC, so that the long delays of RRC or NBAP procedures (>> 100ms) are avoided and the user is staying in CELL\_DCH state.

The "CQI off" and "CQI reporting reduction" could be carried out by e.g.:

- L1 signalling: Serving Node B controls when a UE is going into an inactive phase with CQI off and corresponding L1 signalling is used to trigger deactivation & reactivation.
- L2 signalling: The UE controls CQI off by L2 MAC-e signalling to the NodeBs of the active RLS, i.e. deactivation & reactivation.
- Predefined/configured rules: Both UE and NodeB detect inactivity and activity based on either pre-defined or configured rules and reduce the CQI reporting interval to a pre-defined or configured CQI reporting interval during periods of inactivity.

##### 4.4.1.1 L1 signalling approach for CQI off

###### **Traffic inactivity detection:**

The absence of data to be transmitted on HS-DSCH in the DL can be detected by observing the current occupation of the MAC-hs buffer located in the serving Node B. A deactivation start timer/timeout (starting when a buffer runs empty) can be used to avoid unnecessary switching between active and inactive mode during very short traffic intermissions.

###### **Switching CQI off:**

Depending on the traffic inactivity on DL, a switching off of periodic CQI reporting (as configured by RNC) is triggered by the serving Node B.

The serving Node B informs the UE about the change by physical layer signalling. This can be implemented as a new signalling message on the HS-SCCH, using one of the 8 unused bit combinations within the 7 bits assigned to the channelization code set.

On receiving this message, the UE will immediately stop the transmission of CQI reports on HS-DPCCH, but save the RNC-configured reporting cycle to be restored at reactivation time. The reduction in UL interference achieved will depend upon the CQI reporting interval configured by the UTRAN for each UE.

#### **Triggering reactivation:**

When the serving Node B detects the reactivation condition (new data for DL in the MAC-hs buffer can be immediately detected in the serving Node B), it sends a signalling message to the UE (via HS-SCCH) to trigger the restart of CQI reporting. On receiving this message, the UE reacts by immediately restarting CQI reports with the last RNC-configured reporting cycle.

The Node B avoids scheduling of large PDUs to the UE, until the first CQI report has been received. Delay-critical data (e.g. SRB messages) can immediately be scheduled when restricted to a small PDU (corresponding to low CQI values).

#### 4.4.1.1.1 Interworking aspects

##### **Cell changes and Soft Handover:**

Measurement reports from the UE and RNC-triggered signalling of changes in the active set and changes of the serving Node B will be transmitted on SRB over E-DCH and HS-DSCH, and thereby trigger reactivation. Therefore the highest gain of this concept is achieved when the reporting interval of such mobility measurements is well above the timeout parameter that triggers the deactivation.

The on- and off-switching of the CQI reports is not affected by soft handover (SHO), as SHO is not applied on HS-DPCCH.

##### **Reporting power gains to RNC:**

As it is the goal of the proposed concept to allow more users to get and remain connected (without the need for intermediate RRC state switching), it is necessary that the RNC is made aware of the savings in the received noise rise, so that these can be taken into account in decisions e.g. for call admission and RRC state switching. These gains will, however, automatically be reflected in the measurements of “total received wideband power”, which are periodically reported from Node B to CRNC, anyway. Thus, no changes to the standard measurement reporting are required for this purpose.

#### 4.4.1.2 L2 signalling approach for CQI off

##### **Traffic inactivity detection:**

The UE detects autonomously the conditions for a transition into the idle traffic mode, i.e. inactivity in the DL. The conditions for a transition into the idle traffic mode could involve no activity for a certain minimum period of time in DL (and UL).

When the UE has detected a transition from active mode into “idle traffic mode” or vice versa, it can instantaneously stop or resume CQI reporting. When the NodeB has detected a transition from active mode into “idle traffic mode” or vice versa, it can instantaneously continue or stop decoding the CQI information.

The UE will inform the NodeBs about a change from active mode into idle traffic mode and vice versa by means of a short MAC-e PDU consisting of scheduling information (SI). For the change from active mode into idle traffic mode, a specific SI reserved for that purpose is transmitted and repeated through HARQ retransmissions until all NodeBs in serving and non-serving RLS have acknowledged receipt of the transition or the maximum number of transmissions is reached.

##### **Switching CQI off:**

Periodic CQI reporting (as configured by RNC) can be switched off when data inactivity on the downlink has been detected by the UE. In particular, the UE immediately stops the transmission of CQI reports on HS-DPCCH upon



transition into the idle traffic mode. Since no HS-PDSCH data is transmitted in an idle traffic period, ACK/NACK signalling is not required and HS-DPCCH is completely switched off, thus also reducing the UL interference. The RNC-configured CQI reporting cycle is saved and can be restored instantaneously at reactivation time.

#### Triggering reactivation:

A NodeB can trigger reactivation by sending a short MAC-hs PDU in the downlink, which is then followed by the reactivation through transmitting SI by the UE in the uplink.

For the change from idle traffic mode into active mode, the actual SI is transmitted and repeated through HARQ retransmissions until receipt of the transition is acknowledged.

#### Specific L2 signalling aspects:

The reserved MAC-e SI for indicating a transition can have its own HARQ profile with an additional power offset to ensure reliable detection by all NodeBs in the active set with reasonable latency. The SI word specific for the transition from active mode into idle traffic mode conveys UE buffer occupancy of 0 (9 bits), maximum possible power ratio versus DPCCH (5 bits) and a pre-defined logical channel ID (4 bits). While a pre-defined logical channel ID is given in the SI word specific for the transition from active mode into idle traffic mode, it may be noted that the transition is valid for all logical channel IDs.

#### 4.4.1.2.1 New parameters for L2 signalling approach for CQI off

| Parameter                                | Description                                                                                               |
|------------------------------------------|-----------------------------------------------------------------------------------------------------------|
| Inactivity time                          | minimum time of inactivity on UL and DL before the UE can trigger a transition into the idle traffic mode |
| SI for transition into idle traffic mode | Dedicated and reserved SI that is only used to signal the transition into the idle traffic mode           |

#### 4.4.1.3 Predefined/configured rules for CQI reporting reduction

Instead of relying on signalling, predefined (and standardized) rules can be used to control the UE and Node B behaviour, i.e., the UE and Node B could by applying these rules have a consistent view of whether 'normal' or 'reduced' activity transmission should be used.

In the downlink direction, the Node B is clearly aware of whether there is data awaiting transmission. The UE will notice whether it has been recently scheduled or not, which provides an indication about the downlink activity and correspondingly whether the UE shall use 'normal' or 'reduced' activity transmission for the uplink CQI reporting.

Currently, a single CQI reporting pattern is defined for HSDPA, where a regular reporting interval can be configured. By defining an additional CQI reporting pattern (which can have a configurable reporting interval different from the first pattern) to be used in 'reduced' activity transmission, a solution not requiring signalling can be achieved. Normally, the UE reports CQI using the frequent reporting pattern, i.e., transmits a CQI report once every  $x_1$  ms. If the UE has not been scheduled for a certain (configurable) time period, the UE switches to a second, 'reduced activity' CQI reporting pattern, i.e., reports CQI every  $x_2$  ms, where  $x_2 > x_1$ .

Note that the CQI reporting patterns as a special case may include switching off the reporting completely (basically setting  $x_i$  to infinity). One possibility to implement this is to (re)start a timer in the UE every time it is scheduled. Once the timer reaches zero, the UE switches from pattern 1 to pattern 2. The Node B can use a corresponding timer mechanism (one per UE) to determine whether to expect pattern 1 or pattern 2.

Furthermore, it may be beneficial, although not absolutely necessary, to select the patterns such that  $x_1$  is a factor in  $x_2$ . If, e.g., due to the UE missing the HS-SCCH and the Node B not detecting the absence of an ACK/NAK on the HS-DPCCH, the UE and Node B happens to use different patterns there are at least some reporting events that coincide with this choice of patterns. Alternatively, Node B could detect the presence of CQI every  $x_1$  ms regardless of whether CQI reporting is reduced or not.

To implement the above mechanisms, higher layer signalling between the RNC and the UE is required to configure the CQI reporting intervals  $x_i$ . This signalling typically only takes place once at call setup and thus does not lead to a

significant increase in interference. Signalling is also required between the RNC and Node B to configure the CQI reporting patterns  $x_i$ .

## 4.4.2 Analysis of the concept

### 4.4.2.1 Gain in terms of number of additional users & UL noise rise

The gain that can be achieved by switching CQI reporting off, in terms of reducing the noise rise consumed by HS-DPCCH, depends on several factors:

- Interval of CQI reporting (this can be configured between once per 2ms HSDPA TTI and once per 160ms). The more often the CQI is reported the higher is the gain of switching CQI reporting off.
- The power of the HS-DPCCH. The higher the HS-DPCCH power the higher the gain of switching CQI reporting off.

During DL inactivity the ACK/NACK field (first of the 3 slots) of HS-DPCCH is automatically DTXed.

The HS-DPCCH power is defined relative to the UL DPCCH power via the signalled value  $\Delta_{CQI}$  which translates into an amplitude ratio  $\beta_{hs}/\beta_c = 1/3 \dots 2$  (i.e. -9.5dB .. 6dB), see 25.213 [5] and 25.214 [6].

Due to same SF, similar channel coding if TFCI carried by UL DPCCH and similar required reliability it could be assumed that HS-DPCCH and UL DPCCH are transmitted with similar power (i.e. power ratio of 0dB).

Assuming one CQI reporting per 2ms HSDPA TTI (which is the highest reporting cycle), a power ratio of HS-DPCCH/DPCCH of 0dB and that the UL DPCCH SIR target is configured so that it consumes 1% of the maximum allowed noise rise then switching CQI reporting off will reduce the noise rise produced by one user from 1.67% to 1%. This gain translates into the increase of the number of inactive users by the gain factor of 1.67.

### 4.4.2.2 Signalling load

Considering the L1 signalling approach:

- the HS-SCCH capacity of 500 messages per sec (1 every 2ms),
- the fact that a UE has to be able to read 4 HS-SCCHs in parallel,
- the case that one HS-SCCH message would be used for deactivation and a second HS-SCCH message would be used for reactivation,
- an average inactivity period of 5sec,

even a high number of inactive users (e.g. 80) would have only a smaller impact on the HS-SCCH signalling load ( $80 \times (2 \text{ msg}/5\text{sec})/(2000\text{msg}/\text{sec}) = 1,6\%$ ).

## 4.4.3 Benefits of the concept

- Less air interface capacity consumption per UE due to reduced UL DPCCH noise contribution and therefore also increased UE battery life time compared to REL-6.
- Compared to REL-6: Increased number of temporarily inactive users that can stay in CELL\_DCH and that can therefore get active in a very short time avoiding frequent transitions to CELL\_FACH.
- Possibility to address UL noise rise reduction in case of DL inactivity.
- for L1 signalling approach for CQI off: no extra UL E-DPDCH transmission needed, fast signalling and low processing effort.
- for L2 signalling approach for CQI off: reliable due to CRC for the MAC-e PDU and HARQ retransmission mechanism.
- for predefined/configured rules: further signalling reduction (especially for CPC initiation)

#### 4.4.4 Open issues of the concept

- Need for modification of HS-SCCH signalling (spare values exist).
- Applicability for VoIP?
- Need for sending CQIs from time to time? Or is CQI off sufficient?

### 4.5 DRX at the UE

#### 4.5.1 Description of the concept

- In case of discontinuous transmissions or sustained DL and UL inactivity, the UE and UTRAN may limit the number of subframes where the UE needs to monitor the HS-SCCH so that:
  - DL scheduling is still possible
  - UE is able to shut-off the receiver circuitry over some periods of time to yield a non 100% receiver duty cycle.
- Minimum monitoring of CPICH for the UE to keep up with changes in its Active Set due to mobility.
- The UE monitors a limited subset of HS-SCCHs in the time domain e.g., one subframe every two, or every four subframes – this DRX operation is controlled by the “HS-SCCH transmission cycle”.

Note: This concept alone does not solve the problems of limitations in number of users per cell or limitations in UL noise rise or reduction in latency for temporarily inactive users addressed by the WI. Therefore it will only be considered if it can be applied as add-on to the concepts addressing the objectives of the WI.

#### 4.5.2 Analysis of the concept

The DRX concept is complementary to the DPCCH gating (DTX) concept introduced in section 4.2. Indeed, the DPCCH gating concept will effectively open transmission gaps during which no PHY channels are transmitted from the UE. It would be, therefore, desirable to open reception gaps aligned as much as possible with those transmission gaps so that the UE could effectively go to sleep and hence extend its battery life (talk-time).

In order to analyze the concept we look into the following aspects:

- How the DTX and DRX cycles can be maximally aligned.
- What is the performance impact at the DL scheduler.

##### 4.5.2.1 Timing, with 2 ms E-DCH TTI

###### 4.5.2.1.1 Background

Figure 4.5.2.1.1-1 details the relative HARQ timings for HSDPA and HSUPA.

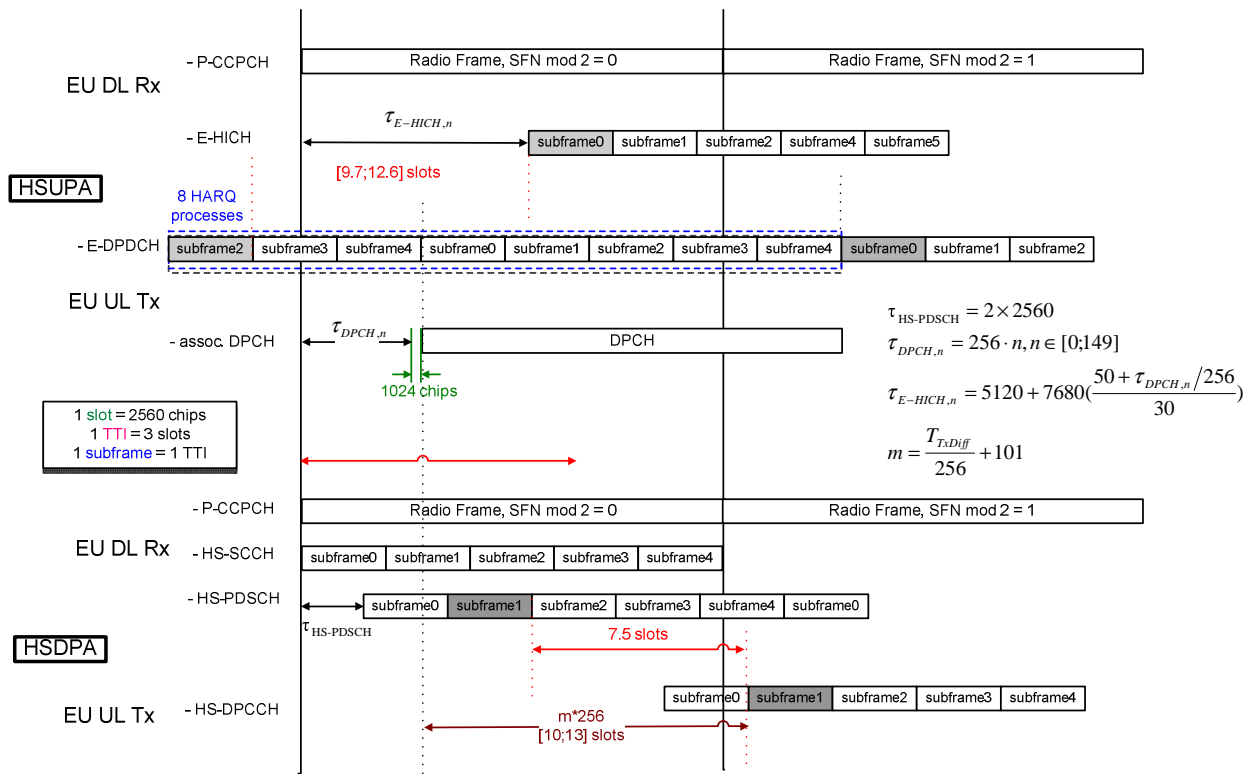

Figure 4.5.2.1.1-1: HSDPA/HSUPA relative HARQ timing

It is worth to note that for HSDPA:

- The data acknowledgment is sent 7.5 slots after the end of the transmission of a HS-PDSCH subframe over the HS-DPCCH.
- A data retransmission can occur between 5 and 7 TTIs later

While for HSUPA:

- The data acknowledgment is sent 9.7~12.6 slots after the end of the transmission of the corresponding E-DPDCH subframe over the E-HICH.
- A data retransmission can only be sent 7 TTIs later

In the following discussion, we synchronize these events so that they coincide as much as possible. Since it is not desirable to change the above timing, we can only choose which subframes the UE is monitoring or is allowed to use for transmission. These restrictions have to be well shared and synchronized with the Node B as the latter has to take them into account when scheduling the HSDPA packets.

The parameter “n” of  $\tau_{DPCH,n}$ , which defines the offset for the UE (see Figure 4.5.2.1.1-1), creates a variability in the relative position of the HSDPA and HSUPA channels. With different values of n, the success of channel synchronization will vary.

#### 4.5.2.1.2 DRX mode 2/8

In this mode, the UE can be scheduled and is allowed to transmit every 4<sup>th</sup> subframe as depicted in Figure 4.5.2.1.2-1 and Figure 4.5.2.1.2-2. A DTX cycle of 4 TTIs, defines the E-DPDCH and E-HICH timelines. If we want to keep that DTX cycle almost unchanged, the UE transmission on the UL HS-DPCCH has to coincide with the DTX awake periods. This falls nicely as the UE reception would also fall in the same periods. By preserving the DTX cycle, we create an overlapping DRX cycle. This allows the UE to go to sleep when it is neither receiving or transmitting.

Sleeping is optional for the UE. The time to switch between the awake and sleep states is implementation dependent. The subsequent figures show skirts around the combined channel activity time to illustrate this concept. However, this is for illustration purposes only.

With arbitrarily chosen wakeup and sleep delays and averaging over n, which defines the offset for the UE (see Figure 4.5.2.1.1-1), a UEs can achieve 31% of DTX/DRX time.

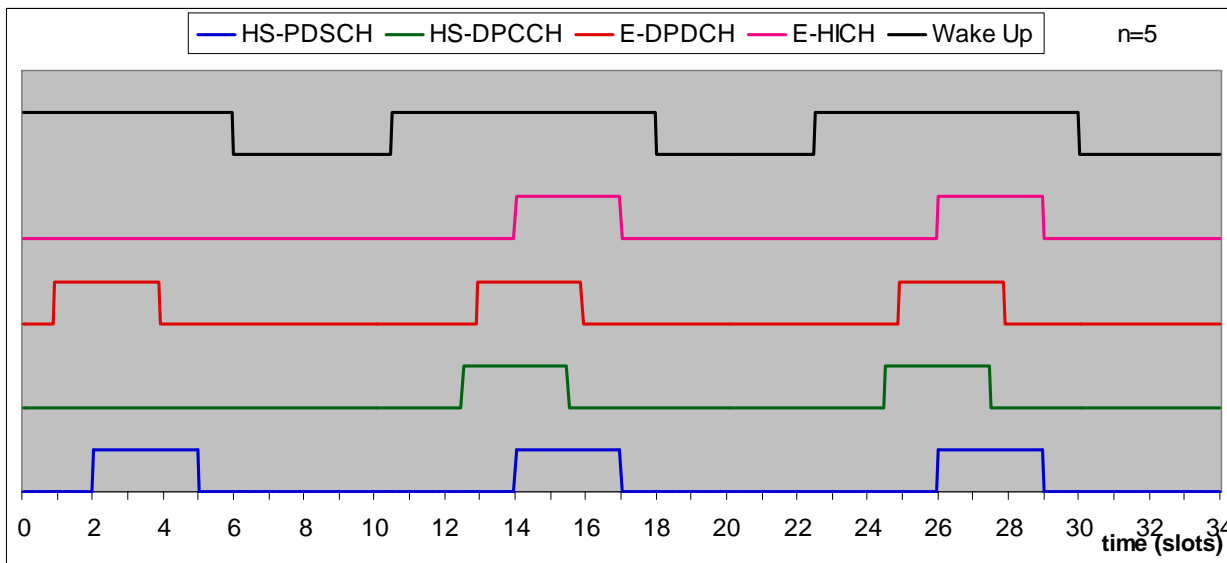

Figure 4.5.2.1.2-1: DRX mode 2/8, n=5

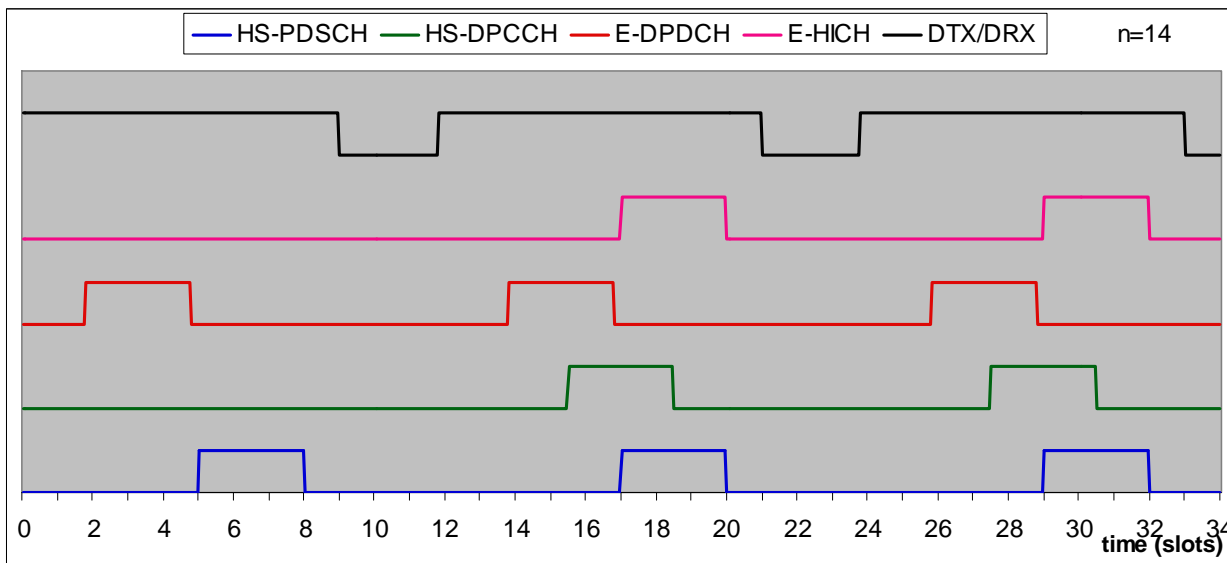

Figure 4.5.2.1.2-1: DRX mode 2/8, n=14

4.5.2.1.3 DRX mode 1/8

In this mode, the UE is scheduled and is allowed to transmit every 8<sup>th</sup> subframe. The transmission and reception cycles are offset by 4 frames to separate transmission and reception operations. This allows DTX and DRX periods of 75%, however, the combined DTX/DRX average period is 42% at the UE.

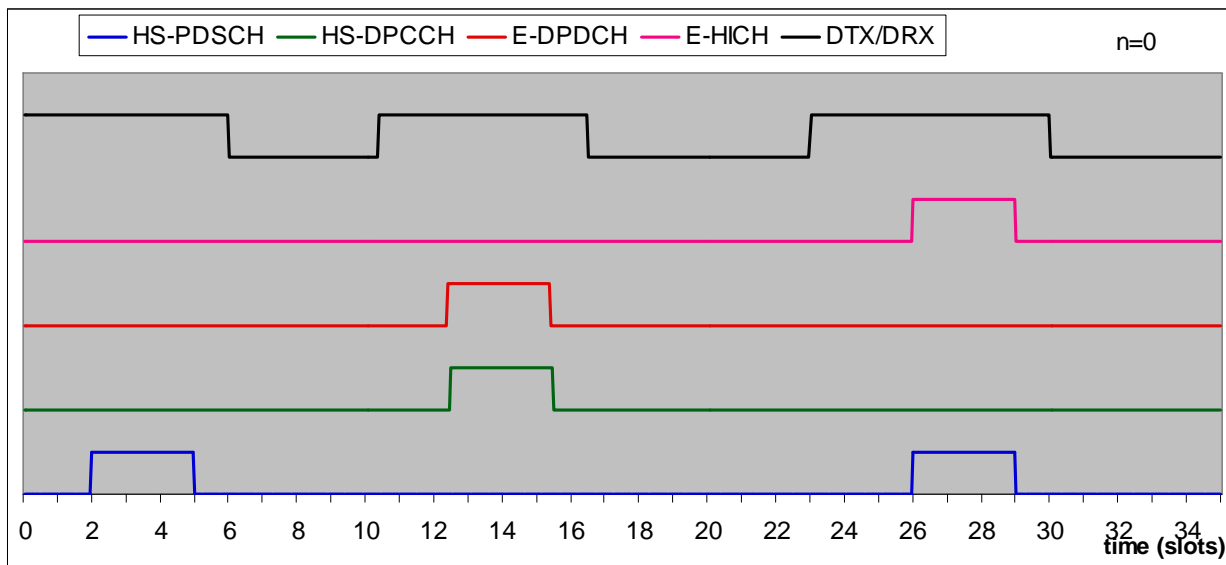

Figure 4.5.2.1.3-1: DRX mode 1/8, n=0

4.5.2.1.4 DRX mode 1/16 and beyond

In this mode, the UE is scheduled and is allowed to transmit every 16<sup>th</sup> subframe. The transmission and reception cycles are offset by 4 frames to combine the transmission operations. In this mode, the UE can achieve DTX/DRX periods of 60%. Note that if the UE chooses to transmit and that transmission is NACK-ed, the UE will have to wake up at the appropriate time (7 subframes later) to re-transmit. This case is not depicted below.

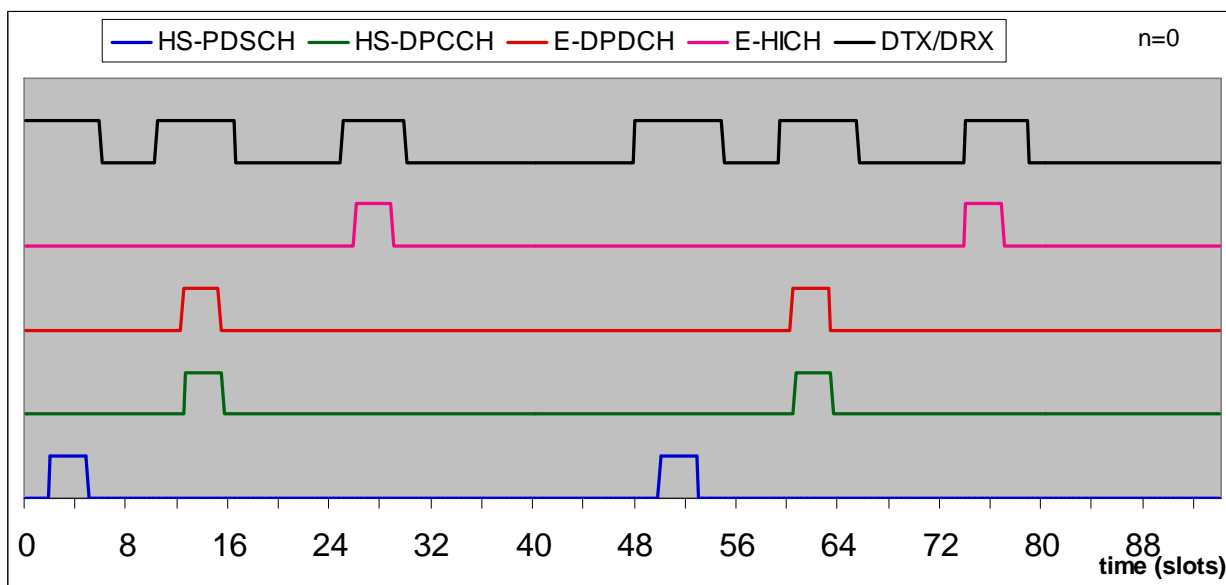

Figure 4.5.2.1.4-1: DRX mode 1/16, n=0

If longer DTX cycles are allowed, DRX cycles can be tailored that are similar to this 1/16 mode.

4.5.2.1.5 DRX mode 2/8, in a 2 way soft handover

In the following, we assume the UE is in a 2 way soft handover between two Node B's and that the UE is assigned **n1** and **n2** as offsets from the Node B's.

Per 25.214, “UTRAN starts the transmission of the downlink DPCCH/DPDCH or F- PCH for each new radio link at a frame timing such that the frame timing received at the UE will be within  $T_0 \pm 148$  chips prior to the frame timing of the uplink DPCCH/DPDCH at the UE”. We can assume that all Node Bs have adjusted their transmission times so that

hypothetical DPCH channels would arrive at the same time. Since that arrival time dictates the E-DPCH offset, we can pick as a reference an enabled TTI subframe. The E-HICH subframes will be [9.7 to 12.6] slots after this enabled E-DPCH depending on the Node B. By design, they will fall within a subframe of each other.

The choice of the HS-PDSCH subframe (and consequently the associated HS-DPCCH) is based on the closest E-DPCH subframe that optimizes the DTX/DRX cycle.

However, the E-RGCH from the non-serving cell is 10 ms long, preventing any DRX during this mode of operation.

If we ignore the E-RGCH from the non-serving cell, averaging over n1 and n2, the UE can sleep 26% of the time.

#### 4.5.2.1.6 DRX mode 1/8, in a 2 way soft handover

The 10ms E-RGCH impacts the possible DRX cycle, however, we can still achieve on average **24%** of sleep time. In the worse case scenario, the sleep time drops to **15%**. In the best cases, the UE can sleep up to **27%** of the time.

If we ignore the E-RGCH from the non-serving cell, averaging over n1 and n2, the UE can sleep 36% of the time. At a worse case scenario, the sleep time drops to 22%. In the best cases, the UE can sleep up to 46% of the time.

Figure 4.5.2.1.6-1 shows an example of handover between two Node Bs with sleep times of 27%.

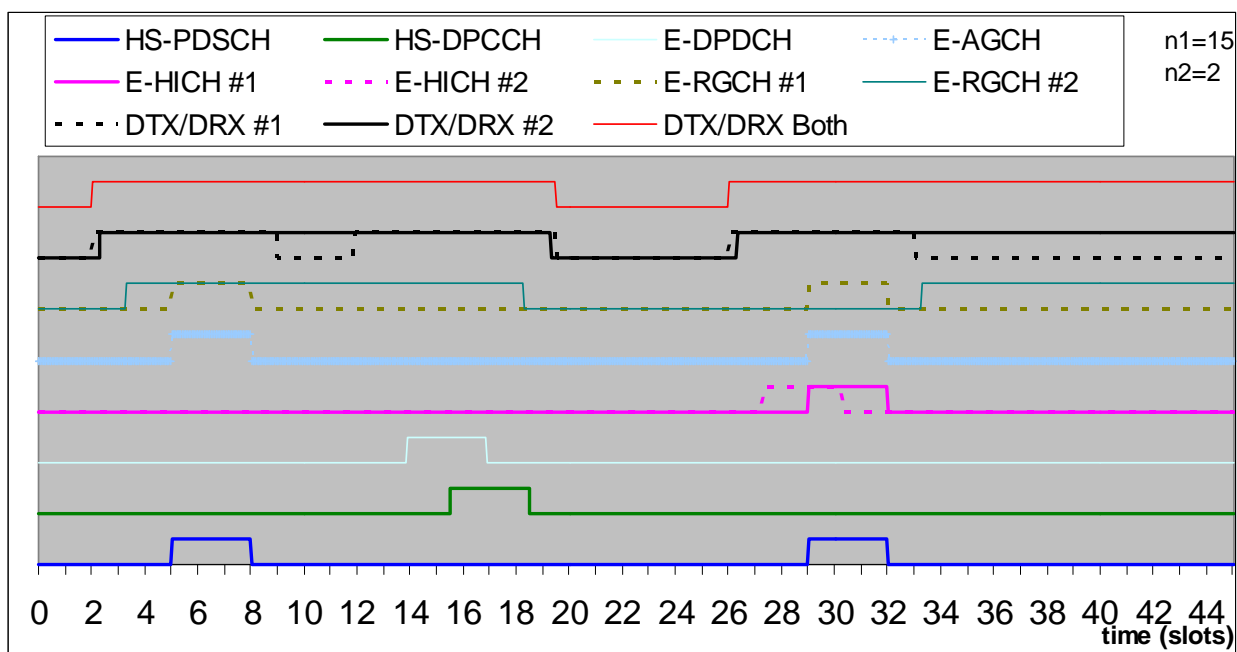

Figure 4.5.2.1.6-1: UE in handover region, DRX mode 1/8, in soft handover, 27% sleep time

#### 4.5.2.1.7 DRX mode 1/16, in a 2 way soft handover

In this mode, we can achieve on average **39%** of sleep time. The sleep time varies between **33%** and **44%**. Figure 4.5.2.1.7-1 shows an example of handover between two Node Bs with sleep times of 39%.

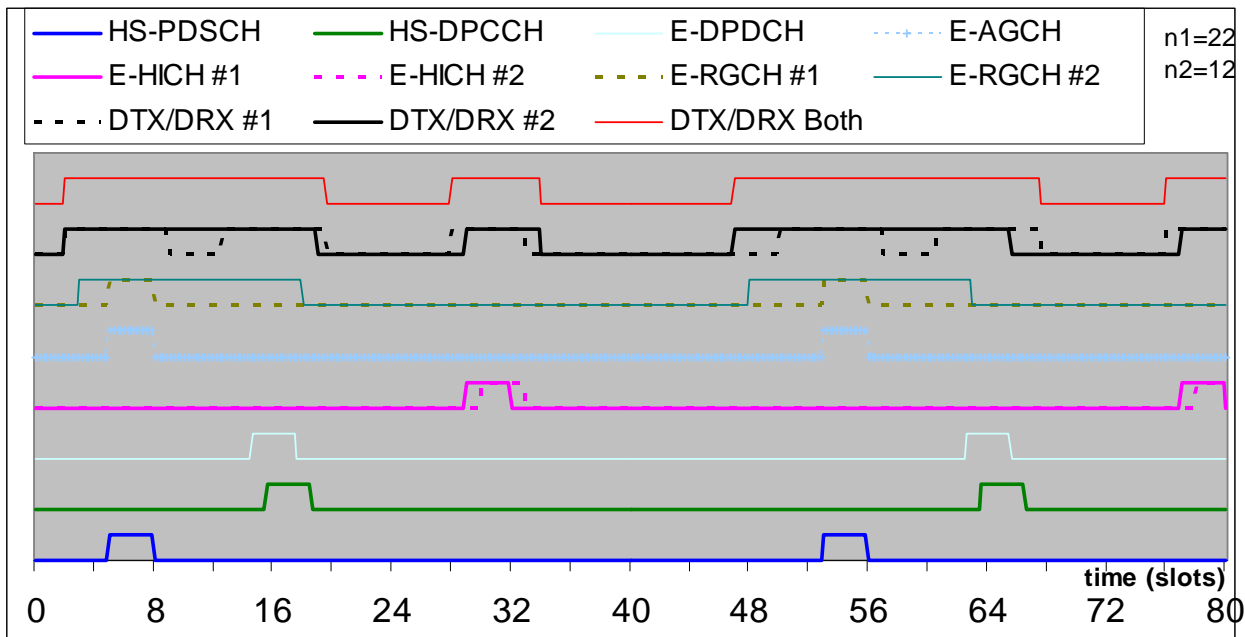

Figure 4.5.2.1.7-1: UE in handover region, DRX mode 1/16, in soft handover, 39% sleep time

#### 4.5.2.2 Downlink scheduler performance

When a UE is in a DRX mode, the scheduler is restricted with regard to the times it can choose to schedule this UE on the DL. This could result in a degradation of the performance of the scheduler measured with the Average Outage Probability. Figures 4.5.2.2-1 and 4.5.2.2-2 show that the Average Outage Probability degradation is acceptable (less than 5%) for all channel models considered when we are well below the system capacity.

While the DRX mode allows the UE to extend its battery life, it is under UTRAN's control, and thus can be deactivated if the DL scheduler is running short. At high system loads, the UTRAN can disable this function to optimize its resource allocation.



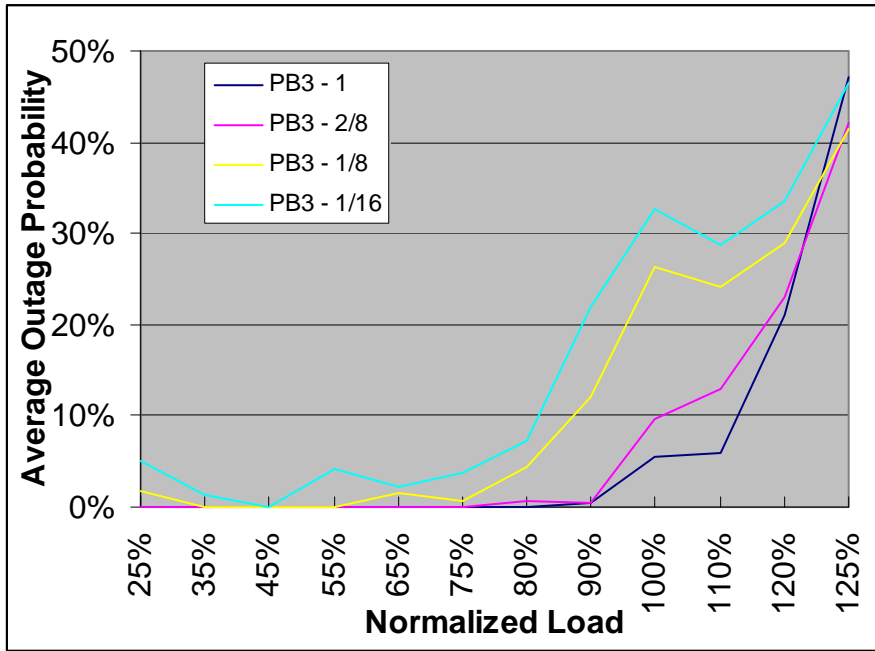

Figure 4.5.2.2-1: Impact on DL scheduler for a PB3 channel model

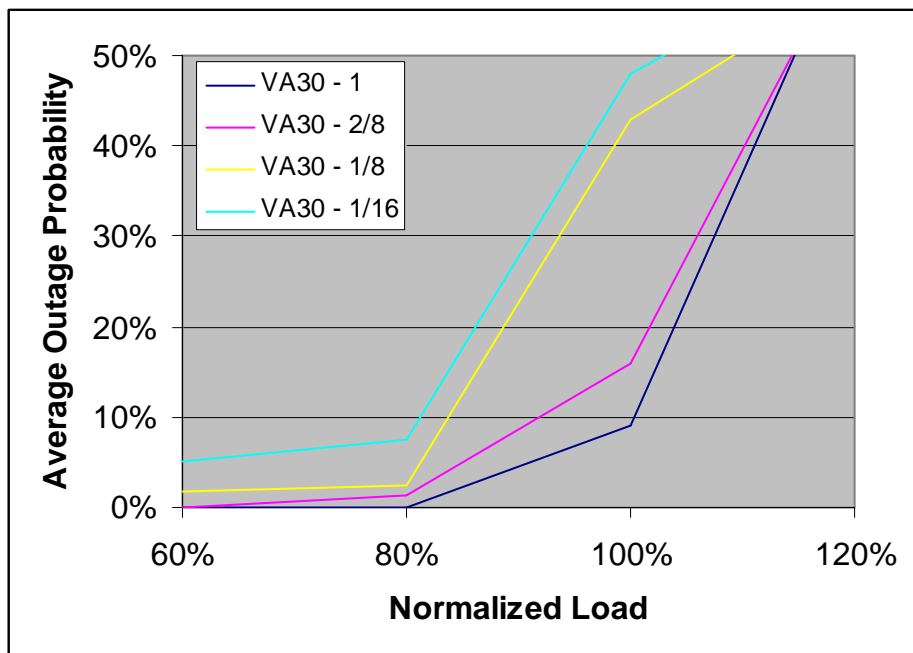

Figure 4.5.2.2-2: Impact on DL scheduler for a VA30 channel model

4.5.2.2A Timing, with 10 ms E-DCH TTI

4.5.2.2A.1 Background

The same basic time relationships remain between the HSDPA/HSUPA channels, with some modifications as shown in Figure 4.5.2.2A.1-1.

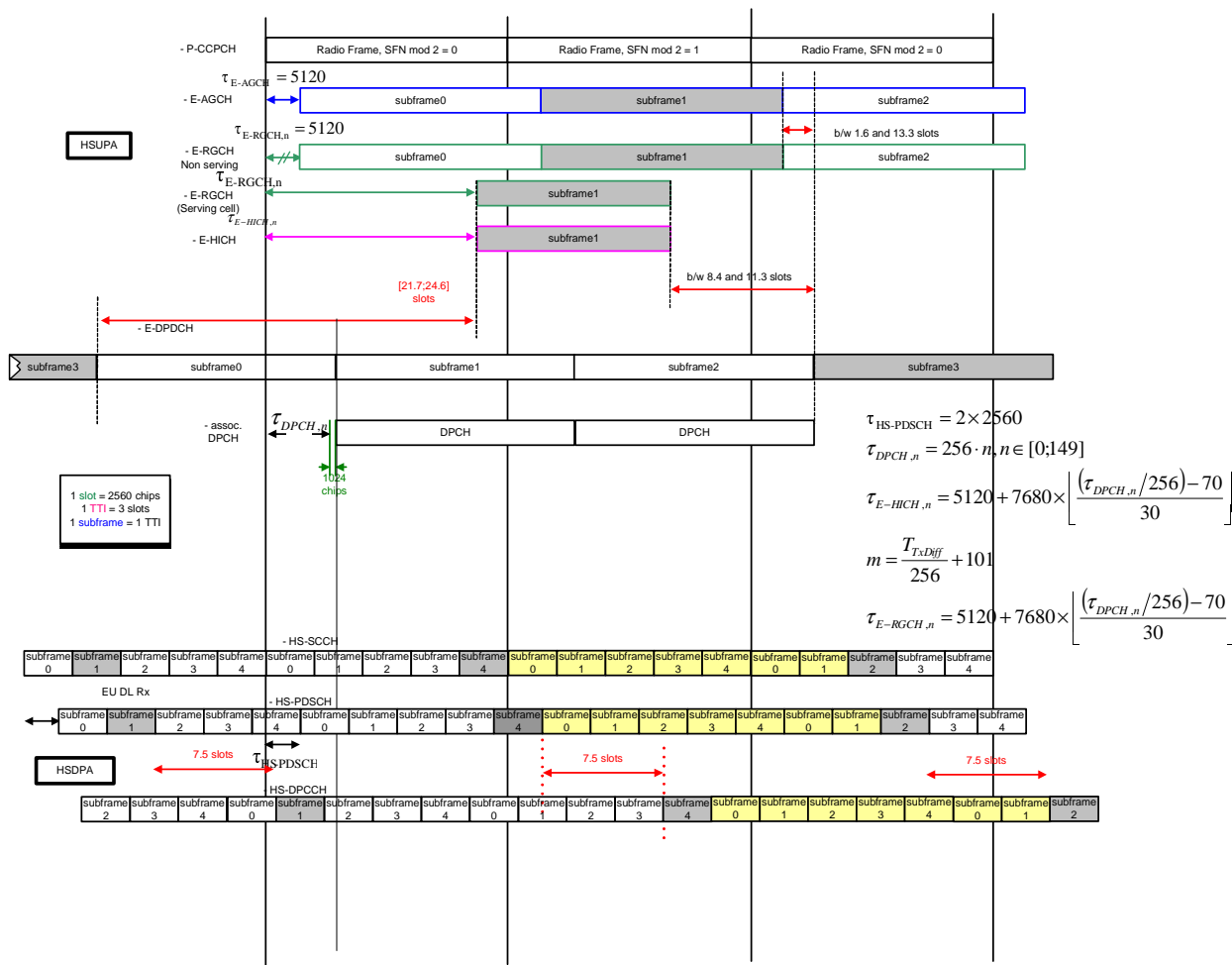

Figure 4.5.2.2A.1-1: HSDPA/HSUPA relative HARQ timing for 10 ms E-DCH

4.5.2.2A.2 DRX mode 1/2

As can be noted from Figure 4.5.2.2A.1-1, the need to receive E-HICH, E-RGCH and E-AGCH result in no sleep time.

4.5.2.2A.3 DRX mode 1/3

It is possible to operate in this mode, however, the UE DRX sleep mode is upper bounded by about 6 slots which is around 13%.

4.5.2.2A.4 DRX mode 1/4

We can achieve on average **24.6%** of sleep time. In the worst case scenario, the sleep time drops to **20.5%**. In the best cases, the UE can sleep up to **29.3%** of the time.

Figure 4.5.2.2A.4-1 shows an example of handover between two Node Bs with sleep times of 25%.

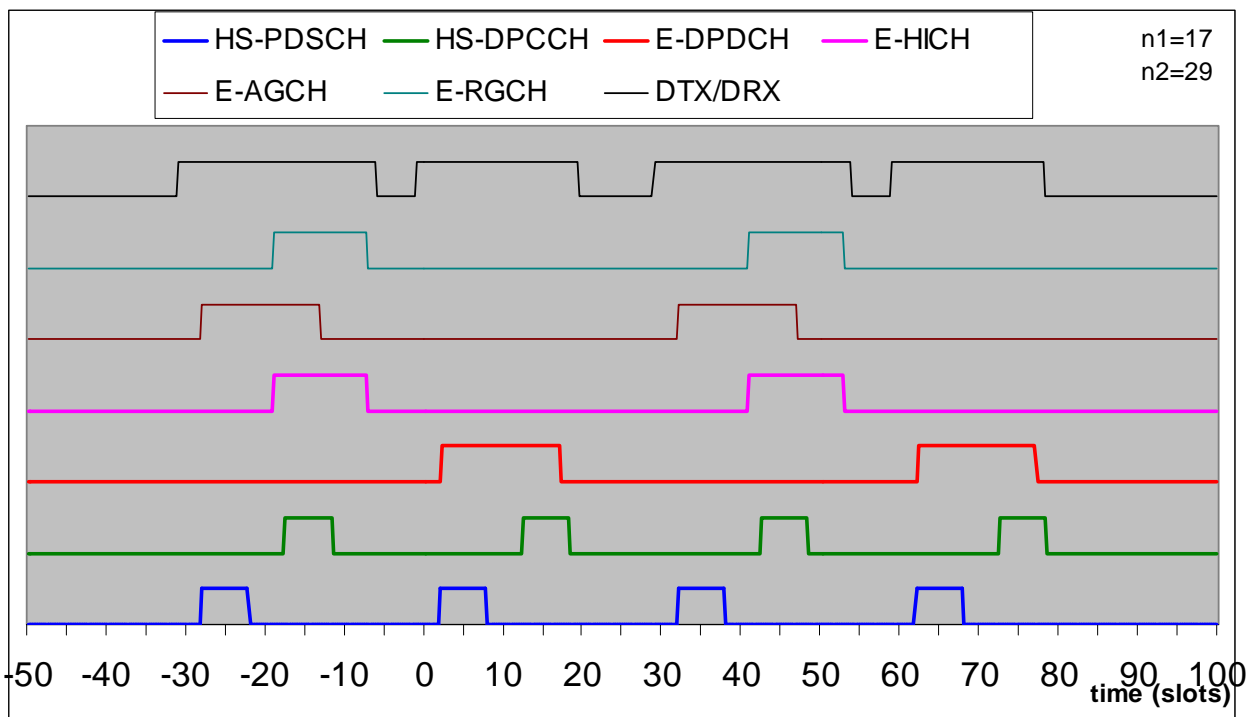

Figure 4.5.2.2A.4-1: 10ms E-DCH, DRX mode 1/4, 25% sleep time

4.5.2.2A.5 DRX mode 1/4, in a 2 way soft handover

The 10ms E-RGCH still impacts the possible DRX cycle, we can achieve on average **18.2%** of sleep time. In the worse case scenario, the sleep time drops to **3.3%**. In the best cases, the UE can sleep up to **27.6%** of the time.

If we ignore the E-RGCH from the non-serving cell, averaging over n1 and n2, the UE can sleep 24.6% of the time. At a worse case scenario, the sleep time drops to 20.5% . In the best cases, the UE can sleep up to 29.3% of the time. These results are as similar to the case where we are not in soft handover.

Figure 4.5.2.2A.5-1 shows an example of handover between two Node Bs with sleep times of 23%.

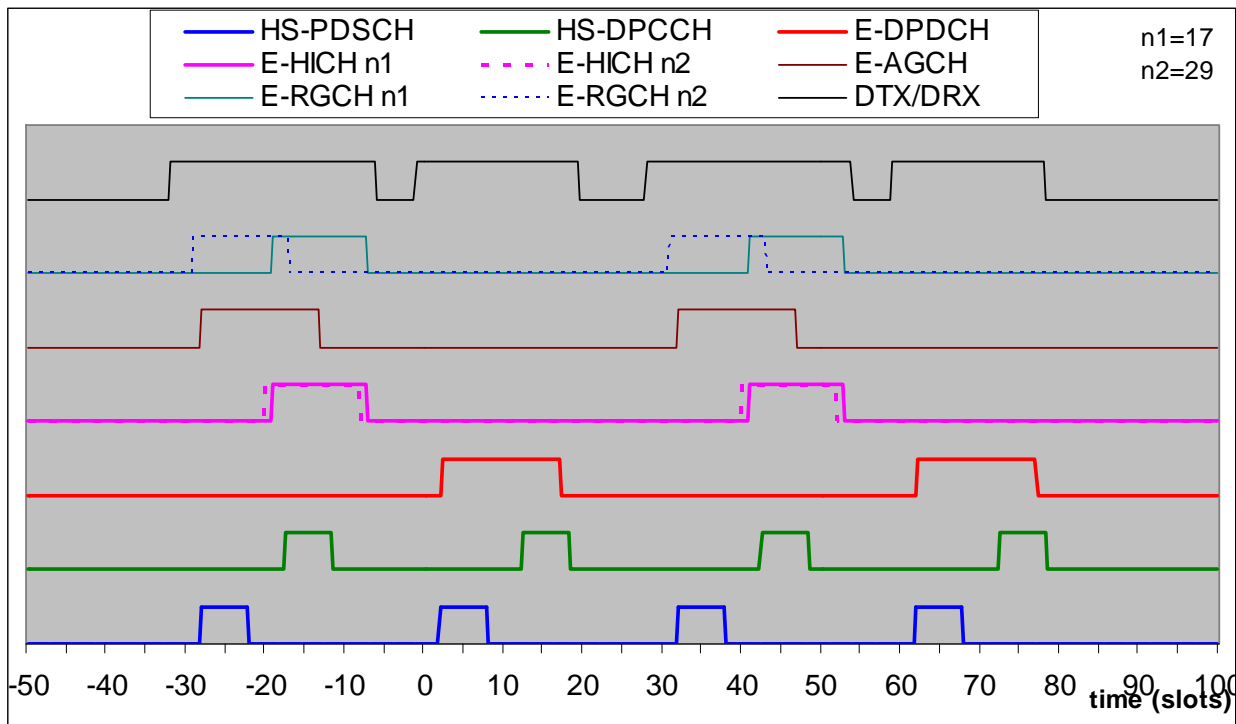

Figure 4.5.2.2A.5-1: UE in handover region, 10ms E-DCH, DRX mode 1/4, in soft handover, 23% sleep time

The HS-PDSCH transmissions have to occur when the UE wakes up so that the ACKs can be sent before it goes to sleep. More transmissions can occur than shown while the UE is awake, even if that means that the UE would have to stay longer awake to send the ACKs.

### 4.5.2.3 Impact of DRX in demodulation performance

#### 4.5.2.3.1 Simulation assumptions

This section goes over the assumptions for the link-level simulations.

- **Channel estimation:** Non-causal FIR filter over 2 slots: same channel estimation used for DRX and non-DRX simulations.
- **Time tracking:** 1<sup>st</sup> order loop. Same loop gain for DRX and non-DRX simulations.
- **Frequency tracking:** 1<sup>st</sup> order loop. Same loop gain for DRX and non-DRX simulations.
- **Channel models:**

| Propagation Conditions | Geometry (dB) |
|------------------------|---------------|
| PedA, 3km/h            | 5             |
| VehA, 120km/h          | 0             |

- Physical channel parameters:

| Physical channel | Parameter            | Value                                                            | Note                                                                                              |
|------------------|----------------------|------------------------------------------------------------------|---------------------------------------------------------------------------------------------------|
| P-CPICH          | P-CPICH $E_c/I_{or}$ | -10dB                                                            |                                                                                                   |
| P-CCPCH          | P-CCPCH $E_c/I_{or}$ | -12dB                                                            | Mean power level is shared with SCH.                                                              |
| SCH              | SCH $E_c/I_{or}$     | -12dB                                                            | Mean power level is shared with P-CCPCH. SCH includes P- and S-SCH with power split between both. |
| PICH             | PICH $E_c/I_{or}$    | -15dB                                                            |                                                                                                   |
| HS-SCCH          | HS-SCCH $E_c/I_{or}$ | Test-specific                                                    |                                                                                                   |
| OCNS             | OCNS $E_c/I_{or}$    | Necessary power so that total transmit PSD of Noce B adds to one | OCNS interference is specified in table C.13 of [19].                                             |

- Rx antennas: 1
- DRX cycles (inter-TTI interval): 4, 8, and 16. HS-SCCH is received every 4, 8, and 16 subframes.
- DRX patterns:
  - CRX (continuous reception): Non-DRX with inter-TTI interval of 8 is illustrated in Figure 1 (baseline reference). The pilot processing is always on.
  - DRX (discontinuous reception) with inter-TTI interval of 8 is illustrated in Figure 2. The UE wakes up 1 slot before the HS-SCCH subframe begins and goes to sleep 1 slot after the last HS-SCCH subframe ends because of non-causal channel estimation.
    - The DRX duration of the inter-TTI interval of 8 is 19 slots (6.33 subframes).
    - Similarly, the DRX duration of inter-TTI interval of 4 and 16 are 7 slots (2.33 subframes) and 43 slots (14.33 subframes), respectively.

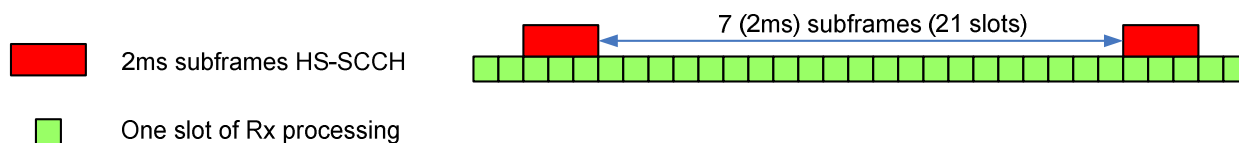

**Figure 4.5.2.3.1-1: Baseline reference without DRX when inter-TTI interval is 8.**

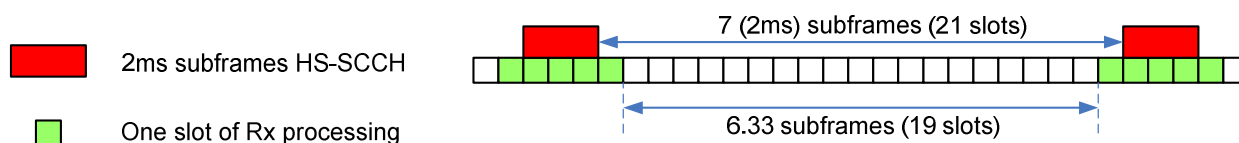

**Figure 4.5.2.3.1-2: HS-SCCH demodulation with DRX when inter-TTI interval is 8.**

4.5.2.3.2 Simulation results

The following figures show the block error rates (BLER) of HS-SCCH for different inter-TTI intervals. In all figures, the TTL and FTL are enabled.

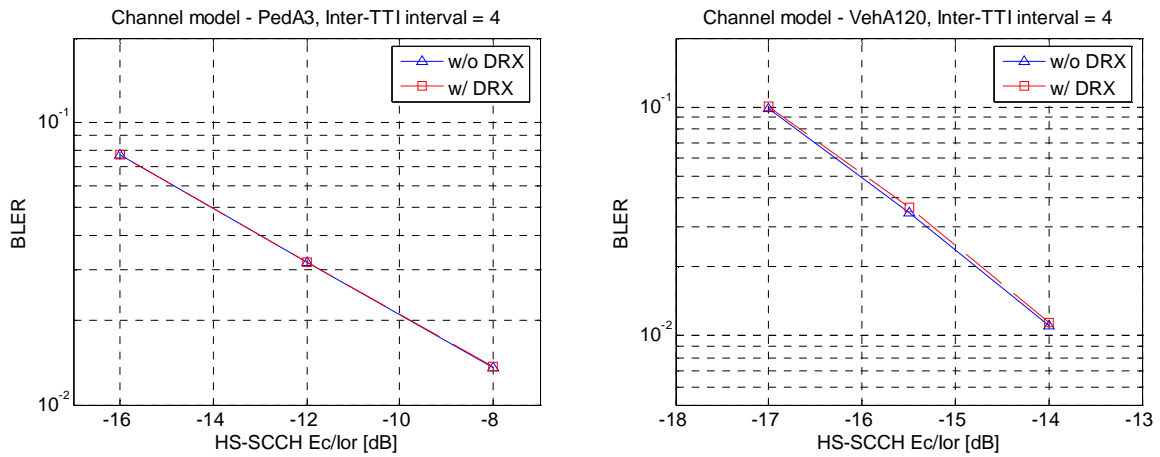

Figure 4.5.2.3.2-1: BLER of CRX and DRX cases with TTL, FTL and Inter-TTI interval = 4.

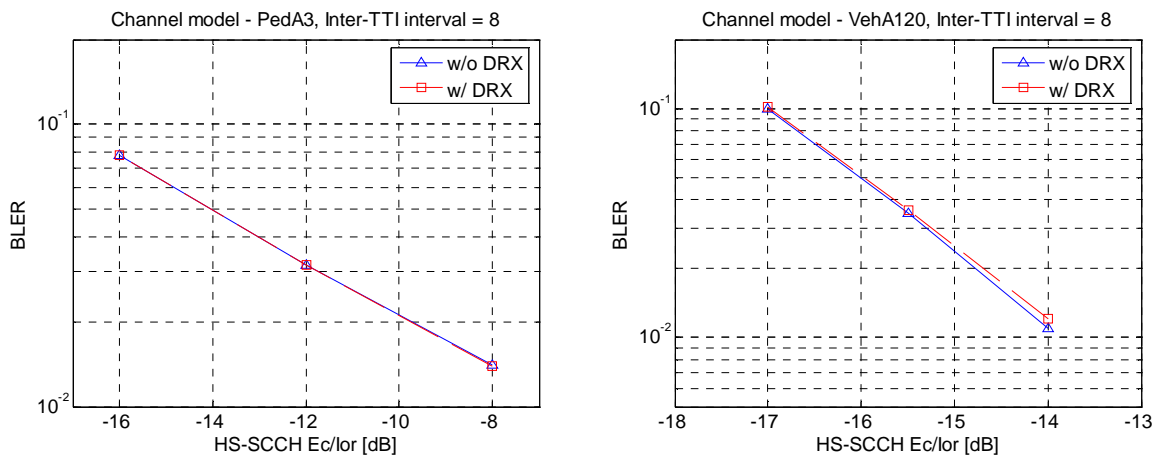

Figure 4.5.2.3.2-2: BLER of CRX and DRX cases with TTL, FTL and Inter-TTI interval = 8.

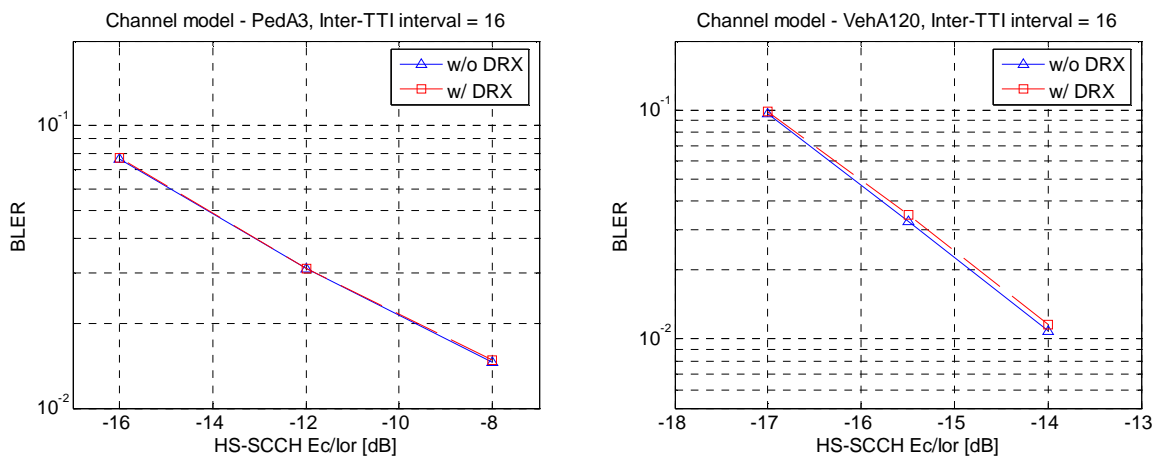

Figure 4.5.2.3.2-3: BLER of CRX and DRX cases with TTL, FTL and Inter-TTI interval = 16.

### 4.5.3 Benefits of the concept

Figure 4.5.3-1 shows the impact in power control rates as well as the possible DRX and DTX ratios that are achieved when the UE skips a number of subframes. The modes detailed earlier correspond to values on the x axis of 3, 7 and 15. It is apparent that the benefits are achieved pretty quickly, i.e. without having to skip a great number of subframes.

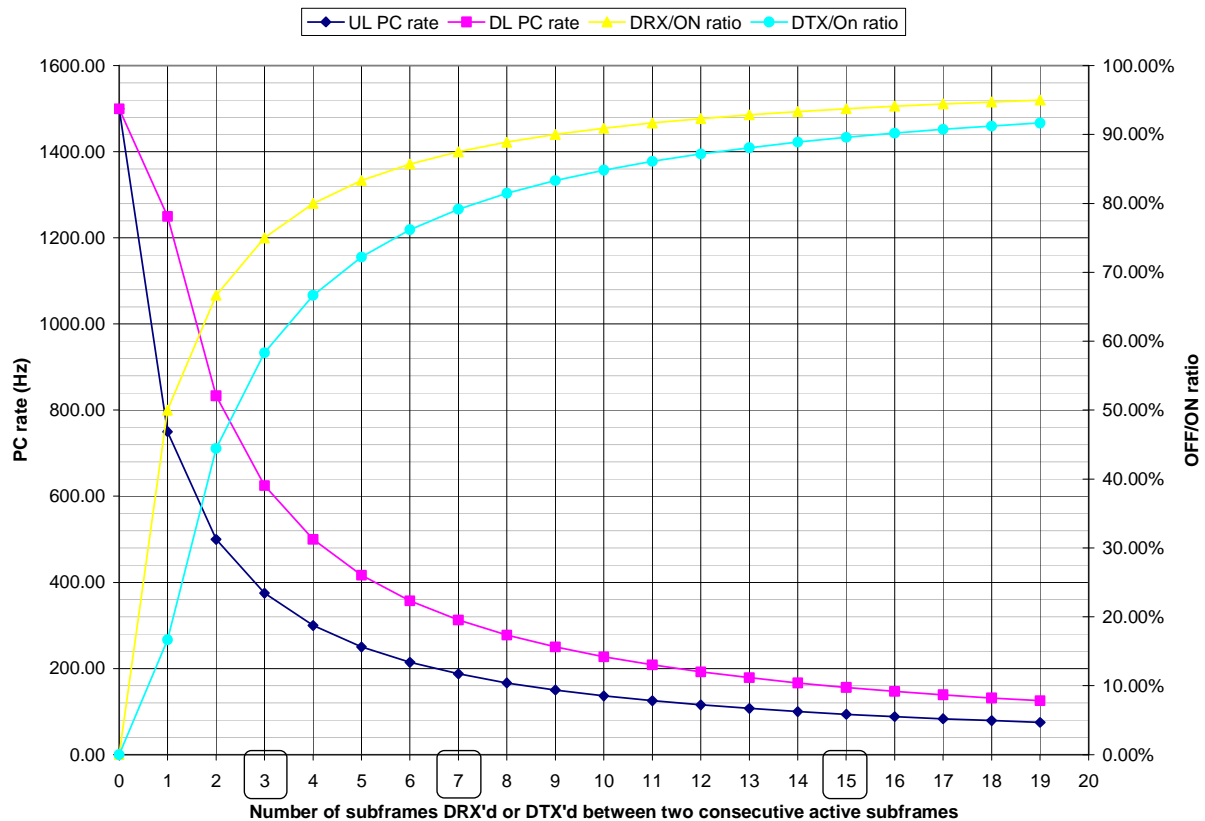

Figure 4.5.3-1: Benefits vs DTX/DRX rate

### 4.5.4 Open issues of the concept

## 4.6 Restricted HS-SCCH

### 4.6.1 Description of the concept

The objective of the restricted HS-SCCH is to reduce HS-SCCH power requirements compared to the existing Rel-6 HS-SCCH (henceforth called legacy HS-SCCH) by

- eliminating HS-SCCH transmissions during HARQ retransmissions,
- reducing the payload carried over the HS-SCCH during new transmissions, and
- jointly encoding the entire HS-SCCH payload and transmitting the codeword over all three slots of HS-SCCH transmission, in contrast to the existing scheme where part 1 and part 2 HS-SCCH information are encoded and transmitted independently. We discuss in Section 4.6.1.5 how this affects the ability of the UE to detect the HS-SCCH in time to start buffering HS-PDSCH signals.

Under the proposed scheme, higher layers configure each HSDPA flow to use either the legacy HS-SCCH or the restricted HS-SCCH that is proposed in this contribution, depending on the type of traffic carried on the flow (e.g., VoIP or best effort) and on whether or not the UE is capable of receiving the restricted HS-SCCH. Once a flow is thus configured, the Node-B transmits the specified type of HS-SCCH to the UE whenever that flow is scheduled.

The physical channel slot structure of the restricted HS-SCCH is the same as that of the legacy HS-SCCH. As in the current specification, the network configures each cell with a set of HS-SCCH channelization codes at SF128, and configures each HSDPA UE to monitor at most four of these codes. Any of the HS-SCCH channelization codes in the cell may be used in any TTI to carry either a legacy HS-SCCH or an restricted HS-SCCH. In other words, both the legacy HS-SCCH and the restricted HS-SCCH share the same set of channelization codes, and there is no need to reserve certain HS-SCCH codes for the enhanced mode of operation.

It is possible for a user to use both the legacy HS-SCCH and the restricted HS-SCCH if the user is configured with both a VoIP flow and a non-VoIP flow simultaneously. In this case, any one of the HS-SCCH codes monitored by the UE may be used in a given TTI to carry a legacy HS-SCCH or the restricted HS-SCCH in a TTI, depending on which of the user's flows is scheduled.

#### 4.6.1.1 HARQ Operation and Signalling

The following changes to HARQ operation are made for an HSDPA flow that is configured to use the restricted HS-SCCH.

- Synchronous HARQ retransmissions are used for the flow. In other words, the  $n$ th HARQ transmission for a packet is implicitly scheduled at a fixed time following the  $(n-1)$ th failed transmission, provided that HARQ is not terminated. This allows the UE to determine the time of a retransmission without relying on HS-SCCH signalling. The scheduler may still terminate HARQ for any packet arbitrarily at any time. New transmissions can be scheduled at any time, just like in the current operation.
- The restricted HS-SCCH is transmitted along with a new HARQ transmission for this flow. No HS-SCCH is transmitted for a retransmission. The possible issue of buffer corruption due to this is addressed in Section 4.6.4.1.2.
- A maximum limit is imposed on the number of HARQ transmissions for this flow. The maximum number of HARQ transmissions for the flow is configured by higher layers. Since there is no HS-SCCH transmission during retransmissions, there is a need to bound the number of retransmissions that the UE will consider after the initial transmission. In the absence of such a restriction, one can think of scenarios when the UE will be unable to determine exactly when the Node-B has terminated HARQ for a packet, thereby leading to unnecessary NACK transmissions on the HS-DPCCH.
- The restricted HS-SCCH does not carry any HARQ information. The HARQ process number is not required because of synchronous retransmissions: there is no ambiguity at the UE in associating a retransmission with the corresponding first transmission. When the restricted HS-SCCH is used, the redundancy version (RV) parameter is implicitly determined by the HARQ transmission number. The design of the sequence of RV parameters as a function of the HARQ transmission number is FFS. The new data indicator is not required since the restricted HS-SCCH is transmitted only for new transmissions.

#### 4.6.1.2 Signalling of transport format

The following modifications apply to HSDPA flows that are associated with the restricted HS-SCCH.

- Only QPSK modulation is allowed.
- Only one OVFSF code is allowed per HS-DSCH transmission, whereby the code for any transmission is chosen from a set of up to four codes that is configured by higher layers for that flow. Higher layers also signal a fixed mapping between the set of HS-SCCH codes that are monitored by the UE and a corresponding set of HS-PDSCH channelization codes, such that the HS-PDSCH channelization code used in a new HS-DSCH transmission is uniquely determined by the HS-SCCH code on which this transmission is signalled, without explicitly transmitting any channelization code information on the HS-SCCH. It is important to note that this scheme does not impose any additional restriction on the ability of the MAC-hs scheduler to schedule a particular set of code multiplexed VoIP users, compared to a scheme where one code from a pre-defined set of four channelization codes is explicitly signalled on the HS-SCCH using 2 bits. An example of how the network can allocate codes using this scheme is the following. If there are  $M$  HS-SCCH channels configured in a cell, no



more than  $M$  HS-PDSCH codes may be used in one TTI for transmission of VoIP flows, due to the restriction that each VoIP flow may use no more than one code. Therefore, the network may impose a one-to-one mapping between the set of  $M$  HS-SCCH channels and a set of  $M$  HS-PDSCH codes, and use any remaining HS-PDSCH codes only for non-VoIP flows. An example of this scheme is shown in Figure 4.6.1.2-1, where  $M=6$  HS-SCCH channels are available, and 10 OVSF codes, numbered 7 through 16, are available for HS-PDSCH. The network may establish a mapping between HS-SCCH and HS-PDSCH codes as shown in the figure. The network would then signal portions of this mapping to each UE based on the set of HS-SCCH channels that are monitored by that UE. The channelization code mapping is used only for transmissions that use the restricted HS-SCCH. Legacy HS-SCCH will continue to operate as specified in the Release-6 specification, whereby any HS-SCCH channel that is monitored by the UE may be used in conjunction with any set of HS-PDSCH channelization codes.

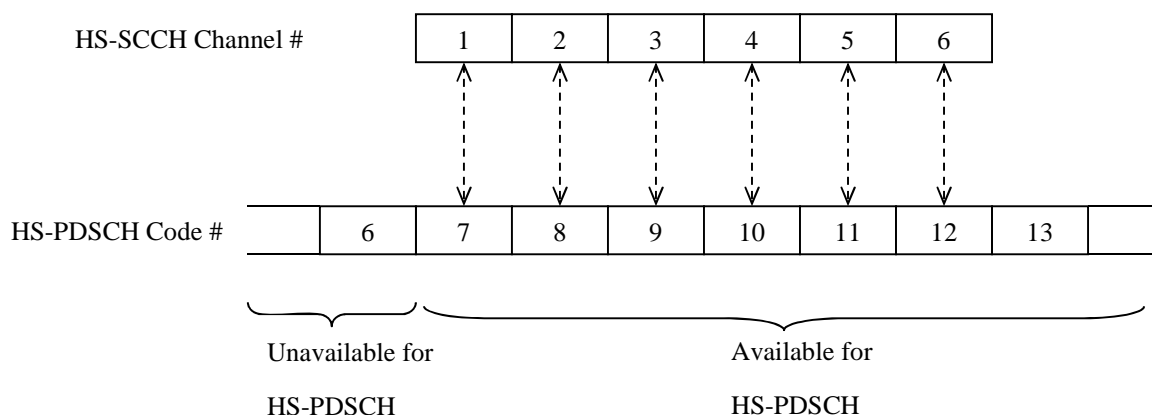

**Figure 4.6.1.2-1: Mapping between HS-SCCH channels and HS-PDSCH codes that enables the UE to determine the transmitted HS-PDSCH code without explicit signaling on HS-SCCH.**

- The channelization code used for a retransmission must be the same as the one used in the original transmission of that MAC-hs PDU.
- Choice of transport block size is limited to one of at most four different pre-configured transport block sizes. The set of up to four allowed block sizes is configured by higher layers. The restricted HS-SCCH signals an index into this set of block sizes.

The selection of the above restrictions is based on the characteristics of VoIP transmissions. Simulation studies have shown that there is no significant degradation in VoIP performance or capacity by eliminating the use of 16-QAM modulation and by limiting the number of HS-PDSCH codes per transmission to one. Simulations have also shown that no more than three block sizes are used most of the time for VoIP transmissions. Multiple block sizes are required to support silence (SID) frames and voice frame aggregation in the MAC-hs layer, whereby the MAC-hs scheduler concatenates one or more MAC-d PDUs in one MAC-hs PDU.

The size of the pre-configured set of channelization codes for a flow is selected to balance a trade-off between HS-SCCH signalling requirements and the flexibility that is provided to the scheduler in code multiplexing different VoIP users in one TTI. If the size of the set is larger than four, we will require at least one bit of additional HS-SCCH signalling for channelization code information, and thereby increase its transmit power requirements. If the size of the pre-configured set of codes is smaller than four, the scheduler may find it difficult to multiplex certain sets of users together in a TTI. If the scheduler selects a set of  $K$  users to be code multiplexed in a TTI, then for successful allocation of unique codes to each of them, the restricted channelization sets for the  $K$  users must satisfy the following criterion: there exists a code  $c(k)$  in the  $k$ th user's restricted code set such that  $c(k_1) \neq c(k_2)$  whenever  $k_1 \neq k_2$ . This becomes less likely as the size of the restricted code set is reduced.

#### 4.6.1.3 Coding for HS-SCCH

A block diagram of the restricted HS-SCCH coding chain is shown in Figure 4.6.1.3-1. The coding chain is described below.

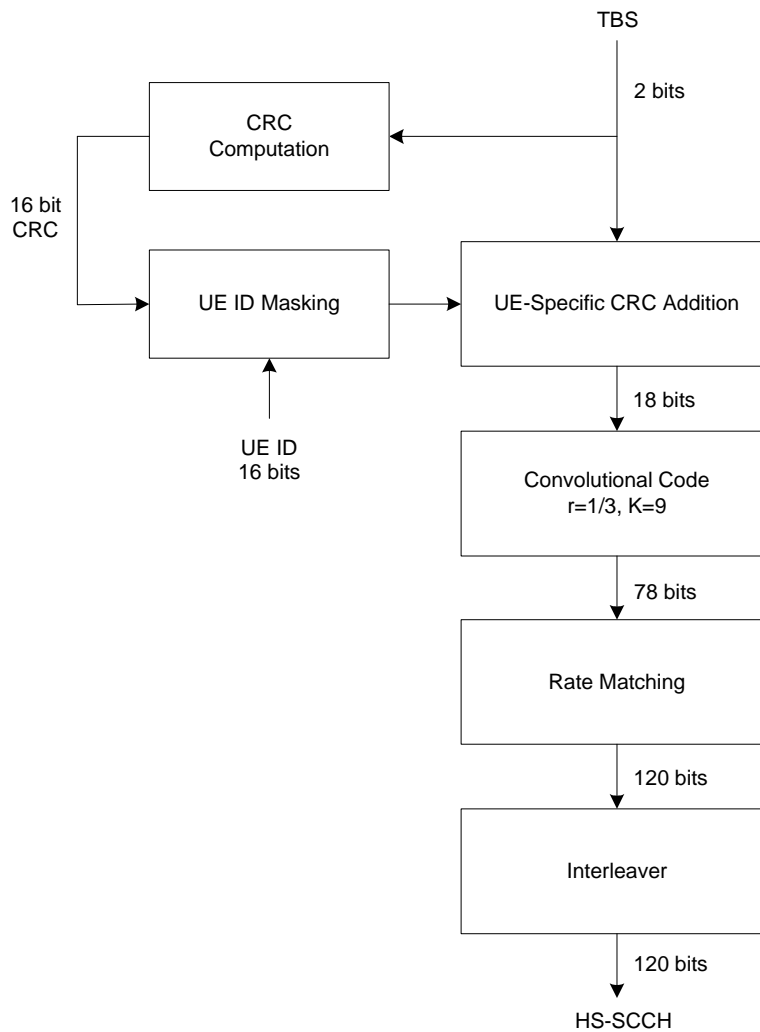

**Figure 4.6.1.3-1: Coding for restricted HS-SCCH**

- **CRC addition.** A 16-bit UE-specific CRC is added to the 2-bit TBS information. To do this, a 16-bit CRC is first computed corresponding to the 2 TBS bits, according to the specification in Section 4.2.1 in [4]. The CRC remainder is then masked with the 16-bit UE ID as specified in Section 4.6.4 in [4]. The block obtained after CRC addition is 18 bits long.
- **Channel coding.** The 18-bit block is encoded using the rate 1/3, constraint length 9 convolutional code that is used in the current HS-SCCH specification. The output of the encoder has 78 coded bits, including tail bits.
- **Rate matching.** Repetition is performed according to the specification in Section 4.2.7 in [4] to match the 78 coded bits to 120 physical channel bits.
- **Interleaving.** A channel interleaver is used on the coded bits after rate matching according to the specification of the “2<sup>nd</sup> interleaver” in Section 4.2.11 in [4].
- **Physical channel mapping.** The 120 bits from the output of the channel interleaver are mapped in sequence to the 120 physical channel bits available in the HS-SCCH subframe.

#### 4.6.1.4 HS-SCCH physical channel structure

The physical channel structure of the restricted HS-SCCH is identical to that of the legacy HS-SCCH: it has a fixed rate of 60kbps, operates at SF=128 and is transmitted over an HS-SCCH subframe that is 3 slots long. Timing of the HS-SCCH relative to HS-PDSCH also remains unchanged.

#### 4.6.1.5 UE reception of the restricted HS-SCCH

One of the consequences of encoding HS-SCCH information jointly across the whole 2ms TTI is that the UE will need to wait till the end of the HS-SCCH TTI in order to decode it. However, it may be desirable for the UE to detect the information it requires to start buffering and processing HS-PDSCH signals *before* the beginning of the corresponding HS-PDSCH transmission. A simple method is suggested in this section that can be used by the UE to detect the HS-SCCH after receiving only the first slot of HS-SCCH transmission.

The method exploits the fact that there are only four possible HS-SCCH codewords—corresponding to the four choices for transport block size—that could possibly be intended for a particular UE. The total number of codewords that may be transmitted on the restricted HS-SCCH is  $2^{18}$ , corresponding to the different values taken by the 16-bit UE ID and the 2-bit TBS. Since the UE ID is fixed for any particular UE, it is only required to detect the presence of any of the four codewords that correspond to the UE. The UE may pre-compute the list of four HS-SCCH codewords that are consistent with its UE ID, and store only the portions of these codewords that are transmitted in the first slot. Upon receiving the first slot of HS-SCCH signal, the UE would compute a confidence metric by comparing the partial received signal with the stored set of four partial codewords, and use the maximum of the four metrics as a measure of confidence that the corresponding HS-SCCH transmission was intended for it. The confidence metric may be computed based on the distance metric between the received signal and the stored partial codewords, or, equivalently, as the correlation of the received signal with the partial codewords. A decision to start buffering the corresponding HS-PDSCH code can be made by performing a threshold test on this confidence measure. Choice of the threshold can be made to ensure a desired low probability of mis-detection.

Once the UE detects that a particular restricted HS-SCCH transmission is intended for it, no other information is required from the HS-SCCH for the UE to start buffering the HS-PDSCH signal, since the channelization code is known from the HS-SCCH channel number, and modulation is always QPSK.

#### 4.6.2 Analysis of the concept

The HS-SCCH fields carried on the restricted HS-SCCH for new HARQ transmissions are described below. Table 4.6.2-1 provides a comparative summary of the HS-SCCH payload for the legacy design and the proposed restricted HS-SCCH.

**Table 4.6.2-1: Comparison of payload between the restricted HS-SCCH and legacy HS-SCCH.**

|                                      | Number of bits for the existing HS-SCCH | Number of bits for the new HS-SCCH mode |
|--------------------------------------|-----------------------------------------|-----------------------------------------|
| New data indicator                   | 1                                       | 0                                       |
| Redundancy and constellation version | 3                                       | 0                                       |
| HARQ process                         | 3                                       | 0                                       |
| Transport block size                 | 6                                       | 2                                       |
| Modulation scheme                    | 1                                       | 0                                       |
| Channelization code set              | 7                                       | 0                                       |
| UE ID                                | 16                                      | 16                                      |
| <b>Total number of bits</b>          | <b>37</b>                               | <b>18</b>                               |

- **Channelization-code-set (CCS) information (0 bits).** As described in Section 4.6.1.2, the restricted HS-SCCH does not require explicit signalling of channelization code information.
- **Modulation scheme information (0 bits).** Signalling of modulation is not required since 16-QAM is not allowed.
- **Transport block size (TBS) information (2 bits).** As described in Section 4.6.1.2, the HS-SCCH needs to identify one of four pre-defined block sizes for a VoIP flow, which requires 2 bits. The HS-SCCH transmits a 2-bit index into the pre-configured set of at most four transport block sizes that is configured by higher layers.
- **HARQ process information (0 bits).** Signalling of HARQ process information is not required because of synchronous HARQ.

- **Redundancy and constellation version (0 bits).** The RV parameters are derived from the HARQ transmission number, and are therefore not required to be signalled.
- **New data indicator (0 bits).** Since the restricted HS-SCCH is transmitted only for new transmissions, the new data indicator is not required.
- **UE identity (16 bits).** In order to signal the identity of the intended recipient UE, the restricted HS-SCCH will continue to use the 16-bit H-RNTI as the UE identity.

Based on the reduction in payload alone, and assuming that coding gain remains unchanged, the relative gain in HS-SCCH performance can be calculated as  $10\log_{10}(37/18) = 3.13$  dB. The restricted HS-SCCH also benefits from an additional coding gain, since it operates at a lower code rate than the existing HS-SCCH, which uses puncturing. Furthermore, in addition to the gains due to payload reduction and more coding, the restricted HS-SCCH yields a gain in fade margins because of joint encoding of the entire payload and transmission over three slots using an interleaver.

### 4.6.3 Benefits of the concept

- The new HS-SCCH specification requires only few changes with respect to the current standards specification.
- The required power for transmitting HS-SCCH is significantly reduced.
- Blind detection techniques for the UE are avoided.
- Soft buffer corruption in the UE is avoided as the presence of HS-SCCH is identical with the new data indication.

### 4.6.4 Open issues of the concept

#### 4.6.4.1 Unexpected and Erroneous Events

In this section, we discuss some unexpected error events that may occur when the restricted HS-SCCH is used. It is shown that some of the error events can be mitigated by following some simple rules at the transmitter, that the error events that cannot be eliminated in this manner have a very small probability of occurrence, and that each error event leads to a possible loss of no more than one MAC-hs PDU.

##### 4.6.4.1.1 ACK/NACK not received in response to a new transmission

Suppose that in a TTI in which a UE is not expecting a HARQ retransmission, the Node-B transmits a new HARQ transmission to the UE along with the corresponding restricted HS-SCCH, but the UE misses detection of the HS-SCCH. Without further corrective action the packet will be lost in this case, since HS-SCCH is not transmitted with the retransmissions, and therefore the UE will never be able to receive any of the HARQ transmissions for this packet.

This error event can be resolved by requiring that whenever the Node-B does not detect an ACK/NACK corresponding to a new transmission, it will transmit the new transmission again, along with the HS-SCCH.

##### 4.6.4.1.2 Buffer corruption

Consider the case when the UE is expecting a retransmission of a packet in a specific TTI, but the Node-B decides to transmit a fresh transmission of a new packet to the UE in that TTI. This may happen if the Node-B decides to pre-empt the retransmission with a fresh transmission, or if the Node-B had incorrectly detected an ACK when a NACK was transmitted. Suppose further that the UE misses HS-SCCH detection for this new transmission. In this case the UE will assume that it has received a retransmission of the old packet, and will HARQ-combine the received signal with the contents of the IR buffer for the old packet. This will lead to buffer corruption for the new packet, with the likely result that the new packet is lost. The effect of the error event is restricted to just one packet, however, since the UE will be able to receive the next new transmission by decoding the corresponding HS-SCCH.

Probability of the above error event is reduced by the use of a limit on the maximum number of HARQ transmissions, since it reduces the probability of the Node-B terminating HARQ of a packet without the UE's knowledge. In fact, if the MAC-hs scheduler ensures that a retransmission is never pre-empted before exhausting the maximum number of transmissions, then the only way in which buffer corruption could occur is due to a NACK  $\rightarrow$  ACK detection error followed by mis-detection of the HS-SCCH for the new transmission. Assuming independent errors on the HS-DPCCH

and HS-SCCH, the probability of this event is  $P[\text{NACK} \rightarrow \text{ACK}] * P[\text{HS-SCCH misdetection}]$ , which is smaller than 0.01%. Since this probability is much smaller than the target error rate for VoIP kind of applications, we can conclude that buffer corruption due to the restricted HS-SCCH is not a significant problem.

#### 4.6.4.1.3 HS-SCCH misdetection followed by ACK false alarm

This is a scenario in which the restricted HS-SCCH would perform better than the legacy HS-SCCH. Consider the case when HS-SCCH detection fails for a transmission, and the UE therefore does not send ACK/NACK in response, but the Node-B incorrectly detects an ACK (ACK false alarm). This causes the loss of one packet. The probability of this error event in the case of new transmissions is exactly the same for both legacy and restricted HS-SCCHs. The restricted HS-SCCH has the added advantage over the legacy channel in that, since the restricted HS-SCCH is not transmitted during retransmissions, this error event can never occur during retransmissions. The probability of this error event during a retransmission is the same as in the case of a new transmission when the legacy HS-SCCH is used. The probability that a packet is lost due to this error event can be computed as  $P[\text{HS-SCCH misdetection}] * P[\text{DTX} \rightarrow \text{ACK}]$ , which is in the order of 0.01%. The effect of such an error is localized to only one packet, since the next fresh transmission will be received once the corresponding HS-SCCH is correctly decoded.

#### 4.6.4.1.4 HS-SCCH misdetection followed by NACK false alarm

This is the same scenario as in Section 4.6.4.1.3 except that DTX is interpreted as NACK on the HS-DPCCH. This will likely not lead to a packet loss in the case of the legacy HS-SCCH since it would just lead to another retransmission which will be received by the UE. However, with the restricted HS-SCCH, this packet will be lost since the UE will not receive any retransmissions of this packet. This is also a rare event, with a probability  $P[\text{HS-SCCH misdetection}] * P[\text{DTX} \rightarrow \text{NACK}] \approx 0.01\%$  that a packet is lost in this manner. The effect of this error event is also localized to just one packet.

## 4.7 HS-SCCH-less operation

### 4.7.1 Description of the Concept

HS-SCCH adds a significant overhead to each HS-DSCH transmission. Although this overhead is relatively small for transmission of large packets of data, such as in the presence of full-buffer type of traffic, it is considerable for IMS real-time services such as VoIP.

This concept alleviates this overhead by allowing for each UE 2 HS-DSCH subframe formats to be transmitted without HS-SCCH. The new subframe format is the same as the current HS-DSCH subframe format, except that:

- The HS-SCCH is not transmitted.
- Only pre-defined 2 TB sizes are allowed. (semi-static, configurable per UE)
- Only QPSK is allowed.
- Only one pre-defined HS-PDSCH code can be used per UE. (semi-static, configured per UE)
  - Each UE is told via signalling to only listen to one particular OVFSF code for transmissions using the new subframe formats. The UE must therefore monitor that code for a transmission in addition to monitoring the HS-SCCH as in Release 5/6.
- HARQ is limited to:
  - 2 retransmissions.
  - Synchronous IR.
  - The redundancy version is pre-defined. (static, non configurable)
- The HS-PDSCH CRC is 24-bits long and is UE specific.
- Its generation follows the same procedure as the CRC currently on the HS-SCCH and therefore is covered by the 16-bit UE MAC ID.

- The UE does not transmit negative acknowledgements (NAK)
- The UE attempts reception of the regular HS-SCCH in parallel to the blind detection over the HS-PDSCH to detect scheduling with the old and with the new slot format.

## 4.7.2 Analysis of the concept

### 4.7.2.1 Transmission waveform and timing

Figure 4.7.2.1-1 depicts transmissions only using the existing subframe format. In contrast, Figure 4.7.2.1-2 depicts a transmission with a new subframe format. The new format disables transmission of the HS-SCCH, as well as negative acknowledgements.

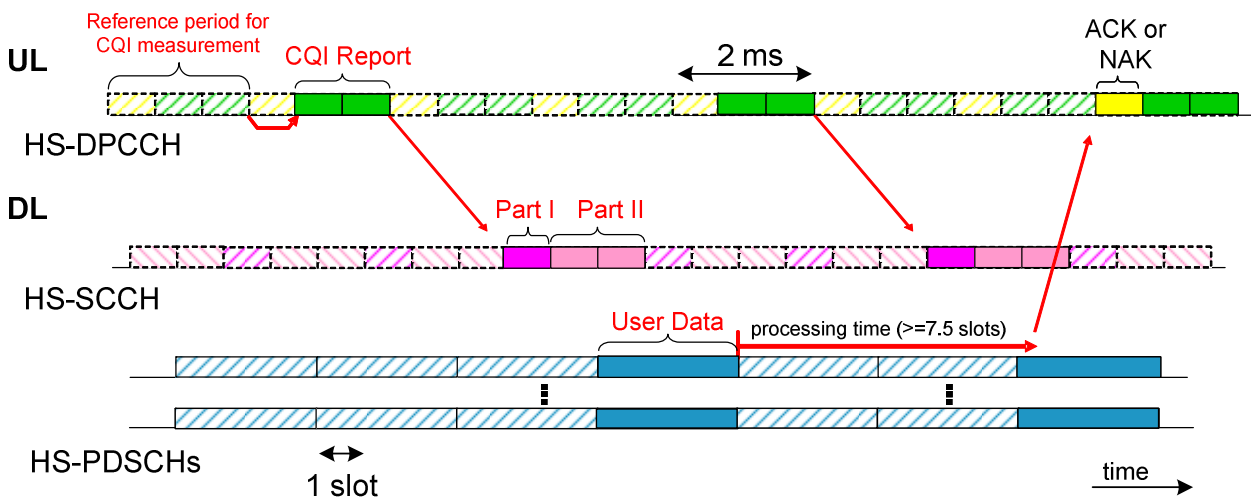

Figure 4.7.2.1-1: Transmission waveform and timing using the existing HS-DSCH subframe format

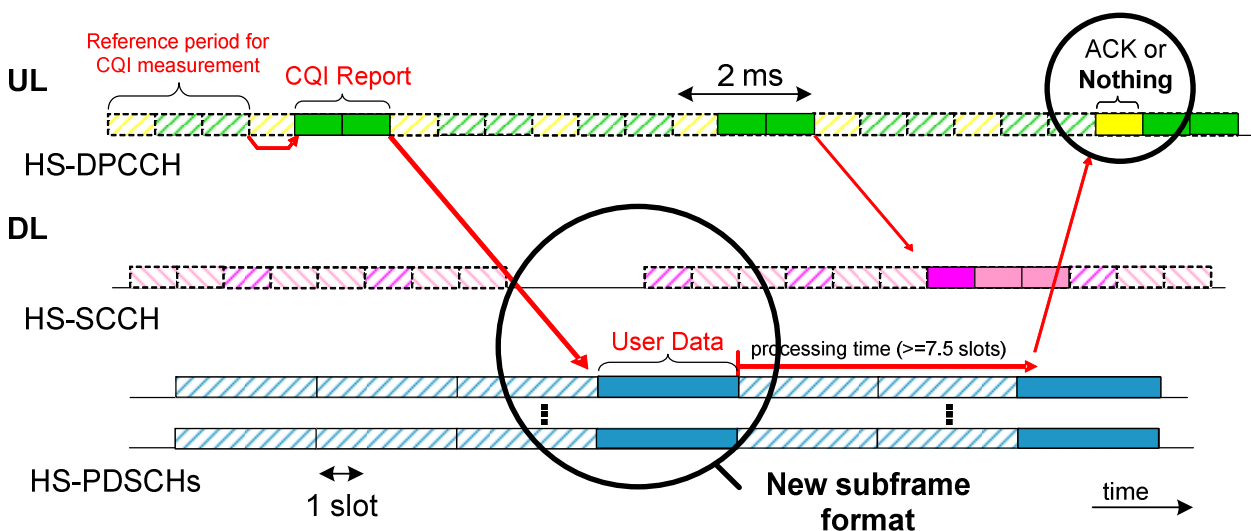

Figure 4.7.2.1-2: Transmission waveform and timing using the proposed HS-DSCH subframe format

Note how new and old subframe formats can be intermixed. Note also that in this depiction of the timing the ACK processing time is unchanged for the new formats.

To implicitly convey the control information in the HS-SCCH, the following list goes over the HS-SCCH fields and their mapping to the HS-SCCH less operation:

- Modulation used (1 bit):
  - Always QPSK.
- OVSF codes used (7 bits):
  - One pre-defined (semi-static) code. (P=1)
- Transport Format Resource Indicator (6 bits):
  - Only 2 possible values. Blindly determined by the UE.
- HARQ process number (3 bits):
  - Not needed because synchronous IR is used.
- Redundancy version (3 bits):
  - Pre-defined (static) redundancy versions for each transmission.
- New data indicator (1 bit):
  - Not needed because synchronous IR with pre-defined redundancy versions is used.
- CRC / User identity (16 bits):
  - Not needed because carried over HS-PDSCH transmission.

#### 4.7.2.2 UE complexity discussion

When an HS-SCCH-less transmission occurs the UE does not know the payload size, or the HARQ information for combining. The UE must therefore blindly decode for both of the possible payload sizes. Furthermore, since synchronous IR with 3 transmissions is used, the UE must decode for all 3 possibilities: current TTI is a 1<sup>st</sup> transmission, current TTI is a 2<sup>nd</sup> transmission and current TTI is a 3<sup>rd</sup> transmission. The UE must therefore perform a total of  $2 \times 3 = 6$  blind decodes.

The first 3 blind decodes are based on the assumption that a somewhat small payload was transmitted, of at most N1 bits. This would correspond, for example, to an AMR-NB full-rate frame. The next 3 blind decodes are based on the assumption that a very small payload was transmitted, of at most N2 bits. Both N1 and N2 are semi-static values.

In order to minimize complexity we set

- N1 = 353 bits; this is sufficient to carry a 12.2 kbit/s AMR-NB or 12.6 kbit/s AMR-WB speech frame.
- N2 = 161 bits; this is sufficient to carry an AMR-NB or AMR-WB SID frame.

To control complexity of the de-interleaving and rate-matching process we restrict the redundancy versions of successive transmissions to be  $X_{rv} = (0, 0, 0)$ . In other words energy combining ("Chase" combining) is used. There is virtually no performance loss in fixing the redundancy versions in such a manner, since the code-rate of these small payloads is already close or at the lowest code-rate achievable by our code ( $R=1/3$ ).

With these assumptions in hand, the main complexity resides in the ability to performing the 6 decodes. The first 3 decodes are for a payload of at most N1 = 353 bits. The 3 next decodes are for a payload of at most N2= 161. The total number of bits that need to be decoded is therefore at most  $3 \times 353 + 3 \times 161 = 1.542$  bits.

Consider that the lowest capability UE (Categories 11 and 12) must be able to Turbo decode 3.630 bits in that same amount of time (and process up to 14.000 soft channel bits). Furthermore the UEs typically deployed nowadays can decode 7.298 bits.

Noting that there is no other Turbo decoding on the HS-DSCH required when HS-SCCH-less operation occurs, we conclude that the proposed HS-SCCH-less operation can be accommodated within the existing Release 5 UE complexity.

Note that parallel decoding of the HS-SCCH within a subframe happens in the same way as in regular Rel-5 operation.

### 4.7.2.3 CRC discussion

If a 16-bit CRC was to be used for HS-PDSCH transmissions for the HS-SCCH-less formats, instead of the traditional 24-bit CRC, the false alarm rate would be  $2^{-16}$ .

At each TTI the UE decodes 6 possible ways; if any of these decodes incorrectly triggers the CRC to check, a packet will be incorrectly forwarded to the upper-layers.

With 6 decodes per TTI and a false alarm rate of  $2^{-16}$ , we get that the mean time between false alarms will be:

$$\frac{2 \cdot 10^{-3}}{6 \cdot 2^{-16}} = 21.8 \text{ seconds}$$

With a 24-bit CRC we get a false alarm rate of

$$\frac{2 \cdot 10^{-3}}{6 \cdot 2^{-24}} = 5592 \text{ seconds} = 93 \text{ minutes}$$

From the above false alarm computations for both CRC lengths, retaining the 24-bit CRC for HS-PDSCH is, therefore, recommended. Since the UE MAC ID is 16 bits, just part of the HS-PDSCH CRC will be covered by the UE MAC ID.



4.7.2.4 VoIP and best effort capacity simulations

4.7.2.4.1 Simulation assumptions

| Multipath channel models             | AWGN, PB3, and VA30<br>Fader type: JTC.                                                                                                                                                                                                                                                                                                                                                                                                                                                                                                                                                                                                                                                                                                                                                                                                                                                                       |         |    |    |       |     |   |         |     |   |         |     |   |        |     |   |      |     |   |      |     |   |
|--------------------------------------|---------------------------------------------------------------------------------------------------------------------------------------------------------------------------------------------------------------------------------------------------------------------------------------------------------------------------------------------------------------------------------------------------------------------------------------------------------------------------------------------------------------------------------------------------------------------------------------------------------------------------------------------------------------------------------------------------------------------------------------------------------------------------------------------------------------------------------------------------------------------------------------------------------------|---------|----|----|-------|-----|---|---------|-----|---|---------|-----|---|--------|-----|---|------|-----|---|------|-----|---|
| Cell layout and link budget          | According to TR 25.848:<br>Site-to-site distance: 2.8 km.<br>3-cells per site.<br>Node B Tx power: 44 dBm.<br>Log-normal shadowing: 8 dB.<br>Shadow-correlation between co-located cells: 1.0.<br>Shadow-correlation between non co-located cells: 0.5.<br>Carrier frequency: 2 GHz.<br>Bandwidth: 5 MHz.<br>Number of UE antennas: 1.                                                                                                                                                                                                                                                                                                                                                                                                                                                                                                                                                                        |         |    |    |       |     |   |         |     |   |         |     |   |        |     |   |      |     |   |      |     |   |
| Node B resources                     | Power reserved for common channels and DPCH for all users: 7.5 Watt (30%)<br>3 Watt for common channels + 1 Watt / ~100 users for DPCH.<br>Remaining power for all HS-SCCH and HS-PDSCH: 17.5 Watt<br>OVSF codes reserved for common channels: <table border="1" data-bbox="593 629 1018 880"> <thead> <tr> <th>Channel</th> <th>SF</th> <th>Nb</th> </tr> </thead> <tbody> <tr> <td>CPICH</td> <td>256</td> <td>1</td> </tr> <tr> <td>P-CCPCH</td> <td>256</td> <td>1</td> </tr> <tr> <td>S-CCPCH</td> <td>256</td> <td>1</td> </tr> <tr> <td>E-AGCH</td> <td>256</td> <td>1</td> </tr> <tr> <td>AICH</td> <td>256</td> <td>1</td> </tr> <tr> <td>PICH</td> <td>256</td> <td>1</td> </tr> </tbody> </table><br>OVSF code usage modeled for dedicated channels:<br>F-DPCH<br>Soft-handover overhead: 1.8<br>Up to 8 simultaneous HS-SCCH transmissions allowed.<br>HS-SCCH code collisions were not modelled. | Channel | SF | Nb | CPICH | 256 | 1 | P-CCPCH | 256 | 1 | S-CCPCH | 256 | 1 | E-AGCH | 256 | 1 | AICH | 256 | 1 | PICH | 256 | 1 |
| Channel                              | SF                                                                                                                                                                                                                                                                                                                                                                                                                                                                                                                                                                                                                                                                                                                                                                                                                                                                                                            | Nb      |    |    |       |     |   |         |     |   |         |     |   |        |     |   |      |     |   |      |     |   |
| CPICH                                | 256                                                                                                                                                                                                                                                                                                                                                                                                                                                                                                                                                                                                                                                                                                                                                                                                                                                                                                           | 1       |    |    |       |     |   |         |     |   |         |     |   |        |     |   |      |     |   |      |     |   |
| P-CCPCH                              | 256                                                                                                                                                                                                                                                                                                                                                                                                                                                                                                                                                                                                                                                                                                                                                                                                                                                                                                           | 1       |    |    |       |     |   |         |     |   |         |     |   |        |     |   |      |     |   |      |     |   |
| S-CCPCH                              | 256                                                                                                                                                                                                                                                                                                                                                                                                                                                                                                                                                                                                                                                                                                                                                                                                                                                                                                           | 1       |    |    |       |     |   |         |     |   |         |     |   |        |     |   |      |     |   |      |     |   |
| E-AGCH                               | 256                                                                                                                                                                                                                                                                                                                                                                                                                                                                                                                                                                                                                                                                                                                                                                                                                                                                                                           | 1       |    |    |       |     |   |         |     |   |         |     |   |        |     |   |      |     |   |      |     |   |
| AICH                                 | 256                                                                                                                                                                                                                                                                                                                                                                                                                                                                                                                                                                                                                                                                                                                                                                                                                                                                                                           | 1       |    |    |       |     |   |         |     |   |         |     |   |        |     |   |      |     |   |      |     |   |
| PICH                                 | 256                                                                                                                                                                                                                                                                                                                                                                                                                                                                                                                                                                                                                                                                                                                                                                                                                                                                                                           | 1       |    |    |       |     |   |         |     |   |         |     |   |        |     |   |      |     |   |      |     |   |
| IMS VoIP packet format and overheads | VoIP packet with payload according to RFC3267.<br>24-bit ROHC overhead.<br>16-bit RLC overhead.<br>No voice packet bundling.                                                                                                                                                                                                                                                                                                                                                                                                                                                                                                                                                                                                                                                                                                                                                                                  |         |    |    |       |     |   |         |     |   |         |     |   |        |     |   |      |     |   |      |     |   |
| VoIP traffic details                 | AMR 12.2 kbps.<br>SID transmitted every 160 ms of silence.<br>Voice activity model:<br>50% voice activity.<br>ON and OFF periods of duration exponentially distributed, of average 3 seconds.<br>100 ms maximum delay bound with SDU discarding at the MAC-hs.                                                                                                                                                                                                                                                                                                                                                                                                                                                                                                                                                                                                                                                |         |    |    |       |     |   |         |     |   |         |     |   |        |     |   |      |     |   |      |     |   |
| Best-effort (BE) traffic             | Full-buffer traffic.<br>5 users per cell at fixed geometries {0, 1.5, 2.5, 3, 5dB}. <sup>1</sup><br>SDU size: 320 bit                                                                                                                                                                                                                                                                                                                                                                                                                                                                                                                                                                                                                                                                                                                                                                                         |         |    |    |       |     |   |         |     |   |         |     |   |        |     |   |      |     |   |      |     |   |
| Signalling traffic                   | SRB, RTCP, and SIP not modeled.                                                                                                                                                                                                                                                                                                                                                                                                                                                                                                                                                                                                                                                                                                                                                                                                                                                                               |         |    |    |       |     |   |         |     |   |         |     |   |        |     |   |      |     |   |      |     |   |
| Parameters of New HS-DSCH Format     | Synchronous IR.<br>TB sizes: 137 bits, and 317 bits with 24 Bit CRC.<br>No DRX or DTX.<br>Each user is assigned one of the available HS-PDSCH codes at call setup.<br>OVSF code collision and fragmentation is explicitly modelled.                                                                                                                                                                                                                                                                                                                                                                                                                                                                                                                                                                                                                                                                           |         |    |    |       |     |   |         |     |   |         |     |   |        |     |   |      |     |   |      |     |   |
| Scheduler                            | Voice traffic scheduled first, then best-effort (BE) traffic scheduled next.<br>Voice traffic scheduler:<br>Exponential scheduling rule with $a_i = 1$ .<br>BE traffic scheduler:<br>Proportional Fair.                                                                                                                                                                                                                                                                                                                                                                                                                                                                                                                                                                                                                                                                                                       |         |    |    |       |     |   |         |     |   |         |     |   |        |     |   |      |     |   |      |     |   |
| Feedback delays                      | CQI delay: 8 slots from time of measure to start of HS-PDSCH transmission.<br>HARQ delay: minimum 15 slots from end of a transmission to start of a re-transmission.                                                                                                                                                                                                                                                                                                                                                                                                                                                                                                                                                                                                                                                                                                                                          |         |    |    |       |     |   |         |     |   |         |     |   |        |     |   |      |     |   |      |     |   |
| Error modelling                      | HS-PDSCH:<br>Threshold-based decoder.<br>Energy combining assumed.<br>HS-SCCH: Threshold-based decoder.<br>CQI: perfect estimation with quantization errors.<br>HS-DPCCH: HARQ feedback errors modelled with ACK false alarm probability of $10^{-3}$ and ACK mis-detection probability of $10^{-2}$ .<br>No channel estimation modelled.                                                                                                                                                                                                                                                                                                                                                                                                                                                                                                                                                                     |         |    |    |       |     |   |         |     |   |         |     |   |        |     |   |      |     |   |      |     |   |

### 4.7.2.4.2 Simulation results

The system integrates modeling of simultaneously using new formats with synchronous IR and 3 transmissions as well as old formats with asynchronous IR and 4 transmissions. The simulations also explicitly track OVSF code usage for the HS-PDSCH, model code collision and OVSF space segmentation.

The results highlight the relationship between real-time services load and best-effort (BE) throughput by characterizing the increase in BE throughput due to the introduction of the new subframe format for the real-time services.

The real-time service modeled in these simulations is VoIP IMS using the AMR 12.2 kbit/s vocoder. The simulations consider 5 BE users per cell with the following assigned geometries {0, 1.5, 2.5, 3, 5dB}. Detailed simulation assumptions are explained in section 4.7.2.4.1.

Figure 4.7.2.4.2-1, Figure 4.7.2.4.2-2 and Figure 4.7.2.4.2-3 plot the variation of total best-effort throughput with increasing number of VoIP users for systems without and with the introduction of the new subframe format. Results exhibit a significant increase in BE throughput for the range of 50-100 VoIP users. As observed, the relative performance gains in terms of BE throughput increases as the number of VoIP users (allowed to use to the new subframe format) in the system increase. As the system approaches the VoIP user capacity, the BE throughput goes to 0. This is because the BE users utilize only the residual throughput and are scheduled after the VoIP users.

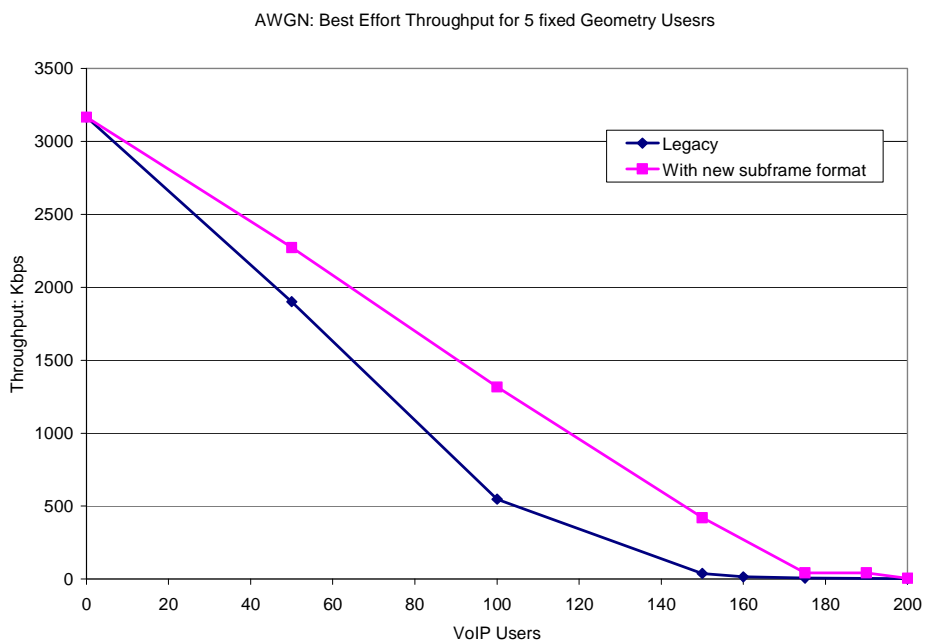

Figure 4.7.2.4.2-1: Performance Results – AWGN channel

<sup>1</sup> The geometries were fixed in order to accelerate simulation run-time. These geometries were randomly selected to represent typical values in a system.

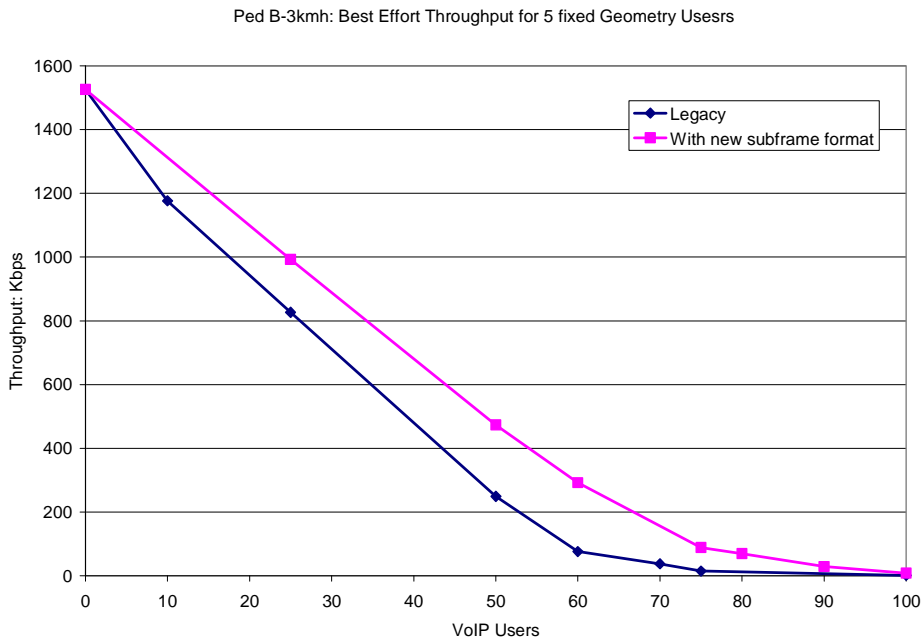

Figure 4.7.2.4.2-2: Performance Results – Ped B, 3 km/h channel

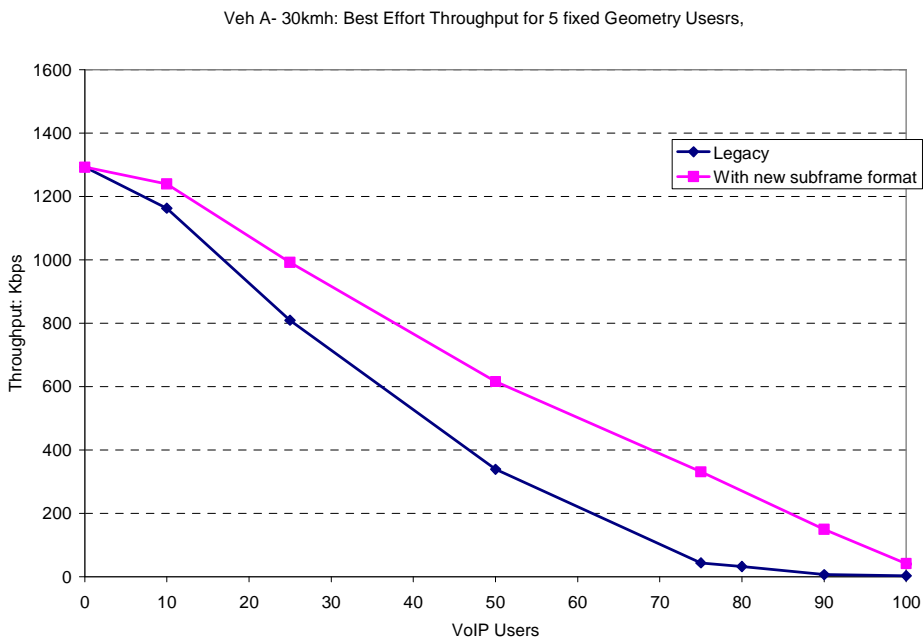

Figure 4.7.2.4.2-3: Performance Results – Veh A, 30 km/h channel

As an example, assume the system of Figure 4.7.2.4.2-2 with a load of 50 VoIP users (or an equivalent of some other multimedia users such as gaming or video-telephony). The introduction of the HS-SCCH-less operation offers the following possible benefits:

- Increase the number of VoIP users from 50 to 70 users, without impacting the best-effort throughput.
- Maintain 50 VoIP users, and the best-effort throughput will be increased 2.7 times.
- Flexibly to operate between the previous two points of operation.

### 4.7.3 Benefits of the concept

The new subframe format propose is backward compatible, does not introduce any significant waveform changes, and provides the following capacity benefits:

- Significant increase in DL capacity for real-time services.
- Significant increase in available best-effort throughput on the DL for a given load of real-time services.

Although simulations presented were limited to IMS VoIP with AMR 12.2 kbit/s, it is expected that the benefit extends to other types of real-time services such as gaming and video-over-IP.

### 4.7.4 Open issues of the concept

## 4.8 Reduced complexity HS-SCCH-less operation

### 4.8.1 Description of the concept

The relative overhead consumed by HS-SCCH becomes significant when it is used to transport small packets, such as those generated in the transport of low-latency low data-rate traffic like VoIP and gaming over HSDPA.

The full HS-SCCH-less operation, as described in TR 25.903 Section 4.7, reduces this overhead by removing the HS-SCCH completely for two of the HS-DSCH subframe formats (i.e. TB size and MCS). It relies on synchronous IR and blind combining & decoding to eliminate the need for the HS-SCCH.

This concept, the reduced complexity HS-SCCH-less operation, lessens the HS-SCCH overhead by allowing 4 of the HS-DSCH subframe formats to be transmitted without HS-SCCH with the first HARQ transmission. On the other hand, HARQ retransmissions are accompanied by the HS-SCCH.

More specifically, when the UE is set up in reduced complexity HS-SCCH-less operation, the traffic is delivered to the UE as follows.

- The HS-SCCH is not transmitted with first HARQ transmissions.
- The modulation used is restricted to QPSK.
- Only 4 pre-defined TB formats for MAC-hs PDUs are allowed.
  - These 4 formats are chosen semi-statically, and maybe independently configured per UE.
- The HS-PDSCH CRC is 24-bits long and is UE specific.
  - Its generation follows the same procedure as the CRC currently on the HS-SCCH, and therefore is covered by the 16-bit UE MAC ID.
- At most two contiguous pre-defined HS-PDSCH OVSF codes are assigned per UE. (semi-static, configured per UE, multiple UEs can share the codes)
  - Each UE is told via RRC signalling to listen to one particular HS-PDSCH OVSF code for transmissions of the chosen 4 TB formats. The UE therefore monitors that code and the neighboring code for a transmission by blind decoding of the 4 chosen formats.
- The UE does not transmit negative acknowledgements (NACK) in the first transmission when decoding the chosen formats. It transmits ACK or NACKs for the retransmissions.
- HARQ is limited to:
  - 2 retransmissions.
  - The redundancy version is pre-defined. (static, non configurable)

- The HARQ retransmissions are accompanied by an HS-SCCH, which is sent with the same channel coding and decoding as the Release 5/6 HS-SCCH. Some of the bits of the HS-SCCH are reinterpreted in order to signal the UE the following information.
  - That the HS-SCCH is for the Reduced Complexity HS-SCCH operation
  - Whether the retransmission is the first retransmission or the second retransmission
  - The channelization code and the transport block size used by the HARQ process
  - The HARQ combining information – in the form of an offset from the current TTI indicating where the previous transmission was sent
- The detailed fields in the interpretation of the HS-SCCH are described in Section 4.X.2
- In addition, just as in Release 5/6 operation, the UE continues to attempt reception of the regular HS-SCCH and corresponding HS-PDSCH codes if any and carries out HARQ the regular way.

#### 4.8.1.1 HS-SCCH for retransmissions with the reduced complexity HS-SCCH-less operation

As described in Section 4.8.1, the HS-SCCH is not included with the first HARQ transmission, but is included with the HARQ retransmissions. The coding of the HS-SCCH is unchanged – only the meaning of the bits is modified under this operation.

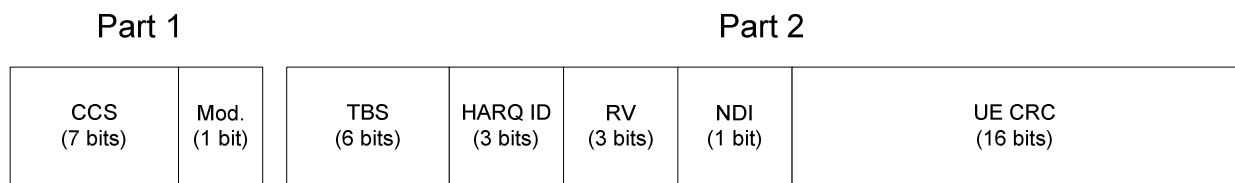

**Figure 4.8.1.1-1: Structure of the HS-SCCH for legacy transmissions**

Figure 4.8.1.1-1 depicts the existing HS-SCCH format. Part 2 contains the information necessary for HARQ combining.

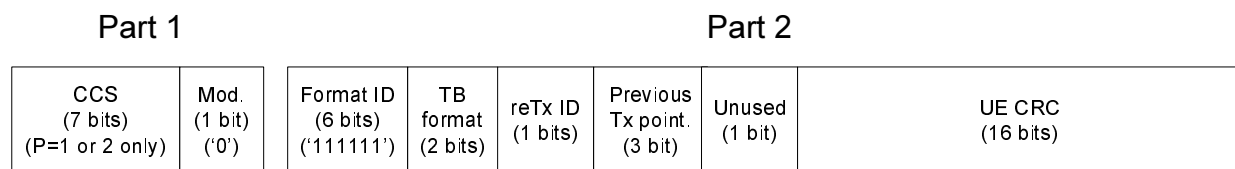

**Figure 4.8.1.1-2: Structure of the HS-SCCH for retransmissions using the reduced complexity HS-SCCH-less operation**

Figure 4.8.1.1-2 depicts the structure of the HS-SCCH used for retransmissions in the reduced complexity HS-SCCH-less operation. The Format ID ‘111111’ corresponds to a TB size that was never used in practice for legacy transmissions because it has a code-rate of R=0.99. The combination of Format ID = ‘111111’ and CCS with P=1 or P=2 is used to indicate to the UE that this is a reduced complexity HS-SCCH-less retransmission.

Referring again to Figure 4.8.1.1-2, the interpretation of CCS and Modulation index of Part 1 is the same as for the legacy HS-SCCH, except that the P value signalled through the CCS must be consistent with the HS-SCCH-less TB format that was pre-configured through RRC signalling (see Section 4.X.1). Furthermore, since only QPSK is allowed for HS-SCCH-less operation the Modulation bit will always be set to ‘0’.

The content of Part 2 is re-defined as follows:

- Format ID: 6 bits indicate in combination with CCS (P=1 or 2) that this is an HS-SCCH-less retransmission.
- TB Format: 2 bits indicate which pre-configured TB size is being transmitted.
- reTx ID: 1 bit indicates whether this a 2<sup>nd</sup> transmission (‘0’) or a 3<sup>rd</sup> transmission (‘1’).

- Previous Transmission Pointer: 3 bits indicates the offset from the current TTI, in number of TTIs the time of the previous transmission: {6 TTIs, 7 TTIs, 8 TTIs, ...}
- UE-Specific CRC: unchanged.

The redundancy version is pre-defined to follow the following sequence for the 3 HARQ transmissions: {s=1 r=0, s=0 r=1, s=1 r=2}. The reTx ID field therefore indicates which redundancy version is being transmitted.

The NDI bit is not needed since HARQ transmissions are limited to 3 and the reTx ID avoids the ambiguity that existed in legacy transmissions.

## 4.8.2 Analysis of the concept

### 4.8.2.1 Timing and operation

The timing of the reduced complexity HS-SCCH-less operation is similar to the timing in Release 5/6 HSDPA operation. It is depicted in Figure 4.8.2.1-1.

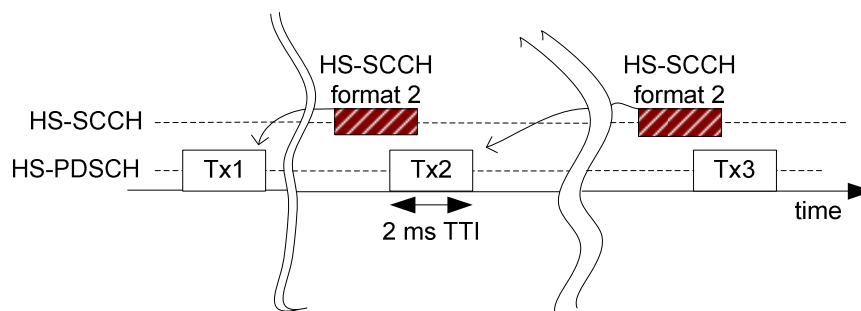

**Figure 4.8.2.1-1: Illustration of the reduced complexity HS-SCCH-less operation**

The first and second retransmissions can be asynchronous with respect to the first transmission, and with respect to each other. The accompanying HS-SCCH follows the same timing relationship with the HS-PDSCH transmission as legacy transmissions do; namely the HS-SCCH starts and ends one slot before the HS-PDSCH transmission boundaries.

If the UE is able to decode the first transmission successfully, it sends an ACK to the Node B over the HS-DPCCH. If it is not able to decode the first transmission, it buffers the data sent on the TTI. The retransmissions do not require any blind combining or decoding operation as the HS-SCCH accompanying the retransmissions carry the information needed. The inclusion of systematic bits in the HS-SCCH of third retransmission provides robustness against HS-SCCH losses.

### 4.8.2.2 UE Complexity discussion

The operation requires the UE to perform blind decoding every TTI of the transport format from 4 possibilities. but requires no blind combining. These 4 transport formats will typically carry small payloads (less than 1,000 bits).

### 4.8.2.3 Simulation Results

Figure 4.8.2.3-1 and Figure 4.8.2.3-2 depict the VoIP capacity for channel models PB3 and VA30. The performance of the legacy operation (Release 6) is compared to that of

- The original HS-SCCH-less proposal from TR 25.903, Section 4.7-- “Original HS-SCCH-less: 2 TB sizes”
- The original HS-SCCH-less proposal augmented with 4 TB size -- “Original HS-SCCH-less: 4 TB sizes”
- The proposed reduced complexity HS-SCCH-less proposal – “Reduced complexity HS-SCCH-less: 4 TB sizes”

Figure 4.8.2.3-3 and Figure 4.8.2.3-4 depict the Best Effort throughput of 5 fixed Best Effort users when the number of VoIP users is kept at medium load. It shows that a significant advantage in Best Effort throughput can be obtained because of the overhead reduction and freeing up of HS-SCCH codes for Best Effort traffic.

These results demonstrate that the reduced complexity HS-SCCH-less proposal captures the gains of the original HS-SCCH-less proposal, while maintaining a significantly lower complexity both at the UE as well as the Node B through increased flexibility.

The reduced complexity HS-SCCH-less operation achieves a significant reduction in the HS-SCCH overhead because the HS-SCCH overhead is only incurred during retransmissions. In these two scenarios the fraction of transmissions that were retransmissions was 15%.

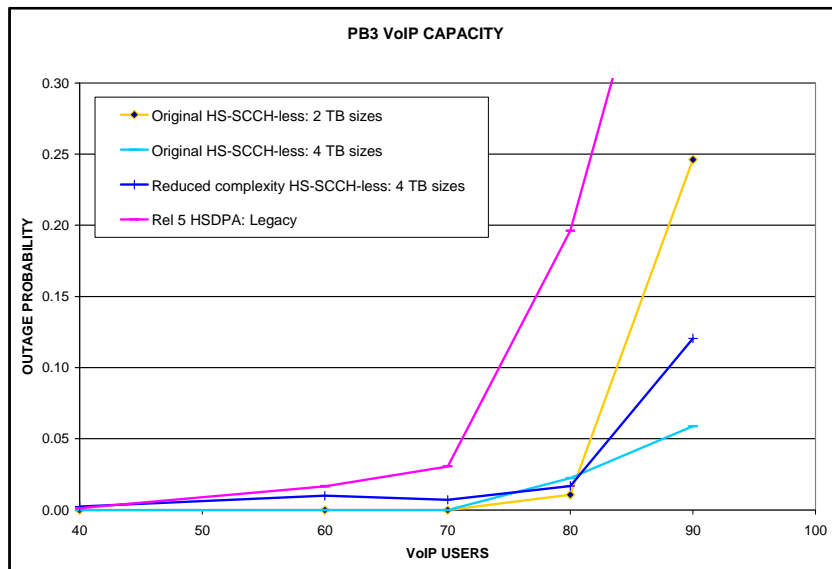

Figure 4.8.2.3-1: Comparison of VoIP capacity for the Ped B 3 km/h channel model

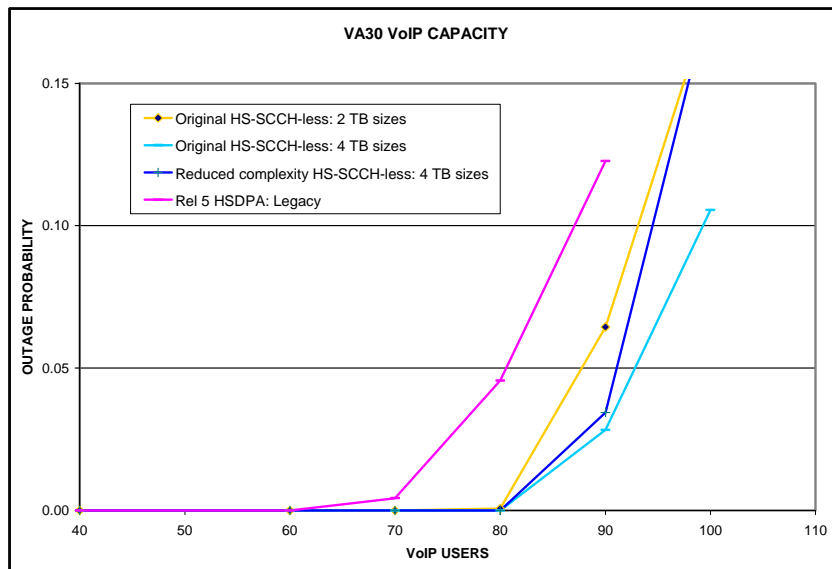

Figure 4.8.2.3-2: Comparison of VoIP capacity for the Veh A 30 km/h channel model



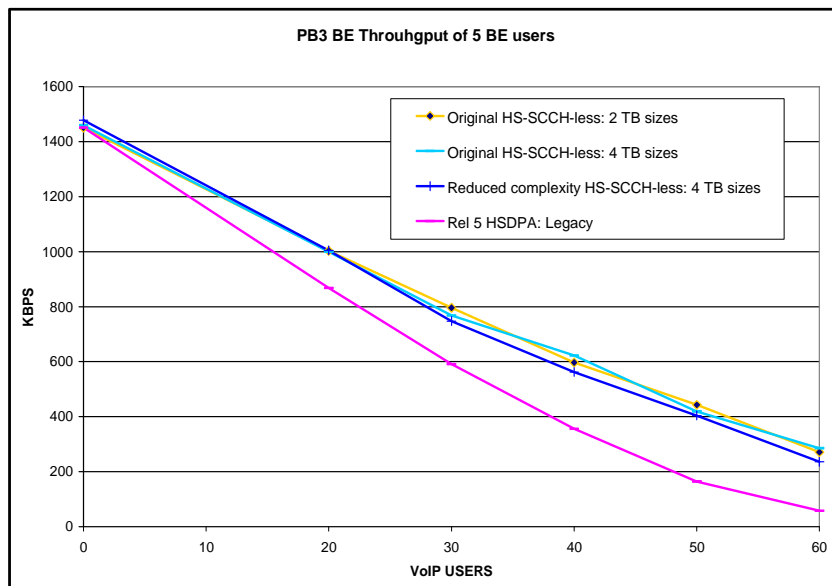

Figure 4.8.2.3-3: Best Effort throughput of 5 fixed geometry users as a function of VoIP load for the Ped B 3km/h channel model

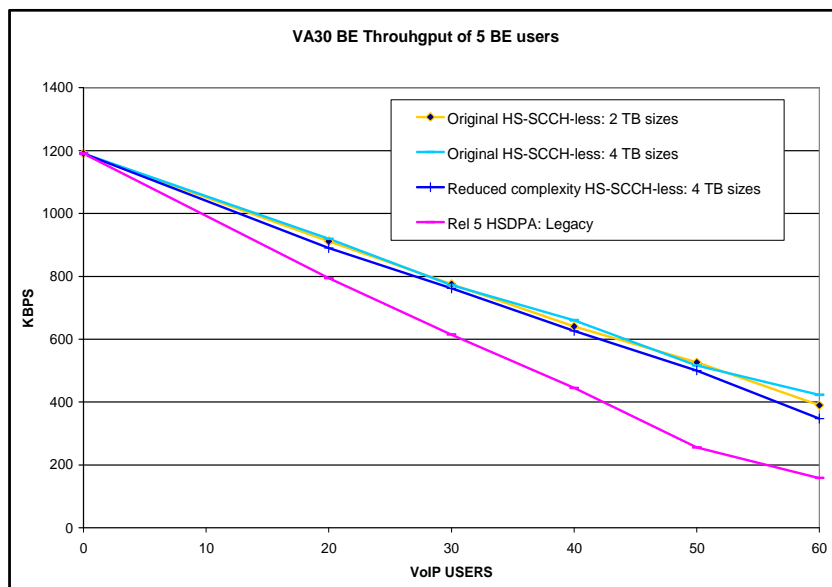
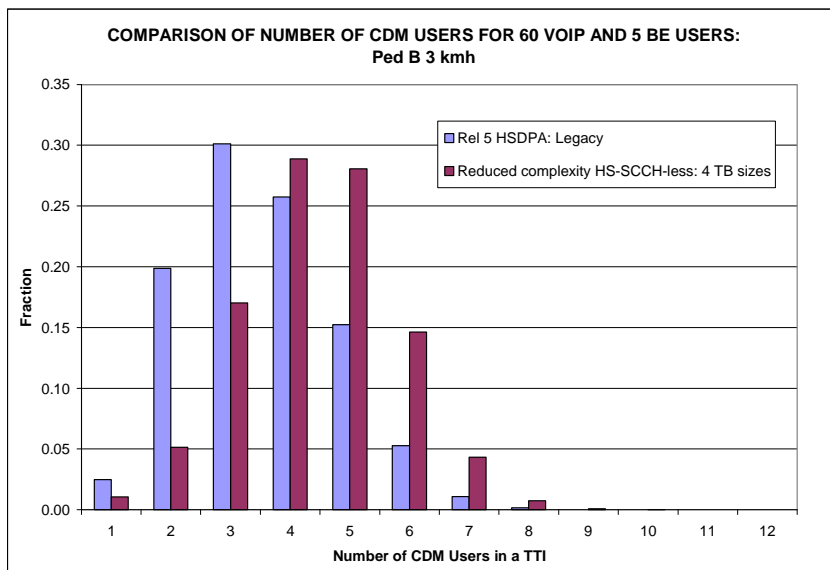

Figure 4.8.2.3-4: Best Effort throughput of 5 fixed geometry users as a function of VoIP load for the Veh A 30 km/h channel model



**Figure 4.8.2.3-5: Statistics of the number of simultaneously scheduled users (CDM) for legacy and new operation, in the presence of 60 VoIP and 5 Best Effort users for the Ped B 3 km/h channel. (Maximum number of simultaneous HS-SCCH transmissions fixed to 8)**

4.8.2.3.1 Simulation assumptions

| Multi-path channel models             | VA 30 km/h and PB 3 km/h<br>Fader type: JTC.                                                                                                                                                                                                                                                                                                                                                                                                                                                                                                                                                                                                                                                                                                                                                                                                                                                                                                                                              |         |    |    |       |     |   |         |     |   |         |     |   |        |     |   |      |     |   |      |     |   |
|---------------------------------------|-------------------------------------------------------------------------------------------------------------------------------------------------------------------------------------------------------------------------------------------------------------------------------------------------------------------------------------------------------------------------------------------------------------------------------------------------------------------------------------------------------------------------------------------------------------------------------------------------------------------------------------------------------------------------------------------------------------------------------------------------------------------------------------------------------------------------------------------------------------------------------------------------------------------------------------------------------------------------------------------|---------|----|----|-------|-----|---|---------|-----|---|---------|-----|---|--------|-----|---|------|-----|---|------|-----|---|
| Cell layout and link budget           | According to TR 25.848 (section A.3):<br>Site-to-site distance: 2.8 km.<br>3-cells per site.<br>Node B Tx power: 44 dBm.<br>Log-normal shadowing: 8 dB.<br>Shadow-correlation between co-located cells: 1.0.<br>Shadow-correlation between non co-located cells: 0.5.<br>Carrier frequency: 2 GHz.<br>Bandwidth: 5 MHz.<br>Number of UE antennas: 1.                                                                                                                                                                                                                                                                                                                                                                                                                                                                                                                                                                                                                                      |         |    |    |       |     |   |         |     |   |         |     |   |        |     |   |      |     |   |      |     |   |
| Node B resources                      | Power reserved for common channels and DPCH for all users: 7.5 Watt (30%)<br>3 Watt for common channels + 1 Watt / ~100 users for DPCH<br>Remaining power for all HS-SCCH and HS-PDSCH: 17.6 Watt<br>OVSF codes reserved for common channels: <table border="1" style="margin-left: 20px;"> <thead> <tr> <th>Channel</th> <th>SF</th> <th>Nb</th> </tr> </thead> <tbody> <tr> <td>CPICH</td> <td>256</td> <td>1</td> </tr> <tr> <td>P-CCPCH</td> <td>256</td> <td>1</td> </tr> <tr> <td>S-CCPCH</td> <td>256</td> <td>1</td> </tr> <tr> <td>E-AGCH</td> <td>256</td> <td>1</td> </tr> <tr> <td>AICH</td> <td>256</td> <td>1</td> </tr> <tr> <td>PICH</td> <td>256</td> <td>1</td> </tr> </tbody> </table><br>OVSF code usage modelled for dedicated channels:<br>F-DPCH (SF – 256)<br>Soft-handover overhead: 1.8<br>Up to 8 simultaneous HS-SCCH transmissions allowed.<br>HS-SCCH code collisions are not modelled.<br>HS-PDSCH OVSF code usage and collisions are explicitly modelled. | Channel | SF | Nb | CPICH | 256 | 1 | P-CCPCH | 256 | 1 | S-CCPCH | 256 | 1 | E-AGCH | 256 | 1 | AICH | 256 | 1 | PICH | 256 | 1 |
| Channel                               | SF                                                                                                                                                                                                                                                                                                                                                                                                                                                                                                                                                                                                                                                                                                                                                                                                                                                                                                                                                                                        | Nb      |    |    |       |     |   |         |     |   |         |     |   |        |     |   |      |     |   |      |     |   |
| CPICH                                 | 256                                                                                                                                                                                                                                                                                                                                                                                                                                                                                                                                                                                                                                                                                                                                                                                                                                                                                                                                                                                       | 1       |    |    |       |     |   |         |     |   |         |     |   |        |     |   |      |     |   |      |     |   |
| P-CCPCH                               | 256                                                                                                                                                                                                                                                                                                                                                                                                                                                                                                                                                                                                                                                                                                                                                                                                                                                                                                                                                                                       | 1       |    |    |       |     |   |         |     |   |         |     |   |        |     |   |      |     |   |      |     |   |
| S-CCPCH                               | 256                                                                                                                                                                                                                                                                                                                                                                                                                                                                                                                                                                                                                                                                                                                                                                                                                                                                                                                                                                                       | 1       |    |    |       |     |   |         |     |   |         |     |   |        |     |   |      |     |   |      |     |   |
| E-AGCH                                | 256                                                                                                                                                                                                                                                                                                                                                                                                                                                                                                                                                                                                                                                                                                                                                                                                                                                                                                                                                                                       | 1       |    |    |       |     |   |         |     |   |         |     |   |        |     |   |      |     |   |      |     |   |
| AICH                                  | 256                                                                                                                                                                                                                                                                                                                                                                                                                                                                                                                                                                                                                                                                                                                                                                                                                                                                                                                                                                                       | 1       |    |    |       |     |   |         |     |   |         |     |   |        |     |   |      |     |   |      |     |   |
| PICH                                  | 256                                                                                                                                                                                                                                                                                                                                                                                                                                                                                                                                                                                                                                                                                                                                                                                                                                                                                                                                                                                       | 1       |    |    |       |     |   |         |     |   |         |     |   |        |     |   |      |     |   |      |     |   |
| IMS VoIP packet format and overheads  | VoIP packet with payload according to RFC3267<br>24-bit ROHC overhead.<br>8-bit RLC overhead.<br>No forced voice packet bundling.                                                                                                                                                                                                                                                                                                                                                                                                                                                                                                                                                                                                                                                                                                                                                                                                                                                         |         |    |    |       |     |   |         |     |   |         |     |   |        |     |   |      |     |   |      |     |   |
| VoIP traffic details                  | AMR 12.2 kbps.<br>SID transmitted every 160 ms of silence.<br>Voice activity model:<br>50% voice activity.<br>ON and OFF periods of duration exponentially distributed, of average 3 seconds.<br>100 ms maximum delay bound with 100 ms SDU discarding at the MAC-hs.<br>Call length: 30 seconds.<br>Call Outage: VoIP calls with FER over call length greater than 3% are considered in outage.                                                                                                                                                                                                                                                                                                                                                                                                                                                                                                                                                                                          |         |    |    |       |     |   |         |     |   |         |     |   |        |     |   |      |     |   |      |     |   |
| Best-effort (BE) traffic (if modeled) | Full-buffer traffic if specified.<br>5 users per cell at fixed geometries {0, 1.5, 2.5, 3, 5dB}.<br>SDU size: 320 bit                                                                                                                                                                                                                                                                                                                                                                                                                                                                                                                                                                                                                                                                                                                                                                                                                                                                     |         |    |    |       |     |   |         |     |   |         |     |   |        |     |   |      |     |   |      |     |   |
| Signalling traffic                    | SRB, RTCP, and SIP not modeled.                                                                                                                                                                                                                                                                                                                                                                                                                                                                                                                                                                                                                                                                                                                                                                                                                                                                                                                                                           |         |    |    |       |     |   |         |     |   |         |     |   |        |     |   |      |     |   |      |     |   |
| Parameters of HS-SCCH-less operation  | TB sizes:<br>2 TB sizes: 137 bits, 317 bits<br>4 TB sizes: 137 bits, 317 bits, 584 bits, and 320 bits<br>24-bit CRC overhead.<br>No DRX or DTX.<br>Each user is assigned two of the available HS-PDSCH OVSF codes at call setup.<br>OVSF code collision and fragmentation is explicitly modelled.                                                                                                                                                                                                                                                                                                                                                                                                                                                                                                                                                                                                                                                                                         |         |    |    |       |     |   |         |     |   |         |     |   |        |     |   |      |     |   |      |     |   |

|                 |                                                                                                                                                                                                                                                                                                                                                                                                                                                                                                                                                                                                                                                                                                                                                                                                                                                                                                                                                                                                                                                                                                                                                                                                                                                                                                                                              |
|-----------------|----------------------------------------------------------------------------------------------------------------------------------------------------------------------------------------------------------------------------------------------------------------------------------------------------------------------------------------------------------------------------------------------------------------------------------------------------------------------------------------------------------------------------------------------------------------------------------------------------------------------------------------------------------------------------------------------------------------------------------------------------------------------------------------------------------------------------------------------------------------------------------------------------------------------------------------------------------------------------------------------------------------------------------------------------------------------------------------------------------------------------------------------------------------------------------------------------------------------------------------------------------------------------------------------------------------------------------------------|
| Scheduler       | <p>Voice traffic scheduled first, then best-effort (BE) traffic scheduled next (if applicable).</p> <p><u>Voice traffic scheduler:</u><br/> HARQ retransmissions have highest priority<br/> Oldest transmissions are re-transmitted first<br/> Format is selected such as to minimize power usage<br/> New transmissions are scheduled when there are no more HARQ retransmissions to schedule:<br/> Users are prioritized according to the exponential scheduling rule modified as follows:</p> $P_i = a \cdot \exp \left( \frac{a \cdot D_i[n] - \overline{aD}[n]}{1 + (\overline{aD}[n])^{1/2}} \right) \cdot \frac{SNR_i[n]}{SNR_i[n]}$ <p>with <math>a = 1</math>,<br/> with <math>SNR_i[n]</math> and <math>\overline{aD}[n]</math> averaged using a 1-tap IIR low-pass filter of time-constant 3.3 seconds.<br/> Format is selected such as to send the most of that user's voice packets as possible.<br/> ("Greedy" resource allocation.)<br/> If there are several options, the format requiring the least power is selected.</p> <p><u>BE traffic scheduler:</u><br/> Proportional Fair priority function.<br/> Format is selected such as to send the most of the user's data packets as possible.<br/> ("Greedy" resource allocation.)<br/> If there are several options, the format requiring the least power is selected.</p> |
| Feedback delays | <p>CQI delay: 8 slots from time of measure to start of HS-PDSCH transmission.<br/> HARQ delay: minimum 15 slots from end of a transmission to start of a retransmission.</p>                                                                                                                                                                                                                                                                                                                                                                                                                                                                                                                                                                                                                                                                                                                                                                                                                                                                                                                                                                                                                                                                                                                                                                 |
| Error modelling | <p>HS-PDSCH:<br/> Threshold-based decoder.<br/> Energy combining assumed.<br/> HS-SCCH: Threshold-based decoder.<br/> CQI: perfect estimation with quantization errors.<br/> HS-DPCCH: HARQ feedback errors modelled with ACK false alarm probability of <math>10^{-3}</math> and ACK misdetection probability of <math>10^{-2}</math>.<br/> No channel estimation modelled.</p>                                                                                                                                                                                                                                                                                                                                                                                                                                                                                                                                                                                                                                                                                                                                                                                                                                                                                                                                                             |

### 4.8.3 Benefits of the concept

The performance benefits of the reduced complexity HS-SCCH-less operation are evident from the simulations results.

- Significant increase in the VoIP capacity compared to the Release 5/6 HSDPA operation obtained due to reduced overhead.
- HS-SCCH channels are freed up to be used for other services.
- At medium VoIP user loads, the first two benefits translate into a large gain in the throughput available to co-existing Best Effort user's traffic.
- Delay sensitive traffic is better supported as more users can be code multiplexed in a single TTI without the costly overhead of the HS-SCCH. Figure 4.8.2.3-5 shows that typically more users are multiplexed per TTI in the new operation.

#### Backward Compatibility and flexibility benefits:

- Is backward compatible and integrated with the existing HS-DSCH operation.
  - The scheduler may dynamically choose at each TTI whether to schedule a HS-SCCH-less or a legacy transmission.
- Does not impose synchronous operation on retransmissions.
- Does not change the coding and transmission of the HS-SCCH.

- Does not require blind combining by the UE.

#### 4.8.4 Open Issues of the concept

## 4.A Summary of technical concepts and possible combinations

### 4.A.1 Overview of the technical concepts

| section | technical concept     | alternatives (if any) | CPC initiation                                                                                      |            |                                                                                  |                                                                                                                                                                                                                                                                                                                                                                       | CPC termination                                                         |            |           |               | comments                                                                                                                                                                                                                                                                                                                                                          |
|---------|-----------------------|-----------------------|-----------------------------------------------------------------------------------------------------|------------|----------------------------------------------------------------------------------|-----------------------------------------------------------------------------------------------------------------------------------------------------------------------------------------------------------------------------------------------------------------------------------------------------------------------------------------------------------------------|-------------------------------------------------------------------------|------------|-----------|---------------|-------------------------------------------------------------------------------------------------------------------------------------------------------------------------------------------------------------------------------------------------------------------------------------------------------------------------------------------------------------------|
|         |                       |                       | trigger                                                                                             | signalling | UE action                                                                        | Node B action                                                                                                                                                                                                                                                                                                                                                         | trigger                                                                 | signalling | UE action | Node B action |                                                                                                                                                                                                                                                                                                                                                                   |
| 4.1     | new DPCCH slot format | -                     | New DPCCH slot format with fewer pilot bits can be configured in same way as existing slot formats. | -          | Switch to Rel-99 slot format with more pilot bits during CQI transmission (FFS). | If switching to Rel-99 slot format occurs during CQI transmission:<br><br>Serving Node B: Switch to Rel-99 slot format with more pilot bits during CQI transmission (based on the configured CQI reporting occasions).<br><br>Non-serving Node B: Modify DPCCH detection appropriately (e.g. using a reduced number of DPCCH bits and/or blind slot format detection) | Rel-99 slot format with more pilots can be configured in the usual way. | -          | -         | -             | A new DPCCH slot format with 5 pilot bits and 5 TPC bits would enable a larger reduction in DPCCH overhead than a new slot format with 6 pilot bits and 4 TPC bits.<br><br>The exact new slot format is FFS. The 5 pilots / 5 TPC format could be selected if the slot format changes during CQI transmissions; otherwise the 6 pilots / 4 TPC could be selected. |

| section | technical concept    | alternatives (if any) | CPC initiation                                                                                                                                 |                                                                                                                                           |                                                                                                                                                   |                                                                        | CPC termination                        |                                                                                                                                            |                                                                                                                          |                                                                     | comments                                                                                         |
|---------|----------------------|-----------------------|------------------------------------------------------------------------------------------------------------------------------------------------|-------------------------------------------------------------------------------------------------------------------------------------------|---------------------------------------------------------------------------------------------------------------------------------------------------|------------------------------------------------------------------------|----------------------------------------|--------------------------------------------------------------------------------------------------------------------------------------------|--------------------------------------------------------------------------------------------------------------------------|---------------------------------------------------------------------|--------------------------------------------------------------------------------------------------|
|         |                      |                       | trigger                                                                                                                                        | signalling                                                                                                                                | UE action                                                                                                                                         | Node B action                                                          | trigger                                | signalling                                                                                                                                 | UE action                                                                                                                | Node B action                                                       |                                                                                                  |
| 4.2     | UL DPCCH gating      | -                     | UL inactivity and no HS-DPCCH transmission (nothing else than DPCCH to transmit in the slot)                                                   | -                                                                                                                                         | Transmit DPCCH only in predefined slots                                                                                                           | -                                                                      | E-DCH or HS-DPCCH transmission         | -                                                                                                                                          | - (Start transmitting as in rel'6)                                                                                       | - (Start receiving as in rel'6)                                     | DPCCH DTX detection in the beginning of each TTI in slots where no predefined DPCCH transmission |
| 4.3.1.1 | SIR target reduction | L1 signalling         | expiry of a timer which is started after MAC-e scheduler in Node B has noticed via scheduling information that MAC-e buffer in the UE is empty | HS-SCCH signalling to UE (to inform UE about CPC initiation and to trigger corresponding UE behaviour); signalling only in non-VoIP case) | autonomous UL DPCCH power reduction; application of a power offset on HS-DPCCH and/or UL DPCCH in case of DL activity while UL is inactive is ffs | UL DPCCH SIR_target reduction in serving Node B                        | new data arriving in UE's MAC-e buffer | specific E-DPCCH sequence from UE which is then confirmed by HS-SCCH from Node B (for VoIP signalling only needed after longer inactivity) | autonomous UL DPCCH power increase back to normal; then no further beta_hs boost required; start of E-DPDCH transmission | setting back of UL DPCCH SIR_target to normal in serving Node B     |                                                                                                  |
| 4.3.1.2 | SIR target reduction | L2 signalling         | UE has no data to transmit in uplink for a certain minimum amount of time                                                                      | sending a MAC-e PDU reserved for this purpose until all NodeBs in serving and non-serving RLS have                                        | UL DPCCH power reduction, apply power control loop with DPC_MODE=1                                                                                | UL DPCCH SIR_target reduction, power control reception with DPC_MODE=1 | New data arriving in UE's MAC-e buffer | sending a MAC-e PDU with SI until all NodeBs in serving and non-serving RLS have acknowledged receipt of                                   | UL DPCCH power restoration, restore regular power control loop                                                           | UL DPCCH SIR_target restoration, restore regular power control loop |                                                                                                  |



| section | technical concept    | alternatives (if any) | CPC initiation                                                       |                                                                                                   |                                                           |                                                                                     | CPC termination                                 |                                                |                                                                                                         |                                                                                                                                                       | comments |
|---------|----------------------|-----------------------|----------------------------------------------------------------------|---------------------------------------------------------------------------------------------------|-----------------------------------------------------------|-------------------------------------------------------------------------------------|-------------------------------------------------|------------------------------------------------|---------------------------------------------------------------------------------------------------------|-------------------------------------------------------------------------------------------------------------------------------------------------------|----------|
|         |                      |                       | trigger                                                              | signalling                                                                                        | UE action                                                 | Node B action                                                                       | trigger                                         | signalling                                     | UE action                                                                                               | Node B action                                                                                                                                         |          |
|         |                      |                       |                                                                      | acknowledged receipt of the state transition                                                      |                                                           |                                                                                     |                                                 | the state transition                           |                                                                                                         |                                                                                                                                                       |          |
| 4.3.1.3 | SIR target reduction | rules                 | Node B and UE detect a predefined time interval of E-DCH inactivity  | -                                                                                                 | UL DPCCH power reduction                                  | UL DPCCH SIR_target reduction in serving Node B                                     | E-DCH transmission<br><br>HS-DPCCH transmission | Node B detects the E-DCH transmission<br><br>- | UL DPCCH power restoration<br><br>temporary UL DPCCH power restoration during the HS-DPCCH transmission | UL DPCCH SIR_target restoration in serving Node B<br><br>temporary UL DPCCH SIR_target restoration in serving Node B during the HS-DPCCH transmission | note 2   |
| 4.4.1.1 | CQI off              | L1 signalling         | empty MAC-hs buffer in Node B for some time                          | request from Node B to UE via HS-SCCH                                                             | switching off CQI reporting (but storing reporting cycle) | trigger UE to switch off CQI                                                        | new data arriving in Node B's MAC-hs buffer     | request from Node B to UE via HS-SCCH          | restart CQI reporting with last reporting cycle                                                         | trigger UE to switch on CQI (first DL transmission may use former CQI or small CQI)                                                                   |          |
| 4.4.1.2 | CQI off              | L2 signalling         | UE receives no data in downlink for a certain minimum amount of time | sending a MAC-e PDU reserved for this purpose until the serving NodeB has acknowledged receipt of | switching off CQI reporting (but storing reporting cycle) | NodeB receives MAC-e PDU and acknowledges receipt with ACK and stops CQI evaluation | new data arriving in Node B's MAC-hs buffer     | sending a short MAC-hs PDU in the downlink     | sending a MAC-e PDU reserved for this purpose until the serving NodeB has acknowledged receipt of       | NodeB receives MAC-e PDU and acknowledges receipt with ACK and resumes CQI evaluation                                                                 |          |

| section | technical concept                                                                         | alternatives (if any) | CPC initiation                                                        |                      |                                     |                                     | CPC termination                             |                                               |                                    |                                    | comments |
|---------|-------------------------------------------------------------------------------------------|-----------------------|-----------------------------------------------------------------------|----------------------|-------------------------------------|-------------------------------------|---------------------------------------------|-----------------------------------------------|------------------------------------|------------------------------------|----------|
|         |                                                                                           |                       | trigger                                                               | signalling           | UE action                           | Node B action                       | trigger                                     | signalling                                    | UE action                          | Node B action                      |          |
|         |                                                                                           |                       |                                                                       | the state transition |                                     |                                     |                                             |                                               | the state transition               |                                    |          |
| 4.4.1.3 | CQI reduction                                                                             | rules                 | Node B and UE detect a predefined time interval of HS-DSCH inactivity | -                    | apply reduced CQI reporting pattern | apply reduced CQI reporting pattern | new data arriving in Node B's MAC-hs buffer | UE receives scheduling information on HS-SCCH | apply normal CQI reporting pattern | apply normal CQI reporting pattern |          |
| 4.5     | DRX at UE                                                                                 | -                     |                                                                       |                      |                                     |                                     |                                             |                                               |                                    |                                    |          |
| 4.6     | Restricted HS-SCCH                                                                        |                       |                                                                       |                      |                                     |                                     |                                             |                                               |                                    |                                    |          |
| 4.7     | HS-SCCH-less operation                                                                    |                       |                                                                       |                      |                                     |                                     |                                             |                                               |                                    |                                    |          |
| note 1: | void.                                                                                     |                       |                                                                       |                      |                                     |                                     |                                             |                                               |                                    |                                    |          |
| note 2: | The introduction of a next-slot E-DCH transmission indication on DPCCH or E-DPCCH is FFS. |                       |                                                                       |                      |                                     |                                     |                                             |                                               |                                    |                                    |          |

## 4.A.2 Overview of possible combinations of technical concepts

| concepts -><br>vs.<br>combinations | new<br>DPCCH<br>slot<br>format<br>(4.1) | UL<br>DPCCH<br>gating<br>(4.2) | SIR target<br>reduction<br>with L1<br>signalling<br>(4.3.1.1) | SIR target<br>reduction<br>with L2<br>signalling<br>(4.3.1.2) | SIR target<br>reduction<br>with rules<br>(4.3.1.3) | CQI off<br>with L1<br>signalling<br>(4.4.1.1) | CQI off<br>with L2<br>signalling<br>(4.4.1.2) | CQI<br>reduction<br>with rules<br>(4.4.1.3) | DRX at<br>UE (4.5) | Restrict<br>ed HS-<br>SCCH<br>(4.6) | HS-SCCH-<br>less<br>operation<br>(4.7) | comments                                                                                                                                                                                                                                                         |
|------------------------------------|-----------------------------------------|--------------------------------|---------------------------------------------------------------|---------------------------------------------------------------|----------------------------------------------------|-----------------------------------------------|-----------------------------------------------|---------------------------------------------|--------------------|-------------------------------------|----------------------------------------|------------------------------------------------------------------------------------------------------------------------------------------------------------------------------------------------------------------------------------------------------------------|
| 1.                                 |                                         |                                | X                                                             |                                                               |                                                    | X                                             |                                               |                                             |                    |                                     |                                        | consistent signalling<br>approach                                                                                                                                                                                                                                |
| 2.                                 | (X)<br>Note 1                           | X                              |                                                               |                                                               |                                                    |                                               |                                               | (X)<br>Note 2                               | (X)<br>Note 3      |                                     |                                        | One combination<br>could contain all, any<br>or none of the<br>concepts marked with<br>(X).                                                                                                                                                                      |
| 3.                                 | (X)<br>Note 1                           | X                              |                                                               |                                                               |                                                    | (X)<br>Note 2                                 |                                               |                                             | (X)<br>Note 3      |                                     |                                        | One combination<br>could contain all, any<br>or none of the<br>concepts marked with<br>(X).                                                                                                                                                                      |
| 4.                                 | X<br>Note 4                             |                                |                                                               |                                                               | X                                                  |                                               |                                               | X                                           |                    |                                     |                                        | consistent signalling<br>approach                                                                                                                                                                                                                                |
| 5.                                 | X                                       |                                | (X1)                                                          | (X1)                                                          | (X1)                                               | (X2)                                          | (X2)                                          | (X2)                                        | (X3)               |                                     |                                        | One combination<br>could contain one of<br>the concepts marked<br>(X1), and may<br>contain one of the<br>concepts marked<br>(X2) and/or the<br>concept marked (X3).<br><br>SIR target reduction<br>can be greater with<br>new DPCCH slot<br>format than without. |

|                                                                                                                                                                                                                                                                                                                                                                                                                                                                                                                                                                                                                                                       |     |               |      |      |      |      |      |      |      |  |  |                                                                                                                                                                                                                                                                                                                               |
|-------------------------------------------------------------------------------------------------------------------------------------------------------------------------------------------------------------------------------------------------------------------------------------------------------------------------------------------------------------------------------------------------------------------------------------------------------------------------------------------------------------------------------------------------------------------------------------------------------------------------------------------------------|-----|---------------|------|------|------|------|------|------|------|--|--|-------------------------------------------------------------------------------------------------------------------------------------------------------------------------------------------------------------------------------------------------------------------------------------------------------------------------------|
| 6.                                                                                                                                                                                                                                                                                                                                                                                                                                                                                                                                                                                                                                                    | X   | X             | (X1) | (X1) | (X1) | (X2) | (X2) | (X2) | (X3) |  |  | <p>One combination could contain one of the concepts marked (X1), and may contain one of the concepts marked (X2) and/or the concept marked (X3).</p> <p>SIR target reduction can be greater with new DPCCH slot format than without.</p> <p>New slot format enables DPCCH “on” slots in gated mode to be at lower power.</p> |
| 7.                                                                                                                                                                                                                                                                                                                                                                                                                                                                                                                                                                                                                                                    | (X) | (X)<br>Note 5 |      | X    |      |      | (X)  |      | (X)  |  |  | <p>One combination could contain all, any or none of the concepts marked with (X).</p>                                                                                                                                                                                                                                        |
| 8.                                                                                                                                                                                                                                                                                                                                                                                                                                                                                                                                                                                                                                                    |     |               |      |      |      |      |      |      |      |  |  |                                                                                                                                                                                                                                                                                                                               |
| <p>Note: The numbering of the combinations in the table does not include any priority information.</p> <p>Note 1: New DPCCH slot format could be used with DPCCH gating. It could e.g. contain a next slot E-DCH transmission indication</p> <p>Note 2: CQI reporting frequency would enable larger gains for DPCCH gating</p> <p>Note 3: DRX at UE allowed by DL transmission restrictions, but not required: no new/changes requirements for UE</p> <p>Note 4: New DPCCH slot format proposal B is considered for this concept combination.</p> <p>Note 5: Power control adjustments may be different from the ones described in L2 signalling.</p> |     |               |      |      |      |      |      |      |      |  |  |                                                                                                                                                                                                                                                                                                                               |

---

## 5 Technical solution

This section describes which technical concepts of section 4 are selected to solve the problems in the 3GPP standard described by the work item "Continuous Connectivity for Packet Data Users" defined in [1].

### 5.1 Overview of the selected solution

"Continuous connectivity for packet data users" as building block under the REL-7 feature "RAN improvements" was decided by RAN1 #46 to consist of the following UL & DL improvements:

- A **new UL DPCCH slot format** configurable by L3 in a semi-static way (based on section 4.1).
- **UL DPCCH gating/discontinuous transmission (DTX)** in 2 cycles (based on section 4.2) connected with a **F-DPCH gating in DL** and an implicit **CQI reporting reduction** in UL (see section 4.4)
- In DL: **Discontinuous reception (DRX)** at the UE (based on section 4.5).
- In DL: A so called **HS-SCCH-less operation** which includes an HS-SCCH less initial transmission and modified HS-SCCH for retransmission(s) (based on section 4.8).

Note 1: The referenced subsections of section 4 indicate the ideas that were taken into account but they do not necessarily describe the concepts exactly as they were introduced in the final solution as described in section 5.

Note 2: The building block "Continuous connectivity for packet data users" under the REL-7 feature "RAN improvements" is in the following abbreviated as "CPC solution" (CPC: continuously packet connected or continuous packet connectivity).

The following summary provides an overview about the CPC solution as introduced in the REL-7 specifications (for more detailed description please refer to the corresponding CRs).

The CPC solution:

- is mandatory to be implemented in all FDD UEs of REL-7 and above supporting HSDPA/E-DCH (even though the actual shutting off of the UE receiver remains an UE implementation issue);
- is configurable on a per UE basis by the SRNC i.e. the SRNC can enable the CPC solution or parts of it for each UE individually provided the corresponding Node B supports it;
- can only be applied to FDD UEs in CELL\_DCH state provided that F-DPCH but no DCH in UL and DL is configured for this UE (i.e. SRBs have to be mapped to HS-DSCH)
- is divided into three parts:
  - 1) new UL DPCCH slot format
  - 2) DTX/DRX at UE (linked with DTX of F-DPCH at Node B)
  - 3) HS-SCCH less-operation
- These 3 parts could in theory be configured by the RNC independently from each other as well as in combination. In the specifications one limitation was introduced: 1. can only be applied in connection with 2.
- allows to reduce UL (esp. UL DPCCH, CQI) and DL (esp. HS-SCCH, F-DPCH) control signalling for temporarily inactive packet data users that can get active again in a short time period (<50ms). This helps to increase the number of packet data users in CELL\_DCH as well as to increase the time that these users can stay in CELL\_DCH state (due to increased battery life time as well as lower control signalling overhead on the air interface).

### 5.1.1 New UL DPCCH slot format

This part of the CPC solution introduces a new uplink DPCCH slot format which increases the number of TPC bits for power control from 2 to 4 allowing for a trade off between increased power control reliability and reduced UL DPCCH transmit power. As there is no UL DCH and no FBI field is used, the number of pilot bits is then 6 (instead of 8).

This new UL DPCCH slot format can be configured and reconfigured per UE by the SRNC.

### 5.1.2 Discontinuous transmission and reception in CELL\_DCH

This part of the CPC solution can be divided into 2 subparts:

- Discontinuous uplink DPCCH transmission (in the following abbreviated **UL\_DTX**/DTX at UE)
- Discontinuous downlink reception (in the following abbreviated **DL\_DRX**/DRX at UE).

UL\_DTX can be applied independently from DL\_DRX but DL\_DRX is only applied if also UL\_DTX is applied.

As soon as the feature UL DTX an/or DL DRX is enabled by the SRNC and a time CPC\_enabling\_delay (given by higher layers in 10ms radio frames; this period allows synchronisation and power control stabilisation; note: In the specifications this parameter is just called "Enabling\_Delay".) has passed the UE and Node B(s) apply UL DTX and/or DL DRX based on standardized rules.

For UL DTX and DL DRX corresponding parameters for these rules are configured by the SRNC: via RNSAP/NBAP in the Node B and via RRC in the UE.

**UL DTX** allows an autonomous reduction of UL DPCCH transmissions in the UE depending on how often EDCH and HS-DPCCH transmissions in UL occur. This mechanism is under control of the network by standardized rules whose parameters are configured in the RNC.

Two different cycles of discontinuous UL DPCCH transmission have to be distinguished for a UE applying UL DTX:

- **UE\_DTX\_cycle\_2** (time period in subframes) which is  $\geq$ UE\_DTX\_cycle\_1
  - applied if no E-DCH transmissions in UL occurred within the last Inactivity\_Threshold\_for\_UE\_DTX\_cycle\_2 (time period in E-DCH TTIs);
  - creates UL DPCCH transmission pattern 2: UL DPCCH transmitted for UE\_DPCCH\_burst\_2 subframes and no UL DPCCH for the rest of the period UE\_DTX\_cycle\_2
- **UE\_DTX\_cycle\_1** (time period in subframes)
  - applied if UE\_DTX\_cycle\_2 is not applied;
  - creates UL DPCCH transmission pattern 1: UL DPCCH transmitted for UE\_DPCCH\_burst\_1 subframes and no UL DPCCH for the rest of the period UE\_DTX\_cycle\_1.

The UL DPCCH transmission patterns defined by the two cycles start at the same time and cycle 2 is configured to be a multiple of cycle 1. A UE specific offset UE\_DTX\_DRX\_Offset (in subframes) can be configured to distribute discontinuous transmissions of different users in the time domain.

With these 2 UL DPCCH patterns the overhead of UL DPCCH can be controlled by a rule (known by UE and Node B):

UL DPCCH is only transmitted if at least one of the following has to be transmitted:

- HS-DPCCH (ACK/NACK/CQI) or
- EDCH or
- an UL DPCCH burst of a UE\_DTX\_cycle\_1 or an UL DPCCH burst UE\_DTX\_cycle\_2 or
- an UL DPCCH **preamble** or UL DPCCH **postamble** (1 slot).

The 2 slots UL DPCCH preamble is used directly before an HS-DPCCH or EDCH or UL DPCCH bursts of UL DPCCH transmission pattern if not overlapping with an HS-DPCCH or EDCH transmission. The preamble helps for UL DPCCH power setting as UL DPCCH power is kept on hold during transmission gaps. In addition a one slot

postamble of UL DPCCH is following after HS-DPCCH or EDCH transmissions or UL DPCCH bursts of UL DPCCH transmission pattern which are followed by a period of no UL DPCCH transmissions.

When returning from UE\_DTX\_cycle\_2 to UE\_DTX\_cycle\_1 because of new EDCH data to be transmitted after some period of no EDCH transmission (>Inactivity\_Threshold\_for\_UE\_DTX\_cycle\_2 TTIs) it is also possible to use a long preamble (configurable by the parameter UE\_DTX\_long\_preamble\_length to 2 or 4 or 15 slots).

As UL DTX reduces UL DPCCH transmissions which are also used for determining power control commands on F-DPCH in DL, the Node B is not required to transmit F-DPCH in those gaps of UL DPCCH transmission ("DL F-DPCH gating"). So the UE only receives the TPC commands on F-DPCH corresponding to actually transmitted UL DPCCH slots.

The UL compressed mode (used for measurements since R99) and the UL DPCCH transmission patterns are applied as follows:

- As long as UL DTX is not applied or if UL DTX is used but E-DCH data transmission is ongoing compressed mode is applied as in REL-6 and takes priority over UL DPCCH pattern settings.
- In case UL DTX is applied and no ED-DCH data needs to be send 2 cases can be distinguished:
  - If a (preamble + UL DPCCH burst + postamble) of the UL DPCCH transmission pattern overlaps partly or fully with a compressed mode gap then the UL DPCCH in this radio frame will be transmitted as in a REL-6 compressed mode frame, i.e. in the whole frame except the compressed mode gap.
  - If a (preamble + UL DPCCH burst + postamble) of the UL DPCCH transmission pattern does not overlap with the compressed mode gap in a compressed radio frame then the UL DPCCH transmission related to compressed mode will not be carried out in this radio frame. So in this radio frame the UL DPCCH will follow the UL DPCCH transmission pattern.

When the discontinuous uplink DPCCH transmission is enabled a count down timer (going from a configurable value CQI\_DTX\_TIMER down to 0 in subframes) controls when **CQI reports** on HS-DPCCH are sent:

- either CQI reports shall be sent on HS-DPCCH according to REL-6 CQI feedback cycle (this case is called "CQI\_DTX\_Priority=1" and applies before timer expires at 0),
- or CQI reports on HS-DPCCH have to fall into UL DPCCH bursts of the currently active discontinuous uplink DPCCH transmission pattern in order to get transmitted (this case is called "CQI\_DTX\_Priority=0" and applies after the timer has expired at 0).

The timer is reset to CQI\_DTX\_TIMER every time an HS-SCCH indicating a HS-DSCH transmission (no HS-SCCH order) was received with consistent control information or HS-PDSCH was received correctly.

Note: When UL DTX is enabled by higher layers for a specific UE then also its CQI feedback pattern is offset by UE\_DTX\_DRX Offset (in subframes) in the same way as the UL DPCCH transmission patterns. The CQI feedback cycle remains unchanged compared to the case where no UL DTX is applied.

In addition to UL DTX there is an option **UL DRX/DRX** at the Node B which allows the Node B to save resources (e.g. for processing) by restricting on MAC level the starting points of new UL data transmissions (after inactivity) of a UE: If no E-DCH transmission has been performed for the time MAC\_Inactivity\_Threshold (in TTIs) the E-TFC selection in the UE will be restricted to cycles given by MAC\_DTX\_Cycle. This restriction of starting points of UL EDCH transmissions is time offset by the same UE\_DTX\_DRX\_Offset (in subframes) as already known from UL DTX in order to allow that the UL EDCH transmissions fall together with UL DPCCH bursts.

**DL DRX** allows the UE to predict when it has to listen to DL transmissions from the Node B in order to save UE power and increase its battery life time. This mechanism is also based on standardized rules and uses parameters configured by the RNC. Note: Even when configured the UE is not forced to receive discontinuously.

For Inactivity\_Threshold\_for\_UE\_DRX\_cycle subframes after an HS-SCCH reception or after the first slot of an HS-PDSCH reception the UE has to monitor HS-SCCH of its HS-SCCH set and HS-PDSCH (if HS-SCCH less mode is applied in parallel) continuously.

In addition the parameter **UE\_DRX\_cycle** (in subframes) determines an "HS-SCCH reception pattern": The UE must listen to one HS-SCCH sub-frame (and the corresponding HS-PDSCH if HS-SCCH received successfully or if HS-

SCCH less mode is applied in parallel) every UE\_DRX\_cycle sub-frames. The HS-SCCH reception pattern can be offset for different UEs by a UE dependent UE\_DTX\_DRX\_Offset (same parameter as for UL DTX).

Note: The Node B scheduler has to take into account the times at which a UE can receive HS-SCCH/HS-PDSCH.

In addition the UE has to listen to

- F-DPCH in slots corresponding to transmitted UL DPCCH slots;
- DL E-HICH corresponding to an UL E-DCH;
- if **UE\_DRX\_Grant\_Monitoring** = TRUE:  
E-AGCH from serving cell and E-RGCH transmissions from cells in the serving E-DCH radio link set when they overlap with the start of an HS-SCCH reception pattern;
- DL E-AGCH from serving cell and DL E-RGCH(s) from all the cells in the E-DCH active set
  - if overlapping with E-HICH (corresponding to a scheduled E-DCH transmission);
  - if sent within Inactivity\_Threshold\_for\_UE\_Grant\_Monitoring subframes after an E-DCH scheduled transmission;
  - if at least one MAC-d flow is configured with a scheduled transmission and TEBS > 0 (TEBS: Total E-DCH Buffer Status).

The Node B has a fast L1 mechanism to force the UE back to continuous UL DPCCH transmissions and continuous DL receptions as in REL-6: **HS-SCCH orders**.

- Node B can deactivate (or reactivate) UL DTX or DL DRX operation for a specific UE by a L1 command sent on an HS-SCCH of type 2 without an associated HS-PDSCH.
- HS-SCCH orders ('111101') can be distinguished from HS-SCCH less operation ('111110') by its special information type bit combination in HS-SCCH part 2. Note: HS-SCCH orders use already a specific (in REL-5/REL-6 not used) channelization code set bit sequence "1110000" on HS-SCCH part 1.
- These HS-SCCH orders are used in exceptional cases (e.g. danger of losing a connection to a UE). Normally the UE will stay in the configured UL DTX/DL DRX mode until it is reconfigured and this allows the benefits of continuous operation as in REL-6 as well as discontinuous operation by autonomously applied standardized rules, i.e. without further signalling.  
E.g. transmission gaps between packets of a VoIP call as well as speech pauses in between can all be handled as well as a continuous file transfer without a reconfiguration.
- HS-SCCH orders are carried out by the UE a specific time intervall after receiving an HS-SCCH order:
  - for UL DTX: at earliest E-DCH TTI boundary coinciding with or following the beginning of the HS-DPCCH subframe containing the HARQ-ACK corresponding to the order,
  - for DL DRX: 12 slots after the ending of the HS-SCCH subframe delivering the order.
- If received correctly by the UE an ACK is sent in the corresponding HS-DPCCH ACK field.

### 5.1.3 HS-SCCH less operation

This part of the CPC solution is introducing a new HS-SCCH type 2 format (compared to the HS-SCCH type 1 as in REL-6) as well as a new CRC attachment method 2 for HS-DSCH and it is reducing the DL HS-SCCH overhead for lower data rate services that can be operated with just 4 predefined transport block formats for MAC-hs PDUs (special focus: VoIP users).

If HS-SCCH less operation is combined with

- either UL\_DTX
- or UL\_DTX & DL\_DRX

further restrictions regarding the timing of DL HS-SCCH & HS-PDSCH & F-DPCH as well as UL DPCCH, HS-DPCCH have to be taken into account by the scheduler in the Node B as well as by the UE.



The main characteristics of HS-SCCH less operation are:

- 'HS-SCCH less mode' is configured per UE (not per HS-SCCH) by the SRNC by prescribing 1 or 2 HS-PDSCH channelization codes and corresponding up to 4 MAC-hs transport block sizes that have to be used if HS-SCCH type 2 is used.  
These settings are semi-static, i.e. they can be reconfigured.  
Note: 'HS-SCCH less mode' configured for a UE allows the usage of HS-SCCH less operation, i.e. HS-SCCH type 2/CRC attachment method 2 for this UE. It does not mandate it. This means the UE also continues to attempt reception of the legacy HS-SCCH type 1.
- As in REL-6 the UE has to monitor up to 4 HS-SCCHs but whether HS-SCCHs of type 1 (as in REL-6) or type 2 (as for HS-SCCH less operation) are used is up to the Node B and is autonomously detected by the UE. The only limitation is that if the first transmission of a transport block is using a HS-SCCH type x (x: either 1 or 2) also all retransmissions of this transport block have to use the same HS-SCCH type x.
- Operating with HS-SCCH type 2 is characterized by
  - An initial HS-PDSCH transmission has no associated HS-SCCH. The UE:
    - knows the channelization code of the HS-PDSCH via RRC from the SRNC (modulation of HS-PDSCH is fixed to QPSK),
    - has to blindly decode on the up to 2 HS-PDSCH codes with 4 possible transport formats (configured by the SRNC),
    - detects whether HS-PDSCH is dedicated to this UE (UE-Id) from an introduced new 24bit CRC of HS-PDSCH (CRC attachment method 2).
    - successful detection is answered by an ACK from the UE (in unsuccessful case no NACK is sent).
  - The retransmission (max. 2 are possible) has an associated HS-SCCH of type 2 which informs the UE about:
    - HS-PDSCH channelization code (up to max. 2) and modulation (QPSK)
    - whether associated HS-PDSCH is dedicated to this UE (UE identity)
    - transport block size (1 out of the configured 4) so no blind decoding
    - whether this is the first or second retransmission
    - a pointer to the previous HS-PDSCH transmission of the same transport block (pointing 6..13 subframes before the start of this HS-PDSCH transmission);  
the UE uses a so called 13 TTI long "cyclic soft buffer" to store and combine up to 3 HS-PDSCH transmissions
    - The UE answers on HS-DPCCH with ACK or NACK in the same way as for HS-SCCH type 1.
  - Apart from the information above same timing of HS-SCCH, HS-PDSCH, HS-DPCCH as in REL-6.

## 5.2 Impact on RAN1 specifications

TS 25.201 REL-7:

- Update of the list of physical layer procedures to add HS-SCCH less operation and to add procedures related to discontinuous transmission and reception.

TS 25.211 REL-7:

- Introduction of the new slot format with 4 TPC bits, mapping of 4 TPC bits to power control commands and terminology of subframes.

TS 25.212 REL-7:

- Addition of new CRC attachment method 2 for HS-DSCH to be used in connection with HS-SCCH type 2.
- Addition of new HS-SCCH type 2 format to be used for:
  - HS-SCCH format type 2 for retransmissions.

- HS-SCCH orders: L1 commands to activate/deactivate DTX and/or DRX at the UE.

TS 25.214 REL-7:

- Synchronisation and power control aspects of discontinuous uplink DPCH transmission.
- Operation of discontinuous transmission (DTX) and reception (DRX) procedures for CELL\_DCH.
- Details of HS-SCCH less operation and Node B procedure for transmitting HS-DSCH.

## 5.3 Impact on RAN2 specifications

TS 25.308 REL-7: Note: All changes apply to FDD only.

- Summary of
  - discontinuous UL transmission (with the option of UL DRX at the Node B) and discontinuous DL reception
  - HS-SCCH-less HS-DSCH transmission
  - usage of new UL DPCH slot format

TS 25.319 REL-7:

- Although E-DCH is impacted by the CPC solution RAN2 decided to only cover CPC changes in TS 25.308.

TS 25.321 REL-7: Note: All changes apply to FDD only.

- New parameters for primitives between MAC and RRC
- HARQ procedure for HS-SCCH less operation
- Impact on E-TFCI selection on MAC at UE for UL DRX at Node B
- Conditions under which UE is required to monitor E-AGCH and E-RGCH

TS 25.331 REL-7: Note: All changes apply to FDD only.

- DTX\_DRX\_STATUS variable and corresponding actions
- HS\_SCCH\_LESS\_STATUS variable and corresponding actions
- Parameters for UL DTX and DL DRX operation (DTX-DRX information, new variable DTX\_DRX\_PARAMS)
- Parameters for HS-SCCH less operation (HS-SCCH less information, new variable HS\_SCCH\_LESS\_PARAMS)
- CPC parameters (DTX-DRX timing information, DTX-DRX information, HS-SCCH less information) added to the following messages:
  - 1) ACTIVE SET UPDATE
  - 2) CELL UPDATE CONFIRM
  - 3) PHYSICAL CHANNEL RECONFIGURATION
  - 4) RADIO BEARER RECONFIGURATION
  - 5) RADIO BEARER RELEASE
  - 6) RADIO BEARER SETUP
  - 7) RRC CONNECTION SETUP
  - 8) TRANSPORT CHANNEL RECONFIGURATION
- Extension of CQI feedback cycle including now also 16ms, 32ms, 64ms
- UL DPCH: slot format #4 not applicable if CPC\_DTX\_DRX\_STATUS is FALSE
- DTX-DRX timing information added (Enabling\_Delay, UE\_DTX\_DRX\_Offset)
- constant maxHS-SCCHLessTrBlk = 4 to limit transport block sizes for HS-SCCH less operation

- ASN.1 text

## 5.4 Impact on RAN3 specifications

TS 25.423 REL-7: Note:All changes apply to FDD only.

- Procedure text added to
  - Radio Link Setup
  - Radio Link Addition
  - Synchronised Radio Link Reconfiguration Preparation
  - Unsynchronised Radio Link Reconfiguration
- CPC parameters (see ( )) added to the following messages:
  - RADIO LINK SETUP REQUEST (Continuous Packet Connectivity DTX-DRX Information, Continuous Packet Connectivity HS-SCCH less Information)
  - RADIO LINK SETUP RESPONSE (Continuous Packet Connectivity HS-SCCH less Information Response)
  - RADIO LINK SETUP FAILURE (Continuous Packet Connectivity HS-SCCH less Information Response)
  - RADIO LINK RECONFIGURATION PREPARE (Continuous Packet Connectivity DTX-DRX Information, Continuous Packet Connectivity DTX-DRX Information To Modify, Continuous Packet Connectivity HS-SCCH less Information)
  - RADIO LINK RECONFIGURATION READY (Continuous Packet Connectivity HS-SCCH less Information Response)
  - RADIO LINK RECONFIGURATION REQUEST (Continuous Packet Connectivity DTX-DRX Information, Continuous Packet Connectivity DTX-DRX Information To Modify, Continuous Packet Connectivity HS-SCCH less Information)
  - RADIO LINK RECONFIGURATION RESPONSE (Continuous Packet Connectivity HS-SCCH less Information Response)
- Radio Network Layer causes added (Continuous Packet Connectivity DTX-DRX operation not supported, Continuous Packet Connectivity HS-SCCH less operation not supported)
- Continuous Packet Connectivity DTX-DRX Support Indicator and Continuous Packet Connectivity HS-SCCH less Support Indicator added to Cell Capability Container FDD
- Information Elements updated for CPC HS-SCCH less operation in:
  - HS-DSCH Serving Cell Change Information
  - HS-DSCH Serving Cell Change Information Response
- New Information Elements introduced for CPC:
  - Continuous Packet Connectivity DTX-DRX Information
  - Continuous Packet Connectivity DTX-DRX Information To Modify
  - Continuous Packet Connectivity HS-SCCH less Information
  - Continuous Packet Connectivity HS-SCCH less Information Response
- for HS-SCCH less operation: option of HS-PDSCH code change introduced in “Radio Link Parameter Update” procedure in RNSAP so that DRNS can indicate the need for HS-PDSCH code update to SRNC
- ASN.1 text

TS 25.433 REL-7: Note:All changes apply to FDD only.

- Procedure text added for
  - Audit
  - Resource Status Indication
  - Radio Link Setup
  - Radio Link Addition
  - Synchronised Radio Link Reconfiguration Preparation
  - Unsynchronised Radio Link Reconfiguration
- CPC parameters added to the following messages:
  - AUDIT RESPONSE (Continuous Packet Connectivity DTX-DRX Capability, Continuous Packet Connectivity HS-SCCH less Capability)
  - RESOURCE STATUS INDICATION (Continuous Packet Connectivity DTX-DRX Capability, Continuous Packet Connectivity HS-SCCH less Capability)
  - RADIO LINK SETUP REQUEST (Continuous Packet Connectivity DTX-DRX Information, Continuous Packet Connectivity HS-SCCH less Information)
  - RADIO LINK SETUP RESPONSE (Continuous Packet Connectivity HS-SCCH less Information Response)
  - RADIO LINK SETUP FAILURE (Continuous Packet Connectivity HS-SCCH less Information Response)
  - RADIO LINK RECONFIGURATION PREPARE (Continuous Packet Connectivity DTX-DRX Information, Continuous Packet Connectivity DTX-DRX Information To Modify, Continuous Packet Connectivity HS-SCCH less Information)
  - RADIO LINK RECONFIGURATION READY (Continuous Packet Connectivity HS-SCCH less Information Response)
  - RADIO LINK RECONFIGURATION REQUEST (Continuous Packet Connectivity DTX-DRX Information, Continuous Packet Connectivity DTX-DRX Information To Modify, Continuous Packet Connectivity HS-SCCH less Information)
  - RADIO LINK RECONFIGURATION RESPONSE (Continuous Packet Connectivity HS-SCCH less Information Response)
- Information Elements updated for CPC:
  - HS-DSCH Serving Cell Change Information (Continuous Packet Connectivity HS-SCCH less Information)
  - HS-DSCH Serving Cell Change Information Response (Continuous Packet Connectivity HS-SCCH less Information Response) 9.2.2.21B of R3-070349
- Extension of CQI feedback cycle including now also 16ms, 32ms, 64ms
  - New Information Elements introduced for CPC:
    - Continuous Packet Connectivity DTX-DRX Capability
    - Continuous Packet Connectivity HS-SCCH less Capability
    - Continuous Packet Connectivity DTX-DRX Information
    - Continuous Packet Connectivity DTX-DRX Information To Modify
    - Continuous Packet Connectivity HS-SCCH less Information
    - Continuous Packet Connectivity HS-SCCH less Information Response
- for HS-SCCH less operation: option of signalling the need of an HS-PDSCH code change in the “Radio Link Parameter Update” procedure of NBAP from the Node B to the CRNC

- ASN.1 text

## 5.5 Impact on RAN4 specifications

<Editor's note: RAN4 investigations still ongoing.>

TS 25.101 REL-7:

- out of synchronisation handling has to take into account discontinuous UL DPCCH transmission in that sense that not just F-DPCH of 160ms period is considered but 240 slots in which F-DPCH is known to be present during UL DTX operation
- areas to be further checked: impact of discontinuous UL DPCCH transmission on UL power control, need for additional DL power control requirement, transmit off power, transmit on/off time mask, blind demodulation requirement for HS-DSCH in case of HS-SCCH less operation, additional demodulation of new HS-SCCH format type 2, need for receiver performance requirements in case of DL DRX, need for testing of DTX/DRX cycles and timers.

TS 25.133 REL-7:

- normalised remaining power margin available for E-TFC selection (section 6.4) has to take into account discontinuous UL DPCCH transmission
- UE transmit power measurement (section 9.1.6) has to take into account discontinuous UL DPCCH transmission.
- UE transmission power headroom measurement (section 9.1.13) has to take into account discontinuous UL DPCCH transmission.
- ffs: extension of 200ms CPICH measurement period and intra-frequency CPICH measurement requirement at the UE in case of DL DRX.

## 5.6 Change requests related to CPC

The following CRs introduced CPC in REL-7 RAN specifications:

| TS     | vers. | CR   | rev | Tdoc      | Title                                                                                                                                                      | RAN |
|--------|-------|------|-----|-----------|------------------------------------------------------------------------------------------------------------------------------------------------------------|-----|
| 25.201 | 7.10  | 0031 | -   | R1-071214 | Introduction of CPC related functionality                                                                                                                  | #35 |
| 25.211 | 7.0.0 | 0230 | 2   | R1-071097 | Support of CPC feature                                                                                                                                     | #35 |
| 25.211 | 7.0.0 | 0231 | -   | R1-063151 | Support of CPC feature: addition of subframe numbering                                                                                                     | #35 |
| 25.212 | 7.3.0 | 0238 | 5   | R1-071173 | Support of CPC feature                                                                                                                                     | #35 |
| 25.214 | 7.3.0 | 0421 | 13  | R1-071257 | Support of CPC feature                                                                                                                                     | #35 |
| 25.308 | 7.0.0 | 0013 | 3   | RP-060725 | Introduction of CPC                                                                                                                                        | #34 |
| 25.321 | 7.3.0 | 0315 | -   | R2-071072 | Introduction of DTX-DRX and HS-SCCH less in MAC                                                                                                            | #35 |
| 25.331 | 7.3.0 | 2990 | -   | R2-071071 | Introduction of DTX-DRX and HS-SCCH less in RRC                                                                                                            | #35 |
| 25.423 | 7.3.0 | 1258 | 2   | R3-070350 | Introduction of Continuous Packet Connectivity in RNSAP                                                                                                    | #35 |
| 25.423 | 7.3.0 | 1260 | 1   | R3-070360 | HS-PDSCH code change for CPC mode                                                                                                                          | #35 |
| 25.433 | 7.3.0 | 1330 | 2   | R3-070349 | Introduction of Continuous Packet Connectivity in NBAP                                                                                                     | #35 |
| 25.433 | 7.3.0 | 1334 | 1   | R3-070361 | HS-PDSCH code change for CPC mode                                                                                                                          | #35 |
| 25.101 | 7.6.0 | 0506 | -   | R4-070119 | Introduction of continuous packet connectivity (CPC) to "Out-of-synchronization handling of output power"                                                  | #35 |
| 25.133 | 7.6.0 | 0899 | -   | R4-070120 | Introduction of continuous packet connectivity (CPC) to ETFC restriction, UE transmitted power and UE transmission power headroom measurement requirements | #35 |

## Annex A (informative): Change history

| Change history |             |           |    |     |                                                                                                                                                                                                                                                     |        |        |  |
|----------------|-------------|-----------|----|-----|-----------------------------------------------------------------------------------------------------------------------------------------------------------------------------------------------------------------------------------------------------|--------|--------|--|
| Date           | Meeting     | Doc.      | CR | Rev | Subject/Comment                                                                                                                                                                                                                                     | Old    | New    |  |
| 2005-10        | RAN1 #42bis | R1-051127 | -  | -   | Skeleton TR                                                                                                                                                                                                                                         | -      | 0.0.1  |  |
| 2005-10        | RAN1 #42bis | R1-051278 | -  | -   | Skeleton TR (editorial modifications)                                                                                                                                                                                                               | 0.0.1  | 0.0.2  |  |
| 2005-10        | RAN1 #42bis | R1-051292 | -  | -   | TR 25.903 including text proposals agreed at RAN1 #42bis (i.e. parts of R1-051205 and R1-051215) and agreements of the email discussion after RAN1 #42bis (related to R1-051128 and R1-051277).                                                     | 0.0.2  | 0.0.3  |  |
| 2005-10        | RAN1 #42bis | R1-051293 | -  | -   | RAN1 agreed version of the TR 25.903 (after email discussion)                                                                                                                                                                                       | 0.0.3  | 0.1.0  |  |
| 2005-11        | RAN1 #43    | R1-051602 | -  | -   | TR 25.903 including text proposals agreed at RAN1 #43: R1-051320, R1-051322, R1-051461, R1-051462, R1-051565, R1-051566, R1-051603 (only "common base for all concepts"), R1-051606, R1-051609, R1-051611, R1-051612                                | 0.1.0  | 0.1.1  |  |
| 2005-11        | RAN1 #43    | R1-051617 | -  | -   | RAN1 agreed version of the TR 25.903 (agreed by email)                                                                                                                                                                                              | 0.1.1  | 0.2.0  |  |
| 2006-02        | RAN1 #44    | R1-060748 | -  | -   | TR 25.903 including text proposals agreed at RAN1 #44: R1-060357*, R1-060408*, R1-060452*, R1-060570*, R1-060592, R1-060595, R1-060598*, R1-060691, R1-060692, R1-060693, R1-060694, R1-060695, R1-060696 (*: agreed with modifications)            | 0.2.0  | 0.2.1  |  |
| 2006-02        | RAN1 #44    | R1-060754 | -  | -   | RAN1 agreed version of the TR 25.903 (agreed by email)                                                                                                                                                                                              | 0.2.1  | 0.3.0  |  |
| 2006-04        | RAN1 #44bis | R1-061098 | -  | -   | TR 25.903 including text proposals agreed at RAN1 #44bis: R1-060943, R1-061010, R1-061021, R1-061022 ('SIR' will be replaced by 'CIR'), R1-061030, R1-061039, R1-061075, R1-061076, R1-061077, R1-061078                                            | 0.3.0  | 0.3.1  |  |
| 2006-04        | RAN1 #44bis | R1-061101 | -  | -   | Adding a dash to the table in section 4.A.1 in row "SIR target reduction, rules" in the column "CPC initiation, signalling" according to a review comment to v0.3.1.                                                                                | 0.3.1  | 0.3.2  |  |
| 2006-04        | RAN1 #44bis | R1-061102 | -  | -   | RAN1 agreed version of the TR 25.903 (agreed by email)                                                                                                                                                                                              | 0.3.2  | 0.4.0  |  |
| 2006-05        | RAN1 #45    | R1-061638 | -  | -   | TR 25.903 including text proposals agreed at RAN1 #45: R1-061351, R1-061353, R1-061476, R1-061495, R1-061571, R1-061573, R1-061574, R1-061575, R1-061576                                                                                            | 0.4.0  | 0.4.1  |  |
| 2006-05        | RAN1 #45    | R1-061643 | -  | -   | RAN1 agreed version of the TR 25.903 (agreed by email)                                                                                                                                                                                              | 0.4.1  | 0.5.0  |  |
| 2006-05        | RAN #32     | RP-060318 | -  | -   | submitted to RAN #32 for information                                                                                                                                                                                                                | 0.5.0  | 1.0.0  |  |
| 2006-09        | RAN1 #46    | R1-062444 | -  | -   | TR 25.903 including text proposals agreed at RAN1 #46: R1-062260, R1-062261, R1-062320 (adding "DPCCH gap length = 1sec" to simulation assumptions table), R1-062382, R1-062421, R1-062423                                                          | 1.0.0  | 1.0.1  |  |
| 2006-09        | RAN1 #46    | R1-062451 | -  | -   | RAN1 agreed version of the TR 25.903 (agreed by email), compared to v1.0.1 also corrections of some references were included (see cover page of R1-062451) in the email agreement                                                                   | 1.0.1  | 1.1.0  |  |
| 2006-11        | RAN1 #47    | R1-063620 | -  | -   | TR 25.903 including in section 5 text proposal R1-063157 together with corresponding comments of the email discussion after RAN1 #47.                                                                                                               | 1.1.0  | 1.1.1  |  |
| 2006-11        | RAN1 #47    | R1-063621 | -  | -   | RAN1 agreed version of the TR 25.903 (agreed by email), compared to v1.1.1 only the revision marks were accepted and the yellow marks were removed.<br>(note: This v1.2.0 was also submitted for information to RAN #34 in Dec. 2006 as RP-060794). | 1.1.1  | 1.2.0  |  |
| 2007-02        | RAN1 #48    | R1-070969 | -  | -   | Editor's proposal to update TR 25.903 according to decisions about latest REL-7 CRs                                                                                                                                                                 | 1.2.0  | 1.2.1  |  |
| 2007-02        | RAN1 #48    | R1-071255 | -  | -   | RAN1 agreed version of the TR 25.903 (agreed by email).                                                                                                                                                                                             | 1.2.1  | 1.3.0  |  |
| 2007-03        | RAN_35      | RP-070077 | -  | -   | TR 25.903 version provided to RAN #35 for approval.                                                                                                                                                                                                 | 1.3.0  | 2.0.0  |  |
| 15/03/07       | RAN_35      | RP-070077 |    |     | Doc in REL-7 under change control further to approval decision                                                                                                                                                                                      | 2.0.0  | 7.0.0  |  |
| 2008-12        | RAN_42      | -         | -  | -   | Doc in REL-8 under change control                                                                                                                                                                                                                   | 7.0.0  | 8.0.0  |  |
| 2009-12        | SP_46       | -         | -  | -   | Doc in REL-9 under change control                                                                                                                                                                                                                   | 8.0.0  | 9.0.0  |  |
| 2011-03        | SP_51       | -         | -  | -   | Doc in REL-10 under change control                                                                                                                                                                                                                  | 9.0.0  | 10.0.0 |  |
| 2012-09        | SP_57       | -         | -  | -   | Update to Rel-11 version (MCC)                                                                                                                                                                                                                      | 10.0.0 | 11.0.0 |  |
| 2014-09        | SP_65       | -         | -  | -   | Update to Rel-12 version (MCC)                                                                                                                                                                                                                      | 11.0.0 | 12.0.0 |  |
| 2015-12        | SP_70       | -         | -  | -   | Update to Rel-13 version (MCC)                                                                                                                                                                                                                      | 12.0.0 | 13.0.0 |  |

| Change history |         |      |    |     |     |                                                        |             |
|----------------|---------|------|----|-----|-----|--------------------------------------------------------|-------------|
| Date           | Meeting | TDoc | CR | Rev | Cat | Subject/Comment                                        | New version |
| 2017-03        | SA#75   | -    | -  | -   | -   | Promotion to Release 14 without technical change (MCC) | 14.0.0      |
| 2018-06        | SA#80   | -    | -  | -   | -   | Update to Rel-15 version (MCC)                         | 15.0.0      |
| 2020-07        | RP-88e  | -    | -  | -   | -   | Upgrade to Rel-16 version without technical change     | 16.0.0      |
| 2022-03        | RP-95e  | -    | -  | -   | -   | Upgrade to Rel-17 version without technical change     | 17.0.0      |
| 2024-03        | RP-103  | -    | -  | -   | -   | Upgrade to Rel-18 version without technical change     | 18.0.0      |



---

# History

| <b>Document history</b> |          |             |
|-------------------------|----------|-------------|
| V18.0.0                 | May 2024 | Publication |
|                         |          |             |
|                         |          |             |
|                         |          |             |
|                         |          |             |