



**E**UROPEAN  
**T**ELECOMMUNICATION  
**S**TANDARD

**ETS 300 557**

January 1997

Seventh Edition

---

Source: ETSI TC-SMG

Reference: RE/SMG-030408PR6

ICS: 33.020

**Key words:** Digital cellular telecommunications system, Global System for Mobile communications (GSM)



**Digital cellular telecommunications system (Phase 2);  
Mobile radio interface layer 3 specification  
(GSM 04.08)**

**ETSI**

European Telecommunications Standards Institute

**ETSI Secretariat**

**Postal address:** F-06921 Sophia Antipolis CEDEX - FRANCE

**Office address:** 650 Route des Lucioles - Sophia Antipolis - Valbonne - FRANCE

**X.400:** c=fr, a=atlas, p=etsi, s=secretariat - **Internet:** secretariat@etsi.fr

Tel.: +33 4 92 94 42 00 - Fax: +33 4 93 65 47 16

---

**Copyright Notification:** No part may be reproduced except as authorized by written permission. The copyright and the foregoing restriction extend to reproduction in all media.

© European Telecommunications Standards Institute 1997. All rights reserved.





	3.4.1.1	General .....	38
	3.4.1.2	Measurement report.....	38
3.4.2		Transfer of messages and link layer service provision.....	38
3.4.3		Channel assignment procedure.....	38
	3.4.3.1	Channel assignment initiation .....	39
	3.4.3.2	Assignment completion.....	41
	3.4.3.3	Abnormal cases .....	41
3.4.4		Handover procedure .....	42
	3.4.4.1	Handover initiation .....	42
	3.4.4.2	Physical channel establishment.....	43
		3.4.4.2.1 Finely synchronized cell case.....	43
		3.4.4.2.2 Non synchronized cell case.....	44
		3.4.4.2.3 Pseudo-synchronized cell case.....	44
		3.4.4.2.4 Pre-synchronized cell case .....	44
	3.4.4.3	Handover completion .....	45
	3.4.4.4	Abnormal cases .....	45
3.4.5		Frequency redefinition procedure .....	46
	3.4.5.1	Abnormal cases .....	46
3.4.6		Channel mode modify procedure.....	47
	3.4.6.1	Initiation of the channel mode modify procedure .....	47
	3.4.6.2	Completion of channel mode modify procedure .....	47
	3.4.6.3	Abnormal cases .....	47
3.4.7		Ciphering mode setting procedure.....	47
	3.4.7.1	Ciphering mode setting initiation .....	47
	3.4.7.2	Ciphering mode setting completion.....	48
3.4.8		Additional channel assignment procedure.....	48
	3.4.8.1	Additional assignment procedure initiation.....	49
	3.4.8.2	Additional assignment procedure completion .....	49
	3.4.8.3	Abnormal cases .....	49
3.4.9		Partial channel release procedure .....	49
	3.4.9.1	Partial release procedure initiation.....	49
	3.4.9.2	Abnormal cases .....	49
3.4.10		Classmark change procedure.....	50
3.4.11		Classmark interrogation procedure .....	50
	3.4.11.1	Classmark interrogation initiation.....	50
	3.4.11.2	Classmark interrogation completion .....	50
3.5		RR connection release procedure.....	51
3.5.1		Normal release procedure .....	51
	3.5.1.1	Channel release procedure initiation.....	51
	3.5.1.2	Abnormal cases .....	51
3.5.2		Radio link failure .....	51
	3.5.2.1	Mobile side .....	52
	3.5.2.2	Network side .....	52
3.5.3		RR connection abortion .....	52
3.6		Receiving a RR STATUS message by a RR entity.....	52
4		Elementary procedures for Mobility Management .....	53
4.1		General.....	53
	4.1.1	Type of MM procedures.....	53
	4.1.2	MM sublayer states.....	54
		4.1.2.1 MM sublayer states in the Mobile Station .....	54
		4.1.2.1.1 Main states .....	54
		4.1.2.1.2 Substates of the MM IDLE state .....	57
	4.1.2.2	The update Status.....	58
	4.1.2.3	MM sublayer states on the network side.....	59
4.2		Behaviour in MM IDLE State .....	59
4.2.1		Primary Service State selection.....	60
	4.2.1.1	Selection of the Service State after Power On.....	60
	4.2.1.2	Other Cases.....	60
4.2.2		Detailed Description of the MS behaviour in MM IDLE State. ....	60
	4.2.2.1	Service State, NORMAL SERVICE.....	60
	4.2.2.2	Service State, ATTEMPTING TO UPDATE.....	61
	4.2.2.3	Service State, LIMITED SERVICE.....	61

	4.2.2.4	Service State, NO IMSI.....	61
	4.2.2.5	Service State, SEARCH FOR PLMN, NORMAL SERVICE.....	61
	4.2.2.6	Service State, SEARCH FOR PLMN.....	62
4.3	4.2.3	Service state when back to state MM IDLE from another state .....	62
	4.3	MM common procedures.....	63
	4.3.1	TMSI reallocation procedure .....	63
	4.3.1.1	TMSI reallocation initiation by the network .....	63
	4.3.1.2	TMSI reallocation completion by the Mobile Station.....	63
	4.3.1.3	TMSI reallocation completion in the network.....	63
	4.3.1.4	Abnormal cases.....	64
	4.3.2	Authentication procedure .....	64
	4.3.2.1	Authentication request by the network.....	65
	4.3.2.2	Authentication response by the Mobile Station.....	65
	4.3.2.3	Authentication processing in the network .....	65
	4.3.2.4	Ciphering key sequence number .....	65
	4.3.2.5	Unsuccessful authentication.....	65
	4.3.2.6	Abnormal cases.....	66
	4.3.3	Identification procedure .....	67
	4.3.3.1	Identity request by the network.....	67
	4.3.3.2	Identification response by the Mobile Station .....	67
	4.3.3.3	Abnormal cases.....	67
	4.3.4	IMSI detach procedure .....	68
	4.3.4.1	IMSI detach initiation by the Mobile Station .....	68
	4.3.4.2	IMSI detach procedure in the network.....	68
	4.3.4.3	IMSI detach completion by the Mobile Station.....	68
	4.3.4.4	Abnormal cases.....	68
	4.3.5	Abort procedure.....	68
	4.3.5.1	Abort procedure initiation by the network .....	69
	4.3.5.2	Abort procedure in the Mobile Station .....	69
4.4	MM specific procedures.....		69
	4.4.1	Location updating procedure.....	69
	4.4.2	Periodic updating.....	70
	4.4.3	IMSI attach procedure .....	71
	4.4.4	Generic Location Updating procedure.....	71
	4.4.4.1	Location updating initiation by the Mobile Station.....	71
	4.4.4.1a	Network Request for Additional MS Capability Information .....	71
	4.4.4.2	Identification request from the network.....	71
	4.4.4.3	Authentication by the network.....	71
	4.4.4.4	Ciphering mode setting by the network .....	72
	4.4.4.5	Attempt Counter .....	72
	4.4.4.6	Location updating accepted by the network .....	72
	4.4.4.7	Location updating not accepted by the network .....	73
	4.4.4.8	Release of RR connection after location updating .....	73
	4.4.4.9	Abnormal cases on the Mobile Station side .....	73
	4.4.4.10	Abnormal cases on the network side.....	75
4.5	Connection management sublayer service provision .....		76
	4.5.1	MM connection establishment.....	76
	4.5.1.1	MM connection establishment initiated by the mobile station .....	76
	4.5.1.2	Abnormal cases.....	78
	4.5.1.3	MM connection establishment initiated by the network .....	79
	4.5.1.4	Abnormal cases.....	79
	4.5.1.5	MM connection establishment for emergency calls.....	79
	4.5.1.6	Call re-establishment.....	80
	4.5.1.6.1	Call re-establishment, initiation by the mobile station.....	80
	4.5.1.6.2	Abnormal cases .....	81
	4.5.1.7	Forced release during MO MM connection establishment .....	82
4.5.2	MM connection information transfer phase .....		83
	4.5.2.1	Sending CM messages .....	83
	4.5.2.2	Receiving CM messages.....	83
	4.5.2.3	Abnormal cases.....	83
4.5.3	MM connection release .....		84

	4.5.3.1	Release of associated RR connection .....	84
4.6		Receiving a MM STATUS message by a MM entity. ....	84
5		Elementary procedures for circuit-switched Call Control .....	85
5.1		Overview .....	85
	5.1.1	General .....	85
	5.1.2	Call Control States .....	88
	5.1.2.1	Call states at the Mobile Station side of the interface .....	88
	5.1.2.1.1	Null (State U0) .....	88
	5.1.2.1.2	MM Connection pending (U0.1) .....	88
	5.1.2.1.3	Call initiated (U1) .....	88
	5.1.2.1.4	Mobile originating call proceeding (U3) .....	88
	5.1.2.1.5	Call delivered (U4) .....	88
	5.1.2.1.6	Call present (U6) .....	88
	5.1.2.1.7	Call received (U7) .....	88
	5.1.2.1.8	Connect Request (U8) .....	88
	5.1.2.1.9	Mobile terminating call confirmed (U9) .....	88
	5.1.2.1.10	Active (U10) .....	88
	5.1.2.1.11	Disconnect request (U11) .....	89
	5.1.2.1.12	Disconnect indication (U12) .....	89
	5.1.2.1.13	Release request (U19) .....	89
	5.1.2.1.14	Mobile originating modify (U26) .....	89
	5.1.2.1.15	Mobile terminating modify (U27) .....	89
	5.1.2.2	Network call states .....	89
	5.1.2.2.1	Null (State N0) .....	89
	5.1.2.2.2	MM connection pending (N0.1) .....	89
	5.1.2.2.3	Call initiated (N1) .....	89
	5.1.2.2.4	Mobile originating call proceeding (N3) .....	89
	5.1.2.2.5	Call delivered (N4) .....	89
	5.1.2.2.6	Call present (N6) .....	89
	5.1.2.2.7	Call received (N7) .....	90
	5.1.2.2.8	Connect request (N8) .....	90
	5.1.2.2.9	Mobile terminating call confirmed (N9) .....	90
	5.1.2.2.10	Active (N10) .....	90
	5.1.2.2.11	{Not used} .....	90
	5.1.2.2.12	Disconnect indication (N12) .....	90
	5.1.2.2.13	Release request (N19) .....	90
	5.1.2.2.14	Mobile originating modify (N26) .....	90
	5.1.2.2.15	Mobile terminating modify (N27) .....	90
	5.1.2.2.16	Connect Indication (N28) .....	90
5.2		Call establishment procedures .....	91
	5.2.1	Mobile originating call establishment .....	91
	5.2.1.1	Call initiation .....	91
	5.2.1.2	Receipt of a setup message .....	92
	5.2.1.3	Receipt of a CALL PROCEEDING message .....	93
	5.2.1.4	Notification of progressing mobile originated call .....	94
	5.2.1.4.1	Notification of interworking in connection with mobile originated call establishment .....	94
	5.2.1.4.2	Call progress in the PLMN/ISDN environment .....	94
	5.2.1.5	Alerting .....	94
	5.2.1.6	Call connected .....	95
	5.2.1.7	Call rejection .....	96
	5.2.1.8	Transit network selection .....	96
	5.2.1.9	Traffic channel assignment at mobile originating call establishment .....	96
	5.2.1.10	Call queuing at mobile originating call establishment .....	96
	5.2.2	Mobile terminating call establishment .....	96
	5.2.2.1	Call indication .....	96
	5.2.2.2	Compatibility checking .....	97
	5.2.2.3	Call confirmation .....	97
	5.2.2.3.1	Response to SETUP .....	97

	5.2.2.3.2	Receipt of CALL CONFIRMED and ALERTING by the network.....	98
	5.2.2.3.3	Call failure procedures.....	98
	5.2.2.3.4	Called Mobile Station clearing during mobile terminating call establishment...	98
	5.2.2.4	Notification of interworking in connection with mobile terminating call establishment .....	99
	5.2.2.5	Call accept.....	100
	5.2.2.6	Active indication.....	100
	5.2.2.7	Traffic channel assignment at mobile terminating call establishment .....	100
	5.2.2.8	Call queuing at mobile terminating call establishment.....	101
	5.2.2.9	User connection attachment during a mobile terminating call .....	101
5.3		Signalling procedures during the "active" state.....	102
	5.3.1	User notification procedure .....	102
	5.3.2	Call rearrangements.....	102
	5.3.3	Not used.....	102
	5.3.4	Support of Dual Services.....	102
	5.3.4.1	Service Description.....	102
	5.3.4.2	Call establishment .....	103
	5.3.4.2.1	Mobile Originating Establishment .....	103
	5.3.4.2.2	Mobile Terminating Establishment.....	104
	5.3.4.3	Changing the Call Mode .....	104
	5.3.4.3.1	Initiation of in-call modification.....	104
	5.3.4.3.2	Successful completion of in-call modification.....	104
	5.3.4.3.3	Change of the channel configuration ..	105
	5.3.4.3.4	Failure of in-call modification .....	105
	5.3.4.4	Abnormal procedures .....	105
5.4		Call clearing .....	107
	5.4.1	Terminology.....	107
	5.4.2	Exception conditions .....	107
	5.4.3	Clearing initiated by the Mobile Station .....	107
	5.4.3.1	Initiation of call clearing .....	107
	5.4.3.2	Receipt of a DISCONNECT message from the Mobile Station.....	108
	5.4.3.3	Receipt of a RELEASE message from the network .....	108
	5.4.3.4	Receipt of a RELEASE COMPLETE message from the Mobile Station .....	108
	5.4.3.5	Abnormal cases.....	108
	5.4.4	Clearing initiated by the network .....	109
	5.4.4.1	Clearing when tones/announcements provided .....	109
	5.4.4.1.1	Receipt of a DISCONNECT message with progress indicator #8 from the network .....	109
	5.4.4.1.2	Expiry of timer T306.....	109
	5.4.4.2	Clearing when tones/announcements not provided .....	109
	5.4.4.2.1	Receipt of a DISCONNECT message without progress indicator or with progress indicator different from #8 from the network.....	109
	5.4.4.2.2	Receipt of a RELEASE message from the Mobile Station .....	110
	5.4.4.2.3	Abnormal cases .....	110
	5.4.4.3	Completion of clearing.....	110
	5.4.4.3.1	Abnormal cases .....	110
	5.4.5	Clear collision .....	110
5.5		Miscellaneous procedures .....	111
	5.5.1	In-band tones and announcements.....	111
	5.5.2	Call collisions.....	111
	5.5.3	Status procedures .....	111
	5.5.3.1	Status enquiry procedure.....	111

	5.5.3.2	Reception of a STATUS message by a CC entity .....	112
	5.5.3.2.1	STATUS message with incompatible state.....	112
	5.5.3.2.2	STATUS message with compatible state.....	112
5.5.4		Call re-establishment, mobile station side .....	112
	5.5.4.1	Indication from the mobility management sublayer.....	112
	5.5.4.2	Reaction of call control.....	112
	5.5.4.3	Completion of re-establishment .....	112
	5.5.4.4	Unsuccessful outcome.....	113
5.5.5		Call re-establishment, network side.....	113
	5.5.5.1	State alignment .....	113
5.5.6		Progress .....	113
5.5.7		DTMF protocol control procedure .....	113
	5.5.7.1	Start DTMF request by the Mobile Station .....	114
	5.5.7.2	Start DTMF response by the network .....	114
	5.5.7.3	Stop DTMF request by the Mobile Station .....	114
	5.5.7.4	Stop DTMF response by the network .....	114
	5.5.7.5	Sequencing of subsequent start DTMF requests by the Mobile Station .....	114
6		Support of packet services .....	116
7		Examples of structured procedures.....	117
	7.1	General.....	117
	7.1.1	Paging request.....	117
	7.1.2	Immediate assignment .....	118
	7.1.3	Service request and contention resolution.....	118
	7.1.4	Authentication .....	119
	7.1.5	Ciphering mode setting.....	119
	7.1.6	Transaction phase .....	120
	7.1.6.1	Transmission mode change.....	120
	7.1.7	Channel release.....	120
	7.2	Abnormal cases .....	120
	7.3	Selected examples .....	121
	7.3.1	Location updating .....	121
	7.3.2	Mobile originating call establishment .....	122
	7.3.3	Mobile terminating call establishment.....	127
	7.3.4	Call clearing .....	130
	7.3.5	DTMF protocol control .....	132
	7.3.6	Handover .....	133
	7.3.7	In-call modification .....	136
	7.3.8	Call re-establishment.....	137
8		Handling of unknown, unforeseen, and erroneous protocol data .....	138
	8.1	General.....	138
	8.2	Message too short.....	138
	8.3	Unknown or unforeseen transaction identifier.....	138
	8.4	Unknown or unforeseen message type.....	139
	8.5	Non-semantic mandatory information element errors .....	139
	8.5.1	Radio resource management .....	140
	8.5.2	Mobility management.....	140
	8.5.3	Call control.....	140
	8.6	Unknown and unforeseen IEs in the non-imperative message part .....	140
	8.6.1	IEs unknown in the message.....	140
	8.6.2	Out of sequence IEs .....	140
	8.6.3	Repeated IEs .....	141
	8.7	Non-imperative message part errors .....	141
	8.7.1	Syntactically incorrect optional IEs .....	141
	8.7.2	Conditional IE errors.....	141
	8.8	Messages with semantically incorrect contents .....	141
9		MESSAGE FUNCTIONAL DEFINITIONS AND CONTENTS .....	142



9.1	Messages for Radio Resources management .....	143
9.1.1	Additional assignment .....	145
9.1.1.1	Mobile Allocation.....	145
9.1.1.2	Starting Time .....	145
9.1.2	Assignment command.....	146
9.1.2.1	Mode of the First Channel .....	147
9.1.2.2	Description of the Second Channel .....	147
9.1.2.3	Mode of the Second Channel .....	147
9.1.2.4	Mobile Allocation and Frequency List, after the starting time .....	147
9.1.2.5	Starting Time .....	147
9.1.2.6	Reference cell frequency list.....	149
9.1.2.7	Cell Channel Description .....	149
9.1.2.8	Cipher Mode Setting .....	149
9.1.3	Assignment complete .....	150
9.1.4	Assignment failure.....	151
9.1.5	Channel mode modify .....	152
9.1.5.1	Channel Description .....	152
9.1.6	Channel mode modify acknowledge .....	153
9.1.7	Channel release .....	154
9.1.8	Channel request .....	155
9.1.9	Ciphering mode command.....	157
9.1.10	Ciphering mode complete .....	157
9.1.10.1	Mobile Equipment Identity .....	157
9.1.11	Classmark change .....	158
9.1.11.1	Additional Mobile Station Classmark Information .....	158
9.1.11.2	Mobile Station Classmark.....	158
9.1.12	Classmark enquiry.....	158
9.1.13	Frequency redefinition.....	159
9.1.13.1	Cell Channel Description .....	159
9.1.14	Handover access.....	159
9.1.15	Handover command.....	160
9.1.15.1	Synchronization Indication .....	161
9.1.15.2	Mode of the First Channel .....	161
9.1.15.3	Description of the Second Channel .....	162
9.1.15.4	Mode of the Second Channel .....	162
9.1.15.5	Frequency Channel Sequence, Frequency List, Frequency short list and Mobile Allocation, after time. ....	162
9.1.15.6	Starting Time .....	163
9.1.15.7	Reference cell frequency list.....	163
9.1.15.8	Real Time Difference.....	163
9.1.15.9	Timing Advance .....	164
9.1.15.10	Cipher Mode Setting .....	164
9.1.16	Handover complete .....	164
9.1.16.1	Mobile Observed Time Difference .....	164
9.1.17	Handover failure .....	165
9.1.18	Immediate assignment.....	166
9.1.18.1	Mobile Allocation.....	167
9.1.18.2	Starting Time .....	167
9.1.18.3	IA Rest Octets (Frequency parameters, before time).....	167
9.1.19	Immediate assignment extended .....	168
9.1.19.1	Unnecessary IEs.....	169
9.1.19.2	Mobile Allocation.....	169
9.1.19.3	Starting Time .....	169
9.1.19.4	Maximum message length .....	169
9.1.19.5	IAX Rest Octets .....	169
9.1.20	Immediate assignment reject .....	170
9.1.20.1	Use of the indexes.....	171
9.1.20.2	Filling of the message.....	171
9.1.21	Measurement report .....	172
9.1.22	Paging request type 1.....	173
9.1.22.1	Unnecessary IE .....	174
9.1.22.2	Channels needed for Mobiles 1 and 2.....	174

	9.1.22.3	Mobile Identities .....	174
	9.1.22.4	P1 Rest Octets .....	174
9.1.23		Paging request type 2 .....	175
	9.1.23.1	Channels needed for Mobiles 1 and 2 .....	176
	9.1.23.2	Mobile Identity 3 .....	176
	9.1.23.3	P2 Rest Octets .....	176
9.1.24		Paging request type 3 .....	177
	9.1.24.1	Channels needed for Mobiles 1 and 2 .....	178
	9.1.24.2	P3 Rest Octets .....	178
9.1.25		Paging response .....	178
	9.1.25.1	Mobile Station Classmark .....	179
9.1.26		Partial release .....	179
	9.1.26.1	Channel Description .....	179
9.1.27		Partial release complete .....	179
9.1.28		Physical information .....	180
9.1.29		RR Status .....	180
9.1.30		Synchronization channel information .....	181
9.1.31		System information Type 1 .....	182
9.1.32		System information type 2 .....	182
9.1.33		System information type 2bis .....	183
9.1.34		System information type 2ter .....	184
9.1.35		System information type 3 .....	185
9.1.36		System information type 4 .....	186
	9.1.36.1	CBCH Channel description .....	187
	9.1.36.2	CBCH Mobile Allocation .....	187
	9.1.36.3	SI 4 Rest Octets .....	187
9.1.37		System information type 5 .....	187
9.1.38		System information type 5bis .....	188
9.1.39		System information type 5ter .....	189
9.1.40		System information type 6 .....	189
	9.1.40.1	Cell Identity .....	190
	9.1.40.2	Location Area Identification .....	190
	9.1.40.3	Cell Options .....	190
	9.1.40.4	NCC permitted .....	190
9.1.41		System information type 7 .....	190
9.1.42		System information type 8 .....	191
9.2		Messages for mobility management .....	192
	9.2.1	Authentication reject .....	193
	9.2.2	Authentication request .....	193
	9.2.3	Authentication response .....	194
	9.2.4	CM Re-establishment request .....	194
	9.2.4.1	Location area identification .....	194
	9.2.4.2	Mobile Station Classmark .....	195
	9.2.5	CM service accept .....	195
	9.2.6	CM service reject .....	195
	9.2.7	CM service abort .....	196
	9.2.8	Abort .....	196
	9.2.9	CM service request .....	197
	9.2.9.1	Mobile Station Classmark .....	197
	9.2.10	Identity request .....	197
	9.2.11	Identity response .....	198
	9.2.12	IMSI detach indication .....	198
	9.2.12.1	Mobile Station Classmark .....	198
	9.2.13	Location updating accept .....	199
	9.2.13.1	Follow on proceed .....	199
	9.2.14	Location updating reject .....	199
	9.2.15	Location updating request .....	200
	9.2.15.1	Location area identification .....	200
	9.2.15.2	Mobile Station Classmark .....	200
	9.2.16	MM Status .....	201
	9.2.17	TMSI reallocation command .....	201
	9.2.18	TMSI reallocation complete .....	202
9.3		Messages for circuit-switched call control .....	203

9.3.1	Alerting .....	204
9.3.1.1	Alerting (network to mobile station direction).....	204
	9.3.1.1.1 Facility .....	204
	9.3.1.1.2 Progress indicator .....	204
	9.3.1.1.3 User-user .....	204
9.3.1.2	Alerting (mobile station to network direction).....	205
	9.3.1.2.1 Facility .....	205
	9.3.1.2.2 User-user .....	205
	9.3.1.2.3 SS version.....	205
9.3.2	Call confirmed .....	206
9.3.2.1	Repeat indicator.....	207
9.3.2.2	Bearer capability 1 and bearer capability 2 .....	207
9.3.2.3	Cause .....	207
9.3.2.4	CC Capabilities .....	207
9.3.3	Call proceeding .....	208
9.3.3.1	Repeat indicator.....	209
9.3.3.2	Bearer capability 1 and bearer capability 2 .....	209
9.3.3.3	Facility.....	209
9.3.3.4	Progress Indicator .....	209
9.3.4	Congestion control .....	209
9.3.4.1	Cause .....	210
9.3.5	Connect .....	210
9.3.5.1	Connect (network to mobile station direction) .....	210
	9.3.5.1.1 Facility .....	210
	9.3.5.1.2 Progress indicator.....	210
	9.3.5.1.3 User-user .....	210
9.3.5.2	Connect (mobile station to network direction) .....	211
	9.3.5.2.1 Facility .....	211
	9.3.5.2.2 User-user .....	211
	9.3.5.2.3 SS version.....	211
9.3.6	Connect acknowledge .....	212
9.3.7	Disconnect.....	212
9.3.7.1	Disconnect (network to mobile station direction) .....	212
	9.3.7.1.1 Facility .....	213
	9.3.7.1.2 Progress indicator.....	213
	9.3.7.1.3 User-user .....	213
9.3.7.2	Disconnect (mobile station to network direction) .....	213
	9.3.7.2.1 Facility .....	214
	9.3.7.2.2 User-user .....	214
	9.3.7.2.3 SS version.....	214
9.3.8	Emergency setup .....	214
9.3.8.1	Bearer capability .....	214
9.3.9	Facility .....	215
9.3.9.1	Facility (network to mobile station direction).....	215
9.3.9.2	Facility (mobile station to network direction).....	216
	9.3.9.2.1 SS version.....	216
9.3.10	Hold .....	217
9.3.11	Hold Acknowledge.....	217
9.3.12	Hold Reject.....	218
9.3.13	Modify .....	219
9.3.13.1	Low layer compatibility.....	219
9.3.13.2	High layer compatibility .....	219
9.3.13.3	Reverse call setup direction.....	219
9.3.14	Modify complete .....	220
9.3.14.1	Low layer compatibility.....	220
9.3.14.2	High layer compatibility .....	220
9.3.14.3	Reverse call setup direction.....	220
9.3.15	Modify reject .....	221
9.3.15.1	Low layer compatibility.....	221
9.3.15.2	High layer compatibility .....	221
9.3.16	Notify .....	222
9.3.17	Progress.....	222
9.3.17.1	User-user .....	222

9.3.18	Release.....	223
9.3.18.1	Release (network to mobile station direction) .....	223
9.3.18.1.1	Cause .....	224
9.3.18.1.2	Second cause .....	224
9.3.18.1.3	Facility .....	224
9.3.18.1.4	User-user .....	224
9.3.18.2	Release (mobile station to network direction) .....	224
9.3.18.2.1	Cause .....	225
9.3.18.2.2	Second cause .....	225
9.3.18.2.3	Facility .....	225
9.3.18.2.4	User-user .....	225
9.3.18.2.5	SS version .....	225
9.3.19	Release complete .....	225
9.3.19.1	Release complete (network to mobile station direction) ...	225
9.3.19.1.1	Cause .....	226
9.3.19.1.2	Facility .....	226
9.3.19.1.3	User-user .....	226
9.3.19.2	Release complete (mobile station to network direction) ...	226
9.3.19.2.1	Cause .....	227
9.3.19.2.2	Facility .....	227
9.3.19.2.3	User-user .....	227
9.3.19.2.4	SS version .....	227
9.3.20	Retrieve .....	227
9.3.21	Retrieve Acknowledge .....	228
9.3.22	Retrieve Reject .....	228
9.3.23	Setup .....	229
9.3.23.1	Setup (mobile terminated call establishment) .....	229
9.3.23.1.1	BC repeat indicator.....	230
9.3.23.1.2	Bearer capability 1 and bearer capability 2 .....	230
9.3.23.1.3	Facility .....	230
9.3.23.1.4	Progress indicator .....	231
9.3.23.1.5	Called party subaddress.....	231
9.3.23.1.6	LLC repeat indicator .....	231
9.3.23.1.7	Low layer compatibility I .....	231
9.3.23.1.8	Low layer compatibility II .....	231
9.3.23.1.9	HLC repeat indicator .....	231
9.3.23.1.10	High layer compatibility i.....	231
9.3.23.1.11	High layer compatibility ii.....	231
9.3.23.1.12	User-user .....	231
9.3.23.2	Setup (mobile originating call establishment) .....	232
9.3.23.2.1	BC repeat indicator.....	233
9.3.23.2.2	Facility .....	233
9.3.23.2.3	LLC repeat indicator .....	233
9.3.23.2.4	Low layer compatibility I .....	234
9.3.23.2.5	Low layer compatibility II .....	234
9.3.23.2.6	HLC repeat indicator .....	234
9.3.23.2.7	High layer compatibility i.....	234
9.3.23.2.8	High layer compatibility ii.....	234
9.3.23.2.9	User-user .....	234
9.3.23.2.10	SS version .....	234
9.3.23.2.11	CLIR suppression.....	234
9.3.23.2.12	CLIR invocation .....	234
9.3.23.2.13	CC Capabilities.....	234
9.3.24	Start DTMF .....	235
9.3.25	Start DTMF Acknowledge.....	235
9.3.25.1	Keypad facility .....	235
9.3.26	Start DTMF reject .....	236
9.3.27	Status.....	236
9.3.27.1	Auxiliary states .....	236
9.3.28	Status enquiry .....	237
9.3.29	Stop DTMF .....	237
9.3.30	Stop DTMF acknowledge .....	238

9.3.31	User information .....	238
9.3.31.1	User-user .....	238
9.3.31.2	More data.....	239
10	General message format and information elements coding .....	239
10.1	Overview .....	239
10.2	Protocol Discriminator.....	240
10.3	Skip indicator and transaction identifier .....	240
10.3.1	Skip indicator .....	240
10.3.2	Transaction identifier .....	240
10.4	Message Type .....	241
10.5	Other information elements .....	245
10.5.1	Common information elements .....	247
10.5.1.1	Cell identity .....	247
10.5.1.2	Ciphering Key Sequence Number .....	248
10.5.1.3	Location Area Identification .....	249
10.5.1.4	Mobile Identity.....	251
10.5.1.5	Mobile Station Classmark 1 .....	253
10.5.1.6	Mobile Station Classmark 2.....	255
10.5.1.7	Mobile Station Classmark 3.....	258
10.5.1.8	Spare Half Octet .....	259
10.5.2	Radio Resource management information elements.....	260
10.5.2.1a	BA Range .....	260
10.5.2.1b	Cell Channel Description .....	262
10.5.2.1b.1	General description.....	262
10.5.2.1b.2	Bit map 0 format .....	264
10.5.2.1b.3	Range 1 024 format .....	265
10.5.2.1b.4	Range 512 format .....	267
10.5.2.1b.5	Range 256 format .....	269
10.5.2.1b.6	Range 128 format .....	271
10.5.2.1b.7	Variable bit map format.....	272
10.5.2.2	Cell Description.....	274
10.5.2.3	Cell Options (BCCH).....	275
10.5.2.3a	Cell Options (SACCH) .....	275
10.5.2.4	Cell Selection Parameters .....	278
10.5.2.5	Channel Description .....	280
10.5.2.6	Channel Mode .....	283
10.5.2.7	Channel Mode 2 .....	284
10.5.2.8	Channel Needed.....	285
10.5.2.9	Cipher Mode Setting .....	286
10.5.2.10	Cipher Response .....	287
10.5.2.11	Control Channel Description.....	288
10.5.2.12	Frequency Channel Sequence .....	291
10.5.2.13	Frequency List .....	293
10.5.2.13.1	General description.....	293
10.5.2.13.2	Bit map 0 format .....	294
10.5.2.13.3	Range 1 024 format .....	295
10.5.2.13.4	Range 512 format .....	298
10.5.2.13.5	Range 256 format .....	301
10.5.2.13.6	Range 128 format .....	304
10.5.2.13.7	Variable bit map format.....	308
10.5.2.14	Frequency Short List.....	308
10.5.2.15	Handover Reference .....	309
10.5.2.16	IA Rest Octets .....	310
10.5.2.17	IAR Rest Octets .....	313
10.5.2.18	IAX Rest Octets .....	314
10.5.2.19	L2 Pseudo Length.....	315
10.5.2.20	Measurement Results.....	316
10.5.2.21	Mobile Allocation.....	321
10.5.2.21a	Mobile Time Difference.....	323
10.5.2.22	Neighbour Cells Description .....	324
10.5.2.23	P1 Rest Octets .....	326
10.5.2.24	P2 Rest Octets .....	327

	10.5.2.25	P3 Rest Octets .....	328
	10.5.2.26	Page Mode .....	329
	10.5.2.27	NCC Permitted .....	330
	10.5.2.28	Power Command .....	331
	10.5.2.28a	Power Command and access type .....	332
	10.5.2.29	RACH Control Parameters .....	333
	10.5.2.30	Request Reference .....	336
	10.5.2.31	RR Cause .....	337
	10.5.2.32	SI 1 Rest Octets .....	339
	10.5.2.33	SI 2bis Rest Octets .....	339
	10.5.2.33a	SI 2ter Rest Octets .....	340
	10.5.2.34	SI 3 Rest Octets .....	341
	10.5.2.35	SI 4 Rest Octets .....	347
	10.5.2.36	SI 7 Rest Octets .....	355
	10.5.2.37	SI 8 Rest Octets .....	355
	10.5.2.38	Starting Time .....	355
	10.5.2.39	Synchronization Indication .....	357
	10.5.2.40	Timing Advance .....	358
	10.5.2.41	Time Difference .....	359
	10.5.2.42	TMSI .....	360
	10.5.2.43	Wait Indication .....	362
	10.5.2.44	Additional Multiband Information .....	363
10.5.3		Mobility management information elements .....	364
	10.5.3.1	Authentication parameter RAND .....	364
	10.5.3.2	Authentication parameter SRES .....	365
	10.5.3.3	CM service type .....	366
	10.5.3.4	Identity type .....	367
	10.5.3.5	Location updating type .....	368
	10.5.3.6	Reject cause .....	369
	10.5.3.7	Follow-on Proceed .....	370
10.5.4		Call control information elements .....	370
	10.5.4.1	Extensions of codesets .....	370
	10.5.4.2	Locking shift procedure .....	371
	10.5.4.3	Non-locking shift procedure .....	372
	10.5.4.4	Auxiliary states .....	373
	10.5.4.5	Bearer capability .....	374
	10.5.4.5.1	Static conditions for the bearer capability IE contents .....	381
	10.5.4.5a	Call Control Capabilities .....	382
	10.5.4.6	Call state .....	383
	10.5.4.7	Called party BCD number .....	384
	10.5.4.8	Called party subaddress .....	386
	10.5.4.9	Calling party BCD number .....	387
	10.5.4.10	Calling party subaddress .....	388
	10.5.4.11	Cause .....	390
	10.5.4.11a	CLIR suppression .....	396
	10.5.4.11b	CLIR invocation .....	396
	10.5.4.12	Congestion level .....	397
	10.5.4.13	Connected number .....	398
	10.5.4.14	Connected subaddress .....	399
	10.5.4.15	Facility .....	399
	10.5.4.16	High layer compatibility .....	400
	10.5.4.16.1	Static conditions for the high layer compatibility IE contents .....	401
	10.5.4.17	Keypad facility .....	402
	10.5.4.18	Low layer compatibility .....	402
	10.5.4.19	More data .....	403
	10.5.4.20	Notification indicator .....	403
	10.5.4.21	Progress indicator .....	404
	10.5.4.22	Repeat indicator .....	406
	10.5.4.22a	Reverse call setup direction .....	407
	10.5.4.23	Signal .....	407
	10.5.4.24	SS Version Indicator .....	408

	10.5.4.25	User-user .....	409
11	List of system parameters .....		411
11.1	Timers and counters for radio resource management .....		411
	11.1.1	Timers on the MS side .....	411
	11.1.2	Timers on the network side .....	411
	11.1.3	Other parameters .....	413
11.2	Timers of mobility management .....		413
	11.2.1	Timer T3240 .....	414
11.3	Timers of circuit-switched call control .....		415
Annex A (informative):	Example of subaddress information element coding .....		417
Annex B (normative):	COMPATIBILITY CHECKING .....		418
B.1	Introduction .....		418
B.2	Calling side compatibility checking .....		418
	B.2.1	Compatibility checking of the CM SERVICE REQUEST message .....	418
	B.2.2	Compatibility/Subscription checking of the SETUP message .....	418
B.3	Called side compatibility checking .....		418
	B.3.1	Compatibility checking with addressing information .....	418
	B.3.2	Network-to-MS compatibility checking .....	419
	B.3.3	User-to-User compatibility checking .....	419
B.4	High layer compatibility checking .....		419
Annex C (normative):	Low layer information coding principles .....		420
C.1	Purpose .....		420
C.2	Principles .....		420
	C.2.1	Definition of types of information .....	420
	C.2.2	Examination by network .....	420
	C.2.3	Location of type I information .....	421
	C.2.4	Location of types II and III information .....	421
	C.2.5	Relationship between bearer capability and low layer compatibility information elements .....	421
Annex D (informative):	Examples of bearer capability information element coding .....		422
D.1	Coding for speech for a full rate support only mobile station .....		422
	D.1.1	Mobile station to network direction .....	422
	D.1.2	Network to mobile station direction .....	422
D.2	An example of a coding for modem access with V22-bis, 2.4 kbit/s, 8 bit no parity .....		423
	D.2.1	Mobile station to network direction .....	423
	D.2.2	Network to mobile station direction .....	424
D.3	An example of a coding for group 3 facsimile (9.6 kbit/s, transparent) .....		425
	D.3.1	Mobile station to network direction .....	425
	D.3.2	Network to mobile station direction .....	426
Annex E (informative):	Comparison between call control procedures specified in technical specification GSM 04.08 and CCITT Recommendation Q.931 .....		427
Annex F (informative):	GSM specific cause values for radio resource management .....		432
Annex G (informative):	GSM specific cause values for mobility management .....		434
G.1	Causes related to MS identification .....		434
G.2	Cause related to subscription options .....		434
G.3	Causes related to PLMN specific network failures and congestion .....		434
G.4	Causes related to nature of request .....		435
G.5	Causes related to invalid messages .....		435
Annex H (informative):	GSM specific cause values for call control .....		437
H.1	Normal class .....		437
H.2	Resource unavailable class .....		438
H.3	Service or option not available class .....		439
H.4	Service or option not implemented class .....		440
H.5	Invalid message (e.g., parameter out of range) class .....		440

H.6	Protocol error (e.g., unknown message) class.....	441
H.7	Interworking class .....	442
Annex J (informative):	Algorithm to encode frequency list information elements .....	443
J.1	Introduction.....	443
J.2	General principle .....	443
J.3	Performances.....	446
J.4	Encoding algorithm.....	448
J.5	Decoding .....	451
J.6	A detailed example.....	452
Annex K (informative):	Default Codings of Information Elements .....	454
K.1	Common information elements. ....	454
K.2	Radio Resource management information elements.....	455
K.3	Mobility management information elements.....	457
K.4	Call control information elements.....	458
History .....		459



## Foreword

This European Telecommunication Standard (ETS) has been produced by the Special Mobile Group (SMG) Technical Committee (TC) of the European Telecommunications Standards Institute (ETSI).

This ETS specifies the procedures used at the radio interface (Reference Point Um, see GSM 04.02) for Call Control (CC), Mobility Management (MM) and Radio Resource (RR) management within the Digital cellular telecommunications system (Phase 2).

**This ETS correspond to GSM Technical Specification (GSM-TS) GSM 04.08 version 4.16.1.**

The specification from which this ETS has been derived was originally based on CEPT documentation, hence the presentation of this ETS may not be entirely in accordance with the ETSI/PNE rules.

Reference is made within this ETS to GSM Technical Specifications (GSM-TS) (see note).

NOTE: TC-SMG has produced documents which give the technical specifications for the implementation of the digital cellular telecommunications system. Historically, these documents have been identified as GSM Technical Specifications (GSM-TS). These TSs may have subsequently become I-ETSS (Phase 1), or ETSS (Phase 2), whilst others may become ETSI Technical Reports (ETRs). GSM-TSs are, for editorial reasons, still referred to in current GSM ETSS.

<b>Transposition dates</b>	
Date of adoption	20 December 1996
Date of latest announcement of this ETS (doa):	30 April 1997
Date of latest publication of new National Standard or endorsement of this ETS (dop/e):	31 October 1997
Date of withdrawal of any conflicting National Standard (dow):	31 October 1997

Blank page

## 0 Scope

This European Telecommunication Standard (ETS) specifies the procedures used at the radio interface (Reference Point Um, see GSM 04.02) for Call Control (CC), Mobility Management (MM) and Radio Resource (RR) management.

When the notations for "further study" or "FS" or "FFS" are present in this ETS they mean that the indicated text is not a normative portion of this standard.

These procedures are defined in terms of messages exchanged over the control channels of the radio interface. The control channels are described in GSM 04.03.

The structured functions and procedures of this protocol and the relationship with other layers and entities are described in general terms in GSM 04.07.

### 0.1 Scope of the Technical Specification

The procedures currently described in this ETS are for the call control of circuit-switched connections, mobility management and radio resource management.

GSM 04.10 contains functional procedures for support of supplementary services.

GSM 04.11 contains functional procedures for support of point-to-point short message services.

GSM 04.12 contains functional description of short message - cell broadcast.

NOTE: "layer 3" includes the functions and protocols described in this ETS. The terms "data link layer" and "layer 2" are used interchangeably to refer to the layer immediately below layer 3.

### 0.2 Application to the interface structures

The layer 3 procedures apply to the interface structures defined in GSM 04.03. They use the functions and services provided by layer 2 defined in GSM 04.05 and 04.06. GSM 04.07 gives the general description of layer 3 including procedures, messages format and error handling.

### 0.3 Structure of layer 3 procedures

A building block method is used to describe the layer 3 procedures.

The basic building blocks are "elementary procedures" provided by the protocol control entities of the three sublayers, i.e. radio resource management, mobility management and connection management sublayer.

Complete layer 3 transactions consist of specific sequences of elementary procedures. The term "structured procedure" is used for these sequences.

### 0.4 Test procedures

Test procedures of GSM radio interface signalling are described in GSM 11.10 and 11.20.

## 0.5 Use of logical channels

The logical control channels are defined in GSM 05.02. In the following those control channels are considered which carry signalling information or specific types of user packet information:

- i) Broadcast Control CHannel (BCCH): downlink only, used to broadcast Cell specific information;
- ii) Synchronization CHannel (SCH): downlink only, used to broadcast synchronization and BSS identification information;
- iii) Paging CHannel (PCH): downlink only, used to send page requests to Mobile Stations;
- iv) Random Access CHannel (RACH): uplink only, used to request a Dedicated Control CHannel;
- v) Access Grant CHannel (AGCH): downlink only, used to allocate a Dedicated Control CHANNEL;
- vi) Stand Alone Dedicated Control CHannel (SDCCH): bi-directional;
- vii) Fast Associated Control CHannel (FACCH): bi-directional, associated with a Traffic CHannel;
- viii) Slow Associated Control CHannel (SACCH): bi-directional, associated with a SDCCH or a Traffic CHannel;
- ix) Cell Broadcast CHannel (CBCH): downlink only used for general (not point to point) short message information.

Two service access points are defined on signalling layer 2 which are discriminated by their Service Access Point Identifiers (SAPI) (see GSM 04.06):

- i) SAPI 0: supports the transfer of signalling information including user-user information;
- ii) SAPI 3: supports the transfer of user short messages.

Layer 3 selects the service access point, the logical control channel and the mode of operation of layer 2 (acknowledged, unacknowledged or random access, see GSM 04.05 and 04.06) as required for each individual message.

## 0.6 Overview of control procedures

### 0.6.1 List of procedures

The following procedures are specified in this ETS:

- a) Section 3 specifies elementary procedures for Radio Resource management:
  - system information broadcasting (section 3.2.2);
  - radio resources connection establishment (section 3.3):
    - immediate assignment procedure (section 3.3.1);
    - paging procedure (section 3.3.2);
  - radio resources connection transfer phase (section 3.4):
    - measurement report procedure (section 3.4.1.2);
    - intracell change of channels (section 3.4.3);
    - intercell change of channels (section 3.4.4);
    - frequency redefinition procedure (section 3.4.5);
    - channel mode change procedure (section 3.4.6);
    - ciphering mode setting procedure (section 3.4.7);
    - additional channel assignment procedure (section 3.4.8);
    - partial channel release procedure (section 3.5);
  - radio resources connection release (section 3.5).

- b) Section 4 specifies elementary procedures for Mobility Management:
- mobility management common procedures (section 4.3):
    - TMSI reallocation procedure (section 4.3.1);
    - authentication procedure (section 4.3.2);
    - identification procedure (section 4.3.3);
    - IMSI detach procedure (section 4.3.4);
    - abort procedure (section 4.3.5);
  - mobility management specific procedures (section 4.4):
    - location updating procedure (section 4.4.1);
    - periodic updating (section 4.4.2);
    - IMSI attach procedure (section 4.4.3);
    - generic location updating procedure (section 4.4);
  - connection management sublayer service provision:
    - mobility management connection establishment (section 4.5.1);
    - mobility management connection information transfer phase (section 4.5.2);
    - mobility management connection release (section 4.5.3).
- c) Section 5 specifies elementary procedures for circuit switched Call Control comprising the following elementary procedures:
- mobile originating call establishment (section 5.2.1);
  - mobile terminating call establishment (section 5.2.2);
  - signalling procedures during the active state (section 5.3):
    - user notification procedure (section 5.3.1);
    - call rearrangements (section 5.3.2);
    - DTMF protocol control procedure (section 5.3.3);
    - in-call modification (section 5.3.4);
  - call clearing initiated by the mobile station (section 5.4.3);
  - call clearing initiated by the network (section 5.4.4);
  - miscellaneous procedures:
    - in-band tones and announcements (section 5.5.1);
    - status enquiry procedure (section 5.5.3);
    - call re-establishment procedure (section 5.5.4).

The elementary procedures can be combined to form structured procedures. Examples of such structured procedures are given in section 7. This part of the Technical Specification is only provided for guidance to assist implementations.

Section 8 specifies actions to be taken on various error conditions.

## 1 Normative references

This ETS incorporates by dated and undated reference, provisions from other publications. These normative references are cited at the appropriate places in the text and the publications are listed hereafter. For dated references, subsequent amendments to or revisions of any of these publications apply to this ETS only when incorporated in it by amendment or revision. For undated references, the latest edition of the publication referred to applies.

- [1] GSM 01.02 (ETR 099): "Digital cellular telecommunications system (Phase 2); General description of a GSM Public Land Mobile Network (PLMN)".
- [2] GSM 01.04 (ETR 100): "Digital cellular telecommunications system (Phase 2); Abbreviations and acronyms".
- [3] GSM 02.02 (ETS 300 501): "Digital cellular telecommunications system (Phase 2); Bearer Services (BS) supported by a GSM Public Land Mobile Network (PLMN)".
- [4] GSM 02.03 (ETS 300 502): "Digital cellular telecommunications system (Phase 2); Teleservices supported by a GSM Public Land Mobile Network (PLMN)".
- [5] GSM 02.09 (ETS 300 506): "Digital cellular telecommunications system (Phase 2); Security aspects".
- [6] GSM 02.11 (ETS 300 507): "Digital cellular telecommunications system (Phase 2); Service accessibility".
- [7] GSM 02.17 (ETS 300 509): "Digital cellular telecommunications system (Phase 2); Subscriber identity modules Functional characteristics".
- [8] GSM 02.40 (ETS 300 512): "Digital cellular telecommunications system (Phase 2); Procedures for call progress indications".
- [9] GSM 03.01 (ETS 300 521): "Digital cellular telecommunications system (Phase 2); Network functions".
- [10] GSM 03.03 (ETS 300 523): "Digital cellular telecommunications system (Phase 2); Numbering, addressing and identification".
- [11] GSM 03.13 (ETS 300 531): "Digital cellular telecommunications system (Phase 2); Discontinuous Reception (DRX) in the GSM system".
- [12] GSM 03.14 (ETS 300 532): "Digital cellular telecommunications system (Phase 2); Support of Dual Tone Multi-Frequency signalling (DTMF) via the GSM system".
- [13] GSM 03.20 (ETS 300 534): "Digital cellular telecommunications system (Phase 2); Security related network functions".
- [14] GSM 03.22 (ETS 300 535): "Digital cellular telecommunications system (Phase 2); Functions related to Mobile Station (MS) in idle mode".
- [15] GSM 04.02 (ETS 300 551): "Digital cellular telecommunications system (Phase 2); GSM Public Land Mobile Network (PLMN) access reference configuration".
- [16] GSM 04.03 (ETS 300 552): "Digital cellular telecommunications system (Phase 2); Mobile Station - Base Station System (MS - BSS) interface Channel structures and access capabilities".

- [17] GSM 04.04 (ETS 300 553): "Digital cellular telecommunications system (Phase 2); layer 1; General requirements".
- [18] GSM 04.05 (ETS 300 554): "Digital cellular telecommunications system (Phase 2); Data Link (DL) layer; General aspects".
- [19] GSM 04.06 (ETS 300 555): "Digital cellular telecommunications system (Phase 2); Mobile Station - Base Station System (MS - BSS) interface; Data Link (DL) layer specification".
- [20] GSM 04.07 (ETS 300 556): "Digital cellular telecommunications system (Phase 2); Mobile radio interface signalling layer 3; General aspects".
- [21] GSM 04.10 (ETS 300 558): "Digital cellular telecommunications system (Phase 2); Mobile radio interface layer 3; Supplementary services specification; General aspects".
- [22] GSM 04.11 (ETS 300 559): "Digital cellular telecommunications system (Phase 2); Point-to-Point (PP) Short Message Service (SMS) support on mobile radio interface".
- [23] GSM 04.12 (ETS 300 560): "Digital cellular telecommunications system (Phase 2); Short Message Service Cell Broadcast (SMSCB) support on the mobile radio interface".
- [24] GSM 04.80 (ETS 300 564): "Digital cellular telecommunications system (Phase 2); Mobile radio interface layer 3 supplementary services specification; Formats and coding".
- [25] GSM 04.81 (ETS 300 565): "Digital cellular telecommunications system (Phase 2); Line identification supplementary services - Stage 3".
- [26] GSM 04.82 (ETS 300 566): "Digital cellular telecommunications system (Phase 2); Call Forwarding (CF) supplementary services - Stage 3".
- [27] GSM 04.83 (ETS 300 567): "Digital cellular telecommunications system (Phase 2); Call Waiting (CW) and Call Hold (HOLD) supplementary services - Stage 3".
- [28] GSM 04.84 (ETS 300 568): "Digital cellular telecommunications system (Phase 2); MultiParty (MPTY) supplementary services - Stage 3".
- [29] GSM 04.85 (ETS 300 569): "Digital cellular telecommunications system (Phase 2); Closed User Group (CUG) supplementary services - Stage 3".
- [30] GSM 04.86 (ETS 300 570): "Digital cellular telecommunications system (Phase 2); Advice of Charge (AoC) supplementary services - Stage 3".
- [31] GSM 04.88 (ETS 300 571): "Digital cellular telecommunications system (Phase 2); Call Barring (CB) supplementary services - Stage 3".
- [32] GSM 05.02 (ETS 300 574): "Digital cellular telecommunications system (Phase 2); Multiplexing and multiple access on the radio path".
- [33] GSM 05.05 (ETS 300 577): "Digital cellular telecommunications system (Phase 2); Radio transmission and reception".
- [34] GSM 05.08 (ETS 300 578): "Digital cellular telecommunications system (Phase 2); Radio subsystem link control".
- [35] GSM 05.10 (ETS 300 579): "Digital cellular telecommunications system (Phase 2); Radio subsystem synchronization".

- [36] GSM 07.01 (ETS 300 582): "Digital cellular telecommunications system (Phase 2); General on Terminal Adaptation Functions (TAF) for Mobile Stations (MS)".
- [37] GSM 09.02 (ETS 300 599): "Digital cellular telecommunications system (Phase 2); Mobile Application Part (MAP) specification".
- [38] GSM 09.07 (ETS 300 604): "Digital cellular telecommunications system (Phase 2); General requirements on interworking between the Public Land Mobile Network (PLMN) and the Integrated Services Digital Network (ISDN) or Public Switched Telephone Network (PSTN)".
- [39] GSM 11.10 (ETS 300 607): "Digital cellular telecommunications system (Phase 2); Mobile Station (MS) conformity specification".
- [40] GSM 11.20 (ETS 300 609-1): "Digital cellular telecommunications system (Phase 2); The GSM Base Station System (BSS) equipment specification".
- [41] ISO/IEC 646 (1991): "Information technology - ISO 7-bit coded character set for information interchange".
- [42] ISO/IEC 6429: "Information technology - Control functions for coded character sets".
- [43] ISO 8348 (1987): "Information processing systems - Data communications - Network service definition".
- [44] CCITT Recommendation E.163: "Numbering plan for the international telephone service".
- [45] CCITT Recommendation E.164: "Numbering plan for the ISDN era".
- [46] CCITT Recommendation E.212: "Identification plan for land mobile stations".
- [47] ITU-T Recommendation F.69 (1993): "Plan for telex destination codes".
- [48] CCITT Recommendation I.330: "ISDN numbering and addressing principles".
- [49] CCITT Recommendation I.440 (1989): "ISDN user-network interface data link layer - General aspects".
- [50] CCITT Recommendation I.450 (1989): "ISDN user-network interface layer 3 General aspects".
- [51] ITU-T Recommendation I.500 (1993): "General structure of the ISDN interworking recommendations".
- [52] CCITT Recommendation T.50: "International Alphabet No. 5".
- [53] CCITT Recommendation Q.931: "ISDN user-network interface layer 3 specification for basic control".
- [54] CCITT Recommendation V.21: "300 bits per second duplex modem standardized for use in the general switched telephone network".
- [55] CCITT Recommendation V.22: "1 200 bits per second duplex modem standardized for use in the general switched telephone network and on point-to-point 2-wire leased telephone-type circuits".
- [56] CCITT Recommendation V.22bis: "2 400 bits per second duplex modem using the frequency division technique standardized for use on the general switched telephone network and on point-to-point 2-wire leased telephone-type circuits".



- [57] CCITT Recommendation V.23: "600/1 200-baud modem standardized for use in the general switched telephone network".
- [58] CCITT Recommendation V.26ter: "2 400 bits per second duplex modem using the echo cancellation technique standardized for use on the general switched telephone network and on point-to-point 2-wire leased telephone-type circuits".
- [59] CCITT Recommendation V.32: "A family of 2-wire, duplex modems operating at data signalling rates of up to 9 600 bit/s for use on the general switched telephone network and on leased telephone-type circuits".
- [60] CCITT Recommendation V.110: "Support of data terminal equipments (DTEs) with V-Series interfaces by an integrated services digital network".
- [61] CCITT Recommendation X.21: "Interface between data terminal equipment (DTE) and data circuit-terminating equipment (DCE) for synchronous operation on public data networks".
- [62] CCITT Recommendation X.25: "Interface between data terminal equipment (DTE) and data circuit-terminating equipment (DCE) for terminals operating in the packet mode and connected to public data networks by dedicated circuit".
- [63] CCITT Recommendation X.28: "DTE/DCE interface for a start-stop mode data terminal equipment accessing the packet assembly/disassembly facility (PAD) in a public data network situated in the same country".
- [64] CCITT Recommendation X.30: "Support of X.21, X.21 bis and X.20 bis based data terminal equipments (DTEs) by an integrated services digital network (ISDN)".
- [65] CCITT Recommendation X.31: "Support of packet mode terminal equipment by an ISDN".
- [66] CCITT Recommendation X.32: "Interface between data terminal equipment (DTE) and data circuit-terminating equipment (DCE) for terminals operating in the packet mode and accessing a packet switched public data network through a public switched telephone network or an integrated services digital network or a circuit switched public data network".
- [67] CCITT Recommendation X.75 (1988): "Packet-switched signalling system between public networks providing data transmission services".
- [68] CCITT Recommendation X.121: "International numbering plan for public data networks".
- [69] ETS 300 102-1: "Integrated Services Digital Network (ISDN); User-network interface layer 3 Specifications for basic call control".
- [70] ETS 300 102-2: "Integrated Services Digital Network (ISDN); User-network interface layer 3 Specifications for basic call control".

## 2 Definitions and abbreviations

Abbreviations used in this ETS are listed in GSM 01.04.

### 2.1 Random values

In a number of places in this ETS it is mentioned that some value must take a "random" value, in a given range, or more generally with some statistical distribution. Such cases interest only the Mobile Station.

It is required that there is a low probability that two MSs in the same conditions (including the case two mobile stations of the same type from the same manufacturer) will choose the same value. Moreover, it is required that, if it happens that two MSs in similar conditions choose the same value, the probability of their choices being identical at the next occasion is the same as if their first choices had been different.

The meaning of such a specification is that any statistical test for these values, done on a series of similar events, will obtain a result statistically compatible with the specified distribution. This shall hold even in the cases where the tests are conducted with a subset of possible events, with some common parameters. Moreover, basic tests of independence of the values within the series shall pass.

Data against which correlation with the values shall not be found are the protocol state, or the IMSI, or identities or other unrelated information broadcast by the network, or the current TDMA frame number.

### 2.2 Vocabulary

The following terms are used in this ETS:

- Idle mode: In this mode, the MOBILE STATION is not allocated any dedicated channel; it listens to the CCCH and the BCCH.
- RR connected mode: In this mode, the MOBILE STATION is allocated at least two dedicated channels, only one of them being a SACCH.
- Main DCCH: In RR connected mode, only two channels are used as DCCH, one being a SACCH, the other being a SDCCH or a FACCH; the SDCCH or FACCH is called here "the main DCCH".
- A channel is activated if it can be used for transmission, in particular for signalling, at least with UI frames. On the SACCH, whenever activated, it must be ensured that a contiguous stream of layer 2 frames is sent.
- A TCH is connected if circuit mode user data can be transferred. A TCH cannot be connected if it is not activated. A TCH which is activated but not connected is used only for signalling, i.e. as a DCCH.
- The data link of SAPI 0 on the main DCCH is called the main signalling link. Any message specified to be sent on the main signalling link is sent in acknowledged mode except when otherwise specified.
- The term "to establish" a link is a short form for "to establish the multiframe mode" on that data link. It is possible to send UI frames on a data link even if it is not established as soon as the corresponding channel is activated. Except when otherwise indicated, a data link layer establishment is done without an information field.

### **3 Radio Resource management procedures**

#### **3.1 Overview/General**

##### **3.1.1 General**

Radio Resource management procedures include the functions related to the management of the common transmission resources, e.g. the physical channels and the data link connections on control channels.

The general purpose of Radio Resource procedures is to establish, maintain and release RR connections that allow a point-to-point dialogue between the network and a Mobile Station. This includes the cell selection/reselection and the handover procedures. Moreover, Radio Resource management procedures include the reception of the uni-directional BCCH and CCCH when no RR connection is established. This permits automatic cell selection/reselection.

NOTE: This section includes some procedures used for the TCH/H + TCH/H configuration which need not be supported by simple Mobile Stations. These procedures and the information content relating to the TCH/H + TCH/H configuration in RR messages may need further elaboration.

##### **3.1.2 Services provided to upper layers**

###### **3.1.2.1 Idle mode**

The RR procedures include (on the mobile station side) those for automatic cell selection/reselection. The RR entity indicates to upper layers the unavailability of a BCCH/CCCH and the cell change when decided by the RR entity. Upper layers are advised of the BCCH broadcast information when a new cell has been selected, or when a relevant part of this information changes.

###### **3.1.2.2 Establishment and release of a RR connection**

A RR connection is a physical point-to-point bi-directional connection, and includes a SAPI 0 data link connection operating in multiframe mode on the main DCCH.

The upper layer can require the establishment of a RR connection. Only one RR connection can be established for a mobile station at one time.

The upper layer can require the release of a RR connection.

###### **3.1.2.3 RR connected mode**

When a RR connection is established, RR procedures provide the following services:

- establishment/release of multiframe mode on data link layer connections other than SAPI 0, on the main DCCH or on the SACCH;
- transfer of messages on any data link layer connection;
- indication of temporary unavailability of transmission (suspension, resuming);
- indication of loss of RR connection;
- automatic cell reselection and handover to maintain the RR connection;
- setting/change of the transmission mode on the physical channels, including change of type of channel, change of the coding/decoding/transcoding mode and setting of ciphering;
- allocation/release of an additional channel (for the TCH/H + TCH/H configuration).

### 3.1.3 Services required from data link and physical layers

The RR sublayer uses the services provided by the data link layer as defined in GSM 04.05.

Moreover, the RR sublayer directly uses services provided by the physical layer such as BCCH searching, as defined in GSM 04.04.

### 3.1.4 Change of dedicated channels

#### 3.1.4.1 Change of dedicated channels using SAPI = 0

In case a change of dedicated channels is required using a dedicated assignment and handover procedure, respectively, the RR sublayer will request the data link layer to suspend multiple frame operation before the mobile station leaves the old channel. When the channel change has been completed, layer 3 will request the data link layer to resume multiple frame operation again. The layer 2 suspend/resume procedures are described in GSM 04.05 and 04.06.

These procedures are specified in such a way that a loss of a layer 3 message cannot occur on the radio interface. However, MM and CM messages sent from the mobile station to the network may be duplicated by the data link layer if a message has been transmitted but not yet completely acknowledged before the mobile station leaves the old channel (see GSM 04.06).

As the RR sublayer is controlling the channel change, a duplication of RR messages does not occur. However, there are some procedures for which a duplication is possible, e.g. DTMF procedures. For all MM and CM procedures using SAPI=0, the request messages sent by the mobile station contain a sequence number in order to allow the network to detect duplicated messages, which are then ignored by the network. The procedures for sequenced transmission on layer 3 are described in section 3.1.4.2.

#### 3.1.4.2 Change of dedicated channels using other SAPIs than 0

For SAPIs other than 0, the data link procedures described in GSM 04.06 do not provide any guarantee against message loss or duplication.

Therefore, if an application uses a SAPI other than 0 and if this application is sensitive to message loss or duplication, then it has to define its own protection mechanism. No general protection mechanism is provided by the layer 3 defined in this ETS.

#### 3.1.4.3 Sequenced message transfer operation

MM and CM messages using SAPI=0 sent from the mobile station to the network can be duplicated by the data link layer in the following case:

A channel change of dedicated channels is required (assignment or handover procedure) and the last layer 2 frame has not been acknowledged by the peer data link layer before the mobile station leaves the old channel.

In this case, the mobile station does not know whether the network has received the message correctly. Therefore, the mobile station has to send the message again after the new dedicated channel is established (see GSM 04.06).

The network must be able to detect the duplicated received message. Therefore, each MM and CM message using SAPI=0 must be marked with a send sequence number.

##### 3.1.4.3.1 Variables and sequence numbers

###### 3.1.4.3.1.1 Send state variable V(SD)

The RR sublayer of the mobile station shall have one associated send state variable V(SD) ("Send Duplicated") for sending MM and CM messages using SAPI=0. The send state variable denotes the sequence number of the next in sequence numbered message to be transmitted. The value of the send state variable shall be incremented by one with each numbered message transmission. Arithmetic operations on V(SD) are performed modulo 2.

### **3.1.4.3.1.2 Send sequence number N(SD)**

Only MM and CM messages using SAPI=0 contain the send sequence number N(SD). At the time when such a message is designated for transmission, the value of N(SD) for the message to be transferred is set equal to the value of the send state variable V(SD). See GSM 04.07.

### **3.1.4.3.2 Procedures for the initiation, transfer execution and termination of the sequenced message transfer operation**

#### **3.1.4.3.2.1 Initiation**

The sequenced message transfer operation is initiated by establishing a RR connection. The send state variable V(SD) is set to 0.

#### **3.1.4.3.2.2 Transfer Execution**

The network must compare the send sequence numbers of pairs of subsequent messages. In case the send sequence numbers of two subsequent messages are not identical, no duplication has occurred. In case the send sequence numbers are identical, the network must ignore one of these messages.

#### **3.1.4.3.2.3 Termination**

The sequenced message transfer operation is terminated by the RR connection release procedure.

### 3.1.5 Procedure for Service Request and Contention Resolution

Upon seizure of the assigned dedicated channel, the mobile station establishes the main signalling link on this channel by sending a layer 2 SABM frame containing a layer 3 service request message. The data link layer will store this message to perform the contention resolution. The service request message will be returned by the network in the UA frame.

The data link layer in the mobile station compares the content of the information field (i.e. the layer 3 service request message) received in the UA frame with the stored message and leaves the channel in case they do not match. This procedure resolves contentions in the case where several Mobile Stations have accessed at the same random access slot and with the same random reference and one has succeeded due to capture. The full description of the procedure is given in GSM 04.06.

The purpose of the service request message is to indicate to the network which service the mobile station is requesting. This then allows the network to decide how to proceed (e.g. to authenticate or not).

The service request message must contain the identity of the mobile station and may include further information which can be sent without encryption.

The layer 3 service request message is typically one of the following:

- CM SERVICE REQUEST
- LOCATION UPDATING REQUEST
- IMSI DETACH
- PAGING RESPONSE
- CM REESTABLISHMENT REQUEST

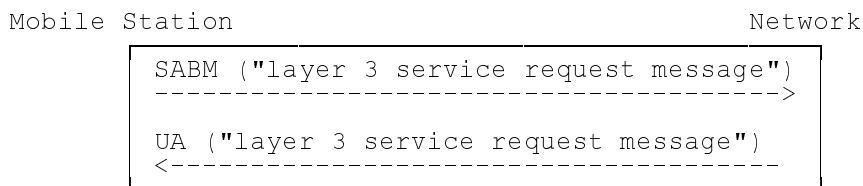

Figure 3.1/GSM 04.08: Service request and contention resolution

## 3.2 Idle mode procedures

### 3.2.1 Mobile station side

In idle mode, the mobile station listens to the BCCH and to the paging sub-channel for the paging group the mobile station belongs to (cf. GSM 03.13); it measures the radio propagation for connection with other cells.

Measurements are treated to assess the need of a cell change as specified in GSM 05.08. When the decision to change cells is made, the mobile station switches to the BCCH of the new cell. The broadcast information is then checked to verify the allowance to camp on this cell (cf. section 3.2.2). If allowed, the cell change is confirmed, and the broadcast information is then treated for Mobility Management actions (cf. section 4). Similarly, physical contexts are updated (list of neighbouring cells frequencies, thresholds for some actions, etc. cf. GSM 05.08 and section 3.2.2).

### 3.2.2 Network side

#### 3.2.2.1 System information broadcasting

SYSTEM INFORMATION TYPE 2 to 4 messages, and optionally TYPE 1, 2bis, 2ter 7 and 8 are regularly broadcast by the network on the BCCH. Based on this information the mobile station is able to decide whether and how it may gain access to the system via the current cell. The SYSTEM INFORMATION TYPE 2bis message shall be sent if and only if the EXT-IND bit in the Neighbour Cells Description IE in both the TYPE 2 and TYPE 2bis messages indicates that each IE only carries part of the BA. SYSTEM INFORMATION TYPE 2ter message shall be sent if and only if this is indicated in SYSTEM INFORMATION TYPE 3 message.

A GSM 900 mobile station which only supports the primary GSM band P-GSM 900 (cf. GSM 05.05) may consider the EXT-IND bit in the Neighbour Cells Description IE in the SYSTEM INFORMATION TYPE 2 message bit as a spare bit. If it does so it shall assume that the information element carries the complete BA and it shall ignore any SYSTEM INFORMATION TYPE 2bis messages.

If the additional cell reselection parameters are broadcasted then System Information Type 3 message shall always contain these parameters. In addition to System Information Type 3 at least either System Information Type 4 or System Information Type 7 and 8 messages shall contain these parameters too.

NOTE: The exact order of sending SYSTEM INFORMATION messages on the BCCH is specified in GSM 05.02.

Similar information is sent in SYSTEM INFORMATION TYPE 5, 6 and optionally 5bis, 5ter or both, on the SACCH just after handover, and whenever there is no other use of that channel. The SYSTEM INFORMATION TYPE 5bis message shall be sent if and only if the EXT-IND bit in the Neighbour Cells Description IE in both the TYPE 5 and TYPE 5bis messages indicates that each IE only carries part of the BA.

A GSM 900 mobile station which only supports the primary GSM band P-GSM 900 (cf. GSM 05.05) may consider the EXT-IND bit in the Neighbour Cells Description IE in the SYSTEM INFORMATION TYPE 5 message bit as a spare bit, assume that the information element carries the complete BA, and ignore any SYSTEM INFORMATION TYPE 5bis messages.

NOTE: The network should take into account limitations of certain mobile stations to understand SYSTEM INFORMATION TYPE 2bis, TYPE 2ter, TYPE 5ter and TYPE 5bis messages, the EXT-IND bit in the Neighbour Cells Description, the indication of 2ter in SYSTEM INFORMATION TYPE 3 and formats used in the Neighbour Cells Description IE and Cell Channel Description IE used in SYSTEM INFORMATION messages, see this section, section 10.5.2.1b, and section 10.5.2.22.

The information broadcast may be grouped in the following classes:

- information giving unique identification of the current network, location area and cell;
- information used for candidate cell measurements for handover and cell selection procedures;
- information describing the current control channel structure;
- information controlling the random access channel utilization;
- information defining different options supported within the cell; and
- information about the length of the part of the message belonging to the phase 1 protocol.

### 3.2.2.2 Paging

The network is required to send valid layer 3 messages continuously on all paging subchannels.

## 3.3 RR connection establishment

### 3.3.1 RR connection establishment initiated by the mobile station: immediate assignment procedure

The purpose of the immediate assignment procedure is to establish an RR connection between the mobile station and the network.

The immediate assignment procedure can only be initiated by the RR entity of the mobile station. Initiation is triggered by request from the MM sublayer to establish an RR connection or by the RR entity in response to a PAGING REQUEST message. Upon such a request:

- if access to the network is allowed (as defined in 3.3.1.1), the RR entity of the mobile station initiates the immediate assignment procedure as defined in section 3.3.1.2;
- otherwise, it rejects the request.

The request from the MM sublayer to establish an RR connection specifies an establishment cause. Similarly, the request from the RR entity to establish a RR connection in response to a PAGING REQUEST 1, 2 or 3 message specifies one of the establishment causes "answer to paging".

#### 3.3.1.1 Permission to access the network

All mobile stations with an inserted SIM are members of one out of 10 access classes numbered 0 to 9. The access class number is stored in the SIM. In addition, mobile stations may be members of one or more out of 5 special access classes (access classes 11 to 15) (see GSM 02.11), this is also held on the SIM card.

The system information messages on the BCCH broadcast the list of authorized access classes and authorized special access classes in the system information messages, and whether emergency calls are allowed in the cell to all mobile stations or only to the members of authorized special access classes.

If the establishment cause for the request of the MM sublayer is not "emergency call", access to the network is allowed if and only if the mobile station is a member of at least one authorized:

- access class; or
- special access class.

If the establishment cause for the request of the MM sublayer is "emergency call", access to the network is allowed if and only if:

- emergency calls are allowed to all mobile stations in the cell; or
- the mobile station is a member of at least one authorized special access class.

#### 3.3.1.2 Initiation of the immediate assignment procedure

The RR entity of the mobile station initiates the immediate assignment procedure by scheduling the sending on the RACH and leaving idle mode (in particular, the mobile station shall ignore PAGING REQUEST messages).

It then sends maximally  $M + 1$  CHANNEL REQUEST messages on the RACH in a way such that:

- the number of slots belonging to the mobile station's RACH between initiation of the immediate assignment procedure and the first CHANNEL REQUEST message (excluding the slot containing the message itself) is a random value drawn randomly for each new initial assignment initiation with uniform probability distribution in the set  $\{0, 1, \dots, \max(T, 8) - 1\}$ ;



- the number of slots belonging to the mobile station's RACH between two successive CHANNEL REQUEST messages (excluding the slots containing the messages themselves) is a random value drawn randomly for each new transmission with uniform probability distribution in the set  $\{S, S + 1, \dots, S + T - 1\}$ ;

Here, T is the value of the parameter "Tx-integer" broadcast on the BCCH;

M is the value of the parameter "max retrans" broadcast on the BCCH;

S is a parameter depending on the CCCH configuration and on the value of Tx-integer as defined in table 3.1/GSM 04.08.

The CHANNEL REQUEST messages are sent on the RACH (cf. section 1.5) and contain as parameters:

- an establishment cause which corresponds to the establishment cause given by the MM sublayer and the broadcast NECI value, or which corresponds to one of the establishment causes "answer to paging" given by the RR entity in response to a PAGING REQUEST message including the Channel Needed information;
- a random reference which is drawn randomly from a uniform probability distribution for every new transmission.

After sending the first CHANNEL REQUEST message, the mobile station shall start listening to the BCCH; it shall also listen to the full downlink CCCH timeslot corresponding to its CCCH group.

Having sent M + 1 CHANNEL REQUEST messages, the RR entity of the mobile station starts timer T3126. At expiry of timer T3126, the immediate assignment procedure is aborted; if the immediate assignment procedure was triggered by a request from the MM sublayer, a random access failure is indicated to the MM sublayer.

TX-integer	non combined CCCH	combined CCH/SDCCH
3, 8, 14, 50	55	41
4, 9, 16	76	52
5, 10, 20	109	58
6, 11, 25	163	86
7, 12, 32	217	115

**Table 3.1/GSM 04.08**  
**Values of parameter S**

### 3.3.1.3 Answer from the network

#### 3.3.1.3.1 On receipt of a CHANNEL REQUEST message

The network may allocate a dedicated channel to the mobile station by sending an IMMEDIATE ASSIGNMENT message or IMMEDIATE ASSIGNMENT EXTENDED message in unacknowledged mode on the same CCCH timeslot on which it has received the CHANNEL REQUEST. There is no further restriction on what part of the downlink CCCH an IMMEDIATE ASSIGNMENT message or IMMEDIATE ASSIGNMENT EXTENDED message can be sent. The type of channel allocated (SDCCH or TCH; the channel mode shall be set to signalling only) is a network operator decision. Timer T3101 is then started on the network side.

- NOTE: There are two types of immediate assignment messages:
- IMMEDIATE ASSIGNMENT message, containing assignment information for one mobile station only;
  - IMMEDIATE ASSIGNMENT EXTENDED message, containing assignment information for two mobile stations at the same time.

The IMMEDIATE ASSIGNMENT or IMMEDIATE ASSIGNMENT EXTENDED message contains:

- the description of the assigned channel;

- the information field of the CHANNEL REQUEST message and the frame number of the frame in which the CHANNEL REQUEST message was received;
- the initial timing advance (cf. GSM 04.04);
- optionally, a starting time indication.

If frequency hopping is applied, the mobile station uses the last CA received on the BCCH to decode the Mobile Allocation.

On receipt of an IMMEDIATE ASSIGNMENT or IMMEDIATE ASSIGNMENT EXTENDED message corresponding to one of its 3 last CHANNEL REQUEST messages, the mobile station stops T3126 (if running), stops sending CHANNEL REQUEST messages, switches to the assigned channels, sets the channel mode to signalling only and activates the assigned channels. It then establishes the main signalling link with an SABM containing an information field (see section 3.1.5).

An IMMEDIATE ASSIGNMENT or IMMEDIATE ASSIGNMENT EXTENDED message may indicate a frequency change in progress, with a starting time and possibly alternative channel descriptions.

In the case of the reception of an IMMEDIATE ASSIGNMENT EXTENDED message, or of an IMMEDIATE ASSIGNMENT message which contains only the description of a channel to be used after the starting time, the mobile station shall wait up to the starting time before accessing the channel. If the starting time has already elapsed, the mobile shall access the channel as an immediate reaction to the reception of the message (see GSM 05.10 for the timing constraints).

If the message contains both the description of a channel to be used after the indicated time and of a channel to be used before, the mobile station accesses a channel as an immediate reaction to the reception of the message. If the moment the mobile station is ready to access is before the indicated time, the mobile station accesses the channels described for before the starting time. The mobile station then changes to the channel described for after the starting time at the indicated time. New parameters can be frequency list and MAIO. Other parameters describing the channel to be used before the starting time are taken from the description of the channel defined for use after the starting time. If the moment the mobile station is ready to access is after the starting time, the mobile station accesses the channel described for after the starting time.

If frequency hopping is applied, the Mobile Station uses the last CA received on the BCCH.

### 3.3.1.3.2 Assignment rejection

If no channel is available for assignment, the network may send to the mobile station an IMMEDIATE ASSIGNMENT REJECT message in unacknowledged mode on the same CCCH timeslot on which the channel request message was received. There is no further restriction on what part of the downlink CCCH timeslot an IMMEDIATE ASSIGNMENT REJECT message can be sent. This message contains the request reference and a wait indication.

On receipt of an IMMEDIATE ASSIGNMENT REJECT message corresponding to one of its 3 last CHANNEL REQUEST messages, the mobile station, stops sending CHANNEL REQUEST messages, starts timer T3122 with the indicated value, ("wait indication" information element), starts T3126 if it has not already been started, and listens to the downlink CCCH until T3126 expires. During this time, additional IMMEDIATE ASSIGNMENT REJECT messages are ignored, but any immediate assignment corresponding to any other of its 3 last CHANNEL REQUEST messages make the mobile station follow the procedure in section 3.3.1.2. If no such immediate assignment is received, the mobile station returns to CCCH idle mode (listening to its paging channel). The mobile station is not allowed to make a new attempt to establish a non emergency RR connection in the same cell until T3122 expires. Provided that an IMMEDIATE ASSIGNMENT REJECT message has not been received for an emergency RR connection attempt, the mobile station may attempt to establish an RR connection for an emergency call in the same cell before T3122 has expired.

The Wait Indication IE (i.e. T3122) relates to the cell from which it was received.

After T3122 expiry, no CHANNEL REQUEST message shall be sent as a response to a page until a PAGING REQUEST message for the mobile station is received.

### 3.3.1.4 Assignment completion

The immediate assignment procedure is terminated on the network side when the main signalling link is established. Timer T3101 is stopped and the MM sublayer on the network side is informed that an RR connection exists.

On the mobile station side, the procedure is terminated when the establishment of the main signalling link is confirmed. The MM sublayer is informed that an RR connection exists.

Early classmark sending consists in the Mobile Station sending as early as possible after access a CLASSMARK CHANGE message to provide the network with additional classmark information.

A Mobile Station which implements the « Controlled Early Classmark Sending » option shall perform the early classmark sending if and only if explicitly accepted by the network, as indicated in the last reception in the accessed cell of the SYSTEM INFORMATION TYPE 3 message.

A Mobile Station which implements one of the « multiple band support » option shall also implement the « Controlled Early Classmark Sending » option.

A Mobile Station which implements the « Controlled Early Classmark Sending » option shall indicate it in the classmark (ES IND bit).

### 3.3.1.5 Abnormal cases

If a lower layer failure occurs on the mobile station side on the new channel before the successful establishment of the main signalling link, the allocated channels are released; the subsequent behaviour of the mobile station depends on the type of failure and previous actions.

- If the failure is due to information field mismatch in the contention resolution procedure, see section 3.1.5, and no repetition as described in this section has been performed, the immediate assignment procedure shall be repeated.
- If the failure is due to any other reason or if a repetition triggered by a contention resolution failure has been performed. The mobile station returns to idle mode (RR connection establishment failure), transactions in progress are aborted and cell reselection then may take place.

If the information available in the mobile station, after the reception of an IMMEDIATE ASSIGNMENT message does not satisfactorily define a channel, an RR connection establishment failure has occurred.

If the Mobile Allocation IE indexes frequencies in more than one frequency band then a RR connection establishment failure has occurred.

If an IMMEDIATE ASSIGNMENT message indicates (a) channel(s) in a different frequency band to which the CHANNEL REQUEST message was sent then, if the frequency band is supported by the mobile station, the mobile station shall access the indicated channel(s) with the same power control level as used for the CHANNEL REQUEST message.

If an IMMEDIATE ASSIGNMENT message indicates a channel in non-supported frequency band then a RR connection establishment failure has occurred.

On the network side, if timer T3101 elapses before the main signalling link is established, the newly allocated channels are released and the request is forgotten. Note that the network has no means to distinguish repeated attempts from initial attempts from a mobile station.

### 3.3.2 Paging procedure

The network can initiate the establishment of an RR connection by the paging procedure. Such a procedure can only be initiated by the network.

#### 3.3.2.1 Paging initiation by the network

The network initiates the paging procedure by broadcasting a paging request message on the appropriate paging subchannel, and starts timer T3113. The paging subchannel is specified in GSM 05.02 and GSM 03.13.

- NOTE: There are 3 types of paging messages:
- PAGING REQUEST TYPE 1;
  - PAGING REQUEST TYPE 2; and
  - PAGING REQUEST TYPE 3.

A PAGING REQUEST message includes for each paged mobile station an indication which defines how mobiles of different capabilities shall code the establishment cause field in the CHANNEL REQUEST message. The information received in the CHANNEL REQUEST can be used by the network to assign a suitable channel.

A PAGING REQUEST message may include more than one mobile station identification.

The choice of the message type depends on the number of mobile stations to be paged and of the types on identities that are used. The maximum number of paged mobile stations per message is 4 when using only TMSIs for identification of the mobile stations.

The mobile station is required to receive and analyse the paging messages and immediate assignment messages sent on the paging subchannel corresponding to its paging subgroup, as specified in GSM 05.02.

The paging and immediate assignment type messages contain a page mode information element. This information element controls possible additional requirements on mobile stations belonging to the paging subgroup corresponding to the paging subchannel the message was sent on. This implies that a given mobile station shall take into account the page mode information element of any message sent on its own paging subchannel whatever the nature of this message (paging messages or immediate assignment messages). This further implies that the mobile station does not take into account page mode information element of messages sent on paging subchannels other than its own paging subchannel. The requirements yielded by the page mode information element are as follows:

- a) normal paging: no additional requirements;
- b) extended paging: the mobile station is required in addition to receive and analyse the next but one paging message on the PCH;
- c) paging reorganization: The mobile station shall receive all messages on the CCCH regardless of the BS-AG-BLKS-RES setting. It is required to receive all BCCH messages. When the mobile station receives the next message to its (possibly new) paging subgroup the subsequent action is defined in the page mode information element in that message;
- d) same as before: No change of page mode from the previous page mode.

Note that a mobile station takes into account the page mode information only in messages of its own paging subchannel whatever the currently applied requirements (a, b, c or d).

When the mobile station selects a new PCH, the initial page mode in the mobile station shall be set to paging reorganization. If a message in the paging subchannel is not received correctly, the message is ignored and the previous page mode is assumed.

### 3.3.2.2 Paging response

Upon receipt of a paging request message and if access to the network is allowed, the addressed mobile station shall, when camped on a cell, initiate the immediate assignment procedure as specified in 3.3.1. The establishment of the main signalling link is then initiated by use of an SABM with information field containing the PAGING RESPONSE message (see section 3.1.5). The MM sublayer in the mobile station is informed that an RR connection exists.

Upon receipt of the PAGING RESPONSE message the network stops timer T3113. The MM sublayer in the network is informed that an RR connection exists.

### 3.3.2.3 Abnormal cases

Lower layer failure occurring during the immediate assignment procedure is treated as specified for that procedure.

If timer T3113 expires and a PAGING RESPONSE message has not been received, the network may repeat the paging request message and start timer T3113 again. The number of successive paging attempts is a network dependant choice.

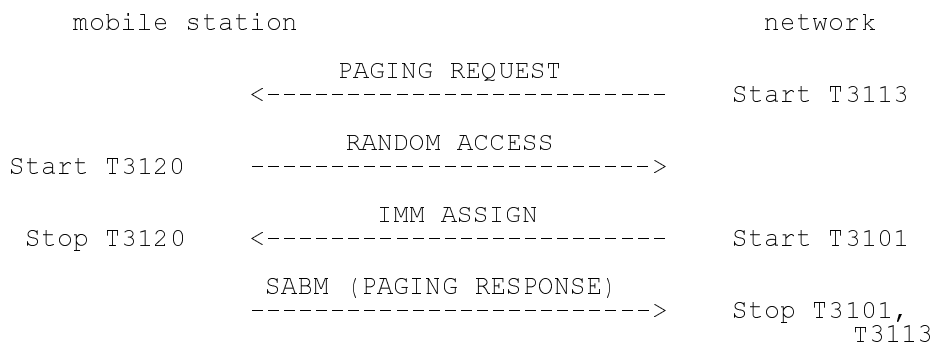

**Figure 3.2/GSM 04.08: Paging sequence**

### **3.4 RR connection transfer phase**

#### **3.4.1 SACCH procedures**

##### **3.4.1.1 General**

In RR connected mode, the SACCH is used in signalling layer at least for measurement results transmission from the mobile station.

The SACCH has the particularity that continuous transmission must occur in both directions. For that purpose, in the mobile station to network direction, measurement result messages are sent at each possible occasion when nothing else has to be sent (see section 3.4.1.2). Similarly, SYSTEM INFORMATION TYPE 5, 6 and optionally 5bis messages are sent in the network to mobile station direction in UI frames when nothing else has to be sent.

As specified in GSM 05.08, problems occurring in the reception of SACCH frames are interpreted as a loss of communication means and appropriate procedures are then triggered as specified in section 3.5.2.

##### **3.4.1.2 Measurement report**

When in RR connected mode, the mobile station regularly sends MEASUREMENT REPORT messages to the network. These messages contain measurements results about reception characteristics from the current cell and from neighbour cells. The BA (list) which is the basis for the measurements is derived from information received on the BCCH in System Information 2 and optionally 2bis and/or 2ter and on the SACCH in System Information 5 and optionally 5bis and/or 5ter. When the information is received in more than one message the mobile station shall only combine information from messages received on the same channel and indicating the same value of the BCCH allocation sequence number without any message indicating a different value of the BCCH allocation sequence number received in between. If neighbouring cell information for the serving cell is not available, the mobile station indicates this in the MEASUREMENT REPORT message. These measurement results are obtained as specified in GSM 05.08.

These messages are sent on the slow ACCH, in unacknowledged mode.

If no other message is scheduled on the SACCH at the instant when a layer 2 frame is due to be sent, then the mobile station shall send a MEASUREMENT REPORT message in that frame. The interval between two successive layer 2 frames containing MEASUREMENT REPORT messages shall not exceed one layer 2 frame.

##### **3.4.2 Transfer of messages and link layer service provision**

When a RR connection is established, upper layers can send messages in multiframe or unacknowledged mode on SAPI 0.

Moreover, upper layers have access to the full link layer services for SAPIs other than 0, with the exception of the error indication and local end release that are directly treated by the RR sublayer, as specified in particular places of section 3.

##### **3.4.3 Channel assignment procedure**

An intracell change of channel can be requested by upper layers for changing the channel type, or decided by the RR sublayer, e.g. for an internal handover. This change may be performed through the dedicated channel assignment procedure.

The purpose of the channel assignment procedure is to completely modify the physical channel configuration of the mobile station without frequency redefinition or change in synchronization while staying in the same cell.

This procedure shall not be used for changing between dependent configurations, i.e. those sharing Radio Resource. An example of dependent channels is a full rate channel and one of the corresponding half rate channels. The only procedures provided for changing between dependent configurations are the additional assignment and the partial release procedures.

The channel assignment procedure happens only in RR connected mode. This procedure cannot be used in the idle mode; in this case the immediate assignment procedure is used.

The channel assignment procedure includes:

- the suspension of normal operation except for RR management (layer 3);
- the release of the main signalling link, and of the other data links as defined in section 3.1.4, and the disconnection of TCHs if any;
- the deactivation of previously assigned channels (layer 1);
- the activation of the new channels and their connection if applicable;
- The triggering of the establishment of the data link connections for SAPI = 0.

The channel assignment procedure is always initiated by the network.

#### **3.4.3.1 Channel assignment initiation**

The network initiates the channel assignment procedure by sending an ASSIGNMENT COMMAND message to the mobile station on the main signalling link. It then starts timer T3107.

NOTE: The network should take into account limitations of certain mobile stations to understand formats used in the Frequency List IE and Cell Channel Description IE used in the ASSIGNMENT COMMAND message, see section 10.5.2.13 and section 10.5.2.1b.

When sending this message on the network side, and when receiving it on the mobile station side, all transmission of signalling layer messages except for those RR messages needed for this procedure and for abnormal cases is suspended until resumption is indicated. These RR messages can be deduced from sections 3.4.3 and 8.8 Radio Resource management.

Upon receipt of the ASSIGNMENT COMMAND message, the mobile station initiates a local end release of link layer connections, disconnects the physical channels, commands the switching to the assigned channels and initiates the establishment of lower layer connections (this includes the activation of the channels, their connection and the establishment of the main signalling links).

The ASSIGNMENT COMMAND message contains the description of the new configuration, including for the TCH/H + TCH/H + ACCHs configuration, the exact ACCHs to be used and a power command. The power level defined in this power command shall be used by the mobile station for the initial power on the new channel(s). It shall not affect the power used on the old channel(s).

An ASSIGNMENT COMMAND message may indicate a frequency change in progress, with a starting time and possibly alternative channel descriptions.

In the case of the reception of an ASSIGNMENT COMMAND message which contains only the description of a channel to be used after the starting time, the mobile station shall wait up to the starting time before accessing the channel. If the starting time has already elapsed, the mobile shall access the channel as an immediate reaction to the reception of the message (see GSM 05.10 for the timing constraints).

If the message contains both the description of a channel to be used after the indicated time and of a channel to be used before, the mobile station accesses a channel as an immediate reaction to the reception of the message. If the moment the mobile station is ready to access is before the indicated time, the mobile station accesses the channels described for before the starting time. The mobile station then changes to the channel described for after the starting time at the indicated time. New parameters can be frequency list, MAIO and HSN. Other parameters describing the allocated channels must be identical to the parameters described for before the starting time. If the moment the mobile station is ready to access is after the starting time, the mobile station accesses the channel described for after the starting time.

If frequency hopping is applied, the cell allocation if present in the message is used to decode the mobile allocation. If the cell allocation is not included, the mobile station uses its current cell allocation, the current CA is the last CA received on the BCCH. Afterward, the current CA may be changed by some messages sent on the main signalling link containing a CA (the possible messages are: ASSIGNMENT COMMAND, HANDOVER COMMAND and FREQUENCY REDEFINITION). Note that there are cases in which the current CA is undefined (see section 3.4.3.3).

The ASSIGNMENT COMMAND message may contain a cipher mode setting IE. In that case, this mode has to be applied on the new channel. If no such information is present, the ciphering mode is the same as on the previous channel. In either case the ciphering key shall not be changed. The ASSIGNMENT COMMAND message shall not contain a cipher mode setting IE that indicates "start ciphering" unless a CIPHERING MODE COMMAND message has been transmitted earlier in the RR connection: if such an ASSIGNMENT COMMAND message is received it shall be regarded as erroneous, an ASSIGNMENT FAILURE with cause "Protocol error unspecified" message shall be returned immediately, and no further action taken.



### 3.4.3.2 Assignment completion

After the main signalling link is successfully established, the mobile station returns an ASSIGNMENT COMPLETE message, specifying cause "normal event", to the network on the main DCCH.

The sending of this message on the mobile station side and its receipt on the network side allow the resumption of the transmission of signalling layer messages other than those belonging to RR management.

At the receipt of the ASSIGNMENT COMPLETE message, the network releases the previously allocated resources and stops timer T3107.

### 3.4.3.3 Abnormal cases

If the mobile station has no current CA and if it needs a CA to analyse the ASSIGNMENT COMMAND message, it stays on the current channel(s) and sends an ASSIGNMENT FAILURE message with cause "no cell allocation available".

If the ASSIGNMENT COMMAND message instructs the mobile station to use a Channel Description or Mode that it does not support, then the mobile station shall return an ASSIGNMENT FAILURE message with cause "channel mode unacceptable", and the mobile station shall remain on the current channel(s) and uses the old Channel Description or Channel Mode.

If the ASSIGNMENT COMMAND message instructs the mobile station to use a frequency that it is not capable of, then the mobile station shall return an ASSIGNMENT FAILURE message with cause "frequency not implemented", and the mobile station shall remain on the current channel(s).

If the mobile station receives an ASSIGNMENT COMMAND message with a Frequency List IE indicating frequencies that are not all in one band, then the mobile station shall stay on the current channel(s) and send an ASSIGNMENT FAILURE message with cause "frequency not implemented". If the mobile station receives an ASSIGNMENT COMMAND message with a Mobile Allocation IE indexing frequencies that are not all in one band, then the mobile station shall stay on the current channel(s) and send an ASSIGNMENT FAILURE message with cause "frequency not implemented".

**NOTE:** An ASSIGNMENT COMMAND message sent to a multi band mobile station shall not be considered invalid because it indicates frequencies that are all in a different frequency band to that of the current channel.

On the mobile station side, if a lower layer failure happens on the new channel before the ASSIGNMENT COMPLETE message has been sent, the mobile station deactivates the new channels, reactivates the old channels, reconnects the TCHs if any and triggers the establishment of the main signalling link. It then sends a ASSIGNMENT FAILURE message, cause "protocol error unspecified" on the main DCCH and resumes the normal operation, as if no assignment attempt had occurred. The operational parameters (e.g. ciphering mode) when returning on the old channel are those applied before the procedure.

When receiving the ASSIGNMENT FAILURE message, the network stops T3107.

If a lower layer failure happens while attempting to connect back to the old channels, the radio link failure procedure is applied (see section 3.5.2).

On the network side, if timer T3107 elapses before either the ASSIGNMENT COMPLETE message has been received on the new channels, an ASSIGNMENT FAILURE message is received on the old channels or the mobile station has re-established the call, the old channels and the new channels are released and all contexts related to the connections with that mobile station are cleared.

On the network side, lower layer failure occurring on the old channels after the sending of the ASSIGNMENT COMMAND message are ignored. Lower layer failures occurring after the receipt of the SABM Frame on the new main signalling link are treated following the general rules (cf. section 3.5.2).

### 3.4.4 Handover procedure

An intercell or intracell change of channel can be requested by the network RR sublayer. This change may be performed through the handover procedure.

NOTE: The decision to do a handover and the choice of the new cell is out of the scope of this technical specification.

The purpose of the handover procedure is to completely modify the channels allocated to the mobile station e.g. when the cell is changed. A change in the channel configuration nature is possible. This procedure is used only while in a RR connected mode.

The handover procedure shall not be used for changing between dependent configurations (see section 3.4.3).

The handover procedure includes:

- The suspension of normal operation except for RR management (layer 3).
- The disconnection of the main signalling link, and of the other links via local end release (layer 2), and the disconnection of the TCH(s) if any.
- The disconnection and the deactivation of previously assigned channels and their release (layer 1).
- The activation of the new channels, and their connection if applicable.
- The triggering of the establishment of data link connection for SAPI = 0 on the new channels.

The handover procedure is always initiated by the network.

#### 3.4.4.1 Handover initiation

The network initiates the handover procedure by sending a HANOVER COMMAND message to the mobile station on the main DCCH. It then starts timer T3103.

NOTE: The network should take into account limitations of certain mobile stations to understand formats used in the Frequency List IE, Frequency Short List IE, and Cell Channel Description IE used in the HANOVER COMMAND message, see section 10.5.2.13, section 10.5.2.14, and section 10.5.2.1b.

When sending this message on the network side, and when receiving it on the mobile station side, all transmission of signalling layer messages except for those RR messages needed for this procedure and for abnormal cases, is suspended until resuming is indicated. These RR messages can be deduced from sections 3.4.3 and 8.5.1 "Radio Resource management".

Upon receipt of the HANOVER COMMAND message, the mobile station initiates, as described in section 3.1.4, the release of link layer connections, disconnects the physical channels, commands the switching to the assigned channels and initiates the establishment of lower layer connections (this includes the activation of the channels, their connection and the establishment of the data links).

The HANOVER COMMAND message contains:

- The characteristics of the new channels, including for the TCH/H + TCH/H + ACCHs configuration the exact ACCHs to be used.
- The characteristics of the new cell that are necessary to successfully communicate (e.g. frequency list in the case of slow frequency hopping), including the data that allows the mobile station to use the pre-knowledge about synchronization it acquires by the measurement process (i.e. BSIC + BCCH frequency).

- A power command (cf. GSM 05.08). The power level defined in this power command shall be used by the mobile station for the initial power on the new channel(s). It shall not affect the power used on the old channel(s).
- An indication of the physical channel establishment procedure to be used.
- A handover reference, used as specified in the following section. The choice of the handover reference by the network is out of the scope of this specification and left to the manufacturers.
- Optionally a timing advance to be used on the new cell.
- Optionally a cipher mode setting. In that case, this mode has to be applied on the new channel. If no such information is present, the ciphering mode is the same as on the previous channel. In either case the ciphering key shall not be changed. The HANOVER COMMAND message shall not contain a cipher mode setting IE that indicates "start ciphering" unless a CIPHERING MODE COMMAND message has been transmitted earlier in the RR connection: if such a HANOVER COMMAND message is received it shall be regarded as erroneous, a HANOVER FAILURE message with cause "Protocol error unspecified" shall be returned immediately, and no further action taken.

In addition, a HANOVER COMMAND message may indicate a frequency change in progress, with a starting time and possibly alternative channel descriptions.

In the case of the reception of a HANOVER COMMAND message which contains only the description of a channel to be used after the starting time, the mobile station shall wait up to the starting time before accessing the channel. If the starting time has already elapsed, the mobile shall access the channel as an immediate reaction to the reception of the message (see GSM 05.10 for the timing constraints).

If the message contains both the description of a channel to be used after the indicated time and of a channel to be used before, the mobile station accesses a channel as an immediate reaction to the reception of the message. If the moment the mobile station is ready to access is before the indicated time, the mobile station accesses the channels described for before the starting time. The mobile station then changes to the channel described for after the starting time at the indicated time. New parameters can be frequency list, MAIO and HSN. Other parameters describing the allocated channels must be identical to the parameters described for before the starting time. If the moment the mobile station is ready to access is after the starting time, the mobile station accesses the channel described for after the starting time.

#### **3.4.4.2 Physical channel establishment**

Four procedures are defined. The support of three of them is mandatory in the mobile station. The pseudo-synchronization case is optional in the mobile station. A pseudo-synchronized handover can be commanded only to a mobile station that can support it, as indicated in the classmark.

##### **3.4.4.2.1 Finely synchronized cell case**

If the mobile station knows that the timing advance with the new cell is not out of range, i.e. smaller than or equal to the maximum timing advance that can be coded as specified in GSM 04.04, or if the new cell does accept out of range timing advance as indicated in the HANOVER COMMAND message, the mobile station proceeds as follows.

After having switched to the assigned channels, the Mobile Station sends four times the HANOVER ACCESS message in four successive layer 1 frames on the main DCCH. This message is sent in an access burst. Its content is reduced to the handover reference information element. The transmission of these four messages is optional if so indicated by the network in the HANOVER COMMAND message.

It then activates the channels in sending and receiving mode and connects the channels if need be.

If applicable, ciphering is immediately started. The access bursts are not ciphered.

#### 3.4.4.2.2 Non synchronized cell case

After having switched to the assigned channels, the mobile station starts repeating the HANDOVER ACCESS message in successive layer 1 frames on the main DCCH. This message is sent in an access burst. Its content is reduced to the handover reference information element. The mobile station starts timer T3124 at the start point of the timeslot in which the HANDOVER ACCESS message is sent the first time.

The mobile station then activates the channels in receiving mode and connects the channels if need be (only for reception).

If applicable, deciphering is then immediately started. The access bursts are not ciphered.

When the network has the RF characteristics that are necessary, it sends in unacknowledged mode a PHYSICAL INFORMATION message to the mobile station on the main DCCH. If applicable, ciphering and deciphering is immediately started (i.e., before even the reception of a correct access burst), and the message is sent enciphered.

The PHYSICAL INFORMATION message contains various physical layer related information, allowing a proper transmission by the mobile station.

When sending the PHYSICAL INFORMATION message, the network starts timer T3105. If this timer times out before the reception of a correctly decoded layer 2 frame in format A or B (see GSM 04.06), or a correctly decoded TCH frame from the mobile station, the network repeats the PHYSICAL INFORMATION message and restarts timer T3105. The maximum number of repetitions is  $N_{y1}$ .

The correct decoding of a frame means that the decoding algorithm and the error detection tests, if any, indicate no error.

When the mobile station receives a PHYSICAL INFORMATION message, it stops timer T3124, stops sending access bursts, activates the physical channels in sending and receiving mode and connects the channels if need be. If the allocated channel is an SDCCH (+ SACCH), performance of the mobile station must enable the mobile station to accept a correct PHYSICAL INFORMATION message sent by the network in any block while T3124 is running.

#### 3.4.4.2.3 Pseudo-synchronized cell case

The details of the use of this procedure are described in GSM 05.10. The mobile station computes the timing advance to be used with the new cell from the real time difference value given in the HANDOVER COMMAND message. If the mobile station knows that the timing advance with the new cell is not out of range, i.e. smaller or equal to the maximum timing advance that can be coded as specified in GSM 04.04, or if the new cell accepts an out of range timing advance as indicated in the HANDOVER COMMAND message, the mobile station switches to the new channel and proceeds as follows.

After having switched to the assigned channels, the mobile station sends in four successive slots on the main DCCH a HANDOVER ACCESS message. This message is sent in random mode and thus does not follow the basic format. Its content is reduced to the handover reference information element. The transmission of these four messages is optional if so indicated by the network in the HANDOVER COMMAND message.

The mobile station then activates the channels in sending and receiving mode and connects the channels if need be. The mobile station may activate the channels in receiving mode and connect the channels while sending access bursts.

If applicable, ciphering is then immediately started. The access bursts are not ciphered.

#### 3.4.4.2.4 Pre-synchronized cell case

The details of the use of this procedure are described in GSM 05.10. The mobile station switches to the new channel and proceeds as follows.

After having switched to the assigned channels, the mobile station sends in four successive slots on the main DCCH a HANOVER ACCESS message. This message is sent in an access burst and thus does not follow the basic format. Its content is reduced to the handover reference information element. The transmission of these four messages is optional if so indicated by the network in the HANOVER COMMAND message.

The mobile station then activates the channel in sending and receiving mode and connects the channels if need be. The timing advance value to be used with the new cell is:

- either the value contained in the HANOVER COMMAND message if the timing advance information element is present;
- or the default value for pre-synchronized handover as defined in GSM 05.10, if the timing advance information element is not included in the HANOVER COMMAND message. The mobile station may activate the channels in receiving mode and connect the channels while sending access bursts.

If applicable, ciphering is immediately started. The access bursts are not ciphered.

#### **3.4.4.3 Handover completion**

After lower layer connections are successfully established, the mobile station returns a HANOVER COMPLETE message, specifying cause "normal event", to the network on the main DCCH.

The sending of this message on the mobile station side and its receipt on the network side allow the resumption of the transmission of signalling layer messages other than those for RR management.

When receiving the HANOVER COMPLETE message, the network stops timer T3103 and releases the old channels.

If requested to do so in the HANOVER COMMAND message, the mobile station includes the observed time difference it has measured when performing the handover, corrected by half the timing advance, in the HANOVER COMPLETE message (detailed specifications are given in GSM 05.10).

#### **3.4.4.4 Abnormal cases**

In the case of a synchronous or pseudo-synchronous handover, if the mobile station knows that the timing advance with the new cell is out of range, i.e. is bigger than the maximum timing advance that can be coded as specified in GSM 04.04, and if the new cell does not accept out of range timing advance as indicated in the HANOVER COMMAND message, the mobile station sends a HANOVER FAILURE message, cause "handover impossible, timing advance out of range", on the main signalling link and does not attempt that handover.

If the HANOVER COMMAND message instructs the mobile station to use a Channel Description or Mode that it does not support, then the mobile station shall return a HANOVER FAILURE message with cause "channel mode unacceptable", and the mobile station shall remain on the current channel(s) and uses the old Channel Description or Mode.

If the HANOVER COMMAND message instructs the mobile station to use a frequency that it is not capable of, then the mobile station shall return a HANOVER FAILURE message with cause "frequency not implemented", and the mobile station shall remain on the current channel(s).

If the mobile station receives a HANOVER COMMAND message with a Frequency List IE or Frequency Short List IE indicating frequencies that are not all in one band, then the mobile station shall stay on the current channel(s) and send a HANOVER FAILURE message with cause "frequency not implemented". If the mobile station receives a HANOVER COMMAND message with a Mobile Allocation IE indexing frequencies that are not all in one band, then the mobile station shall stay on the current channel(s) and send a HANOVER FAILURE message with cause "frequency not implemented".

NOTE: A HANOVER COMMAND message sent to a multi band mobile station shall not be considered invalid because it indicates target channel frequencies that are all in a different frequency band to that of the ARFCN in the Cell Description IE.

On the mobile station side, if timer T3124 times out (only in the non-synchronized case) or if a lower layer failure happens on the new channel before the HANOVER COMPLETE message has been sent, the mobile station deactivates the new channels, reactivates the old channels, reconnects the TCHs if any and triggers the establishment of the main signalling link. It then sends a HANOVER FAILURE message on the main signalling link and resumes normal operation as if no handover attempt had occurred. The operational parameters (e.g. ciphering mode) when returning on the old channel are those applied before the HANOVER COMMAND message was received.

When the HANOVER FAILURE message has been received, the network releases the new channels and stops timers T3105 and stops T3103 in the non-synchronized case.

If a lower layer failure happens while attempting to connect back to the old channels, the standard rules are applied (cf. section 3.5.2).

On the network side, if timer T3103 elapses before either the HANOVER COMPLETE message is received on the new channels, or a HANOVER FAILURE message is received on the old channels, or the mobile station has re-established the call, the old channels are released and all contexts related to the connections with that mobile station are cleared.

On the network side, if neither a correctly layer 2 frame in format A or B nor a correctly TCH frame have been received from the mobile station on the new channel, the newly allocated channels are released.

On the network side, lower layer failures occurring on the old channels after the sending of the HANOVER COMMAND message are ignored. Lower layer failures occurring after the receipt of the SABM frame on the new main signalling link are treated following a general scheme (cf. section 3.5.2).

### 3.4.5 Frequency redefinition procedure

This procedure is used by the network to change the frequencies and hopping sequences of the allocated channels. This is meaningful only in the case of frequency hopping.

The network sends to the mobile station a FREQUENCY REDEFINITION message containing the new parameters together with a starting time indication.

NOTE: The network should take into account limitations of certain mobile stations to understand formats used in the Cell Channel Description IE used in the FREQUENCY REDEFINITION message (see section 10.5.2.13).

When receiving such a message, the mobile station modifies the frequencies/hopping sequences it uses at the exact indicated time slot, i.e. the indicated time slot is the first with new parameters. All other functions are not disturbed by this change. New parameters can be the cell channel description, the mobile allocation and the MAIO. Other parameters describing the allocated channels must be identical to the current parameters.

#### 3.4.5.1 Abnormal cases

If the mobile station receives a FREQUENCY REDEFINITION message with a Mobile Allocation IE indexing frequencies that are not all in one band and a Starting Time IE indicating a time that has not elapsed, then the mobile station shall stay on the current channel(s) and send a RR STATUS message with cause "frequency not implemented".

If the mobile station receives a FREQUENCY REDEFINITION message with a Mobile Allocation IE indexing frequencies that are not all in one band and a Starting Time IE indicating a time that has elapsed, then the mobile station shall locally abort the radio connection and, if permitted, attempt Call Re-establishment.

NOTE: A FREQUENCY REDEFINITION message sent to a multi band mobile station shall not be considered invalid because it indicates new frequencies that are all in a different frequency band to that of the ARFCN of the serving cell.

### **3.4.6 Channel mode modify procedure**

Higher layers can request the setting of the channel mode.

The channel mode modify procedure allows the network to request the mobile station to set the channel mode for one channel. The channel mode covers the coding, decoding and transcoding mode used on the indicated channel.

This procedure is always initiated by the network.

#### **3.4.6.1 Initiation of the channel mode modify procedure**

The network initiates the procedure by sending a CHANNEL MODE MODIFY message to the mobile station. This message contains:

- a channel description of the channel on which the CHANNEL MODE MODIFY message is sent; and
- the mode to be used on the channel.

#### **3.4.6.2 Completion of channel mode modify procedure**

When it has received the CHANNEL MODE MODIFY message, the mobile station sets the mode for the indicated channel and then replies by a CHANNEL MODE MODIFY ACKNOWLEDGE message indicating the ordered channel mode.

This applies whether the mode commanded by the CHANNEL MODE MODIFY is different from the one used by the MS or whether it is already in use.

#### **3.4.6.3 Abnormal cases**

No specific action for a lower layer failure is specified in this section. If the mobile station does not support the indicated mode, it shall retain the old mode and return the associated channel mode information in the CHANNEL MODE MODIFY ACKNOWLEDGE message.

### **3.4.7 Ciphering mode setting procedure**

The ciphering mode setting procedure is used by the network to set the ciphering mode, i.e. whether or not the transmission is ciphered, and if so which algorithm to use. The procedure shall only be used to change from "not ciphered" mode to "ciphered" mode, or vice-versa, or to pass a CIPHERING MODE COMMAND message to the mobile station while remaining in the "not ciphered" mode. The ciphering mode setting procedure is always triggered by the network and it only applies to dedicated resources.

#### **3.4.7.1 Ciphering mode setting initiation**

The network initiates the ciphering mode setting procedure by sending a CIPHERING MODE COMMAND message to the mobile station on the main signalling link, indicating whether ciphering shall be used or not, and if yes which algorithm to use.

Additionally, the network may, by the use of the cipher response information element, request the mobile station to include its IMEISV in the CIPHERING MODE COMPLETE message.

The new mode is applied for reception on the network side after the message has been sent.

### 3.4.7.2 CIPHERING mode setting completion

Whenever the mobile station receives a valid CIPHERING MODE COMMAND message, it shall load the ciphering key stored on the SIM into the ME. A valid CIPHERING MODE COMMAND message is defined to be one of the following:

- one that indicates "start ciphering" and is received by the mobile station in the "not ciphered" mode;
- one that indicates "no ciphering" and is received by the mobile station in the "not ciphered" mode; and
- one that indicates "no ciphering" and is received by the mobile station in the "ciphered" mode.

Other CIPHERING MODE COMMAND messages shall be regarded as erroneous, an RR STATUS message with cause "Protocol error unspecified" shall be returned, and no further action taken.

Upon receipt of the CIPHERING MODE COMMAND message indicating ciphering, the mobile station shall start transmission and reception in the indicated mode.

When the appropriate action on the CIPHERING MODE COMMAND has been taken, the mobile station sends back a CIPHERING MODE COMPLETE message. If the "cipher response" field of the cipher response information element in the CIPHERING MODE COMMAND message specified "IMEI must be included" the mobile station shall include its IMEISV in the CIPHERING MODE COMPLETE message.

Upon receipt of the CIPHERING MODE COMPLETE message or any other correct layer 2 frame which was sent in the new mode, the network starts transmission in the new mode.

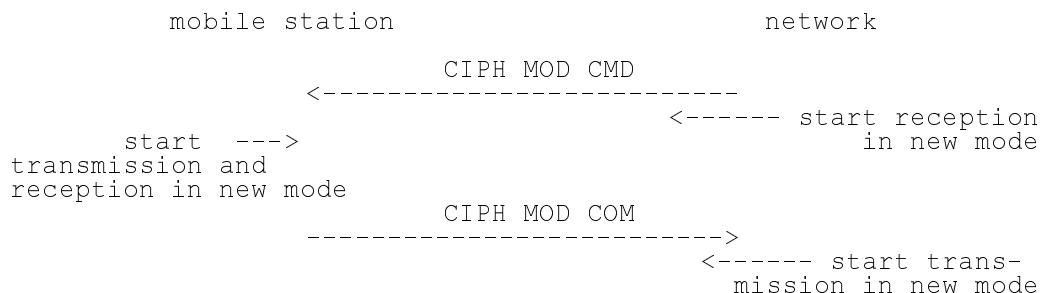

**Figure 3.3/GSM 04.08:**  
**Ciphering mode setting sequence**

### 3.4.8 Additional channel assignment procedure

NOTE: In the present state of GSM 04.03, this procedure is only possible for the TCH/H + ACCHs to TCH/H + TCH/H + ACCHs transition. As a consequence it is not needed for simple mobile stations. The description of the procedure is in general terms to cope with possible evolution.

A change of channel configuration to include an additional channel can be requested by upper layers.

The purpose of the additional assignment procedure is to allocate an additional dedicated channel to a mobile station while keeping the previously allocated channels. In particular the main DCCH and the SACCH are not modified, and signalling exchanges are not interrupted.

The additional assignment procedure may happen only in RR connected mode. It is used for instance for the transition from the TCH/H + ACCHs configuration to the TCH/H + TCH/H + ACCHs configuration.

The additional assignment procedure is always initiated by the network.



### **3.4.8.1 Additional assignment procedure initiation**

The network initiates the procedure by sending an ADDITIONAL ASSIGNMENT message to the mobile station on the main DCCH. The ADDITIONAL ASSIGNMENT message contains the description of the newly assigned channel.

On receipt of the message, the mobile station activates the new channel.

### **3.4.8.2 Additional assignment procedure completion**

The mobile station sends an ASSIGNMENT COMPLETE message to the network on the channel, on which it receives the ADDITIONAL ASSIGNMENT message.

### **3.4.8.3 Abnormal cases**

A lower layer failure occurring during the procedure is treated according to the general case (see section 3.5.2).

The network considers the channel as allocated from the sending of the ADDITIONAL ASSIGNMENT message. As a consequence, if a re-establishment occurs, the network will consider the context as if the mobile station has received the message, and the new configuration allocated after the re-establishment may differ from the one the mobile station had before the re-establishment.

## **3.4.9 Partial channel release procedure**

A change of channel configuration to release one channel can be requested by upper layers.

The purpose of this procedure is to deactivate part of the dedicated channels in use. The channel configuration remains dedicated.

NOTE: In the present state of GSM 04.03, this procedure is only possible for the TCH/H + TCH/H + ACCHs to TCH/H + ACCHs transition. As a consequence it is not needed for simple mobile stations.

The partial release procedure is always initiated by the network.

### **3.4.9.1 Partial release procedure initiation**

The network initiates the partial release by sending a PARTIAL RELEASE message to the mobile station on the main DCCH.

On receipt of the PARTIAL RELEASE message the mobile station:

- initiates the disconnection of all the link layer connections carried by the channel to be released;
- simultaneously initiates the connection on remaining channels of the data link layer connections that have been released;
- deactivates the physical channels to be released;
- sends a PARTIAL RELEASE COMPLETE to the network on the (possibly new) main signalling link.

### **3.4.9.2 Abnormal cases**

A lower layer failure is treated following the general rules as specified in section 3.5.2.

Moreover, on the network side, the channel configuration nature is set from the sending of the PARTIAL RELEASE message onward. As a consequence, any new assignment after a re-establishment may concern a different channel configuration nature from the one known by the mobile station before the re-establishment.

#### **3.4.10 Classmark change procedure**

This procedure allows the mobile station to indicate to the network a change of characteristics reflected in the classmark (e.g. due to addition of power amplification). Furthermore, a mobile station which implements the « controlled early classmark sending » option may also send a CLASSMARK CHANGE message as described in clause 3.3.1.4, even if no change of characteristics has occurred.

The mobile station sends a CLASSMARK CHANGE message to the network. This message contains the new mobile station classmark 2 information element. It may also contain a Classmark 3 Information Element. There is no acknowledgement from the network at layer 3.

#### **3.4.11 Classmark interrogation procedure**

This procedure allows the network to request additional classmark information from the mobile station (e.g. if the information initially sent by the mobile station is not sufficient for network decisions).

##### **3.4.11.1 Classmark interrogation initiation**

The network initiates the classmark interrogation procedure by sending a CLASSMARK ENQUIRY message to the mobile station on the main DCCH.

##### **3.4.11.2 Classmark interrogation completion**

On receipt of the CLASSMARK ENQUIRY message the mobile station sends a CLASSMARK CHANGE message to the network on the main DCCH. This message contains the mobile station classmark 2 information element. It may also contain a Classmark 3 Information Element.

### 3.5 RR connection release procedure

#### 3.5.1 Normal release procedure

The release of the RR connection can be requested by upper layers.

The purpose of this procedure is to deactivate all the dedicated channels in use. When the channels are released, the mobile station returns to the CCCH configuration, idle mode. The channel release procedure can be used in a variety of cases, including TCH release after a call release, and DCCH release when a dedicated channel allocated for signalling is released.

The channel release procedure is always initiated by the network.

##### 3.5.1.1 Channel release procedure initiation

The network initiates the channel release by sending a CHANNEL RELEASE message to the mobile station on the main DCCH, starts timer T3109 and deactivates the SACCH.

On receipt of a CHANNEL RELEASE message the mobile station starts timer T3110 and disconnects the main signalling link. When T3110 times out, or when the disconnection is confirmed, the mobile station deactivates all channels, considers the RR connection as released, and returns to CCCH idle mode.

NOTE: Data Links other than the main signalling link are disconnected by local end link release.

On the network side, when the main signalling link is disconnected, the network stops timer T3109 and starts timer T3111. When timer T3111 times out, the network deactivates the channels, they are then free to be allocated to another connection.

NOTE: The sole purpose of timer T3111 is to let some time to acknowledge the disconnection and to protect the channel in case of loss of the acknowledge frame.

If timer T3109 times out, the network deactivates the channels; they are then free to be allocated to another connection.

The CHANNEL RELEASE message will include an RR cause indication as follows:

- #0 if it is a normal release, e.g. at the end of a call or at normal release of a DCCH.
- #1 to indicate an unspecified abnormal release.
- #2, #3 or #4 to indicate a specific release event.
- #5 if the channel is to be assigned for servicing a higher priority call (e.g. an emergency call).
- #65 if e.g. a handover procedure is stopped because the call has been cleared.

The CHANNEL RELEASE message may include the information element BA Range which may be used by a mobile station in its selection algorithm (see GSM 05.08 and GSM 03.22).

##### 3.5.1.2 Abnormal cases

Abnormal cases are taken into account in the main part of the description of the procedure.

#### 3.5.2 Radio link failure

The main part of these procedures concerns the "normal" cases, i.e. those without any occurrence of loss of communication means. A separate section at the end of the description of each procedure treats the cases of loss of communication, called a radio link failure. In RR connected mode, in most of the cases the reaction of the mobile station or the network is the same. Those reactions are described in this section to avoid repetitions.

A radio link failure can be detected by several ways:

- (1) By analysis of reception at layer 1, as specified in GSM 05.08 and section 3.4.1.1.
- (2) By a data link layer failure as specified in GSM 04.06, on the main signalling link. A data link failure on any other data link shall not be considered as a radio link failure.
- (3) When a lower layer failure happens while the mobile station attempts to connect back to the old channels in a channel assignment procedure or handover procedure.
- (4) In some cases where timers are started to detect the lack of answer from the other party, as described in section 3.

The two first cases are known by the term "lower layer failure".

#### **3.5.2.1 Mobile side**

When a radio link failure is detected by the mobile station:

- the mobile station shall perform a local end release on all signalling links unless otherwise specified;
- The mobile station shall deactivate all channels;
- the RR sublayer of the mobile station shall indicate an RR connection failure to the MM sublayer unless otherwise specified.

NOTE: Upper layers may decide on a re-establishment (cf. section 5.5.4).

#### **3.5.2.2 Network side**

In RR connected mode, the reaction of the network to a lower layer failure depends on the context. Except when otherwise specified, it is to release the connection either with the channel release procedure as specified in section 3.5.1, or with the following procedure. The network starts timer T3109 and deactivates the SACCH (and hence to stop transmission on the SACCH).

When a radio link failure has been detected, an indication is passed to the upper Mobility Management sublayer on the network side.

When timer T3109 expires, the network can regard the channels as released and free for allocation.

This procedure relies on the fact that if a mobile station does not receive the SACCH for some time, it completely releases the channels (cf. GSM 05.08).

NOTE: The network should maintain for a while the transaction context in order to allow call re-establishment. The length of timer is for further study.

#### **3.5.3 RR connection abortion**

The mobile station aborts the RR connection by initiating a normal release of the main signalling link, performing local end releases on all other signalling links and disconnecting all traffic channels, if any.

#### **3.6 Receiving a RR STATUS message by a RR entity.**

If the RR entity of the mobile station receives a RR STATUS message no transition and no specific action shall be taken as seen from the radio interface, i.e. local actions are possible.

The actions to be taken on receiving a RR STATUS message in the network are an implementation dependent option see also section 8.

## 4 Elementary procedures for Mobility Management

### 4.1 General

This section describes the procedures used for mobility management at the radio interface (Reference Point Um).

The main function of the Mobility Management sublayer is to support the mobility of user terminals, such as informing the network of its present location and providing user identity confidentiality.

A further function of the MM sublayer is to provide connection management services to the different entities of the upper Connection Management (CM) sublayer (see GSM 04.07).

All the MM procedures described in this section can only be performed if a RR connection has been established between the mobile station and the network. Else the MM sublayer has to initiate the establishment of a RR connection according to the procedures specified in section 3.3.

#### 4.1.1 Type of MM procedures

Depending on how they can be initiated, three types of MM procedures can be distinguished:

(i) MM common procedures:

A MM common procedure can always be initiated whilst a RR connection exists. The procedures belonging to this type are:

Initiated by the network:

- TMSI reallocation procedure;
- authentication procedure;
- identification procedure;
- abort procedure.

However, abort procedure is used only if an MM connection is being established or has already been established i.e. not during MM specific procedures or during IMSI detach procedure (see section 4.3.5).

Initiated by the Mobile station:

- IMSI detach procedure (with the exceptions specified in section 4.3.4).

(ii) MM specific procedures:

A MM specific procedure can only be initiated if no other MM specific procedure is running or no MM connection exists. The procedures belonging to this type are:

- normal location updating procedure;
- periodic updating procedure;
- IMSI attach procedure .

(iii) MM connection management procedures:

These procedures are used to establish, maintain and release a MM connection between the mobile station and the network, over which an entity of the upper CM layer can exchange information with its peer. A MM connection establishment can only be performed if no MM specific procedure is running. More than one MM connection may be active at the same time.

## 4.1.2 MM sublayer states

The description of the states for the MM sublayer is organized as follows. The main states for the MS side, related to the procedures, are described in section 4.1.2.1.1. The MM IDLE state is subdivided in substates for the description of the behaviour in idle mode (section 4.1.2.1.2). This behaviour depends on an update status, described in 4.1.2.2. The states for the network side are described in 4.1.2.3.

### 4.1.2.1 MM sublayer states in the Mobile Station

In this section the possible states for the MM sublayer in the mobile station is described. In figure 4.1/GSM 04.08 an overview of the MM sublayer protocol is given.

#### 4.1.2.1.1 Main states

##### 0. NULL

The mobile station is inactive (e.g. power down). Important parameters are stored. Only manual action by the user may transfer the MM sublayer to another state.

##### 3. LOCATION UPDATING INITIATED

A location updating procedure has been started and the MM awaits a response from the network. The timer T3210 is running.

##### 5. WAIT FOR OUTGOING MM CONNECTION

The MM connection establishment has been started, and the MM awaits a response from the network. The timer T3230 is running.

##### 6. MM CONNECTION ACTIVE

The MM sublayer has a RR connection to its peer entity on the network side. One or more MM connections are active.

##### 7. IMSI DETACH INITIATED

The IMSI detach procedure has been started. The timer T3220 is running.

##### 9. WAIT FOR NETWORK COMMAND

The MM sublayer has a RR connection to its peer entity in the network, but no MM connection is established. The Mobile Station is passive, awaiting further commands from the network. The timer T3240 may be running.

##### 10. LOCATION UPDATE REJECTED

A location updating procedure has been rejected and RR connection release is awaited. The timer T3240 is running.



13. WAIT FOR RR CONNECTION (LOCATION UPDATING)  
The MM sublayer has requested RR connection establishment for starting the location updating procedure.
14. WAIT FOR RR CONNECTION (MM CONNECTION)  
The MM sublayer has requested RR connection establishment for starting the MM connection establishment.
15. WAIT FOR RR CONNECTION (IMSI DETACH)  
The MM sublayer has requested RR connection establishment for starting the IMSI detach procedure.
17. WAIT FOR RE-ESTABLISH  
A lower layer failure has occurred and reestablishment may be performed from the disturbed CM layer entities.
18. WAIT FOR RR ACTIVE  
The MM sublayer has requested activation of the RR sublayer.
19. MM IDLE  
There is no MM procedure running and no RR connection exist. This is a compound state, and the actual behaviour of the Mobile Station to Connection Management requests is determined by the actual substate as described hereafter.
20. WAIT FOR ADDITIONAL OUTGOING MM CONNECTION.  
The MM connection establishment for an additional MM connection has been started, and the MM awaits response from the network.



#### 4.1.2.1.2 Substates of the MM IDLE state

For the description of the behaviour of the MS the MM IDLE state is subdivided in several substates, also called the service states. The service state pertains to the whole MS (ME alone if no SIM is inserted, or ME plus SIM.). The service state depends on the update status (see section 4.1.2.2) and on the selected cell.

##### 19.1 NORMAL SERVICE

Valid subscriber data are available, update status is U1, a cell is selected that belongs to the LA where the subscriber is registered.

In this state, all requests from the CM layers are treated normally.

##### 19.2 ATTEMPTING TO UPDATE

Valid subscriber data are available, update status is U2 and a cell is selected. Requests from upper layers are accepted. Emergency call requests are treated normally, otherwise the request triggers first a location updating attempt in the selected cell, and then triggers the needed procedure only in case of successful location updating, otherwise the request is rejected.

##### 19.3 LIMITED SERVICE

Valid subscriber data are available, update status is U3, and a cell is selected, which is known not to be able to provide normal service. Only emergency services are offered.

##### 19.4 NO IMSI

No valid subscriber data (no SIM, or the SIM is not considered valid by the ME), and a cell is selected. Only emergency services are offered.

##### 19.5 NO CELL AVAILABLE

No cell can be selected. This state is entered after a first intensive search failed (state 19.7). Cells are searched at a low rhythm. No services are offered.

##### 19.6 LOCATION UPDATE NEEDED

Valid subscriber data are available, and for some reason a location updating must be done as soon as possible (for instance update status is U1 but the selected cell is not in the registered LA, or the timer has expired, ...). This state is usually of no duration, but can last, e.g., in the case of access class blocking.

##### 19.7 PLMN SEARCH

The MS is searching for PLMNs, and the conditions for state 19.8 are not met. This state is ended when either a cell is selected (the new state is 19.1, 19.3 or 19.6), or when it is concluded that no cell is available for the moment (the new state is 19.5).

##### 19.8 PLMN SEARCH, NORMAL SERVICE

Valid subscriber data are available, update status is U1, a cell is selected which belongs to the LA where the subscriber is registered, and the MS is searching for PLMNs. This state is ended when either a cell is selected (the new state is 19.1, 19.3 or 19.6), or when it is concluded that no cell is available for the moment (the new state is 19.5).

#### 4.1.2.2 The update Status

In parallel with the sublayer states described in section 4.1.2.1 and which control the MM sublayer protocol, an update status exists.

The update status pertains to a specific subscriber embodied by a SIM. This status is defined even when the subscriber is not activated (SIM removed or connected to a switched-off ME). It is stored in a non volatile memory in the SIM. The update status is changed only as a result of a location updating procedure attempt (with the exception of an authentication failure and of some cases of CM service rejection).

##### U1 UPDATED.

The last location updating attempt was successful (correct procedure outcome, and the answer was acceptance from the network). With this status, the SIM contains also the LAI of the LA where the subscriber is registered, and possibly valid TMSI, ciphering key and ciphering key sequence number. The "Location update status" stored on the SIM shall be "updated".

##### U2 NOT UPDATED.

The last location updating attempt made failed procedurally (no significant answer was received from the network, including the cases of failures or congestion inside the network).

For this status, the SIM does not contain any valid LAI, TMSI, ciphering key or ciphering key sequence number. For compatibility reasons, all these fields must be set to the "deleted" value at the moment the status is set to NOT UPDATED. However the presence of other values shall not be considered an error by the mobile station. The "Location update status" stored on the SIM shall be "not updated".

##### U3 ROAMING NOT ALLOWED.

The last location updating attempt run correctly, but the answer from the network was negative (because of roaming or subscription restrictions).

For this status, the SIM does not contain any valid LAI, TMSI, ciphering key or ciphering key sequence number. For compatibility reasons, all these fields must be set to the "deleted" value at the moment the status is set to ROAMING NOT ALLOWED. However the presence of other values shall not be considered an error by the mobile station. The "Location update status" stored on the SIM shall be "Location Area not allowed".

### 4.1.2.3 MM sublayer states on the network side

1. IDLE  
The MM sublayer is not active.
2. WAIT FOR RR CONNECTION  
The MM sublayer has received a request for MM connection establishment from the CM layer. A RR connection to the Mobile Station is requested from the RR sublayer (i.e. paging is performed).
3. MM CONNECTION ACTIVE  
The MM sublayer has a RR connection to a Mobile Station. One or more MM connections are active.
4. IDENTIFICATION INITIATED  
The identification procedure has been started by the network. The timer T3270 is running.
5. AUTHENTICATION INITIATED  
The authentication procedure has been started by the network. The timer T3260 is running.
6. TMSI REALLOCATION INITIATED  
The TMSI reallocation procedure has been started by the network. The timer T3250 is running.
7. CIPHERING MODE INITIATED  
The cipher mode setting procedure has been requested to the RR sublayer.
8. WAIT FOR MOBILE ORIGINATED MM CONNECTION  
A CM SERVICE REQUEST message is received and processed, and the MM sublayer awaits the "opening message" of the MM connection.
9. WAIT FOR REESTABLISHMENT  
The RR connection to a Mobile Station with one or more active MM connection has been lost. The network awaits a possible reestablishment request from the Mobile Station.

### 4.2 Behaviour in MM IDLE State

The MM IDLE state is entered when none of the MM procedures are running and no RR connection exists. It is left when one of the MM procedures are triggered or an RR connection is established.

The specific behaviour in the MM IDLE state depends on the service state of the mobile station as described in section 4.1.2.1.2. The service state depends in particular on the update status which is defined in section 4.1.2.2.

How an appropriate service state is chosen after power on is described in section 4.2.1, and the specific behaviour of the mobile station in MM IDLE state is described in section 4.2.2. The service state chosen when the MM IDLE state is returned to from any state except NULL state is described in 4.2.3.

It should be noted that transitions between the various MM idle states are caused by (e.g.):

- results of procedures on RR connected mode (see section 4.2.3);
- insertion or removal of the SIM;
- cell selection/reselection (see also GSM 03.22);
- PLMN search;
- loss of coverage.

How various MM procedures affects the service state and the update status is described in the detailed descriptions of the procedures in sections 4.3 to 4.5.

#### 4.2.1 Primary Service State selection

##### 4.2.1.1 Selection of the Service State after Power On.

When mobility management is activated after power-on, the service state is 19.7 PLMN SEARCH. The detailed processing in this state is described in detail in GSM 03.22 and 05.08, where procedures for power on and selection of PLMN is described in detail. If the "Location update status" stored on the SIM is different from "updated", then the mobile shall act as if the "Location update status" stored on the SIM is "not updated".

The service state when the PLMN SEARCH state is left depends on the outcome of the search and on the presence of the SIM:

- if no cell has been found, the state is NO CELL AVAILABLE, until a cell is found;
- if no SIM is present the state is NO IMSI;
- if the mobile station has been continuously activated since losing coverage and then returns to coverage, and if the selected cell is in the location area where the mobile station is registered and the timer T3212 has not expired, then the state is NORMAL SERVICE;
- if the selected cell is in the location area where the mobile station is registered and IMSI ATTACH is not required and timer T3212 has not expired, then the state is NORMAL SERVICE;
- if the mobile station is in automatic network selection mode and the selected cell is in a forbidden PLMN or a forbidden LA, then the mobile station enters the LIMITED SERVICE state;
- if the mobile station is in manual network selection mode and no cell of the selected PLMN has been found, then the mobile station enters the LIMITED SERVICE state;
- otherwise, the mobile station enters the LOCATION UPDATE NEEDED state.

##### 4.2.1.2 Other Cases

The state PLMN SEARCH is also entered in the following cases:

- in state NO IMSI, a SIM is inserted;
- in any state except NO IMSI, NO CELL AVAILABLE and NORMAL SERVICE, after the user has asked for a PLMN selection;
- in any state except NO IMSI and NO CELL AVAILABLE, coverage is lost;
- roaming is denied with cause "roaming not allowed in this Location Area";
- optionally, when the mobile station is in the ATTEMPTING TO UPDATE state and is in Automatic Network Selection mode and location update attempt counter is greater than or equal to 4.

The service state when the PLMN SEARCH is left depends on the outcome of the search and on the presence of the SIM as specified in section 4.2.1.1.

#### 4.2.2 Detailed Description of the MS behaviour in MM IDLE State

In the MM IDLE state the mobile station shall behave according to the service state. In the following sections the behaviour is described for the non transient service states. It should be noted that after procedures in RR connected mode, e.g. location updating procedures, section 4.2.3 applies which specifies the selection of the MM idle state. Furthermore when in sub-state NORMAL SERVICE, if a PLMN selection is requested, the mobile station enters sub-state PLMN SEARCH, NORMAL SERVICE.

##### 4.2.2.1 Service State, NORMAL SERVICE

When in state MM IDLE and service state NORMAL SERVICE, the mobile station shall:

- perform normal location updating when a new location area is entered;
- perform location updating procedure at expiry of timer T3211 or T3213;
- perform periodic updating at expiration of timer T3212;
- perform IMSI detach;
- support requests from the CM layer;
- respond to paging.

#### **4.2.2.2 Service State, ATTEMPTING TO UPDATE**

When in state MM IDLE and service state ATTEMPTING TO UPDATE the mobile station shall:

- perform location updating procedure at expiry of timer T3211 or T3213;
- perform normal location updating when the location area identification of the serving cell changes;
- if entry into this state was caused by c) or d) or f) (with cause different from "abnormal release, unspecified") or g) (with cause "retry upon entry into a new cell") of section 4.4.4.9, then location updating should be performed when a new cell is entered;
- if entry into this state was caused by e) or f) (with cause "abnormal release, unspecified") or g) (with cause different from "retry upon entry into a new cell") of section 4.4.4.9, then location updating should not be performed because a new cell is entered;
- perform normal location updating at expiry of timer T3212;
- not perform IMSI detach;
- support request for emergency calls;
- use other request from CM layer as triggering of normal location updating procedure (if the location updating procedure is successful, then the request for MM connection is accepted, see section 4.5.1);
- respond to paging (with IMSI).

#### **4.2.2.3 Service State, LIMITED SERVICE**

When in state MM IDLE and service state LIMITED SERVICE the mobile station shall:

- not perform periodic updating;
- not perform IMSI detach;
- reject any requests from CM entities for MM connections except for emergency calls;
- perform normal location updating when a cell is entered which may provide normal service (e.g. location area not in one of the forbidden LAI lists);
- it may respond to paging (with IMSI).

#### **4.2.2.4 Service State, NO IMSI**

When in state MM IDLE and service state NO IMSI the mobile station shall (see section 3.2, GSM 03.22 and GSM 05.08):

- not start any normal location updating attempt;
- not perform periodic updating;
- not perform IMSI detach if powered down;
- reject any request from CM entities for MM connections except for emergency calls;
- not respond to paging;
- only perform default cell selection.

#### **4.2.2.5 Service State, SEARCH FOR PLMN, NORMAL SERVICE**

When in state MM IDLE and service state SEARCH FOR PLMN, NORMAL SERVICE the mobile station shall:

- if timer T3211 or T3213 expires in this state perform a location updating procedure at the latest if and when back to NORMAL SERVICE state and if the cell is not changed;
- if timer T3212 expires in this state perform a periodic location updating procedure at the latest if and when back to NORMAL SERVICE state;
- perform IMSI detach;
- support requests from the CM layer;
- listen as far as possible to paging, and respond.

#### **4.2.2.6 Service State, SEARCH FOR PLMN**

When in state MM IDLE and service state SEARCH FOR PLMN the mobile station shall:

- not start any normal location updating attempt;
- not perform periodic updating;
- not perform IMSI detach if powered down;
- reject any request from CM entities for MM connections except emergency calls;
- not respond to paging.

#### **4.2.3 Service state when back to state MM IDLE from another state**

When returning to MM IDLE, e.g., after a location updating procedure, the mobile station selects the cell as specified in GSM 03.22. With one exception, this is a normal cell selection.

If this return to idle state is not subsequent to a location updating procedure terminated with reception of cause "Roaming not allowed in this location area" the service state depends on the result of the cell selection procedure, on the update status of the mobile station, on the location data stored in the Mobile Station and on the presence of the SIM:

- if no cell has been found, the state is NO CELL AVAILABLE, until a cell is found;
- if no SIM is present, or if the inserted SIM is considered invalid by the MS, the state is NO IMSI;
- if the selected cell is in the location area where the mobile station is registered, then the state is NORMAL SERVICE; it shall be noted that this also includes an abnormal case described in section 4.4.4.9;
- if the selected cell is in a location area where the mobile station is not registered but in which the mobile station is allowed to attempt a location update, then the state is LOCATION UPDATE NEEDED;
- if the selected cell is in a location area where the mobile station is not allowed to attempt a location update, then the state is LIMITED SERVICE;
- after some abnormal cases occurring during an unsuccessful location updating procedure, as described in section 4.4.4.9, the state is ATTEMPTING TO UPDATE;

In case of a return from a location updating procedure to which was answered "Roaming not allowed in this location area", the service state PLMN SEARCH is entered as specified in section 4.2.1.2.

### 4.3 MM common procedures

As described above, a MM common procedure can be initiated at any time whilst a RR connection exists between the network and the mobile station.

#### 4.3.1 TMSI reallocation procedure

The purpose of the TMSI reallocation procedure is to provide identity confidentiality, i.e. to protect a user against being identified and located by an intruder (see GSM 02.09 and 03.20).

If the identity confidentiality service is applied for an IMSI, a Temporary Mobile Subscriber Identity (TMSI) is used for identification within the radio interface signalling procedures.

The structure of the TMSI is specified in GSM 03.03. The TMSI has significance only within a location area. Outside the location area it has to be combined with the Location Area Identifier (LAI) to provide for an unambiguous identity.

Usually the TMSI reallocation is performed at least at each change of a location area. (Such choices are left to the network operator).

The reallocation of a TMSI can be performed either by a unique procedure defined in this section or implicitly by a location updating procedure using the TMSI. The implicit reallocation of a TMSI is described together with that procedure.

If a TMSI provided by a Mobile Station is unknown in the network e.g. due to a data base failure, the network may require the Mobile Station to provide its International Mobile Subscriber Identity (IMSI). In this case the identification procedure (see section 4.3.3) should be used before the TMSI reallocation procedure may be initiated.

The TMSI reallocation can be initiated by the network at any time whilst a RR connection exists between the network and the mobile station.

NOTE 1: Usually the TMSI reallocation is performed in ciphered mode.

NOTE 2: Normally the TMSI reallocation will take place in conjunction with another procedure, e.g. at location updating or at call setup (see GSM 09.02).

##### 4.3.1.1 TMSI reallocation initiation by the network

The network initiates the TMSI reallocation procedure by sending a TMSI REALLOCATION COMMAND message to the Mobile Station and starts the timer T3250.

The TMSI REALLOCATION COMMAND message contains a new combination of TMSI and LAI allocated by the network or a LAI and the IMSI if the used TMSI shall be deleted. Usually the TMSI-REALLOCATION COMMAND message is sent to the Mobile Station using a RR connection in ciphered mode (see GSM 03.20).

##### 4.3.1.2 TMSI reallocation completion by the Mobile Station

Upon receipt of the TMSI REALLOCATION COMMAND message the Mobile Station stores the Location Area Identifier (LAI) in the SIM. If the received identity is the IMSI of the relevant mobile station, the mobile station deletes any TMSI. If the received identity is a TMSI the mobile station stores the TMSI in the SIM. In both cases the mobile station sends a TMSI REALLOCATION COMPLETE message to the network.

##### 4.3.1.3 TMSI reallocation completion in the network

Upon receipt of the TMSI REALLOCATION COMPLETE message, the network stops the timer T3250 and either considers the new TMSI as valid or, if an IMSI was sent to the MS, considers the old TMSI as deleted.

If the RR connection is no more needed, then the network will request the RR sublayer to release it (see section 3.5).

#### 4.3.1.4 Abnormal cases

Mobile Station side:

The Mobile Station shall consider the new TMSI and new LAI, if any, as valid and the old TMSI and old LAI as deleted as soon as a TMSI REALLOCATION COMMAND or another message containing a new TMSI (e.g. LOCATION UPDATING ACCEPT) is correctly received. Any RR connection failure at a later stage shall not have any impact on the TMSI and LAI storage.

Network side:

(a) RR connection failure:

If the RR connection is lost before the TMSI REALLOCATION COMPLETE message is received, all MM connections (if any) shall be released and both the old and the new TMSIs should be considered as occupied for a certain recovery time.

During this period the network may:

- use the IMSI for paging in the case of network originated transactions on the CM layer. Upon response from the Mobile Station the TMSI reallocation is restarted;
- consider the new TMSI as valid if it is used by the Mobile Station in mobile originated requests for RR connection;
- use the Identification procedure followed by a new TMSI reallocation if the Mobile Station uses the old TMSI.

Other implementations are possible.

(b) Expiry of timer T3250:

The TMSI reallocation is supervised by the timer T3250 in the network. At the first expiry of timer T3250 the network may release the RR connection. In this case, the network shall abort the reallocation procedure release all MM connections if any, and follow the rules described for RR connection failure above.

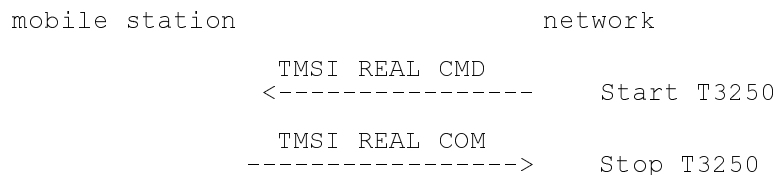

**Figure 4.1/GSM 04.08:  
TMSI reallocation sequence**

#### 4.3.2 Authentication procedure

The purpose of the authentication procedure is twofold:

First to permit the network to check whether the identity provided by the Mobile Station is acceptable or not (see GSM 03.20).

Second to provide parameters enabling the MS to calculate a new ciphering key.

The cases where the authentication procedure should be used are defined in GSM 02.09.

The authentication procedure is always initiated and controlled by the network.



#### **4.3.2.1 Authentication request by the network**

The network initiates the authentication procedure by transferring an AUTHENTICATION REQUEST message across the radio interface and starts the timer T3260. The AUTHENTICATION REQUEST message contains the parameters necessary to calculate the response parameters (see GSM 03.20). It also contains the ciphering key sequence number allocated to the key which may be computed from the given parameters.

#### **4.3.2.2 Authentication response by the Mobile Station**

The Mobile Station shall be ready to respond upon an AUTHENTICATION REQUEST message at any time whilst a RR connection exists. It shall process the challenge information and send back an AUTHENTICATION RESPONSE message to the network. The new ciphering key calculated from the challenge information shall overwrite the previous one and be stored on the SIM before the AUTHENTICATION RESPONSE message is transmitted. The ciphering key stored in the SIM shall be loaded in to the ME when any valid CIPHERING MODE COMMAND is received during an RR connection (the definition of a valid CIPHERING MODE COMMAND message is given in section 3.4.7.2). The ciphering key sequence number shall be stored together with the calculated key.

#### **4.3.2.3 Authentication processing in the network**

Upon receipt of the AUTHENTICATION RESPONSE message, the network stops the timer T3260 and checks the validity of the response (see GSM 03.20).

#### **4.3.2.4 Ciphering key sequence number**

The security parameters for authentication and ciphering are tied together in sets, i.e. from a challenge parameter RAND both the authentication response SRES and the ciphering key can be computed given the secret key associated to the IMSI.

In order to allow start of ciphering on a RR connection without authentication, the ciphering key sequence numbers are introduced. The sequence number is managed by the network in the way that the AUTHENTICATION REQUEST message contains the sequence number allocated to the key which may be computed from the RAND parameter carried in that message.

The Mobile Station stores this number with the key, and indicates to the network in the first message (LOCATION UPDATING REQUEST, CM SERVICE REQUEST, PAGING RESPONSE, CM REESTABLISHMENT REQUEST) which sequence number the stored key has. When the deletion of the sequence number is described this also means that the associated key shall be considered as invalid.

The network may choose to start ciphering with the stored key (under the restrictions given in GSM 02.09) if the stored sequence number and the one given from the Mobile Station are equal.

#### **4.3.2.5 Unsuccessful authentication**

If authentication fails, i.e. if the response is not valid, the network may distinguish between the two different ways of identification used by the Mobile Station:

- the TMSI was used;
- the IMSI was used.

If the TMSI has been used, the network may decide to initiate the identification procedure. If the IMSI given by the Mobile Station then differs from the one the network had associated with the TMSI, the authentication should be restarted with the correct parameters. If the IMSI provided by the Mobile Station is the expected one (i.e. authentication has really failed), the network should proceed as described below.

If the IMSI has been used, or the network decides not to try the identification procedure, an AUTHENTICATION REJECT message should be transferred to the Mobile Station.

After having sent this message, all MM connections in progress (if any) are released and the network should initiate the RR connection release procedure described in section 3.5.

Upon receipt of an AUTHENTICATION REJECT message, the Mobile Station shall set the update status in the SIM to ROAMING NOT ALLOWED, delete from the SIM the stored TMSI, LAI and ciphering key sequence number, and consider the SIM invalid until switched-off or the SIM is removed.

#### 4.3.2.6 Abnormal cases

(a) RR connection failure:

Upon detection of a RR connection failure before the AUTHENTICATION RESPONSE is received, the network shall release all MM connections (if any) and abort any ongoing MM specific procedure.

(b) Expiry of timer T3260:

The authentication procedure is supervised on the network side by the timer T3260. At expiry of this timer the network may release the RR connection. In this case the network shall abort the authentication procedure and any ongoing MM specific procedure, release all MM connections if any, and initiate the RR connection release procedure described in section 3.5.

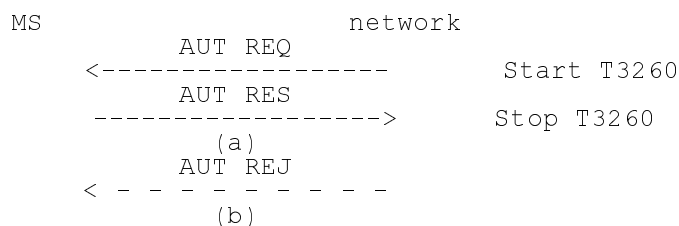

**Figure 4.2/GSM 04.08:**  
**Authentication sequence:**  
**(a) authentication;**  
**(b) authentication rejection.**

### 4.3.3 Identification procedure

The identification procedure is used by the network to request a Mobile Station to provide specific identification parameters to the network e.g. International Mobile Subscriber Identity, International Mobile Equipment Identity (cf. GSM 03.03). For the presentation of the IMEI, the requirements of GSM 02.09 apply.

#### 4.3.3.1 Identity request by the network

The network initiates the identification procedure by transferring an IDENTITY REQUEST message to the Mobile Station and starts the timer T3270. The IDENTITY REQUEST message specifies the requested identification parameters in the identity type information element.

#### 4.3.3.2 Identification response by the Mobile Station

The mobile station shall be ready to respond to an IDENTITY REQUEST message at any time whilst a RR connection exists.

Upon receipt of the IDENTITY REQUEST message the Mobile Station sends back an IDENTITY RESPONSE message. The IDENTITY RESPONSE message contains the identification parameters as requested by the network.

Upon receipt of the IDENTITY RESPONSE the network shall stop timer T3270.

#### 4.3.3.3 Abnormal cases

(a) RR connection failure:

Upon detection of a RR connection failure before the IDENTITY RESPONSE is received, the network shall release all MM connections (if any) and abort any ongoing MM specific procedure.

(b) Expiry of timer T3270:

The identification procedure is supervised by the network by the timer T3270. At expiry of the timer T3270 the network may release the RR connection. In this case, the network shall abort the identification procedure and any ongoing MM specific procedure, release all MM connections if any, and initiate the RR connection release procedure as described in section 3.5.

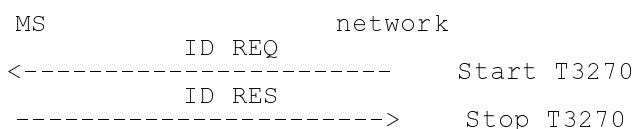

**Figure 4.3/GSM 04.08:  
Identification sequence**

#### 4.3.4 IMSI detach procedure

The IMSI detach procedure may be invoked by a Mobile Station if the Mobile Station is deactivated or if the Subscriber Identity Module (see GSM 02.17) is detached from the Mobile Station. A flag (ATT) broadcasted in the SYSTEM INFORMATION TYPE 3 message on the BCCH is used by the network to indicate whether the detach procedure is required.

The procedure causes the Mobile Station to be indicated as inactive in the network.

##### 4.3.4.1 IMSI detach initiation by the Mobile Station

The IMSI detach procedure consists only of the IMSI DETACH INDICATION message sent from the Mobile Station to the network. The Mobile Station then starts timer T3220 and enters the MM sublayer state IMSI DETACH INITIATED.

If no RR connection exists, the MM sublayer within the mobile station will request the RR sublayer to establish a RR connection. If a RR connection exists, the MM sublayer will release locally any ongoing MM connections before the IMSI DETACH INDICATION message is sent.

The IMSI detach procedure may not be started if a MM specific procedure is active. If possible, the IMSI detach procedure is then delayed until the MM specific procedure is finished, else the IMSI detach is omitted.

##### 4.3.4.2 IMSI detach procedure in the network

When receiving an IMSI DETACH INDICATION message, the network may set an inactive indication for the IMSI. No response is returned to the Mobile Station. After reception of the IMSI DETACH INDICATION message the network shall release locally any ongoing MM connections, and start the normal RR connection release procedure (see section 3.5).

##### 4.3.4.3 IMSI detach completion by the Mobile Station

Timer T3220 is stopped when the RR connection is released. The Mobile Station should, if possible, delay the local release of the channel to allow a normal release from the network side until T3220 time-out. If this is not possible (e.g. detach at power down) the RR sublayer on the Mobile Station side should be aborted.

##### 4.3.4.4 Abnormal cases

If establishment of an RR connection is not possible, or the RR connection is lost, the IMSI detach is aborted by the Mobile Station.

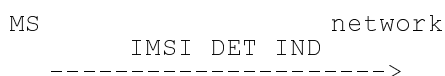

**Figure 4.4/GSM 04.08:  
IMSI detach sequence**

#### 4.3.5 Abort procedure

The abort procedure may be invoked by the network to abort any on-going MM connection establishment or already established MM connection. The mobile station shall treat ABORT message as compatible with current protocol state only if it is received when at least one MM connection exists or an MM connection is being established.

#### 4.3.5.1 Abort procedure initiation by the network

The abort procedure consists only of the ABORT message sent from the network to the Mobile Station. Before the sending of the ABORT message the network shall locally release any ongoing MM connection. After the sending the network may start the normal RR connection release procedure.

The Cause information element indicates the reason for the abortion. The following cause values may apply:

- # 6: Illegal ME
- #17: Network failure

#### 4.3.5.2 Abort procedure in the Mobile Station

At the receipt of the ABORT message the Mobile Station shall abort any MM connection establishment or call re-establishment procedure and release all MM connections (if any). If cause value #6 is received the Mobile Station shall delete any TMSI, LAI and ciphering key sequence number stored in the SIM, set the update status to ROAMING NOT ALLOWED (and store it in the SIM according to section 4.1.2.2) and consider the SIM invalid until switch off or the SIM is removed. As a consequence the mobile station enters state MM IDLE, substate NO IMSI after the release of the RR connection.

The Mobile Station shall then wait for the network to release the RR connection (see section 4.5.3.1).

### 4.4 MM specific procedures

A MM specific procedure can only be started if no other MM specific procedure is running or no MM connection exists between the network and the mobile station. The end of the running MM specific procedure or the release of all MM connections have to be awaited before a new MM specific procedure can be started.

During the lifetime of a MM specific procedure, if a MM connection establishment is requested by a CM entity, this request will either be rejected or be delayed until the running MM specific procedure is terminated (this depends on the implementation).

Any MM common procedure (except IMSI detach) may be initiated during a MM specific procedure.

Unless it has specific permission from the network (follow-on proceed) the Mobile Station side should await the release of the RR connection used for a MM specific procedure before a new MM specific procedure or MM connection establishment is started.

NOTE: The network side may use the same RR connection for MM connection management.

#### 4.4.1 Location updating procedure

The location updating procedure is a general procedure which is used for the following purposes:

- normal location updating (described in this section);
- periodic updating (see section 4.4.2);
- IMSI attach (see section 4.4.3).

The normal location updating procedure is used to update the registration of the actual Location Area of a Mobile Station in the network. The location updating type information element in the LOCATION UPDATING REQUEST message shall indicate normal location updating. The conditions under which the normal location updating procedure is used by a Mobile Station in the MM IDLE state are defined for each service state in section 4.2.2.

The normal location updating procedure shall also be started if the network indicates that the Mobile Station is unknown in the VLR as a response to MM connection establishment request.

To limit the number of location updating attempts made, where location updating is unsuccessful, an attempt counter is used. The attempt counter is reset when a Mobile Station is switched on or a SIM card is inserted.

Upon successful location updating the Mobile Station sets the update status to UPDATED in the SIM, and stores the received Location Area Identification in the SIM. The attempt counter shall be reset.

The detailed handling of the attempt counter is described in sections 4.4.4.6 to 4.4.4.9.

The Mobile Equipment shall contain a list of "forbidden location areas for roaming", as well as a list of "forbidden location areas for regional provision of service". These lists shall be erased when the MS is switched off or when the SIM is removed, and periodically (with period in the range 12 to 24 hours). The location area identification received on the BCCH that triggered the location updating request shall be added to the suitable list whenever a location update reject message is received with the cause "Roaming not allowed in this location area" or with the cause "Location Area not allowed". The lists shall accommodate each 10 or more location area identifications. When the list is full and a new entry has to be inserted, the oldest entry shall be deleted.

The cell selection processes in the different states are described in GSM 03.22 and GSM 05.08.

The location updating procedure is always initiated by the Mobile Station.

#### **4.4.2 Periodic updating**

Periodic updating may be used to notify periodically the availability of the Mobile Station to the network. Periodic updating is performed by using the location updating procedure. The location updating type information element in the LOCATION UPDATING REQUEST message shall indicate periodic updating.

The procedure is controlled by the timer T3212 in the Mobile Station. If the timer is not already started, the timer is started each time the Mobile Station enters the MM IDLE substate NORMAL SERVICE or ATTEMPTING TO UPDATE. The timer T3212 is stopped when the Mobile Station leaves the MM IDLE state.

The timer is stopped and reset to 0 when:

- a LOCATION UPDATING ACCEPT or LOCATION UPDATING REJECT message is received;
- the first MM message is received, or ciphering mode setting is completed in the case of MM connection establishment;
- the MS has responded to paging and thereafter has received the first correct layer 3 message except RR message;
- the timer has expired;
- the MS is deactivated (i.e. equipment powered down or SIM removed).

When the timer reaches the T3212 time-out value, the location updating procedure is started.

The conditions under which the periodic location updating procedure is used by a Mobile Station in the MM IDLE state are defined for each service state in section 4.2.2.

If the Mobile Station is in service state NO CELL AVAILABLE, LIMITED SERVICE, PLMN SEARCH or PLMN SEARCH-NORMAL SERVICE when the timer expires the location updating procedure is delayed until this service state is left. The (periodic) location updating procedure is not started if the BCCH information at the time the procedure is triggered indicates that periodic location shall not be used. The time-out value is broadcasted in the SYSTEM INFORMATION TYPE 3 message on the BCCH, in the Control channel description IE (see section 10.5.2.11).

The T3212 time-out value shall not be changed in the NO CELL AVAILABLE, LIMITED SERVICE, PLMN SEARCH and PLMN SEARCH-NORMAL SERVICE states.

When a change of the T3212 time-out value has to be taken into account and the timer is running (at change of the serving cell or, change of the broadcast value of T3212), the MS shall behave as follows:

Let  $t_1$  be the new T3212 time-out value and let  $t$  be the current timer value at the moment of the change to the new T3212 time-out value; then the timer shall be restarted with the value  $t$  modulo  $t_1$ .

When the Mobile Station is activated, or when a change of the T3212 time-out value has to be taken into account and the timer is not running, the MS shall behave as follows:

Let  $t_1$  be the new T3212 time-out value, the new timer shall be started at a value randomly, uniformly drawn between 0 and  $t_1$ .

#### **4.4.3 IMSI attach procedure**

The IMSI attach procedure is the complement of the IMSI detach procedure (see section 4.3.4). It is used to indicate the IMSI as active in the network. A flag (ATT) is broadcast in the SYSTEM INFORMATION TYPE 3 message. It indicates whether the attach and detach procedures are required to be used or not.

The IMSI attach procedure is invoked if the detach/attach procedures are required by the network and an IMSI is activated in a Mobile Station (i.e. activation of a Mobile Station with plug-in SIM, insertion of a card in a card-operated Mobile Station etc.) within coverage area from the network or a Mobile Station with an IMSI activated outside the coverage area enters the coverage area. The IMSI attach procedure is used only if the update status is UPDATED and if the stored Location Area Identification is the same as the one which is actually broadcasted on the BCCH of the current serving cell. Otherwise a normal location updating procedure (see section 4.4.1) is invoked independently of the ATT flag indication.

IMSI attach is performed by using the location updating procedure. The location updating type information element in the LOCATION UPDATING REQUEST message shall in this case indicate IMSI attach.

#### **4.4.4 Generic Location Updating procedure**

##### **4.4.4.1 Location updating initiation by the Mobile Station**

Any timer used for triggering the location updating procedure (e.g. T3211, T3212) is stopped if running.

As no RR connection exists at the time when the location updating procedure has to be started, the MM sublayer within the mobile station will request the RR sublayer to establish a RR connection and enter state WAIT FOR RR CONNECTION (LOCATION UPDATE). The procedure for establishing an RR connection is described in section 3.3.

The Mobile Station initiates the location updating procedure by sending a LOCATION UPDATING REQUEST message to the network, starts the timer T3210 and enters state LOCATION UPDATING INITIATED. The location updating type information element shall indicate what kind of updating is requested.

##### **4.4.4.1a Network Request for Additional MS Capability Information**

The network may initiate the classmark interrogation procedure, for example, to obtain further information on the MS's encryption capabilities.

##### **4.4.4.2 Identification request from the network**

The network may initiate the identification procedure, e.g. if the network is unable to get the IMSI based on the TMSI and LAI used as identification by the Mobile Station (see section 4.3.3).

##### **4.4.4.3 Authentication by the network**

The authentication procedure (see section 4.3.2) may be initiated by the network upon receipt of the LOCATION UPDATING REQUEST message from the Mobile Station. (See the cases defined in GSM 02.09).

#### 4.4.4.4 Cipherring mode setting by the network

The cipherring mode setting procedure (see section 3.4.7) may be initiated by the network, e.g., if a new TMSI has to be allocated.

#### 4.4.4.5 Attempt Counter

To limit the number of location updating attempts made, where location updating is unsuccessful, an attempt counter is used. It counts the number of consecutive unsuccessful location update attempts.

The attempt counter is incremented when a location update procedure fails. The specific situations is specified in section 4.4.4.9.

The attempt counter is reset when:

- the mobile station is powered on;
- a SIM is inserted;
- location update is successfully completed;
- location update completed with cause #11, #12 or #13 (see section 4.4.4.7);

and in case of service state ATTEMPTING to UPDATE:

- a new location area is entered;
- expiry of timer T3212;
- location update is triggered by CM sublayer requests.

The attempt counter is used when deciding whether to re-attempt a location update after time-out of timer T3211.

#### 4.4.4.6 Location updating accepted by the network

If the location updating is accepted by the network a LOCATION UPDATING ACCEPT message is transferred to the Mobile Station.

In case the identity confidentiality service is active (see sections 4.3.1 and 4.4.4.4), the TMSI reallocation may be part of the location updating procedure. The TMSI allocated is then contained in the LOCATION UPDATING ACCEPT message together with the location area identifier LAI. The network shall in this case start the supervision timer T3250 as described in section 4.3.1.

If the network wishes to prolong the RR connection to allow the MS to initiate MM connection establishment (for example if the mobile station has indicated in the LOCATION UPDATING REQUEST that it has a follow-on request pending) the network shall send "follow on proceed" in the LOCATION UPDATING ACCEPT and start timer T3255.

The mobile station receiving a LOCATION UPDATING ACCEPT message shall store the received location area identification LAI, stop timer T3210, reset the attempt counter and set the update status in the SIM to UPDATED. If the message contains an IMSI, the mobile station is not allocated any TMSI, and shall delete any TMSI in the SIM accordingly. If the message contains a TMSI, the mobile station is allocated this TMSI, and shall store this TMSI in the SIM and a TMSI REALLOCATION COMPLETE shall be returned to the network. If neither IMSI nor TMSI is received in the LOCATION UPDATING ACCEPT message, the old TMSI if any available shall be kept.

If the LAI or PLMN identity contained in the LOCATION UPDATING ACCEPT message is a member of any of the "forbidden lists" then any such entries shall be deleted.

After that, the mobile station shall act according to the presence of the "Follow-on proceed" information element in the LOCATION UPDATING ACCEPT; if this element is present and the mobile station has a CM application request pending, it shall send a CM SERVICE REQUEST to the network and proceed as in section 4.5.1.1. Otherwise, it shall start timer T3240 and enter state WAIT FOR NETWORK COMMAND.



#### 4.4.4.7 Location updating not accepted by the network

If the location updating cannot be accepted the network sends a LOCATION UPDATING REJECT message to the Mobile Station. The Mobile Station receiving a LOCATION UPDATING REJECT message shall stop the timer T3210, store the reject cause, start T3240, enter state LOCATION UPDATING REJECTED await the release of the RR connection triggered by the network. Upon the release of the RR connection the MS shall take the following actions depending on the stored reject cause:

- # 2 (IMSI unknown in HLR)
- # 3 (Illegal MS)
- # 6 (Illegal ME)

The Mobile Station shall set the update status to ROAMING NOT ALLOWED (and store it in the SIM according to section 4.1.2.2), and delete any TMSI, stored LAI and ciphering key sequence number and shall consider the SIM as invalid until switch-off or the SIM is removed.

- # 11 (PLMN not allowed)
- # 12 (Location Area not allowed)
- # 13 (Roaming not allowed in this location area)

The Mobile Station shall delete any LAI, TMSI and ciphering key sequence number stored in the SIM, reset the attempt counter, set the update status to ROAMING NOT ALLOWED (and store it in the SIM according to section 4.1.2.2). The Mobile Station shall store the LAI or the PLMN identity in the suitable forbidden list, i.e. in the "forbidden PLMN list" for cause #11, in the list of "forbidden location areas for regional provision of service" for cause #12, and in the list of "forbidden location areas for roaming" for cause #13. In addition, the MS will memorize if cause #13 was received, so to perform a PLMN selection instead of a cell selection when back to the MM IDLE state.

Other values are considered as abnormal cases and the specification of the MS behaviour in those cases is given in section 4.4.4.9.

#### 4.4.4.8 Release of RR connection after location updating

When the Location updating procedure is finished (see sections 4.4.4.6 and 4.4.4.7) the Mobile Station shall (except in the case where the mobile has a follow-on CM application request pending and has received the follow-on proceed indication, see section 4.4.4.6) set timer T3240 and enter the state WAIT FOR NETWORK COMMAND, expecting the release of the RR connection. The network may decide to keep the RR connection for network initiated establishment of a MM connection, or to allow for mobile initiated MM connection establishment.

Any release of the RR connection shall be initiated by the network according to section 3.5. If the RR connection is not released within a given time controlled by the timer T3240, the Mobile station shall abort the RR connection. In both cases, either after a RR connection release triggered from the network side or after a RR connection abort requested by the MS-side, the MS shall return to state MM IDLE.

At transition to state MM IDLE, substates NORMAL SERVICE or ATTEMPTING TO UPDATE either timer T3212 or timer T3211 is started as described in section 4.4.4.9.

#### 4.4.4.9 Abnormal cases on the Mobile Station side

The different abnormal cases that can be identified are the following:

- a) Access barred because of access class control.  
The location updating procedure is not started. The MS stays in the current serving cell and applies normal cell reselection process. The procedure is started as soon as possible and if still necessary (when the barred state is ended or because of a cell change).
- b) The answer to random access is an IMMEDIATE ASSIGNMENT REJECT message.  
The location updating is not started. The MS stays in the chosen cell and applies normal cell selection process. The waiting timer T3122 is reset when a cell change occurs. The procedure is started as soon as possible after T3122 time-out if still necessary.

- c) Random access failure.  
Timer T3213 is started. When it expires the procedure is attempted again if still necessary.

NOTE: As specified in GSM 05.08, a cell reselection then takes place, with return to the cell inhibited for 5 seconds if there is at least one other suitable cell. Typically the selection process will take the MS back to the cell where the random access failed after 5 seconds.

If random access failure occurs for two successive random access attempts for location updating the mobile station proceeds as specified below.

- d) RR connection failure.  
The procedure is aborted and the MS proceeds as specified below.
- e) T3210 time-out.  
The procedure is aborted, the RR connection is aborted and the MS proceeds as specified below.
- f) RR release before the normal end of procedure.  
The procedure is aborted and the MS proceeds as specified below.
- g) Location updating reject, other causes than those treated in section 4.4.4.7.  
The MS waits for release of the RR connection as specified in section 4.4.4.8, and then proceeds as specified below.

In cases d) to g) above and for repeated failures as defined in c) above the MS proceeds as follows. Timer T3210 is stopped if still running. The RR Connection is aborted in case of timer T3210 time-out. The attempt counter is incremented. The next actions depend on the Location Area Identities (stored and received from the BCCH of the current serving cell) and the value of the attempt counter.

- The update status is UPDATED, and the stored LAI is equal to the one received on the BCCH from the current serving cell and the attempt counter is smaller than 4.  
The MS shall keep the update status to UPDATED, the MM IDLE sub-state after the RR connection release is NORMAL SERVICE. The Mobile Station shall memorize the location updating type used in the location updating procedure. It shall start timer T3211 when the RR connection is released. When timer T3211 expires the location updating procedure is triggered again with the memorized location updating type.
- Either the update status is different from UPDATED, or the stored LAI is different from the one received on the BCCH from the current serving cell, or the attempt counter is greater or equal to 4.  
The MS shall delete any LAI, TMSI, ciphering key sequence number stored in the SIM, set the update status to NOT UPDATED and enter the MM IDLE sub-state ATTEMPTING TO UPDATE when the RR connection is released (see section 4.2.2.2 for the subsequent actions). If the attempt counter is smaller than 4, the MS shall memorize that timer T3211 is to be started when the RR connection is released, otherwise it shall memorize that timer T3212 is to be started when the RR connection is released.

#### 4.4.4.10 Abnormal cases on the network side

a) RR connection failure.

If a RR connection failure occurs during a common procedure integrated with the location updating procedure, the behaviour of the network should be according to the description of that common procedure.

If a RR connection failure occurs when a common procedure does not exist, the location updating procedure towards the Mobile Station should be aborted.

b) protocol error.

If the LOCATION UPDATING REQUEST message is received with a protocol error, the network should, if possible, return a LOCATION UPDATING REJECT message with one of the following Reject causes:

#96: Mandatory information element error

#99: Information element non-existent or not implemented

#100: Conditional IE error

#111: Protocol error, unspecified

Having sent the response, the network should start the channel release procedure (see section 3.5).

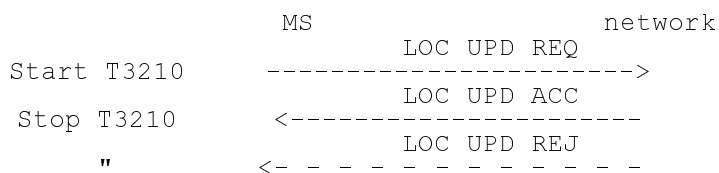

**Figure 4.5/GSM 04.08:  
Location updating sequence**

## 4.5 Connection management sublayer service provision

The concept of MM connection is introduced in this section. This concept is mainly a descriptive tool. The establishment of an MM connection by the network and the release of an MM connection by the network or by the Mobile Station is always local, i.e. these purposes can be achieved without sending any MM messages over the air interface. (On the contrary, establishment of an MM connection by the Mobile Station requires the sending of MM messages over the air interface.)

The Mobility Management (MM) sublayer is providing connection management services to the different entities of the upper Connection management (CM) sublayer (see GSM 04.07). It offers to a CM entity the possibility to use an MM connection for the exchange of information with its peer entity. An MM connection is established and released on request from a CM entity. Different CM entities communicate with their peer entity using different MM connections. Several MM connections may be active at the same time.

An MM connection requires an RR connection. All simultaneous MM connections for a given Mobile Station use the same RR connection.

In the following sections, the procedures for establishing, re-establishing, maintaining, and releasing an MM connection are described, usually separately for the mobile station and the network side.

### 4.5.1 MM connection establishment

#### 4.5.1.1 MM connection establishment initiated by the mobile station

Upon request of a CM entity to establish an MM connection the MM sublayer first decides whether to accept, delay, or reject this request:

- An MM connection establishment may only be initiated by the mobile station when the following conditions are fulfilled:
  - Its update status is UPDATED.
  - The MM sublayer is in one of the states MM IDLE or MM connection active.

An exception from this general rule exists for emergency calls (see section 4.5.1.5). A further exception is defined in the following clause.

- If an MM specific procedure is running at the time the request from the CM sublayer is received, and the LOCATION UPDATING REQUEST message has been sent, the request will either be rejected or delayed, depending on implementation, until the MM specific procedure is finished and, provided that the network has not sent a "follow-on proceed" indication, the RR connection is released. If the LOCATION UPDATING REQUEST message has not been sent, the mobile station may include a "follow-on request" indicator in the message. The mobile station shall then delay the request until the MM specific procedure is completed, when it may be given the opportunity by the network to use the RR connection (see section 4.4.4.6).

In order to establish an MM connection, the mobile station proceeds as follows:

- a) If no RR connection exists, the MM sublayer requests the RR sublayer to establish an RR connection and enters MM sublayer state WAIT FOR RR CONNECTION (MM CONNECTION). This request contains an establishment cause and a CM SERVICE REQUEST message. When the establishment of an RR connection is indicated by the RR sublayer (this indication implies that the CM SERVICE REQUEST message has been successfully transferred via the air interface, see section 2.2), the MM sublayer of the mobile station starts timer T3230, gives an indication to the CM entity that requested the MM connection establishment, and enters MM sublayer state WAIT FOR OUTGOING MM CONNECTION.
- b) If an RR connection is available, the MM sublayer of the mobile station sends a CM SERVICE REQUEST message to the network, starts timer T3230, gives an indication to the CM entity that requested the MM connection establishment, and enters:
  - MM sublayer state WAIT FOR OUTGOING MM CONNECTION, if no MM connection is active;

- MM sublayer state WAIT FOR ADDITIONAL OUTGOING MM CONNECTION, if at least one MM connection is active;
- If an RR connection exists but the mobile station is in the state WAIT FOR NETWORK COMMAND then any requests from the CM layer that are received will either be rejected or delayed until this state is left.

The CM SERVICE REQUEST message contains the:

- mobile identity according to section 10.5.1.4;
- mobile station classmark 2;
- ciphering key sequence number; and
- CM service type identifying the requested type of transaction (e.g. mobile originating call establishment, emergency call establishment, short message service, supplementary service activation).

Upon receiving a CM SERVICE REQUEST message, the network shall analyse its content. The type of semantic analysis may depend on other on going MM connection(s). Depending on the type of request and the current status of the RR connection, the network may start any of the MM common procedures and RR procedures.

The network may initiate the classmark interrogation procedure, for example, to obtain further information on the MS's encryption capabilities.

The identification procedure (see section 4.3.3) may be invoked for instance if a TMSI provided by the mobile station is not recognized.

The network may invoke the authentication procedure (see section 4.3.2) depending on the CM service type.

The network decides also if the ciphering mode setting procedure shall be invoked (see section 3.4.7).

An indication from the RR sublayer that the ciphering mode setting procedure is completed, or reception of a CM SERVICE ACCEPT message, shall be treated as a service acceptance indication by the mobile station. The MM connection establishment is completed, timer T3230 shall be stopped, the CM entity that requested the MM connection shall be informed, and MM sublayer state MM CONNECTION ACTIVE is entered. The MM connection is considered to be active.

If the service request cannot be accepted, the network returns a CM SERVICE REJECT message to the mobile station.

The reject cause information element (see 10.5.3.6 and annex G) indicates the reason for rejection. The following cause values may apply:

- #4 : IMSI unknown in VLR
- #6 : Illegal ME
- #17 : Network failure
- #22 : Congestion
- #32 : Service option not supported
- #33 : Requested service option not subscribed
- #34 : Service option temporarily out of order

If no other MM connection is active, the network may start the RR connection release (see section 3.5) when the CM SERVICE REJECT message is sent.

If a CM SERVICE REJECT message is received by the mobile station, timer T3230 shall be stopped, the requesting CM sublayer entity informed. Then the mobile station shall proceed as follows:

- If the cause value is not #4 or #6 the MM sublayer returns to the previous state (the state where the request was received). Other MM connections shall not be affected by the CM SERVICE REJECT message.

- If cause value #4 is received, the mobile station aborts any MM connection, deletes any TMSI, LAI and ciphering key sequence number in the SIM, changes the update status to NOT UPDATED (and stores it in the SIM according to section 4.1.2.2), and enters the MM sublayer state WAIT FOR NETWORK COMMAND. If subsequently the RR connection is released or aborted, this will force the mobile station to initiate a normal location updating). Whether the CM request shall be memorized during the location updating procedure, is a choice of implementation.
- If cause value #6 is received, the mobile station aborts any MM connection, deletes any TMSI, LAI and ciphering key sequence number in the SIM, changes the update status to ROAMING NOT ALLOWED (and stores it in the SIM according to section 4.1.2.2), and enters the MM sublayer state WAIT FOR NETWORK COMMAND. The mobile station shall consider the SIM as invalid until switch-off or the SIM is removed.

#### 4.5.1.2 Abnormal cases

Mobile station side:

- a) RR connection failure or IMSI deactivation.

If an RR connection failure occurs or the IMSI is deactivated during the establishment of an MM connection, the MM connection establishment is aborted, timer T3230 is stopped, and an indication is given to the CM entity that requested the MM connection establishment. This shall be treated as a rejection for establishment of the new MM connection, and the MM sublayer shall release all active MM connections.

- b) T3230 expiry.

If T3230 expires (i.e. no response is given but a RR connection is available) the MM connection establishment is aborted and the requesting CM sublayer is informed. If no other MM connection exists then the MS shall proceed as described in section 4.5.3.1 for release of the RR connection. Otherwise the mobile station shall return to the MM sublayer state where the request of an MM connection was received, i.e. to MM sublayer state MM connection active. Other ongoing MM connections (if any) shall not be affected.

- c) Reject cause values #95, #96, #97, #99, #100, #111 received.

The same actions as on timer expiry shall be taken by the Mobile station.

- d) Random access failure or RR connection establishment failure.

If the mobile station detects a random access failure or RR connection establishment failure during the establishment of an MM connection, it aborts the MM connection establishment and gives an indication to the CM entity that requested the MM connection establishment.

NOTE: Further actions of the mobile station depend on the RR procedures and MM specific procedures during which the abnormal situation has occurred and are described together with those procedures.

Network side:

- a) RR connection failure.

The actions to be taken upon RR connection failure within a MM common procedure are described together with that procedure. A RR connection failure occurring outside such MM common procedures, shall trigger the release of all active MM connections if any.

- b) Invalid message or message content.

Upon reception of an invalid initial message or a CM SERVICE REQUEST message with invalid content, a CM SERVICE REJECT message shall be returned with one of the following appropriate Reject cause indications:

# 95: Semantically incorrect message

# 96: Mandatory information element error

- # 97: Message type non-existent or not implemented
- # 99: Information element non-existent or not implemented
- # 100: Conditional IE error
- # 111: Protocol error, unspecified

When the CM SERVICE REJECT message has been sent, the network may start RR connection release if no other MM connections exist or if the abnormal condition also has influence on the other MM connections.

#### 4.5.1.3 MM connection establishment initiated by the network

When a CM sublayer entity in the network requests the MM sublayer to establish a MM connection, the MM sublayer will request the establishment of an RR connection to the RR sublayer if no RR connection to the desired mobile station exists. The MM sublayer is informed when the paging procedure is finished (see section 3.3.2).

When an RR connection is established (or if it already exists at the time the request is received), the MM sublayer may initiate any of the MM common procedures (except IMSI detach); it may request the RR sublayer to perform the RR classmark interrogation procedure, and/or the ciphering mode setting procedure.

When all MM and RR procedures are successfully completed which the network considers necessary, the MM sublayer will inform the requesting CM sublayer entity on the success of the MM connection establishment.

If an RR connection already exists and no MM specific procedure is running, the network may also establish a new MM connection by sending a CM message with a new PD/TI combination.

If the establishment of an RR connection is unsuccessful, or if any of the MM common procedures or the ciphering mode setting fail, this is indicated to the CM layer with an appropriate error cause.

If an RR connection used for a MM specific procedure exists to the mobile station, the CM request may be rejected or delayed depending on implementation. When the MM specific procedure has been completed, the network may use the same RR connection for the delayed CM request.

#### 4.5.1.4 Abnormal cases

The behaviour upon abnormal events is described together with the relevant RR procedure or MM common procedure.

#### 4.5.1.5 MM connection establishment for emergency calls

A MM connection for an emergency call may be established in all states of the mobility management sublayer which allow MM connection establishment for a normal originating call. In addition, establishment may be attempted in all service states where a cell is selected (see section 4.2.2). However, as a network dependent option, a MM connection establishment for emergency call may be rejected in some of the states.

When a user requests an emergency call establishment the Mobile station will send a CM SERVICE REQUEST message to the network with a CM service type information element indicating emergency call establishment. If the network does not accept the emergency call request, e.g., because IMEI was used as identification and this capability is not supported by the network, the network will reject the request by returning a CM SERVICE REJECT message to the Mobile Station.

The reject cause information element indicates the reason for rejection. The following cause values may apply:

- #3 "Illegal MS"
- #4 "IMSI unknown in VLR"
- #5 "IMEI not accepted"
- #6 "Illegal ME"
- #17 "Network failure"
- #22 "Congestion"

- #32 "Service option not supported"
- #34 "Service option temporarily out of order"

With the above defined exceptions, the procedures described for MM connection establishment in sections 4.5.1.1 and 4.5.1.2 shall be followed.

NOTE: Normally, the mobile station will be identified by an IMSI or a TMSI. However, if none of these identifiers is available in the mobile station, then the mobile station shall use the IMEI for identification purposes. The network may in that case reject the request by returning a CM SERVICE REJECT message with reject cause:  
#5 "IMEI not accepted".

#### 4.5.1.6 Call re-establishment

The re-establishment procedure allows a MS to resume a connection in progress after a radio link failure, possibly in a new cell and possibly in a new location area. The conditions in which to attempt call re-establishment or not depend on the call control state, see section 5.5.4 and, whether or not a cell allowing call re-establishment has been found (as described in GSM 05.08). MM connections are identified by their protocol discriminators and transaction identifiers: these shall not be changed during call re-establishment.

The re-establishment takes place when a lower layer failure occurs and at least one MM connection is active (i.e.. the mobile station's MM sublayer is either in state 6 "MM CONNECTION ACTIVE" or state 20 "WAIT FOR ADDITIONAL OUTGOING MM CONNECTION").

NOTE: During a re-establishment attempt the mobile station does not return to the MM IDLE state; thus no location updating is performed even if the mobile is not updated in the location area of the selected cell.

##### 4.5.1.6.1 Call re-establishment, initiation by the mobile station

NOTE: The network is unable to initiate call re-establishment.

If at least one request to re-establish an MM connection is received from a CM entity as a response to the indication that the MM connection is interrupted (see section 4.5.2.3.) the mobile station initiates the call re-establishment procedure. If several CM entities request re-establishment only one re-establishment procedure is initiated. If any CM entity requests re-establishment, then re-establishment of all transactions belonging to all Protocol Discriminators that permit Call Re-establishment shall be attempted.

Upon request of a CM entity to re-establish an MM connection the MM sublayer requests the RR sublayer to establish an RR connection and enters MM sublayer state WAIT FOR RE-ESTABLISH. This request contains an establishment cause and a CM REESTABLISHMENT REQUEST message. When the establishment of an RR connection is indicated by the RR sublayer (this indication implies that the CM REESTABLISHMENT REQUEST message has been successfully transferred via the air interface, see section 2.2), the MM sublayer of the mobile station starts timer T3230, gives an indication to all CM entities that are being re-established, and remains in the MM sublayer state WAIT FOR RE-ESTABLISH.

The CM REESTABLISHMENT REQUEST message contains the:

- mobile identity according to section 10.5.1.4;
- mobile station classmark 2;
- ciphering key sequence number.

NOTE: Whether or not a CM entity can request reestablishment depends upon the Protocol Discriminator. The specifications for Short Message Service (GSM 04.11) and Call Independent Supplementary Services (GSM 04.10) do not currently specify any reestablishment procedures.

Upon receiving a CM REESTABLISHMENT REQUEST message, the network shall analyse its content. Depending on the type of request, the network may start any of the MM common procedures and RR procedures.



The network may initiate the classmark interrogation procedure, for example, to obtain further information on the mobile station's encryption capabilities.

The identification procedure (see section 4.3.3) may be invoked.

The network may invoke the authentication procedure (see section 4.3.2).

The network decides if the ciphering mode setting procedure shall be invoked (see section 3.4.7).

An indication from the RR sublayer that the ciphering mode setting procedure is completed, or reception of a CM SERVICE ACCEPT message, shall be treated as a service acceptance indication by the mobile station. The MM connection reestablishment is completed, timer T3230 shall be stopped, all CM entities associated with the reestablishment shall be informed, and MM sublayer state MM CONNECTION ACTIVE is re-entered. All the MM connections are considered to be active.

If the network cannot associate the re-establishment request with any existing call for that MS, a CM SERVICE REJECT message is returned with the reject cause:

#38 "call cannot be identified"

If call re-establishment cannot be performed for other reasons, a CM SERVICE REJECT is returned, the appropriate reject cause may be any of the following (see annex G):

# 4 "IMSI unknown in VLR";  
 # 6 "illegal ME";  
 #17 "network failure";  
 #22 "congestion";  
 #32 "service option not supported";  
 #34 "service option temporarily out of order".

Whatever the reject cause a mobile station receiving a CM SERVICE REJECT as a response to the CM REESTABLISHMENT REQUEST shall stop T3230, release all MM connections and proceed as described in section 4.5.3.1. In addition:

- If cause value #4 is received, the mobile station deletes any TMSI, LAI and ciphering key sequence number in the SIM, changes the update status to NOT UPDATED (and stores it in the SIM according to section 4.1.2.2), and enters the MM sublayer state WAIT FOR NETWORK COMMAND. If subsequently the RR connection is released or aborted, this will force the mobile station to initiate a normal location updating). The CM reestablishment request shall not be memorized during the location updating procedure.
- If cause value #6 is received, the mobile station deletes any TMSI, LAI and ciphering key sequence number in the SIM, changes the update status to ROAMING NOT ALLOWED (and stores it in the SIM according to section 4.1.2.2), and enters the MM sublayer state WAIT FOR NETWORK COMMAND. The mobile station shall consider the SIM as invalid until switch-off or the SIM is removed.

#### 4.5.1.6.2 Abnormal cases

Mobile Station side:

- a) Random access failure or RR connection establishment failure.

If the mobile station detects a random access failure or RR connection establishment failure during the re-establishment of an MM connection, the re-establishment is aborted and all MM connections are released.

- b) RR connection failure.

If a RR connection failure occurs, timer T3230 is stopped, the re-establishment is aborted and all active MM connections are released.

- c) IMSI deactivation.

If the IMSI deactivated during the re-establishment attempt then timer T3230 is stopped, the re-establishment is aborted and all MM connections are released.

- d) T3230 expires.

If T3230 expires (i.e. no response is given but a RR connection is available) the re-establishment is aborted, all active MM connections are released and the mobile station proceeds as described in section 4.5.3.1.

- e) Reject causes #96, #97, #99, #100, #111 received.

The mobile station shall perform the same actions as if timer T3230 had expired.

Network side:

- a) RR connection failure.

If a RR connection failure occurs after receipt of the CM REESTABLISHMENT REQUEST the network shall release all MM connections.

- b) Invalid message content.

Upon reception an invalid initial of message or a CM REESTABLISHMENT REQUEST message with invalid content, a CM SERVICE REJECT message shall be returned with one of the following appropriate Reject cause indications:

- #96: Mandatory information element error
- #99: Information element non-existent or not implemented
- #100: Conditional IE error
- #111: Protocol error, unspecified

When the CM SERVICE REJECT message has been sent, the network shall release the RR connection.

#### 4.5.1.7 Forced release during MO MM connection establishment

If the Mobile Station's CM layer initiated the MM connection establishment but the CM layer wishes to abort the establishment prior to the completion of the establishment phase, the Mobile Station shall send a CM SERVICE ABORT message any time after the completion of the RR connection and not after the first CM message (e.g. SETUP) is sent.

If the first CM message has already been sent, the normal release procedure defined by the appropriate CM protocol applies and the CM SERVICE ABORT shall not be sent.

Sending of the CM SERVICE ABORT message is only allowed during the establishment of the first MM connection, where no other MM connection exists in parallel. If parallel MM connections exist already, a new connection establishment cannot be aborted and normal MM connection release according to section 4.5.3 applies after MM connection establishment.

Upon transmission of the CM SERVICE ABORT message the Mobile Station shall set timer T3240 and enter the state WAIT FOR NETWORK COMMAND, expecting the release of the RR connection.

Upon receipt of the CM SERVICE ABORT message the network shall abort ongoing processes, release the appropriate resources, and unless another MM connection establishment is pending, initiate a normal release of the RR connection.

If the RR connection is not released within a given time controlled by timer T3240, the Mobile Station shall abort the RR connection. In both cases, either after a RR connection release triggered from the network side or after a RR connection abort requested by the Mobile Station side the Mobile Station shall return to state MM IDLE; the service state depending upon the current update status as specified in section 4.2.3.

## **4.5.2 MM connection information transfer phase**

After the MM connection has been established, it can be used by the CM sublayer entity for information transfer. According to the protocol architecture described in GSM 04.07, each CM entity will have its own MM connection. These different MM connections are identified by the protocol discriminator PD and, additionally, by the transaction identifier TI.

All MM common procedures may be initiated at any time while MM connections are active. Except for Short Message Control which uses a separate layer 2 low priority data link, no priority mechanism is defined between the CM, MM and RR sublayer messages.

### **4.5.2.1 Sending CM messages**

A CM sublayer entity, after having been advised that a MM connection has been established, can request the transfer of CM messages. The CM messages passed to the MM sublayer are then sent to the other side of the interface with the PD and TI set according to the source entity.

### **4.5.2.2 Receiving CM messages**

Upon receiving a CM message, the MM sublayer will distribute it to the relevant CM entity according to the PD value and TI value. However, if the received CM message is the first for the MM connection (identified by PD and TI), the MM sublayer will in addition indicate to the CM entity that a new MM connection has been established.

### **4.5.2.3 Abnormal cases**

RR connection failure:

If the RR connection failure occurs during a RR or MM common procedure, the consequent actions are described together with that procedure.

In other cases the following applies:

Mobile station:

The MM sublayer shall indicate to all CM entities associated with active MM connections that the MM connection is interrupted, the subsequent action of the MM sublayer (call re-establishment, see section 4.5.1.6, or local release) will then depend on the decisions by the CM entities.

Network:

The MM sublayer shall locally release all active MM connections. As an option the network may delay the release of all or some of the MM connections to allow the mobile station to initiate call re-establishment.

### **4.5.3 MM connection release**

An established MM connection can be released by the local CM entity. The release of the CM connection will then be done locally in the MM sublayer, i.e. no MM message are sent over the air interface for this purpose.

#### **4.5.3.1 Release of associated RR connection**

If all MM connections are released by their CM entities, the Mobile station shall set timer T3240 and enter the state WAIT FOR NETWORK COMMAND, expecting the release of the RR connection.

In the network, if the last MM connection is released by its user, the MM sublayer may decide to release the RR connection by requesting the RR sublayer according to section 3.5. The RR connection may be maintained by the network, e.g. in order to establish another MM connection.

If the RR connection is not released within a given time controlled by the timer T3240, the mobile station shall abort the RR connection. In both cases, either after a RR connection release triggered from the network side or after a RR connection abort requested by the MS-side, the MS shall return to MM IDLE state; the service state depending upon the current update status as specified in section 4.2.3.

### **4.6 Receiving a MM STATUS message by a MM entity.**

If the MM entity of the Mobile Station receives a MM STATUS message no state transition and no specific action shall be taken as seen from the radio interface, i.e. local actions are possible.

The actions to be taken on receiving a MM STATUS message in the network are an implementation dependant option.

## 5 Elementary procedures for circuit-switched Call Control

### 5.1 Overview

#### 5.1.1 General

This section describes the call control (CC) protocol, which is one of the protocols of the Connection Management (CM) sublayer (see GSM 04.07).

Every mobile station must support the call control protocol. If a mobile station does not support any bearer capability at all then it shall respond to a SETUP message with a RELEASE COMPLETE message as specified in section 5.2.2.2.

In the call control protocol, more than one CC entity are defined. Each CC entity is independent from each other and shall communicate with the correspondent peer entity using its own MM connection. Different CC entities use different transaction identifiers.

With a few exceptions this ETS describes the call control protocol only with regard to two peer entities. The call control entities are described as communicating finite state machines which exchange messages across the radio interface and communicate internally with other protocol (sub)layers. This description is only normative as far as the consequential externally observable behaviour is concerned.

Certain sequences of actions of the two peer entities compose "elementary procedures" which are used as a basis for the description in this section. These elementary procedures may be grouped into the following classes:

- call establishment procedures;
- call clearing procedures;
- call information phase procedures;
- miscellaneous procedures.

The terms "mobile originating" or "mobile originated" (MO) are used to describe a call initiated by the mobile station. The terms "mobile terminating" or "mobile terminated" (MT) are used to describe a call initiated by the network.

Figure 5.1a/GSM 04.08 gives an overview of the main states and transitions on the MS side.

Figure 5.1b/GSM 04.08 gives an overview of the main states and transitions on the network side.





## 5.1.2 Call Control States

### 5.1.2.1 Call states at the Mobile Station side of the interface

The states which may exist on the Mobile Station side of the radio interface are defined in this section.

NOTE: States U0.1, U26, and U27 are GSM specific. All other states are CCITT defined.

#### 5.1.2.1.1 Null (State U0)

No call exists.

#### 5.1.2.1.2 MM Connection pending (U0.1)

This state exists for a mobile originating call, when the Mobile Station requests the establishment of a MM connection.

#### 5.1.2.1.3 Call initiated (U1)

This state exists for a mobile originating call, when the Mobile Station requests call establishment from the network.

#### 5.1.2.1.4 Mobile originating call proceeding (U3)

This state exists for a mobile originating call when the Mobile Station has received acknowledgement that the network has received all call information necessary to effect call establishment.

#### 5.1.2.1.5 Call delivered (U4)

This state exists for a mobile originating call, when the calling Mobile Station has received an indication that remote user alerting has been initiated.

#### 5.1.2.1.6 Call present (U6)

This state exists for a mobile terminating call when the Mobile Station has received a call establishment request but has not yet responded.

#### 5.1.2.1.7 Call received (U7)

This state exists for a mobile terminating call when the Mobile Station has indicated alerting but has not yet answered.

#### 5.1.2.1.8 Connect Request (U8)

This state exists for a mobile terminating call, when the Mobile Station has answered the call and is waiting to be awarded the call.

#### 5.1.2.1.9 Mobile terminating call confirmed (U9)

This state exists for a mobile terminating call when the Mobile Station has sent acknowledgement that the Mobile Station has received all call information necessary to effect call establishment.

#### 5.1.2.1.10 Active (U10)

This state exists for a mobile terminating call when the Mobile Station has answered the call. This state exists for a mobile originating call when the Mobile Station has received an indication that the remote user has answered the call.



**5.1.2.1.11 Disconnect request (U11)**

This state exists when the Mobile Station has requested the network to clear the end-to-end connection (if any) and is waiting for a response.

**5.1.2.1.12 Disconnect indication (U12)**

This state exists when the Mobile Station has received an invitation to disconnect because the network has disconnected the end-to-end connection (if any).

**5.1.2.1.13 Release request (U19)**

This state exists when the Mobile Station has requested the network to release and is waiting for a response.

**5.1.2.1.14 Mobile originating modify (U26)**

This state exists when the mobile station has sent a request to the network for a new mode but has not yet received an answer.

**5.1.2.1.15 Mobile terminating modify (U27)**

This state exists when the mobile station has received a request from the network for a new mode and has not yet sent a response to this request.

**5.1.2.2 Network call states**

NOTE: States N0.1, N26, N27, N28, N3a, N4,a, N7a, and N9a are GSM specific. All other states are CCITT defined.

The call states that may exist on the network side of the radio interface are defined in this section.

**5.1.2.2.1 Null (State N0)**

No call exists.

**5.1.2.2.2 MM connection pending (N0.1)**

This state exists for a mobile terminating call, when the network requests the establishment of a MM connection.

**5.1.2.2.3 Call initiated (N1)**

This state exists for a mobile originating call when the network has received a call establishment request but has not yet responded.

**5.1.2.2.4 Mobile originating call proceeding (N3)**

This state exists for a mobile originating call when the network has sent acknowledgement that the network has received all call information necessary to effect call establishment.

**5.1.2.2.5 Call delivered (N4)**

This state exists for a mobile originating call when the network has indicated that remote user alerting has been initiated.

**5.1.2.2.6 Call present (N6)**

This state exists for a mobile terminating call when the network has sent a call establishment request but has not yet received a satisfactory response.

**5.1.2.2.7 Call received (N7)**

This state exists for a mobile terminating call when the network has received an indication that the Mobile Station is alerting but has not yet received an answer.

**5.1.2.2.8 Connect request (N8)**

This state exists for a mobile terminating call when the network has received an answer but the network has not yet awarded the call.

**5.1.2.2.9 Mobile terminating call confirmed (N9)**

This state exists for a mobile terminating call when the network has received acknowledgement that the Mobile Station has received all call information necessary to effect call establishment.

**5.1.2.2.10 Active (N10)**

This state exists for a mobile terminating call when the network has awarded the call to the called Mobile Station. This state exists for a mobile originating call when the network has indicated that the remote user has answered the call.

**5.1.2.2.11 {Not used}**

**5.1.2.2.12 Disconnect indication (N12)**

This state exists when the network has disconnected the end- to-end connection (if any) and has sent an invitation to disconnect the Mobile Station to network connection.

**5.1.2.2.13 Release request (N19)**

This state exists when the network has requested the Mobile Station to release and is waiting for a response.

**5.1.2.2.14 Mobile originating modify (N26)**

This state exists when the network has received a request from the mobile station for a new mode but has not yet sent a response.

**5.1.2.2.15 Mobile terminating modify (N27)**

This state exists when the network has sent a request to the mobile station for a new mode but has not yet received an answer.

**5.1.2.2.16 Connect Indication (N28)**

This state exists for a mobile originating call when the network has indicated that the remote user has answered the call and the network is waiting for acknowledgement by the Mobile Station.

## 5.2 Call establishment procedures

Establishment of a call is initiated by request of upper layer in either the mobile station or the network; it consists of:

- the establishment of a CC connection between the mobile station and the network;
- the activation of the codec or interworking function.

Whenever it is specified in GSM 04.08, section 5 that the mobile station shall attach the user connection, this means that the mobile station shall activate the codec or interworking function as soon as an appropriate channel is available. The mobile station shall de-activate the codec or interworking function whenever an appropriate channel is no longer available. As soon as an appropriate channel is (again) available, the codec or interworking function shall be re-activated. If a new order to attach the user connection is received, the new order shall supersede the previous one.

A channel shall be considered as appropriate if it is consistent with the possibly negotiated bearer capability applicable for the actual phase of the call. The mobile station shall not consider a channel as not appropriate because the type of the channel (full rate/half rate) is not the preferred one. If:

- the user connection has to be attached but no appropriate channel is available for a contiguous time of 30 seconds; or if
- the codec or interworking function is de-activated for a contiguous time of 30 seconds;

then the mobile station may initiate call clearing.

Upon request of upper layers to establish a call, restricting conditions for the establishment of the call are examined. These restricting conditions concern the states of parallel CC entities and are defined elsewhere. If these restricting conditions are fulfilled, the call establishment is rejected. Otherwise a CC entity in state U0, "null", is selected to establish the call. It initiates the establishment by requesting the MM sublayer to establish an MM connection.

### 5.2.1 Mobile originating call establishment

The call control entity of the mobile station initiates establishment of a CC connection by requesting the MM sublayer to establish a mobile originating MM connection and entering the "MM connection pending" state. There are two kinds of a mobile originating call: basic call and emergency call. The request to establish an MM connection shall contain a parameter to specify whether the call is a basic or an emergency call. This information may lead to specific qualities of services to be provided by the MM sublayers. Timer T303 is started when the CM SERVICE REQUEST message is sent.

While being in the "MM connection pending" state, the call entity of the mobile station may cancel the call prior to sending the first call control message according to the rules given in section 4.5.1.7.

#### 5.2.1.1 Call initiation

Having entered the "MM connection pending" state, upon MM connection establishment, the call control entity of the mobile station sends a setup message to its peer entity. This setup message is:

- a SETUP message, if the call to be established is a basic call; and
- an EMERGENCY SETUP message, if the call to be established is an emergency call.

It then enters the "call initiated" state. This state is supervised by timer T303, which has already been started after entering the "MM connection pending" state.

The setup message shall contain all the information required by the network to process the call. In particular, the SETUP message shall contain the called party address information.

When the call control entity of the mobile station is in the "call initiated" state and if it receives:

- i) a CALL PROCEEDING message, it shall proceed as described in section 5.2.1.3;
- ii) an ALERTING message, it shall proceed as described in section 5.2.1.5;

- iii) a CONNECT message, it shall proceed as described in section 5.2.1.6;
- iv) a RELEASE COMPLETE message it shall proceed as described in section 5.2.1.2.

Abnormal case:

Since timer T303 is used to supervise the two consecutive states "MM connection pending" and "call initiated", the expiry of timer T303 leads to different actions depending on the respective state:

- If timer T303 elapses in the "MM connection pending" state, the MM connection in progress shall be aborted and the user shall be informed about the rejection of the call.
- If timer T303 elapses in the "call initiated" state before any of the CALL PROCEEDING, ALERTING, CONNECT or RELEASE COMPLETE messages has been received, the clearing procedure described in section 5.4 is performed.

### 5.2.1.2 Receipt of a setup message

In the "null" state, upon receipt of a setup message (a SETUP message or an EMERGENCY SETUP message, see section 5.2.1.1), the call control entity of the network enters the "call initiated" state. It shall then analyse the call information contained in the setup message.

- i) If, following the receipt of the setup message, the call control entity of the network determines that the call information received from the mobile station is invalid (e.g. invalid number), then the network shall initiate call clearing as defined in section 5.4 with one of the following cause values:

- # 1 "unassigned (unallocated) number"
- # 3 "no route to destination"
- # 22 "number changed"
- # 28 "invalid number format (incomplete number)"

- ii) If, following the receipt of the setup message, the call control entity of the network determines that a requested service is not authorized or is not available, it shall initiate call clearing in accordance with section 5.4.2 with one of the following cause values:

- # 8 "operator determined barring"
- # 57 "bearer capability not authorized"
- # 58 "bearer capability not presently available"
- # 63 "service or option not available, unspecified"
- # 65 "bearer service not implemented"

- iii) Otherwise, the call control entity of the network shall either:

- send a CALL PROCEEDING message to its peer entity to indicate that the call is being processed; and enter the "mobile originating call proceeding" state;
- or: send an ALERTING message to its peer entity to indicate that alerting has been started at the called user side; and enter the "call received" state;
- or: send a CONNECT message to its peer entity to indicate that the call has been accepted at the called user side; and enter the "connect request" state.

The call control entity of the network may insert bearer capability information element(s) in the CALL PROCEEDING message to select options presented by the Mobile Station in the Bearer Capability information element(s) of the SETUP message. The bearer capability information element(s) shall contain the same parameters as received in the SETUP except those presenting a choice. Where choices were offered, appropriate parameters indicating the results of those choices shall be included.

The call control entity of the network having entered the "mobile originating call proceeding" state, the network may initiate the assignment of a traffic channel according to section 5.2.1.9 (early assignment).

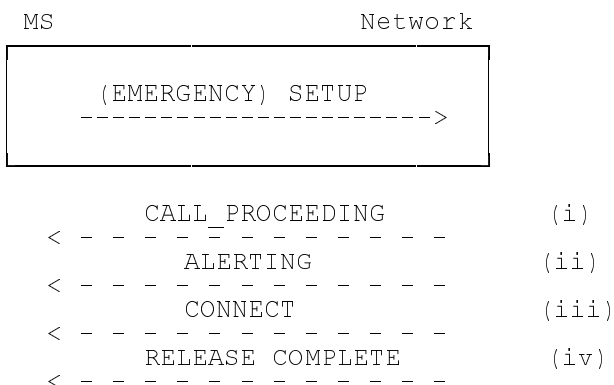

**Figure 5.2/GSM 04.08:**  
**Mobile originated call initiation and possible subsequent responses**

**5.2.1.3 Receipt of a CALL PROCEEDING message**

Having entered the "call initiated" state, when the call control entity of the mobile station receives a CALL PROCEEDING message, it shall stop timer T303; start timer T310 unless:

- the CALL PROCEEDING message contains a *progress indicator* IE specifying progress description #1 or #2;
- or it has received a PROGRESS message containing a *progress indicator* IE specifying progress description #1 or #2 prior to the CALL PROCEEDING message;

and enter the "mobile originating call proceeding" state.

Abnormal case:

If timer T310 elapses before any of the ALERTING, CONNECT or DISCONNECT messages has been received, the mobile station shall perform the clearing procedure described in section 5.4.



**Figure 5.3/GSM 04.08:**  
**Call proceeding sequence at mobile originating call establishment**

#### 5.2.1.4 Notification of progressing mobile originated call

In this section, the term "interworking" is used only in the meaning of interworking with a network other than PLMN or ISDN, not as interworking between PLMN and ISDN since this is the normal case. In this sense, PLMN and ISDN are seen within the same environment, called the PLMN/ISDN environment.

##### 5.2.1.4.1 Notification of interworking in connection with mobile originated call establishment

During call establishment, the call may leave a PLMN/ISDN environment; e.g., because of interworking with another network, with a non-PLMN/ISDN user, or with non-PLMN/ISDN equipment within the called user's premises; the call may also return to a PLMN/ISDN environment. When such situations occur, the network may send a *progress indicator* information element to the calling mobile station either:

- a) in an appropriate call control message, if a state change is required (e.g. ALERTING or CONNECT); or,
- b) in the PROGRESS message, if no state change is appropriate.

This *progress indicator* information element shall contain one of the following progress description values:

- a) #1 "call is not end-to-end PLMN/ISDN; further call progress information may be available in-band".
- b) #2 "destination address is non-PLMN/ISDN".
- c) #4 "call has returned to PLMN/ISDN".

See also sections 5.5.1 and 5.5.6 for further reactions of the mobile station.

##### 5.2.1.4.2 Call progress in the PLMN/ISDN environment

In order to inform the mobile station that the call is progressing in the PLMN/ISDN environment the network may send a *progress indicator* information element to the calling mobile station either:

- a) in an appropriate call control message, if a state change is required (e.g., ALERTING or CONNECT); or
- b) in the PROGRESS message, if no state change is appropriate.

This *progress indicator* information element shall contain progress description value #32 "Call is end-to-end ISDN/PLMN". See also section 5.5.6 for further reactions of the mobile station.

#### 5.2.1.5 Alerting

Having entered the "mobile originating call proceeding" state, upon receiving an indication that user alerting has been initiated at the called address, the call control entity of the network shall: send an ALERTING message to its peer entity at the calling mobile station and enter the "call delivered" state.

When the call control entity of the mobile station in the "call initiated" state or "mobile originating call proceeding" state receives an ALERTING message then, the call control entity of the mobile station shall stop timer T303 and T310 (if running) and shall enter the "call delivered" state. In this state, for speech calls:

- an alerting indication should be given to the user. If the mobile station has not attached the user connection then the mobile station shall internally generate an alerting indication. If the mobile station has attached the user connection then the network is responsible for generating the alerting indication and the mobile station need not generate one.

Abnormal cases:

On the mobile station side, if timer T310 expires, the call control entity of the mobile station shall initiate call clearing as described in section 5.4.



**Figure 5.4/GSM 04.08:  
Call confirmation  
at mobile originating call establishment**

**5.2.1.6 Call connected**

Upon receiving an indication that the call has been accepted, the call control entity of the network shall: through connect the traffic channel (including the connection of an interworking function, if required) and send a CONNECT message to its peer entity at the calling mobile station; start timer T313 and enter the "connect indication" state.

This message indicates to the call control entity of the calling mobile station that a connection has been established through the network.

The call control entity of the mobile station in the "call initiated" state, in the "mobile originating call proceeding" state or in the "call delivered" state, shall, upon receipt of a CONNECT message:

- attach the user connection;
- return a CONNECT ACKNOWLEDGE message;
- stop any locally generated alerting indication (if applied);
- stop timer T303 and T310 (if running);
- enter the "active" state.

Abnormal cases:

On the mobile station side, if timer T303 or T310 expires, the call control entity of the mobile station shall initiate call clearing as described in section 5.4.

NOTE: The mobile station may have applied an additional internal alerting supervision which causes initiation of call clearing prior to the expiry of T303 or T310.

The call control of the network in the "connect indication" state, shall, upon receipt of a CONNECT ACKNOWLEDGE message:

- stop timer T313 and enter the "active" state.

Abnormal cases:

On the network side, if timer T313 elapses before a CONNECT ACKNOWLEDGE message has been received, the network shall perform the clearing procedure as described in section 5.4.

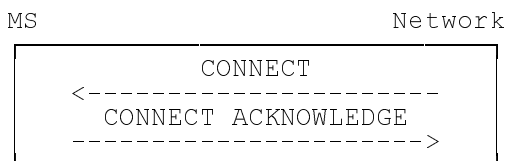

**Figure 5.5/GSM 04.08:  
Call acceptance sequence  
at mobile originating call establishment**

### 5.2.1.7 Call rejection

Upon receiving an indication that the network or the called user is unable to accept the call, the network shall initiate call clearing at the radio interface to the mobile which originated the call, as described in section 5.4 using the cause provided by the terminating network or the called user.

### 5.2.1.8 Transit network selection

NOTE: For further study.

### 5.2.1.9 Traffic channel assignment at mobile originating call establishment

It is a network dependent decision when to initiate the assignment of an appropriate traffic channel during the mobile originating call establishment phase. Initiation of a suitable RR procedure to assign an appropriate traffic channel does neither change the state of a call control entity nor affect any call control timer.

NOTE: During certain phases of such an RR procedure, transmission of CC and MM messages may be suspended, see GSM 04.08, section 3 and GSM 08.08.

The assignment procedure does not affect any call control timer.

### 5.2.1.10 Call queuing at mobile originating call establishment

The conditions to apply queuing are described in GSM 03.01.

If an idle traffic channel is not available at the assignment instant, the network may place the traffic channel request in a queue. Calls arriving when all positions in the queue are occupied shall be cleared by the network using the cause #34 "no circuit/channel available".

An explicit queuing indicator is not provided to the mobile station.

The maximum queuing interval is supervised by the network. The limit is a network dependent choice. In case the network is not able to allocate a traffic channel within the queuing limit, the network will release the call using cause #34 "no circuit/channel available".

Specific indications provided in the network to the remote user are a network dependent choice.

## 5.2.2 Mobile terminating call establishment

Before call establishment can be initiated in the Mobile station, the MM connection must be established by the network.

### 5.2.2.1 Call indication

After the arrival of a call from a remote user, the corresponding call control entity in the network shall: initiate the MM connection establishment according to section 4 and enter the "MM connection pending" state. The request to establish the MM connection is passed from the CM sublayer to the MM sublayer. It contains the necessary routing information derived from the SETUP message.

Upon completion of the MM connection, the call control entity of the network shall: send the SETUP message to its peer entity at the Mobile Station, start timer T303 and enter the "call present" state.

Upon receipt of a SETUP message, the Mobile Station shall perform compatibility checking as described in 5.2.2.2. If the result of the compatibility checking was compatibility, the call control entity of the Mobile Station shall enter the "call present" state. An incompatible Mobile Station shall respond with a RELEASE COMPLETE message in accordance with section 5.2.2.3.4.



If no response to the SETUP message is received by the call control entity of the network before the expiry of timer T303, the procedures described in section 5.2.2.3.3 shall apply.

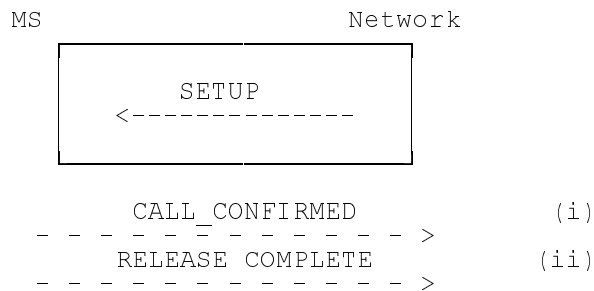

**Figure 5.6/GSM 04.08:**  
**Mobile terminating call initiation and possible subsequent responses**

### 5.2.2.2 Compatibility checking

The Mobile Station receiving a SETUP message shall perform compatibility checking before responding to that SETUP message. annex B defines compatibility checking to be performed by the mobile station upon receiving a SETUP message.

### 5.2.2.3 Call confirmation

#### 5.2.2.3.1 Response to SETUP

Having entered the "call present state" the call control entity of the Mobile Station shall - with the exception of the cases described below - acknowledge the SETUP message by a CALL CONFIRMED message, and enter the "mobile terminating call confirmed" state.

The call control entity of the Mobile Station may include in the CALL CONFIRMED message to the network one or two bearer capability information elements to the network, either preselected in the Mobile Station or corresponding to a service dependent directory number (see GSM 09.07). The Mobile Station may also include one or two bearer capabilities in the CALL CONFIRMED message to define the radio channel requirements. In any case the rules specified in section 9.3.2.2 shall be followed.

**NOTE:** The possibility of alternative responses (e.g., in connection with supplementary services) is for further study.

A busy Mobile Station which satisfies the compatibility requirements indicated in the SETUP message shall respond either with a CALL CONFIRMED message if the call setup is allowed to continue or a RELEASE COMPLETE message if the call setup is not allowed to continue, both with cause #17 "user busy".

If the mobile user wishes to refuse the call, a RELEASE COMPLETE message shall be sent with the cause #21 "call rejected" .

In the cases where the Mobile Station responds to a SETUP message with RELEASE COMPLETE message the Mobile Station shall release the MM connection and enter the "null" state after sending the RELEASE COMPLETE message.

The network shall process the RELEASE COMPLETE message in accordance with section 5.4.

#### 5.2.2.3.2 Receipt of CALL CONFIRMED and ALERTING by the network

The call control entity of the network in the "call present" state, shall, upon receipt of a CALL CONFIRMED message: stop timer T303, start timer T310 and enter the "mobile terminating call confirmed" state.

The call control entity of the Mobile Station having entered the "mobile terminating call confirmed" state, if the call is accepted at the called user side, the Mobile Station proceeds as described in 5.2.2.5. Otherwise, if the signal information element was present in the SETUP message user alerting is initiated at the Mobile Station side; if the signal information element was not present in the SETUP message, user alerting is initiated when an appropriate channel is available.

Here, initiation of user alerting means:

- the generation of an appropriate tone or indication at the Mobile Station; and
- sending of an ALERTING message by the call control entity of the Mobile Station to its peer entity in the network and entering the "call received" state.

The call control entity of the network in the "mobile terminated call confirmed" state shall, upon receipt of an ALERTING message: send a corresponding ALERTING indication to the calling user; stop timer T310; start timer T301, and enter the "call received" state.

In the "mobile terminating call confirmed" state or the "call received" state, if the user of a Mobile Station is User Determined User Busy then a DISCONNECT message shall be sent with cause #17 "user busy". In the "mobile terminating call confirmed" state, if the user of a Mobile station wishes to reject the call then a DISCONNECT message shall be sent with cause #21 "call rejected".

#### 5.2.2.3.3 Call failure procedures

In case of abnormal behaviour the following call failure procedures apply:

- i. If the network does not receive any response to the SETUP message prior to the expiration of timer T303, then the network shall: initiate clearing procedures towards the calling user with cause #18 "no user responding"; and initiate clearing procedures towards the called Mobile Station in accordance with 5.4.4 using cause #102 "recovery on timer expiry".
- ii. If the network has received a CALL CONFIRMED message, but does not receive an ALERTING, CONNECT or DISCONNECT message prior to the expiration of timer T310, then the network shall:
  - initiate clearing procedures towards the calling user with cause #18 "no user responding"; and
  - initiate clearing procedures towards the called Mobile Station in accordance with section 5.4.4 using cause #102 "recovery on timer expiry".
- iii. If the network has received an ALERTING message, but does not receive a CONNECT or DISCONNECT message prior to the expiry of timer T301 (or a corresponding internal alerting supervision timing function), then the network shall: initiate clearing procedures towards the calling user with cause #19 "user alerting, no answer"; and initiate clearing procedures towards the called Mobile Station in accordance with section 5.4.4, using cause #102 "recovery on timer expiry" or using cause #31 "normal, unspecified".

NOTE: The choice between cause #31 and cause #102 may have consequences on indications generated by the mobile station (see GSM 02.40).

#### 5.2.2.3.4 Called Mobile Station clearing during mobile terminating call establishment

See section 5.4.2.

#### 5.2.2.4 Notification of interworking in connection with mobile terminating call establishment

In this section, the term "interworking" is used only in the meaning of interworking with a network other than PLMN or ISDN, not as interworking between PLMN and ISDN since this is the normal case. In this sense, PLMN and ISDN are seen within the same environment, called the PLMN/ISDN environment.

During call establishment the call may enter an PLMN/ISDN environment, e.g., because of interworking with another network, with a non-PLMN/ISDN user, or with non-PLMN/ISDN equipment within the calling or called user's premises. When this occurs, the network may include a *progress indicator* information element to be included in the SETUP message to be sent to the called mobile station specifying progress description value

- a) #1 "call is not end-to-end PLMN/ISDN; further call progress information may be available in-band";  
or
- b) #3 "origination address is non-PLMN/ISDN".

See also section 5.5.1 for further reactions of the mobile station.

### 5.2.2.5 Call accept

In the "mobile terminating call confirmed" state or the "call received" state, the call control entity in the Mobile Station indicates acceptance of a mobile terminating call by:

- sending a CONNECT message to its peer entity in the network;
- starting Timer T313; and
- entering the "connect request" state.

### 5.2.2.6 Active indication

In the "mobile terminated call confirmed" state or in the "call received" state, the call control entity of the network shall, upon receipt of a CONNECT message: through connect the traffic channel (including the connection of an interworking function, if required), stop timers T310, T303 or T301 (if running); send a CONNECT ACKNOWLEDGE message to its peer entity at the Mobile Station of the called user; initiate procedures to send a CONNECT message towards the calling user and enter the "active" state.

In the "connect request" state, the call control entity of the Mobile Station shall, upon receipt of a CONNECT ACKNOWLEDGE message: stop timer T313 and enter the "active" state.

When timer T313 expires prior to the receipt of a CONNECT ACKNOWLEDGE message, the mobile station shall initiate clearing in accordance with section 5.4.3.

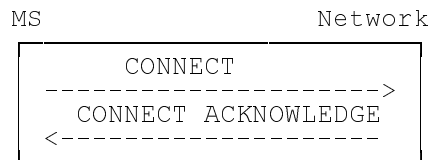

**Figure 5.7/GSM 04.08:**  
**Call acceptance and active indication at mobile terminating call establishment**

### 5.2.2.7 Traffic channel assignment at mobile terminating call establishment

It is a network dependent decision when to initiate the assignment of a traffic channel during the mobile terminating call establishment phase.

Initiation of the assignment phase does not directly change the state of a CC entity nor affect any call control timer, but may have such secondary effects (see e.g. subclause 5.2.2.3.2).

#### **5.2.2.8 Call queuing at mobile terminating call establishment**

The principles described in section 5.2.1.1.10 apply accordingly.

NOTE: The interworking to the fixed network has to fulfil the network specific requirements.

#### **5.2.2.9 User connection attachment during a mobile terminating call**

For speech calls:

The mobile station shall attach the user connection at latest when sending the connect message.

For data calls:

The mobile station shall attach the user connection when receiving the CONNECT ACKNOWLEDGE message from the network.

### 5.3 Signalling procedures during the "active" state

#### 5.3.1 User notification procedure

The mobile terminating user notification procedure allows the network to notify a mobile station of any appropriate call-related event during the "active" state of a call. The procedure consists in the network sending a NOTIFY message to the mobile station. No state change occurs at any of the interface sides following the sending or the receipt of this message (but an appropriate indication may optionally be generated in the mobile station).

The mobile originating notification procedure allows the mobile station to notify the remote user of any appropriate call-related event during the "active" state of a call by sending a NOTIFY message containing a notification indicator to the network; upon receipt of this message, the network sends a NOTIFY message containing the same notify indicator to the other user involved in the call. No state change occurs at any of the interface sides following the sending or the receipt of this message.

#### 5.3.2 Call rearrangements

Call rearrangements on the air interface are not supported by explicit messages (e.g. SUSPEND and RESUME messages as defined in ETS 300 102-1). However if a remote non-PLMN user initiates call rearrangements, the network shall inform the Mobile Station by means of a NOTIFY message. In a similar way the Mobile Station can inform the network about rearrangements by sending a NOTIFY message (e.g. change of user equipment connected to the Mobile Station).

#### 5.3.3 Not used

#### 5.3.4 Support of Dual Services

The behaviour described in this section is used to realize the following required services throughout section 5.3.4. The mobile station is not obliged to support the network originated in-call modification procedure. In that case, the mobile station shall, when receiving a MODIFY message, treat the message as unknown and react as described in section 8.4. If the mobile station is already prepared to support the procedure in both directions, it shall act as described in this section.

- a) Alternate Speech/Data (BS 61 according to GSM 02.02).
- b) Speech followed by Data (BS 81 according to GSM 02.02).
- c) Alternate Speech/Group 3 fax (Teleservice 61 according to GSM 02.03).

##### 5.3.4.1 Service Description

This circuit switched service allows the two users on a point-to-point connection to use the connection between them for different information transfer during the same call, but not at the same time.

If the negotiation during call establishment leads to the recognition of the above mentioned services, the in-call modification procedure is allowed to be executed within the current call by changing from one call mode to the other.

In some cases the in-call modification procedure makes it necessary to change the channel configuration by allocating a new channel and in other cases to change channel configuration parameters while keeping the previously allocated channel. This change is determined by the network, which initiates either the channel assignment procedure, handover procedure or channel mode modify procedure (see section 3).

The capability and the initial mode desired must be identified by the mobile station by identifying each mode of operation with a separate information element during call establishment. Further the type of change between the modes must be identified by means of the repeat indicator:

mode 1 "alternate" mode 2; or  
mode 1 "and then" mode 2.

### 5.3.4.2 Call establishment

For both mobile originating and mobile terminating calls, the normal call establishment procedures apply.

#### 5.3.4.2.1 Mobile Originating Establishment

The service is requested by the originating mobile station by transferring a SETUP message to the network containing the *BC repeat indicator* IE, the *bearer capability 1* information element, and the *bearer capability 2* information element. The first mode of operation ("call mode") shall be indicated by the *bearer capability 1* information element and the second call mode by the *bearer capability 2* information element.

A low layer compatibility may optionally be specified for each call mode in a *low layer compatibility I* and *low layer compatibility II* information element. In that case:

- The SETUP message shall contain the *LLC repeat indicator* IE and both *low layer compatibility I* and *low layer compatibility II* information elements. The *low layer compatibility I* information element then corresponds to the *bearer capability 1* information element and the *low layer compatibility II* information element to the *bearer capability 2* information element.
- If no low layer compatibility specification applies for one of the two call modes, the corresponding low layer compatibility IE (*low layer compatibility I* or *low layer compatibility II*) shall indicate "not applicable".
- The *LLC repeat indicator* shall specify the same repeat indication as the *BC repeat indicator* IE.

Similarly, a high layer compatibility may optionally be specified for each call mode in a *high layer compatibility i* and *high layer compatibility ii* information element. In that case:

- The SETUP message shall contain the *HLC repeat indicator* IE and both *high layer compatibility i* and *high layer compatibility ii* information elements. The *high layer compatibility i* information element then corresponds to the *bearer capability 1* information element and the *high layer compatibility ii* information element to the *bearer capability 2* information element.
- If no high layer compatibility specification applies for one of the two call modes, the corresponding high layer compatibility IE (*high layer compatibility i* or *high layer compatibility ii*) shall indicate "not applicable".
- The *HLC repeat indicator* shall specify the same repeat indication as the *BC repeat indicator* IE.

The receiving entity shall ignore whether the *LLC repeat indicator* IE or *HLC repeat indicator* are contained in the message or not; it shall also ignore the repeat indication of an *LLC repeat indicator* IE or *HLC repeat indicator* IE. If the *low layer compatibility II* IE is not contained in the message and the *low layer compatibility I* IE is contained in the message, the receiving entity shall relate it to a call mode indicated in the message that does not specify speech (if any). If the *high layer compatibility ii* IE is not contained in the message and the *high layer compatibility i* IE is contained in the message, the receiving entity shall relate it to a call mode indicated in the message that does not specify speech (if any).

The specific part of the network which is sensitive to the call mode shall examine each mode described in the bearer capabilities included in the SETUP message by performing compatibility checking as defined in annex B. If as a result of this compatibility checking the network decides to reject the call, then the network shall initiate call clearing as specified in section 5.4 with the following causes:

- a) #57 "bearer capability not authorized"
- b) #58 "bearer capability not presently available"
- c) #65 "bearer service not implemented"
- d) #70 "only restricted digital information bearer capability is available"

#### 5.3.4.2.2 Mobile Terminating Establishment

The service is indicated to the called mobile station by a SETUP message coded in the same manner as in the mobile originating call establishment. As specified for normal terminating call establishment, the service may be indicated by the called mobile station in the CALL CONFIRMED message.

The destination mobile station shall perform the compatibility checking as defined in annex B for both required modes if indicated in the SETUP message. If as a result of compatibility checking the mobile station decides to reject the call, the mobile station shall initiate call clearing according to the procedures of section 5.4 with one of the following causes:

- a) #57 "bearer capability not authorized"
- b) #58 "bearer capability not presently available"
- c) #65 "bearer service not implemented"
- d) #88 "incompatible destination"

The mobile station may accept the call if the first mode indicated is free irrespective of whether the other mode is free or busy.

#### 5.3.4.3 Changing the Call Mode

In order to change the call mode, the following in-call modification procedures shall be used.

Either side of the radio interface may act as the requesting user to invoke the in-call modification.

Upon each successful completion of the in-call modification procedure, the call changes to the next mode negotiated and agreed during the establishment phase of the call.

The in-call modification procedures are completely symmetrical at the radio interface.

NOTE: Considering a possible future evolution, in-call modification is specified as a symmetrical procedure.

##### 5.3.4.3.1 Initiation of in-call modification

The procedure is initiated by the requesting originating side in the "active" state of the call. It shall send a MODIFY message including the new mode to be changed to; start timer T323; and enter the "mobile originating modify" state (mobile station side) or the "mobile terminating modify" state (network side). Any internal resources necessary to support the next call mode shall be reserved. The new mode given in the MODIFY message shall be one of those already negotiated and agreed during the establishment phase of the call. If the data call direction is different from the direction of the call setup a reverse call setup direction IE shall be included in the MODIFY message; otherwise this IE shall not be included. The MODIFY originating side shall stop sending Bm-channel information; and stop interpreting received Bm-channel information according to the old call mode.

Upon receipt of the MODIFY message, the destination side shall check to ensure that the requested call mode can still be supported and if so, it shall initiate the reservation of any resources necessary to support the next call mode and enter the "mobile originating modify" (network side) or "mobile terminating modify" state (mobile station side).

##### 5.3.4.3.2 Successful completion of in-call modification

If the destination network/Mobile Station receives a MODIFY message with a new mode which is already the actual one of the call the network/Mobile Station shall remain in the "active" state; send a MODIFY COMPLETE message with the actual mode; and shall not initiate anything else.

If the requested mode is not the actual one and can be supported by the destination interface it shall change the channel configuration, if required, and step on to any internal resources necessary to support the next call mode. If the requested mode is a data or facsimile mode, it shall also perform the appropriate means to take the direction of the data call into account. After successful change of the channel configuration it shall start sending user information according to the next call mode and start interpreting received user channel information according to the next call mode; send a MODIFY COMPLETE



message with the new call mode included and enter the "active" state (mobile station or network side). If the MODIFY message had contained a *reverse call setup direction* IE, the same IE shall be included in the MODIFY COMPLETE message.

In case of an alternate speech/data or alternate speech/facsimile group 3 service (refer to section 5.3.4) the old resources may still be kept reserved, in case of speech followed by data service they may be released.

Upon receipt of the MODIFY COMPLETE message the originating side shall: initiate the alternation to those resources necessary to support the next call mode; stop timer T323; and enter the "active" state (mobile station or network side). The reaction of the originating side if it had included a reverse call setup direction IE in the MODIFY message, but the destination side did not include the IE in the MODIFY COMPLETE message is implementation dependent.

#### **5.3.4.3.3 Change of the channel configuration**

In case the requested bearer capability cannot be supported by the current channel configuration the network shall initiate the assignment procedure and change the channel configuration accordingly.

#### **5.3.4.3.4 Failure of in-call modification**

##### **5.3.4.3.4.1 Network rejection of in-call modification**

If the network cannot support the change to the requested call mode or if the change of the channel configuration fails the network shall: release the resources which had been reserved for the alternation; send a MODIFY REJECT message with the old bearer capability and with cause # 58 "bearer capability not presently available" to the initiating mobile station; and enter the "active" state. If the change of the channel configuration fails, the network shall return to the internal resources required for the old call mode.

Upon receipt of the MODIFY REJECT message with the old bearer capability the initiating mobile station shall: stop timer T323; release any resources which had been reserved for the alternation; resume sending user channel information according to the present call mode; resume interpreting received user channel information according to the present call mode; and enter the "active" state.

##### **5.3.4.3.4.2 Mobile Station rejection of in-call modification**

If the mobile station cannot support the change to the requested call mode, the mobile station shall: release any resources which had been reserved for the alternation; send a MODIFY REJECT message with the old bearer capability and cause # 58 "bearer capability not presently available", and enter the "active" state.

Upon receipt of the MODIFY REJECT message the network shall: stop timer T323, release any resources which had been reserved for the alternation.

##### **5.3.4.3.4.3 Time-out recovery**

Upon expiration of T323 in either the Mobile Station or the network the procedures for call clearing shall be initiated with cause # 102 "recovery on timer expiry".

#### **5.3.4.4 Abnormal procedures**

If a MODIFY, MODIFY COMPLETE or MODIFY REJECT message is received in the "disconnect indication", "disconnect request" (mobile station side only) or "release request" state then the received message shall be discarded and no action shall be taken.

If a MODIFY COMPLETE message indicating a call mode which does not correspond to the requested one is received or if a MODIFY REJECT message indicating a call mode which does not correspond to the actual one is received then the received message shall be discarded and no action shall be taken.

If a MODIFY message indicating a call mode which does not belong to those negotiated and agreed during the establishment phase of the call, is received, then a MODIFY REJECT message with the actual call mode and with cause # 57 "bearer capability not authorized" shall be sent back.

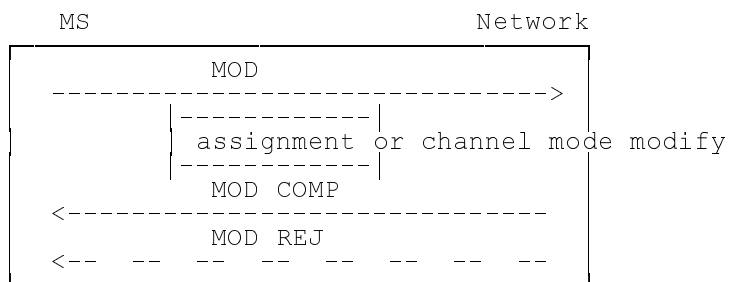

**Figure 5.10a/GSM 04.08:**  
**In-call modification sequence initiated by MS**

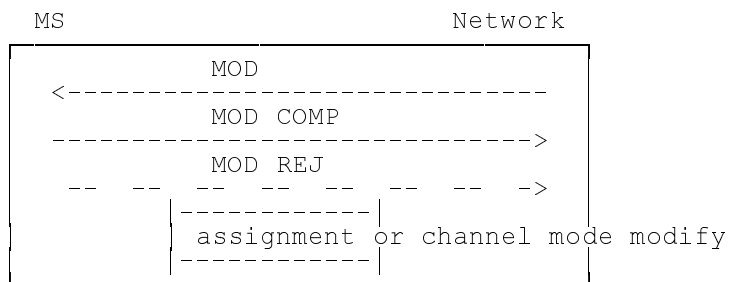

**Figure 5.10b/GSM 04.08:**  
**In-call modification sequence initiated by network**

## 5.4 Call clearing

### 5.4.1 Terminology

The following terms are used in this ETS in the description of clearing procedures:

- A traffic channel (see GSM 04.03) is "connected" when the channel is part of a circuit-switched connection established according to this Technical Specification.
- A traffic channel is "disconnected" when the channel is no longer part of a circuit-switched connection, but is not yet available for use in a new connection.

### 5.4.2 Exception conditions

Under normal conditions, the call control entity of the Mobile Station or of the network initiates call clearing by sending a DISCONNECT message to its peer entity; then both entities follow the procedures defined in sections 5.4.3 and 5.4.4 respectively.

As an exception to the above rule, the call control entity of the Mobile Station or of the network, in response to a SETUP message, can reject a call by stopping all running call control timers, responding with a RELEASE COMPLETE message, releasing the MM connection, and returning to the "null" state, provided no other response has previously been sent.

As a further exception, the call control entity of the network may initiate call clearing by stopping all running call control timers, sending a RELEASE message, starting timer T308, and entering the "release request" state.

NOTE: This way to initiate call clearing by sending a RELEASE message should not be used by the network:

- if in-band tones/announcements are provided and the network decides to use the procedure described in section 5.4.4.1;
- if the network wants to have the opportunity to respond to information sent by the mobile station during call clearing.

A call control entity shall accept an incoming RELEASE COMPLETE message used to initiate the call clearing even though the cause information element is not included.

A control entity shall accept an incoming RELEASE message used to initiate the call clearing even though the cause information element is not included.

Furthermore, a call control entity shall regard an incoming RELEASE COMPLETE message as consistent with any of its states; a call control entity shall regard an incoming RELEASE message as consistent with any of its states except the null state; a call control entity of the MOBILE STATION shall regard an incoming DISCONNECT message as consistent with any of its call control states except the "null" state, the "release request" state, and the "disconnect indication" state; a call control entity of the network shall regard an incoming DISCONNECT message as consistent with any of its call control states except the "null" state and the "release request" state.

NOTE: This allows the introduction of shorter call clearing procedures in the future.

### 5.4.3 Clearing initiated by the Mobile Station

#### 5.4.3.1 Initiation of call clearing

Apart from the exceptions identified in section 5.4.2, the call control entity of the Mobile Station shall initiate clearing by: stopping all running call control timers, sending a DISCONNECT message; starting timer T305; and entering the "disconnect request" state.

#### **5.4.3.2 Receipt of a DISCONNECT message from the Mobile Station**

The call control entity in the network in any state except the "null" state and the "release request" state shall, upon receipt of a DISCONNECT message:

- stop all running call control timers;
- initiate procedures to clear the network connection and the call to the remote user;
- send a RELEASE message to its peer entity;
- start timer T308; and
- enter the "release request" state.

NOTE: The RELEASE message has only local significance and does not imply an acknowledgement of clearing from the remote user.

#### **5.4.3.3 Receipt of a RELEASE message from the network**

The call control entity of the Mobile Station in any state except the "null" state and the "release request" state, shall, upon receipt of a RELEASE message: stop all running call control timers; send a RELEASE COMPLETE message; release the MM connection; and return to the "null" state.

#### **5.4.3.4 Receipt of a RELEASE COMPLETE message from the Mobile Station**

A call control entity of the network in any call control state shall, upon receipt of a RELEASE COMPLETE message from its peer entity in the Mobile Station: stop all running call control timers; release the MM connection; and return to the "null" state.

#### **5.4.3.5 Abnormal cases**

The call control entity of the Mobile Station in the "disconnect request" state, shall upon expiry of timer T305: send a RELEASE message to the network with the cause number originally contained in the DISCONNECT message and optionally, a second cause information element with cause #102 "recovery on timer expiry", start timer T308, and enter the "release request" state.

The call control entity of the network in the "release request" state, shall, at first expiry of timer T308, retransmit the RELEASE message, start timer T308, and stay in the "release request" state. At second expiry of timer T308, the call control entity of the network shall: release the MM connection; and return to the "null" state.

#### 5.4.4 Clearing initiated by the network

Apart from the exception conditions identified in section 5.4.2, the call control entity of the network shall initiate clearing by: sending a DISCONNECT message; and entering the "disconnect indication" state. The DISCONNECT message is a local invitation to clear the call.

NOTE: When the network initiates clearing by sending a RELEASE message, the procedures described in sections 5.4.3., 5.4.3.4 and 5.4.3.5 are followed.

##### 5.4.4.1 Clearing when tones/announcements provided

When in-band tones/announcements are provided (see section 5.5.1), the call control entity of the network may initiate clearing by sending a DISCONNECT message containing progress indicator #8 "in-band information or appropriate pattern now available", starting timer T306, and entering the "disconnect indication" state.

###### 5.4.4.1.1 Receipt of a DISCONNECT message with progress indicator #8 from the network

The call control entity of the Mobile Station in any state except the "null" state, the "disconnect indication" state, and the "release request" state, shall, upon receipt of a DISCONNECT message with progress indicator #8:

- i) if an appropriate speech traffic channel is not connected, continue clearing as defined in section 5.4.4.2.1 without connecting to the in-band tone/announcement;
- ii) if an appropriate speech traffic channel is connected, attach the user connection for speech if it is not yet attached and enter the "disconnect indication" state. In that state, if upper layers request the clearing of the call, the call control entity of the Mobile station shall proceed as defined in section 5.4.4.2.1.

###### 5.4.4.1.2 Expiry of timer T306

The call control entity of the network, having entered the "disconnect indication" state after sending a disconnect message with the progress indicator #8, shall, upon expiry of timer T306, continue clearing by sending a RELEASE message with the cause number originally contained in the DISCONNECT message; starting timer T308; and entering the "release request" state.

##### 5.4.4.2 Clearing when tones/announcements not provided

When in-band tones and announcements are not provided, the call control entity of the network shall initiate call clearing by stopping all running call control timers, sending a DISCONNECT message without progress indicator, starting timer T305 and entering the "disconnect indication" state.

###### 5.4.4.2.1 Receipt of a DISCONNECT message without progress indicator or with progress indicator different from #8 from the network

The call control entity of the Mobile Station in any state except the "null" state, the "disconnect indication" state, and the "release request" state, shall, upon the receipt of a DISCONNECT message without progress indicator information element or with progress indicator different from #8:

- stop all running call control timers;
- send a RELEASE message;
- start timer T308; and
- enter the "release request" state.

#### **5.4.4.2.2 Receipt of a RELEASE message from the Mobile Station**

The call control entity of the network in any state except the "null" state and the "release request" state, shall, upon receipt of a RELEASE message: stop all running call control timers; send a RELEASE COMPLETE message; release the MM connection; and return to the "null" state.

#### **5.4.4.2.3 Abnormal cases**

The call control entity of the network, having entered the "disconnect indication" state after sending a DISCONNECT message without progress indicator or with progress indicator different from #8, shall upon expiry of timer T305: send a RELEASE message to the Mobile Station with the cause number originally contained in the DISCONNECT message; start timer T308; and enter the "release request" state. In addition to the original clearing cause, the RELEASE message may contain a second cause information element with cause #102 "recovery on timer expiry".

#### **5.4.4.3 Completion of clearing**

A call control entity of the Mobile Station in any call control state shall, upon receipt of a RELEASE COMPLETE message from its peer entity in the network: stop all running call control timers ; release the MM connection; and return to the "null" state.

##### **5.4.4.3.1 Abnormal cases**

The call control entity of the Mobile Station in the "release request" state shall at first expiry of timer T308 retransmit the RELEASE message and restart timer T308. At second expiry of timer T308, the call control entity of the Mobile Station shall: release the MM connection; and return to the "null" state.

#### **5.4.5 Clear collision**

Clear collision occurs when both the Mobile Station and the network simultaneously transfer DISCONNECT messages specifying the same call.

The behaviour of the network call control entity receiving a DISCONNECT message whilst in the "disconnect indication" state is specified in section 5.4.3. The behaviour of the Mobile Station call control entity receiving a DISCONNECT message whilst in the "disconnect request" state is defined in section 5.4.4.

Clear collision can also occur when both sides simultaneously transfer RELEASE messages related to the same call. The entity receiving such a RELEASE message whilst within the "release request" state shall: stop timer T308; release the MM connection; and enter the "null" state (without sending a RELEASE COMPLETE message).

## 5.5 Miscellaneous procedures

### 5.5.1 In-band tones and announcements

When the network wants to make the Mobile Station attach the user connection (e.g. in order to provide in-band tones/announcement) before the Mobile Station has reached the "active" state of a call, the network may include a *progress indicator* IE indicating user attachment in a suitable CC message:

- either it includes the IE in a SETUP, CALL PROCEEDING, ALERTING, or CONNECT message that is send during call establishment;
- it sends a PROGRESS message containing the IE.

A *progress indicator* IE indicates user attachment if it specifies a progress description in the set {1, 2, 3} or in the set {6, 7, 8, ..., 20}.

On reception of a SETUP, CALL PROCEEDING, ALERTING, CONNECT, or PROGRESS message the Mobile Station shall proceed as specified elsewhere in section 5; if the *progress indicator* IE indicated user attachment and a speech mode traffic channel is appropriate for the call the Mobile Station shall in addition: attach the user connection for speech as soon as an appropriate channel in speech mode is available. (If a new order to attach the user connection is received before the attachment has been performed, the new order shall supersede the previous one.)

NOTE: This allows the use of *progress indicator* IEs independently from the channel modes appropriate for the call.

### 5.5.2 Call collisions

Call collisions as such cannot occur at the network. Any simultaneous mobile originating or mobile terminating calls are dealt with separately assigned and different transaction identifiers.

### 5.5.3 Status procedures

#### 5.5.3.1 Status enquiry procedure

Whenever a call control entity wishes to check the call state of its peer entity, it may initiate the status enquiry procedure.

NOTE: This may, in particular, apply to procedural error conditions described in section 8.

A call control entity initiates the status enquiry procedure by sending the STATUS ENQUIRY message and starting timer T322. While timer T322 is running, the call control entity shall not send further STATUS ENQUIRY messages.

Upon receipt of a STATUS ENQUIRY message, the receiver shall respond with a STATUS message, reporting the current call state and cause value #30 "response to STATUS ENQUIRY". Receipt of the STATUS ENQUIRY shall not result in a state change relating to any protocol and connection of the receiver.

If a STATUS message is received that contains cause value #30 "response to status enquiry", timer T322 shall be stopped and further appropriate actions taken, based on the information in that STATUS message, relative to the current state of the receiver of the STATUS message. These further "appropriate actions" are implementation dependent. However, the actions prescribed in section 5.5.3.2 shall apply.

If a clearing message is received while timer T322 is running, timer T322 shall be stopped, and call clearing shall continue.

If timer T322 expires, the STATUS ENQUIRY message may be retransmitted maximally once. If T322 expires after the STATUS ENQUIRY has been transmitted the maximum number of times, clearing of the call shall be initiated with cause value #41, "temporary failure", in the first call clearing message.

### 5.5.3.2 Reception of a STATUS message by a CC entity

#### 5.5.3.2.1 STATUS message with incompatible state

On receipt of a STATUS message reporting an incompatible call control state, the receiving entity shall clear the call by sending a RELEASE COMPLETE message with cause # 101 "message not compatible with protocol state". The reported call control state is incompatible if the combination of call control states at the sender and receiver side cannot occur, do not match or cannot be aligned by actions of the receiver; the exact definition is implementation dependent.

#### 5.5.3.2.2 STATUS message with compatible state

A STATUS message may be received indicating a compatible call state but containing one of the following causes:

- # 95 "semantically incorrect message"; or
- # 96 "invalid mandatory information"; or
- # 97 "message type non-existent or not implemented"; or
- # 98 "message type not compatible with protocol state"; or
- # 99 "information element non-existent or not implemented"; or
- # 100 "conditional IE error".

This indicates that the transmitter of the STATUS message was unable to accept some information sent by the recipient of the STATUS message. This allow the recipient to retransmit some or all of the information. Other actions are possible and are implementation dependent; they may include releasing the call.

### 5.5.4 Call re-establishment, mobile station side

This section describes the internal handling in the mobile station as far as call control is concerned.

#### 5.5.4.1 Indication from the mobility management sublayer

When a MM connection is active, an indication may be given by the MM sublayer to the call control entity to announce that the current MM connection has been interrupted but might be re-established on request of call control.

#### 5.5.4.2 Reaction of call control

Depending whether call re-establishment is allowed or not and on its actual state, call control shall decide to either request re-establishment or to release the MM connection.

##### a) Re-establishment not required.

If the call is in the call establishment or call clearing phase, i.e. any state other than the "active" state or the "mobile originating modify" state, call control shall release the MM connection.

##### b) Re-establishment required.

If the call is in the "active" state or "mobile originating modify" state, the indication from MM that re-establishment is possible shall cause call control to request re-establishment from the MM connection, suspend any further message to be sent and await the completion of the re-establishment procedure.

#### 5.5.4.3 Completion of re-establishment

Call Control is notified when the MM connection is re-established and shall then resume the transmission of possibly suspended messages and resume user data exchange when an appropriate channel is available.



#### 5.5.4.4 Unsuccessful outcome

If the attempt to re-establish the connection was unsuccessful, the MM connection will be released and a release indication will be given to call control (see section 4.5.1.6).

#### 5.5.5 Call re-establishment, network side

This section describes the handling in the network as far as call control is concerned.

##### 5.5.5.1 State alignment

After a successful call re-establishment it is a network responsibility to identify (e.g. by using the status enquiry procedure, if needed, and resolve, if possible, any call state or auxiliary state mismatch between the network and the mobile station.

#### 5.5.6 Progress

At any time during the establishment or release of a call and during an active call the network may send a PROGRESS message to the Mobile Station.

On receipt of a PROGRESS message during the establishment or release of a call the Mobile Station shall stop all call control timers related to that call.

NOTE: If the PROGRESS has been received before the receipt of a CALL PROCEEDING message, the Mobile Station will not start timer T310 on receipt of a CALL PROCEEDING message (see section 5.2.1.1.3).



**Figure 5.11/GSM 04.08:  
Progress**

#### 5.5.7 DTMF protocol control procedure

Dual Tone Multi Frequency (DTMF) is an inband one out of four plus one out of four signalling system primarily used from terminal instruments in telecommunication networks. The support of DTMF in the network is described in GSM 03.14.

The mobile station shall be capable of transmitting DTMF messages if and only if the mobile station has the user connection for speech attached and an appropriate channel is available.

The transaction identifier used by the DTMF messages shall be that of the attached speech call.

NOTE 1: This specification means that DTMF messages can generally be sent in the active state of a call in speech transmission mode or when a traffic channel is available during setup or release and the *progress indicator* IE has been received.

NOTE 2: Since the DTMF protocol messages are sent in a store and forward mode on the signalling channels the control of the device at the far end may be delayed dependent on the load or quality of the channels.

NOTE 3: The procedures described in this section support DTMF only in the direction Mobile Station to network.

#### **5.5.7.1 Start DTMF request by the Mobile Station**

A user may cause a DTMF tone to be generated e.g. by depression of a key in the MS. The relevant action is interpreted by the Mobile Station as a requirement for a DTMF digit to be sent in a START DTMF message on an established FACCH. This message contains the value of the digit to be transmitted (0, 1, ..., 9, A, B, C, D, \*, #).

Only a single digit will be transferred in each START DTMF message.

#### **5.5.7.2 Start DTMF response by the network**

Upon receiving the START DTMF message the network will reconvert the received digit back into a DTMF tone which is applied toward the remote user and returns a START DTMF ACKNOWLEDGE message to the Mobile Station. This acknowledgement may be used in the Mobile Station to generate an indication as a feedback for a successful transmission.

If the network cannot accept the START DTMF message a START DTMF REJECT message will be sent to the Mobile Station.

#### **5.5.7.3 Stop DTMF request by the Mobile Station**

When the user indicates that the DTMF sending should cease e.g. by releasing the key the Mobile Station will send a STOP DTMF message to the network.

#### **5.5.7.4 Stop DTMF response by the network**

Upon receiving the STOP DTMF message the network will stop sending the DTMF tone and return a STOP DTMF ACKNOWLEDGE message to the Mobile Station.

#### **5.5.7.5 Sequencing of subsequent start DTMF requests by the Mobile Station**

The minimum length of tone generated by the network should be according to CEPT recommendation T/CS 46-02.

The minimum gap between two subsequent tones should be according to CEPT recommendation T/CS 46-02.

There is no defined maximum length to the tone, which will normally cease when a STOP DTMF message is received from the MS. However, the operator may choose to put a pre-defined time limit on the duration of tones sent.

The appropriate sequencing of DTMF control messages is shown in figures 5.8 and 5.9.

NOTE 1: The network may implement the time limit option where the DTMF tone duration is controlled by the network irrespective of the receipt of a STOP DTMF message from the Mobile Station.

NOTE 2: The transmission time of the messages over the air interface on FACCH/F or FACCH/H, see GSM 05.02, ensures that the minimum length of tones and minimum gap between tones according to T/CS 46-02 are fulfilled.



## **6 Support of packet services.**

The circuit-switched call control procedures of section 5 apply to this case.

## 7 Examples of structured procedures

Section 7 is non-normative.

### 7.1 General

Section 7 contains examples of how the network may group together the elementary procedures (i.e. the procedures defined in sections 3 to 5) in order to provide normal service.

The layer 3 signalling at the radio interface may be divided into so-called structured procedures which consist of specific combinations of elementary procedures. In section 7.3, selected examples of structured procedures are described. A structured procedure consists of (not necessarily all) components shown in figure 7.1. These components are characterized by the purpose of their use in structured procedures and their message flow in the following sections 7.1.1 to 7.1.7.

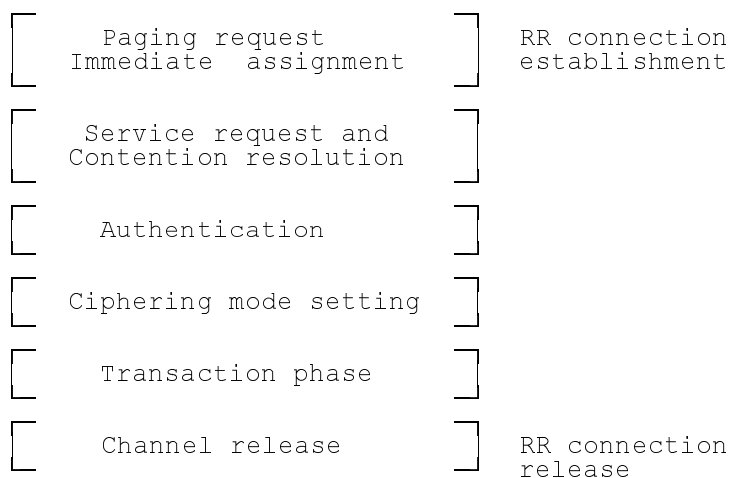
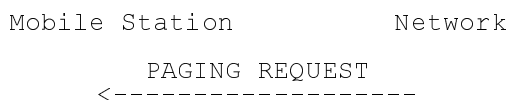

**Figure 7.1/GSM 04.08:  
 Components of structured procedures**

#### 7.1.1 Paging request

The paging procedure is used to locate a mobile station to which a connection shall be established.

Upon receipt of a PAGING REQUEST message the addressed mobile station initiates the immediate assignment procedure.



**Figure 7.2/GSM 04.08: Paging request**

### 7.1.2 Immediate assignment

The immediate assignment procedure is always initiated by the mobile station. It may be triggered by a paging request or by a mobile originating service request.

The mobile station sends a CHANNEL REQUEST message on the Random Access Channel. The network responds with an IMMEDIATE ASSIGNMENT message which causes the mobile station to seize the indicated dedicated channel.

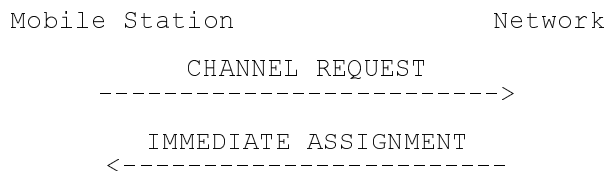

Figure 7.3/GSM 04.08: Immediate assignment

### 7.1.3 Service request and contention resolution

The initial service request message (a PAGING RESPONSE, LOCATION UPDATING REQUEST, IMSI DETACH, CM SERVICE REQUEST, or CM REESTABLISHMENT REQUEST message) is sent by the mobile station to the network piggy-backed in the L2 SABM frames establishing the main signalling link. Its purpose is:

- to provide non-confidential information relevant to the service requested for the RR and MM sublayer in the network;
- in particular to identify the user in the network without jeopardizing the confidentiality of the user's identity; this is achieved by using as mobile identity the TMSI, which was never before transmitted un-encrypted over the radio interface;
- to allow for contention resolution.

Contention resolution provides a resolution process when more than one MS try to seize a channel allocated during the immediate assignment procedure (because they happened to use the same random reference at the same time during random access). This is achieved by the network including in a L2 UA frame the same information field as that one received in the L2 SABM frame to which the UA frame responds. By comparing the two information fields the MS can verify whether it was the originator of the L2 establishment, because the service request contains the mobile identity.

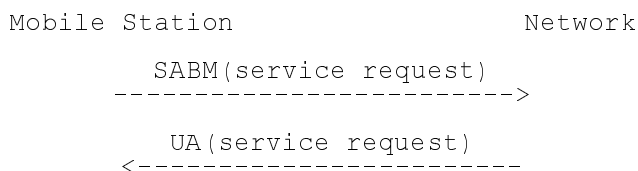
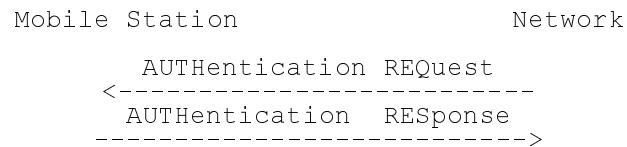

Figure 7.4/GSM 04.08: Service request and contention resolution

#### 7.1.4 Authentication

The purpose of authentication is to validate the identity provided by the mobile station . It is initiated by the network. The authentication procedure also provides the mobile station with information from which a new ciphering key can be derived. The network decides whether or not to use authentication. This may depend on the context.

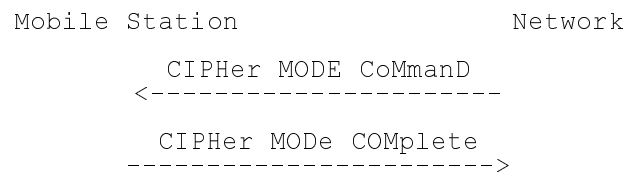

**Figure 7.5/GSM 04.08: Authentication**

#### 7.1.5 Ciphering mode setting

Ciphering mode setting is initiated by the network. Its purpose is to instruct the mobile station whether or not to use ciphering and which algorithm to use.

Where ciphering is used, this procedure synchronizes the start of ciphering at the mobile station and in the network.



**Figure 7.6/GSM 04.08: Ciphering mode setting**

### 7.1.6 Transaction phase

A variety of elementary procedures described in sections 3 to 5 may be performed during the transaction phase. In this section, only the transmission mode change procedure is characterized.

#### 7.1.6.1 Transmission mode change

The transmission mode change procedure may be used when a traffic channel has been assigned e.g.:

- during the in-call modification procedure in order that the channel mode of the TCH be changed to that one requested by call control;
- during call establishment with very early assignment in order that the channel mode of the TCH be changed from signalling only to the mode requested by call control;
- during the active phase of a data call in order that the speed of the data transmission be changed.

The transmission mode procedure is initiated by the network sending a CHANNEL MODE MODIFY message and completed by the mobile station changing the mode of the TCH and sending back a CHANNEL MODE MODIFY ACKNOWLEDGE message.

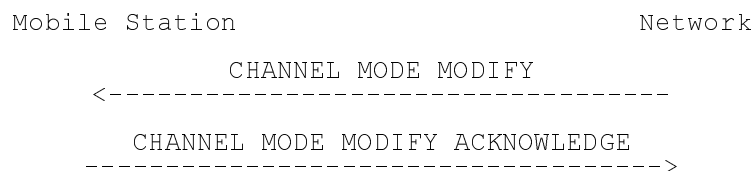

**Figure 7.7/GSM 04.08: Channel mode change**

### 7.1.7 Channel release

Once the transaction phase has been completed, the channel is released by the channel release procedure. The data link layer is released explicitly as described in GSM 04.06. After the channel release is completed, the radio resources which were in use may be reallocated by the network.

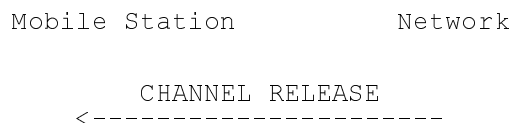

**Figure 7.8/GSM 04.08: Channel release**

## 7.2 Abnormal cases

Abnormal cases are not described in the examples of section 7. They may arise from:

- a) failure at a lower layer (e.g. loss of radio connection);
- b) failure of an elementary procedure;
- c) errors in an elementary procedure.



### 7.3 Selected examples

The following examples are considered:

- location updating
- mobile originating call establishment:
  - a) without OACSU (early assignment)
  - b) with OACSU
  - c) with very early assignment
- mobile terminating call establishment:
  - a) without OACSU (early assignment)
  - b) with OACSU
- call clearing:
  - a) network initiated
  - b) mobile initiated
- DTMF protocol control.
- handover:
  - a) between finely synchronized cells
  - b) between non-synchronized cells
  - c) handover failure, where reconnection of the old channel is possible
- in-call modification
- call re-establishment

#### 7.3.1 Location updating

The location updating procedure is always initiated by the mobile station e.g. when it finds itself in a different location area from the one in which it was registered before. The cases where the procedure is triggered are described in section 4.

The procedure is shown in figure 7.9/GSM 04.08. The network may decide whether to allocate a new TMSI during location updating, and this option is reflected in this example.

The mobile station initiates immediate assignment, service request using the LOCATION UPDATING REQUEST message, and contention resolution.

The network requires authentication (this again is an option).

As the network intends to allocate a new TMSI, it should activate ciphering. The network includes the new TMSI in the LOCATION UPDATING ACCEPT message (it could also use the explicit TMSI reallocation procedure, see section 4). The MS sends a TMSI REALLOCATION COMPLETE message to the network to acknowledge the receipt of the new TMSI. Upon receipt of the TMSI REALLOCATION COMPLETE message the network initiates the channel release if no further transactions are scheduled.

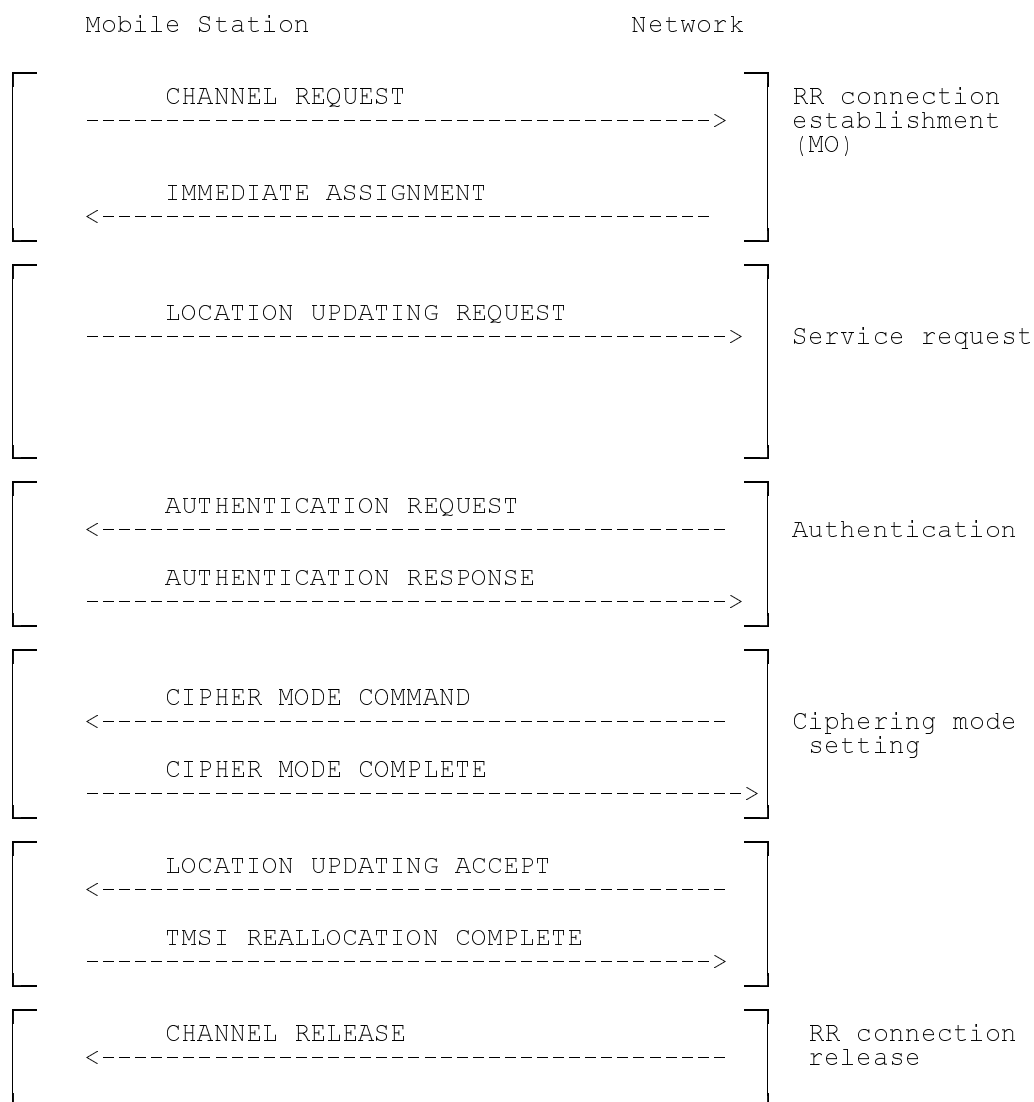

Figure 7.9/GSM 04.08: Location updating: successful case

### 7.3.2 Mobile originating call establishment

The mobile station initiates immediate assignment, service request using the CM SERVICE REQUEST message, and contention resolution. The network may initiate authentication and may start the ciphering mode setting.

After sending the CIPHERING MODE COMPLETE message, the mobile station initiates call establishment by sending the SETUP message to the network. The network answers with a CALL PROCEEDING message.

- a) Non-OACSU option (early assignment).  
 With this option the network allocates a traffic channel to the mobile station before it initiates call establishment in the fixed network.

If call queuing is applied, it may cause variable delay in the traffic channel assignment.

When user alerting has been initiated at the called side, an ALERTING message is sent to the Mobile Station. The network may optionally instruct the MS to attach the user connection at this stage of the call, by means of the progress indicator information element set to the value #1 or #8 (if the ringing tone will be sent by the remote end) in the ALERTING message. In that case, an alerting ringing tone has to be generated by the network.

NOTE: The speech codec is transparent for supervisory tones.

A CONNECT message and its acknowledgement CONNECT ACKNOWLEDGE complete the call establishment when the called party has answered.

The mobile originating call setup with early assignment is shown in figure 7.10a/GSM 04.08.

b) OACSU option (late assignment).

The network determines when the traffic channel is to be assigned. The assignment may be performed at any time after call establishment has been initiated in the fixed network. In the following the case is considered where the network will only allocate a traffic channel after the called party has answered the call (late assignment).

As in a) an ALERTING message is sent to the mobile station when user alerting has been initiated at the called side. If the ringing tone is needed, it has to be generated locally at the mobile station as no traffic channel is allocated. When the called party has answered, the network will initiate the channel assignment procedure in order to allocate a traffic channel to the Mobile Station. If call queuing is applied, it may cause variable delay in the traffic channel assignment. Once the channel assignment has been completed the network will send a CONNECT message to the Mobile Station. The MS attaches then the user connection. The CONNECT ACKNOWLEDGE message will complete the call setup.

The mobile originating call setup with late assignment is shown in figure 7.10b/GSM 04.08.

c) Very early assignment.

The network assigns the traffic channel at the earliest possible moment, i.e. in the immediate assignment procedure. The mode of the traffic channel is changed from signalling only to the mode necessary for the call by means of the channel mode change procedure. An appropriate moment for that change is after the network has sent the CALL PROCEEDING message, when the call is established towards the called user.

With this option, call queuing is never applied.

The further establishment of the call is as in a).

The mobile originating call setup with very early assignment is shown in figure 7.10c/GSM 04.08.

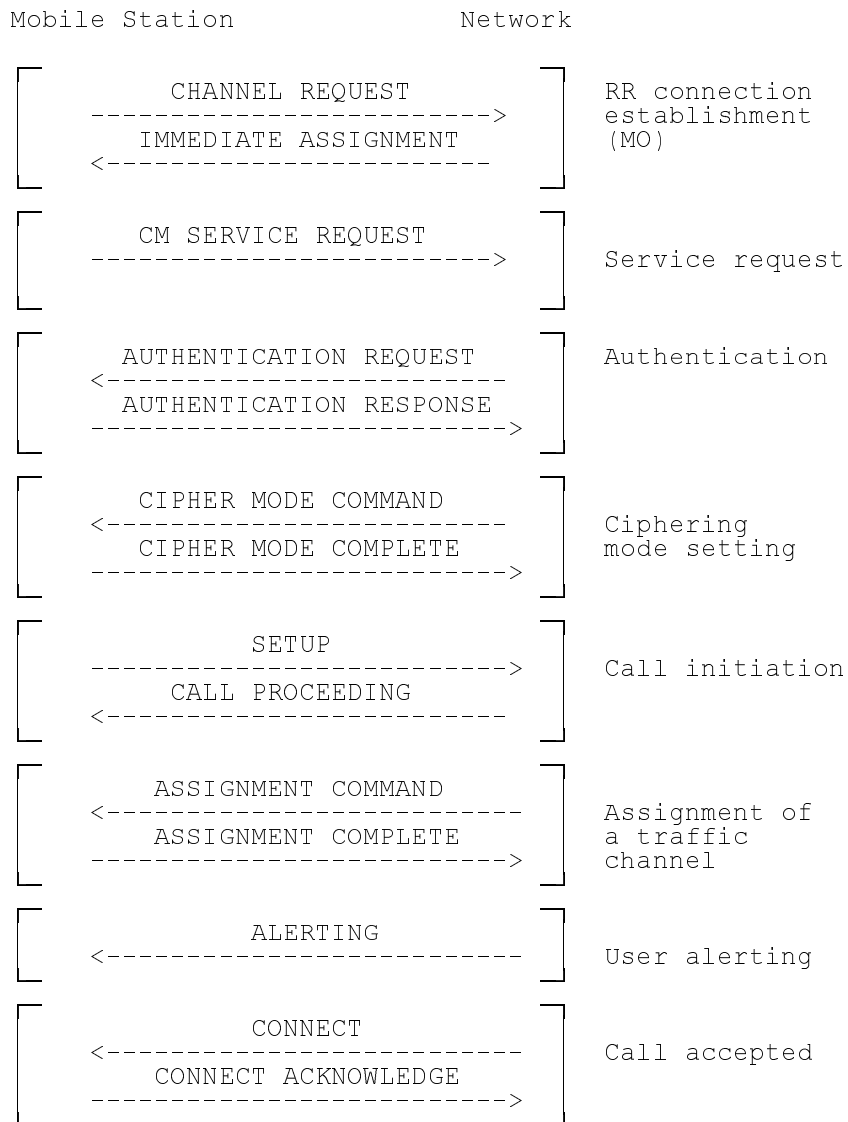

**Figure 7.10a/GSM 04.08:  
 Mobile originating call establishment without OACSU (early assignment)**

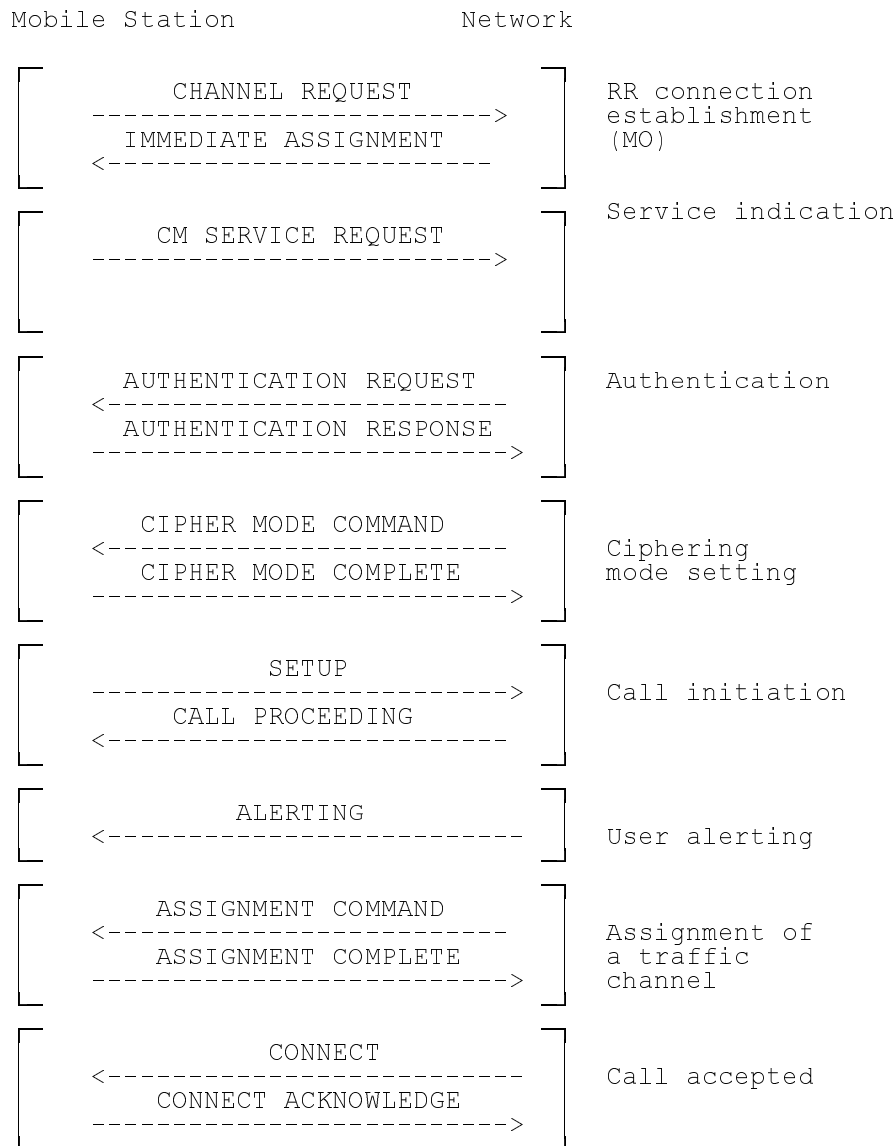

**Figure 7.10b/GSM 04.08:**  
**Mobile originating call establishment with OACSU (late assignment)**

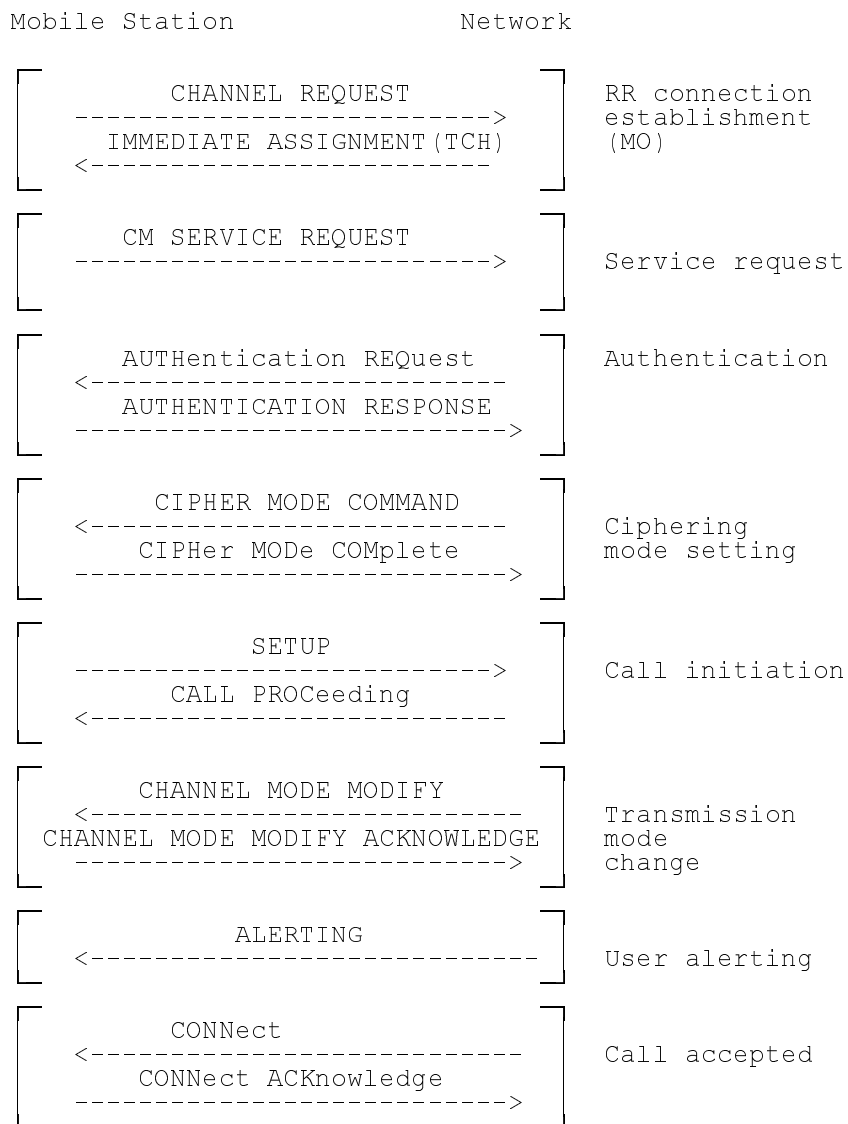

**Figure 7.10c/GSM 04.08:**  
**Mobile originating call establishment with very early assignment**

### 7.3.3 Mobile terminating call establishment

Mobile terminating call establishment is initiated by the network sending a PAGING REQUEST message (see figure 7.11a/GSM 04.08). Upon receiving this message the mobile station initiates the immediate assignment procedure and responds to the network by sending the PAGING RESPONSE message within a layer 2 SABM frame. The network returns a layer 2 UA frame containing the same information field as was sent in the SABM frame.

Authentication and ciphering are treated by the network in the same way as defined for the mobile originating call establishment (section 7.3.2). After ciphering has been started, the network sends a SETUP message to the Mobile Station. The capability of the mobile station (at that time) to accept the call is confirmed when the mobile station returns a CALL CONFIRMED message to the network.

a) Non-OACSU option (early assignment).

With this option the network initiates the assignment of a traffic channel upon receiving the CALL CONFIRMED message.

The signal IE is not included in the SETUP message, therefore user alerting is initiated only after a traffic channel has been allocated. An ALERTING message will be sent to the network.

When the called user answers, the mobile station sends a CONNECT message to the network. Upon receiving the CONNECT message the network completes the through connection of the communication path and sends a CONNECT ACK message to the Mobile Station.

b) OACSU option (late assignment).

In that option, the signalling IE is included in the SETUP message. Consequently, user alerting is initiated as soon as the MS has accepted the call.

The network determines when the traffic channel is to be assigned. The assignment may be performed at any time after user alerting has been initiated. In the following the case is considered where the network will only allocate a traffic channel to the mobile station after having received the CONNECT message sent from the mobile station (see figure 7.11b).

Upon receiving the ASSIGNMENT COMPLETE message from the Mobile Station, the network completes the through connection of the communication path and sends a CONNECT ACKNOWLEDGE message to the Mobile Station.

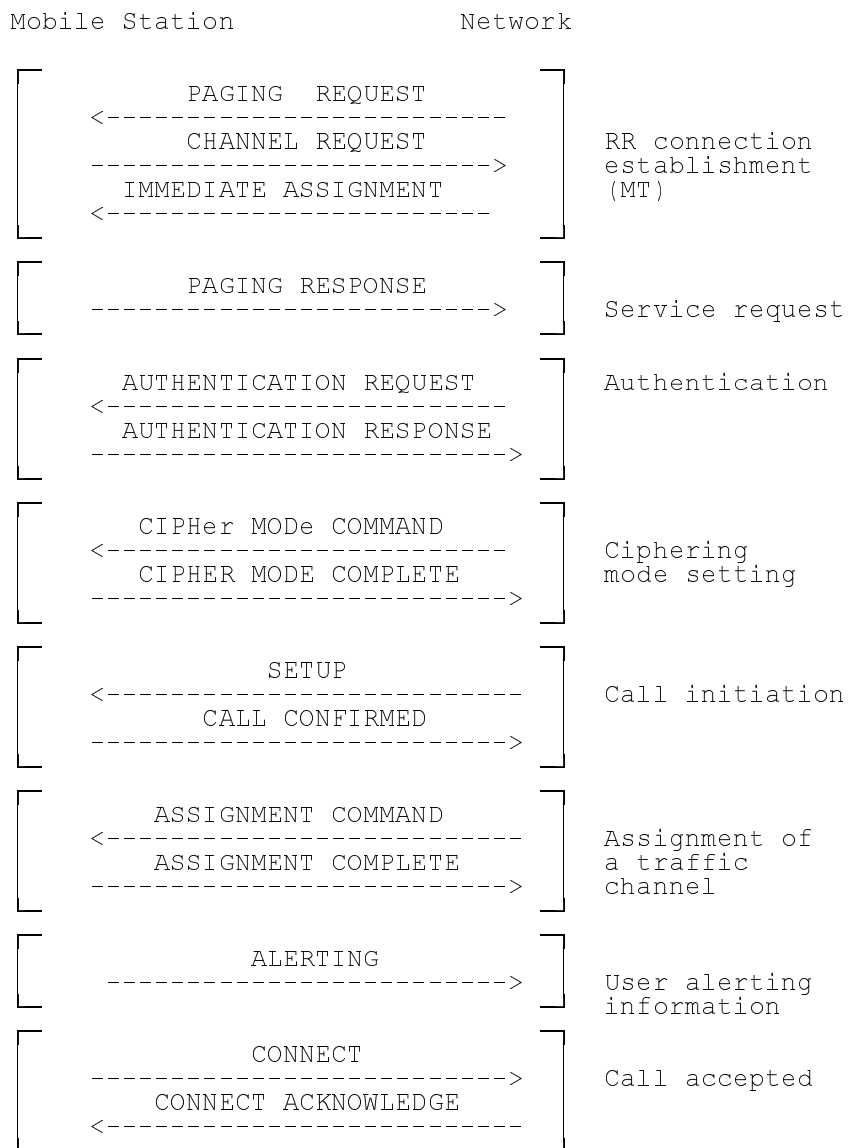

**Figure 7.11a/GSM 04.08: Mobile terminating call establishment without OACSU (early assignment)**



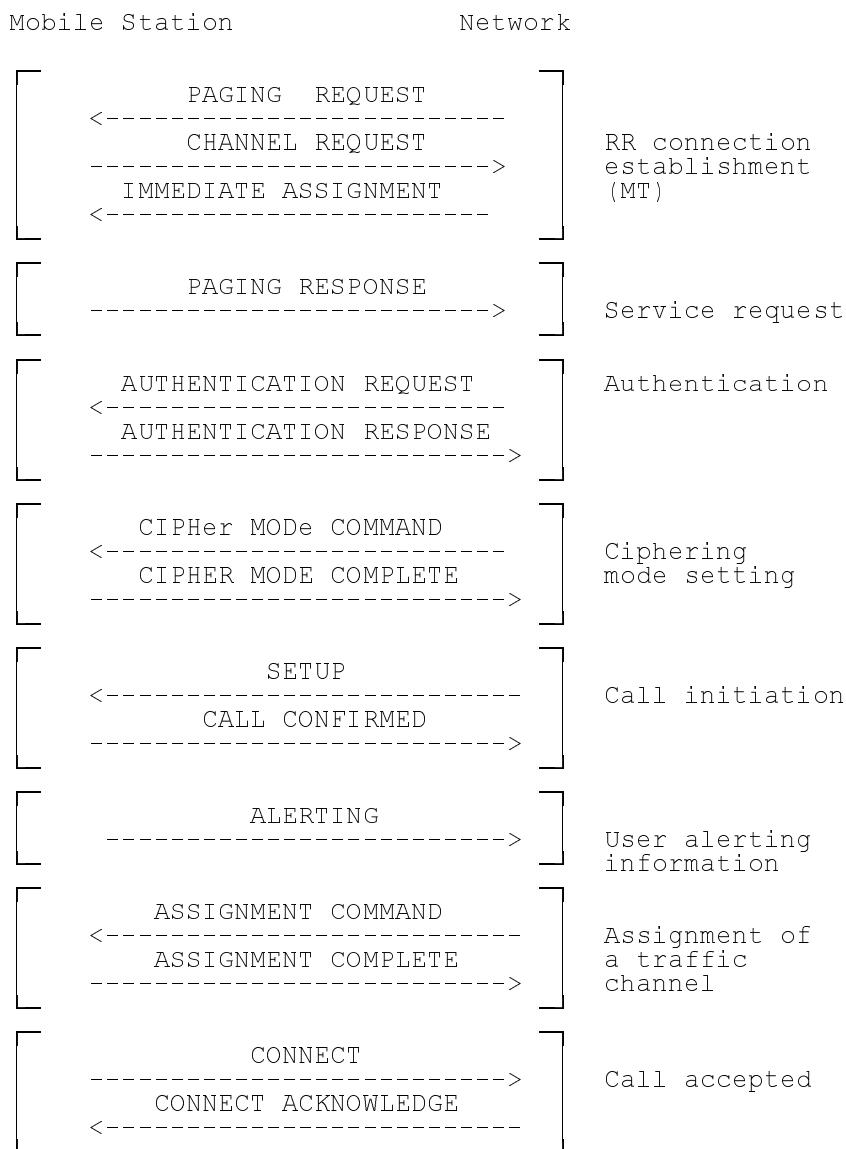

**Figure 7.11b/GSM 04.08: Mobile terminating call establishment with OACSU (late assignment)**

#### 7.3.4 Call clearing

- a) initiated by the network.

The network initiates the clearing of a call by sending a DISCONNECT message to the mobile station (see also section 5.4.4).

Upon receiving the DISCONNECT message from the network the mobile station sends a RELEASE message to the network.

Upon receiving the RELEASE message from the Mobile Station, the network sends a RELEASE COMPLETE to the mobile station and, if the traffic channel is longer needed (e.g. last activity on the traffic channel), performs the channel release procedure as described in section 7.1.7.

Upon receiving the RELEASE COMPLETE message and if the cleared call was the last activity on the traffic channel, the mobile station waits for the release of the channel which is always initiated by the network.

Call clearing initiated by the network is shown in figure 7.12a.

- b) initiated by the mobile station.

The mobile station initiates the clearing of a call by sending a DISCONNECT message to the network (see also section 5.4.3).

Upon receiving the DISCONNECT message from the mobile station the network sends a RELEASE message to the Mobile Station.

Upon receiving the RELEASE message from the network, the mobile station sends a RELEASE COMPLETE to the network, which, if the traffic channel is no longer needed (e.g. last activity on the traffic channel), performs the channel release procedure as described in section 7.1.6.

Call clearing initiated by the MS is shown in figure 7.12b.

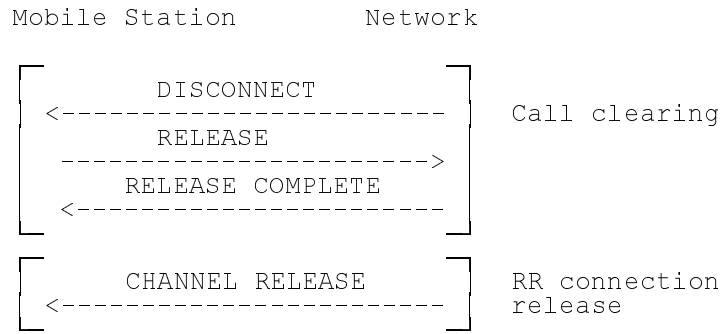

**a) Call clearing initiated by the network**

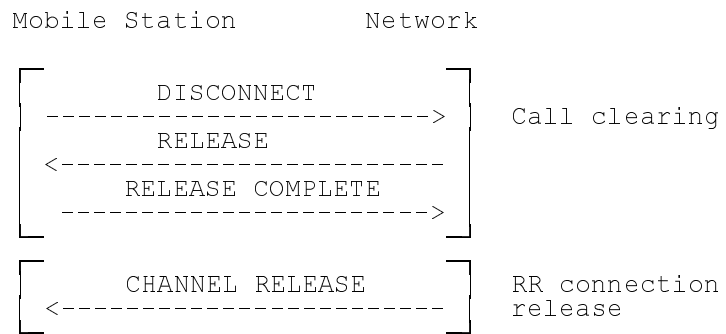

**b) Call clearing initiated by the MS**

**Figure 7.12/GSM 04.08:  
Call clearing**

### 7.3.5 DTMF protocol control

Figure 7.13 shows the structured procedure for DTMF protocol control.

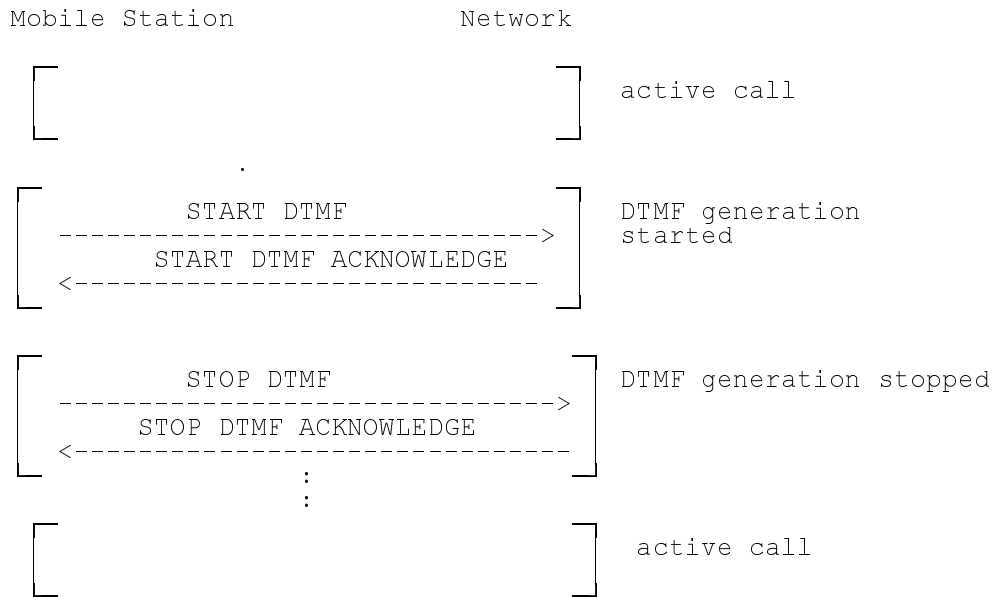

Figure 7.13/GSM 04.08: DTMF protocol control

**7.3.6 Handover**

Figure 7.14 shows the structured procedure for handover to a finely synchronized cell, successful case.

Figure 7.15 shows the structured procedure for handover to a non-synchronized cell, successful case.

Figure 7.16 shows the structured procedure for handover failure, and reconnection to the old traffic channel.

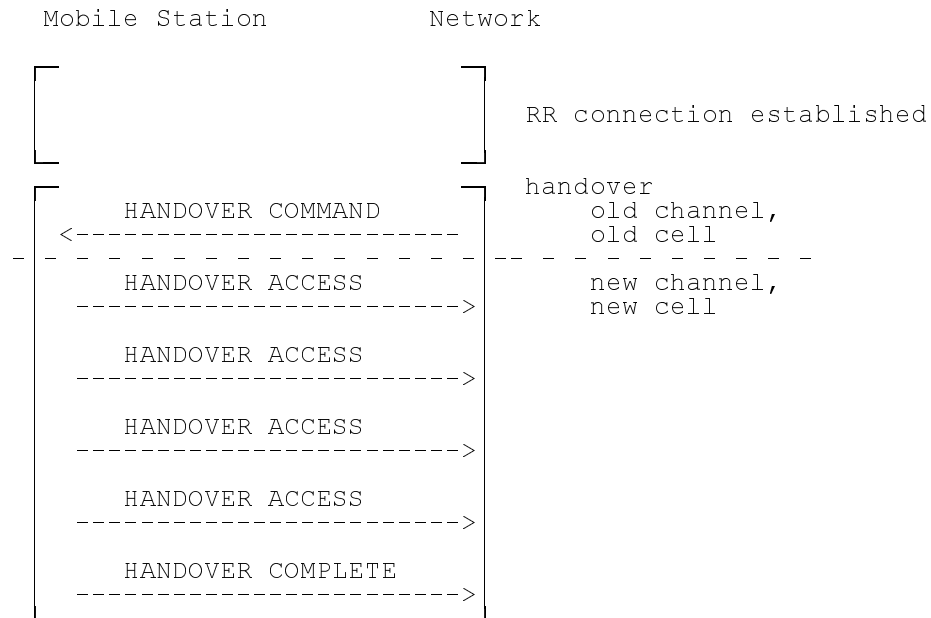

**Figure 7.14/GSM 04.08:  
 Handover to a finely synchronized cell, successful case**

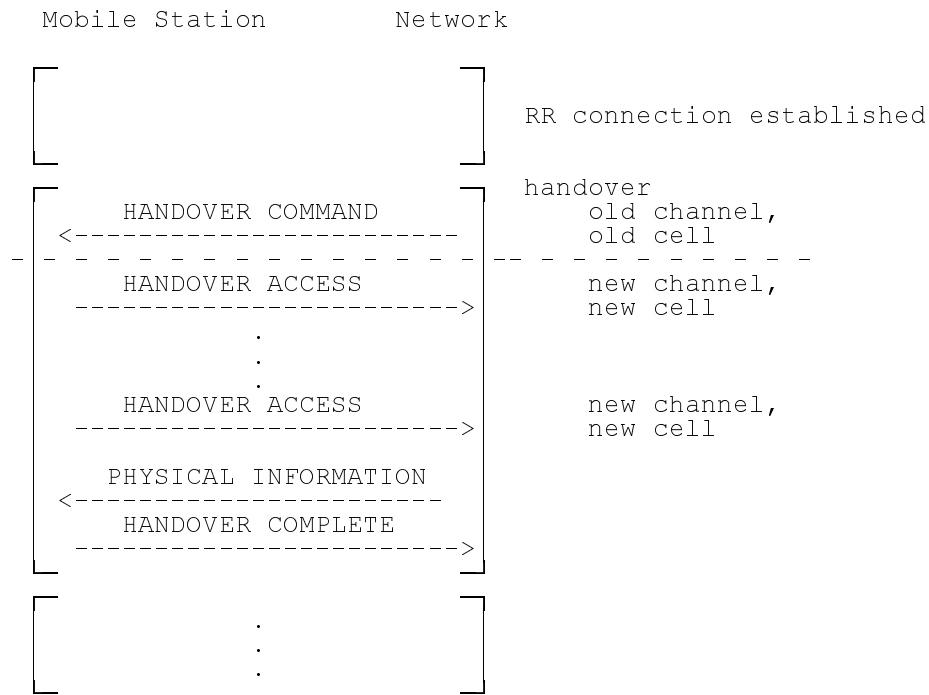

**Figure 7.15/GSM 04.08:**  
**Handover to a non-synchronized cell, successful case**

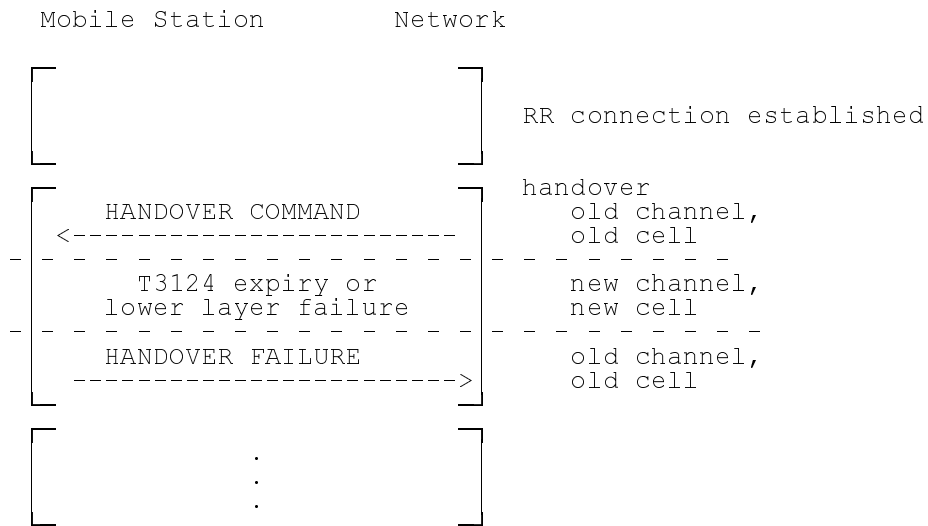

**Figure 7.16/GSM 04.08:**  
**Handover failure, reconnection to the old traffic channel**

### 7.3.7 In-call modification

Figure 7.17/GSM 04.08 shows the structured procedure for in-call modification.

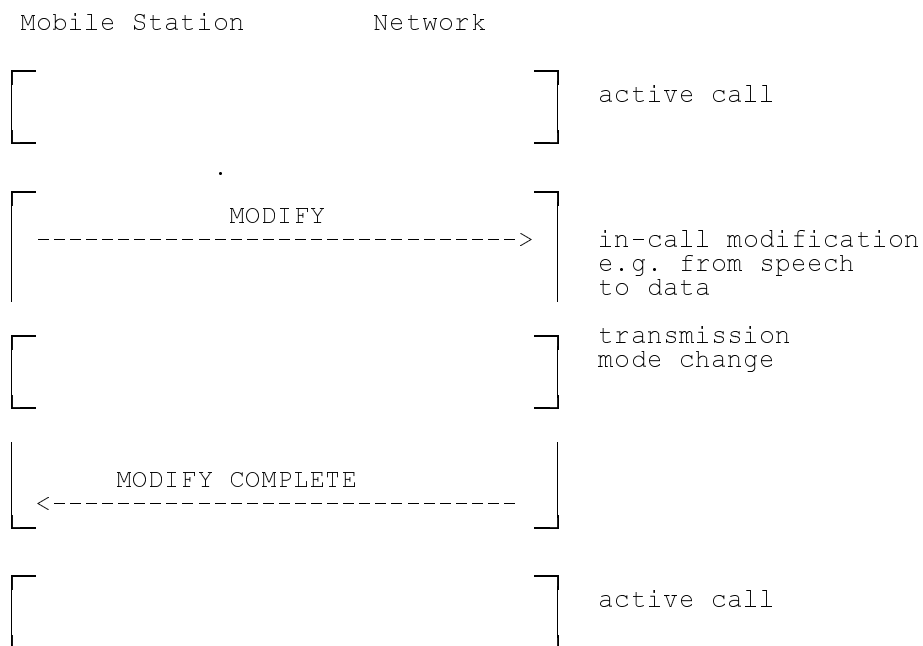

**Figure 7.17/GSM 04.08:  
In-call modification**





## **8 Handling of unknown, unforeseen, and erroneous protocol data**

### **8.1 General**

The procedures specified in GSM 04.08 and call-related supplementary service handling in GSM 04.10 apply to those messages which pass the checks described in this section.

This section also specifies procedures for the handling of unknown, unforeseen, and erroneous protocol data by the receiving entity. These procedures are called "error handling procedures", but in addition to providing recovery mechanisms for error situations they define a compatibility mechanism for future extensions of the protocols.

Error handling concerning the value part of the Facility IE and of the SS Version Indicator IE are not in the scope of this technical specification. It is defined in GSM 04.10 and the GSM 04.8x series.

Subsections 8.1 to 8.8 shall be applied in order of precedence.

Most error handling procedures are mandatory for the MS.

Detailed error handling procedures in the network are implementation dependent and may vary from PLMN to PLMN. However, when extensions of this protocol are developed, networks will be assumed to have the error handling that is indicated in this section as mandatory ("shall") and that is indicated as strongly recommended ("should"). Sections 8.2, 8.3, 8.4, 8.5 and 8.7.2 do not apply to the error handling in the network applied to the receipt of initial layer 3 message: If the network diagnoses an error described in one of these sections in the initial layer 3 message received from the mobile station, it shall either:

- try to recognize the classmark and then take further implementation dependent actions; or
- release the RR-connection.

Also, the error handling of the network is only considered as mandatory or strongly recommended when certain thresholds for errors are not reached during a dedicated connection.

In this section the following terminology is used:

- An IE is defined to be syntactically incorrect in a message if it contains at least one value defined as "reserved" in section 10, or if its value part violates rules of section 10. However it is not a syntactical error that a type 4 IE specifies in its length indicator a greater length than defined in section 10.
- A message is defined to have semantically incorrect contents if it contains information which, possibly dependant on the state of the receiver, is in contradiction to the resources of the receiver and/or to the procedural part (i.e. sections 3, 4, 5) of GSM 04.08, GSM 04.10, or relevant GSM 04.8X series.

### **8.2 Message too short**

When a message is received that is too short to contain a complete message type information element, that message shall be ignored, cf. GSM 04.07.

### **8.3 Unknown or unforeseen transaction identifier**

The Mobile Station and network shall ignore a call control message received with TI value "111". For a call control message received with TI different from "111", the following procedures shall apply:

- a) Whenever any call control message except EMERGENCY SETUP, SETUP or RELEASE COMPLETE is received specifying a transaction identifier which is not recognized as relating to an active call or to a call in progress, the receiving entity shall send a RELEASE COMPLETE message with cause #81 "invalid transaction identifier value" using the received transaction identifier value and remain in the Null state.

- b) When a RELEASE COMPLETE message is received specifying a transaction identifier which is not recognized as relating to an active call or to a call in progress, the MM connection associated with that transaction identifier shall be released.
- c) When an EMERGENCY SETUP message or a SETUP message is received specifying a transaction identifier which is not recognized as relating to an active call or to a call in progress, and with a transaction identifier flag incorrectly set to "1", this message shall be ignored.
- d) When a SETUP message is received by the mobile station specifying a transaction identifier which is recognized as relating to an active call or to a call in progress, this SETUP message shall be ignored.
- e) When an EMERGENCY SETUP message or a SETUP message is received by the network specifying a transaction identifier which is recognized as relating to an active call or to a call in progress, this message need not be treated and the network may perform other actions.

#### 8.4 Unknown or unforeseen message type

If the Mobile Station receives a message with message type not defined for the PD or not implemented by the receiver, it shall ignore the message except for the fact that, if an RR connection exists, it shall return a status message (STATUS, RR STATUS or MM STATUS depending on the protocol discriminator) with cause # 97 "message type non-existent or not implemented".

If the network receives an RR message or MM message with message type not defined for the PD or not implemented by the receiver in a protocol state where reception of an unsolicited message with the given PD from the mobile station is not foreseen in the protocol, the network actions are implementation dependent. Otherwise, if the network receives a message with message type not defined for the PD or not implemented by the receiver, it shall ignore the message except that it should return a status message (STATUS, RR STATUS or MM STATUS depending on the protocol discriminator) with cause #97 "message type non-existent or not implemented".

NOTE: A message type not defined for the PD in the given direction is regarded by the receiver as a message type not defined for the PD (see GSM 04.07).

If the Mobile Station receives a message not compatible with the protocol state, the Mobile Station shall ignore the message except for the fact that, if an RR connection exists, it returns a status message (STATUS, RR STATUS or MM STATUS depending on the protocol discriminator) with cause #98 "Message type not compatible with protocol state".

If the network receives a message not compatible with the protocol state, the network actions are implementation dependent.

#### 8.5 Non-semantical mandatory information element errors

When on receipt of a message:

- an "imperative message part" error; or
- a "missing mandatory IE" error;

is diagnosed or when a message containing:

- a syntactically incorrect mandatory IE; or
- an IE unknown in the message, but encoded as "comprehension required" (see section 10.5); or
- an out of sequence IE encoded as "comprehension required" (see section 10.5);

is received;

- the mobile station shall proceed as follows:

When the message is not one of the messages listed in sections 8.5.1, 8.5.2, and 8.5.3, the Mobile Station shall ignore the message except for the fact that, if an RR connection exists, it shall return a status message (STATUS, RR STATUS or MM STATUS depending on the protocol discriminator) with cause # 96 "invalid mandatory information".

- the network shall proceed as follows:

When the message is not one of the message listed in section 8.5.3 b), c) or e), the network shall either:

- try to treat the message (the exact further actions are implementation dependent); or
- ignore the message except that it should return a status message (STATUS, RR STATUS or MM STATUS depending on the protocol discriminator) with cause # 96 "invalid mandatory information".

### **8.5.1 Radio resource management**

For the Mobile Station the following procedures shall apply:

- a) If the message is a CHANNEL RELEASE message, the actions taken shall be the same as specified in 3.5 "RR connection release".
- b) If the message is a PARTIAL RELEASE message, the reactions of the MS are for further study.

### **8.5.2 Mobility management**

No exceptional cases are described for mobility management messages.

### **8.5.3 Call control**

- a) If the message is a SETUP, EMERGENCY SETUP or a RELEASE message, a RELEASE COMPLETE message with cause # 96 "invalid mandatory information" shall be returned.
- b) If the message is a DISCONNECT message, a RELEASE message shall be returned with cause value # 96 "invalid mandatory information" and section 5.4. "call clearing" applies as normal.
- c) If the message is a RELEASE COMPLETE message, it shall be treated as a normal RELEASE COMPLETE message.
- d) If the message is a HOLD REJECT or RETRIEVE REJECT message, it shall be treated as a normal HOLD REJECT or RETRIEVE REJECT message.
- e) If the message is a STATUS message and received by the network, a RELEASE COMPLETE message may be returned with cause value # 96 "invalid mandatory information".

## **8.6 Unknown and unforeseen IEs in the non-imperative message part**

### **8.6.1 IEs unknown in the message**

The MS shall ignore all IEs unknown in a message which are not encoded as "comprehension required".

The network shall take the same approach.

### **8.6.2 Out of sequence IEs**

The MS shall ignore all out of sequence IEs in a message which are not encoded as "comprehension required".

The network should take the same approach.

### 8.6.3 Repeated IEs

If an information element with format T, TV, or TLV is repeated in a message in which repetition of the information element is not specified in section 9 of this technical specification, only the contents of the information element appearing first shall be handled and all subsequent repetitions of the information element shall be ignored. When repetition of information elements is specified, only the contents of specified repeated information elements shall be handled. If the limit on repetition of information elements is exceeded, the contents of information elements appearing first up to the limit of repetitions shall be handled and all subsequent repetitions of the information element shall be ignored.

The network should follow the same procedures.

### 8.7 Non-imperative message part errors

This category includes:

- syntactically incorrect optional IEs;
- conditional IE errors.

#### 8.7.1 Syntactically incorrect optional IEs

The MS shall treat all optional IEs that are syntactically incorrect in a message as not present in the message.

The network shall take the same approach.

#### 8.7.2 Conditional IE errors

When the MS upon receipt of a message diagnoses a "missing conditional IE" error or an "unexpected conditional IE" error or when it receives a message containing at least one syntactically incorrect conditional IE, it shall ignore the message except for the fact that, if an RR connection exists, it shall return a status message (STATUS, RR STATUS, or MM STATUS depending on the PD) with cause value # 100 "conditional IE error".

When the network receives a message and diagnose a "missing conditional IE" error or an "unexpected conditional IE" error or when it receives a message containing at least one syntactically incorrect conditional IE, the network shall either:

- try to treat the message (the exact further actions are implementation dependent); or
- ignore the message except that it should return a status message (STATUS, RR STATUS or MM STATUS depending on the protocol discriminator) with cause # 100 "conditional IE error".

### 8.8 Messages with semantically incorrect contents

When a message with semantically incorrect contents is received, the foreseen reactions of the procedural part of GSM 04.08 (i.e. of sections 3, 4, 5) are performed. If however no such reactions are specified, the MS shall ignore the message except for the fact that, if an RR connection exists, it returns a status message (STATUS, RR STATUS, or MM STATUS depending on the PD) with cause value # 95 "semantically incorrect message".

The network should follow the same procedure except that a status message is not normally transmitted.

Semantic checking of the Facility information element value part (defined in GSM 04.80) is the subject of the technical specifications GSM 04.10 and the GSM 04.8x series.

## 9 MESSAGE FUNCTIONAL DEFINITIONS AND CONTENTS

This section defines the structure of the messages of those layer 3 protocols defined in GSM 04.08. These are standard L3 messages as defined in GSM 04.07 with the exception of those sent on the SCH, RACH, and the HANDOVER ACCESS message.

Each definition given in the present section includes:

- a) A brief description of the message direction and use, including whether the message has:
  1. Local significance, i.e. relevant only on the originating or terminating access;
  2. Access significance, i.e. relevant in the originating and terminating access, but not in the network;
  3. Dual significance, i.e. relevant in either the originating or terminating access and in the network; or
  4. Global significance, i.e. relevant in the originating and terminating access and in the network.
- b) A table listing the information elements known in the message and their order of their appearance in the message. In messages for circuit-switched call control also a *shift* information element shall be considered as known even if not included in the table. All information elements that may be repeated are explicitly indicated. ( V and LV formatted IEs, which compose the imperative part of the message, occur before T, TV, and TLV formatted IEs which compose the non-imperative part of the message, cf. GSM 04.07.) In a (maximal) sequence of consecutive information elements with half octet length, the first information element with half octet length occupies bits 1 to 4 of octet N, the second bits 5 to 8 of octet N, the third bits 1 to 4 of octet N+1 etc. Such a sequence always has an even number of elements.

For each information element the table indicates:

1. The information element identifier, in hexadecimal notation, if the IE has format T, TV, or TLV. Usually, there is a default IEI for an information element type; default IEIs of different IE types of the same protocol are different. If the IEI has half octet length, it is specified by a notation representing the IEI as a hexadecimal digit followed by a "-" (example: B-).
  2. The name of the information element (which may give an idea of the semantics of the element). The name of the information element (usually written in italics) followed by "IE" or "information element" is used in GSM 04.08 as reference to the information element within a message.
  3. The name of the type of the information element (which indicates the coding of the value part of the IE), and generally, the referenced subsection of section 10 of GSM 04.08 describing the value part of the information element.
  4. The presence requirement indication (M, C, or O) for the IE as defined in GSM 04.07.
  5. The format of the information element (T, V, TV, LV, TLV) as defined in GSM 04.07.
  6. The length of the information element (or permissible range of lengths), in octets, in the message, where "?" means that the maximum length of the IE is only constrained by link layer protocol, and in the case of the Facility IE by possible further conditions specified in GSM 04.10. This indication is non-normative.
- c) Subsections specifying, where appropriate, conditions for IEs with presence requirement C or O in the relevant message which together with other conditions specified in GSM 04.08 define when the information elements shall be included or not, what non-presence of such IEs means, and - for IEs with presence requirement C - the static conditions for presence and/or non-presence of the IEs (cf. GSM 04.07).

## 9.1 Messages for Radio Resources management

Table 9.1/GSM 04.08 summarizes the messages for Radio Resources management.

Channel establishment messages:	Reference
ADDITIONAL ASSIGNMENT	9.1.1
IMMEDIATE ASSIGNMENT	9.1.18
IMMEDIATE ASSIGNMENT EXTENDED	9.1.19
IMMEDIATE ASSIGNMENT REJECT	9.1.20
Ciphering messages:	Reference
CIPHERING MODE COMMAND	9.1.9
CIPHERING MODE COMPLETE	9.1.10
Handover messages:	Reference
ASSIGNMENT COMMAND	9.1.2
ASSIGNMENT COMPLETE	9.1.3
ASSIGNMENT FAILURE	9.1.4
HANDOVER ACCESS	9.1.14
HANDOVER COMMAND	9.1.15
HANDOVER COMPLETE	9.1.16
HANDOVER FAILURE	9.1.17
PHYSICAL INFORMATION	9.1.28
Channel release messages:	Reference
CHANNEL RELEASE	9.1.7
PARTIAL RELEASE	9.1.26
PARTIAL RELEASE COMPLETE	9.1.27
Paging messages:	Reference
PAGING REQUEST TYPE 1	9.1.22
PAGING REQUEST TYPE 2	9.1.23
PAGING REQUEST TYPE 3	9.1.24
PAGING RESPONSE	9.1.25

**Table 9.1/GSM 04.08:  
Messages for Radio Resources management**

System information messages:	Reference
SYSTEM INFORMATION TYPE 1	9.1.31
SYSTEM INFORMATION TYPE 2	9.1.32
SYSTEM INFORMATION TYPE 2bis	9.1.33
SYSTEM INFORMATION TYPE 2ter	9.1.34
SYSTEM INFORMATION TYPE 3	9.1.35
SYSTEM INFORMATION TYPE 4	9.1.36
SYSTEM INFORMATION TYPE 5	9.1.37
SYSTEM INFORMATION TYPE 5bis	9.1.38
SYSTEM INFORMATION TYPE 5ter	9.1.39
SYSTEM INFORMATION TYPE 6	9.1.40
SYSTEM INFORMATION TYPE 7	9.1.41
SYSTEM INFORMATION TYPE 8	9.1.42
Miscellaneous messages:	Reference
CHANNEL MODE MODIFY	9.1.5
CHANNEL MODE MODIFY ACKNOWLEDGE	9.1.6
CHANNEL REQUEST	9.1.8
CLASSMARK CHANGE	9.1.11
CLASSMARK ENQUIRY	9.1.12
FREQUENCY REDEFINITION	9.1.13
MEASUREMENT REPORT	9.1.21
SYNCHRONIZATION CHANNEL INFORMATION	9.1.30
RR STATUS	9.1.29

**Table 9.1/GSM 04.08:**  
**Messages for Radio Resources management**  
**(continued)**



### 9.1.1 Additional assignment

This message is sent on the main DCCH by the network to the mobile station to allocate an additional dedicated channel while keeping the previously allocated channels (see table 9.2/GSM 04.08).

Message type: ADDITIONAL ASSIGNMENT

Significance: dual

Direction: network to mobile station

IEI	Information element	Type / Reference	Presence	Format	length
	RR management Protocol Discriminator	Protocol Discriminator 10.2	M	V	1/2
	Skip Indicator	Skip Indicator 10.3.1	M	V	1/2
	Additional Assignment Message Type	Message Type 10.4	M	V	1
	Channel Description	Channel Description 10.5.2.5	M	V	3
72	Mobile Allocation	Mobile Allocation 10.5.2.21	C	TLV	3-10
7C	Starting Time	Starting Time 10.5.2.38	O	TV	3

**Table 9.2/GSM 04.08:  
ADDITIONAL ASSIGNMENT message content**

#### 9.1.1.1 Mobile Allocation

This information element shall appear if the *Channel Description* information element indicates frequency hopping.

If the *Channel Description* IE does not indicate frequency hopping and the information element is present it shall be considered as an IE unnecessary in the message.

#### 9.1.1.2 Starting Time

This information element appears in particular if e.g., a change of frequency is planned.

### 9.1.2 Assignment command

This message is sent on the main DCCH by the network to the mobile station to change the channel configuration to another independent dedicated channel configuration, when no timing adjustment is needed (see table 9.3/GSM 04.08).

Message type: ASSIGNMENT COMMAND

Significance:dual

Direction: network to mobile station

IEI	Information element	Type / Reference	Presence	Format	length
	RR management Protocol Discriminator	Protocol Discriminator 10.2	M	V	1/2
	Skip Indicator	Skip Indicator 10.3.1	M	V	1/2
	Assignment command Message Type	Message Type 10.4	M	V	1
	Description of the First Channel, after time	Channel Description 10.5.2.5	M	V	3
	Power Command	Power Command 10.5.2.28	M	V	1
05	Frequency List, after time	Frequency List 10.5.2.13	C	TLV	4-132
62	Cell Channel Description	Cell Channel Description 10.5.2.1b	O	TV	17
63	Mode of the First Channel	Channel Mode 10.5.2.6	O	TV	2
64	Description of the Second Channel, after time	Channel Description 10.5.2.5	O	TV	4
66	Mode of the Second Channel	Channel Mode 2 10.5.2.7	O	TV	2
72	Mobile Allocation, after time	Mobile Allocation 10.5.2.21	C	TLV	3-10
7C	Starting Time	Starting Time 10.5.2.38	O	TV	3
19	Frequency List, before time	Frequency List 10.5.2.13	C	TLV	4-132
1C	Description of the First Channel, before time	Channel Description 10.5.2.5	O	TV	4
1D	Description of the Second Channel, before time	Channel Description 10.5.2.5	O	TV	4
1E	Frequency channel sequence before time	Frequency channel sequence 10.5.2.12	C	TV	10
21	Mobile Allocation, before time	Mobile Allocation 10.5.2.21	C	TLV	3-10
9-	Cipher Mode Setting	Cipher Mode Setting 10.5.2.9	O	TV	1

**Table 9.3/GSM 04.08:  
ASSIGNMENT COMMAND message content**

#### 9.1.2.1 Mode of the First Channel

If this information element is not present the channel mode of the previously allocated channel is assumed.

#### 9.1.2.2 Description of the Second Channel

These information elements appear in the case of an assignment occurring if the mobile station carries two connections (on two dedicated channels, e.g. TCH/H + TCH/H).

The connection using the channel previously defined in the *Description of the First Channel* IEs of an ASSIGNMENT COMMAND or HANDOVER COMMAND message shall use the channel defined in the *Description of the First Channel* IEs of the ASSIGNMENT COMMAND message defining the new configuration.

The channel described in the *Description of the First Channel* IEs carries the main DCCH. The SACCH used is the one associated with that channel.

#### 9.1.2.3 Mode of the Second Channel

If no *Description of the Second Channel* IE is present but the information element is present it shall be considered as an IE unnecessary in the message.

This information element appears at least when the channel mode is changed for the channel defined in the second channel description information elements.

#### 9.1.2.4 Mobile Allocation and Frequency List, after the starting time

If at least one of the channel descriptions for the starting time indicates frequency hopping, one and only one of the following information elements shall be present and apply to all assigned channels:

- *Mobile Allocation, after time;*
- *Frequency List, after time.*

If neither of the Channel Description IEs for after time indicate frequency hopping, if decoding of Channel Description IEs for before time does not require a frequency list for after time (see next section), and one or both of the two information elements are present they shall be considered as IEs unnecessary in the message.

#### 9.1.2.5 Starting Time

The *starting time* information element is included when the network wants the mobile station to change the frequency parameters of the channels more or less at the moment a change of channel occurs. In this case a number of information elements may be included to give the frequency parameters to be used before the starting time.

If the *starting time* information element is present and none of the information elements referring to before the starting time are present, the mobile station waits and accesses the channels at the indicated time.

If the *starting time* information element is present and at least one of the information elements referring to before the starting time is present, the mobile station does not wait for the indicated time and accesses the channel using the frequency parameters for before the starting time.

If the *starting time* information element is not present and at some of the information elements referring to before the starting time is present, these information elements shall be considered as IEs unnecessary in the message.

If the *description of the first channel, before time* IE is not present, the channel description to apply for before the time, if needed, is given by the *description of the first channel, after time* IE.

If the *description of the second channel, after time* IE is present, the *description of the second channel, before time* IE not present, and a description of the configuration for before the time needed, the channel configuration before the starting time is nevertheless of two traffic channels, and the channel description to apply to the second channel before the starting time is given by the *description of the second channel, after time* IE.

If the *starting time* IE is present and at least one of the channel descriptions for before the starting time indicates frequency hopping, one and only one of the following information elements may be present and applies before the starting time to all assigned channels:

- *Mobile Allocation, before time* IE;
- *Frequency list, before time* IE;
- *Frequency channel sequence, before time* IE.

If the *starting time* IE is present and at least one of the channel descriptions for before the starting time indicates frequency hopping, and none of the above mentioned IE is present, a frequency list for after the starting time must be present (see section 9.1.2.4), and this list applies also for the channels before the starting time.

#### 9.1.2.6 Reference cell frequency list

If any of the *mobile allocation* information elements is present, then the network must ensure that either the mobile station has received in a previous message the proper reference cell frequency list (CA), or that the *cell channel description* IE is present.

If the *cell channel description* IE is present, it is used to decode the *mobile allocation* IEs in the message, as well as in later messages until reception of a new reference cell frequency list or the cell is left.

#### 9.1.2.7 Cell Channel Description

If present, this information element shall be used to decode the *Mobile Allocation* IE in the same message and in subsequent messages.

#### 9.1.2.8 Cipher Mode Setting

This information element appears when the ciphering mode is changed after the mobile station has switched to the assigned channel.

If this information element is omitted, the mode of ciphering is not changed after the mobile station has switched to the assigned channel.

### 9.1.3 Assignment complete

This message is sent on the main DCCH from the mobile station to the network to indicate that the mobile station has established the main signalling link successfully (see table 9.4/GSM 04.08).

Message type: ASSIGNMENT COMPLETE

Significance:dual

Direction: mobile station to network

IEI	Information element	Type / Reference	Presence	Format	length
	RR management Protocol Discriminator	Protocol Discriminator 10.2	M	V	1/2
	Skip Indicator	Skip Indicator 10.3.1	M	V	1/2
	Assignment Complete Message Type	Message Type 10.4	M	V	1
	RR Cause	RR Cause 10.5.2.31	M	V	1

**Table 9.4/GSM 04.08:  
ASSIGNMENT COMPLETE message content**

**9.1.4 Assignment failure**

This message is sent on the main DCCH on the old channel from the mobile station to the network to indicate that the mobile station has failed to seize the new channel (see table 9.5/GSM 04.08).

Message type: ASSIGNMENT FAILURE

Significance:dual

Direction: mobile station to network

<b>IEI</b>	<b>Information element</b>	<b>Type / Reference</b>	<b>Presence</b>	<b>Format</b>	<b>length</b>
	RR management Protocol Discriminator	Protocol Discriminator 10.2	M	V	1/2
	Skip Indicator	Skip Indicator 10.3.1	M	V	1/2
	Assignment Failure Message Type	Message Type 10.4	M	V	1
	RR cause	RR Cause 10.5.2.31	M	V	1

**Table 9.5/GSM 04.08:  
 ASSIGNMENT FAILURE message content**

### 9.1.5 Channel mode modify

This message is sent on the main DCCH by the network to the mobile station to request the setting of the mode for the indicated channel (see table 9.6/GSM 04.08).

Message type: CHANNEL MODE MODIFY

Significance: local

Direction: network to mobile station

IEI	Information element	Type / Reference	Presence	Format	length
	RR management Protocol Discriminator	Protocol Discriminator 10.2	M	V	1/2
	Skip Indicator	Skip Indicator 10.3.1	M	V	1/2
	Channel Mode Modify Message Type	Message Type 10.4	M	V	1
	Channel Description	Channel Description 10.5.2.5	M	V	3
	Channel Mode	Channel Mode 10.5.2.6	M	V	1

**Table 9.6/GSM 04.08:**  
**CHANNEL MODE MODIFY message content**

#### 9.1.5.1 Channel Description

This is sufficient to identify the channel in the case of a TCH/H + TCH/H configuration.



### 9.1.6 Channel mode modify acknowledge

This message is sent on the main DCCH by the mobile station to the network to indicate the successful or unsuccessful execution of a channel mode modify request (see table 9.7/GSM 04.08).

Message type: CHANNEL MODE MODIFY ACKNOWLEDGE

Significance: local

Direction: mobile station to network

IEI	Information element	Type / Reference	Presence	Format	length
	RR management Protocol Discriminator	Protocol Discriminator 10.2	M	V	1/2
	Skip Indicator	Skip Indicator 10.3.1	M	V	1/2
	Channel Mode Modify Acknowledge Message Type	Message Type 10.4	M	V	1
	Channel Description	Channel Description 10.5.2.5	M	V	3
	Channel Mode	Channel Mode 10.5.2.6	M	V	1

**Table 9.7/GSM 04.08:  
 CHANNEL MODE MODIFY ACKNOWLEDGE message content**

### 9.1.7 Channel release

This message is sent on the main DCCH from the network to the mobile station to initiate deactivation of the dedicated channel used (see table 9.8/GSM 04.08).

Message type: CHANNEL RELEASE

Significance:dual

Direction: network to mobile station

IEI	Information element	Type / Reference	Presence	Format	length
	RR management Protocol Discriminator	Protocol Discriminator 10.2	M	V	1/2
	Skip Indicator	Skip Indicator 10.3.1	M	V	1/2
	Channel Release Message Type	Message Type 10.4	M	V	1
	RR Cause	RR Cause 10.5.2.31	M	V	1
73	BA Range	BA Range 10.5.2.1	O	TLV	6 - ?

**Table 9.8/GSM 04.08:  
CHANNEL RELEASE message content**

### 9.1.8 Channel request

This message is sent in random mode on the RACH. It does not follow the basic format. The possible formats are presented directly below, without reference to information fields. The order of bit transmission is defined in GSM 04.04.

The message is only one octet long, coded as shown in figure 9.1/GSM 4.08 and table 9.9/GSM 04.08.

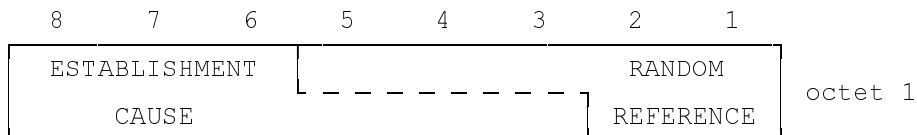

**Figure 9.1/GSM 04.08:  
 CHANNEL REQUEST message content**

#### ESTABLISHMENT CAUSE (octet 1)

This information field indicates the reason for requesting the establishment of a connection. This field has a variable length (from 3 bits up to 6 bits).

#### RANDOM REFERENCE (octet 1)

This is an unformatted field with variable length (from 5 bits down to 2 bits).

The Channel Request message is coded as follows:

(Random Reference field is filled with "x").

MS codes bits 8 ... 1	According to Establishment cause:
101xxxxx	Emergency call
110xxxxx	Call re-establishment; TCH/F was in use, or TCH/H was in use but the network does not set NECI bit to 1
011010xx	Call re-establishment; TCH/H was in use and the network sets NECI bit to 1
011011xx	Call re-establishment; TCH/H + TCH/H was in use and the network sets NECI bit to 1
100xxxxx 0010xxxx 0011xxxx 0001xxxx	Answer to paging  See table 9.9a/GSM 04.08
111xxxxx	Originating call and TCH/F is needed, or originating call and the network does not set NECI bit to 1, or procedures that can be completed with a SDCCH and the network does not set NECI bit to 1. <span style="float: right;">note 1</span>
0100xxxx	Originating speech call from dual-rate mobile station when TCH/H is sufficient and the network sets NECI bit to 1
0101xxxx	Originating data call from dual-rate mobile station when TCH/H is sufficient and the network sets NECI bit to 1
000xxxxx	Location updating and the network does not set NECI bit to 1
0000xxxx	Location updating and the network sets NECI bit to 1
0001xxxx	Other procedures which can be completed with an SDCCH and the network sets NECI bit to 1 <span style="float: right;">note 1</span>
01100xxx 0111xxxx	Reserved for future use <span style="float: right;">note 2</span>

**Table 9.9/GSM 04.08:  
 CHANNEL REQUEST message content**

NOTE 1: Examples of these procedures are: IMSI detach, Short Message Service (SMS), Supplementary Service management.

NOTE 2: If such messages are received by a network, an SDCCH may be allocated.

MS Capability Paging Indication 3)	Full rate only	Dual rate	SDCCH only
Any channel	100xxxxx	100xxxxx	100xxxxx
SDCCH	0001xxxx	0001xxxx	0001xxxx
TCH/F	100xxxxx	0010xxxx	0001xxxx
TCH/H or TCH/F	100xxxxx	0011xxxx	0001xxxx

**Table 9.9a/GSM 04.08:  
CHANNEL REQUEST message (when answering to paging)**

NOTE 3: The Paging Indication is provided by the Channel Needed IE (or the Channel Needed field) associated with the page which triggered the sending of the CHANNEL REQUEST message.

NOTE 4: In some cases the established connection will be used only to allow a default rejection mechanism to take place (typically the mobile station will send a RELEASE COMPLETE message with cause #88 "incompatible destination" as an answer to the incoming SETUP message).

### 9.1.9 Ciphering mode command

This message is sent on the main DCCH from the network to the mobile station to indicate that the network has started deciphering and that enciphering and deciphering shall be started in the mobile station, or to indicate that ciphering will not be performed (see table 9.10/GSM 04.08).

Message type: CIPHERING MODE COMMAND

Significance:dual

Direction: network to mobile station

IEI	Information element	Type / Reference	Presence	Format	length
	RR management Protocol Discriminator	Protocol Discriminator 10.2	M	V	1/2
	Skip Indicator	Skip Indicator 10.3.1	M	V	1/2
	Cipher Mode Command Message Type	Message Type 10.4	M	V	1
	Ciphering Mode Setting	Cipher Mode Setting 10.5.2.9	M	V	1/2
	Cipher Response	Cipher Response 10.5.2.10	M	V	1/2

**Table 9.10/GSM 04.08:  
CIPHERING MODE COMMAND message content**

### 9.1.10 Ciphering mode complete

This message is sent on the main DCCH from the mobile station to the network to indicate that enciphering and deciphering has been started in the mobile station (see table 9.11/GSM 04.08).

Message type: CIPHERING MODE COMPLETE

Significance:dual

Direction: mobile station to network

IEI	Information element	Type / Reference	Presence	Format	length
	RR management Protocol Discriminator	Protocol Discriminator 10.2	M	V	1/2
	Skip Indicator	Skip Indicator 10.3.1	M	V	1/2
	Cipher Mode Complete Message Type	Message Type 10.4	M	V	1
17	Mobile Equipment Identity	Mobile Identity 10.5.1.4	O	TLV	3-11

**Table 9.11/GSM 04.08:  
CIPHERING MODE COMPLETE message content**

#### 9.1.10.1 Mobile Equipment Identity

This information element is included if and only if the mobile station shall include its IMEISV (see section 3.4.7). This information element shall only refer to IMEISV.

**9.1.11 Classmark change**

This message is sent on the main DCCH by the mobile station to the network to indicate a classmark change or as a response to a classmark enquiry (see table 9.12/GSM 04.08).

Message type: CLASSMARK CHANGE  
Significance:dual  
Direction: mobile station to network

IEI	Information element	Type / Reference	Presence	Format	length
	RR management Protocol Discriminator	Protocol Discriminator 10.2	M	V	1/2
	Skip Indicator	Skip Indicator 10.3.1	M	V	1/2
	Classmark Change Message Type	Message Type 10.4	M	V	1
	Mobile Station Classmark	Mobile Station Classmark 2 10.5.1.6	M	LV	4
20	Additional Mobile Station Classmark Information	Mobile Station Classmark 3 10.5.1.7	C	TLV	3-14

**Table 9.12/GSM 04.08:  
CLASSMARK CHANGE message content**

**9.1.11.1 Additional Mobile Station Classmark Information**

This IE shall be included if and only if the CM3 bit in the *Mobile Station Classmark* IE is set to "additional mobile station capabilities are described in the Classmark 3 information element".

**9.1.11.2 Mobile Station Classmark**

This IE shall include for multiband mobile station the Classmark 2 corresponding to the frequency band in use.

**9.1.12 Classmark enquiry**

This message is sent on the main DCCH by the network to the mobile station to request classmark information (see table 9.12a/GSM 04.08).

Message type: CLASSMARK ENQUIRY  
Significance:dual  
Direction: network to mobile station

IEI	Information element	Type / Reference	Presence	Format	length
	RR management Protocol Discriminator	Protocol Discriminator 10.2	M	V	1/2
	Skip Indicator	Skip Indicator 10.3.1	M	V	1/2
	Classmark Enquiry Message Type	Message Type 10.4	M	V	1

**Table 9.12a/GSM 04.08:  
CLASSMARK ENQUIRY message content**

### 9.1.13 Frequency redefinition

This message is sent on the main DCCH from the network to the mobile station to indicate that the frequencies and the hopping sequence of the allocated channels shall be changed (see table 9.13/GSM 04.08).

Message type: FREQUENCY REDEFINITION

Significance:dual

Direction: network to mobile station

IEI	Information element	Type / Reference	Presence	Format	length
	RR management Protocol Discriminator	Protocol Discriminator 10.2	M	V	1/2
	Skip Indicator	Skip Indicator 10.3.1	M	V	1/2
	Frequency Redefinition Message Type	Message Type 10.4	M	V	1
	Channel Description	Channel Description 10.5.2.5	M	V	3
	Mobile Allocation	Mobile Allocation 10.5.2.21	M	LV	1-9
	Starting Time	Starting Time 10.5.2.38	M	V	2
62	Cell Channel Description	Cell Channel Description 10.5.2.1b	O	TV	17

**Table 9.13/GSM 04.08:  
FREQUENCY REDEFINITION message content**

#### 9.1.13.1 Cell Channel Description

If it does not appear, the cell channel description is assumed to be unchanged.

#### 9.1.14 Handover access

This message is sent in random mode on the main DCCH during a handover procedure. It does not follow the basic format. The format is presented directly below without reference to information elements. The order of bit transmission is defined in GSM 04.04.

This message is only one octet long, coded as shown in figure 9.2/GSM 04.08 and table 9.14/GSM 04.08.

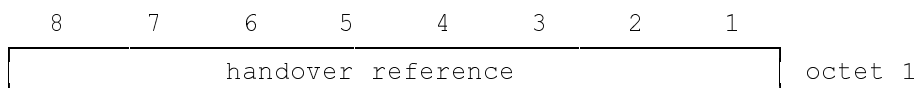

**Figure 9.2/GSM 04.08:  
HANDOVER ACCESS message content**

<p>HANDOVER REFERENCE This is an unformatted 8 bit field. (also described in section 10.5.2.15)</p>
---

**Table 9.14/GSM 04.08:  
HANDOVER ACCESS message content**

**9.1.15 Handover command**

This message is sent on the main DCCH by the network to the mobile station to change the dedicated channel configuration, timing adjustment needed (see table 9.15/GSM 04.08).

Message type: HANOVER COMMAND  
Significance:dual  
Direction: network to mobile station

IEI	Information element	Type / Reference	Presence	Format	length
	RR management Protocol Discriminator	Protocol Discriminator 10.2	M	V	1/2
	Skip Indicator	Skip Indicator 10.3.1	M	V	1/2
	Handover Command Message Type	Message Type 10.4	M	V	1
	Cell Description	Cell description 10.5.2.2	M	V	2
	Description of the first channel, after time	Channel Description 10.5.2.5	M	V	3
	Handover Reference	Handover Reference 10.5.2.15	M	V	1
	Power Command and Access type	Power Command and Access type 10.5.2.28a	M	V	1
D-	Synchronization Indication	Synchronization Indication 10.5.2.39	O	TV	1
02	Frequency Short List, after time	Frequency Short List 10.5.2.14	C	TV	10
05	Frequency List, after time	Frequency List 10.5.2.13	C	TLV	4-131
62	Cell Channel Description	Cell Channel Description 10.5.2.1b	C	TV	17
63	Mode of the First Channel	Channel Mode 10.5.2.6	O	TV	2

**Table 9.15/GSM 04.08:  
HANOVER COMMAND message content**



64	Description of the Second Channel, after time	Channel Description 10.5.2.5	O	TV	4
66	Mode of the Second Channel	Channel Mode 2 10.5.2.7	O	TV	2
69	Frequency Channel Sequence, after time	Frequency Channel Sequence 10.5.2.12	C	TV	10
72	Mobile Allocation, after time	Mobile Allocation 10.5.2.21	C	TLV	3-10
7C	Starting Time	Starting Time 10.5.2.38	O	TV	3
7B	Real Time Difference	Time Difference 10.5.2.41	C	TLV	3
7D	Timing Advance	Timing Advance 10.5.2.40	C	TV	2
12	Frequency Short List, before time	Frequency Short List 10.5.2.14	C	TV	10
19	Frequency List, before time	Frequency List 10.5.2.13	C	TLV	4-131
1C	Description of the First Channel, before time	Channel Description 10.5.2.5	O	TV	4
1D	Description of the Second Channel, before time	Channel Description 10.5.2.5	O	TV	4
1E	Frequency channel sequence before time	Frequency channel sequence 10.5.2.12	C	TV	10
21	Mobile Allocation, before time	Mobile Allocation 10.5.2.21	C	TLV	3-10
9-	Cipher Mode Setting	Cipher Mode Setting 10.5.2.9	O	TV	1

**Table 9.15/GSM 04.08 (continued):  
HANDOVER COMMAND message content**

#### **9.1.15.1 Synchronization Indication**

If this information element does not appear, the assumed value is "non-synchronized".

#### **9.1.15.2 Mode of the First Channel**

If this information element is not present the channel mode of the first previously allocated channel is assumed.

### 9.1.15.3 Description of the Second Channel

These information element appear if the mobile station carries two connections (on two dedicated channels, e.g. TCH/H+TCH/H).

The connection using the channel previously defined in the *Description of the First Channel* IE of an ASSIGNMENT COMMAND or HANDOVER COMMAND message shall use the channel defined in the first channel description IE of the HANDOVER COMMAND message defining the new configuration.

The channel described in the *Description of the First Channel* IE carries the main DCCH. The SACCH used is the one associated with that channel.

### 9.1.15.4 Mode of the Second Channel

If the *Description of the Second Channel* IE is not present and the information element is present it shall be considered as an IE unnecessary in the message.

This element appears at least when the channel mode is changed for the channel defined in the Description of the Second Channel information element.

### 9.1.15.5 Frequency Channel Sequence, Frequency List, Frequency short list and Mobile Allocation, after time.

If at least one of the channel descriptions for after time indicates frequency hopping, one and only one of the following information elements shall be present:

- *Frequency Channel Sequence, after time;*
- *Frequency list, after time;*
- *Frequency Short List, after time;*
- *Mobile Allocation, after time.*

If neither of the Channel Description IEs indicate frequency hopping, if they are not required for the decoding of Channel Description IEs for before time, and if any of the four information elements are present they shall be considered as IEs unnecessary in the message.

The *Frequency Channel Sequence* information element shall not be used unless all the ARFCNs that it indicates are in the PGSM band.

#### 9.1.15.6 Starting Time

The *starting time* information element is included when the network wants the mobile station to change the frequency parameters of the channels more or less at the moment a change of channel occurs. In this case a number of information elements may be included to give the frequency parameters to be used before the starting time.

The *starting time* information element refers to the new cell time.

If the *starting time* information element is present and none of the information elements referring to before the starting time are present, the mobile station waits and accesses the channels at the indicated time.

If the *starting time* information element is present and at least one of the information elements referring to before the starting time is present, the mobile station does not wait for the indicated time and accesses the channel using the frequency parameters for before the starting time.

If the *starting time* information element is not present and some of the information elements referring to before the starting time is present, these information elements shall be considered as IEs unnecessary in the message.

If the *description of the first channel, before time* IE is not present, the channel description to apply for before the time, if needed, is given by the *description of the first channel, after time* IE.

If the *description of the second channel, after time* IE is present, the *description of the second channel, before time* IE not present, and a description of the configuration for before the time needed, the channel configuration before the starting time is nevertheless of two traffic channels, and the channel description to apply to the second channel before the starting time is given by the *description of the second channel, after time* IE.

If the *starting time* IE is present and at least one of the channel descriptions for before the starting time indicates frequency hopping, one and only one of the following information elements may be present and applies before the starting time to all assigned channels:

- *Mobile Allocation, before time* IE;
- *Frequency Short list, before time* IE;
- *Frequency list, before time* IE;
- *Frequency channel sequence, before time* IE.

If the *starting time* IE is present and at least one of the channel descriptions for before the starting time indicates frequency hopping, and none of the above mentioned IE is present, a frequency list for after the starting time must be present (see section 9.1.2.4), and this list applies also for the channels before the starting time.

#### 9.1.15.7 Reference cell frequency list

If any of the *mobile allocation* information elements is present, then the *cell channel description* IE must be present. It is used to decode the *mobile allocation* IEs in the message.

In addition, if no information elements pertaining to before the starting time is present in the message, the frequency list defined by the *cell channel description* IE is used to decode the *mobile allocation* IEs in later messages received in the new cell until reception of a new reference cell frequency list or the new cell is left.

**9.1.15.8 Real Time Difference**

This information element shall appear if the *Synchronization Indication* information element indicates a pseudo-synchronous handover otherwise it shall be considered as an unnecessary information element.

**9.1.15.9 Timing Advance**

This information element shall appear if the "synchronization indication" element indicates a presynchronized handover. If not included for a presynchronized handover, then the default value as defined in GSM 05.10 shall be used. For other types of handover it shall be considered as an unnecessary information element.

**9.1.15.10 Cipher Mode Setting**

If this information element is omitted, the mode of ciphering is not changed after the mobile station has switched to the assigned channel.

**9.1.16 Handover complete**

This message is sent on the main DCCH from the mobile station to the network to indicate that the mobile station has established the main signalling link successfully (see table 9.16/GSM 04.08).

Message type: HANDOVER COMPLETE  
 Significance:dual  
 Direction: mobile station to network

IEI	Information element	Type / Reference	Presence	Format	length
	RR management Protocol Discriminator	Protocol Discriminator 10.2	M	V	1/2
	Skip Indicator	Skip Indicator 10.3.1	M	V	1/2
	Handover Complete Message Type	Message Type 10.4	M	V	1
	RR Cause	RR Cause 10.5.2.31	M	V	1
77	Mobile Observed Time Difference	Mobile Time Difference 10.5.2.21a	O	TLV	5

**Table 9.16/GSM 04.08:  
 HANDOVER COMPLETE message content**

**9.1.16.1 Mobile Observed Time Difference**

This information element is included if and only if the Synchronization Indication IE in the HANDOVER COMMAND message requests it to be sent.

**9.1.17 Handover failure**

This message is sent on the main DCCH on the old channel from the mobile station to the network to indicate that the mobile station has failed to seize the new channel (see table 9.17/GSM 04.08).

Message type: HANOVER FAILURE

Significance:dual

Direction: mobile station to network

<b>IEI</b>	<b>Information element</b>	<b>Type / Reference</b>	<b>Presence</b>	<b>Format</b>	<b>length</b>
	RR management Protocol Discriminator	Protocol Discriminator 10.2	M	V	1/2
	Skip Indicator	Skip Indicator 10.3.1	M	V	1/2
	Handover Failure Message Type	Message Type 10.4	M	V	1
	RR Cause	RR Cause 10.5.2.31	M	V	1

**Table 9.17/GSM 04.08:  
 HANOVER FAILURE message content**

**9.1.18 Immediate assignment**

This message is sent on the CCCH by the network to the mobile station in idle mode to change the channel configuration to a dedicated configuration while staying in the same cell (see table 9.18/GSM 04.08).

The L2 pseudo length of this message is the sum of lengths of all information elements present in the message except the *IA Rest Octets* and *L2 Pseudo Length* information elements.

Message type: IMMEDIATE ASSIGNMENT  
Significance:dual  
Direction: network to mobile station

IEI	Information element	Type / Reference	Presence	Format	length
	L2 Pseudo Length	L2 Pseudo Length 10.5.2.19	M	V	1
	RR management Protocol Discriminator	Protocol Discriminator 10.2	M	V	1/2
	Skip Indicator	Skip Indicator 10.3.1	M	V	1/2
	Immediate Assignment Message Type	Message Type 10.4	M	V	1
	Page Mode	Page Mode 10.5.2.26	M	V	1/2
	Spare Half Octet	Spare Half Octet 10.5.1.8	M	V	1/2
	Channel Description	Channel Description 10.5.2.5	M	V	3
	Request Reference	Request Reference 10.5.2.30	M	V	3
	Timing Advance	Timing Advance 10.5.2.40	M	V	1
	Mobile Allocation	Mobile Allocation 10.5.2.21	M	LV	1-9
7C	Starting Time	Starting Time 10.5.2.38	O	TV	3
	IA Rest Octets (frequency parameters, before time)	IA Rest Octets 10.5.2.16	M	V	0-11

**Table 9.18/GSM 04.08:  
IMMEDIATE ASSIGNMENT message content**

#### 9.1.18.1 Mobile Allocation

If the *Channel Description* IE does not indicate frequency hopping the length indicator shall be set to zero, and the mobile station shall consider the IE as an unnecessary IE.

#### 9.1.18.2 Starting Time

This information element appears if e.g. a frequency change is in progress.

#### 9.1.18.3 IA Rest Octets (Frequency parameters, before time)

The sum of the length of this IE and the L2 Pseudo Length of the message equals 22.

If the *starting time* IE is present but not the *frequency parameters, before time* IE, the mobile stations must wait until the starting time before accessing the channel.

If the *starting time* IE is present and the *Channel Description* IE does not indicate frequency hopping the mobile station shall consider the *frequency parameters, before time* IE as unnecessary in the message and the mobile must wait until the starting time before accessing the channel.

If the *starting time* IE is not present, the mobile station shall consider the *frequency parameters, before time* IE as unnecessary in the message.

**9.1.19 Immediate assignment extended**

This message is sent on the CCCH by the network to two mobile stations in idle mode to change their channel configurations to different dedicated configurations while they stay in the same cell (see table 9.19/GSM 04.08).

The L2 pseudo length of this message is the sum of lengths of all information elements present in the message except the *IAX Rest Octets* and *L2 Pseudo Length* information elements.

Message type: IMMEDIATE ASSIGNMENT EXTENDED  
Significance:dual  
Direction: network to mobile station

IEI	Information element	Type / Reference	Presence	Format	length
	L2 Pseudo Length	L2 Pseudo Length 10.5.2.19	M	V	1
	RR management Protocol Discriminator	Protocol Discriminator 10.2	M	V	1/2
	Skip Indicator	Skip Indicator 10.3.1	M	V	1/2
	Immediate Assignment Extended Message Type	Message Type 10.4	M	V	1
	Page Mode	Page Mode 10.5.2.26	M	V	1/2
	Spare Half Octet	Spare Half Octet 10.5.1.8	M	V	1/2
	Channel Description 1	Channel Description 10.5.2.5	M	V	3
	Request Reference 1	Request Reference 10.5.2.30	M	V	3
	Timing Advance 1	Timing Advance 10.5.2.40	M	V	1
	Channel Description 2	Channel Description 10.5.2.5	M	V	3
	Request Reference 2	Request Reference 10.5.2.30	M	V	3
	Timing Advance 2	Timing Advance 10.5.2.40	M	V	1
	Mobile Allocation	Mobile Allocation 10.5.2.21	M	LV	1-5
7C	Starting Time	Starting Time 10.5.2.38	O	TV	3
	IAX Rest Octets	IAX Rest Octets 10.5.2.18	M	V	0-4

**Table 9.19/GSM 04.08:  
IMMEDIATE ASSIGNMENT EXTENDED message content**

NOTE: Index 1 refers to the first mobile station, index 2 refers to the second mobile station.



#### **9.1.19.1 Unnecessary IEs**

A mobile station which reacts on the request reference 1 shall consider all information elements as unnecessary IEs except for *Requests Reference 1, Channel Description 1, Timing advance 1, Starting Time* and if *Channel Description 1* IE indicates frequency hopping mobile allocation.

A mobile station which reacts on the request reference 2 shall consider all information elements as unnecessary IE except *Requests Reference 2, Channel Description 2, Timing advance 2, Starting Time* and if *channel description 2* IE indicates frequency hopping mobile allocation.

A mobile station in idle mode shall consider all information elements as unnecessary IEs except for the *Page Mode* IE.

#### **9.1.19.2 Mobile Allocation**

If both channel description IE do not indicate frequency hopping, the length indicator shall be set to zero.

#### **9.1.19.3 Starting Time**

This information element appears if a frequency change is in progress. If included the starting time is common to the two referenced mobile stations.

#### **9.1.19.4 Maximum message length**

As the maximum length of the resulting layer 3 data cannot exceed 22 octets, it is not possible to use this message type if the total length of the value part of the *Mobile Allocation* plus, optionally, the length of the *Starting Time* IE exceeds 5 octets. In this case it is necessary to use the IMMEDIATE ASSIGNMENT message.

#### **9.1.19.5 IAX Rest Octets**

The sum of the length of this IE and the L2 Pseudo Length of the message equals 22.

**9.1.20 Immediate assignment reject**

This message is sent on the CCCH by the network to up to four mobile stations to indicate that no channel is available for assignment (see table 9.20/GSM 04.08). This message has L2 pseudo length 19.

Message type: IMMEDIATE ASSIGNMENT REJECT

Significance:dual

Direction: network to mobile station

IEI	Information element	Type / Reference	Presence	Format	length
	L2 Pseudo Length	L2 Pseudo Length 10.5.2.19	M	V	1
	RR management Protocol Discriminator	Protocol Discriminator 10.2	M	V	1/2
	Skip Indicator	Skip Indicator 10.3.1	M	V	1/2
	Immediate Assignment Reject Message Type	Message Type 10.4	M	V	1
	Page Mode	Page Mode 10.5.2.26	M	V	1/2
	Spare Half Octet	Spare Half Octet 10.5.1.8	M	V	1/2
	Request Reference 1	Request Reference 10.5.2.30	M	V	3
	Wait Indication 1	Wait Indication 10.5.2.43	M	V	1
	Request Reference 2	Request Reference 10.5.2.30	M	V	3
	Wait Indication 2	Wait Indication 10.5.2.43	M	V	1
	Request Reference 3	Request Reference 10.5.2.30	M	V	3
	Wait Indication 3	Wait Indication 10.5.2.43	M	V	1

**Table 9.20/GSM 04.08:  
IMMEDIATE ASSIGNMENT REJECT message content**

	Request Reference 4	Request Reference 10.5.2.30	M	V	3
	Wait Indication 4	Wait Indication 10.5.2.43	M	V	1
	IAR Rest Octets	IAR Rest Octets 10.5.2.17	M	V	3

**Table 9.20/GSM 04.08 (continued):  
 IMMEDIATE ASSIGNMENT REJECT message content**

NOTE: Index 1 refers to the first mobile station, index 2 refers to the second mobile station and so on.

**9.1.20.1 Use of the indexes**

A request reference information element and the following wait indication information element refer to the same mobile station. So it is possible to reject up to four channel requests with this message.

**9.1.20.2 Filling of the message**

If necessary the request reference information element and the wait indication information element should be duplicated to fill the message.

**9.1.21 Measurement report**

This message is sent on the SACCH by the mobile station to the network to report measurement results about the dedicated channel and about neighbour cells (see table 9.21/GSM 04.08).

Message type: MEASUREMENT REPORT

Significance:dual

Direction: mobile station to network

<b>IEI</b>	<b>Information element</b>	<b>Type / Reference</b>	<b>Presence</b>	<b>Format</b>	<b>length</b>
	RR management Protocol Discriminator	Protocol Discriminator 10.2	M	V	1/2
	Skip Indicator	Skip Indicator 10.3.1	M	V	1/2
	Measurement Report Message Type	Message Type 10.4	M	V	1
	Measurement Results	Measurement Results 10.5.2.20	M	V	16

**Table 9.21/GSM 04.08:  
MEASUREMENT REPORT message content**

**9.1.22      Paging request type 1**

This message is sent on the CCCH by the network to up to two mobile stations to trigger channel access by these. The mobile stations are identified by their TMSI or IMSI (see table 9.22/GSM 04.08).

The L2 pseudo length of this message is the sum of lengths of all information elements present in the message except the *P1 Rest Octets* and *L2 Pseudo Length* information elements.

Message type:    PAGING REQUEST TYPE 1

Significance:dual

Direction:    network to mobile station

IEI	Information element	Type / Reference	Presence	Format	length
	L2 Pseudo Length	L2 Pseudo Length 10.5.2.19	M	V	1
	RR management Protocol Discriminator	Protocol Discriminator 10.2	M	V	1/2
	Skip Indicator	Skip Indicator 10.3.1	M	V	1/2
	Paging Request Type 1 Message Type	Message Type 10.4	M	V	1
	Page Mode	Page Mode 10.5.2.26	M	V	1/2
	Channels Needed for Mobiles 1 and 2	Channel Needed 10.5.2.8	M	V	1/2
	Mobile Identity 1	Mobile Identity 10.5.1.4	M	LV	2-9
17	Mobile Identity 2	Mobile Identity 10.5.1.4	O	TLV	3-10
	P1 Rest Octets	P1 Rest Octets 10.5.2.23	M	V	0-17

**Table 9.22/GSM 04.08:  
 PAGING REQUEST TYPE 1 message content**

**9.1.22.1 Unnecessary IE**

A mobile station in idle mode shall consider all information elements as unnecessary IEs except for the *Page Mode* IE.

**9.1.22.2 Channels needed for Mobiles 1 and 2**

The first CHANNEL field of *Channel Needed* IE is associated with *Mobile Identity 1*. The second CHANNEL field of *Channel Needed* IE is associated with *Mobile Identity 2*.

**9.1.22.3 Mobile Identities**

The *Mobile Identity 1 and 2* IEs shall not refer to IMEI.

**9.1.22.4 P1 Rest Octets**

The sum of the length of this IE and the L2 Pseudo Length of the message equals 22.

**9.1.23      Paging request type 2**

This message is sent on the CCCH by the network to two or three mobile stations to trigger channel access by these. Two of the mobile stations are identified by their TMSI while the third is identified by its TMSI or IMSI (see table 9.23/GSM 04.08).

The L2 pseudo length of this message is the sum of lengths of all information elements present in the message except the *P2 Rest Octets* and *L2 Pseudo Length* information elements.

Message type:    PAGING REQUEST TYPE 2  
 Significance: dual  
 Direction:    network to mobile station

IEI	Information element	Type / Reference	Presence	Format	length
	L2 Pseudo Length	L2 Pseudo Length 10.5.2.19	M	V	1
	RR management Protocol Discriminator	Protocol Discriminator 10.2	M	V	1/2
	Skip Indicator	Skip Indicator 10.3.1	M	V	1/2
	Paging Request Type 2 Message Type	Message Type 10.4	M	V	1
	Page Mode	Page Mode 10.5.2.26	M	V	1/2
	Channels Needed for Mobiles 1 and 2	Channel Needed 10.5.2.8	M	V	1/2
	Mobile Identity 1	TMSI 10.5.2.42	M	V	4
	Mobile Identity 2	TMSI 10.5.2.42	M	V	4
17	Mobile Identity 3	Mobile Identity 10.5.1.4	O	TLV	3-10
	P2 Rest Octets	P2 Rest Octets 10.5.2.24	M	V	1-11

**Table 9.23/GSM 04.08:  
 PAGING REQUEST TYPE 2 message content**

**9.1.23.1 Channels needed for Mobiles 1 and 2**

The first CHANNEL field of Channel Needed IE is associated with Mobile Identity 1. The second CHANNEL field of *Channel Needed* IE is associated with *Mobile Identity 2*.

**9.1.23.2 Mobile Identity 3**

The *Mobile Identity 3* information element shall not refer to IMEI.

**9.1.23.3 P2 Rest Octets**

The sum of the length of this IE and the L2 Pseudo Length of the message equals 22.

This IE contains the channel needed indication related to the paging of *Mobile Identity 3*.



### 9.1.24 Paging request type 3

This message is sent on the CCCH by the network to four mobile stations to trigger channel access by these. The mobile stations are identified by their TMSIs (see table 9.24/GSM 04.08). This message has a L2 Pseudo Length of 19.

Message type: PAGING REQUEST TYPE 3

Significance:dual

Direction: network to mobile station

IEI	Information element	Type / Reference	Presence	Format	length
	L2 Pseudo Length	L2 Pseudo Length 10.5.2.19	M	V	1
	RR management Protocol Discriminator	Protocol Discriminator 10.2	M	V	1/2
	Skip Indicator	Skip Indicator 10.3.1	M	V	1/2
	Paging Request Type 3 Message Type	Message Type 10.4	M	V	1
	Page Mode	Page Mode 10.5.2.26	M	V	1/2
	Channels Needed for Mobiles 1 and 2	Channel Needed 10.5.2.8	M	V	1/2
	Mobile Identity 1	TMSI 10.5.2.42	M	V	4
	Mobile Identity 2	TMSI 10.5.2.42	M	V	4
	Mobile Identity 3	TMSI 10.5.2.42	M	V	4
	Mobile Identity 4	TMSI 10.5.2.42	M	V	4
	P3 Rest Octets	P3 Rest Octets 10.5.2.25	M	V	3

**Table 9.24/GSM 04.08:  
PAGING REQUEST TYPE 3 message content**

### 9.1.24.1 Channels needed for Mobiles 1 and 2

The first CHANNEL field of *Channel Needed* IE is associated with *Mobile Identity 1*. The second CHANNEL field of *Channel Needed* IE is associated with *Mobile Identity 2*.

### 9.1.24.2 P3 Rest Octets

This IE contains the channel needed indication related to the paging of *Mobile Identity 3 and 4*.

### 9.1.25 Paging response

This message is sent on the main DCCH by the mobile station to the network in connection with establishment of the main signalling link as a response to the paging request message (see table 9.25/GSM 04.08).

Message type: PAGING RESPONSE

Significance:dual

Direction: mobile station to network

IEI	Information element	Type / Reference	Presence	Format	length
	RR management Protocol Discriminator	Protocol Discriminator 10.2	M	V	1/2
	Skip Indicator	Skip Indicator 10.3.1	M	V	1/2
	Paging Response Message Type	Message Type 10.4	M	V	1
	Ciphering Key Sequence Number	Ciphering Key Sequence Number 10.5.1.2	M	V	1/2
	Spare Half Octet	Spare Half Octet 10.5.1.8	M	V	1/2
	Mobile Station Classmark	Mobile Station Classmark 2 10.5.1.6	M	LV	4
	Mobile Identity	Mobile Identity 10.5.1.4	M	LV	2-9

**Table 9.25/GSM 04.08:  
PAGING RESPONSE message content**

**9.1.25.1 Mobile Station Classmark**

This IE shall include for multiband mobile station the Classmark 2 corresponding to the frequency band in use.

**9.1.26 Partial release**

This message is sent on the main DCCH by the network to the mobile station to deactivate part of the dedicated channels in use (see table 9.26/GSM 04.08).

Message type: PARTIAL RELEASE  
Significance:dual  
Direction: network to mobile station

IEI	Information element	Type / Reference	Presence	Format	length
	RR management Protocol Discriminator	Protocol Discriminator 10.2	M	V	1/2
	Skip Indicator	Skip Indicator 10.3.1	M	V	1/2
	Partial Release Message Type	Message Type 10.4	M	V	1
	Channel Description	Channel Description 10.5.2.5	M	V	3

**Table 9.26/GSM 04.08:  
PARTIAL RELEASE message content**

**9.1.26.1 Channel Description**

This information element describes the channel to be released.

**9.1.27 Partial release complete**

This message is sent on the main DCCH by the mobile station to the network to indicate that a part of the dedicated channels has been deactivated (see table 9.27/GSM 04.08).

Message type: PARTIAL RELEASE COMPLETE  
Significance:dual  
Direction: mobile station to network

IEI	Information element	Type / Reference	Presence	Format	length
	RR management Protocol Discriminator	Protocol Discriminator 10.2	M	V	1/2
	Skip Indicator	Skip Indicator 10.3.1	M	V	1/2
	Partial release Complete Message Type	Message Type 10.4	M	V	1

**Table 9.27/GSM 04.08:  
PARTIAL RELEASE COMPLETE message content**

**9.1.28 Physical information**

This message is sent on the main DCCH by the network to the mobile station to stop the sending of access bursts from the mobile station (see table 9.28/GSM 04.08).

Message type: PHYSICAL INFORMATION  
 Significance:dual  
 Direction: network to mobile station

IEI	Information element	Type / Reference	Presence	Format	length
	RR management Protocol Discriminator	Protocol Discriminator 10.2	M	V	1/2
	Skip Indicator	Skip Indicator 10.3.1	M	V	1/2
	Physical Information Message Type	Message Type 10.4	M	V	1
	Timing Advance	Timing Advance 10.5.2.40	M	V	1

**Table 9.28/GSM 04.08:  
 PHYSICAL INFORMATION message content**

**9.1.29 RR Status**

This message is sent by the mobile station or the network at any time to report certain error conditions as described in section 8 (see table 9.28a/GSM 04.08).

Message type: RR STATUS  
 Significance:local  
 Direction: both

IEI	Information element	Type / Reference	Presence	Format	length
	RR management Protocol Discriminator	Protocol Discriminator 10.2	M	V	1/2
	Skip Indicator	Skip Indicator 10.3.1	M	V	1/2
	RR Status Message Type	Message Type 10.4	M	V	1
	RR Cause	RR Cause 10.5.2.31	M	V	1

**Table 9.28a/GSM 04.08:  
 RR STATUS message content**

**9.1.30 Synchronization channel information**

This message is sent on the SCH, which is one of the broadcast channels (ref. GSM 05.02 section 3.3.2). Its purpose is to support the synchronization of a mobile station to a BSS. It does not follow the basic format. Its length is 25 bits. The order of bit transmission is defined in GSM 04.04 (see figure 9.3/GSM 04.08 and table 9.29/GSM 04.08).

Message type: SYNCHRONIZATION CHANNEL INFORMATION  
 Significance: dual  
 Direction: network to mobile station

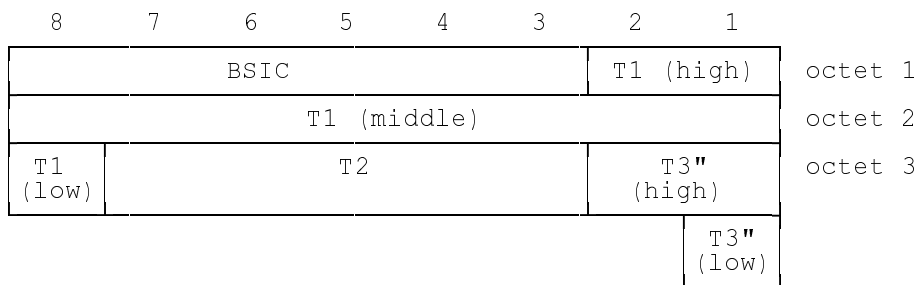

**Figure 9.3/GSM 04.08:  
 Frame synchronization information element**

BSIC, the base station identity code of the base station  T1, T2 and T3", the 3 parts of the reduced TDMA frame number (RFN) as specified in . GSM 05.02 section 3.3.2.
---

**Table 9.29/GSM 04.08:  
 Synchronization channel information message contents**

**9.1.31 System information Type 1**

This message is sent on the BCCH by the network to all mobile stations within the cell giving information of control of the RACH and of the cell allocation (see table 9.30/GSM 04.08). Special requirements for the transmission of this message apply (see GSM 05.02). This message has a L2 Pseudo Length of 21.

Message type: SYSTEM INFORMATION TYPE 1  
Significance:dual  
Direction: network to mobile station

IEI	Information element	Type / Reference	Presence	Format	length
	L2 pseudo length	L2 pseudo length 10.5.2.19	M	V	1
	RR management Protocol Discriminator	Protocol Discriminator 10.2	M	V	1/2
	Skip Indicator	Skip Indicator 10.3.1	M	V	1/2
	System Information Type 1 Message Type	Message Type 10.4	M	V	1
	Cell Channel Description	Cell Channel Description 10.5.2.1b	M	V	16
	RACH Control Parameter	RACH Control Parameters 10.5.2.29	M	V	3
	SI 1 Rest Octets	SI 1 Rest Octets 10.5.2.32	M	V	1

**Table 9.30/GSM 04.08:  
SYSTEM INFORMATION TYPE 1 message content**

**9.1.32 System information type 2**

This message is sent on the BCCH by the network to all mobile stations within the cell giving information of control of the RACH and of the BCCH allocation in the neighbour cells (see table 9.31/GSM 04.08). Special requirements for the transmission of this message apply (see GSM 05.02). This message has a L2 Pseudo Length of 22.

Message type: SYSTEM INFORMATION TYPE 2  
Significance:dual  
Direction: network to mobile station

IEI	Information element	Type / Reference	Presence	Format	length
	L2 Pseudo Length	L2 Pseudo Length 10.5.2.19	M	V	1
	RR management Protocol Discriminator	Protocol Discriminator 10.2	M	V	1/2
	Skip Indicator	Skip Indicator 10.3.1	M	V	1/2
	System Information Type 2 Message Type	Message Type 10.4	M	V	1
	BCCH Frequency List	Neighbour Cell Description 10.5.2.22	M	V	16
	NCC Permitted	NCC permitted 10.5.2.27	M	V	1
	RACH Control Parameter	RACH Control Parameters 10.5.2.29	M	V	3

**Table 9.31/GSM 04.08:  
SYSTEM INFORMATION TYPE 2 message content**

**9.1.33 System information type 2bis**

This message is sent optionally on the BCCH by the network to all mobile stations within the cell giving information on control of the RACH and of the extension of the BCCH allocation in the neighbour cells (see table 9.31a/GSM 04.08). Special requirements for the transmission of this message apply (see GSM 05.02).

A GSM 900 mobile station which only supports the primary GSM band P-GSM 900 (cf. GSM 05.05) may ignore this message (see section 3.2.2.1).

This message has a L2 pseudo length of 21.

Message type: SYSTEM INFORMATION TYPE 2bis

Significance:dual

Direction: network to mobile station

IEI	Information element	Type / Reference	Presence	Format	length
	L2 Pseudo Length	L2 Pseudo Length 10.5.2.19	M	V	1
	RR management Protocol Discriminator	Protocol Discriminator 10.2	M	V	1/2
	Skip Indicator	Skip Indicator 10.3.1	M	V	1/2
	System Information Type 2bis Message Type	Message Type 10.4	M	V	1
	Extended BCCH Frequency List	Neighbour Cell Description 10.5.2.22	M	V	16
	RACH Control Parameters	RACH Control Parameters 10.5.2.29	M	V	3
	SI 2bis Rest Octets	SI 2bis Rest Octets 10.5.2.33	M	V	1

**Table 9.31a/GSM 04.08:  
SYSTEM INFORMATION TYPE 2bis message content**

### 9.1.34 System information type 2ter

This message is sent optionally on the BCCH by the network to all mobile stations within the cell giving information on the extension of the BCCH allocation in the neighbour cells (see table 9.31b/GSM 04.08). Special requirements for the transmission of this message apply (see GSM 05.02).

A mobile station that only supports one band (cf. GSM 05.05) may ignore this message (see section 3.2.2.1).

This message has a L2 pseudo length of 18.

Message type: SYSTEM INFORMATION TYPE 2ter

Significance:dual

Direction: network to mobile station

IEI	Information element	Type / Reference	Presence	Format	length
	L2 Pseudo Length	L2 Pseudo Length 10.5.2.19	M	V	1
	RR management Protocol Discriminator	Protocol Discriminator 10.2	M	V	1/2
	Additional Multiband information	Additional Multiband information 10.5.2.44	M	V	1/2
	System Information Type 2ter Message Type	Message Type 10.4	M	V	1
	Extended BCCH Frequency List	Neighbour Cell Description 10.5.2.22	M	V	16
	SI 2ter Rest Octets	SI 2ter Rest Octets 10.5.2.33a	M	V	4

**Table 9.31b/GSM 04.08:  
SYSTEM INFORMATION TYPE 2ter message content**



**9.1.35 System information type 3**

This message is sent on the BCCH by the network giving information of control on the RACH, the location area identification, the cell identity and various other information about the cell (see table 9.32/ GSM 04.08). Special requirements for the transmission of this message apply (see GSM 05.02). This message has a L2 Pseudo Length of 18.

Message type: SYSTEM INFORMATION TYPE 3

Significance: dual

Direction: network to mobile station

IEI	Information element	Type / Reference	Presence	Format	length
	L2 Pseudo Length	L2 Pseudo Length 10.5.2.19	M	V	1
	RR management Protocol Discriminator	Protocol Discriminator 10.2	M	V	1/2
	Skip Indicator	Skip Indicator 10.3.1	M	V	1/2
	System Information Type 3 Message Type	Message Type 10.4	M	V	1
	Cell Identity	Cell Identity 10.5.1.1	M	V	2
	Location Area Identification	Location Area Identification 10.5.1.3	M	V	5
	Control Channel Description	Control Channel description 10.5.2.11	M	V	3
	Cell Options	Cell Options (BCCH) 10.5.2.3	M	V	1
	Cell Selection Parameters	Cell Selection Parameters 10.5.2.4	M	V	2
	RACH Control Parameters	RACH Control Parameters 10.5.2.29	M	V	3
	SI 3 Rest Octets	SI 3 Rest Octets 10.5.2.34	M	V	4

**Table 9.32/GSM 04.08:  
SYSTEM INFORMATION TYPE 3 message content**

**9.1.36 System information type 4**

This message is sent on the BCCH by the network giving information on control of the RACH, the location area identification, the cell identity and various other information about the cell (see table 9.33/ GSM 04.08). Special requirements for the transmission of this message apply (see GSM 05.02). The L2 pseudo length of this message is the sum of lengths of all information elements present in the message except the *SI 4 Rest Octets* and *L2 Pseudo Length* information elements.

Message type: SYSTEM INFORMATION TYPE 4

Significance:dual

Direction: network to mobile station

IEI	Information element	Type / Reference	Presence	Format	length
	L2 Pseudo Length	L2 Pseudo Length 10.5.2.19	M	V	1
	RR management Protocol Discriminator	Protocol Discriminator 10.2	M	V	1/2
	Skip Indicator	Skip Indicator 10.3.1	M	V	1/2
	System Information Type 4 Message Type	Message Type 10.4	M	V	1
	Location Area Identification	Location Area Identification 10.5.1.3	M	V	5
	Cell Selection Parameters	Cell Selection Parameters 10.5.2.4	M	V	2
	RACH Control Parameters	RACH Control Parameters 10.5.2.29	M	V	3
64	CBCH Channel Description	Channel description 10.5.2.5	O	TV	4
72	CBCH Mobile Allocation	Mobile Allocation 10.5.2.21	C	TLV	3-6
	SI 4 Rest Octets	SI 4 Rest Octets 10.5.2.35	M	V	0-10

**Table 9.33/GSM 04.08:  
SYSTEM INFORMATION TYPE 4 message content**

**9.1.36.1      CBCH Channel description**

This information element is present if SMSCB is active in the cell and indicates (together with the *CBCH Mobile Allocation IE*) where to find the CBCH.

**9.1.36.2      CBCH Mobile Allocation**

If the *CBCH Channel Description* Information Element indicates frequency hopping, the *CBCH Mobile Allocation IE* shall be present. If the *CBCH Channel Description* does not indicate frequency hopping, the *CBCH Mobile Allocation IE* shall be considered as an unnecessary IE in the message.

**9.1.36.3      SI 4 Rest Octets**

The sum of the length of this IE and the L2 pseudo length of the message equals 22.

**9.1.37      System information type 5**

This message is sent on the SACCH by the network to mobile stations within the cell giving information on the BCCH allocation in the neighbour cells (see table 9.34/GSM 04.08).

When received this information shall be used as the list of BCCH frequencies of the neighbouring cells to be reported on. Any change in the neighbour cells description must overwrite any old data held by the mobile station. The mobile station must analyse all correctly received system information type 5 messages.

Message type:    SYSTEM INFORMATION TYPE 5  
Significance:dual  
Direction:    network to mobile station

IEI	Information element	Type / Reference	Presence	Format	length
	RR management Protocol Discriminator	Protocol Discriminator 10.2	M	V	1/2
	Skip Indicator	Skip Indicator 10.3.1	M	V	1/2
	System Information Type 5 Message Type	Message Type 10.4	M	V	1
	BCCH Frequency List	Neighbour Cell Description 10.5.2.22	M	V	16

**Table 9.34/GSM 04.08:  
SYSTEM INFORMATION TYPE 5 message content**

### 9.1.38 System information type 5bis

This message is sent optionally on the SACCH by the network to mobile stations within the cell giving information on the extension of the BCCH allocation in the neighbour cells (see table 9.34a/GSM 04.08).

A GSM 900 mobile station which only supports the primary GSM band P-GSM 900 (cf. GSM 05.05) may ignore this message (see section 3.2.2.1).

When received (and not ignored) this information must be used as the list of neighbouring cells to be reported on. Any change in the neighbour cells description must overwrite any old data held by the mobile station. The mobile station must, with the exception stated above, analyse all correctly received system information type 5 messages.

Message type: SYSTEM INFORMATION TYPE 5bis

Significance:dual

Direction: network to mobile station

IEI	Information element	Type / Reference	Presence	Format	length
	RR management Protocol Discriminator	Protocol Discriminator 10.2	M	V	1/2
	Skip Indicator	Skip Indicator 10.3.1	M	V	1/2
	System Information Type 5 bis Message Type	Message Type 10.4	M	V	1
	Extension of the BCCH Frequency List Description	Neighbour Cell Description 10.5.2.22	M	V	16

**Table 9.34a/GSM 04.08:**  
**SYSTEM INFORMATION TYPE 5bis message content**

**9.1.39 System information type 5ter**

This message is sent optionally on the SACCH by the network to mobile stations within the cell giving information on the extension of the BCCH allocation in the neighbour cells (see table 9.34b/GSM 04.08).

A mobile station that only supports one band (cf. GSM 05.05) may ignore this message (see section 3.2.2.1).

When received (and not ignored) this information must be used as part of the list of neighbouring cells to be reported on. Any change in the neighbour cells description must overwrite this part of any old data held by the mobile station. The mobile station shall, with the exception stated above, analyse all correctly received system information type 5ter messages.

Message type: SYSTEM INFORMATION TYPE 5ter

Significance:dual

Direction: network to mobile station

IEI	Information element	Type / Reference	Presence	Format	length
	RR management Protocol Discriminator	Protocol Discriminator 10.2	M	V	1/2
	Additional Multiband information	Additional Multiband information 10.5.2.44	M	V	1/2
	System Information Type 5ter Message Type	Message Type 10.4	M	V	1
	Extended BCCH Frequency List	Neighbour Cell Description 10.5.2.22	M	V	16

**Table 9.34b/GSM 04.08:  
SYSTEM INFORMATION TYPE 5ter message content**

**9.1.40 System information type 6**

This message is sent on the SACCH by the network to mobile stations within the cell giving information of location area identification, of cell identity and various other information (see table 9.35/GSM 04.08). If received correctly by the mobile station this message is treated as in sections 9.1.40.1 to 9.1.40.4.

Message type: SYSTEM INFORMATION TYPE 6

Significance:dual

Direction: network to mobile station

IEI	Information element	Type / Reference	Presence	Format	length
	RR management Protocol Discriminator	Protocol Discriminator 10.2	M	V	1/2
	Skip Indicator	Skip Indicator 10.3.1	M	V	1/2
	System Information Type 6 Message Type	Message Type 10.4	M	V	1
	Cell Identity	Cell Identity 10.5.1.1	M	V	2
	Location Area Identification	Location Area Identification 10.5.1.3	M	V	5
	Cell Options	Cell Options (SACCH) 10.5.2.3	M	V	1
	NCC Permitted	NCC Permitted 10.5.2.27	M	V	1

**Table 9.35/GSM 04.08:  
SYSTEM INFORMATION TYPE 6 message content**

#### 9.1.40.1 Cell Identity

Not used by mobile station.

#### 9.1.40.2 Location Area Identification

Not used by mobile station.

#### 9.1.40.3 Cell Options

When correctly received, this information shall be used as the current Cell Options information. Any change in the Cell Options shall overwrite any old Cell Options data held by the mobile station.

#### 9.1.40.4 NCC permitted

As for BCCH Frequency List in SYSTEM INFORMATION TYPE 5.

#### 9.1.41 System information type 7

This message is sent on the BCCH by the network giving information about cell reselection parameters to be used in that cell (see table 9.36/GSM 04.08). Special requirements for the transmission of this message apply (see GSM 05.02). The L2 pseudo length of this message has the value 1.

Message type: SYSTEM INFORMATION TYPE 7

Significance:dual

Direction: network to mobile station

IEI	Information element	Type / Reference	Presence	Format	length
	L2 pseudo length	L2 pseudo length 10.5.2.19	M	V	1
	RR management Protocol Discriminator	Protocol Discriminator 10.2	M	V	1/2
	Skip Indicator	Skip Indicator 10.3.1	M	V	1/2
	System Information Type 7 Message Type	Message Type 10.4	M	V	1
	SI 7 Rest Octets	SI 7 Rest Octets 10.5.2.36	M	V	20

**Table 9.36/GSM 04.08:**  
**SYSTEM INFORMATION TYPE 7 message content**

**9.1.42 System information type 8**

This message is sent on the BCCH by the network giving information about cell reselection parameters to be used in that cell (see table 9.37/GSM 04.08). Special requirements for the transmission of this message apply (see GSM 05.02). The L2 Pseudo Length of this message has the value 1.

Message type: SYSTEM INFORMATION TYPE 8  
 Significance:dual  
 Direction: network to mobile station

IEI	Information element	Type / Reference	Presence	Format	length
	L2 Pseudo Length	L2 Pseudo Length 10.5.2.19	M	V	1
	RR management Protocol Discriminator	Protocol Discriminator 10.2	M	V	1/2
	Skip Indicator	Skip Indicator 10.3.1	M	V	1/2
	System Information Type 8 Message Type	Message Type 10.4	M	V	1
	SI 8 Rest Octets	SI 8 Rest Octets 10.5.2.37	M	V	20

**Table 9.37/GSM 04.08:  
 SYSTEM INFORMATION TYPE 8 message content**

## 9.2 Messages for mobility management

Table 9.38/GSM 04.08 summarizes the messages for mobility management.

Registration messages:	Reference
IMSI DETACH INDICATION	9.2.12
LOCATION UPDATING ACCEPT	9.2.13
LOCATION UPDATING REJECT	9.2.14
LOCATION UPDATING REQUEST	9.2.15
Security messages:	Reference
AUTHENTICATION REJECT	9.2.1
AUTHENTICATION REQUEST	9.2.2
AUTHENTICATION RESPONSE	9.2.3
IDENTITY REQUEST	9.2.10
IDENTITY RESPONSE	9.2.11
TMSI REALLOCATION COMMAND	9.2.17
TMSI REALLOCATION COMPLETE	9.2.18
Connection management messages:	Reference
CM SERVICE ACCEPT	9.2.5
CM SERVICE REJECT	9.2.6
CM SERVICE ABORT	9.2.7
CM SERVICE REQUEST	9.2.9
CM REESTABLISHMENT REQUEST	9.2.4
ABORT	9.2.8
Miscellaneous message:	Reference
MM STATUS	9.2.16

**Table 9.38/GSM 04.08:  
Messages for mobility management**



### 9.2.1 Authentication reject

This message is sent by the network to the mobile station to indicate that authentication has failed (and that the receiving mobile station shall abort all activities) (see table 9.39/GSM 04.08).

Message type: AUTHENTICATION REJECT

Significance:dual

Direction: network to mobile station

IEI	Information element	Type / Reference	Presence	Format	Length
	Mobility management protocol discriminator	Protocol discriminator 10.2	M	V	1/2
	Skip Indicator	Skip Indicator 10.3.1	M	V	1/2
	Authentication Reject message type	Message type 10.4	M	V	1

**Table 9.39/GSM 04.08:  
AUTHENTICATION REJECT message content**

### 9.2.2 Authentication request

This message is sent by the network to the mobile station to initiate authentication of the mobile station identity (see table 9.40/GSM 04.08).

Message type: AUTHENTICATION REQUEST

Significance:dual

Direction: network to mobile station

IEI	Information element	Type / Reference	Presence	Format	Length
	Mobility management protocol discriminator	Protocol discriminator 10.2	M	V	1/2
	Skip Indicator	Skip Indicator 10.3.1	M	V	1/2
	Authentication Request message type	Message type 10.4	M	V	1
	Ciphering key sequence number	Ciphering key sequence number 10.5.1.2	M	V	1/2
	Spare half octet	Spare half octet 10.5.1.8	M	V	1/2
	Authentication parameter RAND	Auth. parameter RAND 10.5.3.1	M	V	16

**Table 9.40/GSM 04.08:  
AUTHENTICATION REQUEST message content**

### 9.2.3 Authentication response

This message is sent by the mobile station to the network to deliver a calculated response to the network (see table 9.41/GSM 04.08).

Message type: AUTHENTICATION RESPONSE  
Significance:dual  
Direction: mobile station to network

IEI	Information element	Type / Reference	Presence	Format	Length
	Mobility management protocol discriminator	Protocol discriminator 10.2	M	V	1/2
	Skip Indicator	Skip Indicator 10.3.1	M	V	1/2
	Authentication Response message type	Message type 10.4	M	V	1
	Authentication parameter SRES	Auth. parameter SRES 10.5.3.2	M	V	4

**Table 9.41/GSM 04.08:**  
**AUTHENTICATION RESPONSE message content**

### 9.2.4 CM Re-establishment request

This message is sent by the mobile station to the network to request re-establishment of a connection if the previous one has failed (see table 9.42/GSM 04.08).

Message type: CM RE-ESTABLISHMENT REQUEST  
Significance:dual  
Direction: mobile station to network

IEI	Information element	Type / Reference	Presence	Format	Length
	Mobility management protocol discriminator	Protocol discriminator 10.2	M	V	1/2
	Skip Indicator	Skip Indicator 10.3.1	M	V	1/2
	CM Re-Establishment Request message type	Message type 10.4	M	V	1
	Ciphering key sequence number	Ciphering key sequence number 10.5.1.2	M	V	1/2
	Spare half octet	Spare half octet 10.5.1.8	M	V	1/2
	Mobile station classmark	Mobile station classmark 2 10.5.1.6	M	LV	4
	Mobile identity	Mobile identity 10.5.1.4	M	LV	2-9
13	Location area identification	Location area identification 10.5.1.3	C	TV	6

**Table 9.42/GSM 04.08:**  
**CM RE-ESTABLISHMENT REQUEST message content**

#### 9.2.4.1 Location area identification

The *location area identification* information element shall appear when a TMSI is used as mobile identity, to render that mobile identity non-ambiguous. This is the LAI stored in the SIM.

### 9.2.4.2 Mobile Station Classmark

This IE shall include for multiband mobile station the Classmark 2 corresponding to the frequency band in use.

### 9.2.5 CM service accept

This message is sent by the network to the mobile station to indicate that the requested service has been accepted (see table 9.43/GSM 04.08).

Message type: CM SERVICE ACCEPT  
Significance:dual  
Direction: network to mobile station

IEI	Information element	Type / Reference	Presence	Format	Length
	Mobility management protocol discriminator	Protocol discriminator 10.2	M	V	1/2
	Skip Indicator	Skip Indicator 10.3.1	M	V	1/2
	CM Service Accept message type	Message type 10.4	M	V	1

**Table 9.43/GSM 04.08:  
CM SERVICE ACCEPT message content**

### 9.2.6 CM service reject

This message is sent by the network to the mobile station to indicate that the requested service cannot be provided (see table 9.44/GSM 04.08).

Message type: CM SERVICE REJECT  
Significance:dual  
Direction: network to mobile station

IEI	Information element	Type / Reference	Presence	Format	Length
	Mobility management protocol discriminator	Protocol discriminator 10.2	M	V	1/2
	Skip Indicator	Skip Indicator 10.3.1	M	V	1/2
	CM Service Reject message type	Message type 10.4	M	V	1
	Reject cause	Reject cause 10.5.3.6	M	V	1

**Table 9.44/GSM 04.08:  
CM SERVICE REJECT message content**

**9.2.7 CM service abort**

This message is sent by the mobile station to the network to request the abortion of the first MM connection establishment in progress and the release of the RR connection (see table 9.44a/GSM 04.08).

Message type: CM SERVICE ABORT  
 Significance:dual  
 Direction: mobile station to network

IEI	Information element	Type / Reference	Presence	Format	Length
	Mobility management protocol discriminator	Protocol discriminator 10.2	M	V	1/2
	Skip Indicator	Skip Indicator 10.3.1	M	V	1/2
	CM Service Abort message type	Message type 10.4	M	V	1

**Table 9.44a/GSM 04.08:  
 CM SERVICE ABORT message content**

**9.2.8 Abort**

This message is sent by the network to the mobile station to initiate the abortion of all MM connections and to indicate the reason for the abortion (see table 9.44b/GSM 04.08).

Message type: ABORT  
 Significance:dual  
 Direction: network to mobile station

IEI	Information element	Type / Reference	Presence	Format	Length
	Mobility management protocol discriminator	Protocol discriminator 10.2	M	V	1/2
	Skip Indicator	Skip Indicator 10.3.1	M	V	1/2
	Abort message type	Message type 10.4	M	V	1
	Reject cause	Reject cause 10.5.3.6	M	V	1

**Table 9.44b/GSM 04.08:  
 ABORT message content**

### 9.2.9 CM service request

This message is sent by the mobile station to the network to request a service for the connection management sublayer entities, e.g. circuit switched connection establishment, supplementary services activation, short message transfer (see table 9.45/GSM 04.08).

Message type: CM SERVICE REQUEST  
Significance:dual  
Direction: mobile station to network

IEI	Information element	Type / Reference	Presence	Format	Length
	Mobility management protocol discriminator	Protocol discriminator 10.2	M	V	1/2
	Skip Indicator	Skip Indicator 10.3.1	M	V	1/2
	CM Service Request message type	Message type 10.4	M	V	1
	CM service type	CM service type 10.5.3.3	M	V	1/2
	Ciphering key sequence number	Ciphering key sequence number 10.5.1.2	M	V	1/2
	Mobile station classmark	Mobile station classmark 2 10.5.1.6	M	LV	4
	Mobile identity	Mobile identity 10.5.1.4	M	LV	2-9

**Table 9.45/GSM 04.08:  
CM SERVICE REQUEST message content**

#### 9.2.9.1 Mobile Station Classmark

This IE shall include for multiband mobile station the Classmark 2 corresponding to the frequency band in use.

#### 9.2.10 Identity request

This message is sent by the network to the mobile station to request a mobile station to submit the specified identity to the network (see table 9.46/GSM 04.08).

Message type: IDENTITY REQUEST  
Significance:dual  
Direction: network to mobile station

IEI	Information element	Type / Reference	Presence	Format	Length
	Mobility management protocol discriminator	Protocol discriminator 10.2	M	V	1/2
	Skip Indicator	Skip Indicator 10.3.1	M	V	1/2
	Identity Request message type	Message type 10.4	M	V	1
	Identity type	Identity type 10.5.3.4	M	V	1/2
	Spare half octet	Spare half octet 10.5.1.8	M	V	1/2

**Table 9.46/GSM 04.08:  
IDENTITY REQUEST message content**

### 9.2.11 Identity response

This message is sent by the mobile station to the network in response to an IDENTITY REQUEST message providing the requested identity (see table 9.47/GSM 04.08).

Message type: IDENTITY RESPONSE  
Significance:dual  
Direction: mobile station to network

IEI	Information element	Type / Reference	Presence	Format	Length
	Mobility management protocol discriminator	Protocol discriminator 10.2	M	V	1/2
	Skip Indicator	Skip Indicator 10.3.1	M	V	1/2
	Identity Response message type	Message type 10.4	M	V	1
	Mobile identity	Mobile identity 10.5.1.4	M	LV	2-10

**Table 9.47/GSM 04.08:  
IDENTITY RESPONSE message content**

### 9.2.12 IMSI detach indication

This message is sent by the mobile station to the network to set a deactivation indication in the network (see table 9.48/GSM 04.08).

Message type: IMSI DETACH INDICATION  
Significance:dual  
Direction: mobile station to network

IEI	Information element	Type / Reference	Presence	Format	Length
	Mobility management protocol discriminator	Protocol discriminator 10.2	M	V	1/2
	Skip Indicator	Skip Indicator 10.3.1	M	V	1/2
	IMSI Detach Indication message type	Message type 10.4	M	V	1
	Mobile station classmark	Mobile station classmark 1 10.5.1.5	M	V	1
	Mobile identity	Mobile identity 10.5.1.4	M	LV	2-9

**Table 9.48/GSM 04.08:  
IMSI DETACH INDICATION message content**

#### 9.2.12.1 Mobile Station Classmark

This IE shall include for multiband mobile station the Classmark 1 corresponding to the frequency band in use.

### 9.2.13 Location updating accept

This message is sent by the network to the mobile station to indicate that updating or IMSI attach in the network has been completed (see table 9.49/GSM 04.08).

Message type: LOCATION UPDATING ACCEPT  
Significance:dual  
Direction: network to mobile station

IEI	Information element	Type / Reference	Presence	Format	Length
	Mobility management protocol discriminator	Protocol discriminator 10.2	M	V	1/2
	Skip Indicator	Skip Indicator 10.3.1	M	V	1/2
	Location Updating Accept message type	Message type 10.4	M	V	1
	Location area identification	Location area identification 10.5.1.3	M	V	5
17	Mobile identity	Mobile identity 10.5.1.4	O	TLV	3-10
A1	Follow on proceed	Follow on proceed 10.5.3.7	O	T	1

**Table 9.49/GSM 04.08:**  
**LOCATION UPDATING ACCEPT message content**

#### 9.2.13.1 Follow on proceed

The *follow on proceed* information element appears if the network wishes to indicate that the Mobile Station may attempt an MM connection establishment using the same RR connection.

### 9.2.14 Location updating reject

This message is sent by the network to the mobile station to indicate that updating or IMSI attach has failed (see table 9.50/GSM 04.08).

Message type: LOCATION UPDATING REJECT  
Significance:dual  
Direction: network to mobile station

IEI	Information element	Type / Reference	Presence	Format	Length
	Mobility management protocol discriminator	Protocol discriminator 10.2	M	V	1/2
	Skip Indicator	Skip Indicator 10.3.1	M	V	1/2
	Location Updating Reject message type	Message type 10.4	M	V	1
	Reject cause	Reject cause 10.5.3.6	M	V	1

**Table 9.50/GSM 04.08:**  
**LOCATION UPDATING REJECT message content**

### 9.2.15 Location updating request

This message is sent by the mobile station to the network either to request update of its location file (normal updating or periodic updating) or to request IMSI attach (see table 9.51/GSM 04.08).

Message type: LOCATION UPDATING REQUEST

Significance:dual

Direction: mobile station to network

IEI	Information element	Type / Reference	Presence	Format	Length
	Mobility management protocol discriminator	Protocol discriminator 10.2	M	V	1/2
	Skip Indicator	Skip Indicator 10.3.1	M	V	1/2
	Location Updating Request message type	Message type 10.4	M	V	1
	Location updating type	Location updating type 10.5.3.5	M	V	1/2
	Ciphering key sequence number	Ciphering key sequence number 10.5.1.2	M	V	1/2
	Location area identification	Location area identification 10.5.1.3	M	V	5
	Mobile station classmark	Mobile station classmark 1 10.5.1.5	M	V	1
	Mobile identity	Mobile identity 10.5.1.4	M	LV	2-9

**Table 9.51/GSM 04.08:**  
**LOCATION UPDATING REQUEST message content**

#### 9.2.15.1 Location area identification

The location area identification stored in the SIM is used.

#### 9.2.15.2 Mobile Station Classmark

This IE shall include for multiband mobile station the Classmark 1 corresponding to the frequency band in use.



### 9.2.16 MM Status

This message is sent by the mobile station or the network at any time to report certain error conditions listed in section 8 (see table 9.51a/GSM 04.08).

Message type: MM STATUS  
Significance: local  
Direction: both

IEI	Information element	Type / Reference	Presence	Format	Length
	Mobility management protocol discriminator	Protocol discriminator 10.2	M	V	1/2
	Skip Indicator	Skip Indicator 10.3.1	M	V	1/2
	MM Status message type	Message type 10.4	M	V	1
	Reject cause	Reject cause 10.5.3.6	M	V	1

**Table 9.51a/GSM 04.08:  
MM STATUS message content**

### 9.2.17 TMSI reallocation command

This message is sent by the network to the mobile station to reallocate or delete a TMSI (see table 9.52/GSM 04.08).

Message type: TMSI REALLOCATION COMMAND  
Significance: dual  
Direction: network to mobile station

IEI	Information element	Type / Reference	Presence	Format	Length
	Mobility management protocol discriminator	Protocol discriminator 10.2	M	V	1/2
	Skip Indicator	Skip Indicator 10.3.1	M	V	1/2
	TMSI Reallocation Command message type	Message type 10.4	M	V	1
	Location area identification	Location area identification 10.5.1.3	M	V	5
	Mobile identity	Mobile identity 10.5.1.4	M	LV	2-9

**Table 9.52/GSM 04.08:  
TMSI REALLOCATION COMMAND message content**

**9.2.18 TMSI reallocation complete**

This message is sent by the mobile station to the network to indicate that reallocation or deletion of a TMSI has taken place (see table 9.53/GSM 04.08).

Message type: TMSI REALLOCATION COMPLETE

Significance:dual

Direction: mobile station to network

IEI	Information element	Type / Reference	Presence	Format	Length
	Mobility management protocol discriminator	Protocol discriminator 10.2	M	V	1/2
	Skip Indicator	Skip Indicator 10.3.1	M	V	1/2
	TMSI Reallocation Complete message type	Message type 10.4	M	V	1

**Table 9.53/GSM 04.08:  
TMSI REALLOCATION COMPLETE message content**

### 9.3 Messages for circuit-switched call control

Table 9.54/GSM 04.08 summarizes the messages for circuit-switched call control.

Call establishment messages:	Reference
ALERTING	9.3.1
CALL CONFIRMED 1)	9.3.2
CALL PROCEEDING	9.3.3
CONNECT	9.3.5
CONNECT ACKNOWLEDGE	9.3.6
EMERGENCY SETUP 1)	9.3.8
PROGRESS	9.3.17
SETUP	9.3.23
Call information phase messages:	Reference
MODIFY 1)	9.3.13
MODIFY COMPLETE 1)	9.3.14
MODIFY REJECT 1)	9.3.15
USER INFORMATION	9.3.31
Call clearing messages:	Reference
DISCONNECT	9.3.7
RELEASE	9.3.18
RELEASE COMPLETE	9.3.19
Messages for supplementary service control	Reference
FACILITY	9.3.9
HOLD 1)	9.3.10
HOLD ACKNOWLEDGE 1)	9.3.11
HOLD REJECT 1)	9.3.12
RETRIEVE 1)	9.3.20
RETRIEVE ACKNOWLEDGE 1)	9.3.21
RETRIEVE REJECT 1)	9.3.22
Miscellaneous messages:	Reference
CONGESTION CONTROL	9.3.4
NOTIFY	9.3.16
START DTMF 1)	9.3.24
START DTMF ACKNOWLEDGE 1)	9.3.25
START DTMF REJECT 1)	9.3.26
STATUS	9.3.27
STATUS ENQUIRY	9.3.28
STOP DTMF 1)	9.3.29
STOP DTMF ACKNOWLEDGE 1)	9.3.30

**Table 9.54/GSM 04.08:  
Messages for circuit-mode connections call control**

NOTE: Not supported by Blue Book CCITT Rec. Q.931.

### 9.3.1 Alerting

#### 9.3.1.1 Alerting (network to mobile station direction)

This message is sent by the network to the calling mobile station to indicate that the called user alerting has been initiated.

See table 9.55/GSM 04.08.

Message type: ALERTING  
Significance: global  
Direction: network to mobile station

IEI	Information element	Type / Reference	Presence	Format	Length
	Call control protocol discriminator	Protocol discriminator 10.2	M	V	1/2
	Transaction identifier	Transaction identifier 10.3.2	M	V	1/2
	Alerting message type	Message type 10.4	M	V	1
1C	Facility	Facility 10.5.4.15	O	TLV	2-?
1E	Progress indicator	Progress indicator 10.5.4.21	O	TLV	4
7E	User-user	User-user 10.5.4.25	O	TLV	3-35

**Table 9.55/GSM 04.08:**  
**ALERTING message content (network to mobile station direction)**

##### 9.3.1.1.1 Facility

This information element may be used for functional operation of supplementary services.

##### 9.3.1.1.2 Progress indicator

This information element may be included by the network:

- in order to pass information about the call in progress, e.g., in the event of interworking and/or;
- to make the mobile station attach the user connection for speech.

##### 9.3.1.1.3 User-user

This information element may be included by the network if the called remote user included a *user-user* information element in the ALERTING message.

### 9.3.1.2 Alerting (mobile station to network direction)

This message is sent by the called mobile station to the network, to indicate that the called user alerting has been initiated.

See table 9.55a/GSM 04.08.

Message type: ALERTING  
Significance: global  
Direction: mobile station to network

IEI	Information element	Type / Reference	Presence	Format	Length
	Call control protocol discriminator	Protocol discriminator 10.2	M	V	1/2
	Transaction identifier	Transaction identifier 10.3.2	M	V	1/2
	Alerting message type	Message type 10.4	M	V	1
1C	Facility	Facility 10.5.4.15	O	TLV	2-?
7E	User-user	User-user 10.5.4.25	O	TLV	3-35
7F	SS version	SS version indicator 10.5.4.24	O	TLV	2-3

**Table 9.55a/GSM 04.08:  
ALERTING message content (mobile station to network direction)**

#### 9.3.1.2.1 Facility

This information element may be used for functional operation of supplementary services.

#### 9.3.1.2.2 User-user

This information element may be included when the called mobile station wants to return information to the calling remote user.

#### 9.3.1.2.3 SS version

This information element shall not be included if the *facility* information element is not present in this message.

This information element shall be included or excluded as defined in GSM 04.10. This information element should not be transmitted unless explicitly required by GSM 04.10.

### 9.3.2 Call confirmed

This message is sent by the called mobile station to confirm an incoming call request.

See table 9.56/GSM 04.08.

Message type: CALL CONFIRMED

Significance: local

Direction: mobile station to network

IEI	Information element	Type / Reference	Presence	Format	Length
	Call control protocol discriminator	Protocol discriminator 10.2	M	V	1/2
	Transaction identifier	Transaction identifier 10.3.2	M	V	1/2
	Call confirmed message type	Message type 10.4	M	V	1
D-	Repeat Indicator	Repeat Indicator 10.5.4.22	C	TV	1
04	Bearer capability 1	Bearer capability 10.5.4.5	O	TLV	3-10
04	Bearer capability 2	Bearer capability 10.5.4.5	O	TLV	3-10
08	Cause	Cause 10.5.4.11	O	TLV	4-32
15	CC Capabilities	Call Control Capabilities 10.5.4.5a	O	TLV	3

**Table 9.56/GSM 04.08:  
CALL CONFIRMED message content**

### 9.3.2.1 Repeat indicator

The *repeat indicator* information element shall be included if *bearer capability 1* information element and *bearer capability 2* IE are both included in the message.

### 9.3.2.2 Bearer capability 1 and bearer capability 2

The *bearer capability 1* information element shall be included if and only if at least one of the following three cases holds:

- the mobile station wishes another bearer capability than that given by the *bearer capability 1* information element of the incoming SETUP message;
- the *bearer capability 1* information element is missing or not fully specified in the SETUP message;
- the *bearer capability 1* information element received in the SETUP message is accepted and the "radio channel requirement" of the Mobile Station is other than "full rate support only mobile station".

When the *bearer capability 1* information element is followed by the *bearer capability 2* IE in the SETUP, the above rules apply to both *bearer capability 1* IE and *bearer capability 2* IE. Except those cases identified in GSM 07.01, if either *bearer capability* needs to be included, both shall be included.

Furthermore, both *bearer capability* information elements may be present if the mobile station wishes to reverse the order of occurrence of the *bearer capability* information elements (which is referred to in the *repeat indicator* information element, see section 10.5.4.22) in cases identified in GSM 07.01.

### 9.3.2.3 Cause

This information element is included if the mobile station is compatible but the user is busy.

### 9.3.2.4 CC Capabilities

This information element may be included by the mobile station to indicate its call control capabilities.

### 9.3.3 Call proceeding

This message is sent by the network to the calling mobile station to indicate that the requested call establishment information has been received, and no more call establishment information will be accepted.

See table 9.57/GSM 04.08.

Message type: CALL PROCEEDING

Significance: local

Direction: network to mobile station

IEI	Information element	Type / Reference	Presence	Format	Length
	Call control protocol discriminator	Protocol discriminator 10.2	M	V	1/2
	Transaction identifier	Transaction identifier 10.3.2	M	V	1/2
	Call proceeding message type	Message type 10.4	M	V	1
D-	Repeat Indicator	Repeat Indicator 10.5.4.22	C	TV	1
04	Bearer capability 1	Bearer capability 10.5.4.5	O	TLV	3-10
04	Bearer capability 2	Bearer capability 10.5.4.5	O	TLV	3-10
1C	Facility	Facility 10.5.4.15	O	TLV	2-?
1E	Progress indicator	Progress indicator 10.5.4.21	O	TLV	4

**Table 9.57/GSM 04.08:**  
**CALL PROCEEDING message content**



### 9.3.3.1 Repeat indicator

This information element is included if and only if *bearer capability 1 IE* and *bearer capability 2 IE* are both contained in the message.

### 9.3.3.2 Bearer capability 1 and bearer capability 2

The *bearer capability 1* information element is included if the network has to specify at least one of the negotiable parameters described in GSM 07.01.

When the *bearer capability 1* information element is followed by the *bearer capability 2 IE* in the SETUP, the above rule applies to both *bearer capability 1 IE* and *bearer capability 2 IE*. Except those cases identified in GSM 07.01, if either *bearer capability* needs to be included, both shall be included.

### 9.3.3.3 Facility

This information element may be used for functional operation of supplementary services.

### 9.3.3.4 Progress Indicator

This information element may be included:

- in order to pass information about the call in progress e.g. in the event of interworking and/or;
- to make the MS attach the user connection for speech.

## 9.3.4 Congestion control

This message is sent by the mobile station or the network to indicate the establishment or termination of flow control on the transmission of USER INFORMATION messages.

See table 9.58/GSM 04.08.

Message type: CONGESTION CONTROL

Significance: local (note)

Direction: both

IEI	Information element	Type / Reference	Presence	Format	Length
	Call control protocol discriminator	Protocol discriminator 10.2	M	V	1/2
	Transaction identifier	Transaction identifier 10.3.2	M	V	1/2
	Congestion control message type	Message type 10.4	M	V	1
	Congestion level	Congestion level 10.5.4.12	M	V	1/2
	Spare half octet	Spare half octet 10.5.1.8	M	V	1/2
08	Cause	Cause 10.5.4.11	O	TLV	4-32

**Table 9.58/GSM 04.08:  
CONGESTION CONTROL message content**

NOTE: This message has local significance, but may carry information of global significance.

### 9.3.4.1 Cause

This information element is included if the user to user information has been discarded as a result of the congestion situation.

### 9.3.5 Connect

#### 9.3.5.1 Connect (network to mobile station direction)

This message is sent by the network to the calling mobile station to indicate call acceptance by the called user.

See table 9.59/GSM 04.08.

Message type: CONNECT  
Significance: global  
Direction: network to mobile station

IEI	Information element	Type / Reference	Presence	Format	Length
	Call control protocol discriminator	Protocol discriminator 10.2	M	V	1/2
	Transaction identifier	Transaction identifier 10.3.2	M	V	1/2
	Connect message type	Message type 10.4	M	V	1
1C	Facility	Facility 10.5.4.15	O	TLV	2-?
1E	Progress indicator	Progress indicator 10.5.4.21	O	TLV	4
4C	Connected number	Connected number 10.5.4.13	O	TLV	3-14
4D	Connected subaddress	Connected subaddress 10.5.4.14	O	TLV	2-23
7E	User-user	User-user 10.5.4.25	O	TLV	3-35

**Table 9.59/GSM 04.08:  
CONNECT message content(network to mobile station direction)**

#### 9.3.5.1.1 Facility

This information element may be used for functional operation of supplementary services.

#### 9.3.5.1.2 Progress indicator

This information element may be included by the network:

- in order to pass information about the call in progress e.g. in the event of interworking and/or;
- to make the MS attach the user connection for speech.

#### 9.3.5.1.3 User-user

This information element may be included by the network if the remote user awarded the call included a user- user information element in the CONNECT message.

### 9.3.5.2 Connect (mobile station to network direction)

This message is sent by the called mobile station to the network to indicate call acceptance by the called user.

See table 9.59a/GSM 04.08.

Message type: CONNECT  
Significance: global  
Direction: mobile station to network

IEI	Information element	Type / Reference	Presence	Format	Length
	Call control protocol discriminator	Protocol discriminator 10.2	M	V	1/2
	Transaction identifier	Transaction identifier 10.3.2	M	V	1/2
	Connect message type	Message type 10.4	M	V	1
1C	Facility	Facility 10.5.4.15	O	TLV	2-?
4D	Connected subaddress	Connected subaddress 10.5.4.14	O	TLV	2-23
7E	User-user	User-user 10.5.4.25	O	TLV	3-35
7F	SS version	SS version indicator 10.5.4.24	O	TLV	2-3

**Table 9.59a/GSM 04.08:  
CONNECT message content (mobile station to network direction)**

#### 9.3.5.2.1 Facility

This information element may be used for functional operation of supplementary services.

#### 9.3.5.2.2 User-user

This information element is included when the answering mobile station wants to return user information to the calling remote user.

#### 9.3.5.2.3 SS version

This information element shall not be included if the *facility* information element is not present in this message.

This information element shall be included or excluded as defined in GSM 04.10. This information element should not be transmitted unless explicitly required by GSM 04.10.

### 9.3.6 Connect acknowledge

This message is sent by the network to the called mobile station to indicate that the mobile station has been awarded the call. It shall also be sent by the calling mobile station to the network to acknowledge the offered connection.

See table 9.60/GSM 04.08.

Message type: CONNECT ACKNOWLEDGE  
Significance: local  
Direction: both

IEI	Information element	Type / Reference	Presence	Format	Length
	Call control protocol discriminator	Protocol discriminator 10.2	M	V	1/2
	Transaction identifier	Transaction identifier 10.3.2	M	V	1/2
	Connect acknowledge message type	Message type 10.4	M	V	1

**Table 9.60/GSM 04.08:  
CONNECT ACKNOWLEDGE message content**

### 9.3.7 Disconnect

#### 9.3.7.1 Disconnect (network to mobile station direction)

This message is sent by the network to indicate that the end-to-end connection is cleared.

See table 9.61/GSM 04.08.

Message type: DISCONNECT  
Significance: global  
Direction: network to mobile station

IEI	Information element	Type / Reference	Presence	Format	Length
	Call control protocol discriminator	Protocol discriminator 10.2	M	V	1/2
	Transaction identifier	Transaction identifier 10.3.2	M	V	1/2
	Disconnect message type	Message type 10.4	M	V	1
	Cause	Cause 10.5.4.11	M	LV	3-31
1C	Facility	Facility 10.5.4.15	O	TLV	2-?
1E	Progress indicator	Progress indicator 10.5.4.21	O	TLV	4
7E	User-user	User-user 10.5.4.25	O	TLV	3-35

**Table 9.61/GSM 04.08:  
DISCONNECT message content (network to mobile station direction)**

**9.3.7.1.1 Facility**

This information element may be used for functional operation of supplementary services, such as the user-user service.

**9.3.7.1.2 Progress indicator**

This information element is included by the network to make the MS attach the user connection for speech and react in a specific way during call clearing (see section 5.4.4).

**9.3.7.1.3 User-user**

This information element may be included by the network when the remote user initiates call clearing and included a user-user information element in the DISCONNECT message.

**9.3.7.2 Disconnect (mobile station to network direction)**

This message is sent by the mobile station to request the network to clear an end-to-end connection.

See table 9.61a/GSM 04.08.

Message type: DISCONNECT  
Significance: global  
Direction: mobile station to network

IEI	Information element	Type / Reference	Presence	Format	Length
	Call control protocol discriminator	Protocol discriminator 10.2	M	V	1/2
	Transaction identifier	Transaction identifier 10.3.2	M	V	1/2
	Disconnect message type	Message type 10.4	M	V	1
	Cause	Cause 10.5.4.11	M	LV	3-31
1C	Facility	Facility 10.5.4.15	O	TLV	2-?
7E	User-user	User-user 10.5.4.25	O	TLV	3-35
7F	SS version	SS version indicator 10.5.4.24	O	TLV	2-3

**Table 9.61a/GSM 04.08:  
DISCONNECT message content (mobile station to network direction)**

**9.3.7.2.1 Facility**

This information element may be used for functional operation of supplementary services, such as the user-user service.

**9.3.7.2.2 User-user**

This information element is included when the mobile station initiates call clearing and wants to pass user information to the remote user at call clearing time.

**9.3.7.2.3 SS version**

This information element shall not be included if the *facility* information element is not present in this message.

This information element shall be included or excluded as defined in GSM 04.10. This information element should not be transmitted unless explicitly required by GSM 04.10.

**9.3.8 Emergency setup**

This message is sent from the mobile station to initiate emergency call establishment.

See table 9.62/GSM 04.08.

Message type: EMERGENCY SETUP

Significance: global

Direction: mobile station to network

IEI	Information element	Type / Reference	Presence	Format	Length
	Call control protocol discriminator	Protocol discriminator 10.2	M	V	1/2
	Transaction identifier	Transaction identifier 10.3.2	M	V	1/2
	Emergency setup message type	Message type 10.4	M	V	1
04	Bearer capability	Bearer capability 10.5.4.5	O	TLV	3

**Table 9.62/GSM 04.08:  
 EMERGENCY SETUP message content**

**9.3.8.1 Bearer capability**

If the element is not included, the network shall by default assume speech and select full rate speech. If this information element is included, it shall indicate speech with the appropriate value radio channel requirement field.

### 9.3.9 Facility

#### 9.3.9.1 Facility (network to mobile station direction)

This message is sent by the network to the mobile station to request or acknowledge a supplementary service. The supplementary service to be invoked and its associated parameters are specified in the facility information element.

See table 9.62a/GSM 04.08.

Message type: FACILITY  
Significance: local (note 1)  
Direction: network to mobile station

IEI	Information element	Type / Reference	Presence	Format	Length
	Call control protocol discriminator	Protocol discriminator 10.2	M	V	1/2
	Transaction identifier	Transaction identifier 10.3.2	M	V	1/2
	Facility message type	Message type 10.4	M	V	1
	Facility (note 2)	Facility 10.5.4.15	M	LV	1-?

**Table 9.62a/GSM 04.08:  
FACILITY message content (network to mobile station direction)**

NOTE 1: This message has local significance; however, it may carry information of global significance.

NOTE 2: The *facility* information element has no upper length limit except that given by the maximum number of octets in a L3 message (see GSM 04.06).

### 9.3.9.2 Facility (mobile station to network direction)

This message is sent by the mobile station to the network to request or acknowledge a supplementary service. The supplementary service to be invoked and its associated parameters are specified in the facility information element.

See table 9.62b/GSM 04.08.

Message type: FACILITY  
Significance: local (note 1)  
Direction: mobile station to network

IEI	Information element	Type / Reference	Presence	Format	Length
	Call control protocol discriminator	Protocol discriminator 10.2	M	V	1/2
	Transaction identifier	Transaction identifier 10.3.2	M	V	1/2
	Facility message type	Message type 10.4	M	V	1
	Facility (note 2)	Facility 10.5.4.15	M	LV	1-?
7F	SS version	SS version indicator 10.5.4.24	O	TLV	2-3

**Table 9.62b/GSM 04.08:  
FACILITY message content (mobile station to network direction)**

NOTE 1: This message has local significance; however, it may carry information of global significance.

NOTE 2: The *facility* information element has no upper length limit except that given by the maximum number of octets in a L3 message (see GSM 04.06).

#### 9.3.9.2.1 SS version

This information element shall be included or excluded as defined in GSM 04.10. This information element should not be transmitted unless explicitly required by GSM 04.10.



**9.3.10 Hold**

This message is sent by the mobile user to request the hold function for an existing call.

See table 9.62c/GSM 04.08 for the content of the HOLD message.

For the use of this message (see GSM 04.10).

Message type: HOLD  
 Significance: local  
 Direction: mobile station to network

IEI	Information element	Type / Reference	Presence	Format	Length
	Call control protocol discriminator	Protocol discriminator 10.2	M	V	1/2
	Transaction identifier	Transaction identifier 10.3.2	M	V	1/2
	Hold message type	Message type 10.4	M	V	1

**Table 9.62c/GSM 04.08:  
 HOLD message content**

**9.3.11 Hold Acknowledge**

This message is sent by the network to indicate that the hold function has been successfully performed.

See table 9.62d/GSM 04.08 for the content of the HOLD ACKNOWLEDGE message.

For the use of this message (see GSM 04.10).

Message type: HOLD ACKNOWLEDGE  
 Significance: local  
 Direction: network to mobile station

IEI	Information element	Type / Reference	Presence	Format	Length
	Call control protocol discriminator	Protocol discriminator 10.2	M	V	1/2
	Transaction identifier	Transaction identifier 10.3.2	M	V	1/2
	Hold Acknowledge message type	Message type 10.4	M	V	1

**Table 9.62d/GSM 04.08:  
 HOLD ACKNOWLEDGE message content**

### 9.3.12 Hold Reject

This message is sent by the network to indicate the denial of a request to hold a call.

See table 9.62e/GSM 04.08 for the content of the HOLD REJECT message.

For the use of this message, see GSM 04.10.

Message type: HOLD REJECT  
Significance: local  
Direction: network to mobile station

IEI	Information element	Type / Reference	Presence	Format	Length
	Call control protocol discriminator	Protocol discriminator 10.2	M	V	1/2
	Transaction identifier	Transaction identifier 10.3.2	M	V	1/2
	Hold Reject message type	Message type 10.4	M	V	1
	Cause	10.5.4.11	M	LV	3-31

**Table 9.62e/GSM 04.08:  
HOLD REJECT message content**

**9.3.13 Modify**

This message is sent by the mobile station to the network or by the network to the mobile station to request a change in bearer capability for a call.

See table 9.63/GSM 04.08.

Message type: MODIFY  
 Significance: global  
 Direction: both

IEI	Information element	Type / Reference	Presence	Format	Length
	Call control protocol discriminator	Protocol discriminator 10.2	M	V	1/2
	Transaction identifier	Transaction identifier 10.3.2	M	V	1/2
	Modify message type	Message type 10.4	M	V	1
	Bearer capability	Bearer capability 10.5.4.5	M	LV	2-9
7C	Low layer comp.	Low layer comp. 10.5.4.18	O	TLV	2-15
7D	High layer comp.	High layer comp. 10.5.4.16	O	TLV	2-5
A3	Reverse call setup direction	Reverse call setup direction 10.5.4.22a	O	T	1

**Table 9.63/GSM 04.08:  
 MODIFY message content**

**9.3.13.1 Low layer compatibility**

This information element shall be included if it was included in the initial SETUP message.

**9.3.13.2 High layer compatibility**

This information element shall be included if it was included in the initial SETUP message.

**9.3.13.3 Reverse call setup direction**

This information element is included or omitted in the mobile to network direction according to the rules defined in section 5.3.4.3.1.

### 9.3.14 Modify complete

This message is sent by the mobile station to the network or by the network to the mobile station to indicate completion of a request to change bearer capability for a call.

See table 9.64/GSM 04.08.

Message type: MODIFY COMPLETE

Significance: global

Direction: both

IEI	Information element	Type / Reference	Presence	Format	Length
	Call control protocol discriminator	Protocol discriminator 10.2	M	V	1/2
	Transaction identifier	Transaction identifier 10.3.2	M	V	1/2
	Modify complete message type	Message type 10.4	M	V	1
	Bearer capability	Bearer capability 10.5.4.5	M	LV	2-9
7C	Low layer comp.	Low layer comp. 10.5.4.18	O	TLV	2-15
7D	High layer comp.	High layer comp. 10.5.4.16	O	TLV	2-5
A3	Reverse call setup direction	Reverse call setup direction 10.5.4.22a	O	T	1

**Table 9.64/GSM 04.08:  
MODIFY COMPLETE message content**

#### 9.3.14.1 Low layer compatibility

This information element shall be included if it was included in the initial SETUP message.

#### 9.3.14.2 High layer compatibility

This information element shall be included if it was included in the initial SETUP message.

#### 9.3.14.3 Reverse call setup direction

This information element is included or omitted according to the rules defined in section 5.3.4.3.2.

**9.3.15      Modify reject**

This message is sent by the mobile station to the network or by the network to the mobile station to indicate failure of a request to change the bearer capability for a call.

See table 9.65/GSM 04.08.

Message type:    MODIFY REJECT  
 Significance: global  
 Direction:    both

IEI	Information element	Type / Reference	Presence	Format	Length
	Call control protocol discriminator	Protocol discriminator 10.2	M	V	1/2
	Transaction identifier	Transaction identifier 10.3.2	M	V	1/2
	Modify reject message type	Message type 10.4	M	V	1
	Bearer capability	Bearer capability 10.5.4.5	M	LV	2-9
	Cause	Cause 10.5.4.11	M	LV	3-31
7C	Low layer comp.	Low layer comp. 10.5.4.18	O	TLV	2-15
7D	High layer comp.	High layer comp. 10.5.4.16	O	TLV	2-5

**Table 9.65/GSM 04.08:  
 MODIFY REJECT message content**

**9.3.15.1      Low layer compatibility**

This information element shall be included if it was included in the initial SETUP message.

**9.3.15.2      High layer compatibility**

This information element shall be included if it was included in the initial SETUP message.

### 9.3.16 Notify

This message is sent either from the mobile station or from the network to indicate information pertaining to a call, such as user suspended.

See table 9.66/GSM 04.08.

Message type: NOTIFY  
Significance: access  
Direction: both

IEI	Information element	Type / Reference	Presence	Format	Length
	Call control protocol discriminator	Protocol discriminator 10.2	M	V	1/2
	Transaction identifier	Transaction identifier 10.3.2	M	V	1/2
	Notify message type	Message type 10.4	M	V	1
	Notification indicator	Notification indicator 10.5.4.20	M	V	1

**Table 9.66/GSM 04.08:  
NOTIFY message content**

### 9.3.17 Progress

This message is sent from the network to the mobile station to indicate the progress of a call in the event of interworking or in connection with the provision of in-band information/patterns.

See table 9.67/GSM 04.08.

Message type: PROGRESS  
Significance: global  
Direction: network to mobile station

IEI	Information element	Type / Reference	Presence	Format	Length
	Call control protocol discriminator	Protocol discriminator 10.2	M	V	1/2
	Transaction identifier	Transaction identifier 10.3.2	M	V	1/2
	Progress message type	Message type 10.4	M	V	1
	Progress indicator	Progress indicator 10.5.4.21	M	LV	3
7E	User-user	User-user 10.5.4.25	O	TLV	3-35

**Table 9.67/GSM 04.08:  
PROGRESS message content**

#### 9.3.17.1 User-user

This information element is included when the PROGRESS message is sent by the network when the call has been cleared by the remote user before it reached the active state to indicate that the remote user wants to pass user information at call clearing time.

**9.3.18 Release**

**9.3.18.1 Release (network to mobile station direction)**

This message is sent, from the network to the mobile station to indicate that the network intends to release the transaction identifier, and that the receiving equipment shall release the transaction identifier after sending RELEASE COMPLETE.

See table 9.68/GSM 04.08.

Message type: RELEASE  
 Significance: local (note)  
 Direction: network to mobile station

IEI	Information element	Type / Reference	Presence	Format	Length
	Call control protocol discriminator	Protocol discriminator 10.2	M	V	1/2
	Transaction identifier	Transaction identifier 10.3.2	M	V	1/2
	Release message type	Message type 10.4	M	V	1
08	Cause	Cause 10.5.4.11	O	TLV	4-32
08	Second cause	Cause 10.5.4.11	O	TLV	4-32
1C	Facility	Facility 10.5.4.15	O	TLV	2-?
7E	User-user	User-user 10.5.4.25	O	TLV	3-35

**Table 9.68/GSM 04.08:  
 RELEASE message content (network to mobile station direction)**

NOTE: This message has local significance; however, it may carry information of global significance when used as the first call clearing message.

**9.3.18.1.1 Cause**

This information element shall be included if this message is used to initiate call clearing.

**9.3.18.1.2 Second cause**

This information element may be included under the conditions described in section 5.4.4.2.3 "Abnormal cases" (Clearing initiated by the network).

**9.3.18.1.3 Facility**

This information element may be included for functional operation of supplementary services.

**9.3.18.1.4 User-user**

This information element may be included in the network to mobile station direction, when the RELEASE message is used to initiate call clearing, in order to transport user-user information from the remote user.

**9.3.18.2 Release (mobile station to network direction)**

This message is sent from the mobile station to the network to indicate that the mobile station intends to release the transaction identifier, and that the receiving equipment shall release the transaction identifier after sending RELEASE COMPLETE.

See table 9.68a/GSM 04.08.

Message type: RELEASE  
 Significance: local (note)  
 Direction: mobile station to network direction

IEI	Information element	Type / Reference	Presence	Format	Length
	Call control protocol discriminator	Protocol discriminator 10.2	M	V	1/2
	Transaction identifier	Transaction identifier 10.3.2	M	V	1/2
	Release message type	Message type 10.4	M	V	1
08	Cause	Cause 10.5.4.11	O	TLV	4-32
08	Second cause	Cause 10.5.4.11	O	TLV	4-32
1C	Facility	Facility 10.5.4.15	O	TLV	2-?
7E	User-user	User-user 10.5.4.25	O	TLV	3-35
7F	SS version	SS version indicator 10.5.4.24	O	TLV	2-3

**Table 9.68a/GSM 04.08:  
 RELEASE message content (mobile station to network direction)**

NOTE: This message has local significance; however, it may carry information of global significance when used as the first call clearing message.



**9.3.18.2.1 Cause**

This information element shall be included if this message is used to initiate call clearing.

**9.3.18.2.2 Second cause**

This information element may be included under the conditions described in section 5.4.3.5 "Abnormal cases" (Clearing initiated by the mobile station).

**9.3.18.2.3 Facility**

This information element may be included for functional operation of supplementary services.

**9.3.18.2.4 User-user**

This information element is included when the RELEASE message is used to initiate call clearing and the Mobile Station wants to pass user information to the remote user at call clearing time.

**9.3.18.2.5 SS version**

This information element shall not be included if the *facility* information element is not present in this message.

This information element shall be included or excluded as defined in GSM 04.10. This information element should not be transmitted unless explicitly required by GSM 04.10.

**9.3.19 Release complete**

**9.3.19.1 Release complete (network to mobile station direction)**

This message is sent from the network to the mobile station to indicate that the network has released the transaction identifier and that the mobile station shall release the transaction identifier.

See table 9.69/GSM 04.08.

Message type: RELEASE COMPLETE  
Significance: local (note)  
Direction: network to mobile station direction

IEI	Information element	Type / Reference	Presence	Format	Length
	Call control protocol discriminator	Protocol discriminator 10.2	M	V	1/2
	Transaction identifier	Transaction identifier 10.3.2	M	V	1/2
	Release complete message type	Message type 10.4	M	V	1
08	Cause	Cause 10.5.4.11	O	TLV	4-32
1C	Facility	Facility 10.5.4.15	O	TLV	2-?
7E	User-user	User-user 10.5.4.25	O	TLV	3-35

**Table 9.69/GSM 04.08:  
RELEASE COMPLETE message content (network to mobile station direction)**

NOTE: This message has local significance; however, it may carry information of global significance when used as the first call clearing message.

**9.3.19.1.1 Cause**

This information element shall be included if the message is used to initiate call clearing.

**9.3.19.1.2 Facility**

This information element may be included for functional operation of supplementary services.

**9.3.19.1.3 User-user**

This information element is included in the network to mobile station direction, when the RELEASE COMPLETE message is used to initiate call clearing, in order to transport user-user information from the remote user.

**9.3.19.2 Release complete (mobile station to network direction)**

This message is sent from the mobile station to the network to indicate that the mobile station has released the transaction identifier and that the network shall release the transaction identifier.

See table 9.69a/GSM 04.08.

Message type: RELEASE COMPLETE  
 Significance: local (note)  
 Direction: mobile station to network direction

IEI	Information element	Type / Reference	Presence	Format	Length
	Call control protocol discriminator	Protocol discriminator 10.2	M	V	1/2
	Transaction identifier	Transaction identifier 10.3.2	M	V	1/2
	Release complete message type	Message type 10.4	M	V	1
08	Cause	Cause 10.5.4.11	O	TLV	4-32
1C	Facility	Facility 10.5.4.15	O	TLV	2-?
7E	User-user	User-user 10.5.4.25	O	TLV	3-35
7F	SS version	SS version indicator 10.5.4.24	O	TLV	2-3

**Table 9.69a/GSM 04.08:  
 RELEASE COMPLETE message content (mobile station to network direction)**

NOTE: This message has local significance; however, it may carry information of global significance when used as the first call clearing message.

**9.3.19.2.1 Cause**

This information element shall be included if the message is used to initiate call clearing.

**9.3.19.2.2 Facility**

This information element may be included for functional operation of supplementary services.

**9.3.19.2.3 User-user**

This information element is included in the mobile station to network direction when the RELEASE COMPLETE message is used to initiate call clearing and the Mobile Station wants to pass user information to the remote user at call clearing time.

**9.3.19.2.4 SS version.**

This information element shall not be included if the *facility* information element is not present in this message.

This information element shall be included or excluded as defined in GSM 04.10. This information element should not be transmitted unless explicitly required by GSM 04.10.

**9.3.20 Retrieve**

This message is sent by the mobile user to request the retrieval of a held call.

See table 9.69b/GSM 04.08 for the content of the RETRIEVE message.

For the use of this message, see GSM 04.10.

Message type: RETRIEVE  
Significance: local  
Direction: mobile station to network

IEI	Information element	Type / Reference	Presence	Format	Length
	Call control protocol discriminator	Protocol discriminator 10.2	M	V	1/2
	Transaction identifier	Transaction identifier 10.3.2	M	V	1/2
	Retrieve message type	Message type 10.4	M	V	1

**Table 9.69b/GSM 04.08:  
RETRIEVE message content**

### 9.3.21 Retrieve Acknowledge

This message is sent by the network to indicate that the retrieve function has been successfully performed.

See table 9.69c/GSM 04.08 for the content of the RETRIEVE ACKNOWLEDGE message.

For the use of this message, see GSM 04.10.

Message type: RETRIEVE ACKNOWLEDGE

Significance:local

Direction: network to mobile station

IEI	Information element	Type / Reference	Presence	Format	Length
	Call control protocol discriminator	Protocol discriminator 10.2	M	V	1/2
	Transaction identifier	Transaction identifier 10.3.2	M	V	1/2
	Retrieve Acknowledge message type	Message type 10.4	M	V	1

**Table 9.69c/GSM 04.08:  
RETRIEVE ACKNOWLEDGE message content**

### 9.3.22 Retrieve Reject

This message is sent by the network to indicate the inability to perform the requested retrieve function.

See table 9.69d/GSM 04.08 for the content of the RETRIEVE REJECT message.

For the use of this message, see GSM 04.10.

Message type: RETRIEVE REJECT

Significance:local

Direction: network to mobile station

IEI	Information element	Type / Reference	Presence	Format	Length
	Call control protocol discriminator	Protocol discriminator 10.2	M	V	1/2
	Transaction identifier	Transaction identifier 10.3.2	M	V	1/2
	Retrieve Reject message type	Message type 10.4	M	V	1
	Cause	10.5.4.11	M	LV	3-31

**Table 9.69d/GSM 04.08:  
RETRIEVE REJECT message content**

**9.3.23 Setup**

**9.3.23.1 Setup (mobile terminated call establishment)**

This message is sent by the network to the mobile station to initiate a mobile terminated call establishment.

See table 9.70/GSM 04.08.

Message type: SETUP  
 Significance: global  
 Direction: network to mobile station

IEI	Information element	Type / Reference	Presence	Format	Length
	Call control protocol discriminator	Protocol discriminator 10.2	M	V	1/2
	Transaction identifier	Transaction identifier 10.3.2	M	V	1/2
	Setup message type	Message type 10.4	M	V	1
D-	BC repeat indicator	Repeat indicator 10.5.4.22	C	TV	1
04	Bearer capability 1	Bearer capability 10.5.4.5	O	TLV	3-10
04	Bearer capability 2	Bearer capability 10.5.4.5	O	TLV	3-10
1C	Facility	Facility 10.5.4.15	O	TLV	2-?
1E	Progress indicator	Progress indicator 10.5.4.21	O	TLV	4
34	Signal	Signal 10.5.4.23	O	TV	2
5C	Calling party BCD number	Calling party BCD num. 10.5.4.9	O	TLV	3-14
5D	Calling party sub-address	Calling party subaddr. 10.5.4.10	O	TLV	2-23

**Table 9.70/GSM 04.08:  
 SETUP message content (network to mobile station direction)**

5E	Called party BCD number	Called party BCD num. 10.5.4.7	O	TLV	3-13
6D	Called party sub-address	Called party subaddr. 10.5.4.8	O	TLV	2-23
D-	LLC repeat indicator	Repeat indicator 10.5.4.22	O	TV	1
7C	Low layer compatibility I	Low layer comp. 10.5.4.18	O	TLV	2-15
7C	Low layer compatibility II	Low layer comp. 10.5.4.18	C	TLV	2-15
D-	HLC repeat indicator	Repeat indicator 10.5.4.22	O	TV	1
7D	High layer compatibility i	High layer comp. 10.5.4.16	O	TLV	2-5
7D	High layer compatibility ii	High layer comp. 10.5.4.16	C	TLV	2-5
7E	User-user	User-user 10.5.4.25	O	TLV	3-35

**Table 9.70/GSM 04.08 (continued):  
SETUP message content (network to mobile station direction)**

**9.3.23.1.1 BC repeat indicator**

The *BC repeat indicator* information element is included if and only if *bearer capability 1* information element and *bearer capability 2* IE are both present in the message.

**9.3.23.1.2 Bearer capability 1 and bearer capability 2**

The *bearer capability 1* information element may be omitted in the case where the mobile subscriber is allocated only one directory number for all services (ref.: GSM 09.07). The *bearer capability 2* IE is missing at least if the *bearer capability 1* IE is missing.

**9.3.23.1.3 Facility**

This information element may be included for functional operation of supplementary services.

#### 9.3.23.1.4 Progress indicator

This information element is included by the network

- in order to pass information about the call in progress e.g. in the event of interworking and/or;
- to make the MS attach the user connection for speech.

#### 9.3.23.1.5 Called party subaddress

Included in the Network-to-mobile station direction if the calling user includes a *called party subaddress* information element in the SETUP message.

#### 9.3.23.1.6 LLC repeat indicator

The *LLC repeat indicator* information element is included if and only if both following conditions hold:

- The *BC repeat indicator* IE is contained in the message.
- The *low layer compatibility I* IE is contained in the message.

If included, the *LLC repeat indicator* shall specify the same repeat indication as the *BC repeat indicator* IE.

#### 9.3.23.1.7 Low layer compatibility I

Included in the network-to-mobile station direction if the calling user specified a low layer compatibility.

#### 9.3.23.1.8 Low layer compatibility II

Included if and only if the *LLC repeat indicator* information element is contained in the message.

#### 9.3.23.1.9 HLC repeat indicator

The *HLC repeat indicator* information element is included if and only both following conditions hold:

- The *BC repeat indicator* IE is contained in the message.
- The *high layer compatibility i* IE is contained in the message.

If included, the *HLC repeat indicator* shall specify the same repeat indication as the *BC repeat indicator* IE.

#### 9.3.23.1.10 High layer compatibility i

Included in the network-to-mobile station direction if the calling user specified a high layer compatibility.

#### 9.3.23.1.11 High layer compatibility ii

Included if and only if the *HLC repeat indicator* information element is contained in the message.

#### 9.3.23.1.12 User-user

May be included in the network to called mobile station direction when the calling remote user included a user-user information element in the SETUP message.

**9.3.23.2 Setup (mobile originating call establishment)**

This message is sent from the mobile station to the network to initiate a mobile originating call establishment.

See table 9.70a/GSM 04.08.

Message type: SETUP

Significance: global

Direction: mobile station to network

IEI	Information element	Type / Reference	Presence	Format	Length
	Call control protocol discriminator	Protocol discriminator 10.2	M	V	1/2
	Transaction identifier	Transaction identifier 10.3.2	M	V	1/2
	Setup message type	Message type 10.4	M	V	1
D-	BC repeat indicator	Repeat indicator 10.5.4.22	C	TV	1
04	Bearer capability 1	Bearer capability 10.5.4.5	M	TLV	3-10
04	Bearer capability 2	Bearer capability 10.5.4.5	O	TLV	3-10
1C	Facility	Facility 10.5.4.15	O	TLV	2-?
5D	Calling party sub-address	Calling party subaddr. 10.5.4.10	O	TLV	2-23
5E	Called party BCD number	Called party BCD num. 10.5.4.7	M	TLV	3-13
6D	Called party sub-address	Called party subaddr. 10.5.4.8	O	TLV	2-23
D-	LLC repeat indicator	Repeat indicator 10.5.4.22	O	TV	1

**Table 9.70a/GSM 04.08:  
SETUP message content (mobile station to network direction)**



7C	Low layer compatibility I	Low layer comp. 10.5.4.18	O	TLV	2-15
7C	Low layer compatibility II	Low layer comp. 10.5.4.18	O	TLV	2-15
D-	HLC repeat indicator	Repeat indicator 10.5.4.22	O	TV	1
7D	High layer compatibility i	High layer comp. 10.5.4.16	O	TLV	2-5
7D	High layer compatibility ii	High layer comp. 10.5.4.16	O	TLV	2-5
7E	User-user	User-user 10.5.4.25	O	TLV	3-35
7F	SS version	SS version indicator 10.5.4.24	O	TLV	2-3
A1	CLIR suppression	CLIR suppression 10.5.4.11a	C	T	1
A2	CLIR invocation	CLIR invocation 10.5.4.11b	C	T	1
15	CC capabilities	Call Control Capabilities 10.5.4.5a	O	TLV	3

**Table 9.70a/GSM 04.08 (concluded):  
SETUP message content (mobile station to network direction)**

**9.3.23.2.1 BC repeat indicator**

The *BC repeat indicator* information element is included if and only if *bearer capability 1* IE and *bearer capability 2* IE are both present in the message.

**9.3.23.2.2 Facility**

The information element may be included for functional operation of supplementary services.

**9.3.23.2.3 LLC repeat indicator**

The *LLC repeat indicator* information element is included if and only if both following conditions hold:

- The *BC repeat indicator* IE is contained in the message.
- The *low layer compatibility I* IE is contained in the message.

If included, the *LLC repeat indicator* shall specify the same repeat indication as the *BC repeat indicator* IE.

#### 9.3.23.2.4 Low layer compatibility I

The information element is included in the MS-to-network direction when the calling MS wants to pass low layer compatibility information to the called user.

#### 9.3.23.2.5 Low layer compatibility II

Included if and only if the *LLC repeat indicator* information element is contained in the message.

#### 9.3.23.2.6 HLC repeat indicator

The *HLC repeat indicator* information element is included if and only if both following conditions hold:

- The *BC repeat indicator* IE is contained in the message.
- The *high layer compatibility i* IE is contained in the message.

If included, the *HLC repeat indicator* shall specify the same repeat indication as the *BC repeat indicator* IE.

#### 9.3.23.2.7 High layer compatibility i

The information element is included when the calling MS wants to pass high layer compatibility information to the called user.

#### 9.3.23.2.8 High layer compatibility ii

Included if and only if the *HLC repeat indicator* information element is contained in the message.

#### 9.3.23.2.9 User-user

The information element is included in the calling mobile station to network direction when the calling mobile station wants to pass user information to the called remote user.

#### 9.3.23.2.10 SS version

This information element shall not be included if the *facility* information element is not present in this message.

This information element shall be included or excluded as defined in GSM 04.10. This information element should not be transmitted unless explicitly required by GSM 04.10.

#### 9.3.23.2.11 CLIR suppression

The information element may be included by the MS (see GSM 04.81). If this information element is included the *CLIR invocation* IE shall not be included.

#### 9.3.23.2.12 CLIR invocation

The information element may be included by the MS (see GSM 04.81). If this information element is included the *CLIR suppression* IE shall not be included.

#### 9.3.23.2.13 CC Capabilities

This information element may be included by the mobile station to indicate its call control capabilities.

**9.3.24 Start DTMF**

This message is sent by the mobile station to the network and contains the digit the network should reconvert back into a DTMF tone which is then applied towards the remote user.

See table 9.71/GSM 04.08.

Message type: START DTMF  
Significance: local  
Direction: mobile station to network

IEI	Information element	Type / Reference	Presence	Format	Length
	Call control protocol discriminator	Protocol discriminator 10.2	M	V	1/2
	Transaction identifier	Transaction identifier 10.3.2	M	V	1/2
	Start DTMF message type	Message type 10.4	M	V	1
2C	Keypad facility	Keypad facility 10.5.4.17	M	TV	2

**Table 9.71/GSM 04.08:  
START DTMF message content**

**9.3.25 Start DTMF Acknowledge**

This message is sent by the network to the mobile station to indicate the successful initiation of the action requested by the START DTMF message (conversion of the digit contained in this message into a DTMF tone).

See table 9.72/GSM 04.08.

Message type: START DTMF ACKNOWLEDGE  
Significance: local  
Direction: network to mobile station

IEI	Information element	Type / Reference	Presence	Format	Length
	Call control protocol discriminator	Protocol discriminator 10.2	M	V	1/2
	Transaction identifier	Transaction identifier 10.3.2	M	V	1/2
	Start DTMF acknowledge message type	Message type 10.4	M	V	1
2C	Keypad facility	Keypad facility 10.5.4.17	M	TV	2

**Table 9.72/GSM 04.08:  
START DTMF ACKNOWLEDGE message content**

**9.3.25.1 Keypad facility**

This information element contains the digit corresponding to the DTMF tone that the network applies towards the remote user.

**9.3.26 Start DTMF reject**

This message is sent by the network to the mobile station, if the network can not accept the START DTMF message.

See table 9.73/GSM 04.08.

Message type: START DTMF REJECT  
 Significance: local  
 Direction: network to mobile station

IEI	Information element	Type / Reference	Presence	Format	Length
	Call control protocol discriminator	Protocol discriminator 10.2	M	V	1/2
	Transaction identifier	Transaction identifier 10.3.2	M	V	1/2
	Start DTMF reject message type	Message type 10.4	M	V	1
	Cause	Cause 10.5.4.11	M	LV	3-31

**Table 9.73/GSM 04.08:  
 START DTMF REJECT message content**

**9.3.27 Status**

This message is sent by the mobile station or the network at any time during a call to report certain error conditions listed in section 8. It shall also be sent in response to a STATUS ENQUIRY message.

See table 9.74/GSM 04.08.

Message type: STATUS  
 Significance: local  
 Direction: both

IEI	Information element	Type / Reference	Presence	Format	Length
	Call control protocol discriminator	Protocol discriminator 10.2	M	V	1/2
	Transaction identifier	Transaction identifier 10.3.2	M	V	1/2
	Status message type	Message type 10.4	M	V	1
	Cause	Cause 10.5.4.11	M	LV	3-31
	Call state	Call state 10.5.4.6	M	V	1
24	Auxiliary states	Auxiliary states 10.5.4.4	O	TLV	3

**Table 9.74/GSM 04.08:  
 STATUS message content**

**9.3.27.1 Auxiliary states**

The information element is included if and only if the call state is "active" or "mobile originating modify" and any auxiliary state is different from "idle". For the definition of the auxiliary states see GSM 04.83 and GSM 04.84

### 9.3.28 Status enquiry

This message is sent by the mobile station or the network at any time to solicit a STATUS message from the peer layer 3 entity. Sending of STATUS message in response to a STATUS ENQUIRY message is mandatory.

See table 9.75/GSM 04.08.

Message type: STATUS ENQUIRY  
 Significance: local  
 Direction: both

IEI	Information element	Type / Reference	Presence	Format	Length
	Call control protocol discriminator	Protocol discriminator 10.2	M	V	1/2
	Transaction identifier	Transaction identifier 10.3.2	M	V	1/2
	Status enquiry message type	Message type 10.4	M	V	1

**Table 9.75/GSM 04.08:  
 STATUS ENQUIRY message content**

### 9.3.29 Stop DTMF

This message is sent by a mobile station to the network and is used to stop the DTMF tone sent towards the remote user.

See table 9.76/GSM 04.08.

Message type: STOP DTMF  
 Significance: local  
 Direction: mobile station to network

IEI	Information element	Type / Reference	Presence	Format	Length
	Call control protocol discriminator	Protocol discriminator 10.2	M	V	1/2
	Transaction identifier	Transaction identifier 10.3.2	M	V	1/2
	Stop DTMF message type	Message type 10.4	M	V	1

**Table 9.76/GSM 04.08:  
 STOP DTMF message content**

**9.3.30 Stop DTMF acknowledge**

This message is sent by the network to the mobile station to indicate that the sending of the DTMF tone has been stopped.

See table 9.77/GSM 04.08.

Message type: STOP DTMF ACKNOWLEDGE  
 Significance:local  
 Direction: network to mobile station

IEI	Information element	Type / Reference	Presence	Format	Length
	Call control protocol discriminator	Protocol discriminator 10.2	M	V	1/2
	Transaction identifier	Transaction identifier 10.3.2	M	V	1/2
	Stop DTMF acknowledge message type	Message type 10.4	M	V	1

**Table 9.77/GSM 04.08:  
 STOP DTMF ACKNOWLEDGE message content**

**9.3.31 User information**

This message is sent by the mobile station to the network to transfer information to the remote user. This message is also sent by the network to the mobile station to deliver information transferred from the remote user. This message is used if the user-to-user transfer is part of an allowed information transfer as defined in GSM 04.10.

See table 9.78/GSM 04.08.

Message type: USER INFORMATION  
 Significance:access  
 Direction: both

IEI	Information element	Type / Reference	Presence	Format	Length
	Call control protocol discriminator	Protocol discriminator 10.2	M	V	1/2
	Transaction identifier	Transaction identifier 10.3.2	M	V	1/2
	User Information message type	Message type 10.4	M	V	1
	User-user	User-user 10.5.4.25	M	LV	3-130
A0	More data	More data 10.5.4.19	O	T	1

**Table 9.78/GSM 04.08:  
 USER INFORMATION message content**

**9.3.31.1 User-user**

Some networks may only support a maximum length of 35 octets. Procedures for interworking are not currently defined and are for further study.

**9.3.31.2 More data**

The information element is included by the sending user to indicate that another USER INFORMATION message pertaining to the same message block will follow.

## 10 General message format and information elements coding

The figures and text in this section describe the Information Elements contents.

### 10.1 Overview

Within the Layer 3 protocols defined in GSM 04.08, every message with the exception of the messages sent on the BCCH, downlink CCCH, SCH, RACH, and the HANDOVER ACCESS message, is a standard L3 message as defined in GSM 04.07. This means that the message consists of the following parts:

- a) protocol discriminator;
- b) transaction identifier;
- c) message type;
- d) other information elements, as required.

This organization is illustrated in the example shown in figure 10.1/GSM 04.08.

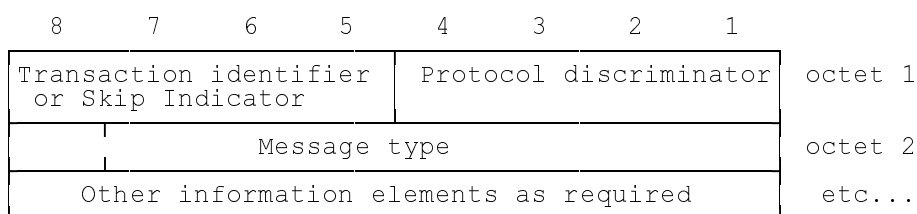

**Figure 10.1/GSM 04.08:  
General message organization example**

Unless specified otherwise in the message descriptions of section 9, a particular information element shall not be present more than once in a given message.

The term "default" implies that the value defined shall be used in the absence of any assignment, or that this value allows negotiation of alternative values in between the two peer entities.

When a field extends over more than one octet, the order of bit values progressively decreases as the octet number increases. The least significant bit of the field is represented by the lowest numbered bit of the highest numbered octet of the field.

## 10.2 Protocol Discriminator

The Protocol Discriminator (PD) and its use are defined in GSM 04.07. GSM 04.08 defines the protocols relating to the PD values:

bits	4	3	2	1	
	0	0	1	1	Call Control; call related SS messages
	0	1	0	1	Mobility Management messages
	0	1	1	0	Radio Resource management messages

except the call related SS procedures, which are defined in GSM 04.10.

## 10.3 Skip indicator and transaction identifier

### 10.3.1 Skip indicator

Bits 5 to 8 of the first octet of every Radio Resource management message and Mobility Management message contains the skip indicator. A message received with skip indicator different from 0000 shall be ignored. A message received with skip indicator encoded as 0000 shall not be ignored (unless it is ignored for other reasons). A protocol entity sending a Radio Resource management message or a Mobility Management message shall encode the skip indicator as 0000.

### 10.3.2 Transaction identifier

Bits 5 to 8 of the first octet of every message belonging to the protocol "Call Control; call related SS messages" contain the transaction identifier (TI). The transaction identifier and its use are defined in GSM 04.07.



## 10.4 Message Type

The message type IE and its use are defined in GSM 04.07. Tables 10.3/GSM 04.08, 10.4/GSM 04.08, and 10.5/GSM 04.08 define the value part of the message type IE used in the Radio Resource management protocol, the Mobility Management protocol, and the Call Control protocol.

8	7	6	5	4	3	2	1	
0	0	1	1	1	-	-	-	Channel establishment messages:
					0	1	1	- ADDITIONAL ASSIGNMENT
					1	1	1	- IMMEDIATE ASSIGNMENT
					0	0	1	- IMMEDIATE ASSIGNMENT EXTENDED
					0	1	0	- IMMEDIATE ASSIGNMENT REJECT
0	0	1	1	0	-	-	-	Ciphering messages:
					1	0	1	- CIPHERING MODE COMMAND
					0	1	0	- CIPHERING MODE COMPLETE
0	0	1	0	1	-	-	-	Handover messages:
					1	1	0	- ASSIGNMENT COMMAND
					0	0	1	- ASSIGNMENT COMPLETE
					1	1	1	- ASSIGNMENT FAILURE
					0	1	1	- HANDOVER COMMAND
					1	0	0	- HANDOVER COMPLETE
					0	0	0	- HANDOVER FAILURE
					1	0	1	- PHYSICAL INFORMATION
0	0	0	0	1	-	-	-	Channel release messages:
					1	0	1	- CHANNEL RELEASE
					0	1	0	- PARTIAL RELEASE
					1	1	1	- PARTIAL RELEASE COMPLETE
0	0	1	0	0	-	-	-	Paging messages:
					0	0	1	- PAGING REQUEST TYPE 1
					0	1	0	- PAGING REQUEST TYPE 2
					1	0	0	- PAGING REQUEST TYPE 3
					1	1	1	- PAGING RESPONSE

**Table 10.1/GSM 04.08 (page 1 of 2):  
Message types for Radio Resource management**

8	7	6	5	4	3	2	1	
0	0	0	1	1	-	-	-	System information messages:
					0	0	0	- SYSTEM INFORMATION TYPE 8
					0	0	1	- SYSTEM INFORMATION TYPE 1
					0	1	0	- SYSTEM INFORMATION TYPE 2
					0	1	1	- SYSTEM INFORMATION TYPE 3
					1	0	0	- SYSTEM INFORMATION TYPE 4
					1	0	1	- SYSTEM INFORMATION TYPE 5
					1	1	0	- SYSTEM INFORMATION TYPE 6
					1	1	1	- SYSTEM INFORMATION TYPE 7
0	0	0	0	0	-	-	-	System information messages:
					0	1	0	- SYSTEM INFORMATION TYPE 2bis
					0	1	1	- SYSTEM INFORMATION TYPE 2ter
					1	0	1	- SYSTEM INFORMATION TYPE 5bis
					1	1	0	- SYSTEM INFORMATION TYPE 5ter
0	0	0	1	0	-	-	-	Miscellaneous messages:
					0	0	0	- CHANNEL MODE MODIFY
					0	1	0	- RR STATUS
					1	1	1	- CHANNEL MODE MODIFY ACKNOWLEDGE
					1	0	0	- FREQUENCY REDEFINITION
					1	0	1	- MEASUREMENT REPORT
					1	1	0	- CLASSMARK CHANGE
					0	1	1	- CLASSMARK ENQUIRY

**Table 10.1/GSM 04.08 (page 2 of 2):  
Message types for Radio Resource management**

Bit 8 is reserved for possible future use as an extension bit (see GSM 04.07).

8	7	6	5	4	3	2	1	
0	x	0	0	-	-	-	-	Registration messages:
				0	0	0	1	- IMSI DETACH INDICATION
				0	0	1	0	- LOCATION UPDATING ACCEPT
				0	1	0	0	- LOCATION UPDATING REJECT
				1	0	0	0	- LOCATION UPDATING REQUEST
0	x	0	1	-	-	-	-	Security messages:
				0	0	0	1	- AUTHENTICATION REJECT
				0	0	1	0	- AUTHENTICATION REQUEST
				0	1	0	0	- AUTHENTICATION RESPONSE
				1	0	0	0	- IDENTITY REQUEST
				1	0	0	1	- IDENTITY RESPONSE
				1	0	1	0	- TMSI REALLOCATION COMMAND
				1	0	1	1	- TMSI REALLOCATION COMPLETE
0	x	1	0	-	-	-	-	Connection management messages:
				0	0	0	1	- CM SERVICE ACCEPT
				0	0	1	0	- CM SERVICE REJECT
				0	0	1	1	- CM SERVICE ABORT
				0	1	0	0	- CM SERVICE REQUEST
				1	0	0	0	- CM REESTABLISHMENT REQUEST
				1	0	0	1	- ABORT
0	x	1	1	-	-	-	-	Miscellaneous messages:
				0	0	0	1	- MM STATUS

**Table 10.2/GSM 04.08:  
Message types for Mobility Management**

Bit 8 is reserved for possible future use as an extension bit (see GSM 04.07).

Bit 7 is reserved for the send sequence number in messages sent from the mobile station. In messages sent from the network, bit 7 is coded with a "0" (see GSM 04.07).

8	7	6	5	4	3	2	1	
0	x	0	0	0	0	0	0	escape to nationally specific message types ; see 1) below
0	x	0	0	-	-	-	-	Call establishment messages:
		0	0	0	1			- ALERTING
		1	0	0	0			- CALL CONFIRMED
		0	0	1	0			- CALL PROCEEDING
		0	1	1	1			- CONNECT
		1	1	1	1			- CONNECT ACKNOWLEDGE
		1	1	1	0			- EMERGENCY SETUP
		0	0	1	1			- PROGRESS
		0	1	0	1			- SETUP
0	x	0	1	-	-	-	-	Call information phase messages:
		0	1	1	1			- MODIFY
		1	1	1	1			- MODIFY COMPLETE
		0	0	1	1			- MODIFY REJECT
		0	0	0	0			- USER INFORMATION
		1	0	0	0			- HOLD
		1	0	0	1			- HOLD ACKNOWLEDGE
		1	0	1	0			- HOLD REJECT
		1	1	0	0			- RETRIEVE
		1	1	0	1			- RETRIEVE ACKNOWLEDGE
		1	1	1	0			- RETRIEVE REJECT
0	x	1	0	-	-	-	-	Call clearing messages:
		0	1	0	1			- DISCONNECT
		1	1	0	1			- RELEASE
		1	0	1	0			- RELEASE COMPLETE
0	x	1	1	-	-	-	-	Miscellaneous messages:
		1	0	0	1			- CONGESTION CONTROL
		1	1	1	0			- NOTIFY
		1	1	0	1			- STATUS
		0	1	0	0			- STATUS ENQUIRY
		0	1	0	1			- START DTMF
		0	0	0	1			- STOP DTMF
		0	0	1	0			- STOP DTMF ACKNOWLEDGE
		0	1	1	0			- START DTMF ACKNOWLEDGE
		0	1	1	1			- START DTMF REJECT
		1	0	1	0			- FACILITY

**Table 10.3/GSM 04.08:**  
**Message types for Call Control and call related SS messages**

NOTE: When used, the message type is defined in the following octet(s), according to the national specification.

Bit 8 is reserved for possible future use as an extension bit (see GSM 04.07).

Bit 7 is reserved for the send sequence number in messages sent from the mobile station. In messages sent from the network, bit 7 is coded with a "0" (see GSM 04.07).

## 10.5 Other information elements

The different formats (V, LV, T, TV, TLV) and the four categories of information elements (type 1, 2, 3, and 4) are defined in GSM 04.07.

The first octet of an information element in the non-imperative part contains the IEI of the information element. If this octet does not correspond to an IEI known in the message (see GSM 04.07), the receiver shall assume that the information element is:

- if bit 8 of the first octet of the IE has the value 1, the IE is of type 1 or 2, i.e. that it is an information element of one octet length;
- if bit 8 of the first octet of the IE has the value 0, the IE is of type 4, i.e. that the next octet is the length indicator indicating the length of the remaining of the information element. If in this case bits 5, 6, and 7 of the first octet of the IE also have the value 0, the IE is encoded as "comprehension required".

NOTE 1: The handling of messages containing unknown IEs encoded as "comprehension required" is specified in section 8.

This rule allows the receiver to jump over unknown information elements and to analyse any following information elements.

The information elements which are common for at least two of the three protocols Radio Resources management, Mobility Management and Call Control, are listed in section 10.5.1.

The information elements for the protocols Radio Resources management, Mobility Management and Call Control are listed in sections 10.5.2, 10.5.3 and 10.5.4 respectively. Default information element identifiers are listed in annex K.

NOTE 2: Different information elements may have the same default information element identifier if they belong to different protocols.

The descriptions of the information element types in sections 10.5.1, 10.5.2, 10.5.3, and 10.5.4 are organized in alphabetical order of the IE types. Each IE type is described in one subsection.

The subsection may have an introduction:

- possibly explaining the purpose of the IE;
- possibly describing whether the IE belongs to type 1, 2, 3, 4 or 5;
- possibly indicating the length that the information element has if it is either type 5 or if it is used in format TV (type 1 and 3) or TLV (type 4).

A figure of the subsection defines the structure of the IE indicating:

- possibly the position and length of the IEI. (However it depends on the message in which the IE occurs whether the IE contains an IEI.);
- the fields the IE value part is composed of;
- possibly the position and length of the length indicator. (However it depends on the IE type whether the IE contains a length indicator or not.);
- possibly octet numbers of the octets that compose the IE (see clause a) below).

Finally, the subsection contains tables defining the structure and value range of the fields that compose the IE value part. The order of appearance for information elements in a message is defined in section 9.

The order of the information elements within the imperative part of messages has been chosen so that information elements with 1/2 octet of content (type 1) go together in succession. The first type 1 information element occupies bits 1 to 4 of octet N, the second bits 5 to 8 of octet N, the third bits 1 to 4 of

octet N + 1 etc. If the number of type 1 information elements is odd then bits 5 to 8 of the last octet occupied by these information elements contains a spare half octet IE in format V.

Where the description of information elements in this ETS contains bits defined to be "spare bits", these bits shall set to the indicated value (0 or 1) by the sending side, and their value shall be ignored by the receiving side. With few exceptions, spare bits are indicated as being set to "0" in GSM 04.08.

The following rules apply for the coding of type 4 information elements:

- a) The octet number of an octet (which is defined in the figure of a subsection) consists of a positive integer, possibly of an additional letter, and possibly of an additional asterisk, see clause f). The positive integer identifies one octet or a group of octets.
- b) Each octet group is a self contained entity. The internal structure of an octet group may be defined in alternative ways.
- c) An octet group is formed by using some extension mechanism. The preferred extension mechanism is to extend an octet (N) through the next octet(s) (Na, Nb, etc.) by using bit 8 in each octet as an extension bit.  
The bit value "0" indicates that the octet group continues through to the next octet. The bit value "1" indicates that this octet is the last octet of the group. If one octet (Nb) is present, the preceding octets (N and Na) shall also be present.

In the format descriptions appearing in sections 10.5.1 to 10.5.4, bit 8 is marked "0/1 ext" if another octet follows. Bit 8 is marked "1 ext" if this is the last octet in the extension domain.

Additional octets may be defined in later versions of the protocols ("1 ext" changed to "0/1 ext") and equipments shall be prepared to receive such additional octets; the contents of these octets shall be ignored. However the length indicated in sections 9 and 10 only takes into account this version of the protocols.

- d) In addition to the extension mechanism defined above, an octet (N) may be extended through the next octet(s) (N+1, N+2 etc.) by indications in bits 7-1 (of octet N).
- e) The mechanisms in c) and d) may be combined.
- f) Optional octets are marked with asterisks (\*).

## 10.5.1 Common information elements

### 10.5.1.1 Cell identity

The purpose of the *Cell Identity* information element is to identify a cell within a location area.

The *Cell Identity* information element is coded as shown in figure 10.2/GSM 04.08 and table 10.5/GSM 04.08.

The *Cell Identity* is a type 3 information element with 3 octets length.

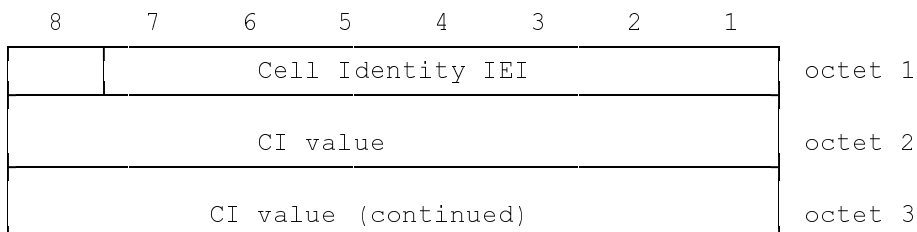

**Figure 10.2/GSM 04.08:**  
***Cell Identity* information element**

<p>CI value, Cell identity value (octet 2 and 3)</p> <p>In the CI value field bit 8 of octet 2 is the most significant bit and bit 1 of octet 3 the least significant bit.</p> <p>The coding of the cell identity is the responsibility of each administration. Coding using full hexadecimal representation may be used. The cell identity consists of 2 octets.</p>
---

**Table 10.5/GSM 04.08:**  
***Cell Identity* information element**

### 10.5.1.2 Cipherring Key Sequence Number

The purpose of the *Cipherring Key Sequence Number* information element is to make it possible for the network to identify the cipherring key  $K_c$  which is stored in the mobile station without invoking the authentication procedure. The cipherring key sequence number is allocated by the network and sent with the AUTHENTICATION REQUEST message to the mobile station where it is stored together with the calculated cipherring key  $K_c$ .

The *Cipherring Key Sequence Number* information element is coded as shown in figure 10.3/GSM 04.08 and table 10.6/GSM 04.08.

The cipherring key sequence number is a type 1 information element.

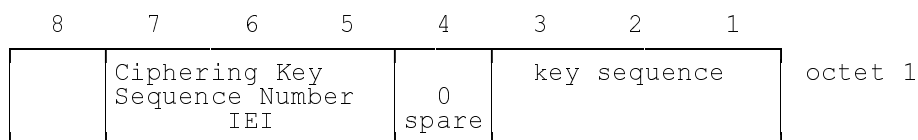

**Figure 10.3/GSM 04.08:**  
***Cipherring Key Sequence Number* information element**

Key sequence (octet 1)	
Bits	
3 2 1	
0 0 0	
through	Possible values for the cipherring key
1 1 0	sequence number
1 1 1	No key is available (MS to network); Reserved (network to MS)

**Table 10.6/GSM 04.08:**  
***Cipherring Key Sequence Number* information element**



**10.5.1.3 Location Area Identification**

The purpose of the *Location Area Identification* information element is to provide an unambiguous identification of location areas within the area covered by the GSM system.

The *Location Area Identification* information element is coded as shown in figure 10.4/GSM 04.08 and table 10.7/GSM 04.08.

The *Location Area Identification* is a type 3 information element with 6 octets length.

8	7	6	5	4	3	2	1	
Location Area Identification IEI								octet 1
MCC digit 2				MCC digit 1				octet 2
1	1	1	1	MCC digit 3				octet 3
MNC digit 2				MNC digit 1				octet 4
LAC								octet 5
LAC (continued)								octet 6

**Figure 10.4/GSM 04.08:**  
***Location Area Identification* information element**

MCC, Mobile country code (octet 2 and 3)  
The MCC field is coded as in CCITT Rec. E212, annex A.

If the LAI is deleted the MCC and MNC shall take the value from the deleted LAI.

In abnormal cases, the MCC stored in the mobile station can contain elements not in the set {0, 1 ... 9}. In such cases the mobile station should transmit the stored values using full hexadecimal encoding. When receiving such an MCC, the network shall treat the LAI as deleted.

MNC, Mobile network code (octet 4)  
The coding of this field is the responsibility of each administration but BCD coding shall be used. If an administration decides to include only one digit in the MNC then bits 5 to 8 of octet 4 are coded as "1111".

Note: GSM 03.03 defines that a 2 digit MNC shall be used, however the possibility to use a one digit MNC in LAI is provided on the radio interface

In abnormal cases, the MNC stored in the mobile station can have digit 1 not in the set {0, 1 ... 9} and/or digit 2 not in the set {0, 1 ... 9, F} hex. In such cases the mobile station should transmit the stored values using full hexadecimal encoding. When receiving such an MNC, the network shall treat the LAI as deleted.

LAC, Location area code (octet 5 and 6)  
In the LAC field bit 8 of octet 5 is the most significant bit and bit 1 of octet 6 the least significant bit.  
The coding of the location area code is the responsibility of each administration except that two values are used to mark the LAC, and hence the LAI, as deleted. Coding using full hexadecimal representation may be used. The location area code consists of 2 octets.  
If a LAI has to be deleted then all bits of the location area code shall be set to one with the exception of the least significant bit which shall be set to zero. If a SIM is inserted in a Mobile Equipment with the location area code containing all zeros, then the Mobile Equipment shall recognise this LAC as part of a deleted LAI

**Table 10.7/GSM 04.08:**  
**Location Area Identification information element**

#### 10.5.1.4 Mobile Identity

The purpose of the *Mobile Identity* information element is to provide either the international mobile subscriber identity, IMSI, the temporary mobile subscriber identity, TMSI, the international mobile equipment identity, IMEI or the international mobile equipment identity together with the software version number, IEMISV.

The IMSI shall not exceed 15 digits, the TMSI is 4 octets long, and the IMEI is composed of 15 digits, the IEMISV is 16 digits (see GSM 03.03).

For all transactions except emergency call establishment, emergency call re-establishment, mobile terminated call establishment, the identification procedure, and the ciphering mode setting procedure, the mobile station and the network shall select the mobile identity type with the following priority:

- 1- TMSI: The TMSI shall be used if it is available.
- 2- IMSI: The IMSI shall be used in cases where no TMSI is available.

For mobile terminated call establishment the mobile station shall select the same mobile identity type as received from the network in the PAGING REQUEST message.

For emergency call establishment and re-establishment the mobile station shall select the mobile identity type with the following priority:

- 1- TMSI: The TMSI shall be used if it is available.
- 2- IMSI: The IMSI shall be used in cases where no TMSI is available.
- 3- IMEI: The IMEI shall be used in cases where no SIM is available or the SIM is considered as not valid by the mobile station or no IMSI or TMSI is available.

In the identification procedure the mobile station shall select the mobile identity type which was requested by the network.

In the ciphering mode setting procedure the mobile shall select the IEMISV.

The *Mobile Identity* information element is coded as shown in figure 10.5/GSM 04.08 and table 10.8/GSM 04.08.

The *Mobile Identity* is a type 4 information element with a minimum length of 3 octet and 10 octets length maximal. Further restriction on the length may be applied, e.g. number plans.

8	7	6	5	4	3	2	1	
Mobile Identity IEI								octet 1
Length of mobile identity contents								octet 2
Identity digit 1				odd/ even indic	Type of identity			octet 3
Identity digit p+1				Identity digit p				octet 4*

**Figure 10.5/GSM 04.08:**  
**Mobile Identity information element**

Type of identity (octet 3)	
Bits	
3 2 1	
0 0 1	IMSI
0 1 0	IMEI
0 1 1	IMEISV
1 0 0	TMSI
0 0 0	No Identity note 1)
All other values are reserved.	
Odd/even indication (octet 3)	
Bit	
4	
0	even number of identity digits and also when the TMSI is used
1	odd number of identity digits
Identity digits (octet 3 etc)	
For the IMSI, IMEI and IMEISV this field is coded using BCD coding. If the number of identity digits is even then bits 5 to 8 of the last octet shall be filled with an end mark coded as "1111".	
If the mobile identity is the TMSI then bits 5 to 8 of octet 3 are coded as "1111" and bit 8 of octet 4 is the most significant bit and bit 1 of the last octet the least significant bit. The coding of the TMSI is left open for each administration.	

**Table 10.8/GSM 04.08:**  
**Mobile Identity information element**

**NOTE:** This can be used in the case when a fill paging message without any valid identity has to be sent on the paging subchannel.

### 10.5.1.5 Mobile Station Classmark 1

The purpose of the *Mobile Station Classmark 1* information element is to provide the network with information concerning aspects of high priority of the mobile station equipment. This affects the manner in which the network handles the operation of the mobile station. The Mobile Station Classmark information indicates general mobile station characteristics and it shall therefore, except for fields explicitly indicated, be independent of the frequency band of the channel it is sent on.

The *Mobile Station Classmark 1* information element is coded as shown in figure 10.6/GSM 04.08 and table 10.9/GSM 04.08.

The *Mobile Station Classmark 1* is a type 3 information element with 2 octets length.

8	7	6	5	4	3	2	1	
Mobile Station Classmark 1 IEI								octet 1
0 spare	Revision level	ES IND	A5/1	RF power capability				octet 2

**Figure 10.6/GSM 04.08:**  
***Mobile Station Classmark 1* information element**

Revision level (octet 2)

Bits

7 6

0 0 Reserved for phase 1

0 1 Used by phase 2 MSs

All other values are reserved for future use.

ES IND (octet 2, bit 5) "Controlled Early Classmark Sending" option implementation

0 "Controlled Early Classmark Sending" option is not implemented

1 "Controlled Early Classmark Sending" option is implemented

A5/1 algorithm supported (octet 2, bit 4)

0 encryption algorithm A5/1 available

1 encryption algorithm A5/1 not available

RF power capability (octet 2)

When transmitted on a channel in the GSM 900 band

Bits

3 2 1

0 0 0 class 1

0 0 1 class 2

0 1 0 class 3

0 1 1 class 4

1 0 0 class 5

All other values are reserved.

When transmitted on a channel in the DCS 1 800 band

Bits

3 2 1

0 0 0 class 1

0 0 1 class 2

0 1 0 class 3

All other values are reserved.

**Table 10.9/GSM 04.08:**  
**Mobile Station Classmark 1 information element**

### 10.5.1.6 Mobile Station Classmark 2

The purpose of the *Mobile Station Classmark 2* information element is to provide the network with information concerning aspects of both high and low priority of the mobile station equipment. This affects the manner in which the network handles the operation of the mobile station. The Mobile Station Classmark information indicates general mobile station characteristics and it shall therefore, except for fields explicitly indicated, be independent of the frequency band of the channel it is sent on.

The *Mobile Station Classmark 2* information element is coded as shown in figure 10.7/GSM 04.08, table 10.10a/GSM 04.08 and table 10.10b/GSM 04.08.

The *Mobile Station Classmark 2* is a type 4 information element with 5 octets length.

8	7	6	5	4	3	2	1	
Mobile station classmark 2 IEI								octet 1
Length of mobile station classmark 2 contents								octet 2
0 spare	Revision level	ES IND	A5/1	RF power capability				octet 3
0 spare	PS capa.	SS Screen. Indicator	SM ca pabi.	0	0	spare		FC octet 4
CM3	0	0	0	0	0	A5/3	A5/2	octet 5
		spare						

**Figure 10.7/GSM 04.08:**  
**Mobile Station Classmark 2 information element**

**NOTE:** Owing to backward compatibility problems, bit 8 of octet 4 should not be used unless it is also checked that the bits 8, 7 and 6 of octet 3 are not "0 0 0".

Revision level (octet 3)

Bits

7 6

0 0 Reserved for phase 1

0 1 Used by phase 2 MSs

All other values are reserved for future use

ES IND (octet 2, bit 5) "Controlled Early Classmark Sending" option implementation

0 "Controlled Early Classmark Sending" option is not implemented

1 "Controlled Early Classmark Sending" option is implemented

A5/1 algorithm supported (octet 3, bit 4)

0 encryption algorithm A5/1 available

1 encryption algorithm A5/1 not available

When transmitted on a channel in the GSM 900 band

Bits

3 2 1

0 0 0 class 1

0 0 1 class 2

0 1 0 class 3

0 1 1 class 4

1 0 0 class 5

All other values are reserved.

When transmitted on a channel in the DCS 1 800 band

Bits

3 2 1

0 0 0 class 1

0 0 1 class 2

0 1 0 class 3

All other values are reserved.

PS capability (pseudo-synchronization capability) (octet 4)

Bit 7

0 PS capability not present

1 PS capability present

SS Screening Indicator (octet 4)

Bits

6 5

0 0 defined in GSM 04.80

0 1 defined in GSM 04.80

1 0 defined in GSM 04.80

1 1 defined in GSM 04.80

SM capability (MT SMS pt to pt capability) (octet 4)

Bit 4

0 Mobile Station does not support mobile terminated point to point SMS

1 Mobile Station supports mobile terminated point to point SMS

**Table 10.10a/GSM 04.08:**  
**Mobile Station Classmark 2 information element**



FC Frequency Capability (octet 4)	
When transmitted on a channel in the GSM 900 band:	
bit 1	
0	The mobile station does not support the extension band G1 in addition to the primary GSM band. (For definition of frequency bands see GSM 05.05)
1	The mobile station does support the extension band G1 in addition to the primary GSM band. (For definition of frequency bands see GSM 05.05)
When transmitted on a channel in the DCS 1 800 band:	
bit 1	
0	Reserved for future use (for definition of frequency bands see GSM 05.05)
Note: This bit conveys no information about support or non support of the G1 extension band when transmitted on a DCS 1 800 channel.	
Classmark 3 (octet 5, bit 8)	
0	No additional MS capability information available
1	Additional MS capabilities are described in the Classmark 3 information element
A5/3 algorithm supported (octet 5, bit 2)	
0	encryption algorithm A5/3 not available
1	encryption algorithm A5/3 available
A5/2 algorithm supported (octet 5, bit 1)	
0	encryption algorithm A5/2 not available
1	encryption algorithm A5/2 available

**Table 10.10b/GSM 04.08:**  
***Mobile Station Classmark 2* information element**

NOTE: Additional mobile station capability information might be obtained by invoking the classmark interrogation procedure.

**10.5.1.7 Mobile Station Classmark 3**

The purpose of the *Mobile Station Classmark 3* information element is to provide the network with information concerning aspects of the mobile station. The contents might affect the manner in which the network handles the operation of the mobile station. The Mobile Station Classmark information indicates general mobile station characteristics and it shall therefore, except for fields explicitly indicated, be independent of the frequency band of the channel it is sent on.

The *Mobile Station Classmark 3* information element is coded as shown in figure 10.8/GSM 04.08 and table 10.11/GSM 04.08.

The *Mobile Station Classmark 3* is a type 4 information element with a maximum of 14 octets length.

NOTE: The 14 octet limit is so that the CLASSMARK CHANGE message will fit in one layer 2 frame.

8	7	6	5	4	3	2	1	
Mobile Station Classmark 3 IEI								octet 1
Length of mobile station classmark 3 contents								octet 2
E Bit	Band 3	Band 2	Band 1	A5/7	A5/6	A5/5	A5/4	octet 3
Associated Radio Capability 2				Associated Radio Capability 1				octet 3bis
0	0	0	0	0	0	0	0	octet N to 14 spare

**Figure 10.8/GSM 04.08:  
 Mobile Station Classmark 3 information element**

A multiband mobile station shall provide information about all frequency bands it can support. A single band mobile station shall never include octet 3bis.

Octets N to 14 are for future applications. The bits inside these octets are spare and these octets may be omitted. However, if octet n is present then octet m shall also be present, where m<n. In case of single band mobile station N is equal to 4 and in case of multiband mobile station N is currently equal to 5.

Multibands Supported Octet 3 (bit 5 to 7)

Band 1 supported (octet 3, bit 5)

- 0 P-GSM not supported
- 1 P-GSM supported

Band 2 supported (octet 3, bit 6)

- 0 E-GSM not supported
- 1 E-GSM supported

Band 3 supported (octet 3, bit 7)

- 0 DCS 1 800 not supported
- 1 DCS 1 800 supported

The indication of support of P-GSM band or E-GSM band is mutually exclusive. For single band mobile station all bits are set to 0.

E bit Octet, 3 bit 8

E bit is set to 0 for this version of protocol, the value 1 is reserved to indicate possible extension.

A5/4 algorithm supported (octet 3, bit 1)

- 0 encryption algorithm A5/4 not available
- 1 encryption algorithm A5/4 available

A5/5 algorithm supported (octet 3, bit 2)

- 0 encryption algorithm A5/5 not available
- 1 encryption algorithm A5/5 available

A5/6 algorithm supported (octet 3, bit 3)

- 0 encryption algorithm A5/6 not available
- 1 encryption algorithm A5/6 available

A5/7 algorithm supported (octet 3, bit 4)

- 0 encryption algorithm A5/7 not available
- 1 encryption algorithm A5/7 available

Associated Radio capability 1 and 2 (octet 3bis)

The radio capability 1 corresponds to the first bit set to one of the multiband support bits (in increasing order starting from band 1) and radio capability 2 corresponds to the second bit set to 1 of the multiband support bits.

For P-GSM, E-GSM and DCS 1 800:

This element contains the binary coding of the power class associated with the band indicated in multiband support bits (see GSM 05.05).

**Table 10.11/GSM 04.08:**  
**Mobile Station Classmark 3 information element**

#### 10.5.1.8 Spare Half Octet

This element is used in the description of messages in section 9 when an odd number of half octet type 1 information elements are used. This element is filled with spare bits set to zero and is placed in bits 5 to 8 of the octet unless otherwise specified.

10.5.2 Radio Resource management information elements.

10.5.2.1a BA Range

The purpose of the BA Range information element is to provide the mobile station with ARFCN range information which can be used in the cell selection procedure.

The BA Range information element is coded as shown in figure 10.8a/GSM 04.08 and table 10.12a/GSM 04.08.

The BA Range is a type 4 information element with a minimum length of 6 octets. No upper length limit is specified except for that given by the maximum number of octets in a L3 message (see GSM 04.06).

8	7	6	5	4	3	2	1	
BA RANGE IEI								octet 1
Length of BA Range contents								octet 2
Number of Ranges								octet 3
RANGE1_LOWER (high part)								octet 4
RANGE1_LOWER (low part)		RANGE1_HIGHER (high part)						octet 5
RANGE1_HIGHER (low part)			RANGE2_LOWER (high part)					octet 6
RANGE2_LOWER (low part)				RANGE2_HIGHER (high part)				octet 7
RANGE2_HIGHER (low part)								octet 8
RANGE3_LOWER (high part)								octet 9
RANGE3_LOWER (low part)		RANGE3_HIGHER (high part)						octet 10
RANGE3_HIGHER (low part)			RANGE4_LOWER (high part)					octet 11
RANGE4_LOWER (low part)				RANGE4_HIGHER (high part)				octet 12
RANGE4_HIGHER (low part)								octet 13
:								octet n

**Figure 10.8a/GSM 04.08:**  
**BA RANGE information element**

**Number of Ranges parameter**

The number of Ranges parameter indicates in binary the number of ranges to be transmitted in the IE. It shall have a minimum value of 1.

**RANGE<sub>i</sub> LOWER**

The RANGE<sub>i</sub> LOWER is coded as the binary representation of the ARFCN used as the lower limit of a range of frequencies to be used by the mobile station in cell selection (see GSM 05.08 and GSM 03.22)

**RANGE<sub>i</sub> HIGHER**

The RANGE<sub>i</sub> HIGHER is coded as the binary representation of the ARFCN used as the higher limit of a range of frequencies to be used by the mobile station in cell selection (see GSM 05.08 and GSM 03.22)

If the length of the BA range information element is greater than the number of octets required to carry the Number of Ranges given in octet 3, then any unused octets or parts of octets at the end of the IE shall be considered as spare.

**Table 10.12a/GSM 04.08:  
BA Range information element**

**10.5.2.1b Cell Channel Description**

The purpose of the *Cell Channel Description* information element is to provide the reference frequency list to be used to decode the mobile allocation information element.

The *Cell Channel Description* is a type 3 information element with 17 octets length.

There are several formats for the *Cell Channel Description* information element, distinguished by the "format indicator" subfield. Some formats are frequency bit maps, the others use a special encoding scheme.

NOTE: No more than 64 RF channels should be encoded in the Cell Allocation since this is the maximum number of RF channels which can be referenced in the Mobile Allocation IE.

**10.5.2.1b.1 General description**

Figure 10.9/04.08 shows only a special bit numbering. The different general format is described in table 10.13/04.08.

8	7	6	5	4	3	2	1	
Cell Channel Description IEI								octet 1
Bit 128	Bit 127	0 spare	0 spare	Bit 124	Bit 123	Bit 122	Bit 121	octet 2
Bit 120	Bit 119	Bit 118	Bit 117	Bit 116	Bit 115	Bit 114	Bit 113	octet 3
Bit 008	Bit 007	Bit 006	Bit 005	Bit 004	Bit 003	Bit 002	Bit 001	octet 17

**Figure 10.9/GSM 04.08:**  
*Cell Channel Description* information element (general format)

FORMAT-ID, Format Identifier (Bit 128 and next)

The different formats are distinguished by the bits of higher number. The possible values are the following:

Bit 128	Bit 127	Bit 124	Bit 123	Bit 122	format notation
0	0	X	X	X	bit map 0
1	0	0	X	X	1024 range
1	0	1	0	0	512 range
1	0	1	0	1	256 range
1	0	1	1	0	128 range
1	0	1	1	1	variable bit map

All other combinations are reserved for future use. A GSM 900 mobile station which only supports the primary GSM band P-GSM 900 (cf. GSM 05.05) may consider all values except the value for bit map 0 as reserved.

The significance of the remaining bits depends on the FORMAT-ID. The different cases are specified in the next sections.

Mobile stations shall treat all ARFCNs in the set {0, 1, 2 ... 1 023} as valid ARFCN values even if the mobile station is unable to transmit or receive on that ARFCN.

**Table 10.13/GSM 04.08:**  
**Cell Channel Description information element, general format**

10.5.2.1b.2 Bit map 0 format

8	7	6	5	4	3	2	1	
Cell Channel Description IEI								octet 1
0 0 FORMAT-ID		0 spare	0 spare	CA ARFCN 124	CA ARFCN 123	CA ARFCN 122	CA ARFCN 121	octet 2
CA ARFCN 120	CA ARFCN 119	CA ARFCN 118	CA ARFCN 117	CA ARFCN 116	CA ARFCN 115	CA ARFCN 114	CA ARFCN 113	octet 3
CA ARFCN 008	CA ARFCN 007	CA ARFCN 006	CA ARFCN 005	CA ARFCN 004	CA ARFCN 003	CA ARFCN 002	CA ARFCN 001	octet 17

**Figure 10.10/GSM 04.08:**  
*Cell Channel Description* information element, bit map 0 format

<p>CA ARFCN N, Cell Allocation Absolute RF Channel Number N (octet 2 etc.)</p> <p>For a RF channel with ARFCN = N belonging to the cell allocation the CA ARFCN N bit is coded with a "1"; N = 1, 2, .. , 124.</p> <p>For a RF channel with ARFCN = N not belonging to the cell allocation the CA ARFCN N bit is coded with a "0"; N = 1, 2 .. , 124.</p>
---

**Table 10.14/GSM 04.08:**  
*Cell channel Description* information element, bit map 0 format



**10.5.2.1b.3 Range 1 024 format**

8	7	6	5	4	3	2	1	
Cell Channel Description IEI								octet 1
1	0	0	0	0	F0	W(1) (high part)		octet 2
W(1) (low part)								octet 3
W(2) (high part)								octet 4
W(2) (low)	W(3) (high part)							octet 5
W(3) (low part)		W(4) (high part)						octet 6
W(4) (low part)		W(5) (high part)						octet 7
W(5) (low part)		W(6) (high part)						octet 8
W(6) (low part)		W(7) (high part)						octet 9
W(7) (low part)		W(8) (high part)						octet 10
W(8) (low)	W(9)							octet 11
W(10)							W(11) high	octet 12
W(11) (low part)						W(12) (high part)		octet 13
W(12) (low part)				W(13) (high part)				octet 14
W(13) (low part)			W(14) (high part)					octet 15
W(14) (low part)			W(15) (high part)					octet 16
W(15) (low part)		W(16)						octet 17

**Figure 10.11/GSM 04.08:**  
**Cell Channel Description information element (1 024 range format)**

F0, frequency 0 indicator (octet 2, bit 3):

0 ARFCN 0 is not a member of the set  
1 ARFCN 0 is a member of the set

W(i), i from 1 to 16 (octet 2 to 17):

Each W(i) encodes a non negative integer in binary format.

If W(k) is null, W(k+1) to W(16) must be null also.

Each non null W(k) allows to compute, together with some previous W(i) the ARFCN F(k) of a frequency in the set. The computation formulas are given in section 10.5.2.13.3.

**Table 10.15/GSM 04.08:**  
**Cell Channel Description information element, range 1 024 format**

10.5.2.1b.4 Range 512 format

8	7	6	5	4	3	2	1	
Cell Channel Description IEI								octet 1
1	0	0	0	1	0	0	ORIG-ARFCN high	octet 2
FORMAT-ID spare spare FORMAT-ID								
ORIG-ARFCN (middle part)								octet 3
ORIG-ARFCN low	W(1) (high part)							octet 4
W(1) (low part)		W(2) (high part)						octet 5
W(2) (low part)		W(3) (high part)						octet 6
W(3) (low part)		W(4) (high part)						octet 7
W(4) low	W(5)							octet 8
W(6)							W(7) high	octet 9
W(7) (low part)					W(8) (high part)			octet 10
W(8) (low part)				W(9) (high part)				octet 11
W(9) (low part)		W(10)						octet 12
W(11)					W(12) (high part)			octet 13
W(12) (low part)				W(13) (high part)				octet 14
W(13) (low part)		W(14)						octet 15
W(15)					W(16) (high part)			octet 16
W(16) (low part)			W(17)					octet 17

Figure 10.12/GSM 04.08:  
 Cell Channel Description information element (512 range format)

ORIG-ARFCN, origin ARFCN (octet 2, 3 and 4)

This field encodes the ARFCN of one frequency belonging to the set. This value is also used to decode the rest of the element.

$W(i)$ ,  $i$  from 1 to 17 (octet 4 to 17):

Each  $W(i)$  encodes a non negative integer in binary format.

If  $W(k)$  is null,  $W(k+1)$  to  $W(17)$  must be null also.

Each non null  $W(k)$  allows to compute, together with some previous  $W(i)$  the ARFCN  $F(k)$  of a frequency in the set. The computation formulas are given in section 10.5.2.13.4.

**Table 10.16/GSM 04.08:**  
***Cell Channel Description* information element, range 512 format**

**10.5.2.1b.5 Range 256 format**

8	7	6	5	4	3	2	1	
Cell Channel Description IEI								octet 1
1	0	0	0	1	0	1	1	ORIG-ARFCN high
FORMAT-ID		spare	spare	FORMAT-ID				octet 2
ORIG-ARFCN (middle part)								octet 3
ORIG-ARFCN low	W(1) (high part)							octet 4
W(1) low	W(2)							octet 5
W(3)						W(4) high		octet 6
W(4) (low part)				W(5) (high part)				octet 7
W(5) (low part)			W(6) (high part)					octet 8
W(6) low	W(7)						W(8) high	octet 9
W(8) (low part)			W(9) (high part)					octet 10
W(9) low	W(10)					W(11) (high part)		octet 11
W(11) (low part)			W(12)					octet 12
W(13)				W(14) (high part)				octet 13
W(14) low	W(15)					W(16) high		octet 14
W(16) (low part)			W(17)				W(18) high	octet 15
W(18) (low part)			W(19)				W(20) high	octet 16
W(20) (low part)			W(21)				0 Spare	octet 17

**Figure 10.13/GSM 04.08:**  
**Cell Channel Description information element, range 256 format**

ORIG-ARFCN, origin ARFCN (octet 2, 3 and 4)

This field encodes the ARFCN of one frequency belonging to the set. This value is also used to decode the rest of the element.

$W(i)$ ,  $i$  from 1 to 21 (octet 4 to 17):

Each  $W(i)$  encodes a non negative integer in binary format.

If  $W(k)$  is null,  $W(k+1)$  to  $W(21)$  must be null also.

Each non null  $W(k)$  allows to compute, together with some previous  $W(i)$  the ARFCN  $F(k)$  of a frequency in the set. The computation formulas are given in section 10.5.2.13.5.

**Table 10.17/GSM 04.08:**  
***Cell Channel Description* information element, range 256 format**

**10.5.2.1b.6 Range 128 format**

8	7	6	5	4	3	2	1	
Cell Channel Description IEI								octet 1
1	0	0	0	1	1	0		ORIG-ARFCN high
FORMAT-ID spare spare FORMAT-ID								octet 2
ORIG-ARFCN (middle part)								octet 3
ORIG-ARFCN low	W(1)							octet 4
W(2)						W(3) (high part)		octet 5
W(3) (low part)				W(4) (high part)				octet 6
W(4) low	W(5)					W(6) (high part)		octet 7
W(6) (low part)			W(7)					octet 8
W(8)				W(9)				octet 9
W(10)				W(11)				octet 10
W(12)				W(13)				octet 11
W(14)				W(15)				octet 12
W(16)			W(17)			W(18) (high part)		octet 13
W(18) low	W(19)			W(20)			W(21) high	octet 14
W(21) (low part)		W(22)			W(23)			octet 15
W(24)			W(25)			W(26) (high part)		octet 16
W(26) low	W(27)			W(28)			0 spare	octet 17

**Figure 10.14/GSM 04.08:**  
**Cell Channel Description information element, range 128 format**

ORIG-ARFCN, origin ARFCN (octet 2, 3 and 4)

This field encodes the ARFCN of one frequency belonging to the set. This value is also used to decode the rest of the element.

W(i), i from 1 to 28 (octet 4 to 17):

Each W(i) encodes a non negative integer in binary format.

If W(k) is null, W(k+1) to W(28) must be null also.

Each non null W(k) allows to compute, together with some previous W(i) the ARFCN F(k) of a frequency in the set. The computation formulas are given in section 10.5.2.13.6.

**Table 10.18/GSM 04.08:**  
**Cell Channel Description information element, range 128 format**

**10.5.2.1b.7 Variable bit map format**

8	7	6	5	4	3	2	1	
Cell Channel Description IEI								octet 1
1	0	0	0	1	1	1	1	ORIG-ARFCN high
FORMAT-ID		spare		FORMAT-ID				octet 2
ORIG-ARFCN (middle part)								octet 3
ORIG-ARFCN low	RRFCN 1	RRFCN 2	RRFCN 3	RRFCN 4	RRFCN 5	RRFCN 6	RRFCN 7	octet 4
RRFCN 104	RRFCN 105	RRFCN 106	RRFCN 107	RRFCN 108	RRFCN 109	RRFCN 110	RRFCN 111	octet 17

**Figure 10.15/GSM 04.08:**  
**Cell Channel Description information element, variable bit map format**



ORIG-ARFCN, origin ARFCN (octet 2, 3 and 4)

This field encodes the ARFCN of one frequency belonging to the set. This value is also used as origin of the bit map to generate all other frequencies.

RRFCN N, relative radio frequency channel number N (octet 4 etc.)

For a RF channel with  $ARFCN = (ORIG-ARFCN + N) \bmod 1024$  belonging to the set, RRFCN N bit is coded with a "1"; N = 1, 2, .., 111

For a RF channel with  $ARFCN = (ORIG-ARFCN + N) \bmod 1024$  not belonging to the set, RRFCN N bit is coded with a "0"; N = 1, 2, .., 111

**Table 10.19/GSM 04.08:**  
***Cell Channel Description* information element, variable bit map format**

**10.5.2.2 Cell Description**

The purpose of the *Cell Description* information element is to provide a minimum description of a cell, e.g. to allow the mobile station to use its preknowledge about synchronization.

The *Cell Description* information element is coded as shown in figure 10.16/GSM 04.08 and table 10.20/GSM 04.08.

The *Cell Description* is a type 3 information element with 3 octets length.

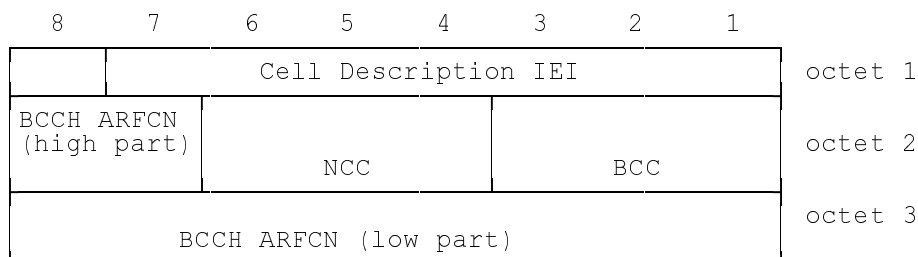

**Figure 10.16/GSM 04.08:  
 Cell Description information element**

<p>NCC, PLMN colour code (octet 2)                  The NCC field is coded as the binary representation of the PLMN colour code (see GSM 03.03)</p> <p>BCC, BS colour code (octet 2)                  The BCC field is coded as the binary representation of the BS colour code (see GSM 03.03).</p> <p>BCCH ARFCN (octet 2, bits 7 and 8, and octet 3)                  The BCCH ARFCN number field is coded as the binary representation of the BCCH carriers absolute RF channel number.</p> <p>Range: 0 to 1 023</p>
--

**Table 10.20/GSM 04.08:  
 Cell Description information element**

### 10.5.2.3 Cell Options (BCCH)

The purpose of the *Cell Options* (BCCH) information element is to provide a variety of information about a cell.

The *Cell Options* (BCCH) information element is coded as shown in figure 10.17/GSM 04.08 and table 10.21/GSM 04.08.

The *Cell Options* (BCCH) is a type 3 information element with 2 octets length.

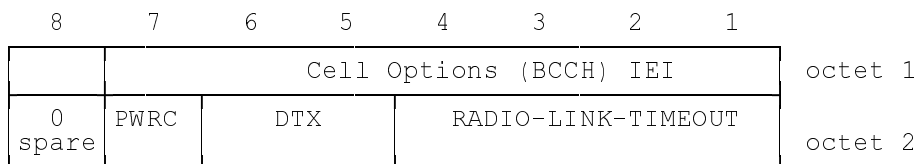

**Figure 10.17/GSM 04.08:**  
***Cell Options* (BCCH) information element**

### 10.5.2.3a Cell Options (SACCH)

The purpose of the *Cell Options* (SACCH) information element is to provide a variety of information about a cell.

The *Cell Options* (SACCH) information element is coded as shown in figure 10.17a/GSM 04.08 and table 10.21a/GSM 04.08.

The *Cell Options* (SACCH) is a type 3 information element with 2 octets length.

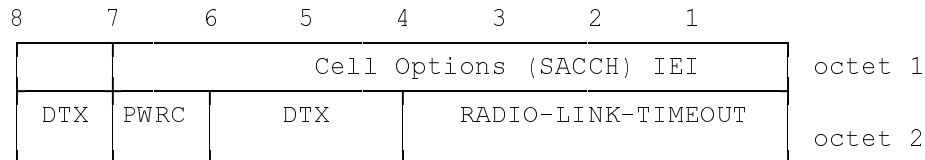

**Figure 10.17a/GSM 04.08:**  
***Cell Options* (SACCH) information element**

PWRC Power control indicator (octet 2) Note 1	
bit 7	
0	PWRC is not set
1	PWRC is set
DTX, DTX indicator (octet 2) Note 3	
Bit	
6 5	
0 0	The MSs may use uplink discontinuous transmission
0 1	The MSs shall use uplink discontinuous transmission
1 0	The MS shall not use uplink discontinuous transmission
RADIO-LINK_TIMEOUT (octet 2) Note 2	
Bits	
4 3 2 1	
0 0 0 0	4
0 0 0 1	8
0 0 1 0	12
.	
.	
1 1 1 0	60
1 1 1 1	64

**Table 10.21/GSM 04.08:**  
**Cell Options (BCCH) information element**

- NOTE 1: The precise meaning of the PWRC parameter can be found in GSM 05.08.
- NOTE 2: The precise meaning of RADIO-LINK-TIME-OUT parameter can be found in GSM 05.08.
- NOTE 3: The DTX indicator field is not related to the use of downlink discontinuous transmission.

PWRC Power control indicator (octet 2) Note 1	
bit 7	
0	PWRC is not set
1	PWRC is set
DTX, DTX indicator (octet 2) Note 3	
Bit	
8 6 5	
0 0 0	The MS may use uplink discontinuous transmission on a TCH-F. The MS shall not use uplink discontinuous transmission on TCH-H.
0 0 1	The MS shall use uplink discontinuous transmission on a TCH-F. The MS shall not use uplink discontinuous transmission on TCH-H.
0 1 0	The MS shall not use uplink discontinuous transmission on a TCH-F. The MS shall not use uplink discontinuous transmission on TCH-H.
0 1 1	Note 4: The MS shall use uplink discontinuous transmission on a TCH-F. The MS may use uplink discontinuous transmission on TCH-H.
1 0 0	The MS may use uplink discontinuous transmission on a TCH-F. The MS may use uplink discontinuous transmission on TCH-H.
1 0 1	The MS shall use uplink discontinuous transmission on a TCH-F. The MS shall use uplink discontinuous transmission on TCH-H.
1 1 0	The MS shall not use uplink discontinuous transmission on a TCH-F. The MS shall use uplink discontinuous transmission on TCH-H.
1 1 1	Note 4: The MS may use uplink discontinuous transmission on a TCH-F. The MS shall use uplink discontinuous transmission on TCH-H.
RADIO-LINK_TIMEOUT (octet 2) Note 2	
Bits	
4 3 2 1	
0 0 0 0	4
0 0 0 1	8
0 0 1 0	12
.	
.	
.	
1 1 1 0	60
1 1 1 1	64

**Table 10.21a/GSM 04.08:**  
**Cell Options (SACCH) information element**

- NOTE 1: The precise meaning of the PWRC parameter can be found in GSM 05.08.
- NOTE 2: The precise meaning of RADIO-LINK-TIME-OUT parameter can be found in GSM 05.08.
- NOTE 3: The DTX indicator field is not related to the use of downlink discontinuous transmission.
- NOTE 4: These codes shall not be sent to mobile stations that implement an earlier version of this protocol in which these codes were not defined.

**10.5.2.4 Cell Selection Parameters**

The purpose of the *Cell Selection Parameters* information element is to provide a variety of information about a cell.

The *Cell Selection Parameters* information element is coded as shown in figure 10.18/GSM 04.08 and table 10.22/GSM 04.08.

The *Cell Selection Parameters* information element is a type 3 information element with 3 octets length.

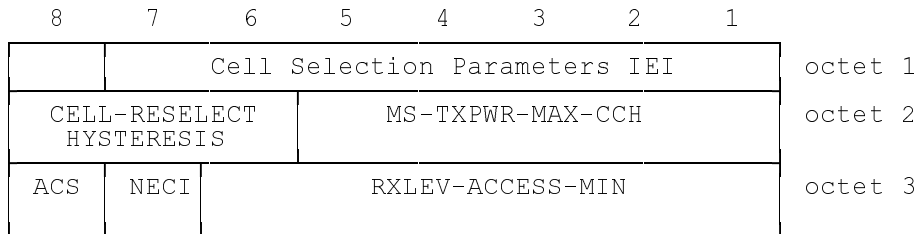

**Figure 10.18/GSM 04.08:**  
*Cell Selection Parameters* information element

CELL-RESELECT-HYSTERESIS (octet 2)	
The usage of this information is defined in GSM 05.08	
Bits	
8 7 6	
0 0 0	0 dB RXLEV hysteresis for LA re-selection
0 0 1	2 dB RXLEV hysteresis for LA re-selection
0 1 0	4 dB RXLEV hysteresis for LA re-selection
0 1 1	6 dB RXLEV hysteresis for LA re-selection
1 0 0	8 dB RXLEV hysteresis for LA re-selection
1 0 1	10 dB RXLEV hysteresis for LA re-selection
1 1 0	12 dB RXLEV hysteresis for LA re-selection
1 1 1	14 dB RXLEV hysteresis for LA re-selection
MS-TXPWR-MAX-CCH (octet 2)	
The MS-TXPWR-MAX-CCH field is coded as the binary representation of the "power control level" in GSM 05.05 corresponding to the maximum TX power level an MS may use when accessing on a Control Channel CCH. This value shall be used by the Mobile Station according to GSM 05.08.	
Range: 0 to 31.	
RXLEV-ACCESS-MIN (octet 3)	
The RXLEV-ACCESS-MIN field is coded as the binary representation of the minimum received signal level at the MS for which it is permitted to access the system.	
Range: 0 to 63. (See GSM 05.08).	
ACS, ADDITIONAL RESELECT PARAM IND (octet 3)	
Bit 8:	
In System Information type 3 message:	
Spare, set to "0"	
In System Information type 4 message:	
0	The SI 4 rest octets, if present, shall be used to derive the value of PI and possibly C2 parameters and/or other parameters
1	The value of PI and possibly C2 parameters and/or other parameters in a System information type 7 or type 8 message shall be used
NECI: HALF RATE SUPPORT (octet 3)	
Bit 7:	
0	New establishment causes are not supported
1	New establishment causes are supported

**Table 10.22/GSM 04.08:**  
**Cell Selection Parameters information element**

10.5.2.5 Channel Description

The purpose of the *Channel Description* information element is to provide a description of an allocable channel together with its SACCH.

The *Channel Description* information element is coded as shown in figure 10.19/GSM 04.08 and table 10.23/GSM 04.08.

The *Channel Description* is a type 3 information element with 4 octets length.

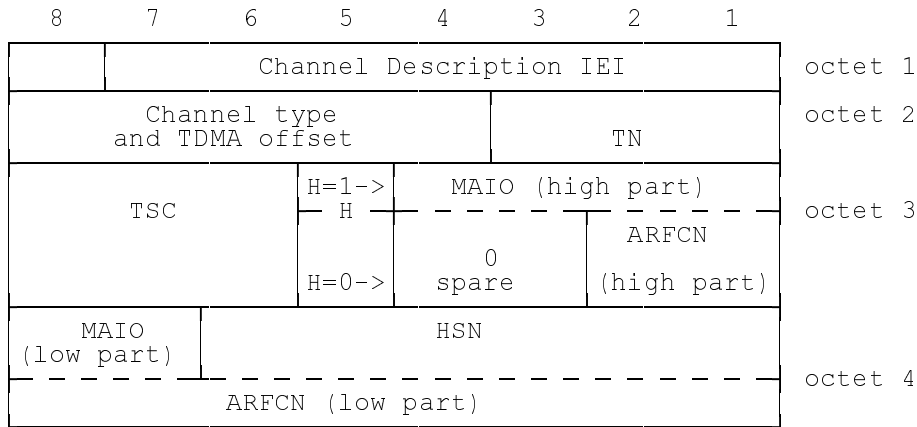

**Figure 10.19/GSM 04.08:**  
***Channel Description* information element**



Channel type and TDMA offset (octet 2)	
Bits	
8 7 6 5 4	
0 0 0 0 1	TCH/F + ACCHs
0 0 0 1 T	TCH/H + ACCHs
0 0 1 T T	SDCCH/4 + SACCH/C4 or CBCH (SDCCH/4)
0 1 T T T	SDCCH/8 + SACCH/C8 or CBCH (SDCCH/8)
The T bits indicate the subchannel number coded in binary.	
All other values are reserved.	
TN, Timeslot number (octet 2)	
The TN field is coded as the binary representation of the timeslot number as defined in GSM 05.10.	
Range: 0 to 7.	
TSC, Training Sequence Code (octet 3)	
The TSC field is coded as the binary representation of the Training Sequence code as defined in GSM 05.03	
Range: 0 to 7.	
H, Hopping channel (octet 3)	
Bit	
5	
0	Single RF channel
1	RF hopping channel
Note: The value of H affects the semantics of the channel selector field	
Channel selector (octet 3 and 4)	
H = "0": The channel selector field consists of the absolute RF channel number	
Octet 3	
Bits	
4 3	
0 0	Spare

**Table 10.23/GSM 04.08:**  
**Channel Description information element**

ARFCN, (octet 3, bits 2 and 1, and  
octet 4, bits 8 to 1)  
The ARFCN is coded as the binary representa-  
tion of the absolute RF channel number

Range: 0 to 1 023

H = "1": The channel selector field consists of the  
mobile allocation index offset, MAIO, and  
the hopping sequence number, HSN.

MAIO, (octet 3 bit 4 to 1 high part and  
octet 4 bit 8 to 7 low part)  
The MAIO field is coded as the binary rep-  
resentation of the mobile allocation index  
offset as defined in GSM 05.02.

Range: 0 to 63.

HSN, (octet 4 bit 6 to 1)  
The HSN field is coded as the binary repres-  
entation of the hopping sequence number  
as defined in GSM 05.02  
Range 0 to 63.

**Table 10.23/GSM 04.08:**  
***Channel Description* information element (continued)**

**10.5.2.6 Channel Mode**

The *Channel Mode* information element gives information of the mode on coding/decoding and transcoding. The exact mode is determined by the contents of this IE and the channel type.

The *Channel Mode* information element is coded as shown in figure 10.20/GSM 04.08 and table 10.24/GSM 04.08.

The *Channel Mode* is a type 3 information element with 2 octets length.

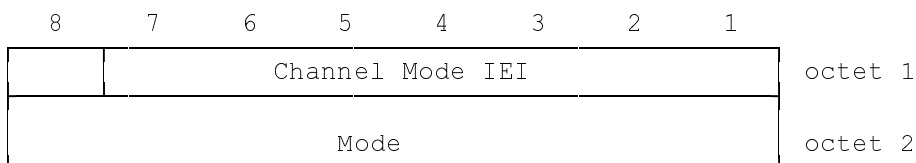

**Figure 10.20/GSM 04.08:  
Channel Mode information element**

The mode field is encoded as follows:	
(octet 2)	
Bits	
8 7 6 5 4 3 2 1	
0 0 0 0 0 0 0 0	signalling only
0 0 0 0 0 0 0 1	speech (full rate or half rate)
0 0 0 0 0 0 1 1	data, 12.0 kbit/s radio interface rate
0 0 0 0 1 0 1 1	data, 6.0 kbit/s radio interface rate
0 0 0 1 0 0 1 1	data, 3.6 kbit/s radio interface rate
Other values are reserved for future use.	

**Table 10.24/GSM 04.08:  
Channel Mode information element**

**10.5.2.7 Channel Mode 2**

The *Channel Mode 2* information element gives information of the mode of coding/decoding and transcoding.

The *Channel Mode 2* information element is coded as shown in figure 10.21/GSM 04.08 and table 10.25/GSM 04.08.

The *Channel Mode 2* is a type 3 information element with 2 octets length.

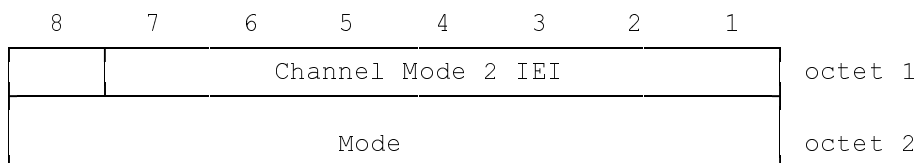

**Figure 10.21/GSM 04.08:  
 Channel Mode 2 information element**

The mode field is encoded as follows:								
(octet 2)								
Bits								
8	7	6	5	4	3	2	1	
0	0	0	0	0	0	0	0	signalling only
0	0	0	0	0	1	0	1	speech half rate
0	0	0	0	1	1	1	1	data, 6.0 kbit/s radio interface rate
0	0	0	1	0	1	1	1	data, 3.6 kbit/s radio interface rate
Other values are reserved for future use.								

**Table 10.25/GSM 04.08:  
 Channel Mode 2 information element**

**10.5.2.8 Channel Needed**

The purpose of the *Channel Needed* information element is to indicate to up to two mobile stations which type of channel is needed (for each mobile station) for the transaction linked to the paging procedure.

The *Channel Needed* information element is coded as shown in figure 10.22/GSM 04.08 and table 10.26/GSM 04.08.

The *Channel Needed* is a type 1 information element.

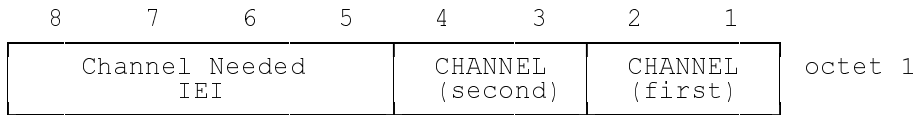

**Figure 10.22/GSM 04.08:**  
***Channel Needed* information element**

CHANNEL (octet 1)		
Bits		
2/4	1/3	
0	0	Any channel.
0	1	SDCCH.
1	0	TCH/F (Full rate).
1	1	TCH/H or TCH/F (Dual rate).
If this information element is used for only one mobile station, then the first CHANNEL field is used and the second CHANNEL field is spare.		

**Table 10.26/GSM 04.08:**  
***Channel Needed* information element**

### 10.5.2.9 Cipher Mode Setting

The purpose of the *Cipher Mode Setting* information element is to indicate whether stream ciphering shall be started or not and if it is to be started, which algorithm to use.

The *Cipher Mode Setting* information element is coded as shown in figure 10.23/GSM 04.08 and table 10.27/GSM 04.08.

The *Cipher Mode Setting* is a type 1 information element.

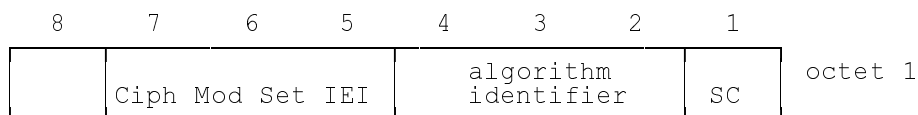

**Figure 10.23/GSM 04.08:**  
***Cipher Mode Setting* information element**

algorithm identifier	
If SC=1 then:	
bits	
4 3 2	
0 0 0	cipher with algorithm A5/1
0 0 1	cipher with algorithm A5/2
0 1 0	cipher with algorithm A5/3
0 1 1	cipher with algorithm A5/4
1 0 0	cipher with algorithm A5/5
1 0 1	cipher with algorithm A5/6
1 1 0	cipher with algorithm A5/7
1 1 1	reserved
If SC=0 then bits 4, 3 and 2 are spare and set to "0"	
SC (octet 1)	
Bit	
1	
0	No ciphering
1	Start ciphering

**Table 10.27/GSM 04.08:**  
***Cipher Mode Setting* information element**

**10.5.2.10 Cipher Response**

The *Cipher Response* information element is used by the network to indicate to the mobile station which information the mobile station has to include in the CIPHERING MODE COMPLETE message.

The *Cipher Response* information element is coded as shown in figure 10.24/GSM 04.08 and table 10.28/GSM 04.08.

The *Cipher Response* is a type 1 information element.

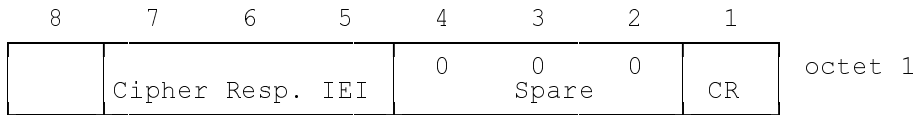

**Figure 10.24/GSM 04.08:**  
***Cipher Response* information element**

CR Cipher Response (octet 1)	
Bit	
1	
0	IMEISV shall not be included
1	IMEISV shall be included

**Table 10.28/GSM 04.08:**  
***Cipher Response* information element**

**10.5.2.11 Control Channel Description**

The purpose of the *Control Channel Description* information element is to provide a variety of information about a cell.

The *Control Channel Description* information element is coded as shown in figure 10.25/GSM 04.08 and table 10.29/GSM 04.08.

The *Control Channel Description* is a type 3 information element with 4 octets length.

8	7	6	5	4	3	2	1	
Control Channel Description IEI								octet 1
0 spare	ATT	BS-AG-BLKS-RES			CCCH-CONF			octet 2
0 spare	0 spare	0 spare	0 spare	0 spare	BS-PA-MFRMS			octet 3
T 3212 time-out value								octet 4

**Figure 10.25/GSM 04.08:**  
***Control Channel Description* information element**



ATT, Attach-detach allowed (octet 2)	
Bit	
7	
0	MSs in the cell are not allowed to apply IMSI attach and detach procedure.
1	MSs in the cell shall apply IMSI attach and detach procedure.
BS-AG-BLKS-RES (octet 2)	
The BS-AG-BLKS-RES field is coded as the binary representation of the number of blocks reserved for access grant.	
Range 0 to 2 if CCCH-CONF = "001"	
0 to 7 for other values of CCCH-CONF	
All other values are reserved in the first case	
CCCH-CONF (octet 2)	
bits	
3 2 1	
0 0 0	1 basic physical channel used for CCCH, not combined with SDCCHs
0 0 1	1 basic physical channel used for CCCH, combined with SDCCHs
0 1 0	2 basic physical channel used for CCCH, not combined with SDCCHs
1 0 0	3 basic physical channel used for CCCH, not combined with SDCCHs
1 1 0	4 basic physical channels used for CCCH, not combined with SDCCHs
all other values are reserved	

**Table 10.29/GSM 04.08:**  
**Control Channel Description information element**

BS-PA-MFRMS (octet 3)		
Bits		
3 2 1		
0 0 0	2	multiframes period for transmission of PAGING REQUEST messages to the same paging subgroup
0 0 1	3	multiframes period for transmission of PAGING REQUEST messages to the same paging subgroup
0 1 0	4	multiframes period for transmission of PAGING REQUEST messages to the same paging subgroup
.		
.		
1 1 1	9	multiframes period for transmission of PAGING REQUEST messages to the same paging subgroup
Note: The number of different paging subchannels on the CCCH is:		
$\text{MAX}(1, (3 - \text{BS-AG-BLKS-RES})) * \text{BS-PA-MFRMS}$ if CCCH-CONF = "001"		
$(9 - \text{BS-AG-BLKS-RES}) * \text{BS-PA-MFRMS}$ for other values of CCCH-CONF		
T3212 timeout value (octet 4)		
The T3212 timeout value field is coded as the binary representation of the timeout value for periodic updating in decihours.		
Range: 1 to 255		
The value 0 is used for infinite timeout value i.e. periodic updating shall not be used within the cell.		

**Table 10.29/GSM 04.08:**  
**Control Channel Description information element (concluded)**

**10.5.2.12 Frequency Channel Sequence**

The purpose of the *Frequency Channel Sequence* information element is to provide the absolute radio frequency channel numbers used in the mobile hopping sequence. This information element shall only be used for radio frequency channels in the primary GSM band (see GSM 05.05).

The *Frequency Channel Sequence* information element is coded as shown in figure 10.26/GSM 04.08 and table 10.30/GSM 04.08.

The *Frequency Channel Sequence* is a type 3 information element with 10 octets length.

8	7	6	5	4	3	2	1	
Frequency Channel Sequence IEI								octet 1
0 spare	Lowest ARFCN							octet 2
inc skip of ARFCN 01				inc skip of ARFCN 02				octet 3
⋮								
inc skip of ARFCN 15				inc skip of ARFCN 16				octet 10

**Figure 10.26/GSM 04.08:**  
***Frequency Channel Sequence* information element**

Lowest ARFCN (octet 2)

The lowest ARFCN field is coded as the binary representation of the lowest absolute RF channel number appearing in the sequence of channels used in the frequency hopping.

Range: 1 to 124

All other values are reserved.

Increment skip ARFCN n (octet 3 to 10)

The increment skip ARFCN n is coded as the binary representation of the increment of the preceding absolute RF channel number appearing in the sequence of channels used in the frequency hopping:  
n = 1, ..., 16.

Range: 0 to 15

The value 0 indicates that the increment value is 15 but the concerned channel is not used and the next field, i.e. Increment skip ARFCN n+1 (if present) must be added to the increment to determine the next absolute RF channel number in the sequence of channels used in the frequency hopping.

**Table 10.30/GSM 04.08:**  
***Frequency Channel Sequence* information element**

### 10.5.2.13 Frequency List

The purpose of the *Frequency List* information element is to provide the list of the absolute radio frequency channel numbers used in a frequency hopping sequence.

The *Frequency List* information element is a type 4 information element.

There are several formats for the *Frequency List* information element, distinguished by the "format indicator" subfield. Some formats are frequency bit maps, the others use a special encoding scheme.

#### 10.5.2.13.1 General description

FORMAT-ID, Format Identifier (part of octet 3)					
The different formats are distinguished by the FORMAT-ID field. The possible values are the following:					
Bit	Bit	Bit	Bit	Bit	format notation
8	7	4	3	2	
0	0	X	X	X	bit map 0
1	0	0	X	X	1024 range
1	0	1	0	0	512 range
1	0	1	0	1	256 range
1	0	1	1	0	128 range
1	0	1	1	1	variable bit map
All other combinations are reserved for future use. A GSM 900 mobile station which only supports the primary GSM band P-GSM 900 (cf. GSM 05.05) may consider all values except the value for bit map 0 as reserved.					
The significance of the remaining bits depends on the FORMAT-ID. The different cases are specified in the next sections.					

**Table 10.31/GSM 04.08:**  
***Frequency List* information element, general format**

10.5.2.13.2 Bit map 0 format

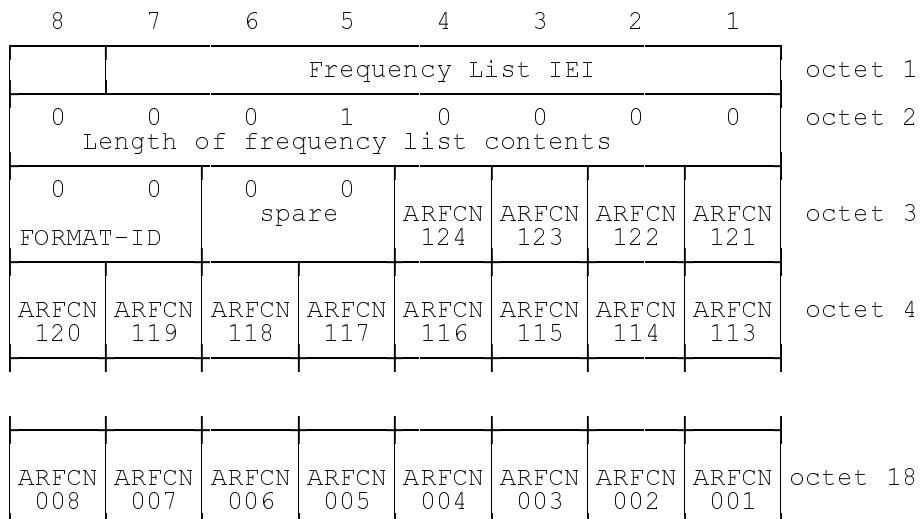

**Figure 10.27/GSM 04.08:**  
**Frequency List information element, bit map 0 format**

<p>ARFCN N, Absolute RF Channel Number N (octet 3 etc.)</p> <p>For a RF channel with ARFCN = N belonging to the frequency list the ARFCN N bit is coded with a "1"; N = 1, 2, .. , 124.</p> <p>For a RF channel with ARFCN = N not belonging to the frequency list the ARFCN N bit is coded with a "0"; N = 1, 2 .. , 124.</p>
--

**Table 10.32/GSM 04.08:**  
**Frequency List information element, bit map 0 format**

**10.5.2.13.3 Range 1 024 format**

The information element contains a header, and W(1) to W(M) for some M. If, due to octet boundaries, some bits are not used at the end of the last octet, these bits must be set to 0.

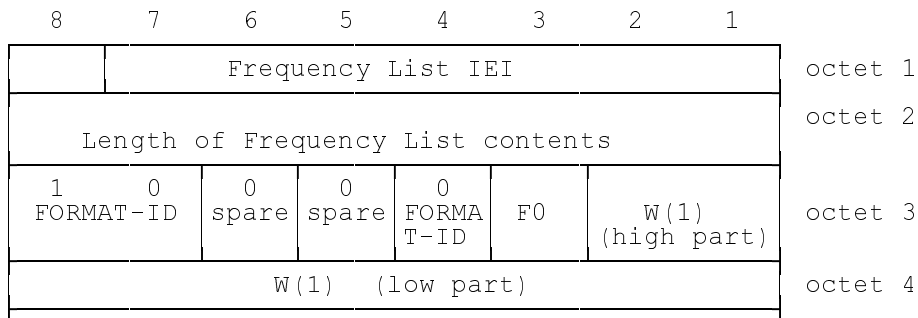

W(2) to W(3) are on 9 bits, when present  
 W(4) to W(7) are on 8 bits, when present  
 W(8) to W(15) are on 7 bits, when present  
 W(16) to W(31) are on 6 bits, when present  
 W(2k) to W(2k+1-1) are on 10-k bits when present  
 and so on



**Figure 10.28/GSM 04.08:**  
**Frequency List information element (Range 1 024 format)**

F0, frequency 0 indicator (octet 3, bit 3):

0 ARFCN 0 is not a member of the set  
1 ARFCN 0 is a member of the set

W(i), i from 1 to M (octet 3 and next):

Each W(i) encodes a non negative integer in binary format.

If W(k) is null, W(i) for  $i > k$  must be null also.

Each non null W(k) allows to compute, together with some previous W(i) the ARFCN F(k) of a frequency in the set. The first computation formulas are given hereafter, with the following conventions:

W<sub>i</sub> denotes W(i);  
F<sub>i</sub> denotes F(i);  
+ indicates the natural integer addition;  
\* indicates the natural integer multiplication;  
n mod m indicates the remainder of the euclidian division of n by m, ie  $0 \leq (n \text{ mod } m) \leq m-1$  and there exists k such that  $n = (k*m) + (n \text{ mod } m)$ ;

n smod m indicates the offset remainder of the euclidian division of n by m, ie  $1 \leq (n \text{ smod } m) \leq m$  and there exists k such that  $n = (k*m) + (n \text{ smod } m)$ ;

F1 = W1  
F2 = (W1 - 512 + W2) smod 1023  
F3 = (W1 + W3) smod 1023  
F4 = (W1 - 512 + (W2 - 256 + W4) smod 511) smod 1023  
F5 = (W1 + (W3 - 256 + W5) smod 511) smod 1023  
F6 = (W1 - 512 + (W2 + W6) smod 511) smod 1023  
F7 = (W1 + (W3 + W7) smod 511) smod 1023  
F8 = (W1 - 512 + (W2 - 256 + (W4 - 128 + W8) smod 255) smod 511) smod 1023

**Table 10.33/GSM 04.08:**  
**Frequency List information element, range 1 024 format**



F9	=	(W1	+	(W3 - 256 + (W5 - 128 + W9 )
		smod 255)	smod 511)	smod 1023
F10	=	(W1 - 512 + (W2	+	(W6 - 128 + W10)
		smod 255)	smod 511)	smod 1023
F11	=	(W1	+	(W3 - 256 + (W7 - 128 + W11)
		smod 255)	smod 511)	smod 1023
F12	=	(W1 - 512 + (W2 - 256 + (W4	+	W12)
		smod 255)	smod 511)	smod 1023
F13	=	(W1	+	(W3 - 256 + (W5
		smod 255)	smod 511)	smod 1023
F14	=	(W1 - 512 + (W2	+	(W6
		smod 255)	smod 511)	smod 1023
F15	=	(W1	+	(W3
		smod 255)	smod 511)	smod 1023
F16	=	(W1 - 512 + (W2 - 256 + (W4 - 128 +		
		(W8 - 64 + W16) smod 127)		
		smod 255)	smod 511)	smod 1023

**Table 10.33/GSM 04.08:**  
**Frequency List information element, range 1 024 format (continued)**

More generally, the computation of F(K) can be done with the following program, using ADA language (declarative parts are skipped and should be obvious):

```

INDEX := K;
J := GREATEST_POWER_OF_2_LESSER_OR_EQUAL_TO(INDEX);
N := W(INDEX);
while INDEX > 1 loop
  if 2*INDEX < 3*J then
    INDEX := INDEX - J/2;           -- left child
    N := (N + W(PARENT) - 1024/J - 1) mod
         (2048/J - 1) + 1;
  else
    INDEX := INDEX - J;           -- right child
    N := (N + W(PARENT) - 1) mod (2048/J - 1) + 1;
  end if;
  J := J/2;
end loop;
F(K) := N;

```

**10.5.2.13.4 Range 512 format**

The information element contains a header, and W(1) to W(M) for some M. If, due to octet boundaries, some bits are not used at the end of the last octet, these bits must be set to 0.

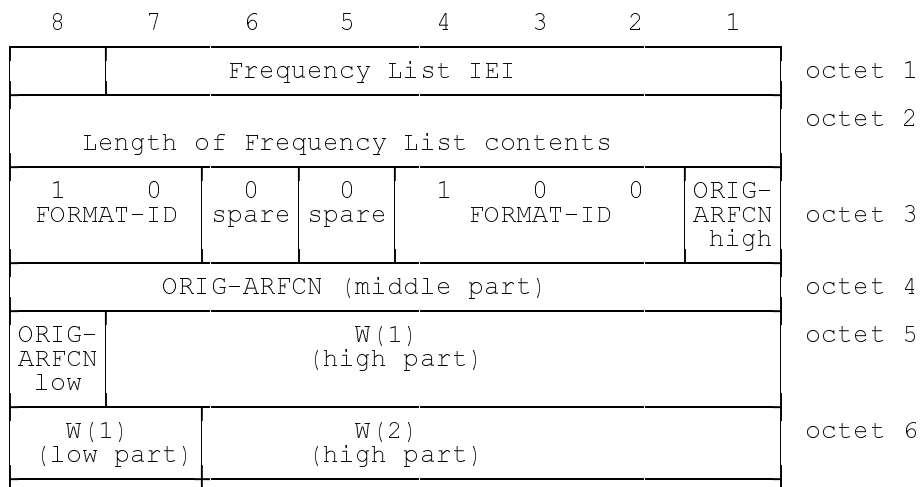

W(2) to W(3) are on 8 bits, when present  
 W(4) to W(7) are on 7 bits, when present  
 W(8) to W(15) are on 6 bits, when present  
 W(16) to W(31) are on 5 bits, when present  
 W(2k) to W(2k+1-1) are on 9-k bits when present  
 and so on

**Figure 10.29/GSM 04.08:**  
**Frequency List information element (Range 512 format)**

ORIG-ARFCN, origin ARFCN (octet 3, 4 and 5)

This field encodes the ARFCN of one frequency belonging to the set. This value is also used to decode the rest of the element.

$W(i)$ ,  $i$  from 1 to  $M$  (octet 5 and next):

Each  $W(i)$  encodes a non negative integer in binary format.

If  $W(k)$  is null,  $W(i)$  for  $i > k$  must be null also.

Each non null  $W(k)$  allows to compute, together with some previous  $W(i)$  the ARFCN  $F(k)$  of a frequency in the set. The first computation formulas are given hereafter, with the following conventions:

$W_i$  denotes  $W(i)$ ;  $W_0$  denotes the value of ORIG-ARFCN

$F_i$  denotes  $F(i)$ ;

+ indicates the natural integer addition;

\* indicates the natural integer multiplication;

$n \bmod m$  indicates the remainder of the euclidian division of  $n$  by  $m$ , ie  $0 \leq (n \bmod m) \leq m-1$  and there exists  $k$  such that  $n = (k*m) + (n \bmod m)$ ;

$n \text{ smod } m$  indicates the offset remainder of the euclidian division of  $n$  by  $m$ , ie  $1 \leq (n \text{ smod } m) \leq m$  and there exists  $k$  such that  $n = (k*m) + (n \text{ smod } m)$ ;

$F_1 = (W_0 + W_1) \bmod 1024$   
 $F_2 = (W_0 + (W_1 - 256 + W_2) \text{ smod } 511) \bmod 1024$   
 $F_3 = (W_0 + (W_1 + W_3) \text{ smod } 511) \bmod 1024$   
 $F_4 = (W_0 + (W_1 - 256 + (W_2 - 128 + W_4) \text{ smod } 255) \text{ smod } 511) \bmod 1024$   
 $F_5 = (W_0 + (W_1 + (W_3 - 128 + W_5) \text{ smod } 255) \text{ smod } 511) \bmod 1024$   
 $F_6 = (W_0 + (W_1 - 256 + (W_2 + W_6) \text{ smod } 255) \text{ smod } 511) \bmod 1024$   
 $F_7 = (W_0 + (W_1 + (W_3 + W_7) \text{ smod } 255) \text{ smod } 511) \bmod 1024$   
 $F_8 = (W_0 + (W_1 - 256 + (W_2 - 128 + (W_4 - 64 + W_8) \text{ smod } 127) \text{ smod } 255) \text{ smod } 511) \bmod 1024$   
 $F_9 = (W_0 + (W_1 + (W_3 - 128 + (W_5 - 64 + W_9) \text{ smod } 127) \text{ smod } 255) \text{ smod } 511) \bmod 1024$

**Table 10.34/GSM 04.08:**  
**Frequency List information element, range 512 format**

$$\begin{aligned}
 F10 &= (W0 + (W1 - 256 + (W2 + (W6 - 64 + W10) \\
 &\quad \text{smod } 127) \text{ smod } 255) \text{ smod } 511) \text{ mod } 1024 \\
 F11 &= (W0 + (W1 + (W3 + (W7 - 64 + W11) \\
 &\quad \text{smod } 127) \text{ smod } 255) \text{ smod } 511) \text{ mod } 1024 \\
 F12 &= (W0 + (W1 - 256 + (W2 - 128 + (W4 + W12) \\
 &\quad \text{smod } 127) \text{ smod } 255) \text{ smod } 511) \text{ mod } 1024 \\
 \\ 
 F13 &= (W0 + (W1 + (W3 - 128 + (W5 + W13) \\
 &\quad \text{smod } 127) \text{ smod } 255) \text{ smod } 511) \text{ mod } 1024 \\
 F14 &= (W0 + (W1 - 256 + (W2 + (W6 + W14) \\
 &\quad \text{smod } 127) \text{ smod } 255) \text{ smod } 511) \text{ mod } 1024 \\
 F15 &= (W0 + (W1 + (W3 + (W7 + W15) \\
 &\quad \text{smod } 127) \text{ smod } 255) \text{ smod } 511) \text{ mod } 1024 \\
 F16 &= (W0 + (W1 - 256 + (W2 - 128 + (W4 - 64 + \\
 &\quad (W8 - 32 + W16) \\
 &\quad \text{smod } 63) \text{ smod } 127) \text{ smod } 255) \text{ smod } 511) \text{ mod } 1024 \\
 F17 &= (W0 + (W1 + (W3 - 128 + (W5 - 64 + \\
 &\quad (W9 - 32 + W17) \\
 &\quad \text{smod } 63) \text{ smod } 127) \text{ smod } 255) \text{ smod } 511) \text{ mod } 1024
 \end{aligned}$$

**Table 10.34/GSM 04.08:**  
**Frequency List information element, range 512 format (continued)**

More generally, the computation of F(K) can be done with the following program, using ADA language (declarative parts are skipped and should be obvious):

```

INDEX := K;
J := GREATEST_POWER_OF_2_LESSER_OR_EQUAL_TO(INDEX);
N := W(INDEX);
while INDEX > 1 loop
  if 2*INDEX < 3*J then          -- left child
    INDEX := INDEX - J/2;
    N := (N + W(PARENT) - 512/J - 1) mod
         (1024/J - 1) + 1;
  else                            -- right child
    INDEX := INDEX - J;
    N := (N + W(_INDEX) - 1) mod (1024/J - 1) + 1;
  end if;
  J := J/2;
end loop;
F(K) := (W(0) + N) mod 1024;

```

**10.5.2.13.5 Range 256 format**

The information element contains a header, and W(1) to W(M) for some M. If, due to octet boundaries, some bits are not used at the end of the last octet, these bits must be set to 0.

8	7	6	5	4	3	2	1	
Frequency List IEI								octet 1
Length of Frequency List contents								octet 2
1	0	0	0	1	0	1	ORIG-ARFCN high	octet 3
FORMAT-ID spare spare FORMAT-ID								
ORIG-ARFCN (middle part)								octet 4
ORIG-ARFCN low	W(1) (high part)							octet 5
W(1) low	W(2)							octet 6

W(2) to W(3) are on 7 bits, when present  
 W(4) to W(7) are on 6 bits, when present  
 W(8) to W(15) are on 5 bits, when present  
 W(16) to W(31) are on 4 bits, when present  
 W(2k) to W(2k+1-1) are on 8-k bits when present  
 and so on

**Figure 10.30/GSM 04.08:**  
**Frequency List information element (Range 256 format)**

ORIG-ARFCN, origin ARFCN (octet 3, 4 and 5)

This field encodes the ARFCN of one frequency belonging to the set. This value is also used to decode the rest of the element.

$W(i)$ ,  $i$  from 1 to  $M$  (octet 5 and next):

Each  $W(i)$  encodes a non negative integer in binary format.

If  $W(k)$  is null,  $W(i)$  for  $i > k$  must be null also.

Each non null  $W(k)$  allows to compute, together with some previous  $W(i)$  the ARFCN  $F(k)$  of a frequency in the set. The first computation formulas are given hereafter, with the following conventions:

$W_i$  denotes  $W(i)$ ;  $W_0$  denotes the value of ORIG-ARFCN

$F_i$  denotes  $F(i)$ ;

$+$  indicates the natural integer addition;

$*$  indicates the natural integer multiplication;

$n \bmod m$  indicates the remainder of the euclidian division of  $n$  by  $m$ , ie  $0 \leq (n \bmod m) \leq m-1$  and there exists  $k$  such that  $n = (k*m) + (n \bmod m)$ ;

$n \text{ smod } m$  indicates the offset remainder of the euclidian division of  $n$  by  $m$ , ie  $1 \leq (n \text{ smod } m) \leq m$  and there exists  $k$  such that  $n = (k*m) + (n \text{ smod } m)$ ;

$$\begin{aligned}
 F_1 &= (W_0 + W_1) \bmod 1024 \\
 F_2 &= (W_0 + (W_1 - 128 + W_2) \text{ smod } 255) \bmod 1024 \\
 F_3 &= (W_0 + (W_1 + W_3) \text{ smod } 255) \bmod 1024 \\
 F_4 &= (W_0 + (W_1 - 128 + (W_2 - 64 + W_4) \text{ smod } 127) \text{ smod } 255) \\
 &\quad \bmod 1024 \\
 F_5 &= (W_0 + (W_1 + (W_3 - 64 + W_5) \text{ smod } 127) \text{ smod } 255) \\
 &\quad \bmod 1024 \\
 F_6 &= (W_0 + (W_1 - 128 + (W_2 + W_6) \text{ smod } 127) \text{ smod } 255) \\
 &\quad \bmod 1024 \\
 F_7 &= (W_0 + (W_1 + (W_3 + W_7) \text{ smod } 127) \text{ smod } 255) \\
 &\quad \bmod 1024
 \end{aligned}$$

**Table 10.35/GSM 04.08:**  
**Frequency List information element, range 256 format**

F8	=	(W0 + (W1 - 128 + (W2 - 64 + (W4 - 32 + W8 ) smod 63)
		smod 127) smod 255) mod 1024
F9	=	(W0 + (W1 + (W3 - 64 + (W5 - 32 + W9 ) smod 63)
		smod 127) smod 255) mod 1024
F10	=	(W0 + (W1 - 128 + (W2 + (W6 - 32 + W10) smod 63)
		smod 127) smod 255) mod 1024
F11	=	(W0 + (W1 + (W3 + (W7 - 32 + W11) smod 63)
		smod 127) smod 255) mod 1024
F12	=	(W0 + (W1 - 128 + (W2 - 64 + (W4 + W12) smod 63)
		smod 127) smod 255) mod 1024
F13	=	(W0 + (W1 + (W3 - 64 + (W5 + W13) smod 63)
		smod 127) smod 255) mod 1024
F14	=	(W0 + (W1 - 128 + (W2 + (W6 + W14) smod 63)
		smod 127) smod 255) mod 1024
F15	=	(W0 + (W1 + (W3 + (W7 + W15) smod 63)
		smod 127) smod 255) mod 1024
F16	=	(W0 + (W1 - 128 + (W2 - 64 + (W4 - 32 + (W8 - 16 + W16)
		smod 31) smod 63) smod 127) smod 255) mod 1024
F17	=	(W0 + (W1 + (W3 - 64 + (W5 - 32 + (W9 - 16 + W17)
		smod 31) smod 63) smod 127) smod 255) mod 1024
F18	=	(W0 + (W1 - 128 + (W2 + (W6 - 32 + (W10 - 16 + W18)
		smod 31) smod 63) smod 127) smod 255) mod 1024
F19	=	(W0 + (W1 + (W3 + (W7 - 32 + (W11 - 16 + W19)
		smod 31) smod 63) smod 127) smod 255) mod 1024
F20	=	(W0 + (W1 - 128 + (W2 - 64 + (W4 + (W12 - 16 + W20)
		smod 31) smod 63) smod 127) smod 255) mod 1024
F21	=	(W0 + (W1 + (W3 - 64 + (W5 + (W13 - 16 + W21)
		smod 31) smod 63) smod 127) smod 255) mod 1024

**Table 10.35/GSM 04.08:**  
**Frequency List information element, range 256 format (continued)**

More generally, the computation of F(K) can be done with the following program, using ADA language (declarative parts are skipped and should be obvious):

```

INDEX := K;
J := GREATEST_POWER_OF_2_LESSER_OR_EQUAL_TO(INDEX);
N := W(INDEX);
while INDEX > 1 loop
  if 2*INDEX < 3*J then
    INDEX := INDEX - J/2;
    N := (N + W(INDEX) - 256/J - 1) mod
         (512/J - 1) + 1;
  else
    INDEX := INDEX - J;
    N := (N + W(INDEX) - 1) mod (512/J - 1) + 1;
  end if;
  J := J/2;
end loop;
F(K) := (W(0) + N) mod 1024;

```





ORIG-ARFCN, origin ARFCN (octet 3, 4 and 5)

This field encodes the ARFCN of one frequency belonging to the set. This value is also used to decode the rest of the element.

$W(i)$ ,  $i$  from 1 to  $M$  (octet 5 and next):

Each  $W(i)$  encodes a non negative integer in binary format.

If  $W(k)$  is null,  $W(i)$  for  $i > k$  must be null also.

Each non null  $W(k)$  allows to compute, together with some previous  $W(i)$  the ARFCN  $F(k)$  of a frequency in the set. The first computation formulas are given hereafter, with the following conventions:

$W_i$  denotes  $W(i)$ ;  $W_0$  denotes the value of ORIG-ARFCN

$F_i$  denotes  $F(i)$ ;

$+$  indicates the natural integer addition;

$*$  indicates the natural integer multiplication;

$n \bmod m$  indicates the remainder of the euclidian division of  $n$  by  $m$ , ie  $0 \leq (n \bmod m) \leq m-1$  and there exists  $k$  such that  $n = (k*m) + (n \bmod m)$ ;

$n \text{ smod } m$  indicates the offset remainder of the euclidian division of  $n$  by  $m$ , ie  $1 \leq (n \text{ smod } m) \leq m$  and there exists  $k$  such that  $n = (k*m) + (n \text{ smod } m)$ ;

$$F_1 = (W_0 + W_1) \bmod 1024$$

$$F_2 = (W_0 + (W_1 - 64 + W_2) \text{ smod } 127) \bmod 1024$$

$$F_3 = (W_0 + (W_1 + W_3) \text{ smod } 127) \bmod 1024$$

$$F_4 = (W_0 + (W_1 - 64 + (W_2 - 32 + W_4) \text{ smod } 63) \text{ smod } 127) \bmod 1024$$

$$F_5 = (W_0 + (W_1 + (W_3 - 32 + W_5) \text{ smod } 63) \text{ smod } 127) \bmod 1024$$

$$F_6 = (W_0 + (W_1 - 64 + (W_2 + W_6) \text{ smod } 63) \text{ smod } 127) \bmod 1024$$

$$F_7 = (W_0 + (W_1 + (W_3 + W_7) \text{ smod } 63) \text{ smod } 127) \bmod 1024$$

**Table 10.36/GSM 04.08:**  
**Frequency List information element, range 128 format**

F8	=	(W0 + (W1 - 64 + (W2 - 32 + (W4 - 16 + W8 ) smod 31)
		smod 63) smod 127) mod 1024
F9	=	(W0 + (W1 + (W3 - 32 + (W5 - 16 + W9 ) smod 31)
		smod 63) smod 127) mod 1024
F10	=	(W0 + (W1 - 64 + (W2 + (W6 - 16 + W10) smod 31)
		smod 63) smod 127) mod 1024
F11	=	(W0 + (W1 + (W3 + (W7 - 16 + W11) smod 31)
		smod 63) smod 127) mod 1024
F12	=	(W0 + (W1 - 64 + (W2 - 32 + (W4 + W12) smod 31)
		smod 63) smod 127) mod 1024
F13	=	(W0 + (W1 + (W3 - 32 + (W5 + W13) smod 31)
		smod 63) smod 127) mod 1024
F14	=	(W0 + (W1 - 64 + (W2 + (W6 + W14) smod 31)
		smod 63) smod 127) mod 1024
F15	=	(W0 + (W1 + (W3 + (W7 + W15) smod 31)
		smod 63) smod 127) mod 1024
F16	=	(W0 + (W1 - 64 + (W2 - 32 + (W4 - 16 + (W8 - 8 + W16)
		smod 15) smod 31) smod 63) smod 127) mod 1024
F17	=	(W0 + (W1 + (W3 - 32 + (W5 - 16 + (W9 - 8 + W17)
		smod 15) smod 31) smod 63) smod 127) mod 1024
F18	=	(W0 + (W1 - 64 + (W2 + (W6 - 16 + (W10 - 8 + W18)
		smod 15) smod 31) smod 63) smod 127) mod 1024
F19	=	(W0 + (W1 + (W3 + (W7 - 16 + (W11 - 8 + W19)
		smod 15) smod 31) smod 63) smod 127) mod 1024
F20	=	(W0 + (W1 - 64 + (W2 - 32 + (W4 + (W12 - 8 + W20)
		smod 15) smod 31) smod 63) smod 127) mod 1024
F21	=	(W0 + (W1 + (W3 - 32 + (W5 + (W13 - 8 + W21)
		smod 15) smod 31) smod 63) smod 127) mod 1024
F22	=	(W0 + (W1 - 64 + (W2 + (W6 + (W14 - 8 + W22)
		smod 15) smod 31) smod 63) smod 127) mod 1024
F23	=	(W0 + (W1 + (W3 + (W7 + (W15 - 8 + W23)
		smod 15) smod 31) smod 63) smod 127) mod 1024
F24	=	(W0 + (W1 - 64 + (W2 - 32 + (W4 - 16 + (W8 + W24)
		smod 15) smod 31) smod 63) smod 127) mod 1024
F25	=	(W0 + (W1 + (W3 - 32 + (W5 - 16 + (W9 + W25)
		smod 15) smod 31) smod 63) smod 127) mod 1024
F26	=	(W0 + (W1 - 64 + (W2 + (W6 - 16 + (W10 + W26)
		smod 15) smod 31) smod 63) smod 127) mod 1024
F27	=	(W0 + (W1 + (W3 + (W7 - 16 + (W11 + W27)
		smod 15) smod 31) smod 63) smod 127) mod 1024
F28	=	(W0 + (W1 - 64 + (W2 - 32 + (W4 + (W12 + W28)
		smod 15) smod 31) smod 63) smod 127) mod 1024
F29	=	(W0 + (W1 + (W3 - 32 + (W5 + (W13 + W29)
		smod 15) smod 31) smod 63) smod 127) mod 1024

**Table 10.36/GSM 04.08:**  
**Frequency List information element, range 128 format (continued)**

More generally, the computation of F(K) can be done with the following program, using ADA language (declarative parts are skipped and should be obvious):

```
INDEX := K;
J := GREATEST_POWER_OF_2_LESSER_OR_EQUAL_TO(INDEX);
N := W(INDEX);
while INDEX > 1 loop
  if 2*INDEX < 3*J then          -- left child
    INDEX := INDEX - J/2;
    N := (N + W(INDEX) - 128/J - 1) mod
         (256/J - 1) + 1;
  else                            -- right child
    INDEX := INDEX - J;
    N := (N + W(INDEX) - 1) mod (256/J - 1) + 1;
  end if;
  J := J/2;
end loop;
F(K) := (W(0) + N) mod 1024;
```

**10.5.2.13.7 Variable bit map format**

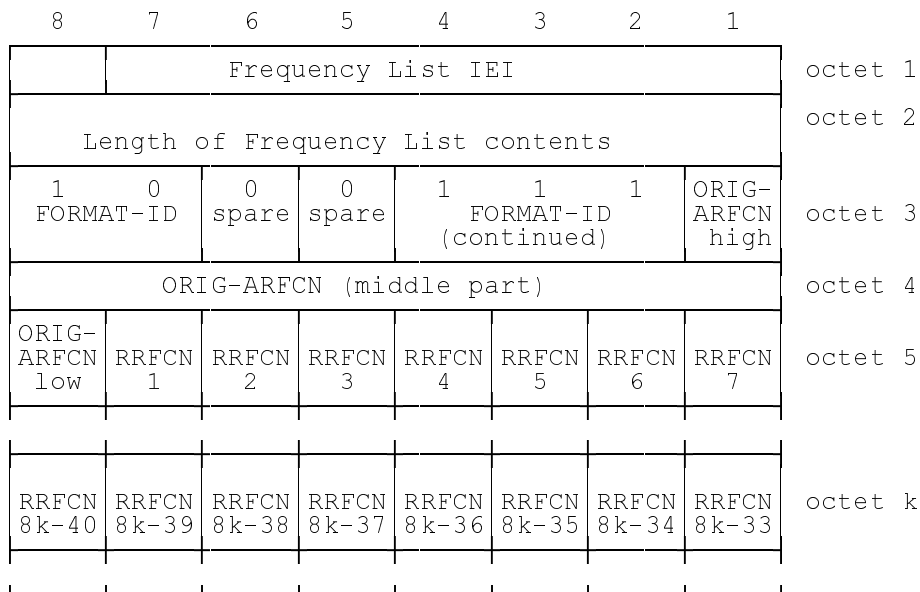

**Figure 10.32/GSM 04.08:**  
**Frequency List information element, variable bit map format**

ORIG-ARFCN, origin ARFCN (octet 3, 4 and 5)

This field encodes the ARFCN of one frequency belonging to the set. This value is also used as origin of the bit map to generate all the other frequencies.

RRFCN N, relative radio frequency channel number N (octet 5 etc.)

For a RF channel with ARFCN = (ORIG-ARFCN + N) mod 1024 belonging to the set, RRFCN N bit is coded with a "1"; N = 1, 2, .., 8M+7 with 1 ≤ M ≤ 127

For a RF channel with ARFCN = (ORIG-ARFCN + N) mod 1024 not belonging to the set, RRFCN N bit is coded with a "0"; N = 1, 2, .., 8M+7 with 1 ≤ M ≤ 127

**Table 10.37/GSM 04.08:**  
**Frequency List information element, variable bit map format**

**10.5.2.14 Frequency Short List**

The purpose of the *Frequency Short List* information element is to provide the list of the absolute radio frequency channel numbers used in a frequency hopping sequence, in a small fixed length information element to obtain when possible the HANOVER COMMAND message in a single block.

The *Frequency Short List* information element is a type 3 information element of 10 octet length.

This element is encoded exactly as the *Frequency List* information element, except that it has a fixed length instead of a variable length and does not contain a length indicator and that it shall not be encoded in bitmap 0 format.

**10.5.2.15 Handover Reference**

The purpose of the *Handover Reference* information element is to provide a handover reference value used for access identification.

The *Handover Reference* information element is coded as shown in figure 10.33/GSM 04.08 and table 10.38/GSM 04.08.

The *Handover Reference* is a type 3 information element with 2 octets length.

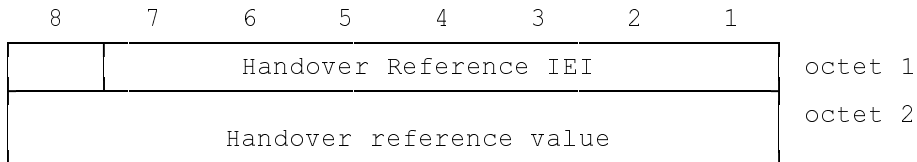

**Figure 10.33/GSM 04.08:**  
***Handover Reference* information element**

Handover reference value (octet 2) The handover reference value field is coded using binary representation.  Range: 0 to 255.
--

**Table 10.38/GSM 04.08:**  
***Handover Reference* information element**

10.5.2.16 IA Rest Octets

The *IA Rest Octets* information element contains spare bits and possibly a *frequency parameters, before time* field, which combines a mobile allocation (see section 10.5.2.21) and a MAIO (see the *channel description* information element).

The *IA Rest Octets* information element is a type 5 information element with 1-12 octets length, and is coded as shown in figures 10.34/GSM 04.08 and 10.34a/GSM 04.08 and table 10.38a/GSM 04.08.

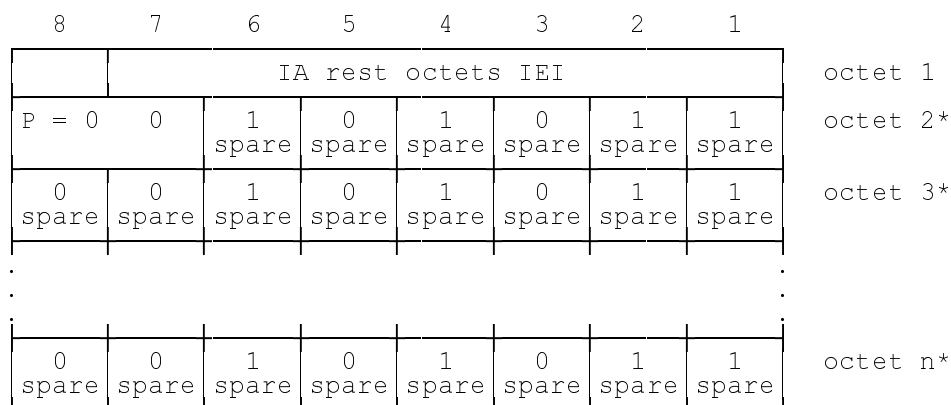

**Figure 10.34/GSM 04.08:**  
*IA rest octets* information element, P=00

8	7	6	5	4	3	2	1	
IA rest octets IEI								octet 1
P = 1 0		Length of frequency parameters contents						octet 2
0 spare	0 spare	MAIO						octet 3
MA C 8k	MA C 8k-1	MA C 8k-2	MA C 8k-3	MA C 8k-4	MA C 8k-5	MA C 8k-6	MA C 8k-7	octet 4
MA C 008	MA C 007	MA C 006	MA C 005	MA C 004	MA C 003	MA C 002	MA C 001	octet k
0 spare	0 spare	1 spare	0 spare	1 spare	0 spare	1 spare	1 spare	octet k+1
0 spare	0 spare	1 spare	0 spare	1 spare	0 spare	1 spare	1 spare	octet n

**Figure 10.34a/GSM 04.08:**  
**IA Rest Octets information element, P=10**

P (octet 2, bits 7 and 8)

P=00 indicates that the frequency parameters field is not present.

P=10 indicates that the frequency parameters field is present.

Length of frequency parameters, before time (octet 2, bits 1 to 6)

This field is coded as the binary representation of the number of octets occupied by the frequency parameters, before time field. If this length is 0, the *frequency parameters, before time* is not present.

MAIO (octet 3, bits 6 to 1)

The MAIO field is coded as the binary representation of the mobile allocation index offset.

range: 0 to 63

MA C<sub>i</sub>, Mobile allocation RF channel (octet 3 to n)

the RF channels represented in the MA C<sub>i</sub> bit fields are those which in the cell channel description information element are coded with "1"s in the CA ARFCN N bit fields. If NF denotes the number of frequencies in the mobile allocation field then:

$$MA C_i = CA ARFCN N(i): i=1,2,..,NF.$$

N(i) is an increasing function of i, i.e., the order of appearance of the RF channels in the mobile allocation field is the same as in the cell allocation field in the cell channel description information element.

For a RF channel belonging to the mobile allocation the MA C<sub>i</sub> bit is coded with a "1": i=1,2,..,NF.

For a RF channel not belonging to the mobile allocation the MA C<sub>i</sub> bit is coded with a "0": i=1,2,..,NF.

If  $NF \bmod 8 \neq 0$  then bits NF to 8k in octet 3 shall each be coded with a "0".

**Table 10.38a/GSM 04.08:**  
**IA rest octet information element**



**10.5.2.17 IAR Rest Octets**

The *IAR Rest Octets* information element contains only spare bits. Its purpose is to allow the upward compatible introduction of new information on the AGCH in later phases.

The *IAR Rest Octets* information element is a type 5 information element with 4 octets length.

8	7	6	5	4	3	2	1	
IAR Rest Octets IEI								octet 1
0 spare	0 spare	1 spare	0 spare	1 spare	0 spare	1 spare	1 spare	octet 2
0 spare	0 spare	1 spare	0 spare	1 spare	0 spare	1 spare	1 spare	octet 3
0 spare	0 spare	1 spare	0 spare	1 spare	0 spare	1 spare	1 spare	octet 4

**Figure 10.35/GSM 04.08:  
*IAR Rest Octets* information element**

**10.5.2.18 IAX Rest Octets**

The *IAX Rest Octets* information element contains only spare bits only. Its purpose is to allow the upward compatible introduction of new information on the AGCH in later phases.

The *IAX Rest Octets* information element is a type 5 information element with 1-5 octets length.

8	7	6	5	4	3	2	1	
IAX Rest Octets IEI								octet 1
0 spare	0 spare	1 spare	0 spare	1 spare	0 spare	1 spare	1 spare	octet 2*
0 spare	0 spare	1 spare	0 spare	1 spare	0 spare	1 spare	1 spare	octet 3*
.	.	.	.	.	.	.	.	
0 spare	0 spare	1 spare	0 spare	1 spare	0 spare	1 spare	1 spare	octet n*

**Figure 10.36/GSM 04.08:  
 IAX Rest Octets information element**

**10.5.2.19 L2 Pseudo Length**

The *L2 Pseudo Length* information element indicates the number of octets following it in the message which are to be interpreted in the scope of the phase 1 protocol.

The *L2 Pseudo Length* information element is the first part of e.g. SYSTEM INFORMATION messages which are mentioned as exceptions in section 10.1. It occupies the first octet of such messages.

The *L2 Pseudo Length* Information element is an element with 2 octets length.

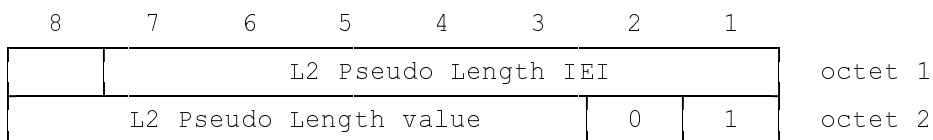

**Figure 10.37/GSM 04.08:**  
***L2 Pseudo Length* information element**

<p>L2 pseudo length value (octet 2)</p> <p>The coding of the L2 pseudo length value field is the binary representation of the L2 pseudo length of the message in which the L2 pseudo length information element occurs.</p>
---

**Table 10.39/GSM 04.08:**  
***L2 Pseudo Length* information element**

NOTE: bits 1 and 2 are not spare.

10.5.2.20 Measurement Results

The purpose of the *Measurement Results* information element is to provide the results of the measurements made by the mobile station on the serving cell and the neighbour cells.

The *Measurement Results* information element is coded as shown in figure 10.38/GSM 04.08 and table 10.40/GSM 04.08.

The *Measurement Results* is a type 3 information element with 17 octets length.

8	7	6	5	4	3	2	1	
Measurement Results IEI								octet 1
BA-USED	DTX-USED	RXLEV-FULL-SERVING-CELL						octet 2
0 spare	MEAS-VALID	RXLEV-SUB-SERVING-CELL						octet 3
0 spare	RXQUAL-FULL-SERVING-CELL			RXQUAL-SUB-SERVING-CELL		NO-NCELL-M (high part)		octet 4
NO-NCELL-M (low part)		RXLEV-NCELL 1						octet 5
BCCH-FREQ-NCELL 1				BSIC-NCELL 1 (high part)				octet 6
BSIC-NCELL 1 (low part)			RXLEV-NCELL 2 (high part)					octet 7
RXLEV-NCELL 2 (low part)	BCCH-FREQ-NCELL 2					BSIC-NCELL 2 (high part)		octet 8

**Figure 10.38/GSM 04.08:**  
**Measurement Results information element**

BSIC-NCELL 2 (low part)		RXLEV-NCELL 3 (high part)		octet 9
RXLEV-NCELL 3 (low part)	BCCH-FREQ-NCELL 3		BSIC-NCELL 3 (high part)	octet 10
BSIC-NCELL 3 (low part)		RXLEV-NCELL 4 (high part)		octet 11
RXLEV-NCELL 4 (low part)	BCCH-FREQ-NCELL 4			octet 12
BSIC-NCELL 4			RXLEV-NCELL 5 (high part)	octet 13
RXLEV-NCELL 5 (low part)		BCCH-FREQ-NCELL 5 (high part)		octet 14
BCCH-FREQ-NCELL 5 (low part)	BSIC-NCELL 5		RXLEV-NCELL 6 (high part)	octet 15
RXLEV-NCELL 6 (low part)		BCCH-FREQ-NCELL 6 (high part)		octet 16
BCCH-FREQ-NCELL 6 (low part)	BSIC-NCELL 6			octet 17

**Figure 10.38/GSM 04.08:**  
**Measurement Results information element (continued)**

BA-USED (octet 2), the value of the BA-IND field of the neighbour cells description information element or elements defining the BCCH allocation used for the coding of BCCH-FREQ-NCELL fields. Range 0 to 1.

DTX-USED (octet 2)

This bit indicates whether or not the MS used DTX during the previous measurement period.

Bit

7

0 DTX was not used

1 DTX was used

RXLEV-FULL-SERVING-CELL and RXLEV-SUB-SERVING-CELL, (octets 2 and 3)

Received signal strength on serving cell, measured respectively on all slots and on a subset of slots (see GSM 05.08)

The RXLEV-FULL-SERVING-CELL and RXLEV-SUB-SERVING-CELL fields are coded as the binary representation of a value N. N corresponds according to the mapping defined in GSM 05.08 to the received signal strength on the serving cell.

Range: 0 to 63

MEAS-VALID (octet 3)

This bit indicates if the measurement results for the dedicated channel are valid or not

Bit

7

0 The measurement results are valid

1 the measurement results are not valid

RXQUAL-FULL-SERVING-CELL and RXQUAL-SUB-SERVING-CELL (octet 4)

Received signal quality on serving cell, measured respectively on all slots and on a subset of the slots (see GSM 05.08)

**Table 10.40/GSM 04.08:**  
**Measurement Results information element**

The RXQUAL-FULL-SERVING-CELL and RXQUAL-SUB-SERVING-CELL fields are coded as the binary representation of the received signal quality on the serving cell.

Range: 0 to 7 (see GSM 05.08)

NO-NCELL-M, Number of neighbouring cell measurements (octets 4 and 5)

Bits

1 8 7

0 0 0 No neighbour cell measurement result

0 0 1 1 " " " "

0 1 0 2 " " " "

0 1 1 3 " " " "

1 0 0 4 " " " "

1 0 1 5 " " " "

1 1 0 6 " " " "

1 1 1 Neighbour cell information not available for serving cell

RXLEV-NCELL *i*, Received signal strength on the *i*'th neighbouring cell (octet 5, 7, 8, 9, 10, 11, 12, 13, 14, 15 and 16)

The RXLEV-NCELL field is coded as the binary representation of a value *N*. *N* corresponds according to the mapping defined in GSM 05.08 to the received signal strength on the *i*'th neighbouring cell( see note 1 & 2).

Range: 0 to 63.

**Table 10.40/GSM 04.08:**  
**Measurement Results information element (continued)**

BCCH-FREQ-NCELL  $i$ , BCCH carrier of the  $i$ 'th neighbouring cell (octet 6, 8, 10, 12, 14, 15, 16 and 17)

The BCCH-FREQ-NCELL  $i$  field is coded as the binary representation of the position, starting with 0, of the  $i$ 'th neighbouring cells BCCH carrier in the BCCH channel list.

The BCCH channel list is composed of one or two BCCH channel sub lists, each sub list is derived from the set of frequencies defined by reference neighbour cells description information element or elements. In the latter case the set is the union of the two sets defined by the two neighbour cells description information elements. In each BCCH channel sub list the absolute RF channel numbers are placed in increasing order of ARFCN, except that ARFCN 0, if included in the set, is put in the last position in the sub list. The BCCH channel list consists either of only the sub list derived from the neighbour cells description information element(s) in System Information 2/5 (and possible 2bis/5bis) or of that sub list immediately followed by the sub list derived from the neighbour cells description information element in System Information 2ter/5ter for the case System Information 2ter/5ter is also received. If the set of ARFCNs defined by the reference neighbour cells description information element or elements includes frequencies that the mobile station does not support then these ARFCNs shall be included in the list.

The notation 2/5 etc. means that the rules above apply to the neighbour cells description information elements received in System Information 2, 2bis and 2ter and to those received in System Information 5, 5bis and 5ter separately.

See note 1 & 2.

Range: 0 to 31.

BSIC-NCELL  $i$ , Base station identity code of the  $i$ 'th neighbouring cell (octet 6, 7, 8, 9, 10, 11, 13, 15 and 17)

The BSIC-NCELL  $i$  field is coded as the binary representation of the base station identity code of the  $i$ 'th neighbouring cell. See note 1 & 2.

Range: 0 to 63.

NOTE 1: If the field extends over two octets the highest numbered bit of the lowest numbered octet is the most significant and the lowest numbered bit of the highest numbered octet is the least significant.

NOTE 2: If NO-NCELL-M < 6 the remaining RXLEV-NCELL  $i$ , BS-FREQ-NCELL  $i$  and BSIC-NCELL  $i$  fields (NO-NCELL-M <  $i$  <= 6) shall be coded with a "0" in each bit.

**Table 10.40/GSM 04.08:**  
**Measurement Results information element (concluded)**



**10.5.2.21 Mobile Allocation**

The purpose of the *Mobile Allocation* information element is to provide that part of the RF channels belonging to the cell allocation (coded with a "1" in the cell channel description information element) which is used in the mobile hopping sequence.

The *Mobile Allocation* information element is coded as shown in figure 10.39/GSM 04.08 and table 10.41/GSM 04.08.

The *Mobile Allocation* is a type 4 information element with 3 to 10 octets length except for the cases specified in sections 9.1.18.1 and 9.1.19.2.

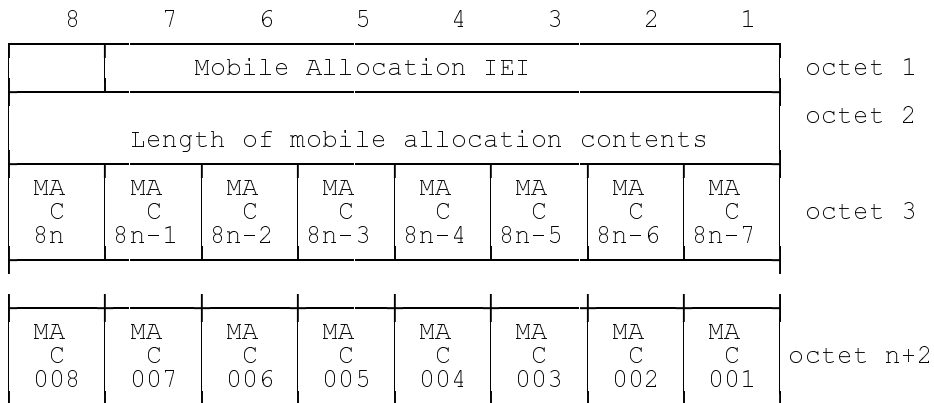

**Figure 10.39/GSM 04.08:**  
***Mobile Allocation* information element.**

MA C i, Mobile allocation RF channel i (octet 3 etc.),  $i = 1, 2, \dots, NF$   
The MA C i bit indicates whether or not the Mobile allocation frequency list includes the i'th frequency in the cell allocation frequency list. The cell allocation frequency list is derived from the set of frequencies defined by the reference cell channel description information element. NF denotes the number of frequencies in the cell allocation frequency list.  
In the cell allocation frequency list the absolute RF channel numbers are placed in increasing order of ARFCN, except that ARFCN 0, if included in the set, is put in the last position in the list,

For a RF channel belonging to the mobile allocation the MA C i bit is coded with a "1";  $i = 1, 2, \dots, NF$ .

For a RF channel not belonging to the mobile allocation the MA C i bit is coded with a "0";  $i = 1, 2, \dots, NF$ .

If  $NF \bmod 8 \neq 0$  then bits NF to  $8n$  in octet 3 must be coded with a "0" in each.

**Table 10.41/GSM 04.08:**  
**Mobile Allocation information element**

**10.5.2.21a Mobile Time Difference**

A *Mobile Time Difference* information element encodes a time related to the synchronization difference between the time bases of two base stations. This type of information is used in conjunction with the HANDOVER COMPLETE message.

The *Mobile Time Difference* information element is coded as shown in figure 10.39a/GSM 04.08 and table 10.41a/GSM 04.08.

The *Mobile Time Difference* information element is a type 4 information element with 5 octets length.

	8	7	6	5	4	3	2	1	
	Mobile Time Difference IEI								Octet 1
	Length of Mobile Time difference contents								Octet 2
	Mobile Time Difference value (high)								Octet 3
	Mobile Time Difference value (continued)								Octet 4
	Mobile Time Difference value (low)				0	0	0	Octet 5	
					spare	spare	spare		

**Figure 10.39a/GSM 04.08:**  
***Mobile Time Difference* information element**

Mobile Time Difference value (octet 3, 4 and 5)  
 The coding of the Mobile Time Difference value field is the binary representation of the time difference in half bit periods and modulo  $2^{21}$  half bit periods;  
 $1/2$  bit period =  $24/13 \mu\text{s}$ .

**Table 10.41a/GSM 04.08:**  
***Mobile Time Difference* information element**

**10.5.2.22 Neighbour Cells Description**

The purpose of the *Neighbour Cells Description* information element is to provide the absolute radio frequency channel numbers of the BCCH carriers to be monitored by the mobile stations in the cell.

The *Neighbour Cells Description* information element is coded as the *Cell Channel Description* information element, as specified in section 10.5.2.1b, with the exception of bits 5 and 6 of octet 2. Figure 10.40/ GSM 04.08 and table 10.42/GSM 04.08 contains the difference of specifications.

The *Neighbour Cells Description* information element is a type 3 information element with 17 octets length.

8	7	6	5	4	3	2	1	
Neighbour Cells Description IEI								octet 1
Bit 128	Bit 127	EXT- IND	BA- IND	Bit 124	Bit 123	Bit 122	Bit 121	octet 2
Bit 120	Bit 119	Bit 118	Bit 117	Bit 116	Bit 115	Bit 114	Bit 113	octet 3
Bit 008	Bit 007	Bit 006	Bit 005	Bit 004	Bit 003	Bit 002	Bit 001	octet 17

**Figure 10.40/GSM 04.08:  
 Neighbour Cells Description information element**

EXT-IND, Extension indication (octet 2, bit 6)

If received in System Information 2, 2bis, 5 or 5bis this bit indicates whether the information element carries the complete information of a BCCH channel sub list or whether a complementary information element is sent in another message.

A GSM 900 mobile station which only supports the primary GSM band P-GSM 900 (cf. TS GSM 05.05) may consider this bit as a spare bit and assume that the information element carries the complete BA, see section 3.2.2.1.

If received in System Information 2ter or 5ter this bit shall be considered spare.

NOTE: This indicator is set to 1 in the neighbour cells description information elements in System Information 2 and 2bis and 5 and 5bis respectively when more than one is needed to describe a BCCH channel sub list.

Bit 6

- 0 The information element carries the complete BA
- 1 The information element carries only a part of the BA

BA-IND, BCCH allocation sequence number indication (octet 2). Range 0 to 1.

The BA-IND is needed to allow the network to discriminate measurements results related to different BAs sent to the MS.

**Table 10.42/GSM 04.08:**  
***Neighbour Cells Description* information element**

**10.5.2.23 P1 Rest Octets**

The *P1 Rest Octets* information element contains only spare bits only. Its purpose is to allow the upward compatible introduction of new information on the PCH in later phases.

The *P1 Rest Octets* information element is a type 5 information element with 1-18 octets length.

8	7	6	5	4	3	2	1	
P1 Rest Octets IEI								octet 1
0 spare	0 spare	1 spare	0 spare	1 spare	0 spare	1 spare	1 spare	octet 2
0 spare	0 spare	1 spare	0 spare	1 spare	0 spare	1 spare	1 spare	octet 3
.	.	.	.	.	.	.	.	
0 spare	0 spare	1 spare	0 spare	1 spare	0 spare	1 spare	1 spare	octet n

**Figure 10.41/GSM 04.08:  
*P1 Rest Octets* information element**

**10.5.2.24 P2 Rest Octets**

The *P2 Rest Octets* information element contains information on the channel needed by the network and spare bits. The purpose of the spare bits is to allow the upward compatible introduction of new information on the PCH in later phases.

The *P2 Rest Octets* information element is a type 5 information element with 2-12 octets length.

8	7	6	5	4	3	2	1	
P2 Rest Octets IEI								octet 1
CNI	CN3		0 spare	1 spare	0 spare	1 spare	1 spare	octet 2
0 spare	0 spare	1 spare	0 spare	1 spare	0 spare	1 spare	1 spare	octet 3*
...								
0 spare	0 spare	1 spare	0 spare	1 spare	0 spare	1 spare	1 spare	octet n*

**Figure 10.42/GSM 04.08:  
 P2 Rest Octets information element**

CNI	Channel Needed Indication (octet 2)
Bit 8	
0	No indication is given. The default value to be assumed for CN3 is 00 (any channel).
1	An indication is given in the CN3 field.
CN3	Channel Needed for Mobile Identity 3
Bits 7 6	(octet 2)
The values and semantics used in the CN3 field are those of the CHANNEL field of Channel Needed IE (see 10.5.2.8).	
The CN3 field is associated with the Mobile Identity 3 IE of the PAGING REQUEST TYPE 2 message.	

**Table 10.43/GSM 04.08:  
 P2 Rest Octets information element**

**10.5.2.25 P3 Rest Octets**

The *P3 Rest Octets* information element contains information on the channel needed by the network and spare bits. The purpose of the spare bits is to allow the upward compatible introduction of new information on the PCH in later phases.

The *P3 Rest Octets* information element is a type 5 information element with 4 octets length.

8	7	6	5	4	3	2	1	
P3 Rest Octets IEI								octet 1
CNI	CN3		CN4		0 spare	1 spare	1 spare	octet 2
0 spare	0 spare	1 spare	0 spare	1 spare	0 spare	1 spare	1 spare	octet 3
0 spare	0 spare	1 spare	0 spare	1 spare	0 spare	1 spare	1 spare	octet 4

**Figure 10.43/GSM 04.08:  
*P3 Rest Octets* information element**

CNI	Channel Needed Indication (octet 2)
Bit 8	
0	No indication is given. The default value to be assumed for CN3 and CN4 is 00 (any channel).
1	An indication is given in CN3 and CN4 fields.
CN3	Channel Needed for Mobile Identity 3
Bits 7 6	(octet 2) (see note)
The CN3 field is associated with the Mobile Identity 3 IE of the PAGING REQUEST TYPE 3 message.	
CN4	Channel Needed for Mobile Identity 4
Bits 5 4	(octet 2) (see note)
The CN4 field is associated with the Mobile Identity 4 IE of the PAGING REQUEST TYPE 3 message.	
NOTE:	The values and semantics used in the CN3 and CN4 fields are those of the CHANNEL field of Channel Needed IE (see 10.5.2.8).

**Table 10.44/GSM 04.08:  
*P3 Rest Octets* information element**



**10.5.2.26 Page Mode**

The purpose of the *Page Mode* information element is to control the action of the mobile station belonging to the paging subgroup corresponding to the paging subchannel.

The *Page Mode* information element is coded as shown in figure 10.44/GSM 04.08 and table 10.45/GSM 04.08.

The *Page Mode* is a type 1 information element.

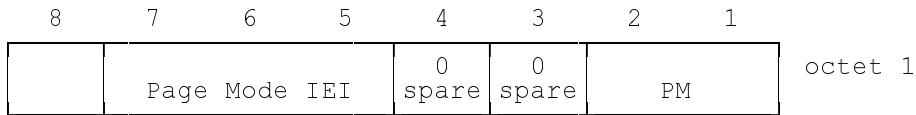

**Figure 10.44/GSM 04.08:  
 Page Mode information element**

PM (octet 1)	
Bits	
2 1	
0 0	Normal paging.
0 1	Extended paging.
1 0	Paging reorganization.
1 1	Same as before.
Note: The value "same as before" has been defined instead of "reserved" to allow the use of this coding with another meaning in an upwards compatible way in later phases of the GSM system.	

**Table 10.45/GSM 04.08:  
 Page Mode information element**

**10.5.2.27 NCC Permitted**

The purpose of the *NCC Permitted* information element is to provide a definition of the allowed NCCs on the BCCH carriers to be reported in the MEASUREMENT REPORT message by the mobile stations in the cell.

The *NCC Permitted* information element is coded as shown in figure 10.45/GSM 04.08 and table 10.46/GSM 04.08.

The *NCC Permitted* is a type 3 information element with 2 octets length.

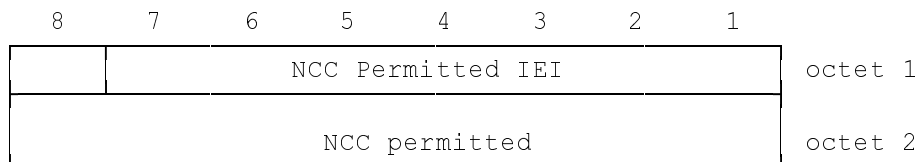

**Figure 10.45/GSM 04.08:  
*NCC Permitted* information element**

NCC permitted (octet 2) The NCC permitted field is coded as a bit map, i.e. bit N is coded with a "0" if the BCCH carrier with NCC = N-1 is not permitted for monitoring and with a "1" if the BCCH carrier with NCC = N-1 is permitted for monitoring; N = 1,2,...,8.
---

**Table 10.46/GSM 04.08:  
*NCC Permitted* information element**

**10.5.2.28 Power Command**

The purpose of the *Power Command* information element is to provide the power level to be used by the mobile station.

The *Power Command* information element is coded as shown in figure 10.46/GSM 04.08 and table 10.47/GSM 04.08.

The *Power Command* is a type 3 information element with 2 octets length.

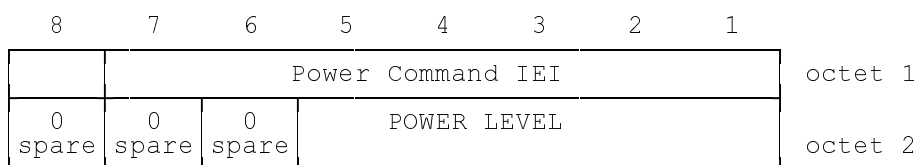

**Figure 10.46/GSM 04.08:  
Power Command information element**

<p>Power level (octet 2)  The power level field is coded as the binary representation of the "power control level", see GSM 05.05.  This value shall be used by the mobile station according to GSM 05.08.  Range: 0 to 31.</p>
---

**Table 10.47/GSM 04.08:  
Power Command information element**

**10.5.2.28a Power Command and access type**

The purpose of the *Power Command and access type* information element is to provide the power level to be used by the mobile station and the indication that the mobile station can avoid the transmission of handover access.

The *Power Command and access type* information element is coded as shown in figure 10.46a/GSM 04.08 and table 10.47a/GSM 04.08.

The *Power Command and access type* is a type 3 information element with 2 octets length.

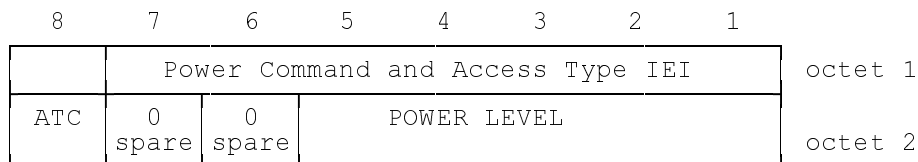

**Figure 10.46a/GSM 04.08:  
 Power Command and access type information element**

ATC (Access Type Control) (octet 2) bit 8 0 Sending of Handover access is mandatory 1 Sending of Handover access is optional  Power level (octet 2) The power level field is coded as the binary representation of the "power control level", see GSM 05.05. This value shall be used by the mobile station according to GSM 05.08.  Range: 0 to 31.
---

**Table 10.47a/GSM 04.08:  
 Power Command and access type information element**

**10.5.2.29 RACH Control Parameters**

The purpose of the *RACH Control Parameters* information element is to provide parameters used to control the RACH utilization. This information element is broadcast to mobile stations in SYSTEM INFORMATION TYPE 1, 2, 2bis, 3, and 4 messages.

The *RACH Control Parameters* information element is coded as shown in figure 10.47/GSM 04.08 and table 10.48/GSM 04.08.

The *RACH Control Parameters* is a type 3 information element with 4 octets length.

8	7	6	5	4	3	2	1	
RACH Control Parameters IEI								octet 1
Max retrans		Tx-integer				CELL BARR ACCESS	RE	octet 2
AC C15	AC C14	AC C13	AC C12	AC C11	EC C10	AC C09	AC C08	octet 3
AC C07	AC C06	AC C05	AC C04	AC C03	AC C02	AC C01	AC C00	octet 4

**Figure 10.47/GSM 04.08:**  
***RACH Control Parameters* information element**

Max retrans, Maximum number of retransmissions (octet 2)				
Bits				
8	7			
0	0	Maximum 1 retransmission		
0	1	Maximum 2 retransmissions		
1	0	Maximum 4 retransmissions		
1	1	Maximum 7 retransmissions		
Tx-integer, Number of slots to spread transmission (octet 2)				
Bits				
6	5	4	3	
0	0	0	0	3 slots used to spread transmission
0	0	0	1	4 slots used to spread transmission
0	0	1	0	5 slots used to spread transmission
0	0	1	1	6 slots used to spread transmission
0	1	0	0	7 slots used to spread transmission
0	1	0	1	8 slots used to spread transmission
0	1	1	0	9 slots used to spread transmission
0	1	1	1	10 slots used to spread transmission
1	0	0	0	11 slots used to spread transmission
1	0	0	1	12 slots used to spread transmission
1	0	1	0	14 slots used to spread transmission
1	0	1	1	16 slots used to spread transmission
1	1	0	0	20 slots used to spread transmission
1	1	0	1	25 slots used to spread transmission
1	1	1	0	32 slots used to spread transmission
1	1	1	1	50 slots used to spread transmission

**Table 10.48/GSM 04.08:**  
**RACH Control Parameters information element**

CELL_BAR_ACCESS, Cell Barred for Access (octet 2)
Bit
2
0 The cell is not barred, see GSM 03.22
1 The cell is barred, see GSM 03.22
RE, Call reestablishment allowed (octet 2)
Bit
1
0 Call Reestablishment allowed in the cell
1 Call Reestablishment not allowed in the cell
EC Emergency Call allowed (octet 3 bit 3)
3
0 Emergency call allowed in the cell to all MSs
1 Emergency call not allowed in the cell except for the MSs that belong to one of the classes between 11 to 15
AC CN, Access Control Class N (octet 3(except bit 3) and octet 4)
For a mobile station with AC C = N access is not barred if the AC CN bit is coded with a "0"; N = 0, 1, .. 9,11, .., 15.

**Table 10.48/GSM 04.08:**  
***RACH Control Parameters* information element (continued)**

**10.5.2.30 Request Reference**

The purpose of the *Request Reference* information element is to provide the random access information used in the channel request and the frame number, FN modulo 42432 in which the channel request was received.

The *Request Reference* information element is coded as shown in figure 10.48/GSM 04.08 and table 10.49/GSM 04.08.

The *Request Reference* is a type 3 information element with 4 octets length.

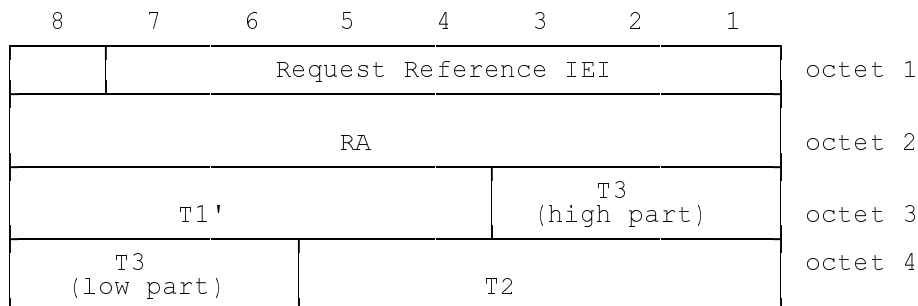

**Figure 10.48/GSM 04.08:  
 Request Reference information element**

<p>RA, Random Access Information (octet 2)                  The RA field is as shown in table 9.9, section 9.1.8</p> <p>T1' (octet 2)                  The T1' field is coded as the binary representation of (FN div 1326) mod 32.</p> <p>T3 (octet 3 and 4)                  The T3 field is coded as the binary representation of FN mod 51. Bit 3 of octet 2 is the most significant bit and bit 6 of octet 3 is the least significant bit.</p> <p>T2 (octet 4)                  The T2 field is coded as the binary representation of FN mod 26.</p> <p>NOTE 1: The frame number, FN modulo 42432 can be calculated as <math>51x((T3-T2) \text{ mod } 26)+T3+51x26xT1'</math></p>
--

**Table 10.49/GSM 04.08:  
 Request Reference information element**



**10.5.2.31 RR Cause**

The purpose of the *RR Cause* information element is to provide the reason for release or the reason for completion of an assignment or handover.

The *RR Cause* information element is coded as shown in figure 10.49/GSM 04.08 and table 10.50/GSM 04.08.

The *RR Cause* is a type 3 information element with 2 octets length.

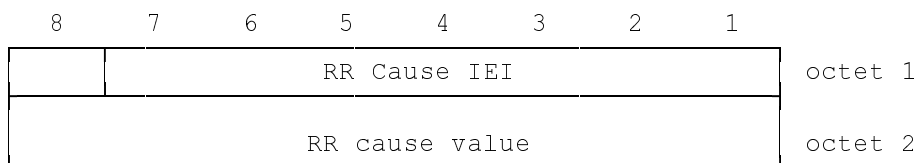

**Figure 10.49/GSM 04.08:**  
***RR Cause* information element**

RR cause value (octet 2)								
Bits								
8	7	6	5	4	3	2	1	
0	0	0	0	0	0	0	0	Normal event
0	0	0	0	0	0	0	1	Abnormal release, unspecified
0	0	0	0	0	0	1	0	Abnormal release, channel unacceptable
0	0	0	0	0	0	1	1	Abnormal release, timer expired
0	0	0	0	0	1	0	0	Abnormal release, no activity on the radio path
0	0	0	0	0	1	0	1	Preemptive release
0	0	0	0	1	0	0	0	Handover impossible, timing advance out of range
0	0	0	0	1	0	0	1	Channel mode unacceptable
0	0	0	0	1	0	1	0	Frequency not implemented
0	1	0	0	0	0	0	1	Call already cleared
0	1	0	1	1	1	1	1	Semantically incorrect message
0	1	1	0	0	0	0	0	Invalid mandatory information
0	1	1	0	0	0	0	1	Message type non-existent or not implemented
0	1	1	0	0	0	1	0	Message type not compatible with protocol state
0	1	1	0	0	1	0	0	Conditional IE error
0	1	1	0	0	1	0	1	No cell allocation available
0	1	1	0	1	1	1	1	Protocol error unspecified
All other cause values shall be treated as 0000 0000, "normal event"								
The listed RR cause values are defined in annex F.								

**Table 10.50/GSM 04.08:  
RR Cause information element**

**10.5.2.32 SI 1 Rest Octets**

The *SI 1 Rest Octets* information element contains only spare bits. Its purpose is to allow the upward compatible introduction of new information on the BCCH in later phases.

The *SI 1 Rest Octets* information element is a type 5 information element with 2 octets length.

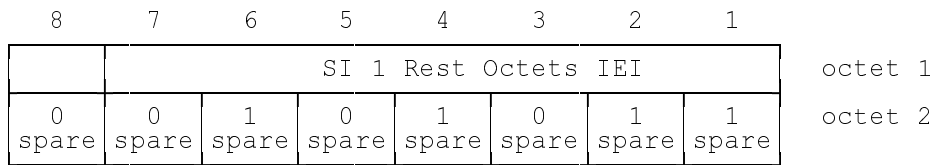
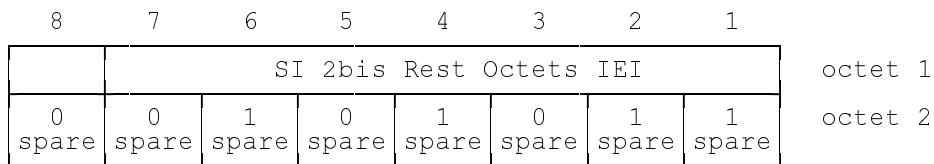

**Figure 10.50/GSM 04.08:  
 SI 1 Rest Octets information element**

**10.5.2.33 SI 2bis Rest Octets**

The *SI 2bis Rest Octets* information element contains only spare bits. Its purpose is to allow the upward compatible introduction of new information on the BCCH in later phases.

The *SI 2bis Rest Octets* information element is a type 5 information element with 2 octets length.



**Figure 10.51/GSM 04.08:  
 SI 2bis Rest Octets information element**

10.5.2.33a SI 2ter Rest Octets

The *SI 2ter Rest Octets* information element contains only spare bits. Its purpose is to allow the upward compatible introduction of new information on the BCCH in later phases.

The *SI 2ter Rest Octets* information element is a type 5 information element with 5 octets length.

8	7	6	5	4	3	2	1	
SI 2ter Rest Octets IEI								octet 1
0 spare	0 spare	1 spare	0 spare	1 spare	0 spare	1 spare	1 spare	octet 2
0 spare	0 spare	1 spare	0 spare	1 spare	0 spare	1 spare	1 spare	octet 3
0 spare	0 spare	1 spare	0 spare	1 spare	0 spare	1 spare	1 spare	octet 4
0 spare	0 spare	1 spare	0 spare	1 spare	0 spare	1 spare	1 spare	octet 5

**Figure 10.51a/GSM 04.08:**  
***SI 2ter Rest Octets* information element**

**10.5.2.34 SI 3 Rest Octets**

The *SI 3 Rest Octets* information element is coded according to the syntax specified in figures 10.52 d-k/GSM 04.08 and described in tables 10.51a-c/GSM 04.08 and 10.52a-b/GSM 04.08 (see section 10.5.2.35).

The *SI 3 Rest Octets* information element is a type 5 information element with 5 octets length.

```
<SI3 rest octet> ::= <Optional selection parameter>
                    <Optional Power offset>
                    <System Information 2ter Indicator>
                    <Early Classmark Sending Control>
                    <Spare padding>
```

```
<Optional Selection Parameter> ::= H <Selection Parameter> | L
```

```
<Selection Parameter> ::= <CBQ> <CELL_RESELECT_OFFSET>
                        <TEMPORARY_OFFSET> <PENALTY_TIME>
```

```
<Optional Power Offset> ::= H <Power Offset> | L
```

```
<System Information 2ter Indicator> ::= H | L
```

```
<Early Classmark Sending Control> ::= H | L
```

	8	7	6	5	4	3	2	1		
	SI 3 Rest Octets IEI								octet 1	
1	PI	CBQ	CELL_RESELECT_OFFSET							octet 2
TEMPORARY_OFFSET			PENALTY_TIME							octet 3
1	POI	POWER OFFSET	0 2TI	1 ECSC	0 spare	1 spare	1 spare		octet 4	
0	spare	0 spare	1 spare	0 spare	1 spare	0 spare	1 spare	1 spare	octet 5	
⋮										
⋮										
0	spare	0 spare	1 spare	0 spare	1 spare	0 spare	1 spare	1 spare	octet n	

**Figure 10.52d/GSM 04.08:**  
*SI 3 Rest Octets* information element for PI=H & POI=H & 2TI=L & ECSC=L

8	7	6	5	4	3	2	1	
SI 3 Rest Octets IEI								octet 1
1								octet 2
PI	CBQ	CELL_RESELECT_OFFSET						
TEMPORARY_OFFSET			PENALTY_TIME					octet 3
0	0	1	0	1	0	1	1	octet 4
POI	2TI	ECSC	spare	spare	spare	spare	spare	
0	0	1	0	1	0	1	1	octet 5
spare	spare	spare	spare	spare	spare	spare	spare	
...								
0	0	1	0	1	0	1	1	octet n
spare	spare	spare	spare	spare	spare	spare	spare	

**Figure 10.52e/GSM 04.08:**  
**SI 3 Rest Octets information element for PI=H & POI=L & 2TI=L & ECSC=L**

8	7	6	5	4	3	2	1	
SI 3 Rest Octets IEI								octet 1
0 PI	1 POI	POWER OFFSET		0 2TI	0 ECSC	1 spare	1 spare	octet 2
0 spare	0 spare	1 spare	0 spare	1 spare	0 spare	1 spare	1 spare	octet 3
.								.
.								.
0 spare	0 spare	1 spare	0 spare	1 spare	0 spare	1 spare	1 spare	octet n

**Figure 10.52f/GSM 04.08:**  
**SI 3 Rest Octets information element for PI=L & POI=H & 2TI=H & ECSC=L**

8	7	6	5	4	3	2	1	
SI 3 Rest Octets IEI								octet 1
0 PI	0 POI	0 2TI	0 ECSC	1 spare	0 spare	1 spare	1 spare	octet 2
0 spare	0 spare	1 spare	0 spare	1 spare	0 spare	1 spare	1 spare	octet 3
.								.
.								.
0 spare	0 spare	1 spare	0 spare	1 spare	0 spare	1 spare	1 spare	octet n

**Figure 10.52g/GSM 04.08:**  
**SI 3 Rest Octets information element for PI=L & POI=L & 2TI=H & ECSC=L**

	SI 3 Rest Octets IEI								octet 1	
1										
PI	CBQ	CELL_RESELECT_OFFSET								octet 2
TEMPORARY_OFFSET			PENALTY_TIME							octet 3
1	POWER_OFFSET		1	1	0	1	1			
POI			2TI	ECSC	spare	spare	spare		octet 4	
0	0	1	0	1	0	1	1			
spare	spare	spare	spare	spare	spare	spare	spare		octet 5	
.										
.										
0	0	1	0	1	0	1	1			
spare	spare	spare	spare	spare	spare	spare	spare		octet n	

Figure 10.52h/GSM 04.08:

SI 3 Rest Octets information element for PI=H & POI=H & 2TI=H & ECSC=L



8	7	6	5	4	3	2	1	
SI 3 Rest Octets IEI								octet 1
1 PI	CBQ	CELL_RESELECT_OFFSET						octet 2
TEMPORARY_OFFSET			PENALTY_TIME					octet 3
0 POI	1 2TI	1 ECSC	0 spare	1 spare	0 spare	1 spare	1 spare	octet 4
0 spare	0 spare	1 spare	0 spare	1 spare	0 spare	1 spare	1 spare	octet 5
.								.
0 spare	0 spare	1 spare	0 spare	1 spare	0 spare	1 spare	1 spare	octet n

**Figure 10.52i/GSM 04.08:**  
**SI 3 Rest Octets information element for PI=H & POI=L & 2TI=H & ECSC=L**

	8	7	6	5	4	3	2	1	
	SI 3 Rest Octets IEI								octet 1
0	1	POWER OFFSET		1	0	1	1		octet 2
PI	POI			2TI	ECSC	spare	spare		
0	0	1	0	1	0	1	1		octet 3
spare	spare	spare	spare	spare	spare	spare	spare		
⋮									
0	0	1	0	1	0	1	1		octet n
spare	spare	spare	spare	spare	spare	spare	spare		

**Figure 10.52j/GSM 04.08:**  
*SI 3 Rest Octets* information element for PI=L & POI=H & 2TI=L & ECSC=L

	8	7	6	5	4	3	2	1	
	SI 3 Rest Octets IEI								octet 1
0	0	1	0	1	0	1	1		octet 2
PI	POI	2TI	ECSC	spare	spare	spare	spare		
0	0	1	0	1	0	1	1		octet 3
spare	spare	spare	spare	spare	spare	spare	spare		
⋮									
0	0	1	0	1	0	1	1		octet n
spare	spare	spare	spare	spare	spare	spare	spare		

**Figure 10.52k/GSM 04.08:**  
*SI 3 Rest Octets* information element for PI=L & POI=L & 2TI=L & ECSC=L

**10.5.2.35 SI 4 Rest Octets**

The *SI 4 Rest Octets* information element includes parameters which are used by the mobile station for cell reselection purposes. It may also include the POWER OFFSET parameter used by DCS 1 800 Class 3 MS.

The meanings of the parameters in octets 2 and higher are determined by the values of PI & POI as indicated in figures 10.53 / GSM 04.08 and 10.54a-c / GSM 04.08 and described in tables 10.51a-c/ GSM 04.08 and 10.52a-b/GSM 04.08.

The *SI 4 Rest Octets* information element is a type 5 information element with 1 to 11 octets length.

	8	7	6	5	4	3	2	1		
	SI X Rest Octets IEI								octet 1	
1	PI	CBQ	CELL_RESELECT_OFFSET							octet 2
TEMPORARY_OFFSET			PENALTY_TIME							octet 3
1	POI	POWER OFFSET	0 spare	1 spare	0 spare	1 spare	1 spare		octet 4	
0	spare	0 spare	1 spare	0 spare	1 spare	0 spare	1 spare	1 spare	octet 5	
⋮										
⋮										
0	spare	0 spare	1 spare	0 spare	1 spare	0 spare	1 spare	1 spare	octet n	

**Figure 10.53/GSM 04.08:**  
**SI X Rest Octets information element (X = 4, 7, or 8), for PI=1 & POI=1**

8	7	6	5	4	3	2	1	
SI X Rest Octets IEI								octet 1
1								octet 2
PI	CBQ	CELL_RESELECT_OFFSET						
TEMPORARY_OFFSET			PENALTY_TIME					octet 3
0	0	1	0	1	0	1	1	octet 4
POI	spare	spare	spare	spare	spare	spare	spare	
0	0	1	0	1	0	1	1	octet 5
spare	spare	spare	spare	spare	spare	spare	spare	
...								
0	0	1	0	1	0	1	1	octet n
spare	spare	spare	spare	spare	spare	spare	spare	

**Figure 10.54a/GSM 04.08:**  
*SI X Rest Octets* information element (X = 4, 7, or 8), for PI=1 & POI=0

	8	7	6	5	4	3	2	1	
	SI X Rest Octets IEI								octet 1
0	1	POWER OFFSET		1	0	1	1		octet 2
PI	POI	spare	spare	spare	spare	spare	spare		
0	0	1	0	1	0	1	1		octet 3
spare	spare	spare	spare	spare	spare	spare	spare		
⋮									
0	0	1	0	1	0	1	1		octet n
spare	spare	spare	spare	spare	spare	spare	spare		

**Figure 10.54b/GSM 04.08:**  
*SI X Rest Octets* information element ( $X = 4, 7, \text{ or } 8$ ), for  $PI=0$  &  $POI=1$

	8	7	6	5	4	3	2	1	
	SI X Rest Octets IEI								octet 1
0	0	1	0	1	0	1	1		octet 2
PI	POI	spare	spare	spare	spare	spare	spare		
0	0	1	0	1	0	1	1		octet 3
spare	spare	spare	spare	spare	spare	spare	spare		
⋮									
0	0	1	0	1	0	1	1		octet n
spare	spare	spare	spare	spare	spare	spare	spare		

**Figure 10.54c/GSM 04.08:**  
*SI X Rest Octets* information element ( $X = 4, 7, \text{ or } 8$ ), for  $PI=0$  &  $POI=0$

For PI=1 and POI=0 table 10.51a/GSM 04.08 applies.

PI, CELL\_RESELECT\_PARAM\_IND (1 bit field)

PI Value

L C2 Parameters not present

H C2 Parameters present

PI is used by the mobile station to determine if the C2 parameters which are, CBQ, CELL\_RESELECT\_OFFSET, TEMPORARY\_OFFSET and PENALTY\_TIME are being broadcast by the network in this message.

POI Value (1 bit field)

L POWER OFFSET Parameter not present

H POWER OFFSET Parameter present

POI is used to indicate the presence or otherwise of the POWER OFFSET parameter in this message.

CBQ, CELL\_BAR\_QUALIFY (1 bit field)

CELL\_BAR\_QUALIFY is used by the network to control mobile station cell selection and reselection. The use and coding of this parameter is defined in GSM 05.08.

CELL\_RESELECT\_OFFSET (6 bit field)

CELL\_RESELECT\_OFFSET is coded as the binary representation of the "CELL\_RESELECT\_OFFSET" in GSM 05.08. It is a value used by the mobile station to apply a positive or negative offset to the value of C2 as defined in GSM 03.22 and GSM 05.08.

TEMPORARY\_OFFSET (3 bit field)

The TEMPORARY\_OFFSET field is coded as the binary representation of the "TEMPORARY\_OFFSET" in GSM 05.08. It is used by the mobile station as part of its calculation of C2 for the cell reselection process as described in GSM 05.08. It is used to apply a negative offset to C2 for the duration of PENALTY\_TIME.

PENALTY\_TIME (5 bit field)

The PENALTY\_TIME is coded as the binary representation of the "PENALTY\_TIME" in GSM 05.08. It defines the length of time for which TEMPORARY\_OFFSET is active. The usage of PENALTY\_TIME is described in GSM 03.22 and GSM 05.08.

**Table 10.51a/GSM 04.08**

For PI=1 and POI=1 table 10.51b-c/GSM 04.08 applies

CBQ, CELL\_BAR\_QUALIFY (1 bit field)

CELL\_BAR\_QUALIFY is used by the network to control mobile station cell selection and reselection. The use and coding of this parameter is defined in GSM 05.08.

CELL\_RESELECT\_OFFSET (6 bit field)

CELL\_RESELECT\_OFFSET is coded as the binary representation of the "CELL\_RESELECT\_OFFSET" in GSM 05.08. It is a value used by the mobile station to apply a positive or negative offset to the value of C2 as defined in GSM 03.22 and GSM 05.08.

TEMPORARY\_OFFSET (3 bit field)

The TEMPORARY\_OFFSET field is coded as the binary representation of the "TEMPORARY\_OFFSET" in GSM 05.08. It is used by the mobile station as part of its calculation of C2 for the cell reselection process as described in GSM 05.08. It is used to apply a negative offset to C2 for the duration of PENALTY\_TIME.

PENALTY\_TIME (5 bit field)

The PENALTY\_TIME is coded as the binary representation of the "PENALTY\_TIME" in GSM 05.08. It defines the length of time for which TEMPORARY\_OFFSET is active. The usage of PENALTY\_TIME is described in GSM 03.22 and GSM 05.08.

**Table 10.51b/GSM 04.08**

POWER OFFSET (2 bit field)

POWER OFFSET is used only by DCS 1 800 Class 3 Mobile Stations to add a power offset to the value of MS\_TXPWR\_MAX\_CCH used for its random access attempts. It is also used by the MS in its calculation of C1 and C2 parameters. Its use is defined in GSM 05.08

If this parameter is transmitted on a BCCH carrier within the DCS 1 800 band, its meaning shall be described below:

Value	Meaning
00	0 dB power offset
01	2 dB power offset
10	4 dB power offset
11	6 dB power offset

If this parameter is transmitted on a BCCH carrier outside the DCS 1 800 band, then all bit positions shall be treated as spare.

2TI, SI 2TER INDICATOR (1 bit field)

2TI	value
L	System Information 2ter is not available
H	System Information 2ter is available

2TI is used by the mobile station to determine if System Information 2ter is being broadcast by the network.

This bit is meaningful only if received in System Information type 3 message. If it is received in any other message it shall be considered spare.

ECSC, Early Classmark Sending Control (1 bit field)

This bit controls the early sending of the classmark by the Mobile Stations implementing the «Controlled Early Classmark Sending» option:

H	Early Sending is explicitly accepted
L	Early Sending is explicitly forbidden

Table 10.51c/GSM 04.08



For PI=0 and POI=1 table 10.52a/GSM 04.08 applies.

PI, CELL_RESELECT_PARAM_IND (octet 2)	
PI Value	
0	C2 Parameters not present
1	C2 Parameters present
PI is used by the mobile station to determine if the C2 parameters which are, CBQ, CELL_RESELECT_OFFSET, TEMPORARY_OFFSET and PENALTY_TIME are being broadcasted by the network in this message.	
POI Value	
0	POWER OFFSET Parameter not present
1	POWER OFFSET Parameter present
POI is used to indicate the presence or otherwise of the POWER OFFSET parameter in this message.	
POWER OFFSET	
POWER OFFSET is used only by DCS 1 800 Class 3 Mobile Stations to add a power offset to the value of MS_TXPWR_MAX_CCH used for its random access attempts. It is also used by the MS in its calculation of C1 and C2 parameters. Its use is defined in GSM 05.08	
If this parameter is transmitted on a BCCH carrier within the DCS 1 800 band, its meaning shall be described below:	
Value	Meaning
00	0 dB power offset
01	2 dB power offset
10	4 dB power offset
11	6 dB power offset
If this parameter is transmitted on a BCCH carrier outside the DCS 1 800 band, then all bit positions shall be treated as spare.	

**Table 10.52a/GSM 04.08**

For PI=0 and POI=0 table 10.52b/GSM 04.08 applies.

PI, CELL\_RESELECT\_PARAM\_IND (octet 2)

PI Value

- 0 C2 Parameters not present
- 1 C2 Parameters present

PI is used by the mobile station to determine if the C2 parameters which are, CBQ, CELL\_RESELECT\_OFFSET, TEMPORARY\_OFFSET and PENALTY\_TIME are being broadcasted by the network in this message.

POI Value

- 0 POWER OFFSET Parameter not present
- 1 POWER OFFSET Parameter present

POI is used to indicate the presence or otherwise of the POWER OFFSET parameter in this message.

**Table 10.52b/GSM 04.08**

**10.5.2.36 SI 7 Rest Octets**

The *SI 7 Rest Octets* information element includes parameters which are used by the mobile station for cell reselection purposes. It may also include the POWER OFFSET parameter used by a DCS 1 800 Class 3 MS.

The meanings of the parameters in octets 2 and higher are determined by the values of PI & POI as indicated in figures 10.53 / GSM 04.08 and 10.54a-c / GSM 04.08 and described in tables 10.51a-c/ GSM 04.08 and 10.52a-b/GSM 04.08 (see section 10.5.2.35).

The *SI 7 Rest Octets* information element is a type 5 information element with 1 to 21 octets length.

**10.5.2.37 SI 8 Rest Octets**

The *SI 8 Rest Octets* information element includes parameters which are used by the mobile station for cell reselection purposes. It may also include the POWER OFFSET parameter used by a DCS 1 800 Class 3 MS.

The meanings of the parameters in octets 2 and higher are determined by the values of PI & POI as indicated in figures 10.53 / GSM 04.08 and 10.54a-c / GSM 04.08 and described in tables 10.51a-c/ GSM 04.08 and 10.52a-b/GSM 04.08 (see section 10.5.2.35).

The *SI 8 Rest Octets* information element is a type 5 information element with 1 to 21 octets length.

**10.5.2.38 Starting Time**

The purpose of the *Starting Time* information element is to provide the start TDMA frame number, FN modulo 42432.

The *Starting Time* information element is coded as shown in figure 10.55/GSM 04.08 and table 10.53/ GSM 04.08.

The *Starting Time* is a type 3 information element with 3 octets length.

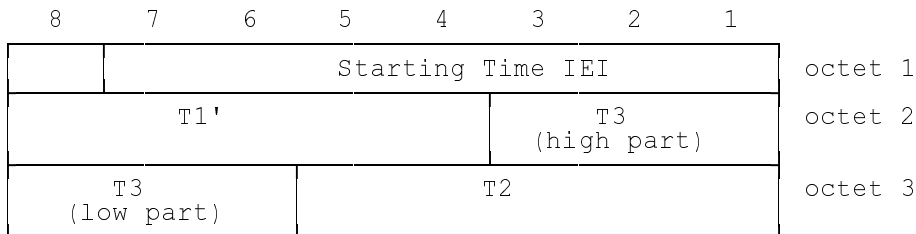

**Figure 10.55/GSM 04.08:  
 Starting Time information element**

T1' (octet 2)  
 The T1' field is coded as the binary representation of  $(FN \text{ div } 1326) \text{ mod } 32$ .

T3 (octet 2 and 3)  
 The T3 field is coded as the binary representation of  $FN \text{ mod } 51$ . Bit 3 of octet 2 is the most significant bit and bit 6 of octet 3 is the least significant bit.

T2 (octet 3)  
 The T2 field is coded as the binary representation of  $FN \text{ mod } 26$ .

NOTE 1: The frame number, FN modulo 42432 can be calculated as  $51x((T3-T2) \text{ mod } 26)+T3+51x26xT1'$

**Table 10.53/GSM 04.08:  
 Starting Time information element**

The starting time and the times mentioned above are with reference to the frame numbering in the concerned cell. They are given in units of frames (around 4.615 ms).

The *Starting Time* IE can encode only an interval of time of 42432 frames, that is to say around 195.8 seconds. To remove any ambiguity, the specification for a reception at time T is that the encoded interval is  $(T-10808, T+31623)$ . In rigorous terms, if we note ST the starting time:

If  $0 \leq (ST-T) \text{ mod } 42432 \leq 31623$ , the indicated time is the next time when  $FN \text{ mod } 42432$  is equal to ST.

If  $32024 \leq (ST-T) \text{ mod } 42432 \leq 42431$ , the indicated time has already elapsed.

The reception time T is not specified here precisely. To allow room for various Mobile Station implementations, the limit between the two behaviours above may be anywhere within the interval defined by:

$31624 \leq (ST-T) \text{ mod } 42432 \leq 32023$ .

### 10.5.2.39 Synchronization Indication

The purpose of *Synchronization Indication* information element is to indicate which type of handover is to be performed.

The *Synchronization Indication* information element is coded as shown in figure 10.56/GSM 04.08 and table 10.55/GSM 04.08.

The *Synchronization Indication* is a type 1 information element.

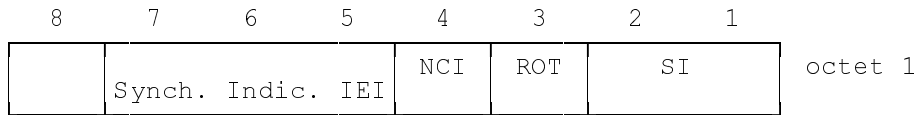

**Figure 10.56/GSM 04.08:**  
***Synchronization Indication* information element**

ROT: Report Observed Time Difference (Octet1 bit 3) 0 Mobile Time Difference IE shall not be included in the HANDOVER COMPLETE message  1 Mobile Time Difference IE shall be included in the HANDOVER COMPLETE message  SI: Synchronisation indication (octet 1) Bit 2 1 0 0 Non-synchronized 0 1 Synchronized 1 0 Pre-synchronised 1 1 Pseudo-synchronised  NCI: Normal cell indication (octet 1, bit 4) 0 Out of range timing advance is ignored 1 Out of range timing advance shall trigger a handover failure procedure
--

**Table 10.55/GSM 04.08:**  
***Synchronization Indication* information element**

**10.5.2.40 Timing Advance**

The purpose of the *Timing Advance* information element is to provide the timing advance value.

The *Timing Advance* information element is coded as shown in figure 10.57/GSM 04.08 and table 10.56/GSM 04.08

The *Timing Advance* is a type 3 information element with 2 octets length.

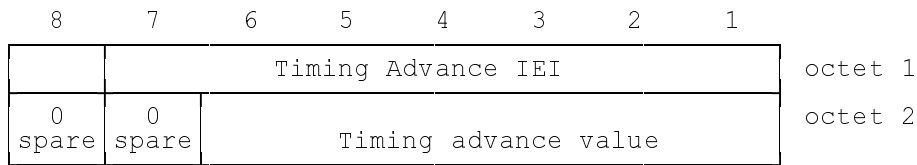

**Figure 10.57/GSM 04.08:  
 Timing Advance information element**

Timing advance value (octet 2) The coding of the timing advance value field is the binary representation of the timing advance in bit periods; 1 bit period = 48/13 μs.
--

**Table 10.56/GSM 04.08:  
 Timing Advance information element**

**10.5.2.41 Time Difference**

The purpose of the *Time Difference* information element is to provide information about the synchronization difference between the time bases of two Base Stations. This type of information element is used in relation with the pseudo-synchronization scheme (see GSM 05.10).

The *Time Difference* information element is coded as shown in figure 10.58/GSM 04.08 and table 10.57/GSM 04.08.

The *Time Difference* information element is a type 4 information element with 3 octets length.

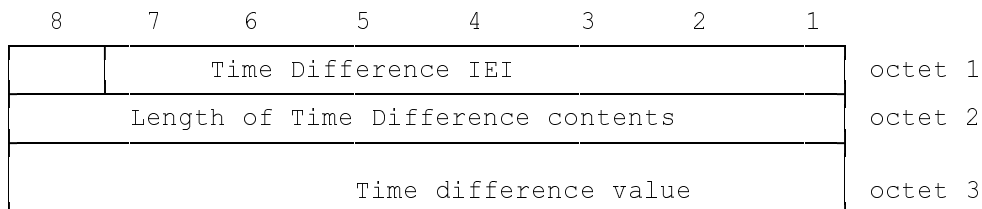

**Figure 10.58/GSM 04.08:**  
***Time Difference* information element**

Time Difference value (octet 3) The coding of the time difference value field is the binary representation of time difference in half bit periods, modulo 256 half bit periods; $1/2$ bit period = $24/13$ $\mu$ s.
---

**Table 10.57/GSM 04.08:**  
***Time Difference* information element**

10.5.2.42 TMSI

The purpose of the *TMSI* information element is to provide the Temporary Mobile Subscriber Identity for paging purposes.

The *TMSI* information element is coded as shown in figure 10.59/GSM 04.08 and table 10.58/GSM 04.08.

The *TMSI* is a type 3 information element with 5 octets length.

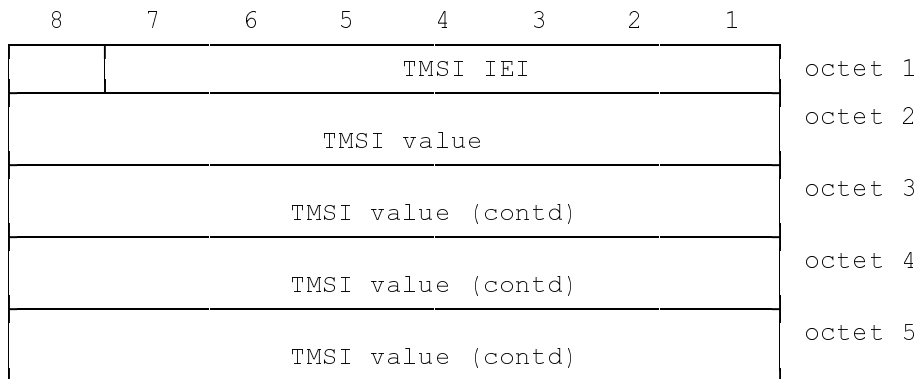

**Figure 10.59/GSM 04.08:**  
***TMSI* information element**



TMSI value (octet 2, 3, 4 and 5)  
Bit 8 of octet 2 is the most significant bit and bit  
1 of octet 5 is the least significant bit.

The coding of the TMSI is left open for each  
administration but its length is 4 octets.

NOTE: For purposes other than paging the TMSI should  
be provided using the mobile identity  
information element.

**Table 10.58/GSM 04.08:**  
***TMSI* information element**

### 10.5.2.43 Wait Indication

The purpose of the *Wait Indication* information element is to provide the time the mobile station shall wait before attempting another channel request.

The *Wait Indication* information element is coded as shown in figure 10.60/GSM 04.08 and table 10.59/GSM 04.08.

The *Wait Indication* is a type 3 information element with 2 octets length.

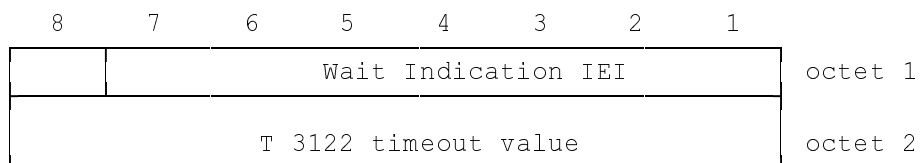

**Figure 10.60/GSM 04.08:**  
***Wait Indication* information element**

T3122 timeout value (octet 2) This field is coded as the binary representation of the T3122 timeout value in seconds.
--

**Table 10.59/GSM 04.08:**  
***Wait Indication* information element**

**10.5.2.44 Additional Multiband Information**

The purpose of the *Additional Multiband Information* information element is to specify the minimum number of cells, if available, to be reported by a multiband MS on each band.

The *Additional Multiband Information* information element is coded as shown in figure 10.61/GSM 04.08 and table 10.60/GSM 04.08.

The *Additional Multiband Information* is a type 1 information element.

8	7	6	5	4	3	2	1
Additional Multiband Information IEI				0	0	Multiband reporting	
				Spare			

**Figure 10.61/GSM 04.08:**  
***Additional Multiband Information* information element**

Multiband reporting (octet 1):

Binary coded minimum number of cells of each supported band to be included in MEASUREMENT REPORT message by a MS as specified in GSM 05.08.

Range: 0 to 3

**Table 10.60/GSM 04.08:**  
***Additional Multiband Information* information element**

**10.5.3 Mobility management information elements.**

**10.5.3.1 Authentication parameter RAND**

The purpose of the *Authentication Parameter RAND* information element is to provide the mobile station with a non-predictable number to be used to calculate the authentication response signature SRES and the ciphering key Kc.

The *Authentication Parameter RAND* information element is coded as shown in figure 10.61/GSM 04.08 and table 10.61/GSM 04.08.

The *Authentication Parameter RAND* is a type 3 information element with 17 octets length.

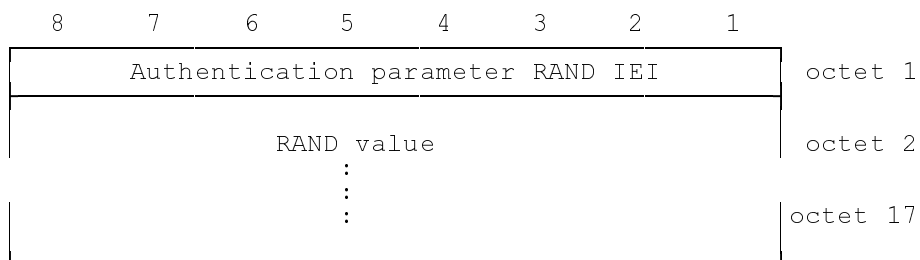

**Figure 10.61/GSM 04.08:**  
***Authentication Parameter RAND* information element**

RAND value (octet 2, 3,... and 17) The RAND value consists of 128 bits. Bit 8 of octet 2 is the most significant bit while bit 1 of octet 17 is the least significant bit.
---

**Table 10.61/GSM 04.08:**  
***Authentication Parameter RAND* information element**

### 10.5.3.2 Authentication parameter SRES

The purpose of the *authentication parameter SRES* information element is to provide the network with the authentication response signature calculated in the mobile station.

The *Authentication Parameter SRES* information element is coded as shown in figure 10.62/GSM 04.08 and table 10.62/GSM 04.08.

The *Authentication Parameter SRES* is a type 3 information element with 5 octets length.

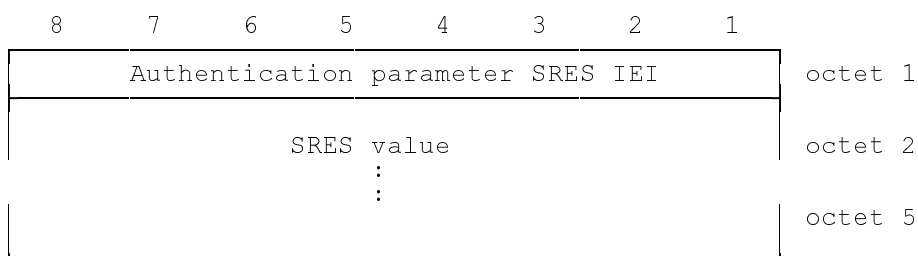

**Figure 10.62/GSM 04.08:**  
***Authentication Parameter SRES* information element**

<p>SRES value (octet 2, 3, 4 and 5) The SRES value consists of 32 bits. Bit 8 of octet 2 is the most significant bit while bit 1 of octet 5 is the least significant bit.</p>
---

**Table 10.62/GSM 04.08:**  
***Authentication Parameter SRES* information element**

**10.5.3.3 CM service type**

The purpose of the *CM Service Type* information element is to specify which service is requested from the network.

The *CM Service Type* information element is coded as shown in figure 10.63/GSM 04.08 and table 10.63/GSM 04.08.

The *CM Service Type* is a type 1 information element.

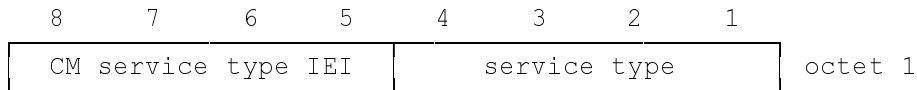

**Figure 10.63/GSM 04.08:  
 CM Service Type information element**

Service type (octet 1)	
Bits	
4 3 2 1	
0 0 0 1	Mobile originating call establishment or packet mode connection establishment
0 0 1 0	Emergency call establishment
0 1 0 0	Short message service
1 0 0 0	Supplementary service activation
All other values are reserved.	

**Table 10.63/GSM 04.08:  
 CM Service Type information element**

### 10.5.3.4 Identity type

The purpose of the *Identity Type* information element is to specify which identity is requested.

The *Identity Type* information element is coded as shown in figure 10.64/GSM 04.08 and table 10.64/GSM 04.08.

The *Identity Type* is a type 1 information element.

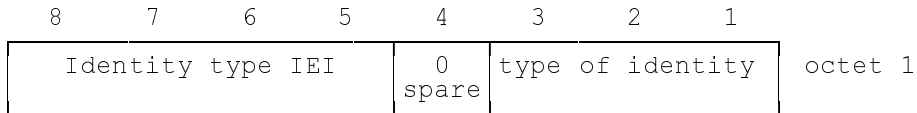

**Figure 10.64/GSM 04.08:**  
***Identity Type* information element**

Type of identity (octet 1)	
Bits	
3 2 1	
0 0 1	IMSI
0 1 0	IMEI
0 1 1	IMEISV
1 0 0	TMSI
All other values are reserved.	

**Table 10.64/GSM 04.08:**  
***Identity Type* information element**

### 10.5.3.5 Location updating type

The purpose of the *Location Updating Type* information element is to indicate whether a normal updating, a periodic updating or an IMSI attach is wanted. It may also indicate that a follow-on request has been received from the mobile station CM layer.

The *Location Updating Type* information element is coded as shown in figure 10.65/GSM 04.08 and table 10.65/GSM 04.08.

The *Location Updating Type* is a type 1 information element.

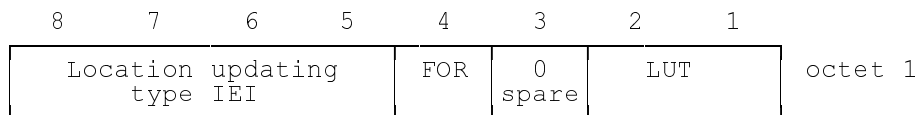

**Figure 10.65/GSM 04.08:**  
***Location Updating Type* information element**

LUT (octet 1)	
Bits	
2	1
0	0
0	1
1	0
1	1
	Normal location updating
	Periodic updating
	IMSI attach
	Reserved
FOR (octet 1)	
The Follow-On Request bit (FOR) is coded as follows:	
Bit	
4	
0	No follow-on request pending
1	Follow-on request pending

**Table 10.65/GSM 04.08:**  
***Location Updating Type* information element**



### 10.5.3.6 Reject cause

The purpose of the *Reject Cause* information element is to indicate the reason why a request from the mobile station is rejected by the network.

The *Reject Cause* information element is coded as shown in figure 10.66/GSM 04.08 and table 10.66/GSM 04.08.

The *Reject Cause* is a type 3 information element with 2 octets length.

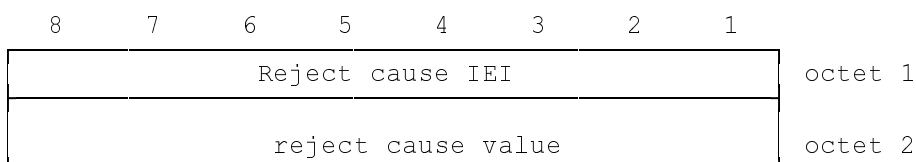

**Figure 10.66/GSM 04.08:  
Reject Cause information element**

Reject cause value (octet 2)								
Bits								
8	7	6	5	4	3	2	1	
0	0	0	0	0	0	1	0	IMSI unknown in HLR
0	0	0	0	0	0	1	1	Illegal MS
0	0	0	0	0	1	0	0	IMSI unknown in VLR
0	0	0	0	0	1	0	1	IMEI not accepted
0	0	0	0	0	1	1	0	Illegal ME
0	0	0	0	1	0	1	1	PLMN not allowed
0	0	0	0	1	1	0	0	Location Area not allowed
0	0	0	0	1	1	0	1	Roaming not allowed in this location area
0	0	0	1	0	0	0	1	Network failure
0	0	0	1	0	1	1	0	Congestion
0	0	1	0	0	0	0	0	Service option not supported
0	0	1	0	0	0	0	1	Requested service option not subscribed
0	0	1	0	0	0	1	0	Service option temporarily out of order
0	0	1	0	0	1	1	0	Call cannot be identified
0	0	1	1	0	0	0	0	}
0	0	1	1	1	1	1	1	} retry upon entry into a new cell
0	1	0	1	1	1	1	1	Semantically incorrect message
0	1	1	0	0	0	0	0	Invalid mandatory information
0	1	1	0	0	0	0	1	Message type non-existent or not implemented
0	1	1	0	0	0	1	0	Message type not compatible with the protocol state
0	1	1	0	0	0	1	1	Information element non-existent or not implemented
0	1	1	0	0	1	0	0	Conditional IE error
0	1	1	0	0	1	0	1	Message not compatible with the protocol state
0	1	1	0	1	1	1	1	Protocol error, unspecified

Any other value received by the mobile station shall be treated as 0010 0010, "Service option temporarily out of order". Any other value received by the network shall be treated as 0110 1111, "Protocol error, unspecified".

NOTE: The listed reject cause values are defined in annex G.

**Table 10.66/GSM 04.08:  
Reject Cause information element**

### 10.5.3.7 Follow-on Proceed

The purpose of the *Follow-on Proceed* information element is to indicate that an MM connection may be established on an existing RR connection.

The *Follow-on Proceed* information element is coded as shown in figure 10.67/GSM 04.08.

The *Follow-on Proceed* is a type 2 information element.

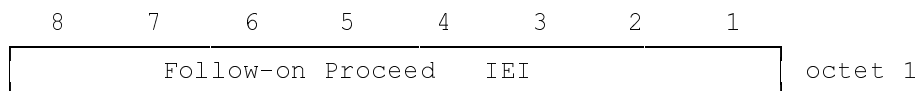

**Figure 10.67/GSM 04.08:**  
***Follow-on Proceed* information element**

## 10.5.4 Call control information elements.

### 10.5.4.1 Extensions of codesets

There is a certain number of possible information element identifier values using the formatting rules described in section 10.5: 128 from the type 3 & 4 information element format and at least 8 from the type 1 & 2 information element format.

One value in the type 1 format is specified for shift operations described below. One other value in both the type 3 & 4 and type 1 format is reserved. This leaves 133 information element identifier values available for assignment.

It is possible to expand this structure to eight codesets of 133 information element identifier values each. One common value in the type 1 format is employed in each codeset to facilitate shifting from one codeset to another. The contents of this shift information element identifies the codeset to be used for the next information element or elements. The codeset in use at any given time is referred to as the "active codeset". By convention, codeset 0 is the initially active codeset.

Two codeset shifting procedures are supported: locking shift and non-locking shift.

Codeset 5 is reserved for information elements reserved for national use.

Codeset 6 is reserved for information elements specific to the local network (either public or private).

Codeset 7 is reserved for user-specific information elements.

The coding rules specified in section 10.5 shall apply for information elements belonging to any active codeset.

Transitions from one active codeset to another (i.e. by means of the locking shift procedure) may only be made to a codeset with a higher numerical value than the codeset being left.

An information element belonging to codeset 5, 6 or 7 may appear together with information elements belonging to codeset 0, by using the non-locking shift procedure (see section 10.5.4.3).

A user or network equipment shall have the capability to recognize a shift information element and to determine the length of the following information element, although the equipment need not be able to interpret and act on the content of the information element. This enables the equipment to determine the start of the subsequent information element.

### 10.5.4.2 Locking shift procedure

The locking shift procedure employs an information element to indicate the new active codeset. The specified codeset remains active until another locking shift information element is encountered which specifies the use of another codeset. For example, codeset 0 is active at the start of message content analysis. If a locking shift to codeset 5 is encountered, the next information elements will be interpreted according to the information element identifiers assigned in codeset 5, until another shift information element is encountered. This procedure is used only to shift to a higher order codeset than the one being left.

The locking shift is valid only within that message which contains the locking shift information element. At the start of every message content analysis, the active codeset is codeset 0.

The locking shift information element uses the type 1 information element format and coding shown in figure 10.68/GSM 04.08 and table 10.68/GSM 04.08.

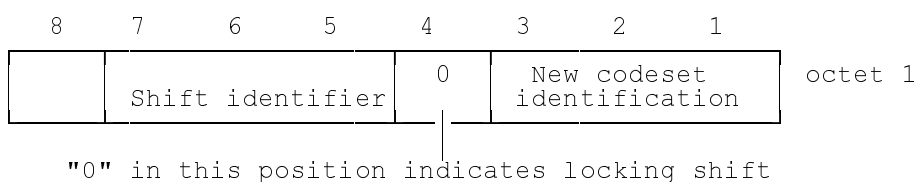

**Figure 10.68/GSM 04.08:  
Locking shift element**

Codeset identification (octet 1):	
bits 3 2 1	
0 0 0	not applicable
0 0 1	
to 1 0 0	reserved
1 0 1	codeset 5: information elements for national use
1 1 0	codeset 6: information elements specific to the local network (either public or private)
1 1 1	codeset 7: user-specific information elements

**Table 10.68/GSM 04.08:  
Locking shift element**

### 10.5.4.3 Non-locking shift procedure

The non-locking shift procedure provides a temporary shift to the specified lower or higher codeset. The non-locking shift procedure uses a type 1 information element to indicate the codeset to be used to interpret the next information element. After the interpretation of the next information element, the active codeset is again used for interpreting any following information elements. For example, codeset 0 is active at the beginning of message content analysis. If a non-locking shift to codeset 6 is encountered, only the next information element is interpreted according to the information element identifiers assigned in codeset 6. After this information element is interpreted, codeset 0 will again be used to interpret the following information elements. A non-locking shift information element indicating the current codeset shall not be regarded as an error.

A locking shift information element shall not follow directly a non-locking shift information element. If this combination is received, it shall be interpreted as though a locking shift information element had been received.

The non-locking shift information element uses the type 1 information format and coding shown in figure 10.69/GSM 04.08 and table 10.69/GSM 04.08.

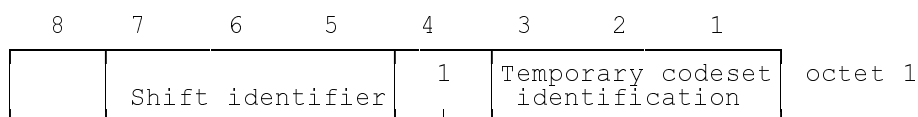

"1" in this position indicates non-locking shift

**Figure 10.69/GSM 04.08:  
 Non-locking shift element**

Codeset identification (octet 1):	
bits 3 2 1	
0 0 0	codeset 0 (initially active): GSM 04.08 information elements
to 0 0 1	reserved
1 0 0	codeset 5: information elements for national use
1 0 1	codeset 6: information elements specific to the local network (either public or private)
1 1 0	codeset 7: user-specific information elements.
1 1 1	

**Table 10.69/GSM 04.08:  
 Non-locking shift element**

#### 10.5.4.4 Auxiliary states

The purpose of the auxiliary states information element is to describe the current status of the auxiliary states of a call in the call control states "active" and "mobile originating modify" (see GSM 04.83 and 04.84).

The auxiliary states information element is coded as shown in figure 10.70/GSM 04.08, table 10.70/GSM 04.08 and table 10.71/GSM 04.08.

The auxiliary states is a type 4 information element with 3 octets length.

8	7	6	5	4	3	2	1	
Auxiliary states IEI								octet 1
Length of auxiliary states contents								octet 2
1 ext	0	0	0	hold aux. state	MPTY aux. state			octet 3
spare								

**Figure 10.70/GSM 04.08:  
Auxiliary states information element**

Hold auxiliary state (octet 3)			
Bits			
4	3		
0	0	idle	Note 1
0	1	hold request	Note 1
1	0	call held	Note 1
1	1	retrieve request	Note 1
Note 1: These states are defined in Rec GSM 04.83.			

**Table 10.70/GSM 04.08:  
Auxiliary states information element**

Multi party auxiliary state (octet 3)			
Bits			
2	1		
0	0	idle	Note 2
0	1	MPTY request	Note 2
1	0	call in MPTY	Note 2
1	1	split request	Note 2
NOTE 2: These states are defined in Rec GSM 04.84.			

**Table 10.71/GSM 04.08:  
Auxiliary states information element**

**10.5.4.5 Bearer capability**

The purpose of the bearer capability information element is to describe a bearer service. The use of the bearer capability information element in relation to compatibility checking is described in annex B.

The bearer capability information element is coded as shown in figure 10.71/GSM 04.08 and tables 10.72/GSM 04.08 to 10.79/GSM 04 08.

The bearer capability is a type 4 information element with a minimum length of 3 octets and a maximum length of 10 octets.

	8	7	6	5	4	3	2	1	
	Bearer capability IEI								octet 1
	Length of the bearer capability contents								octet 2
1 ext	radio channel requirement		co- ding std	trans fer mode	information transfer capability				octet 3
1 ext	0 spare	structure		dupl. mode	confi gur.	NIRR	esta- bli.		octet 4*
1 ext	0	0	rate adaption		signalling access protocol				octet 5*
0/1 ext	0	1	User information layer 1 protocol			sync/ async		octet 6*	
0/1 ext	numb. stop bits	nego- tia- tion	numb. data bits	user rate					octet 6a*
0/1 ext	intermed. rate		NIC on TX	NIC on RX	Parity				octet 6b*
1 ext	connection element		modem type					octet 6c*	
1 ext	1	0	User information layer 2 protocol					octet 7*	

**Figure 10.71/GSM 04.08:  
 Bearer capability information element**

NOTE: The coding of the octets of the bearer capability information element is not conforming to TS CCITT Q.931.

Radio channel requirement (octet 3), network to mobile station direction	
Bits 6 and 7 are spare bits. The sending side (i.e. the network) shall set bit 7 to value 0 and bit 6 to value 1.	
Radio channel requirement (octet 3) mobile station to network direction	
Bits	
7 6	
0 0	reserved
0 1	full rate support only mobile station
1 0	dual rate support mobile station/half rate preferred
1 1	dual rate support mobile station/full rate preferred
Coding standard (octet 3)	
Bit	
5	
0	GSM standardized coding as described below
1	reserved
Transfer mode (octet 3)	
Bit	
4	
0	circuit mode
1	packet mode
Information transfer capability (octet 3)	
Bits	
3 2 1	
0 0 0	speech
0 0 1	unrestricted digital information
0 1 0	3.1 kHz audio, ex PLMN
0 1 1	facsimile group 3
1 1 1	reserved, to be used in the network. The meaning is: alternate speech/facsimile group 3 - starting with speech.
All other values are reserved	

**Table 10.72/GSM 04.08:  
Bearer capability information element**

Structure (octet 4)

Bits

6 5

0 0 service data unit integrity  
1 1 unstructured

All other values are reserved.

Duplex mode (octet 4)

Bit 4

0 half duplex  
1 full duplex

Configuration (octet 4)

Bit

3

0 point-to-point

All other values are reserved.

NIRR (octet 4)

(Negotiation of Intermediate Rate Requested)

Bit

2

0 No meaning is associated with this value.  
1 Data up to and including 4.8 kb/s, full rate,  
non-transparent, 6 kb/s radio interface rate  
is requested.

Establishment (octet 4)

Bit

1

0 demand

All other values are reserved

**Table 10.73/GSM 04.08:**  
**Bearer capability information element**



Access identity (octet 5)	
Bits	
7 6	
0 0	octet identifier
All other values are reserved	
Rate adaption (octet 5)	
Bits	
5 4	
0 0	no rate adaption
0 1	V.110/X.30 rate adaption
1 0	CCITT X.31 flag stuffing
All other values are reserved.	
Signalling access protocol (octet 5)	
Bits	
3 2 1	
0 0 1	I.440/450
0 1 0	X.21
0 1 1	X.28 - dedicated PAD, individual NUI
1 0 0	X.28 - dedicated PAD, universal NUI
1 0 1	X.28 - non dedicated PAD
1 1 0	X.32
All other values are reserved.	

**Table 10.74/GSM 04.08:  
Bearer capability information element**

Layer 1 identity (octet 6)	
Bits	
7 6	
0 1	octet identifier
All other values are reserved	
User information layer 1 protocol (octet 6)	
Bits	
5 4 3 2	
0 0 0 0	default layer 1 protocol
All other values reserved.	
Synchronous/asynchronous (octet 6)	
Bit	
1	
0	synchronous
1	asynchronous

**Table 10.75/GSM 04.08:  
Bearer capability information element**

Number of Stop Bits (octet 6a)	
Bit	
7	
0	1 bit (This value is also used in the case of synchronous mode)
1	2 bits
Negotiation (octet 6a)	
Bit	
6	
0	in-band negotiation not possible
NOTE: See Rec. V.110 and X.30	
All other values are reserved	
Number of data bits excluding parity bit if present (octet 6a)	
Bit	
5	
0	7 bits
1	8 bits (this value is also used in the case of bit oriented protocols)
User rate (octet 6a)	
Bits	
4 3 2 1	
0 0 0 1	0.3 kbit/s Recommendation X.1 and V.110
0 0 1 0	1.2 kbit/s Recommendation X.1 and V.110
0 0 1 1	2.4 kbit/s Recommendation X.1 and V.110
0 1 0 0	4.8 kbit/s Recommendation X.1 and V.110
0 1 0 1	9.6 kbit/s Recommendation X.1 and V.110
0 1 1 0	12.0 kbit/s transparent (non compliance with X.1 and V.110)
0 1 1 1	1.2 kbit/s/75 bit/s Recommendation V.23, (asymmetric) X.1,V.110.
All other values are reserved.	
For facsimile group 3 calls the user rate indicates the first and maximum speed the mobile station is using.	

**Table 10.76/GSM 04.08:  
 Bearer capability information element**

Octet 6b for V.110/X.30 rate adaption	
Intermediate rate (octet 6b)	
Bits	
7 6	
0 0	reserved
0 1	reserved
1 0	8 kbit/s
1 1	16 kbit/s
Network independent clock (NIC) on transmission (Tx)	
(octet 6b) (See Rec. V.110 and X.30)	
Bit	
5	
0	does not require to send data with network independent clock
1	requires to send data with network independent clock
Network independent clock (NIC) on reception (Rx)	
(octet 6b) (See Rec. V.110 and X.30)	
Bit	
4	
0	cannot accept data with network independent clock (i.e. sender does not support this optional procedure)
1	can accept data with network independent clock (i.e. sender does support this optional procedure)
Parity information (octet 6b)	
Bits	
3 2 1	
0 0 0	odd
0 1 0	even
0 1 1	none
1 0 0	forced to 0
1 0 1	forced to 1
All other values are reserved.	

**Table 10.77/GSM 04.08:**  
**Bearer capability information element**

Connection element (octet 6c)

Bit

7 6

0 0	transparent
0 1	non transparent (RLP)
1 0	both, transparent preferred
1 1	both, non transparent preferred

The requesting end (e.g. the one sending the SETUP message) should use the 4 values depending on its capabilities to support the different modes. The answering party shall only use the codings 00 or 01, based on its own capabilities and the proposed choice if any. If both MS and network support both transparent and non transparent, priority should be given to the MS preference.

Modem type (octet 6c)

Bits

5 4 3 2 1

0 0 0 0 0	none
0 0 0 0 1	V.21
0 0 0 1 0	V.22
0 0 0 1 1	V.22 bis
0 0 1 0 0	V.23
0 0 1 0 1	V.26 ter
0 0 1 1 0	V.32
0 0 1 1 1	modem for undefined interface
0 1 0 0 0	autobauding type 1

All other values are reserved.

**Table 10.78/GSM 04.08:  
Bearer capability information element**

Layer 2 identity (octet 7)	
Bits	
7 6	
1 0	octet identifier
All other values are reserved	
User information layer 2 protocol (octet 7)	
Bits	
5 4 3 2 1	
0 0 1 1 0	recommendation X.25, link level
0 1 0 0 0	ISO 6429, codeset 0 (DC1/DC3)
0 1 0 0 1	X.75 layer 2 modified (teletex)
0 1 0 1 0	videotex profile 1
0 1 1 0 0	COPnoFlCt (Character oriented Protocol with no Flow Control mechanism)
All other values are reserved.	

**Table 10.79/GSM 04.08:  
Bearer capability information element**

#### **10.5.4.5.1 Static conditions for the bearer capability IE contents**

If the information transfer capability field (octet 3) indicates "speech", octets 4, 5, 6, 6a, 6b, 6c, and 7 shall not be included.

If the information transfer capability field (octet 3) indicates a value different from "speech", octets 4, 5, 6, 6a, 6b, and 6c shall be included.

If the information transfer capability field (octet 3) indicates "facsimile group 3", the modem type field (octet 6c) shall indicate "none".

The modem type field (octet 6c) shall not indicate "autobauding type 1" unless the connection element field (octet 6c) indicates "non transparent".

**10.5.4.5a Call Control Capabilities**

The purpose of the Call Control Capabilities information element is to identify the call control capabilities of the mobile station.

The Call Control Capabilities information element is coded as shown in figure 10.71a/GSM 04.08 and table 10.79a/GSM 04.08.

The Call Control Capabilities is a type 4 information element with a length of 3 octets.

8	7	6	5	4	3	2	1	
Call Control Capabilities IEI								octet 1
Length of Call Control Capabilities contents								octet 2
0	0	0	0	0	0	0	1	octet 3
spare							DTMF	

**Figure 10.71a/GSM 04.08:  
 Call Control Capabilities information element**

DTMF (octet 3, bit 1)	
0	This value is reserved for earlier versions of the protocol.
1	This value indicates that the mobile station supports DTMF as specified in section 5.5.7 of this specification.

**Table 10.79a/GSM 04.08:  
 Call Control Capabilities**

### 10.5.4.6 Call state

The purpose of the call state information element is to describe the current status of a call, (see section 5.1).

The call state information element is coded as shown in figure 10.72/GSM 04.08 and table 10.80/GSM 04.08.

The call state is a type 3 information element with 2 octets length.

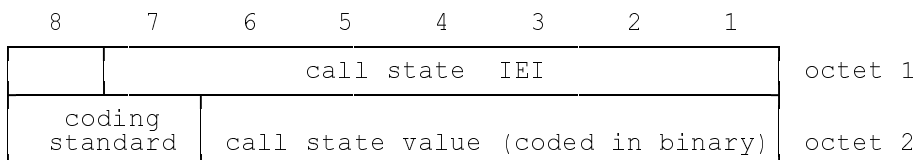

**Figure 10.72/GSM 04.08:  
Call state information element**

Coding standard (octet 2)					
Bits					
8	7				
0 0	standardized coding as described in CCITT Rec. Q.931				
0 1	reserved for other international standards				
1 0	national standard				
1 1	standard defined for the GSM PLMNS as described below				
Coding standards other than "1 1 - Standard defined for the GSM PLMNS" shall not be used if the call state can be represented with the GSM standardized coding.					
The mobile station or network need not support any other coding standard than "1 1 - Standard defined for the GSM PLMNS".					
If a call state IE indicating a coding standard not supported by the receiver is received, call state "active" shall be assumed.					
Call state value (octet 2)					
Bits					
6	5	4	3	2	1
0 0 0 0 0 0	U0 - null				NO - null
0 0 0 0 1 0	U0.1- MM connection pending				N0.1- MM connection pending
0 0 0 0 0 1	U1 - call initiated				N1 - call initiated
0 0 0 0 1 1	U3 - mobile originating call proceeding				N3 - mobile originating call proceeding
0 0 0 1 0 0	U4 - call delivered				N4 - call delivered
0 0 0 1 1 0	U6 - call present				N6 - call present
0 0 0 1 1 1	U7 - call received				N7 - call received
0 0 1 0 0 0	U8 - connect request				N8 - connect request
0 0 1 0 0 1	U9 - mobile terminating call confirmed				N9 - mobile terminating call confirmed
0 0 1 0 1 0	U10- active				N10- active
0 0 1 0 1 1	U11- disconnect request				
0 0 1 1 0 0	U12- disconnect indication				N12-disconnect indication
0 1 0 0 1 1	U19- release request				N19- release request
0 1 1 0 1 0	U26- mobile originating modify				N26- mobile originating modify
0 1 1 0 1 1	U27- mobile terminating modify				N27- mobile terminating modify
0 1 1 1 0 0					N28- connect indication

**Table 10.80/GSM 04.08:  
Call state information element**

**10.5.4.7 Called party BCD number**

The purpose of the called party BCD number information element is to identify the called party.

The called party BCD number information element is coded as shown in figure 10.73/GSM 04.08 and table 10.81/GSM 04.08.

The called party BCD number is a type 4 information element with a minimum length of 3 octets and a maximum length of 13 octets.

8	7	6	5	4	3	2	1	
Called party BCD number IEI								octet 1
Length of called party BCD number contents								octet 2
1 ext	type of number			Numbering plan identification				octet 3
Number digit 2				Number digit 1				octet 4*
Number digit 4				Number digit 3				octet 5*
2)								: : :

**Figure 10.73/GSM 04.08:  
 Called party BCD number information element**

NOTE 1: The number digit(s) in octet 4 precedes the digit(s) in octet 5 etc. The number digit which would be entered first is located in octet 4, bits 1 to 4.

NOTE 2: If the called party BCD number contains an odd number of digits, bits 5 to 8 of the last octet shall be filled with an end mark coded as "1111".

Since the information element must contain the complete called party BCD number there is no need for an additional complete indication.

Type of number (octet 3) (Note 1)	
Bits	
7 6 5	
0 0 0	unknown (Note 2)
0 0 1	international number (Note 3, Note 5)
0 1 0	national number (Note 3)
0 1 1	network specific number (Note 4)
1 0 0	dedicated access, short code
1 0 1	reserved
1 1 0	reserved
1 1 1	reserved for extension

**Table 10.81/GSM 04.08:  
 Called party BCD number**

NOTE 1: For the definition of "number" see CCITT Recommendation I.330 and GSM 03.03.

NOTE 2: The type of number "unknown" is used when the user or the network has no knowledge of the type of number, e.g. international number, national number, etc. In this case the number digits field is organized according to the network dialling plan, e.g. prefix or escape digits might be present.

NOTE 3: Prefix or escape digits shall not be included.



NOTE 4: The type of number "network specific number" is used to indicate administration/service number specific to the serving network, e.g. used to access an operator.

NOTE 5: The international format shall be accepted by the MSC when the call is destined to a destination in the same country as the MSC.

Numbering plan identification (octet 3)	
Number plan (applies for type of number = 000, 001, 010 and 100)	
Bits	
4 3 2 1	
0 0 0 0	unknown
0 0 0 1	ISDN/telephony numbering plan (Rec. E.164/E.163)
0 0 1 1	data numbering plan (Recommendation X.121)
0 1 0 0	telex numbering plan (Recommendation F.69)
1 0 0 0	national numbering plan
1 0 0 1	private numbering plan
1 1 1 1	reserved for extension
All other values are reserved.	

**Table 10.81/GSM 04.08:  
Called party BCD number (continued)**

When an MS is the recipient of number information from the network, any incompatibility between the number digits and the number plan identification shall be ignored and a STATUS message shall not be sent to the network.

In the case of numbering plan "unknown", the number digits field is organized according to the network dialling plan; e.g. prefix or escape digits might be present.

Number digits (octets 4, etc.)	
Bits	Number digit value
4 3 2 1 or	
8 7 6 5	
0 0 0 0	0
0 0 0 1	1
0 0 1 0	2
0 0 1 1	3
0 1 0 0	4
0 1 0 1	5
0 1 1 0	6
0 1 1 1	7
1 0 0 0	8
1 0 0 1	9
1 0 1 0	*
1 0 1 1	#
1 1 0 0	a
1 1 0 1	b
1 1 1 0	c
1 1 1 1	used as an endmark in the case of an odd number of number digits

**Table 10.81/GSM 04.08:  
Called party BCD number (continued)**

### 10.5.4.8 Called party subaddress

The purpose of the Called party subaddress is to identify the subaddress of the called party of a call. For the definition of a subaddress see Rec. CCITT I.330.

The Called party subaddress information element is coded as shown in figure 10.74/GSM 04.08 and table 10.82/GSM 04.08

The called party subaddress is a type 4 information element with a minimum length of 2 octets and a maximum length of 23 octets.

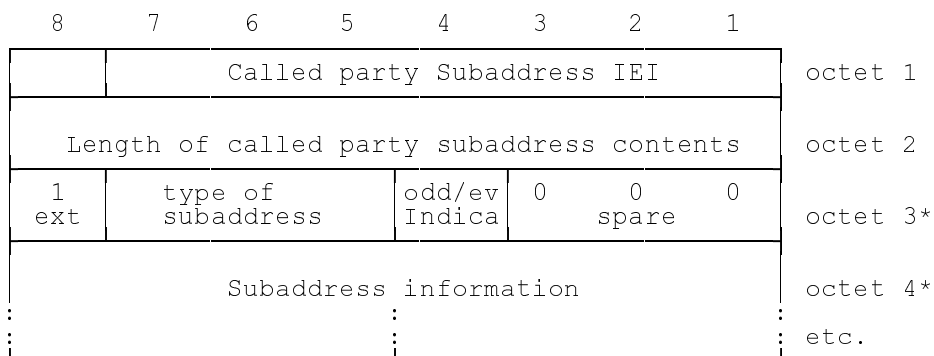

**Figure 10.74/GSM 04.08:  
 Called party subaddress**

<p>Type of subaddress (octet 3)</p> <p>Bits                  7 6 5                  0 0 0 NSAP (X.213/ISO 8348 AD2)                  0 1 0 User specified                  All other values are reserved</p> <p>Odd/even indicator (octet 3)                  Bit                  4                  0 even number of address signals                  1 odd number of address signals</p> <p>NOTE: The odd/even indicator is used when the type of subaddress is "user specified" and the coding is BCD.</p> <p>Subaddress information (octet 4, etc...)                  The NSAP X.213/ISO8348AD2 address shall be formatted as specified by octet 4 which contains the Authority and Format Identifier (AFI). The encoding is made according to the "preferred binary encoding" as defined in X.213/ISO8348AD2. For the definition of this type of subaddress, see Rec. CCITT I.334.</p> <p>A coding example is given in ANNEX A.</p> <p>For User-specific subaddress, this field is encoded according to the user specification, subject to a maximum length of 20 octets. When interworking with X.25 networks BCD coding should be applied.</p> <p>NOTE: It is recommended that users apply NSAP subaddress type since this subaddress type allows the use of decimal, binary and IA5 characters in a standardised manner.</p>
--

**Table 10.82/GSM 04.08:  
 Called party subaddress**

### 10.5.4.9 Calling party BCD number

The purpose of the calling party BCD number information element is to identify the origin of a call.

The calling party BCD number information element is coded as shown in figure 10.75/GSM 04.08 and table 10.83/GSM 04.08.

The calling party BCD number is a type 4 information element. In the network to mobile station direction it has a minimum length of 3 octets and a maximum length of 14 octets. (This information element is not used in the mobile station to network direction.)

8	7	6	5	4	3	2	1	
Calling party BCD number IEI								octet 1
Length of calling party BCD number contents								octet 2
0/1 ext	type of number			Numbering plan identification				octet 3
1 ext	presentat. indicator	0	0	0	screening indicator			octet 3a*
Number digit 2				Number digit 1				octet 4*
Number digit 4				Number digit 3				octet 5*
								:
								:

**Figure 10.75/GSM 04.08:  
 Calling party BCD number information element**

The contents of octets 3, 4, etc. are coded as shown in table 10.81. The coding of octet 3a is defined in table 10.83 below.

If the calling party BCD number contains an odd number of digits, bits 5 to 8 of the last octet shall be filled with an end mark coded as "1111".

Presentation indicator (octet 3a)	
Bits	
7 6	
0 0	Presentation allowed
0 1	Presentation restricted
1 0	Number not available due to interworking
1 1	Reserved
If octet 3a is omitted the value "00 - Presentation allowed" is assumed.	
Screening indicator (octet 3a)	
Bits	
2 1	
0 0	User-provided, not screened
0 1	User-provided, verified and passed
1 0	User-provided, verified and failed
1 1	Network provided
If octet 3a is omitted the value "0 0 - User provided, not screened" is assumed.	

**Table 10.83/GSM 04.08:  
 Calling party BCD number**

**10.5.4.10 Calling party subaddress**

The purpose of the Calling party subaddress is to identify a subaddress associated with the origin of a call. For the definition of a subaddress see Rec. CCITT I.330.

The Calling party subaddress information element is coded as shown in figure 10.76/GSM 04.08 and table 10.84/GSM 04.08

The calling party subaddress is a type 4 information element with a minimum length of 2 octets and a maximum length of 23 octets.

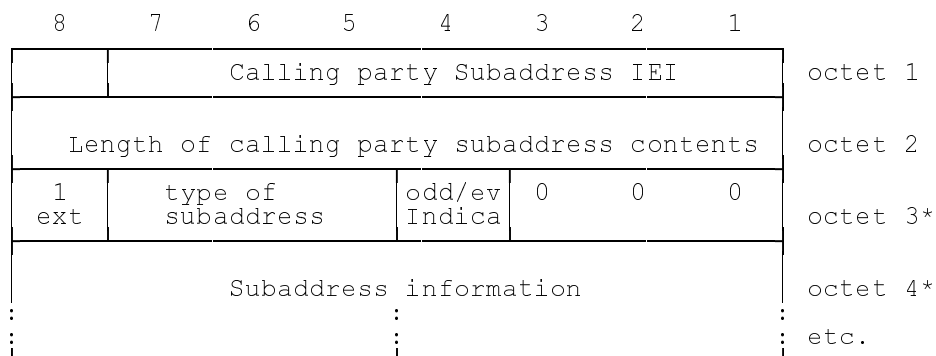

**Figure 10.76/GSM 04.08:  
 Calling party subaddress**

Type of subaddress (octet 3)

Bits

7 6 5

0 0 0 NSAP (X.213/ISO 8348 AD2)

0 1 0 User specified

All other values are reserved

Odd/even indicator (octet 3)

Bit

4

0 even number of address signals

1 odd number of address signals

The odd/even indicator is used when the type of subaddress is "user specified" and the coding is BCD

Subaddress information (octet 4, etc...)

The NSAP X.213/ISO8348AD2 address shall be formatted as specified by octet 4 which contains the Authority and Format Identifier (AFI). The encoding is made according to the "preferred binary encoding" as defined in X.213/ISO8348AD2. For the definition of this type of this type of subaddress, see Rec. CCITT I.332.

A coding example is given in ANNEX A.

For User-specific subaddress, this field is encoded according to the user specification, subject to a maximum length of 20 octets. When interworking with X.25 networks BCD coding should be applied.

NOTE: It is recommended that users apply NSAP subaddress type since this subaddress type allows the use of decimal, binary and IA5 characters in a standardised manner.

**Table 10.84/GSM 04.08:  
Calling party subaddress**

**10.5.4.11 Cause**

The purpose of the cause information element is to describe the reason for generating certain messages, to provide diagnostic information in the event of procedural errors and to indicate the location of the cause originator.

The cause information element is coded as shown in figure 10.77/GSM 04.08 and tables 10.85 and 10.86/GSM 04.08.

The cause is a type 4 information element with a minimum length of 4 octets and a maximum length of 32 octets.

The cause information element may be repeated in a message.

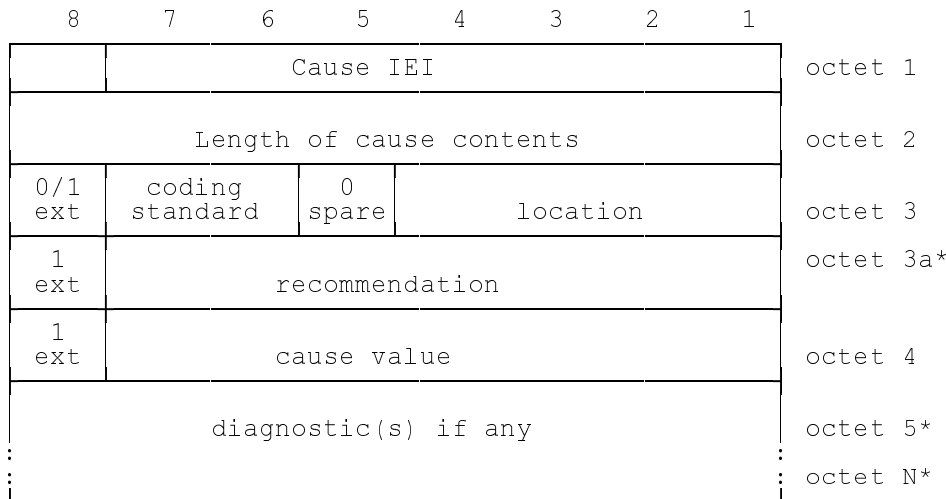

**Figure 10.77/GSM 04.08:  
 Cause information element**

If the default value applies for the recommendation field, octet 3a shall be omitted.

```

Coding standard (octet 3)
Bits
7 6
0 0 Coding as specified in CCITT Rec. Q.931
0 1 Reserved for other international standards
1 0 National standard
1 1 Standard defined for the GSM PLMNS as described
below and in table 10.86/GSM 04.08

```

Coding standards other than "1 1 - Standard defined for the GSM PLMNS" shall not be used if the cause can be represented with the GSM standardized coding.

The mobile station or network need not support any other coding standard than "1 1 - Standard defined for the GSM PLMNS".

If a cause IE indicating a coding standard not supported by the receiver is received, cause "interworking, unspecified" shall be assumed.

```

Location (octet 3)

```

```

Bits
4 3 2 1
0 0 0 0 user
0 0 0 1 private network serving the local user
0 0 1 0 public network serving the local user
0 0 1 1 transit network
0 1 0 0 public network serving the remote user
0 1 0 1 private network serving the remote user
0 1 1 1 international network
1 0 1 0 network beyond interworking point

```

All other values are reserved.

```

Recommendation (octet 3a)

```

Octet 3a shall not be included if the coding standard is coded as "1 1 - Standard defined for GSM PLMNS".

If the coding standard is different from "1 1 - Standard defined for GSM PLMNS", the coding of octet 3a, if included, and octets 4 to N is according to that coding standard.

**Table 10.85/GSM 04.08:  
Cause information element**

Cause value (octet 4)

The cause value is divided in two fields: a class (bits 5 through 7) and a value within the class (bits 1 through 4).

The class indicates the general nature of the event.

Class (000): normal event  
Class (001): normal event  
Class (010): resource unavailable  
Class (011): service or option not available  
Class (100): service or option not implemented  
Class (101): invalid message (e.g. parameter out of range)  
Class (110): protocol error (e.g. unknown message)  
Class (111): interworking

The cause values are listed in table 10.86/GSM 04.08 below and defined in annex H.

Diagnostic(s) (octet 5)

Diagnostic information is not available for every cause, see table 10.86/GSM 04.08 below.

When available, the diagnostic(s) is coded in the same way as the corresponding information element in section 10.

The inclusion of diagnostic(s) is optional.

**Table 10.85/GSM 04.08:  
Cause information element (continued)**



Cause Class	value Value	Cause num.	Cause	Diag- nostic	Remarks
7 6 5	4 3 2 1				
0 0 0	0 0 0 1	1.	Unassigned (unallocated) number	Note 9	
0 0 0	0 0 1 1	3.	No route to destination	Note 9	
0 0 0	0 1 1 0	6.	Channel unacceptable	-	
0 0 0	1 0 0 0	8.	Operator determined barring	-	
0 0 1	0 0 0 0	16.	Normal call clearing	Note 9	
0 0 1	0 0 0 1	17.	User busy	-	
0 0 1	0 0 1 0	18.	No user responding	-	
0 0 1	0 0 1 1	19.	User alerting, no answer	-	
0 0 1	0 1 0 1	21.	Call rejected	Note 9 - user supplied diagnostic (note 4)	
0 0 1	0 1 1 0	22.	Number changed	New destination (note 5)	
0 0 1	1 0 1 0	26.	Non selected user clearing	-	
0 0 1	1 0 1 1	27.	Destination out of order	-	
0 0 1	1 1 0 0	28.	Invalid number format (incomplete number)	-	
0 0 1	1 1 0 1	29.	Facility rejected	Note 1	
0 0 1	1 1 1 0	30.	Response to STATUS ENQUIRY	-	
0 0 1	1 1 1 1	31.	Normal, unspecified	-	
0 1 0	0 0 1 0	34.	No circuit/channel available	-	
0 1 0	0 1 1 0	38.	Network out of order	-	
0 1 0	1 0 0 1	41.	Temporary failure	-	
0 1 0	1 0 1 0	42.	Switching equipment congestion	-	
0 1 0	1 0 1 1	43.	Access information discarded	Discarded information element identifiers (note 6)	
0 1 0	1 1 0 0	44.	requested circuit/channel not available	-	
0 1 0	1 1 1 1	47.	Resources unavailable, unspecified	-	
0 1 1	0 0 0 1	49.	Quality of service unavailable	Note 9	
0 1 1	0 0 1 0	50.	Requested facility not subscribed	Note 1	
0 1 1	0 1 1 1	55.	Incoming calls barred within the CUG	Note 1	
0 1 1	1 0 0 1	57.	Bearer capability not authorized	Note 3	
0 1 1	1 0 1 0	58.	Bearer capability not presently available	Note 3	
0 1 1	1 1 1 1	63.	Service or option not available, unspecified	-	
1 0 0	0 0 0 1	65.	Bearer service not implemented	Note 3	

**Table 10.86/GSM 04.08:  
Cause information element values**

Cause Class	value Value	Cause number	Cause	Diag- nostic	Remarks
7 6 5	4 3 2 1				
1 0 0	0 1 0 0	68.	ACM equal to or greater than ACMmax		
1 0 0	0 1 0 1	69.	Requested facility not implemented	Note 1	
1 0 0	0 1 1 0	70.	Only restricted digital information bearer capability is available		
1 0 0	1 1 1 1	79.	Service or option not implemented, unspecified	-	
1 0 1	0 0 0 1	81.	Invalid transaction identifier value	-	
1 0 1	0 1 1 1	87.	User not member of CUG	Note 1	
1 0 1	1 0 0 0	88.	Incompatible destination	Incompatible parameter (Note 2)	
1 0 1	1 0 1 1	91.	Invalid transit network selection	-	
1 0 1	1 1 1 1	95.	Semantically incorrect message	-	
1 1 0	0 0 0 0	96.	Invalid mandatory information	Information element identifier(s)	
1 1 0	0 0 0 1	97.	Message type non-existent or not implemented	Message type	
1 1 0	0 0 1 0	98.	Message type not compatible with protocol state	Message type	
1 1 0	0 0 1 1	99.	Information element non-existent or not implemented	Information element identifier(s) (notes 6,7)	
1 1 0	0 1 0 0	100.	Conditional IE error	Information element identifier(s) (note 6)	
1 1 0	0 1 0 1	101.	Message not compatible with protocol state	Message type	
1 1 0	0 1 1 0	102.	Recovery on timer expiry	Timer number (note 8)	
1 1 0	1 1 1 1	111.	Protocol error, unspecified	-	
1 1 1	1 1 1 1	127.	Interworking, unspecified	-	

All other values in the range 0 to 31 shall be treated as cause 31.

All other values in the range 32 to 47 shall be treated as cause 47.

All other values in the range 48 to 63 shall be treated as cause 63.

All other values in the range 64 to 79 shall be treated as cause 79.

All other values in the range 80 to 95 shall be treated as cause 95.

All other values in the range 96 to 111 shall be treated as cause 111.

All other values in the range 112 to 127 shall be treated as cause 127.

**Table 10.86/GSM 04.08:  
Cause information element values (continued)**

NOTE 1: Diagnostics for supplementary services are handled as follows:

octet 5, bit 8:

This is an extension bit as defined in the preliminary part of section 10.5. In this version of this protocol, this bit shall be set to 1. If it is set to zero, the contents of the following octets shall be ignored.

octet 5, bit 7-1:

0000001 - Outgoing calls barred within CUG  
 0000010 - No CUG selected  
 0000011 - Unknown CUG index  
 0000100 - CUG index incompatible with requested basic service  
 0000101 - CUG call failure, unspecified  
 0000110 - CLIR not subscribed

All other values shall be ignored.

NOTE 2: The incompatible parameter is composed of the incompatible information element identifier.

NOTE 3: The format of the diagnostic field for cause numbers 57, 58 and 65 is as shown in figure 10.71/GSM 04.08 and tables 10.7248a/GSM 04.08 to 10.79/GSM 04.08.

NOTE 4: The user supplied diagnostics field is encoded according to the user specification, subject to the maximum length of the cause information element. The coding of user supplied diagnostics should be made in such a way that it does not conflict with the coding described in note 9 below.

NOTE 5: The new destination is formatted as the called party BCD number information element, including information element identifier.

NOTE 6: Locking and non-locking shift procedures described in sections 10.5.4.2 and 3 are applied. In principle, information element identifiers are ordered in the same order as the information elements in the received message.

NOTE 7: When only the locking shift information element is included and no information element identifier follows, it means that the codeset in the locking shift itself is not implemented.

NOTE 8: The timer number is coded in IA5 characters, e.g., T308 is coded as "3" "0" "8". The following coding is used in each octet:

bit 8 : spare "0"  
 bits 7-1 : IA5 character

Octet 5 carries "3", octet 5a carries "0", etc.

NOTE 9: The following coding is used for octet 5:

bit 8 : 1  
 bits 7-3 : 00000  
 bits 2-1 : condition as follows:  
 00 - unknown  
 01 - permanent  
 10 - transient

### 10.5.4.11a CLIR suppression

The CLIR suppression information element may be sent by the mobile station to the network in the SETUP message. The use is defined in GSM 04.81.

The CLIR suppression information element is coded as shown in figure 10.78/GSM 04.08.

The CLIR suppression is a type 2 information element.

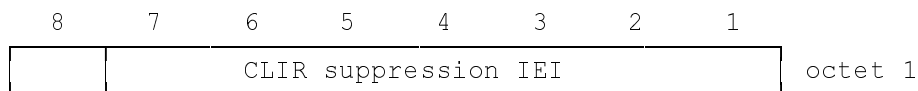

**Figure 10.78/GSM 04.08:  
CLIR suppression information element**

### 10.5.4.11b CLIR invocation

The CLIR invocation information element may be sent by the mobile station to the network in the SETUP message. The use is defined in GSM 04.81.

The CLIR invocation information element is coded as shown in figure 10.78a/GSM 04.08.

The CLIR invocation is a type 2 information element.

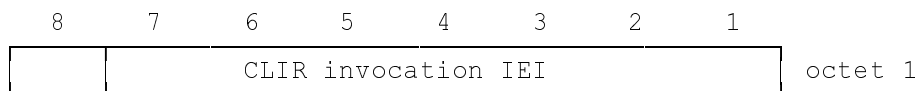

**Figure 10.78a/GSM 04.08:  
CLIR invocation information element**

**10.5.4.12 Congestion level**

The purpose of the congestion level information element is to describe the congestion status of the call.

The congestion level information element is coded as shown in figure 10.79/GSM 04.08 and table 10.87/GSM 04.08.

The congestion level is a type 1 information element.

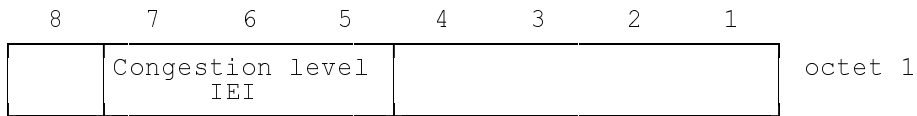

**Figure 10.79/GSM 04.08:  
 Congestion level information element**

Congestion level (octet 1) bits 4 3 2 1 0 0 0 0      receiver ready 1 1 1 1      receiver not ready All other values are reserved.
---

**Table 10.87/GSM 04.08:  
 Congestion level information element**

**10.5.4.13 Connected number**

The purpose of the connected number information element is to identify the connected party of a call.

The connected number information element is coded as shown in figure 10.80/GSM 04.08

The connected number is a type 4 information element with a minimum length of 3 octets and a maximum length of 14 octets.

8	7	6	5	4	3	2	1		
Connected number IEI								octet 1	
Length of connected number contents								octet 2	
0/1 ext	Type of number			Number plan identification				octet 3 note 1)	
1 ext	Presentation indicator	0	0	0	Spare			Screening indicator	octet 3a* note 1)
Number digit 2				Number digit 1				octet 4* note 1)	
Number digit 4				Number digit 3				octet 5* note 1)	
note 2)								: : :	

**Figure 10.80/GSM 04.08**

The contents of octets 3,4,5, etc. are coded as shown in table 10.81/GSM 04.08. The coding of octet 3a is defined in table 10.83/GSM 04.08.

If the connected number contains an odd number of digits, bits 5 to 8 of the last octet shall be filled with the end mark coded as "1111".

#### 10.5.4.14 Connected subaddress

The purpose of the connected subaddress information element is to identify a subaddress associated with the connected party of a call.

The connected subaddress information element is coded as shown in figure 10.81/GSM 04.08

The connected subaddress is a type 4 information element with a minimum length of 2 octets and a maximum length of 23 octets.

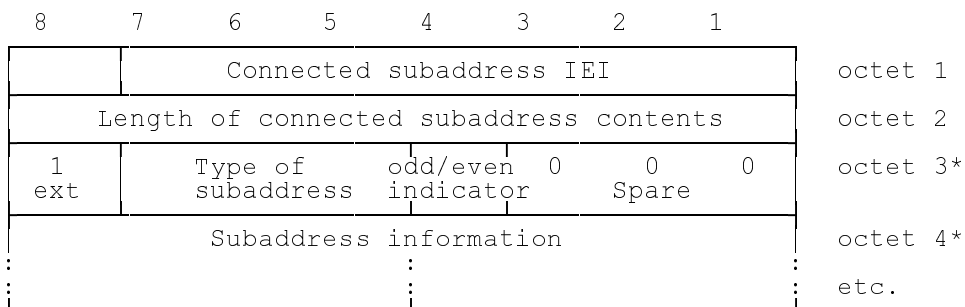

**Figure 10.81/GSM 04.08**

The coding for Type of subaddress, odd/even indicator, and subaddress information is in table 10.82/GSM 04.08.

#### 10.5.4.15 Facility

The purpose of the facility information element is to transport supplementary service related information. Within the scope of GSM 04.08 the content of the Facility information field is an array of octets. The usage of this transportation mechanism is defined in GSM 04.80.

The facility information element is coded as shown in figure 10.82/GSM 04.08.

The facility is a type 4 information element with a minimum length of 2 octets. No upper length limit is specified except for that given by the maximum number of octets in a L3 message (see GSM 04.06).

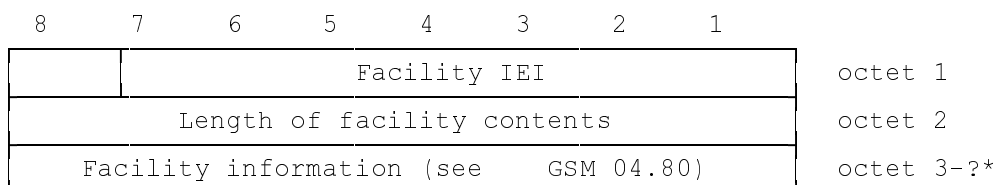

**Figure 10.82/GSM 04.08**

**10.5.4.16 High layer compatibility**

The purpose of the high layer compatibility information element is to provide a means which should be used by the remote user for compatibility checking (see annex B).

The high layer compatibility information element is coded as shown in figure 10.83/GSM 04.08 and table 10.88/GSM 04.08.

The high layer compatibility is a type 4 information element with a minimum length of 2 octets and a maximum length of 5 octets.

NOTE: The high layer compatibility information element is transported transparently by a PLMN between a call originating entity (e.g. a calling user) and the addressed entity (e.g. a remote user or a high layer function network node addressed by the call originating entity). However, if explicitly requested by the user (at subscription time), a network which provides some capabilities to realize teleservices may interpret this information to provide a particular service.

8	7	6	5	4	3	2	1	
High layer compatibility IEI								octet 1
Length of high layer compatibility contents								octet 2
1 ext	coding standard	interpretation			presentat. method of protocol profile			octet 3*
0/1 ext	High layer characteristics identification							octet 4*
1 ext	Extended high layer characteristics identification							octet 4a* (note)

**Figure 10.83/GSM 04.08:  
 High layer compatibility information element**

If the value part of the IE is empty, the IE indicates "not applicable".

NOTE: Octet 4a may be present e.g. when octet 4 indicates Maintenance or Management.



Coding standard (octet 3)  
see CCITT Recommendation Q.931.

Interpretation (octet 3)  
see CCITT Recommendation Q.931.

Presentation method of protocol profile (octet 3)  
see CCITT Recommendation Q.931.

High layer characteristics identification (octet 4)  
see CCITT Recommendation Q.931.

Extended high layer characteristics identification  
(octet 4a)  
see CCITT Recommendation Q.931.

**Table 10.88/GSM 04.08:  
High layer compatibility information element**

**10.5.4.16.1      Static conditions for the high layer compatibility IE contents**

Either the value part of the IE is empty, or it contains at least octet 3 and 4.

**10.5.4.17 Keypad facility**

The purpose of the keypad facility information element is to convey IA5 characters, e.g. entered by means of a terminal keypad (see note).

The keypad facility information element is coded as shown in figure 10.84/GSM 04.08.

The keypad facility is a type 3 information element with 2 octets length.

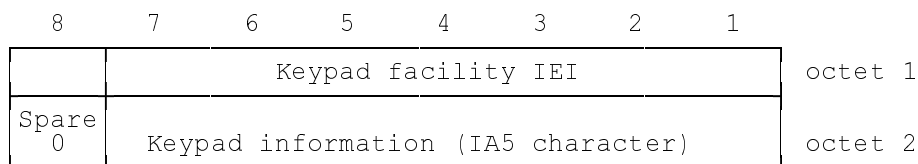

**Figure 10.84/GSM 04.08:  
 Keypad facility information element**

NOTE: In the GSM system this information element is only used to transfer one DTMF digit (0, 1, ... , 9, A, B, C, D, \*, #) as one IA5 character.

**10.5.4.18 Low layer compatibility**

The purpose of the low layer compatibility information element is to provide a means which should be used for compatibility checking by an addressed entity (e.g., a remote user or an interworking unit or a high layer function network node addressed by the calling user). The low layer compatibility information element is transferred transparently by a PLMN between the call originating entity (e.g. the calling user) and the addressed entity.

Except for the information element identifier, the low layer compatibility information element is coded as in ETS 300 102-1.

The low layer compatibility is a type 4 information element with a minimum length of 2 octets and a maximum length of 15 octets.

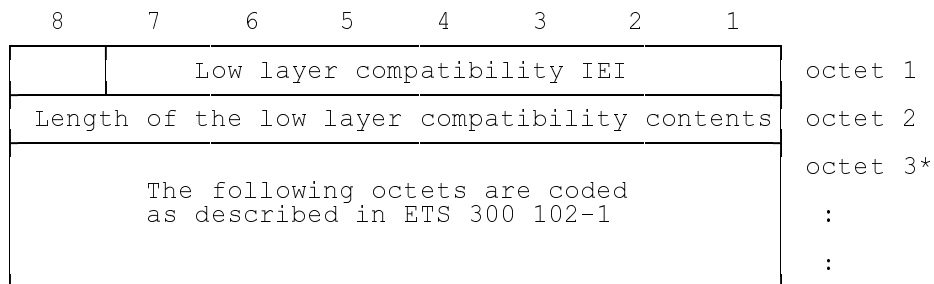

**Figure 10.85/GSM 04.08:  
 Low layer compatibility information element**

If the value part of the IE is empty, the IE indicates "not applicable".

**10.5.4.19 More data**

The more data information element is sent by the mobile station to the network or to the network to the mobile station in a USER INFORMATION message. The presence of the more data information element indicates to the destination remote user/mobile station that another USER INFORMATION message will follow containing information belonging to the same block.

The use of the more data information element is not supervised by the network.

The more data information element is coded as shown in figure 10.86/GSM 04.08.

The more data is a type 2 information element.

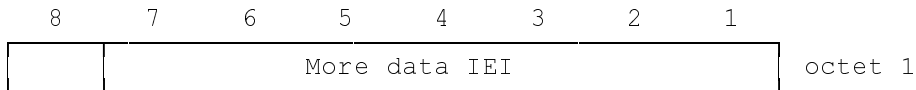

**Figure 10.86/GSM 04.08:  
 More data information element**

**10.5.4.20 Notification indicator**

The purpose of the notification indicator information element is to indicate information pertaining to a call.

The notification indicator element is coded as shown in figure 10.87/GSM 04.08 and table 10.89/GSM 04.08.

The notification indicator is a type 3 information element with 2 octets length.

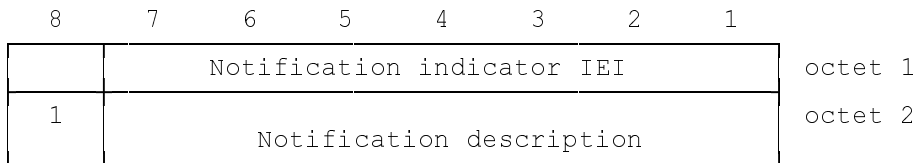

**Figure 10.87/GSM 04.08:  
 Notification indicator information element**

Notification description (octet 2)							
Bits							
7	6	5	4	3	2	1	
0	0	0	0	0	0	0	User suspended
0	0	0	0	0	0	1	User resumed
0	0	0	0	1	0		Bearer change
All other values are reserved.							

**Table 10.89/GSM 04.08:  
 Notification indicator information element**

**10.5.4.21 Progress indicator**

The purpose of the progress indicator information element is to describe an event which has occurred during the life of a call.

The progress indicator information element is coded as shown in figure 10.88/GSM 04.08 and table 10.90/GSM 04.08.

The progress indicator is a type 4 information element with a length of 4 octets.

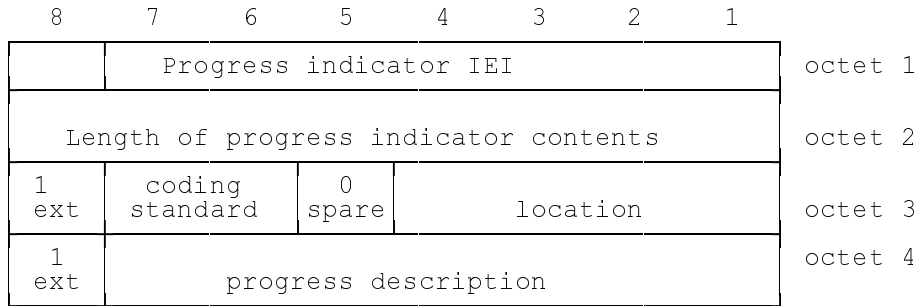

**Figure 10.88/GSM 04.08:  
 Progress indicator information element**

Coding standard (octet 3)		
Bits		
7 6		
0 0	Standardized coding, as described in CCITT Rec. Q.931	
0 1	Reserved for other international standards	
1 0	National standard	
1 1	Standard defined for the GSM PLMNS as described below	
Coding standards other than "1 1 - Standard defined for the GSM PLMNS" shall not be used if the progress description can be represented with the GSM standardized coding.		
The mobile station or network need not support any other coding standard than "1 1 - Standard defined for the GSM PLMNS".		
If a progress indicator IE indicating a coding standard not supported by the receiver is received, progress description "Unspecific" shall be assumed.		
Location (octet 3)		
Bits		
4 3 2 1		
0 0 0 0	User	
0 0 0 1	Private network serving the local user	
0 0 1 0	Public network serving the local user	
0 1 0 0	Public network serving the remote user	
0 1 0 1	Private network serving the remote user	
1 0 1 0	Network beyond interworking point	
All other values are reserved.		
Note:	Depending on the location of the users, the local public network and remote public network may be the same network.	
Progress description (octet 4)		
Bits		
7 6 5 4 3 2 1	No.	
0 0 0 0 0 0 1	1.	Call is not end-to-end PLMN/ISDN, further call progress information may be available in-band
0 0 0 0 0 1 0	2.	Destination address in non-PLMN/ISDN
0 0 0 0 0 1 1	3.	Origination address in non-PLMN/ISDN
0 0 0 0 1 0 0	4.	Call has returned to the PLMN/ISDN
0 0 0 1 0 0 0	8.	In-band information or appropriate pattern now available
0 1 0 0 0 0 0	32.	Call is end-to-end PLMN/ISDN
All other values		Unspecific

**Table 10.90/GSM 04.08:  
Progress indicator information element**

**10.5.4.22 Repeat indicator**

The purpose of the repeat indicator information element is to indicate how the associated repeated information elements shall be interpreted, when included in a message. The repeat indicator information element is included immediately before the first occurrence of the associated information element which will be repeated in a message. "Mode 1" refers to the first occurrence of that information element, "mode 2" refers to the second occurrence of that information element in the same message.

The repeat indicator information element is coded as shown in figure 10.89/GSM 04.08 and table 10.91/GSM 04.08.

The repeat indicator is a type 1 information element.

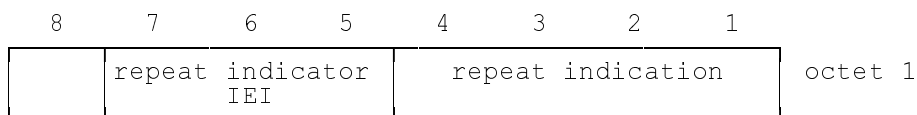

**Figure 10.89/GSM 04.08:  
 Repeat indicator information element**

Repeat indication (octet 1)	
Bits	
4 3 2 1	
0 0 0 1	Circular for successive selection "mode 1 alternate mode 2"
0 0 1 1	Sequential for successive selection "mode 1 and then mode 2"
All other values are reserved.	

**Table 10.91/GSM 04.08:  
 Repeat indicator information element**

**10.5.4.22a Reverse call setup direction**

This information element may be included in a MODIFY and MODIFY COMPLETE message to indicate that the direction of the data call to which the MODIFY message relates is opposite to the call setup direction.

The *reverse call setup direction* information element is coded as shown in figure 10.89a/GSM 04.08.

The *reverse call setup direction* is a type 2 information element

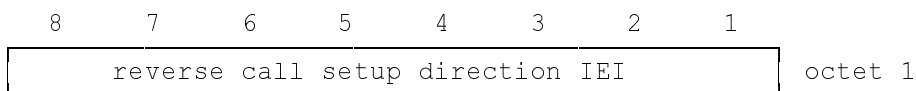

**Figure 10.89a/GSM 04.08:  
 Reverse call setup direction information element**

**10.5.4.23 Signal**

The purpose of the signal information element is to allow the network to convey information to a user regarding tones and alerting signals (see sections 5.2.2.3.2 and 7.3.3).

The signal information element is coded as shown in figure 10.90/GSM 04.08 and table 10.92/GSM 04.08.

The signal is a type 3 information element with 2 octets length.

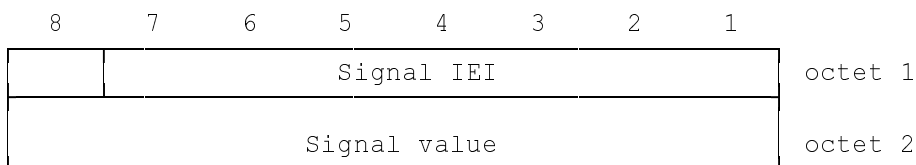

**Figure 10.90/GSM 04.08:  
 Signal information element**

Signal value (octet 2)								
Bits								
8	7	6	5	4	3	2	1	
0	0	0	0	0	0	0	0	dial tone on
0	0	0	0	0	0	0	1	ring back tone on
0	0	0	0	0	0	1	0	intercept tone on
0	0	0	0	0	0	1	1	network congestion tone on
0	0	0	0	0	1	0	0	busy tone on
0	0	0	0	0	1	0	1	confirm tone on
0	0	0	0	0	1	1	0	answer tone on
0	0	0	0	0	1	1	1	call waiting tone on
0	0	0	0	1	0	0	0	off-hook warning tone on
0	0	1	1	1	1	1	1	tones off
0	1	0	0	1	1	1	1	alerting off
All other values are reserved.								

**Table 10.92/GSM 04.08:  
 Signal information element**

**10.5.4.24 SS Version Indicator**

The purpose of the SS version indicator information element is to aid the decoding of the Facility information element as described in GSM 04.10. Within the scope of GSM 04.08 the contents of the SS Version information field is an array of one or more octets. The usage of the SS version information field is defined in GSM 04.80.

The SS version indicator information element is coded as shown in figure 10.91/GSM 04.08.

The SS version indicator is a type 4 information element with a minimum length of 2 octets. No upper length limit is specified except for that given by the maximum number of octets in a L3 message (see GSM 04.06).

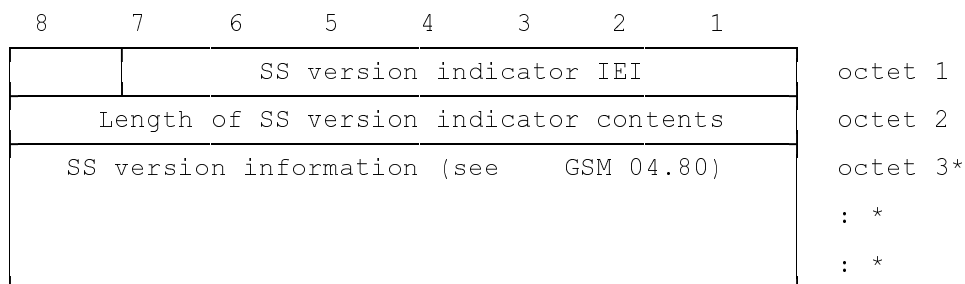

**Figure 10.91/GSM 04.08**

NOTE: Usually, this information element has only one octet of content.



**10.5.4.25 User-user**

The purpose of the user-user information element is to convey information between the mobile station and the remote ISDN user.

The user-user information element is coded as shown in figure 10.92/GSM 04.08 and table 10.93/GSM 04.08. There are no restrictions on the content of the user-user information field.

The user-user is a type 4 information element with a minimum length of 3 octets and a maximum length of either 35 or 131 octets. In the SETUP, ALERTING, CONNECT, DISCONNECT, RELEASE and RELEASE COMPLETE messages, the user-user information element has a maximum size of 35 octets in a GSM PLMN. In USER INFORMATION messages the user-user information element has a maximum size of 131 octets in a GSM PLMN.

In other networks than GSM PLMNs the maximum size of the user-user information element is 35 or 131 octets in the messages mentioned above. The evolution to a single maximum value is the long term objective; the exact maximum value is the subject of further study.

NOTE: The user-user information element is transported transparently through a GSM PLMN.

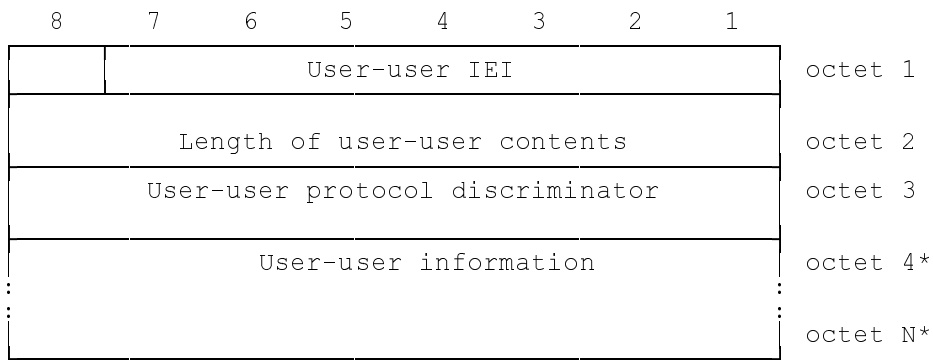

**Figure 10.92/GSM 04.08:  
 User-user information element**

User-user protocol discriminator (octet 3)								
Bits								
8	7	6	5	4	3	2	1	
0	0	0	0	0	0	0	0	User specific protocol (Note 1)
0	0	0	0	0	0	0	1	OSI high layer protocols
0	0	0	0	0	0	0	1	X.244 (Note 2)
0	0	0	0	0	0	1	1	Reserved for system management convergence function
0	0	0	0	0	1	0	0	IA5 characters (Note 3)
0	0	0	0	0	1	1	1	Rec.V.120 rate adaption
0	0	0	0	1	0	0	0	Q.931 (I.451) user-network call control messages
0	0	0	1	0	0	0	0	Reserved for other network layer or layer 3 protocols including Rec.X.25 (Note 4)
through								
0	0	1	1	1	1	1	1	
0	1	0	0	0	0	0	0	National use
through								
0	1	0	0	1	1	1	1	
0	1	0	1	0	0	0	0	Reserved for other network layer or layer 3 protocols including Rec.X.25 (Note 4)
through								
1	1	1	1	1	1	1	0	

All other values are reserved

Note 1: The user information is structured according to user needs.

Note 2: The user information is structured according to Rec.X.244 which specifies the structure of X.25 call user data.

Note 3: The user information consists of IA5 characters.

Note 4: These values are reserved to discriminate these protocol discriminators from the first octet of a X.25 packet including general format identifier.

**Table 10.93/GSM 04.08:  
User-user information element**

## 11 List of system parameters

The description of timers in the following table should be considered a brief summary. The precise details are found in sections 3 to 6, which should be considered the definitive descriptions.

### 11.1 Timers and counters for radio resource management

#### 11.1.1 Timers on the MS side

T3122: This timer is used during random access, after the receipt of an IMMEDIATE ASSIGN REJECT message.

Its value is given by the network in the IMMEDIATE ASSIGN REJECT message.

T3124: This timer is used in the seizure procedure during a hand-over, when the two cells are not synchronized.

Its purpose is to detect the lack of answer from the network to the special signal.

Its value is set to 675 ms if the channel type of the channel allocated in the HANDOVER COMMAND is an SDCCH (+ SACCH); otherwise its value is set to 320ms.

T3126: This timer is started either:

after sending the maximum allowed number of CHANNEL REQUEST messages during an immediate assignment procedure;

or

on receipt of an IMMEDIATE ASSIGNMENT REJECT message;

whichever occurs first.

It is stopped at receipt of an IMMEDIATE ASSIGNMENT message, or an IMMEDIATE ASSIGNMENT EXTENDED message.

At its expiry, the immediate assignment procedure is aborted.

The minimum value of this timer is equal to the time taken by T+2S slots of the mobile station's RACH. S and T are defined in section 3.3.1.2. The maximum value of this timer is 5 seconds.

T3110: This timer is used to delay the channel deactivation after the receipt of a (full) CHANNEL RELEASE. Its purpose is to let some time for disconnection of the main signalling link.

Its value is set to such that the DISC frame is sent twice in case of no answer from the network. (It should be chosen to obtain a good probability of normal termination (i.e. no time out of T3109) of the channel release procedure.)

#### 11.1.2 Timers on the network side

T3101: This timer is started when a channel is allocated with an IMMEDIATE ASSIGNMENT message. It is stopped when the MS has correctly seized the channels.

Its value is network dependent.

NOTE 1: It could be higher than the maximum time for a L2 establishment attempt.

T3103: This timer is started by the sending of a HANOVER message and is normally stopped when the MS has correctly seized the new channel. Its purpose is to keep the old channels sufficiently long for the MS to be able to return to the old channels, and to release the channels if the MS is lost.

Its value is network dependent.

NOTE 2: It could be higher than the maximum transmission time of the HANOVER COMMAND, plus the value of T3124, plus the maximum duration of an attempt to establish a data link in multiframe mode.

T3105: This timer is used for the repetition of the PHYSICAL INFORMATION message during the hand-over procedure.

Its value is network dependent.

NOTE 3: This timer may be set to such a low value that the message is in fact continuously transmitted.

T3107: This timer is started by the sending of an ASSIGNMENT COMMAND message and is normally stopped when the MS has correctly seized the new channels.

Its purpose is to keep the old channel sufficiently long for the MS to be able to return to the old channels, and to release the channels if the MS is lost.

Its value is network dependent.

NOTE 4: It could be higher than the maximum transmission time of the ASSIGNMENT COMMAND message plus twice the maximum duration of an attempt to establish a data link multiframe mode.

T3109: This timer is started when a lower layer failure is detected by the network, when it is not engaged in a RF procedure. It is also used in the channel release procedure.

Its purpose is to release the channels in case of loss of communication.

Its value is network dependent.

NOTE 5: Its value should be large enough to ensure that the mobile station detects a radio link failure.

T3111: This timer is used to delay the channel deactivation after disconnection of the main signalling link. Its purpose is to let some time for possible repetition of the disconnection.

Its value is equal to the value of T3110.

T3113: This timer is started when the network has sent a PAGING REQUEST message and is stopped when the network has received the PAGING RESPONSE message.

Its value is network dependent.

NOTE 6: The value could allow for repetitions of the Channel Request message and the requirements associated with T3101.

### 11.1.3 Other parameters

Ny1: The maximum number of repetitions for the PHYSICAL INFORMATION message during a handover (see section 3.4.4.2.2). The value is network dependent.

### 11.2 Timers of mobility management

TIMER NUM.	MM STATE	TIME OUT VAL.	CAUSE FOR START	NORMAL STOP	AT THE EXPIRY
T3210	3	20s	-LOC_UPD_REQ sent	- LOC_UPD_ACC - LOC_UPD_REJ - AUTH_REJ - Lower layer failure	Start T3211
T3211	1 2	15s	-LOC_UPD_REJ with cause #17 netw. failure -lower layer failure or RR conn. released after RR conn. abort during loc. updating	- Time out - cell change - request for MM connection establishment - change of LA	Restart the Location update proc.
T3212	1, 2	Note 1	-termination of MM service or MM signalling	-initiation of MM service or MM signalling	initiate periodic updating
T3213	1 2 11	4s	-location updating failure	- expiry - change of BCCH parameter	new random attempt
T3220	7	5s	-IMSI DETACH	- release from RM-sublayer	enter Null or Idle, ATTEMPTING TO UPDATE
T3230	5	15s	-CM SERV REQ CM REEST REQ	- Cipher mode setting - CM SERV REJ - CM SERV ACC	provide release ind.
T3240	9 10	10s	see section 11.2.1	see section 11.2.1	abort the RR connection

**Table 11.1/GSM 04.08:**  
**Mobility management timers - MS-side**

NOTE 1: The time-out value is broadcasted in a SYSTEM INFORMATION message.

TIMER NUM.	MM ST AT	TIME OUT VAL.	CAUSE FOR START	NORMAL STOP	AT THE FIRST EXPIRY	AT THE SECOND EXPIRY
T3250	6	5s	TMSI-REAL-CMD or LOC UPD ACC with new TMSI sent	TMSI-REAL-COM received	Optionally Release RR connection	
T3255		Note	LOC UPD ACC sent with "Follow on Proceed"	CM SERVICE REQUEST	Release RR Connection or use for mobile station terminating call	
T3260	5	5s	AUTHENT-REQUEST sent	AUTHENT-RESPONSE received	Optionally Release RR connection	
T3270	4	5s	IDENTITY REQUEST sent	IDENTITY RESPONSE received	Optionally Release RR connection	

**Table 11.2/GSM 04.08:  
Mobility management timers - network-side**

NOTE 2: The value of this timer is not specified by this recommendation.

### 11.2.1 Timer T3240

Timer T3240 is started in the mobile station when:

- the mobile station receives a LOCATION UPDATING ACCEPT message completing a location updating procedure in the cases specified in sections 4.4.4.6 and 4.4.4.8;
- the mobile station receives a LOCATION UPDATING REJECT message in the cases specified in section 4.4.4.7;
- the mobile station has sent a CM SERVICE ABORT message as specified in section 4.5.1.7;
- the mobile station has released or aborted all MM connections in the cases specified in sections 4.3.2.5, 4.3.5.2, 4.5.1.1, and 4.5.3.1.

Timer T3240 is stopped, reset, and started again at receipt of an MM message.

Timer T3240 is stopped and reset (but not started) at receipt of a CM message that initiates establishment of an CM connection (an appropriate SETUP, REGISTER, or CP-DATA message as defined in GSM 04.08, GSM 04.10 or GSM 04.11).

**11.3 Timers of circuit-switched call control**

TIM. NUM.	TIM VAL	STATE OF CALL	CAUSE OF START	NORMAL STOP	AT FIRST EXPIRY	AT SECOND EXPIRY
T303	30s	Call initiated	CM SER RQ sent	CALL PROC, or REL COMP received	Clear the call	Timer is not restarted
T305	30s	Disconnect Request	DISC sent	REL or DISC received	REL sent.	Timer is not restarted
T308	30s	Release request	REL sent	REL COMP or REL received	Retrans. RELEASE restart T308	Call ref. release
T310 Note 1	30s	Outgoing call Proceeding	CALL PROC received	ALERT, CONN, DISC or PROG rec.	Send DISC	Timer is not restarted
T313	30s	Connect Request	CONN sent	CONNECT ACKnowledge received	Send DISC	Timer is not restarted
T323	30s	Modify Request	MOD sent	MOD COMP or MOD REJ received	Clear the call	Timer is not restarted

**Table 11.3/GSM 04.08:  
Call control timers - MS side**

NOTE 1: T310 is not started if progress indicator #1 or #2 has been delivered in the CALL PROCEEDING message or in a previous PROGRESS message.

TIM. NUM.	DFT TIM VAL	STATE OF CALL	CAUSE FOR START	NORMAL STOP	AT FIRST EXPIRY	AT SECON EXPIRY
T301 Note 1	Min 180s	Call received	ALERT received	CONN received	Clear the call	Timer is not restarted
T303	Note 2	Call present	SETUP sent	CALL CONF or REL COMP received	Clear the call	Timer is not restarted
T305	30s	Disconnect Indication	DISC without progress indic. #8 sent	REL or DISC received	Network sends RELEASE	Timer is not restarted
T306	30s	Disconnect Indication	DISC with progress indic. #8 sent	REL or DISC received	Stop the tone/ announc. Send REL	Timer is not restarted
T308	Note 2	Release request	REL sent	REL COMP or REL received	Retrans. RELEASE restart T308	Release call reference
T310	Note 2	Incoming call proceeding	CALL CONF received	ALERT, CONN or DISC received	Clear the call	Timer is not restarted
T313	Note 2	Connect Indication	CON sent	CON ACK received	Clear the call	Timer is not restarted
T323	30s	Modify request	MOD sent	MOD COMP or MOD REJ received	Clear the call	Timer is not restarted

**Table 11.4/GSM 04.08:  
Call control timers - network side**

NOTE 2: The network may already have applied an internal alerting supervision function; e.g. incorporated within call control. If such a function is known to be operating on the call, then timer T301 is not used.

NOTE 3: These time values are set by the network operator.



## Annex A (informative): Example of subaddress information element coding

This annex is informative.

This annex gives an example of how the Called Party Subaddress IE is encoded to carry subaddress digits that use IA5 characters. This example is also applicable to the Calling Party Subaddress IE.

8	7	6	5	4	3	2	1	octet
0	1	1	0	1	1	0	1	1
called party subaddress IEI								
0	0	0	0	0	1	1	1	2
Length								
1 not ext	0	0	0	X	0	0	0	3
NSAP (X.213/ISO 8348 AD2)				odd/ev note 1	note 2			
0	1	0	1	0	0	0	0	4
AFI (note 3)								
IA5 Character (note 4)								5
IA5 Character (note 4)								6
IA5 Character (note 4)								9, note 5

NOTE 1: The value of this bit has no significance when the type of subaddress is "NSAP".

NOTE 2: These bits are spare.

NOTE 3: The Authority and Format Identifier code 50 (in BCD) indicates that the subaddress consists of IA5 characters (see ISO standard 8348 AD2).

NOTE 4: IA5 character as defined in CCITT Recommendation T.50/ISO 646 and then encoded into two semi-octets according to the "preferred binary encoding" defined in X.213/ISO 8348 AD2. (Each character is converted into a number in the range 32 to 127 using the ISO 646 encoding with zero parity and the parity bit in the most significant position. This number is then reduced by 32 to give a new number in the range 0 to 95. The new number is then treated as a pair of decimal digits with the value of each digit being encoded in a semi-octet.)

NOTE 5: the number of IA5 characters in the subaddress may vary, subject to an upper limit of 19 IA5 characters.

## **Annex B (normative): COMPATIBILITY CHECKING**

This annex is normative.

### **B.1 Introduction**

This annex describes the various compatibility checks which shall be carried out to ensure that the best matched MS and network capabilities are achieved on a call between a PLMN and the ISDN.

Three different processes of compatibility checking shall be performed:

- i) at the user-to-network interface on the calling side (see section B.2);
- ii) at the network-user interface on the called side (see section B.3.2);
- iii) user-to-user (see section B 3.3).

NOTE: In this context and throughout this annex the term "called user" is the end point entity which is explicitly addressed.

For details on the coding of the information required for compatibility checking, see annex C.

### **B.2 Calling side compatibility checking**

#### **B.2.1 Compatibility checking of the CM SERVICE REQUEST message**

The network shall check if the service requested in the CM SERVICE REQUEST message is permitted for that subscriber.

#### **B.2.2 Compatibility/Subscription checking of the SETUP message**

At the calling side the network shall check that the basic service(s) requested by the calling MS in the Bearer Capability information element(s) match(es) with the basic services provided to that subscriber by the PLMN. If for at least one bearer capability information element contained in the SETUP message a mismatch is detected, then the network shall proceed as follows:

- if the SETUP message contained two bearer capability information elements for only one of which a mismatch is detected, the network shall either:
  - under the conditions specified in GSM 07.01 (e.g. TS 61 and TS 62), accept the SETUP message with a CALL PROCEEDING message containing the, possibly negotiated, bearer capability information element for which no mismatch is detected; or
  - reject the call using one of the causes listed in annex H.
- otherwise the network shall reject the call using one of the causes listed in annex H.

Network services are described in GSM 02.02 and GSM 02.03 as bearer services and teleservices, respectively.

### **B.3 Called side compatibility checking**

In this section, the word "check" means that the MS examines the contents of the specified information element.

#### **B.3.1 Compatibility checking with addressing information**

If an incoming SETUP message is offered to the MS with addressing information (i.e. sub-address or called party number) the following shall occur:

- a) if the MS has a DDI number or a sub-address, then the information in any Called Party BCD Number or any Called Party subaddress information elements of the incoming SETUP message shall be checked by the MS against the corresponding part of the number assigned to the user (e.g. for DDI) or the user's own sub-address.

In the cases of a mismatch, the MS shall release the call. In the case of a match, the compatibility checking described in sections B.3.2 and B.3.3 shall be performed.

- b) if the MS has no DDI number and no sub-address, then the Called Party BCD Number and Called Party Sub-address information element shall be ignored for the purposes of compatibility checking. The compatibility checking described in sections B.3.2 and B.3.3 shall be performed.

NOTE: According to the user's requirements, compatibility checking can be performed in various ways from the viewpoint of execution order and information to be checked, e.g. first DDI number/sub-address and then bearer capability or vice versa.

### **B.3.2 Network-to-MS compatibility checking**

When the network is providing a basic service at the called side, the MS shall check that the basic service(s) offered by the network in the Bearer Capability information element(s) match(es) the basic services that the MS is able to support. If a mismatch is detected, then the MS shall proceed as follows:

- if the SETUP message contained two bearer capability information elements for only one of which a mismatch is detected, the MS shall either:
  - under the conditions specified in GSM 07.01 (e.g. TS 61 and TS 62), accept the SETUP message with a CALL CONFIRMED message containing the, possibly negotiated, bearer capability information element for which no mismatch is detected; or
  - reject the call using cause No. 88 "incompatible destination".
- otherwise the MS shall reject the offered call using a RELEASE COMPLETE message with cause No. 88 "incompatible destination".

When interworking with existing networks, limitations in network or distant user signalling (e.g. in the case of an incoming call from a PSTN or a call from an analogue terminal) may restrict the information available to the called MS in the incoming SETUP message (e.g. missing Bearer Capability Information Element or missing High Layer Compatibility Information Element). For compatibility checking, and handling of such calls, see GSM 07.01.

### **B.3.3 User-to-User compatibility checking**

See GSM 07.01.

### **B.4 High layer compatibility checking**

See GSM 07.01.

## **Annex C (normative): Low layer information coding principles**

This annex is normative.

### **C.1 Purpose**

This annex describes principles that shall be used when the calling MS specifies information during call setup regarding low layer capabilities required in the network and by the destination terminal. Refer also to GSM 07.01.

NOTE: In this context and throughout this annex the term "called user" is the end point entity which is explicitly addressed. This may also be an explicitly addressed interworking unit (IWU) (see CCITT I.500-Series Recommendations and CCITT Recommendation X.31 case a).

### **C.2 Principles**

#### **C.2.1 Definition of types of information**

There are three different types of information that the calling PLMN user may specify during call setup to identify low layer capabilities needed in the network and in the destination terminal:

- a) type I information is information about the calling terminal which is only used at the destination end to allow a decision regarding terminal compatibility. An example would be the user information layer 3 protocol. Type I information is encoded in octets 5 to 7 of the low layer compatibility information element;
- b) type II information is only used by the network (PLMN) to which the calling user is connected for selection of PLMN specific network resources, e.g. channel type or specific functionality within the interworking function (IWF, see GSM 09.07). This type of information is always present. An example is the connection element. Type II information is coded in:
  - i) octet 3 of the bearer capability information element when the information transfer capability required by the calling user is speech;
  - ii) octets 3, 4, 5, and optionally octet 7 of the bearer capability information element when the information transfer capability required by the calling user is not speech;
- c) type III information is required for selection of a basic service from the choice of basic services offered by the network and together with type II information for selection of an appropriate interworking function (IWF, see GSM 09.07), as well as for terminal compatibility checking at the destination terminal. An example is the information transfer capability. Type III information is always present and is encoded in:
  - i) octet 3 of the bearer capability information element when the information transfer capability required by the calling user is speech;
  - ii) octets 3, 5, 6, 6a, 6b and 6c of the bearer capability information element when the information transfer capability required by the calling user is not speech.

#### **C.2.2 Examination by network**

Type I information is user-to-user (i.e. at the calling side not examined by network) while type II and III information should be available for examination by the destination user and the network.

NOTE: In the case of a mobile terminated call, if the type II and type III information is not sufficient for the selection of an appropriate interworking function, the type I information will also be examined by the network.

### **C.2.3 Location of type I information**

Type I information (i.e. terminal information only significant to the called user) shall, when used, be included in the low layer compatibility information element.

### **C.2.4 Location of types II and III information**

Type II information is included in the bearer capability information element. Type III information is also included in the bearer capability information element. The network may use and modify type III information (e.g. to provide interworking).

In any case a modification of the bearer capability information element has to be performed when interworking to the fixed network (e.g. ISDN) is required, where the signalling of the radio interface has to be mapped to fixed network signalling (e.g. mapping of GSM BCIE to ISDN BCIE, see GSM 09.07).

### **C.2.5 Relationship between bearer capability and low layer compatibility information elements**

There shall be no contradiction of information between the low layer compatibility and the bearer capability at the originating side. However, as some bearer capability code points may be modified during the transport of the call (e.g. by the interworking function), this principle implies that there should be minimal duplication of information between the bearer capability information element and the low layer compatibility information element.

NOTE: If as a result of duplication, a contradiction occurs at the terminating side between the bearer capability information element and the low layer compatibility information element at the terminating side, the receiving entity shall ignore the conflicting information in the low layer compatibility information element.

## Annex D (informative): Examples of bearer capability information element coding

This annex is informative.

This annex gives examples of the coding of bearer capability information elements for various telecommunication services. This annex is included for information purposes only. In the case of any inconsistency between this annex and GSM 07.01 then GSM 07.01 shall take precedence over this annex.

### D.1 Coding for speech for a full rate support only mobile station

#### D.1.1 Mobile station to network direction

8	7	6	5	4	3	2	1	
0	0	0	0	0	1	0	0	octet 1
Bearer capability IEI								
0	0	0	0	0	0	0	1	octet 2
Length of the bearer capability contents								
1 not ext	0 full rate only	1 rate	0 GSM	0 circ. mode	0	0 speech	0	octet 3

#### D.1.2 Network to mobile station direction

8	7	6	5	4	3	2	1	
0	0	0	0	0	1	0	0	octet 1
Bearer capability IEI								
0	0	0	0	0	0	0	1	octet 2
Length of the bearer capability contents								
1 not ext	0 spare	1 spare	0 GSM	0 circ. mode	0	0 speech	0	octet 3

**D.2 An example of a coding for modem access with V22-bis, 2.4 kbit/s, 8 bit no parity**

**D.2.1 Mobile station to network direction**

8	7	6	5	4	3	2	1	
0	0	0	0	0	1	0	0	octet 1 Bearer capability IEI
0	0	0	0	0	1	1	1	octet 2 Length of the bearer capability contents
1 not ext	1	0	0	0	0	1	0	octet 3 dual, half preferred GSM circ. mode 3.1 kHz audio ex PLMN
1 not ext	0	0	0	1	0	0	0	octet 4 spare SDU integrity full pt to pt no de- NIRR mand
1 not ext	0	0	0	0	0	0	1	octet 5 access id. no rate adaption I.440/450
0 ext	0	1	0	0	0	0	1	octet 6 layer 1 default layer 1 async
0 ext	0	0	1	0	0	1	1	octet 6a 1 bit no neg 8 bits 2.4 kbit/s
0 ext	1	1	0	0	0	1	1	octet 6b 16 kbit/s inter. rate no NICTx no NICrx (parity) none
1 not ext	0	1	0	0	0	1	1	octet 6c non trans (RLP) V.22 bis

**D.2.2 Network to mobile station direction**

8	7	6	5	4	3	2	1	
0	0	0	0	0	1	0	0	octet 1
Bearer capability IEI								
0	0	0	0	0	1	1	1	octet 2
Length of the bearer capability contents								
1 not ext	0 spare	1 spare	0 GSM	0 circ. mode	0 3.1 kHz audio	1 ex PLMN	0	octet 3
1 not ext	0 spare	0 SDU integrity	0 full dupl.	1 pt to pt	0 no NIRR	0 de- mand	0	octet 4
1 not ext	0 access id.	0 no rate adaption	0 no rate adaption	0 I.440/450	0	0	1	octet 5
0 ext	0 layer 1	1 layer 1	0 default layer 1	0 default layer 1	0 default layer 1	0 default layer 1	1 async	octet 6
0 ext	0 1 bit	0 no neg	1 8 bits	0 2.4 kbit/s	0 2.4 kbit/s	1 2.4 kbit/s	1	octet 6a
0 ext	1 16 kbit/s inter. rate	1 no NICtx	0 no NICrx	0 (parity)	1 none	1 none	1	octet 6b
1 not ext	0 non trans (RLP)	1 non trans (RLP)	0 non trans (RLP)	0 non trans (RLP)	0 V.22 bis	1 V.22 bis	1	octet 6c



**D.3 An example of a coding for group 3 facsimile (9.6 kbit/s, transparent)**

**D.3.1 Mobile station to network direction**

8	7	6	5	4	3	2	1	
0	0	0	0	0	1	0	0	octet 1 Bearer capability IEI
0	0	0	0	0	1	1	1	octet 2 Length of the bearer capability contents
1 not ext	0	1	0	0	0	1	1	octet 3 full rate only MS GSM circ. mode facsimile group 3
1 not ext	0	1	1	1	0	0	0	octet 4 spare unstructured full dupl. pt to pt no NIRR demand
1 not ext	0	0	0	0	0	0	1	octet 5 access id. no rate adaption I.440/450
0 ext	0	1	0	0	0	0	0	octet 6 layer 1 default layer 1 sync
0 ext	0	0	1	0	1	0	1	octet 6a (syn) no neg (syn) 9.6 kbit/s
0 ext	1	1	0	0	0	1	1	octet 6b 16 kbit/s inter. rate no NICTx no NICrx (parity) none
1 not ext	0	0	0	0	0	0	0	octet 6c transparent none (modem type)

**D.3.2 Network to mobile station direction**

8	7	6	5	4	3	2	1	
0	0	0	0	0	1	0	0	octet 1
Bearer capability IEI								
0	0	0	0	0	1	1	1	octet 2
Length of the bearer capability contents								
1 not ext	0 spare	1 spare	0 GSM	0 circ. mode	0 3.1 kHz audio	1 ex PLMN	0	octet 3
1 not ext	0 spare	1 unstruc- tured	1 full dupl.	1 pt to pt	0 no NIRR	0 de- mand	0	octet 4
1 not ext	0 access id.	0	0 no rate adaption	0	0 I.440/450	1	0	octet 5
0 ext	0 layer 1	1	0 default layer 1	0	0	0	0 sync	octet 6
0 ext	0 (syn)	0 no neg	1 (syn)	0	1 9.6 kbit/s	0	1	octet 6a
0 ext	1 16 kbit/s inter. rate	1 no NICtx	0 no NICrx	0	0 (parity)	1 none	1	octet 6b
1 not ext	0 transparent	0	0	0	0	0	0 none (modem type)	octet 6c

**Annex E (informative): Comparison between call control procedures specified in technical specification GSM 04.08 and CCITT Recommendation Q.931**

This annex is informative.

This annex summarizes a comparison of the procedures for call control as specified in CCITT Recommendation Q.931 (blue book) and GSM 04.08.

If no comment is given, it means that the procedures specified in CCITT Recommendation Q.931 and GSM 04.08 are similar. However, it should be noted that even in such cases the procedures may be described in slightly different ways in the two documents.

Procedure	Q.931	GSM 04.08
Call establishment at the originating interface	5.1	5.2.1
- call request	5.1.1	5.2.1.1.1 en-bloc sending only
- B-channel selection originating	5.1.2	not applicable
- overlap sending	5.1.3	not supported
- invalid call information	5.1.4	5.2.1.1.2
- call proceeding, en-bloc sending	5.1.5.1	5.2.1.1.3
- call proceeding, overlap sending	5.1.5.2	not supported
- notification of interworking at the originating interf.	5.1.6	5.2.1.1.4
- call confirmation indication	5.1.7	5.2.1.1.5
- call connected	5.1.8	5.2.1.1.6
- call rejection	5.1.9	5.2.1.1.7
- transit network selection	5.1.10	5.2.1.1.8

**Table E.1/GSM 04.08:  
Circuit-switched call control procedures**

Procedure	Q.931	GSM 04.08
Call establishment at the destination interface	5.2	5.2.2
- call indication	5.2.1	5.2.2.1 procedure for multiple terminal configuration not required, i.e. delivery of SETUP messages on broadcast data links is not supported
- compatibility checking	5.2.2	5.2.2.2 equivalent, except that delivery of SETUP messages on broadcast data links is not supported
- B-channel selection destination	5.2.3	not applicable
- overlap receiving	5.2.4	not supported
- call confirmation information	5.2.5	5.2.2.3 equivalent, except that delivery of SETUP messages on broadcast data links is not supported
- notification of interworking at the terminating interf.	5.2.6	5.2.2.4
- call accept indication	5.2.7	5.2.2.5
- active indication	5.2.8	5.2.2.6 equivalent, except that SETUP messages are not sent on broadcast data links
- non-selected user clearing	5.2.9	not applicable

**Table E.1/GSM 04.08:  
Circuit-switched call control procedures (continued)**

Procedure	Q.931	GSM 04.08
Call clearing	5.3	5.4
- terminology	5.3.1	5.4.1 terminology adapted to GSM applications
- exception conditions	5.3.2	5.4.2 only case a) of section 5.3.2 of Rec. Q.931 ap- plies. All other excep- tions apply to functions which are not relevant to GSM
- clearing initiated by the user/MS	5.3.3	5.4.3
- clearing initiated by the network	5.3.4	5.4.4
- clearing when tones/announcements are provided	5.3.4.1	5.4.4.1 exception: if not already connected, the traffic channel is connected in order to provide the tone/announcement
- clearing when tones/announcements are not provided	5.3.4.2	5.4.4.2
- completion of clearing	5.3.4.3	5.4.4.3
Clear collision	5.3.5	5.4.5

**Table E.1/GSM 04.08:  
Circuit-switched call control procedures (continued)**

Procedure	Q.931	GSM 04.08
In-band tones and announcements	5.4	5.5.1
Restart procedure	5.5	not supported
Call rearrangements	5.6	5.3.4 call suspension/call re-establishment not supported on the radio path. The functions, if required, are to be supported locally in the MS. On the radio interface, the notification procedure of Rec. Q.931 (section 5.6.7) applies
Call collisions	5.7	5.5.2 call collisions cannot occur
Emergency call establishment at the originating interface	not specified not supported	5.2.1.2
In-call modification	annex O Rec. Q.931 is incomplete with regard to in-call modification procedures	5.3.4
DTMF protocol control procedures	not specified not supported	5.3.3
Call re-establishment	not specified not supported	5.5.4

**Table E.1/GSM 04.08:  
Circuit-switched call control procedures (continued)**

Procedure	Q.931	GSM 04.08
Status enquiry procedure	5.8.10, 5.8.11	5.5.3
User-to-user signalling	7	GSM 04.10
User notification procedure	5.9	5.3.1

**Table E.1/GSM 04.08:**  
**Circuit-switched call control procedures (continued)**

## **Annex F (informative): GSM specific cause values for radio resource management**

This annex is informative.

Cause value = 0 Normal event;

indicates that the channel is released because of a normal event or that an assignment or handover is successfully, and normally, completed.

Cause value = 1 Abnormal release, unspecified;

indicates that the channel is released because of an abnormal event without specifying further reasons.

Cause value = 2 Abnormal release, channel unacceptable;

indicates that the channel type or channel characteristics are not acceptable.

Cause value = 3 Abnormal release, timer expired;

indicates that the release is caused by a timer expiry.

Cause value = 4 Abnormal release, no activity on the radio path;

indicates that some supervisory function has detected that the channel is not active.

Cause value = 5 Pre-emptive release;

indicates that the channel is released in order to be allocated to a call with priority (e.g. an emergency call).

Cause value = 8 Handover impossible, timing advance out of range;

indicates that a handover is unsuccessful because the target BTS is beyond the normal range and the target BTS would not accept an out of range timing advance.

Cause value = 9 Channel mode unacceptable

indicates that the MS does not have the capability to handle the requested mode or type of channel.

Cause value = 10 Frequency not implemented

indicates that the MS does not have the capability to operate on (at least one of) the requested frequency(ies).



Cause value = 65 Call already cleared;

indicates that a handover is unsuccessful because the connection has been released by the network or the remote user.

Cause value = 95 Semantically incorrect message;

See annex H, section H5.10.

Cause value = 96 Invalid mandatory information;

See annex H, section H6.1.

Cause value = 97 Message type non-existent or not implemented;

See annex H, section H6.2.

Cause value = 98 Message type not compatible with protocol state;

See annex H, section H6.3

Cause value = 100 Conditional IE error;

See annex H, section H6.5

Cause value = 101 No cell allocation available;

indicates that an assignment or handover is unsuccessful because the MS has no current CA.

Cause value = 111 Protocol error unspecified;

See annex H, section H6.8.

## **Annex G (informative): GSM specific cause values for mobility management**

This annex is informative.

### **G.1 Causes related to MS identification**

Cause value = 2 IMSI unknown in HLR

This cause is sent to the MS if the MS is not known (registered) in the HLR.

Cause value = 3 Illegal MS

This cause is sent to the MS when the network refuses service to the MS either because an identity of the MS is not acceptable to the network or because the MS does not pass the authentication check, i.e. the SRES received from the MS is different from that generated by the network.

Cause value = 4 IMSI unknown in VLR

This cause is sent to the MS when the given IMSI is not known at the VLR.

Cause value = 5 IMEI not accepted

This cause is sent to the MS if the network does not accept emergency call establishment using an IMEI.

Cause value = 6 Illegal ME

This cause is sent to the MS if the ME used is not acceptable to the network, e.g. blacklisted.

### **G.2 Cause related to subscription options**

Cause value = 11 PLMN not allowed

This cause is sent to the MS if it requests location updating in a PLMN where the MS, by subscription or due to operator determined barring is not allowed to operate.

Cause value = 12 Location Area not allowed

This cause is sent to the MS if it requests location updating in a location area where the MS, by subscription, is not allowed to operate.

Cause value = 13 Roaming not allowed in this location area

This cause is sent to an MS which requests location updating in a location area of a PLMN which does not offer roaming to that MS in that Location Area.

### **G.3 Causes related to PLMN specific network failures and congestion**

Cause value = 17 Network failure

This cause is sent to the MS if the MSC cannot service an MS generated request because of PLMN failures, e.g. problems in MAP.

Cause value = 22 Congestion

This cause is sent if the service request cannot be actioned because of congestion (e.g. no channel, facility busy/congested etc.).

#### **G.4 Causes related to nature of request**

Cause value = 32 Service option not supported

This cause is sent when the MS requests a service/facility in the CM SERVICE REQUEST message which is not supported by the PLMN.

Cause value = 33 Requested service option not subscribed

This cause is sent when the MS requests a service option for which it has no subscription.

Cause value = 34 Service option temporarily out of order

This cause is sent when the MSC cannot service the request because of temporary outage of one or more functions required for supporting the service.

Cause value = 38 Call cannot be identified

This cause is sent when the network cannot identify the call associated with a call re-establishment request.

#### **G.5 Causes related to invalid messages**

Cause value = 95 Semantically incorrect message.

See annex H, section H.5.10.

Cause value = 96 Invalid mandatory information.

See annex H, section H.6.1.

Cause value = 97 Message type non-existent or not implemented.

See annex H, section H.6.2.

Cause value = 98 Message not compatible with protocol state.

See annex H, section H.6.3.

Cause value = 99 Information element non-existent or not implemented

See annex H, section H.6.4.

Cause value = 100 Conditional IE error.

See annex H, section H.6.5.

Cause value = 101 Message not compatible with protocol state

See annex H, section H.6.6.

Cause value = 111 Protocol error, unspecified

See annex H, section H.6.8.

## **Annex H (informative): GSM specific cause values for call control**

This annex is informative.

### **H.1 Normal class**

#### **H.1.1 Cause No. 1 "unassigned (unallocated) number"**

This cause indicates that the destination requested by the Mobile Station cannot be reached because, although the number is in a valid format, it is not currently assigned (allocated).

#### **H.1.2 Cause No. 3 "no route to destination"**

This cause indicates that the called user cannot be reached because the network through which the call has been routed does not serve the destination desired.

#### **H.1.3 Cause No. 6 "channel unacceptable"**

This cause indicates the channel most recently identified is not acceptable to the sending entity for use in this call.

#### **H.1.4 Cause No. 8 "operator determined barring"**

This cause indicates that the MS has tried to access a service that the MS's network operator or service provider is not prepared to allow.

#### **H.1.5 Cause No.16 "normal call clearing"**

This cause indicates that the call is being cleared because one of the users involved in the call has requested that the call be cleared.

Under normal situations, the source of this cause is not the network.

#### **H.1.6 Cause No.17 "user busy"**

This cause is used when the called user has indicated the inability to accept another call.

It is noted that the user equipment is compatible with the call.

#### **H.1.7 Cause No. 18 "no user responding"**

This cause is used when a user does not respond to a call establishment message with either an alerting or connect indication within the prescribed period of time allocated (defined by the expiry of either timer T303 or T310).

#### **H.1.8 Cause No. 19 "user alerting, no answer"**

This cause is used when a user has provided an alerting indication but has not provided a connect indication within a prescribed period of time.

**H.1.9 Cause No. 21 "call rejected"**

This cause indicates that the equipment sending this cause does not wish to accept this call, although it could have accepted the call because the equipment sending this cause is neither busy nor incompatible.

**H.1.10 Cause No. 22 "number changed"**

This cause is returned to a calling Mobile Station when the called party number indicated by the calling Mobile Station is no longer assigned. The new called party number may optionally be included in the diagnostic field. If a network does not support this capability, cause No. 1 "unassigned (unallocated) number" shall be used.

**H.1.11 Cause No. 26 "non-selected user clearing"**

Not supported. Treated as cause no. 31.

**H.1.12 Cause No. 27 "destination out of order"**

This cause indicates that the destination indicated by the Mobile Station cannot be reached because the interface to the destination is not functioning correctly. The term "not functioning correctly" indicates that a signalling message was unable to be delivered to the remote user; e.g., a physical layer or data link layer failure at the remote user, user equipment off-line, etc.

**H.1.13 Cause No. 28 "invalid number format (incomplete number)"**

This cause indicates that the called user cannot be reached because the called party number is not a valid format or is not complete.

**H.1.14 Cause No. 29 "facility rejected"**

This cause is returned when a facility requested by user can not be provided by the network.

**H.1.15 Cause No. 30 "response to STATUS ENQUIRY"**

This cause is included in STATUS messages if the message is sent in response to a STATUS ENQUIRY message. See also section 5.5.3.

**H.1.16 Cause No. 31 "normal, unspecified"**

This cause is used to report a normal event only when no other cause in the normal class applies.

**H.2 Resource unavailable class**

**H.2.1 Cause No. 34 "no circuit/channel available"**

This cause indicates that there is no appropriate circuit/channel presently available to handle the call.

H.2.2 Cause No. 38 "network out of order"

This cause indicates that the network is not functioning correctly and that the condition is likely to last a relatively long period of time; e.g., immediately re-attempting the call is not likely to be successful.

H.2.3 Cause No. 41 "temporary failure"

This cause indicates that the network is not functioning correctly and that the condition is not likely to last a long period of time; e.g., the Mobile Station may wish to try another call attempt almost immediately.

H.2.4 Cause No. 42 "switching equipment congestion"

This cause indicates that the switching equipment generating this cause is experiencing a period of high traffic.

H.2.5 Cause No. 43 "access information discarded"

This cause indicates that the network could not deliver access information to the remote user as requested; i.e., a user-to-user information, low layer compatibility, high layer compatibility, or sub-address as indicated in the diagnostic.

It is noted that the particular type of access information discarded is optionally included in the diagnostic.

H.2.6 Cause No. 44 "requested circuit/channel not available"

This cause is returned when the circuit or channel indicated by the requesting entity cannot be provided by the other side of the interface.

H.2.7 Cause No. 47 "resource unavailable, unspecified"

This cause is used to report a resource unavailable event only when no other cause in the resource unavailable class applies.

**H.3 Service or option not available class**

H.3.1 Cause No. 49 "quality of service unavailable"

This cause indicates to the Mobile Station that the requested quality of service, as defined in CCITT Recommendation X.213, cannot be provided.

H.3.2 Cause No. 50 "Requested facility not subscribed"

This cause indicates that the requested supplementary service could not be provided by the network because the user has not completed the necessary administrative arrangements with its supporting networks.

H.3.3 Cause No. 55 "Incoming calls barred within the CUG"

This cause indicates that although the called party is a member of the CUG for the incoming CUG call, incoming calls are not allowed within this CUG.

H.3.4 Cause No. 57 "bearer capability not authorized"

This cause indicates that the Mobile Station has requested a bearer capability which is implemented by the equipment which generated this cause but the Mobile Station is not authorized to use.

H.3.5 Cause No. 58 "bearer capability not presently available"

This cause indicates that the Mobile Station has requested a bearer capability which is implemented by the equipment which generated this cause but which is not available at this time.

H.3.6 Cause No. 63 "service or option not available, unspecified"

This cause is used to report a service or option not available event only when no other cause in the service or option not available class applies.

H.3.7 Cause No. 68 "ACM equal to or greater than ACMmax"

This cause is used by the mobile to indicate that call clearing is due to ACM being greater than or equal to ACMmax.

**H.4 Service or option not implemented class**

H.4.1 Cause No. 65 "bearer service not implemented"

This cause indicates that the equipment sending this cause does not support the bearer capability requested.

H.4.2 Cause No. 69 "Requested facility not implemented"

This cause indicates that the equipment sending this cause does not support the requested supplementary service.

H.4.3 Cause No. 70 "only restricted digital information bearer capability is available"

This cause indicates that one equipment has requested an unrestricted bearer service, but that the equipment sending this cause only supports the restricted version of the requested bearer capability.

H.4.4 Cause No. 79 "service or option not implemented, unspecified"

This cause is used to report a service or option not implemented event only when no other cause in the service or option not implemented class applies.

**H.5 Invalid message (e.g., parameter out of range) class**

H.5.1 Cause No. 81 "invalid transaction identifier value"

This cause indicates that the equipment sending this cause has received a message with a transaction identifier which is not currently in use on the MS-network interface.



H.5.2 Cause No. 87 "user not member of CUG"

This cause indicates that the called user for the incoming CUG call is not a member of the specified CUG.

H.5.3 Cause No. 88 "incompatible destination"

This cause indicates that the equipment sending this cause has received a request to establish a call which has low layer compatibility, high layer compatibility, or other compatibility attributes (e.g., data rate) which cannot be accommodated.

H.5.4 Cause No. 91 "invalid transit network selection"

For further study. Treated as cause no. 95.

H.5.5 Cause No. 95 "semantically incorrect message"

This cause is used to report receipt of a message with semantically incorrect contents (see section 8.8).

**H.6 Protocol error (e.g., unknown message) class**

H.6.1 Cause No. 96 "invalid mandatory information"

This cause indicates that the equipment sending this cause has received a message with a non-semantical mandatory IE error (see section 8.5).

H.6.2 Cause No. 97 "message type non-existent or not implemented"

This cause indicates that the equipment sending this cause has received a message with a message type it does not recognize either because this is a message not defined, or defined but not implemented by the equipment sending this cause.

H.6.3 Cause No. 98 "message type not compatible with protocol state"

This cause indicates that the equipment sending this cause has received a message not compatible with the protocol state (section 8.4).

H.6.4 Cause No. 99 "information element non-existent or not implemented"

This cause indicates that the equipment sending this cause has received a message which includes information elements not recognized because the information element identifier is not defined or it is defined but not implemented by the equipment sending the cause. However, the information element is not required to be present in the message in order for the equipment sending the cause to process the message.

H.6.5 Cause No. 100 "conditional IE error"

This cause indicates that the equipment sending this cause has received a message with conditional IE errors (see section 8.7.2).

H.6.6 Cause No. 101 "message not compatible with protocol state"

This cause indicates that a message has been received which is incompatible with the protocol state or that a STATUS message has been received indicating an incompatible call state.

H.6.7 Cause No. 102 "recovery on timer expiry"

This cause indicates that a procedure has been initiated by the expiry of a timer in association with GSM 04.08 error handling procedures.

H.6.8 Cause No. 111 "protocol error, unspecified"

This cause is used to report a protocol error event only when no other cause in the protocol error class applies.

**H.7 Interworking class**

H.7.1 Cause No. 127 "interworking, unspecified"

This cause indicates that there has been interworking with a network which does not provide causes for actions it takes; thus, the precise cause for a message which is being sent cannot be ascertained.

## Annex J (informative): Algorithm to encode frequency list information elements

This annex is informative.

### J.1 Introduction

Some information elements encode frequency lists with a special method. The main specification specifies the meaning of the fields and hence the way to decode them, but the corresponding encoding algorithm is difficult to infer from the decoding algorithm. This annex is intended as an aid for implementers of the encoding algorithm.

It could be shown that any set of frequency with less or the same number of frequencies as the number of words can be encoded with a careful choice of  $F_1$ ,  $F_2$ , and so on, i.e. that a set of  $W_i$  can be found so that the decoding algorithm given in the main section will give back the frequency set. The right order is not the order of the frequency values.

### J.2 General principle

The encoding algorithm is based on a recursive dichotomy of both the range (i.e. the set of values that are possible) and the subset (the values to encode).

The dichotomy is best understood if the range is seen as a circle. For instance, for the 1 023 range:

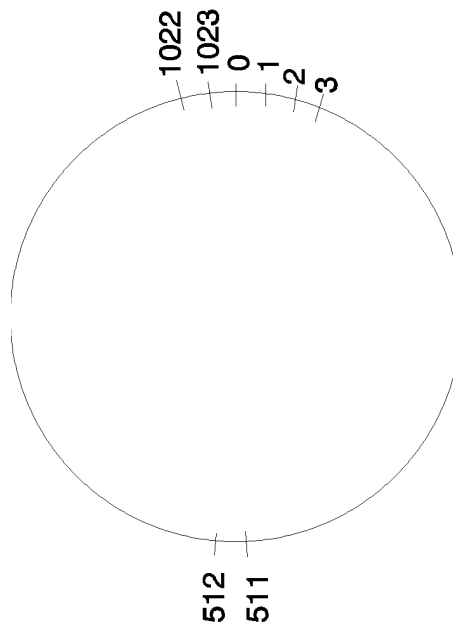
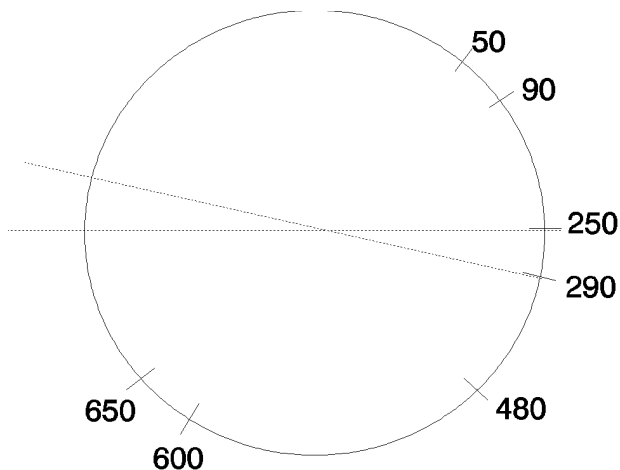

Figure J.1: Circular arrangement of 0..1 023

The dichotomy consists in finding a value in the subset such that the diameter determined by this value splits the subset in two equal or nearly equal sub-subsets. In the following case, we see that value 290 is acceptable (the two sub-subsets have 3 elements), when value 250 is not acceptable (the two sub-subsets have 4 and 2 elements):



**Figure J.2: Example of dichotomy**

The pivot value is part of the information field, then the two sub-subsets are renumbered and the same algorithm is applied again on each of them. Because the range is halved at each step, the number of bits needed to encode a pivot value is 1 bit less than the number of bits needed to encode the parent pivot value.

The convention is that if the number of values is even, the left sub-subset (that is to say the values that can be expressed as the pivot value minus some integer between 1 and half the range) will have 1 element more than the right subset.

At each step the subset is numbered from 0 to the range minus 1. The coding in the information field of the pivot value is its value as renumbered, plus 1. Value 0 is reserved to indicate no element.

The order of appearance in the information field of the successive pivot values is particular. If we present the values as organized as a tree, with the left child being the pivot of the left sub-subset and the right child the pivot of the right sub-subset, the order of appearance is given by the following tree:

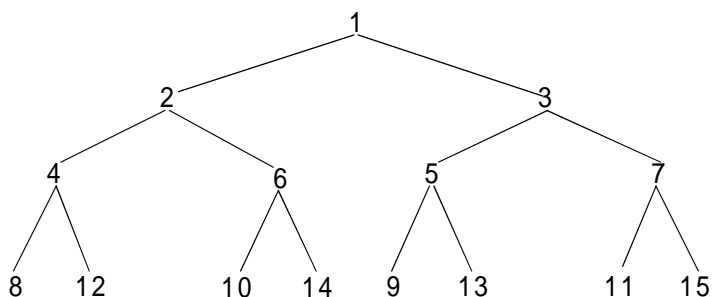

(and so on)

This order has been chosen so that:

- a) whatever the number  $N$  of elements in the set, the meaningful nodes are the first  $N$  and the value for all nodes from  $N+1$  on are null (if sent):
- b) the tree and all subtrees are balanced.

Important properties of these trees are used in the algorithms (with generation 1 corresponding to the root):

Generation  $g$  contains  $2^{g-1}$  nodes, and their indices are  $2^{g-1}$  to  $2^g-1$ ;

For generation  $g$ , nodes  $2^{g-1}$  to  $2^{g-1}+2^{g-2}-1$  are left children, the others are right children;

If node  $k$  belongs to generation  $g$ , its left child is node  $k + 2^{g-1}$ , and its right child is  $k + 2^g$ ;

Reciprocally, if  $k$  is a left child from generation  $g$ , its parent node is node  $k - 2^{g-2}$ , and if  $k$  is a right child of generation  $g$ , its parent is node  $k - 2^{g-1}$ .

### J.3 Performances

The number of bits needed to encode a given set of values depends on the number of values and on the range they can span.

For the application on the BCCH and the SACCH (CA and BA information ) 16 octets are available, and the number of frequencies that can be encoded in one information element is the following:

<b>Range</b>	<b>Number of frequencies</b>
513 to 1 024	2 to 16 (17 if frequency 0 is in)
257 to 512	2 to 18
129 to 256	2 to 22
113 to 128	2 to 29
up to 112	any

With two messages (for the BA) the number of frequencies that can be encoded is the following:

<b>Range</b>	<b>Number of frequencies</b>
513 to 1 024	2 to 36 (note 1)
257 to 512	2 to 40 (note 2)
225 to 256	2 to 51 (note 3)
up to 224	any

NOTE 1: A 1 024 range can be split cyclically in to two 512 ranges each with less than 18 frequencies; each subset is coded in one message with 512 range format.

NOTE 2: A 512 range can be split in to two consecutive 256 ranges. If both sub-ranges contain 22 frequencies or less, it is possible to code each of these in a messages using the 256 range format. Otherwise one of the two ranges contains 23 frequencies or more: 22 of them can be coded in one message using the 256 range format and the remaining frequencies (numbering less than or equal to 18) can be coded in the other message using the 512 range format.

NOTE 3: The principles described in notes 1 and 2, above apply in this case.

The frequency short list information element allows the following:

<b>Range</b>	<b>Number of frequencies</b>
513 to 1 024	2 to 7 (8 if frequency 0 is in)
257 to 512	2 to 8
129 to 256	2 to 9
57 to 128	2 to 12
up to 56	any

The number of frequencies as a function of the range and the length in octets of the variable length frequency list information element (including the message type and length fields) is given by the following table:

	Range	513 to	257 to	129 to	up to	variable
	1 024	512	256	128		bit map
octets						
5	1	1	1	1		8
6	2	2	3	3		16
7	3	3	4	4		24
8	4	4	5	6		32
9	5	6	6	8		40
10	6	7	8	10		48
11	7	8	9	12		56
12	9	9	11	14		64
13	10	11	13	16		72
14	11	12	14	18		80
15	12	13	16	21		88
16	13	15	18	24		96
17	14	16	20	26		104
18	16	18	22	29		112
19	17	19	24	32		120
20	18	21	26	--		128
21	20	22	28			136
22	21	24	30			144
23	22	26	32			152
24	24	27	34			160
25	25	29	37			168
26	26	30	40			176
27	28	32	42			184
28	29	34	45			192
29	30	36	48			200
30	32	38	50			208
31	33	40	53			216
32	35	42	56			224

**Table 04.08/J.1: Performance of the variable length frequency list information element**

#### J.4 Encoding algorithm

The choice is done recursively as given by the following programs, written in ADA:

Let us define the recursive procedure:

```
procedure ENCODE_SUBTREE(in INDEX : INTEGER;
    in SET : SET_OF_VALUE;
    in RANGE : INTEGER);
```

*This procedure is given a set of integer values and an index. It chooses one of those values and computes the corresponding  $W(INDEX)$  (considered as a global variable), it splits the set less the value in two equal or nearly equal subsets, and calls itself recursively for each of those subsets, with suitable  $INDEX$ .*

*Assumption: all values in  $SET$  lie (inclusively) between 0 and  $RANGE-1$ , and they are all distinct.*

*As written, the program does not assume special values for the range. With a range such as  $2^k-1$ , some expressions can be simplified.*

*Declarative part:*

```
INDEX_IN_SET : INTEGER;
```

```
begin
```

*First the program tests the leaf conditions :*

```
if SET'SIZE=0 then
    W(INDEX) := 0;
    return;
elsif SET'SIZE=1 then
    W(INDEX) := 1 + SET(1);
    return;
end if;
```

*The following program finds a value in the set such that exactly  $(SET'SIZE-1)/2$  values from the set are between this value plus 1 and this value plus half the range :*

```
declare
    N : INTEGER;
    J : INTEGER;
begin
    for I in 1..SET'SIZE loop
        N:=0;
        for J in 1..SET'SIZE loop
            if (SET(J)-SET(I)) mod RANGE <= (RANGE-1)/2 then
                N := N+1;
            end if;
        end loop;
    end loop;
```



*The test compares N-1 because the possible pivot value is counted.*

```
if N-1 = (SET'SIZE-1)/2 then
  INDEX_IN_SET := I;
  exit;
end if;
end loop;
end;
```

*INDEX\_IN\_SET is then the index in the list of the pivot value.*

*The following sets W(INDEX)*

```
W(INDEX) := SET(INDEX_IN_SET) + 1;
```

*Then the program does the same thing for the two halves of the range delimited by W(INDEX) and W(INDEX)+RANGE/2. First the left subset:*

```
declare
  SUBSET : SET_OF_VALUE(1..SET'SIZE/2);
  SUBSET_INDEX : INTEGER;
  ORIGIN_VALUE : INTEGER;
begin
  ORIGIN_VALUE := (SET(INDEX_IN_SET] + (RANGE-1)/2
    + 1) mod RANGE;
  SUBSET_INDEX:=1;
  for I in 1..SET'SIZE loop
    if (SET(I)-ORIGIN_VALUE) mod RANGE) < RANGE/2 then
      SUBSET(SUBSET_INDEX) :=
        (SET(I) - ORIGIN_VALUE) mod RANGE;
      SUBSET_INDEX := SUBSET_INDEX + 1;
    end if;
  end loop;

  ENCODE_SUBTREE(
    INDEX := INDEX +
      GREATEST_POWER_OF_2_LESSER_OR_EQUAL_TO(INDEX),
    SET := SUBSET,
    RANGE := RANGE/2);
end;
```

Then the right subset:

```
declare
  SUBSET : SET_OF_VALUE(1..(SET'SIZE-1)/2);
  SUBSET_INDEX : INTEGER;
  ORIGIN_VALUE : INTEGER;
begin
  ORIGIN_VALUE := (SET(INDEX_IN_SET] + 1) mod RANGE;
  SUBSET_INDEX:=1;
  for I in 1..SET'SIZE loop
    if (SET(I)-ORIGIN_VALUE) mod RANGE) < RANGE/2 then
      SUBSET(SUBSET_INDEX) :=
        (SET(I) - ORIGIN_VALUE) mod RANGE;
      SUBSET_INDEX := SUBSET_INDEX + 1;
    end if;
  end loop;
  ENCODE_SUBTREE(
    INDEX := INDEX +
      2*GREATEST_POWER_OF_2_LESSER_OR_EQUAL_TO(INDEX),
    SET := SUBSET,
    RANGE := (RANGE-1)/2);
end;

end ENCODE_SUBTREE;
```

The initial call of the procedure depends on the format. Given some set to encode, the first problem is to verify that it can be encoded, and by so doing to choose the format.

First the encoding process must find the minimum range of the set, that is to say the minimum value  $R$  such that there exists one frequency  $F_0$  in the set such that all frequencies in the set can be written  $(F_0 + N) \bmod 1024$ , with some  $N$ ,  $0 \leq N \leq R-1$ . The choice of the format depends on  $R$  and the number of frequencies : the 512 range format can be chosen only if  $R \leq 512$ , the 256 range format can be chosen only if  $R \leq 256$ , the 128 range format can be chosen only if  $R \leq 128$ .

If the chosen format is "1024 range", then the program must first check if frequency 0 is in the set. If so the  $F_0$  subfield is set to 1, and frequency 0 is removed from the set. Otherwise, the  $F_0$  subfield is set to 0. Then ENCODE\_SUBTREE is called with INDEX := 1, SET set to the set of values equal to the ARFCN of all frequencies minus 1, and RANGE := 1023.

If the chosen format is "512 range", "256 range" or "128 range",  $F_0$  is chosen as ORIG-ARFCN and ENCODE\_SUBTREE is called with INDEX := 1, SET set to the set of values equal to the ARFCN of all frequencies except  $F_0$ , minus  $F_0+1$ , and RANGE set respectively to 511, 255 or 127.

## J.5 Decoding

The decoding algorithm, as given below, is the inverse transform of the program given in the previous section, for the specific case where the original range is a power of 2 minus 1. It is given a set of integer values  $W(i)$ , and an original range  $R$ , and it builds a set of values from  $0..R-1$ .

The program is here written so that the fact that it is the inverse of the encoding program needs no more proof.

```
procedure DECODE(in W : array <> of INTEGER;
                out SET : SET_OF_VALUE;
                in ORIGINAL_RANGE : INTEGER);
```

```
    -- local variables
    INDEX : 1..W'SIZE;   RANGE : INTEGER;
    N : INTEGER;
```

```
begin
    for K in 1..W'SIZE loop
```

*The next loop follows the tree from child to parent, from the node of index K to the root (index 1). For each iteration the node of index INDEX is tackled. The corresponding range is RANGE, and N is the value of the element in the range defined by the node.*

*The data are set to their initial values :*

```
    INDEX := K;
    RANGE := ORIGINAL_RANGE / GREATEST_POWER_OF_2_LESSER_OR_EQUAL_TO(INDEX);
    N := W(INDEX) - 1;
```

```
    while INDEX > 1 loop
```

*Due to the assumption that the original range is a power of two minus one, the range for the parent node can be easily computed, and does not depend upon whether the current node is a left or right child :*

```
        RANGE := 2*RANGE + 1;
```

*Let us note  $J := 2^{g-1}$ ,  $g$  being the generation of node INDEX. We have  $J = \text{GREATEST\_POWER\_OF\_2\_LESSER\_OR\_EQUAL\_TO}(\text{INDEX})$ . The numbering used in the tree is such that the nodes of index  $J$  to  $J + J/2 - 1$  are left children, and the nodes of index  $J/2$  to  $J+J-1$  are right children. Hence an easy test to distinguish left and right children:*

```
        if 2*INDEX <
           3*GREATEST_POWER_OF_2_LESSER_OR_EQUAL_TO(INDEX)
        then      -- left child
```

*The next computation gives the index of the parent node of the node of index INDEX, for a left child :*

```
            INDEX := INDEX -
                GREATEST_POWER_OF_2_LESSER_OR_EQUAL_TO(INDEX)/2;
```

The next formula is the inverse of the renumbering appearing in the encoding for a left child. It gives the value of the parent node in the range defined by the grand-parent node:

```

N := (N + W(INDEX) - 1 + (RANGE-1)/2 + 1)
      mod RANGE;
else
      -- right child

```

The next computation gives the index of the parent node of the node of index INDEX, for a right child :

```
INDEX := INDEX - GREATEST_POWER_OF_2_LESSER_OR_EQUAL_TO(INDEX);
```

The next formula is the inverse of the renumbering appearing in the encoding for a right child:

```

      N := (N + W(INDEX) - 1 + 1) mod RANGE;
      end if;
      end loop;
      F(K) := N;
      end loop;
end;

```

A careful study will show that the programs given in the main part of the Technical Specification are equivalent to the one presented here. The main difference is the use of different remanent variables to remove most of the calls to the function giving the greatest power of 2 less than or equal to some integer.

The decoding must be terminated by the correction specific to the format.

## J.6 A detailed example

Let us take the following subset of 16 elements of the set [0..1 023] : [13, 71, 122, 191, 251, 321, 402, 476, 521, 575, 635, 701, 765, 831, 906, 981]

Range 1 024 format will be used. Frequency 0 is not in the set, thus field F0 is set to 0. The set is renumbered, so as to give a subset of 0..1022 : [12, 70, 121, 190, 250, 320, 401, 475, 520, 574, 634, 700, 764, 830, 905, 980].

For the first node (corresponding to W(1)), the value 121 satisfies the requirements. The opposite value is  $121 + 511 = 632$ . There are 8 values between 633 and 120 (namely the left-hand subset 634, 700, 764, 830, 905, 980, 12 and 70), and 7 values between 122 and 632 (namely the right-hand subset 190, 250, 320, 401, 475, 520 and 574).

The encoded value W(1) is  $121 + 1$ , i.e. 122.

The second node (corresponding to W(2)) is the left-hand child of the first node. The corresponding subtree has to encode for the left-hand subset, renumbered beginning at 633. This gives the following 8 element subset of 0..510, ordered as resulting from the example of algorithm : [402, 460, 1, 67, 131, 197, 272, 347]. Out of these values, 1 splits the set in 4 and 3, and the encoded value W(2) is 2.

Similarly, the third node ( $W(3)$ ) is the right-hand child of the first node and then the corresponding subtree encodes for the right-hand subset, renumbered starting at 122. This gives the following set of 0..510 : [68, 128, 198, 279, 353, 398, 452]. Out of these values, 68 splits the set into 3 and 3, and the encoded value  $W(3)$  is 69.

The same method is applied for all nodes, giving the following encoded values per node :

node	value	node	value
1	122	9	83
2	2	10	3
3	69	11	24
4	204	12	67
5	75	13	54
6	66	14	64
7	60	15	70
8	70	16	9

The encoding then consists in formatting, in that order:

122 on 10 bits, then 2 and 69 on 9 bits each, then 204, 75, 66 and 60 on 8 bits each, then 70, 83, 3, 24, 67, 54, 64 and 70 on 7 bits each, and finally 9 on 6 bits.

Conversely the decoding can be done easily. For instance for node 2, the original value is:

$$(122 - 512 + 2) \text{ smod } 1\ 023 = 635$$

For node 14, we have as original value:

$$(122 - 512 + (2 + (66 + 64) \text{ smod } 255) \text{ smod } 511) \text{ smod } 1\ 023 = 765$$

## Annex K (informative): Default Codings of Information Elements

This annex is informative.

The information in this annex does NOT define the value of any IEI for any particular message. This annex exists to aid the design of new messages, in particular with regard to backward compatibility with phase 1 mobile stations.

### K.1 Common information elements

For the common information elements types listed below, the default coding of information element identifier bits is summarized in table K.1/GSM 04.08.

Reference section
8 7 6 5 4 3 2 1
1 : : : - - - - Type 1 info elements
1 1 1 1 - - - - Note
0 : : : : : : : Type 3 & 4 info elements
0 0 0 1 0 0 0 1 Note
0 0 0 1 0 0 1 1 Location Area Identification 10.5.1.3
0 0 0 1 0 1 1 1 Mobile Identity 10.5.1.4
0 0 0 1 1 0 0 0 Note
0 0 0 1 1 1 1 1 Note
0 0 1 0 0 0 0 0 Mobile Station classmark 3 10.5.1.7
Spare Half Octet 10.5.1.8
All other values are reserved

**Table K.1/GSM 04.08:**  
**Default information element identifier coding for common information elements**

NOTE: These values were allocated but never used in earlier phases of the protocol.

**K.2 Radio Resource management information elements**

For the Radio Resource management information elements listed below, the default coding of the information element identifier bits is summarized in table K.2/GSM 04.08.

	Reference section
8 7 6 5 4 3 2 1	
1 : : : - - - - Type 1 info elements	
1 0 0 1 - - - - Cipher Mode Setting	10.5.2.9
1 0 1 0 - - - - Cipher Response	10.5.2.10
1 0 1 1 - - - - Note	
1 1 0 1 - - - - Synchronization Indication	10.5.2.39
1 1 1 0 - - - - Channel Needed	10.5.2.8
0 : : : : : : : Type 3 & 4 info elements	
0 0 0 0 0 0 1 0 Frequency Short List	10.5.2.14
0 0 0 0 0 1 0 1 Frequency List	10.5.2.13
0 1 1 0 0 0 0 1 Note	
0 1 1 0 0 0 1 0 Cell Channel Description	10.5.2.1b
0 1 1 0 0 0 1 1 Channel Mode	10.5.2.6
0 1 1 0 0 1 0 0 Channel Description	10.5.2.5
0 1 1 0 0 1 1 0 Channel Mode 2	10.5.2.7
0 1 1 0 1 0 0 0 Note	
0 1 1 0 1 0 0 1 Frequency Channel Sequence	10.5.2.12
0 1 1 0 1 0 1 0 Note	
0 1 1 0 1 0 1 1 Note	
0 1 1 0 1 1 0 0 Note	

**Table K.2/GSM 04.08 (page 1 of 2):  
 Default information element identifier coding for Radio  
 Resource management information elements**

8 7 6 5 4 3 2 1		Reference section
0 1 1 1 0 0 0 1	Note	
0 1 1 1 0 0 1 0	Mobile Allocation	10.5.2.21
0 1 1 1 0 0 1 1	BA range	10.5.2.1
0 1 1 1 0 1 0 0	Note	
0 1 1 1 0 1 0 1	Note	
0 1 1 1 0 1 1 0	Note	
0 1 1 1 0 1 1 1	Mobile Time difference	10.5.2.21a
0 1 1 1 1 0 0 0	Note	
0 1 1 1 1 0 0 1	Note	
0 1 1 1 1 0 1 0	Note	
0 1 1 1 1 0 1 1	Time Difference	10.5.2.41
0 1 1 1 1 1 0 0	Starting Time	10.5.2.38
0 1 1 1 1 1 0 1	Timing Advance	10.5.2.40
0 1 1 1 1 1 1 0	TMSI	10.5.2.42
0 1 1 1 1 1 1 1	Note	

**Table K.2/GSM 04.08 (page 2 of 2):  
 Default information element identifier coding for Radio  
 Resource management information elements**

NOTE: These values were allocated but never used in earlier phases of the protocol.



**K.3 Mobility management information elements.**

For the mobility management information elements listed below, the default coding of the information element identifier bits is summarized in table K.3/GSM 04.08.

								Reference Section
8	7	6	5	4	3	2	1	
								Type 1 info elements
1	0	0	1	-	-	-	-	Note
1	1	0	0	-	-	-	-	Note
1	1	1	0	-	-	-	-	Note
								Type 2 info elements
1	0	1	0	-	-	-	-	Follow-on Proceed
								10.5.3.7
								Type 3 & 4 info elements
0	1	0	0	0	0	0	1	Note
0	1	0	0	0	0	1	0	Note
0	1	0	0	0	1	0	0	Note
All other values are reserved								

**Table K.3/GSM 04.08:****Default information element identifier coding for mobility management information elements**

NOTE: These values were allocated but never used in earlier versions of the protocol.

**K.4 Call control information elements**

For the call control information elements listed below, the default coding of the information element identifiers is defined in table K.4/GSM 04.08.

	Reference section
8 7 6 5 4 3 2 1	
1 : : : - - - - Type 1 info elements shift	10.5.4.2 and .3
0 0 1 - - - - Note	
1 0 1 - - - - Repeat indicator	10.5.4.22
1 0 1 0 : : : : Type 2 information elements	
0 0 0 0 More data	10.5.4.19
0 0 0 1 CLIR Suppression	10.5.4.11a
0 0 1 0 CLIR Invocation	10.5.4.11b
0 0 1 1 Reverse call setup direction	10.5.4.22a
0 : : : : : : : Type 3 & 4 info elements	
0 0 0 0 1 0 0 Bearer capability	10.5.4.5
0 0 0 1 0 0 0 Cause	10.5.4.11
0 0 1 0 1 0 0 Note	
0 0 1 0 1 0 1 Call Control Capabilities	10.5.4.5a
0 0 1 1 1 0 0 Facility	10.5.4.15
0 0 1 1 1 1 0 Progress indicator	10.5.4.21
0 1 0 0 1 0 0 Auxiliary states	10.5.4.4
0 1 0 0 1 1 1 Note	
0 1 0 1 1 0 0 Keypad facility	10.5.4.17
0 1 1 0 1 0 0 Signal	10.5.4.23
1 0 0 1 1 0 0 Connected number	10.5.4.13
1 0 0 1 1 0 1 Connected subaddress	10.5.4.14
1 0 1 1 1 0 0 Calling party BCD number	10.5.4.9
1 0 1 1 1 0 1 Calling party subad	10.5.4.10
1 0 1 1 1 1 0 Called party BCD number	10.5.4.7
1 1 0 1 1 0 1 Called party subad	10.5.4.8
1 1 1 1 1 0 0 Low layer compatib.	10.5.4.18
1 1 1 1 1 0 1 High layer compatib.	10.5.4.16
1 1 1 1 1 1 0 User-user	10.5.4.25
1 1 1 1 1 1 1 SS version indicator	10.5.4.24

**Table K.4/GSM 04.08:  
Default information element identifier coding for call control information elements**

NOTE: These values were allocated but never used in earlier phases of the protocol.

## History

<b>Document history</b>			
February 1995	First Edition		
May 1995	Unified Approval Procedure (Second Edition)	UAP 29:	1995-05-22 to 1995-09-15
August 1995	Unified Approval Procedure (Third Edition)	UAP 34:	1995-08-21 to 1995-12-15
October 1995	Second Edition		
December 1995	Unified Approval Procedure (Fourth Edition)	UAP 40:	1995-12-04 to 1996-04-12
January 1996	Third Edition		
March 1996	Unified Approval Procedure (Fifth Edition)	UAP 45:	1996-03-25 to 1996-08-16
May 1996	Fourth Edition		
June 1996	Unified Approval Procedure (Sixth Edition)	UAP 48:	1996-06-03 to 1996-09-27
August 1996	Unified Approval Procedure (Seventh Edition)	UAP 52:	1996-08-19 to 1996-12-13
September 1996	Fifth Edition		
October 1996	Sixth Edition		
January 1997	Seventh Edition		

ISBN 2-7437-1245-7 - Edition 7  
 (ISBN 2-7437-1030-3 - Edition 6)  
 (ISBN 2-7437-0931-6 - Edition 5)  
 (ISBN 2-7437-0664-3 - Edition 4)  
 (ISBN 2-7437-0474-8 - Edition 3)  
 (ISBN 2-7437-0280-X - Edition 2)  
 (ISBN 2-7437-0015-7 - Edition 1)  
 Dépôt légal : Janvier 1997