



EUROPEAN
TELECOMMUNICATION
STANDARD

ETS 300 542

January 1999

Third Edition

Source: SMG

Reference: RE/SMG-030381PR1

ICS: 33.020

Key words: Digital cellular telecommunications system, Global System for Mobile communications (GSM)



**Digital cellular telecommunications system (Phase 2);
Line identification supplementary services;
Stage 2
(GSM 03.81 version 4.8.1)**

ETSI

European Telecommunications Standards Institute

ETSI Secretariat

Postal address: F-06921 Sophia Antipolis CEDEX - FRANCE

Office address: 650 Route des Lucioles - Sophia Antipolis - Valbonne - FRANCE

Internet: secretariat@etsi.fr - <http://www.etsi.fr> - <http://www.etsi.org>

Tel.: +33 4 92 94 42 00 - Fax: +33 4 93 65 47 16

Copyright Notification: No part may be reproduced except as authorized by written permission. The copyright and the foregoing restriction extend to reproduction in all media.

© European Telecommunications Standards Institute 1999. All rights reserved.

Contents

Foreword	5
0 Scope	7
0.1 Normative references	7
0.2 Definitions and abbreviations	7
0.2.1 Definitions	7
0.2.1.1 Definition of line identity	7
0.2.1.2 Definition of presentation and screening indicators	8
0.2.2 Abbreviations	8
1 Calling line identification presentation (CLIP)	9
1.1 Handling of calling line identification presentation	9
1.1.1 Interrogation	9
1.2 Functions and information flows	9
1.3 Information stored in the HLR	13
1.4 State transition model	13
1.5 Transfer of information from HLR to VLR	13
1.6 Information stored in the VLR	14
1.7 Handover	14
2 Calling line identification restriction (CLIR)	15
2.1 Handling of calling line identification restriction	15
2.1.1 General	15
2.1.2 Permanent mode	15
2.1.3 Controlling presentation of the CLI when CLIR is provisioned in temporary mode	15
2.1.4 Interrogation	16
2.2 Functions and information flows	16
2.3 Information stored in the HLR	21
2.4 State transition model	21
2.5 Transfer of information from HLR to VLR	21
2.6 Information stored in the VLR	21
2.7 Handover	22
2.8 Interworking	22
3 Connected line identification presentation (COLP)	23
3.1 Handling of connected line identification presentation	23
3.1.1 Interrogation	23
3.1.2 Interactions with call forwarding supplementary services	23
3.2 Functions and information flows	23
3.3 Information stored in the HLR	28
3.4 State transition model	28
3.5 Transfer of information from HLR to VLR	28
3.6 Information stored in the VLR	29
3.7 Handover	29
4 Connected line identification restriction (COLR)	30
4.1 Handling of connected line identification restriction	30
4.1.1 General	30
4.1.2 Interrogation	30
4.2 Functions and information flows	30
4.3 Information stored in the HLR	34
4.4 State transition model	34
4.5 Transfer of information from HLR to VLR	34
4.6 Information stored in the VLR	34
4.7 Handover	34
4.8 Interworking	35

Annex A (informative):	Status of Technical Specification GSM 03.81.....	36
History		37

Foreword

This European Telecommunication Standard (ETS) has been produced by the Special Mobile Group (SMG) Technical Committee of the European Telecommunications Standards Institute (ETSI).

This ETS defines the stage 2 of the line identification supplementary services for the Digital cellular telecommunications system (Phase 2).

The specification from which this ETS has been derived was originally based on CEPT documentation, hence the presentation of this ETS may not be entirely in accordance with the ETSI/PNE rules.

The contents of this ETS are subject to continuing work within SMG and may change following formal SMG approval. Should SMG modify the contents of this ETS it will then be re-submitted for OAP by ETSI with an identifying change of release date and an increase in version number as follows:

Version 4.x.y

where:

- 4 indicates GSM Phase 2
- x the second digit is incremented for all other types of changes, i.e. technical enhancements, corrections, updates, etc.
- y the third digit is incremented when editorial only changes have been incorporated in the specification;

Transposition dates	
Date of adoption of this ETS:	1 January 1999
Date of latest announcement of this ETS (doa):	30 April 1999
Date of latest publication of new National Standard or endorsement of this ETS (dop/e):	31 October 1999
Date of withdrawal of any conflicting National Standard (dow):	31 October 1999

Blank page

0 Scope

This specification gives the stage 2 description of the call identification supplementary services.

The group line identification supplementary services are divided into the following four supplementary services:

- Calling line identification presentation CLIP (clause 1);
- Calling line identification restriction CLIR (clause 2);
- Connected line identification presentation COLP (clause 3);
- Connected line identification restriction COLR (clause 4).

0.1 Normative references

This specification incorporates by dated and undated reference, provisions from other publications. These normative references are cited at the appropriate places in the text and the publications are listed hereafter. For dated references, subsequent amendments to or revisions of any of these publications apply to this specification only when incorporated in it by amendment or revision. For undated references, the latest edition of the publication referred to applies.

- [1] GSM 01.04: "Digital cellular telecommunications system (Phase 2); Abbreviations and acronyms".
- [2] GSM 03.11: "Digital cellular telecommunications system (Phase 2); Technical realization of supplementary services".

0.2 Definitions and abbreviations

0.2.1 Definitions

0.2.1.1 Definition of line identity

The line identity is made up of the following information units:

- The subscriber's international ISDN/MSISDN number;
- Optionally subaddress information.

For mobile originated calls, the ISDN/MSISDN shall always be provided within the network. The subaddress shall only be included if it is provided by the user (or user equipment).

The calling line identity is the line identity of the calling party. The connected line identity is the line identity of the connected party.

The additional calling line identity provides additional line information for the purpose of the calling line identification presentation service (CLIP). The additional connected line identity provides additional line information for the purpose of the connected line identification presentation service (COLP).

For mobile originating calls the user (or user equipment) has no possibility to provide an additional line identity. For mobile terminating calls the user (or user equipment) has no possibility to provide an additional connected line identity.

0.2.1.2 Definition of presentation and screening indicators

In addition to, or instead of, the line identity or additional line identity, the network may send a presentation indicator (PI) and/or a screening indicator (SI) or additional screening indicator (aSI) to the MS as follows:

- Presentation Indicator:
 - a) Presentation allowed;
 - b) Presentation restricted;
 - c) Number not available.

- Screening indicator/additional Screening indicator:
 - a) User provided, verified and passed;
 - b) User provided, not screened;
 - c) network provided.

The screening indicator or additional screening indicator applies to the ISDN/MSISDN or the number given as additional line identity respectively.

0.2.2 Abbreviations

Abbreviations used in this specification are listed in GSM 01.04.

1 Calling line identification presentation (CLIP)

1.1 Handling of calling line identification presentation

1.1.1 Interrogation

Status check

The mobile subscriber can request the status of the supplementary service and be informed if the service is provided to him/her. This procedure is illustrated in figure 1.1.

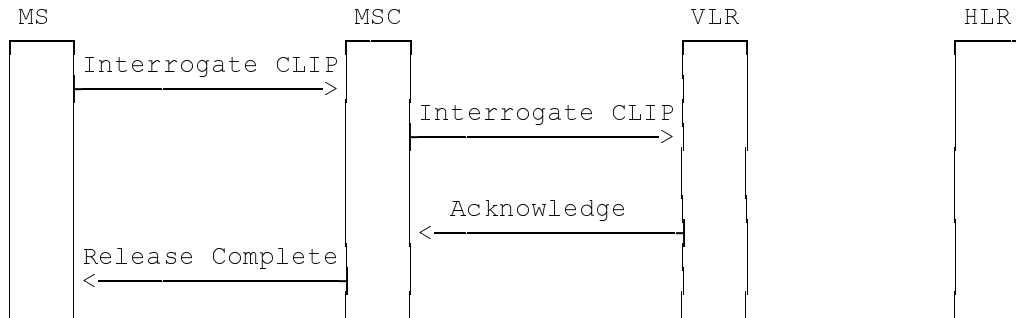

Figure 1.1: Interrogation of calling line identification presentation

1.2 Functions and information flows

The following Mobile Additional Functions have been identified for the PLMN:

MAF001

Determination of the calling line identification presentation subscription

The ability of a PLMN component to determine whether the supplementary service is provisioned for the mobile subscriber. See figure 1.2.

Location: VLR.

MAF002

Determination of the calling party number for offering to the called party

The ability of a PLMN component to determine and to forward the calling line identity and related indications to the called party. See figure 1.3.

Location: destination MSC.

The information flow is shown in figure 1.4.

Process CLIP_MAF001

381_12(1)

Figure 1.2

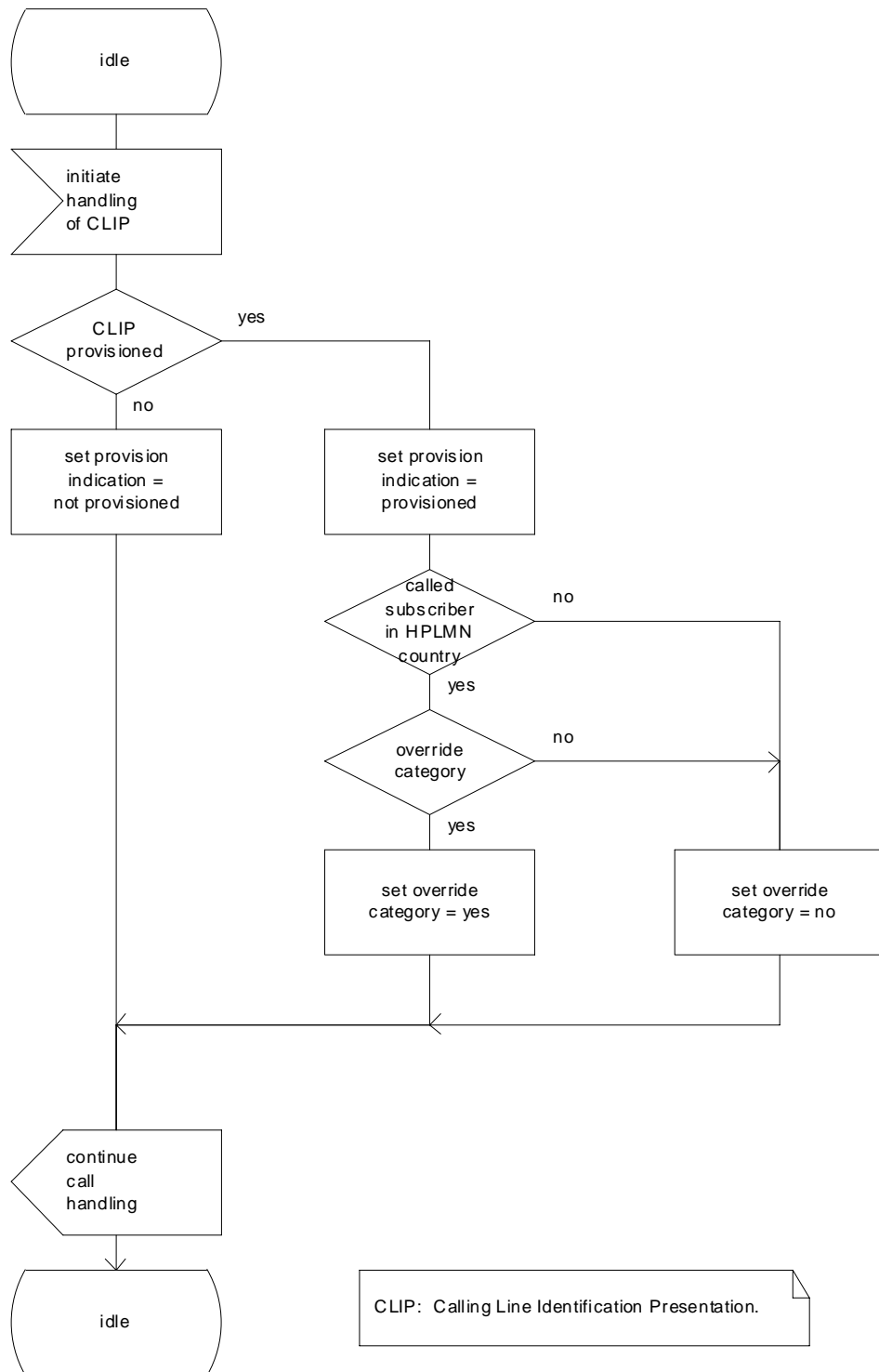

Figure 1.2: MAF001 Determination of calling line identification presentation subscription (VLR)

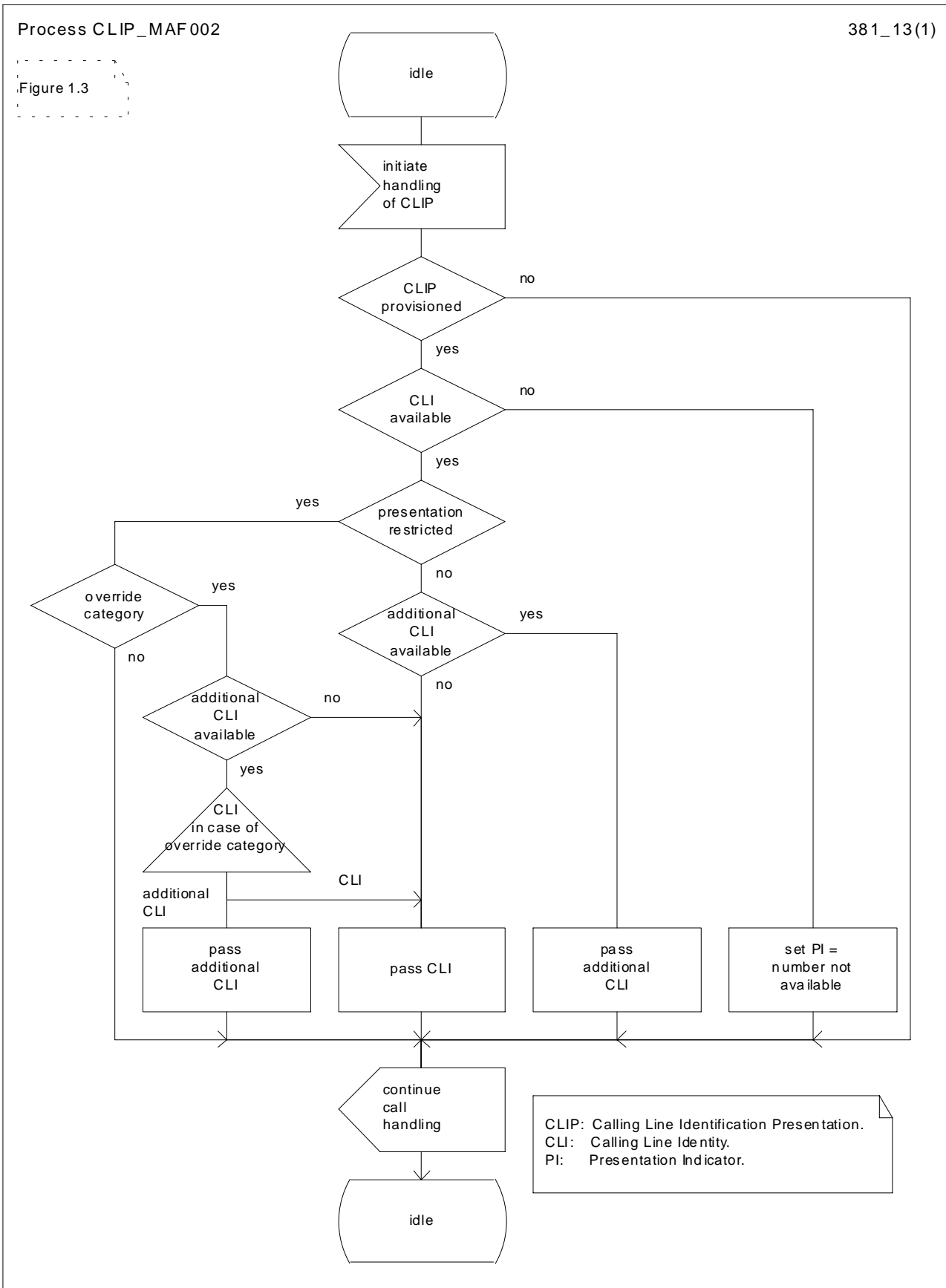
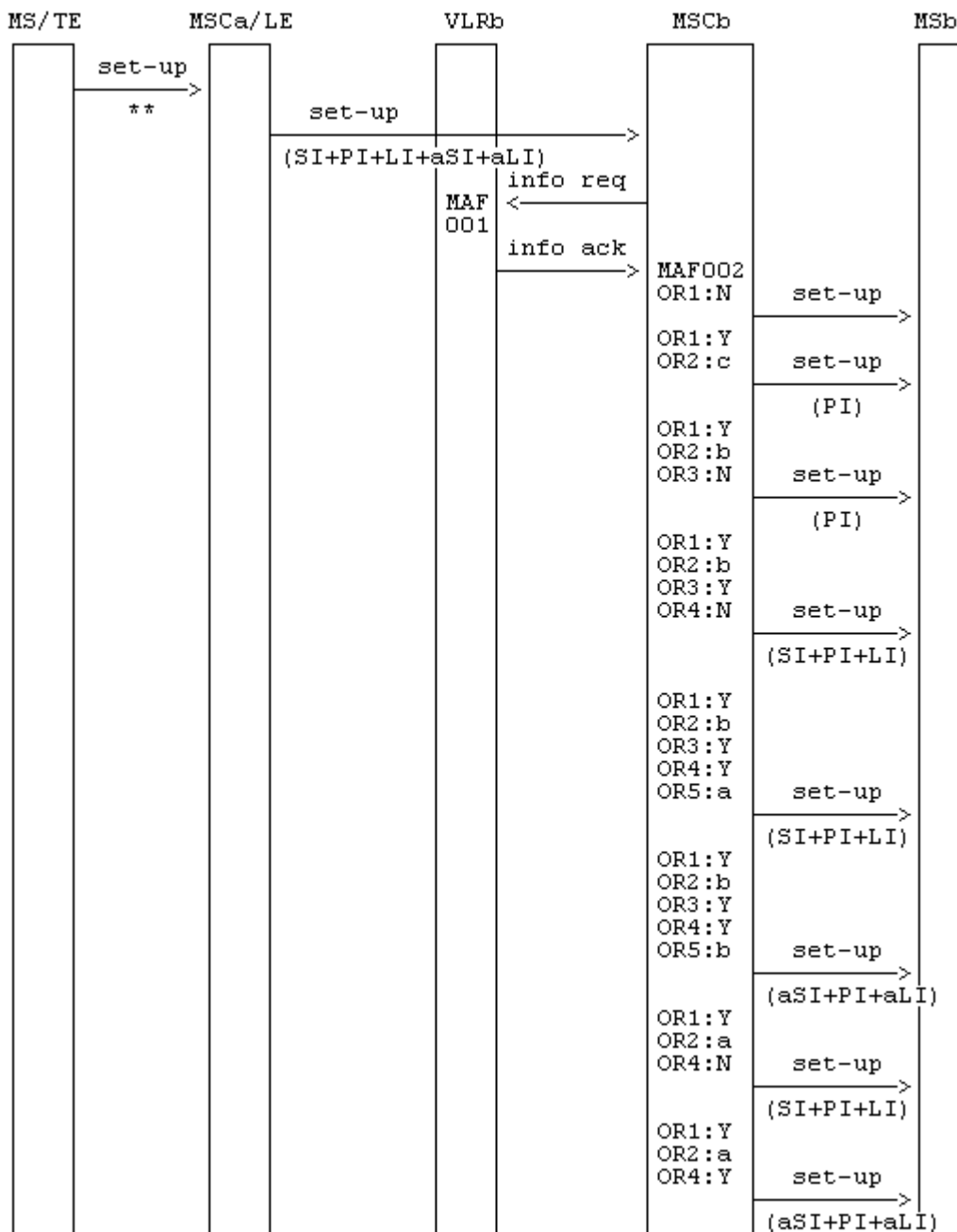

Figure 1.3: MAF002 Determination of the information for offering to the called party (destination MSC)



NOTE: OR1: CLIP provisioned
 OR2: Presentation Indicator Value

OR3: Override category
 OR4: additional line identity available
 OR5: CLI in case of override category

** : A subaddress may be received from the originating MS or the TE

info: information SI: screening indicator aSI: additional screening indicator
 req: request PI: presentation indicator
 ack: acknowledge LI: line identity aLI: additional line identity

Y: yes N: no
 a: allowed
 b: restricted
 c: not available

Y: yes N: no
 a: LI b: aLI

Figure 1.4: Information flow for calling line identification presentation: mobile station or fixed terminal to mobile station

1.3 Information stored in the HLR

CLIP may have the following logical states (refer to TS GSM 03.11 for an explanation of the notation):

Provisioning State	Registration State	Activation State	HLR Induction State
(Not Provisioned,	Not Applicable,	Not Active,	Not Induced)
(Provisioned,	Not Applicable,	Active and Operative,	Not Induced)

The HLR shall store the logical state of CLIP (which shall be one of the valid states listed above) on a per subscriber basis.

The HLR shall also store the subscription option "override category" on a per subscriber basis.

This parameter takes one of the following values:

- yes;
- no.

1.4 State transition model

The following figure shows the successful cases of transition between the applicable logical states of CLIP. The state changes are caused by actions of the service provider.

Note that error cases are not shown in the diagram as they normally do not cause a state change. Additionally, some successful requests may not cause a state change. Hence they are not shown in the diagram.

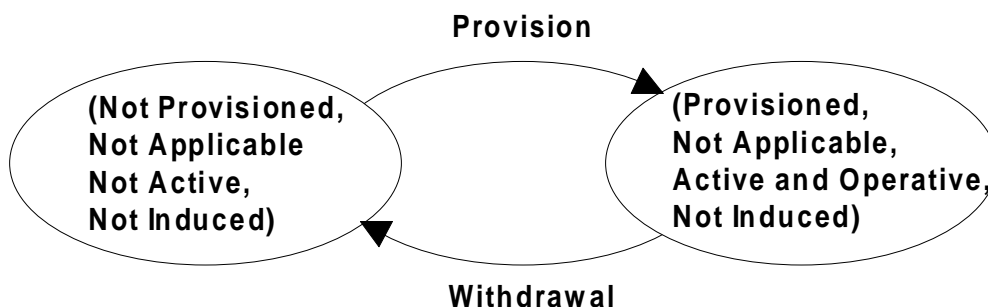

Figure 1.5: State transition model for CLIP

1.5 Transfer of information from HLR to VLR

If the provisioning state for CLIP is "Provisioned" then, when the subscriber registers on a VLR, the HLR shall send that VLR information about the logical state of CLIP. The HLR shall send the override category if the VLR is in the HPLMN country. The HLR may send the override category if the VLR is outside the HPLMN country.

If the logical state of CLIP or the override category is changed while a subscriber is registered on a VLR then the HLR shall inform the VLR of the new logical state of CLIP. If the override category is changed and the provisioning state of CLIP is "Provisioned" then the HLR shall inform the VLR about the new override category when the VLR is in the HPLMN country. The HLR may inform the VLR about the new override category when the VLR is outside the HPLMN country.

1.6 Information stored in the VLR

For CLIP, the VLR shall store the service state information and override category received from the HLR.

If not received from the HLR (case of roaming outside the HPLMN country), the override category shall be set to the default value "no".

1.7 Handover

Handover will have no impact on the control procedures and the operation of the service.

2 Calling line identification restriction (CLIR)

2.1 Handling of calling line identification restriction

2.1.1 General

If the originating party has calling line identification restriction provisioned and it is impossible to indicate to the terminating network (due to interworking) that the number should not be presented to the terminating party, the calling line identity shall not be delivered to the terminating network.

2.1.2 Permanent mode

If the subscriber has calling line identification restriction provisioned in permanent mode, the originating party's CLI shall not be presented to the terminating party (i.e. the terminating MS or TE), unless the terminating party has calling line identification presentation provisioned with the subscription option "override category" set (see clause 1).

2.1.3 Controlling presentation of the CLI when CLIR is provisioned in temporary mode

A subscriber can have calling line identification restriction provisioned in temporary mode with one of two default values: presentation restricted or presentation allowed.

If the default value is set to presentation restricted, the default handling is not to present the originating party's CLI to the terminating party (i.e. the terminating MS or TE).

However, it is possible for the originating subscriber to present his CLI to the terminating party. The originating subscriber must indicate during call set-up that the CLI must be presented to the terminating party. This procedure is illustrated in figure 2.1.

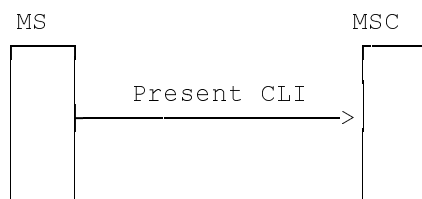

Figure 2.1: MS indicating presentation of CLI when CLIR is provisioned in temporary mode with default value "presentation restricted"

If the default value is set to presentation allowed, the default handling is to present the originating party's CLI to the terminating party (i.e. the terminating MS or TE).

However, it is possible for the originating subscriber to restrict presentation of his CLI to the terminating party. The originating subscriber must indicate during call set-up that CLI presentation must be restricted. This procedure is illustrated in figure 2.2.



Figure 2.2: MS invoking CLIR, when CLIR is provisioned in temporary mode with default value "presentation allowed"

2.1.4 Interrogation

Data request

The mobile subscriber can request the data of the supplementary service.

In response the following information shall be given:

- whether the service is provided or not;
- if provided which mode is subscribed;
- if subscribed to the temporary mode: which default value.

This procedure is illustrated in figure 2.3.

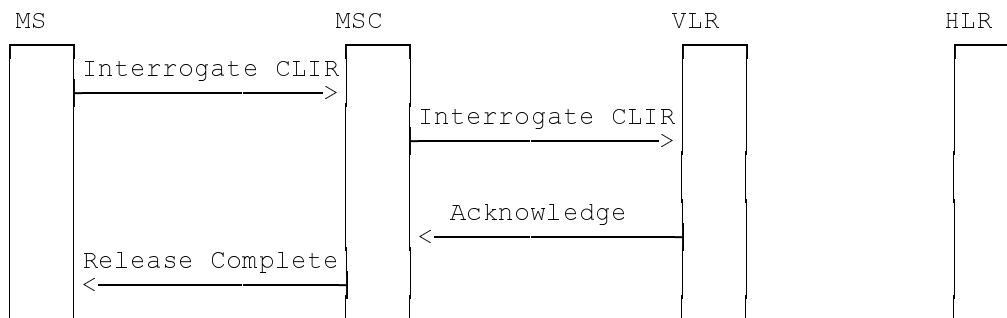

Figure 2.3: Interrogation of calling line identification restriction

2.2 Functions and information flows

The following Mobile Additional Functions have been identified for the PLMN:

MAF003

Determination of the calling line identification restriction subscription

The ability of a PLMN component to determine whether the supplementary service is provisioned for the mobile subscriber. See figure 2.4.

Location: VLR.

MAF004

Determination of the calling party number for offering to the called party

The ability of a PLMN component to determine and to forward the calling line identity and related indications to the called party. See figure 2.5.

Location: originating MSC.

The information flows are shown in figures 2.6 to 2.9.

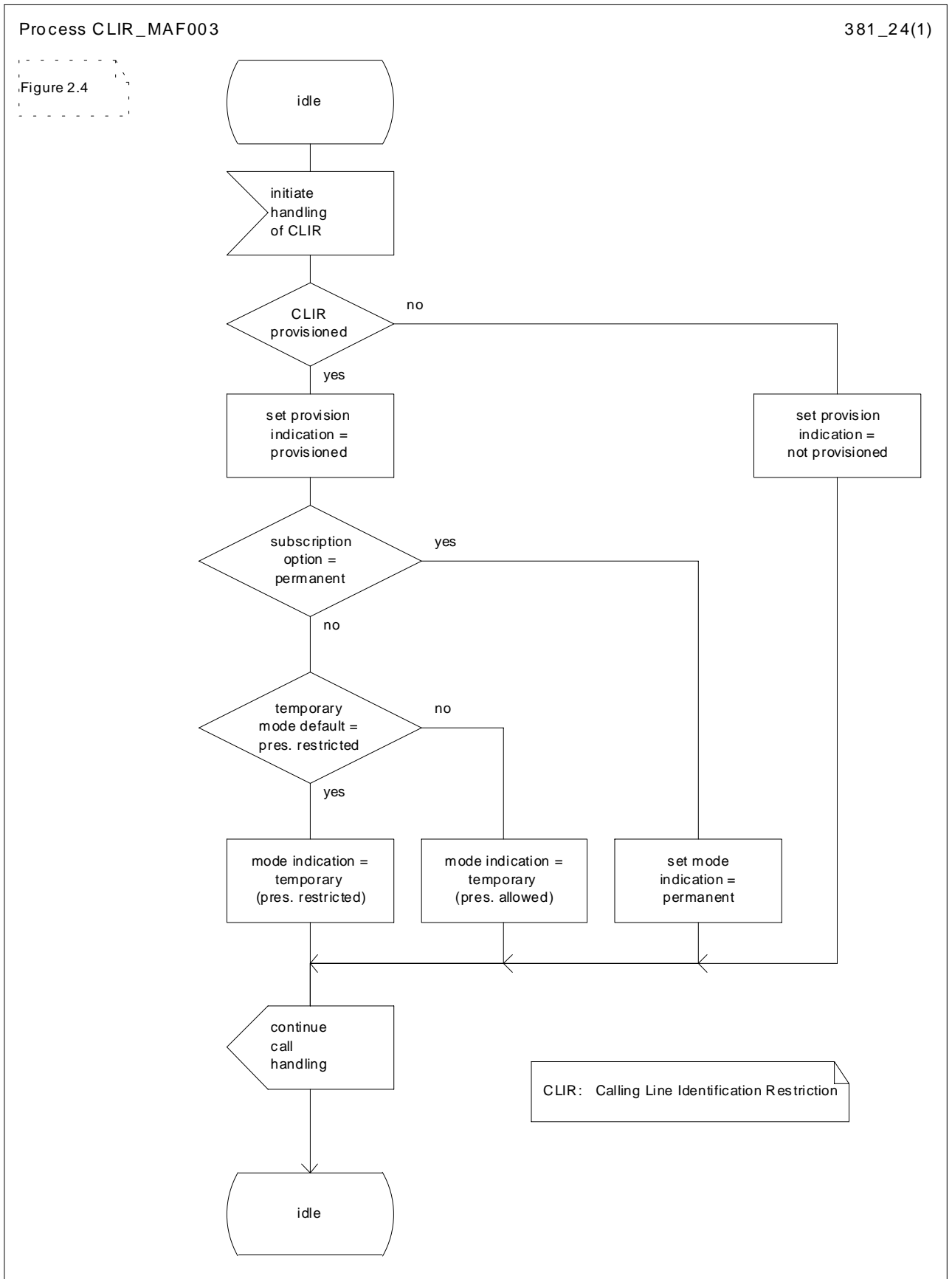

Figure 2.4: MAF003 Determination of calling line identification restriction subscription (VLR)

Process CLIR_MAF004

381_25(1)

Figure 2.5

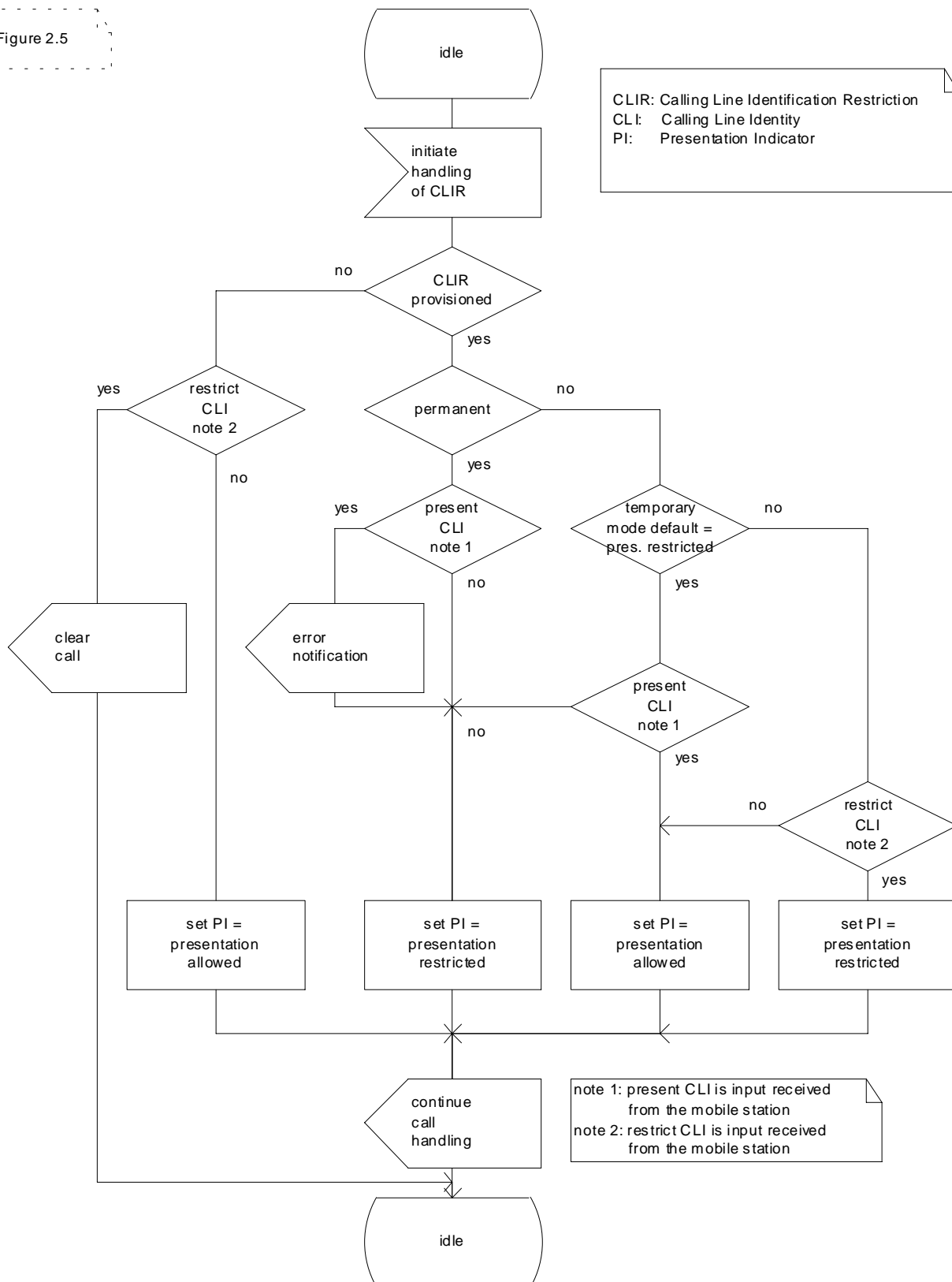
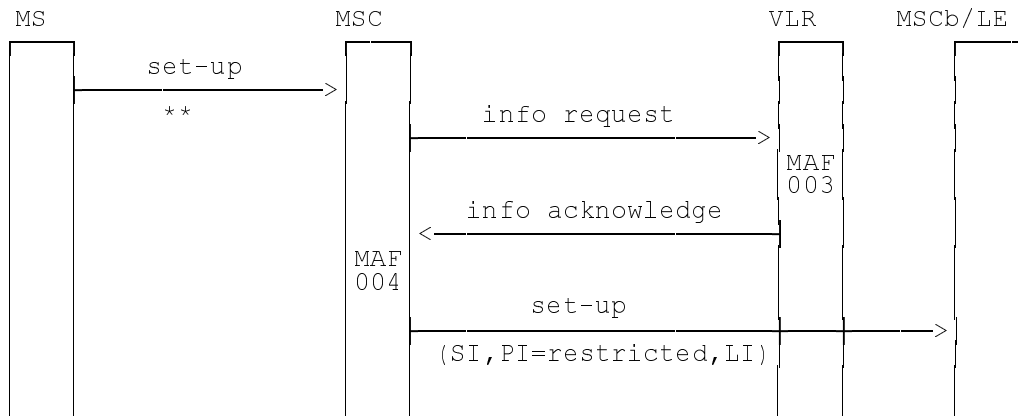
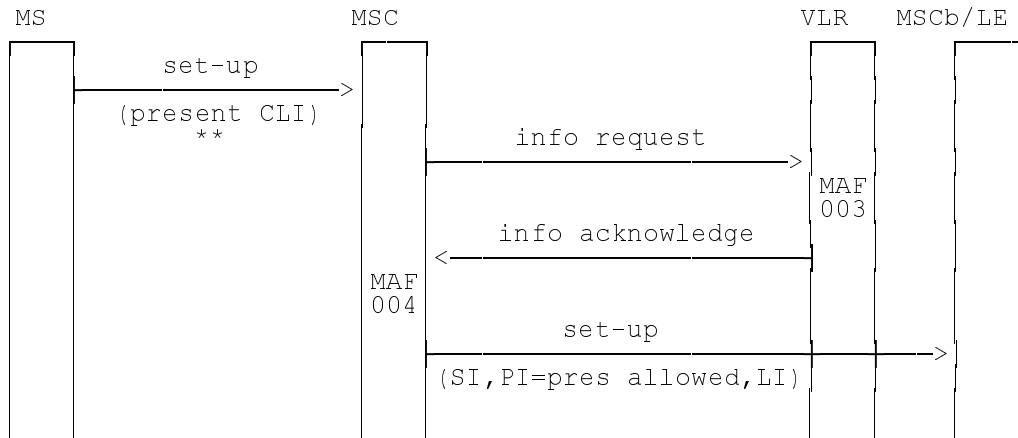

Figure 2.5: MAF004 Determination of the presentation indicator (originating MSC)



NOTE: **: A subaddress may be received from the MS
 SI: screening indicator
 PI: presentation indicator
 LI: line identity

Figure 2.6: Information flow for calling line identification restriction in permanent or temporary mode with the default value "presentation restricted"



NOTE: **: A subaddress may be received from the MS
 SI: screening indicator
 PI: presentation indicator
 LI: line identity
 CLI: calling line identity

Figure 2.7: Information flow for allowing presentation of the CLI when CLIR is provisioned in temporary mode with default value "presentation restricted"

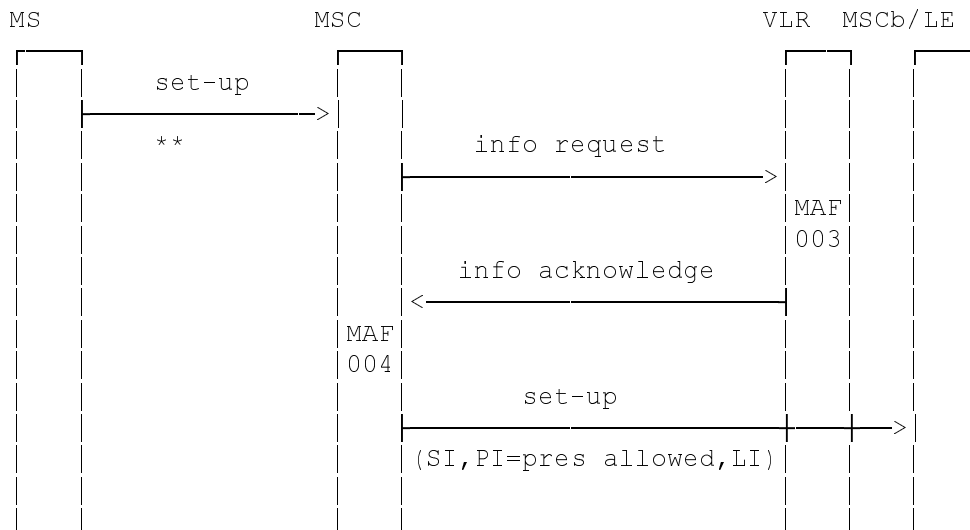

NOTE: **: A subaddress may be received from the MS
 SI: screening indicator
 PI: presentation indicator
 LI: line identity

Figure 2.8: Information flow for calling line identification restriction in temporary mode with default value "presentation allowed"

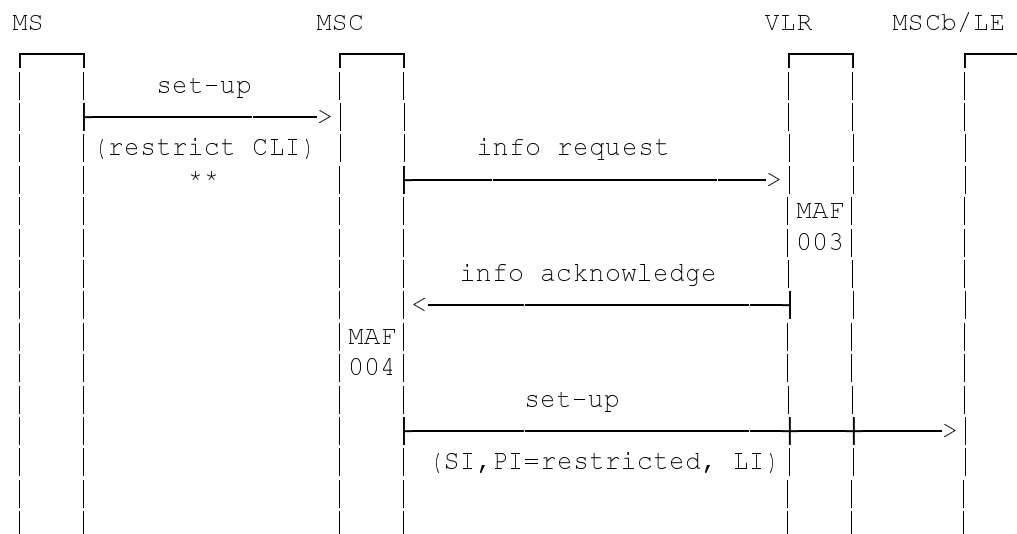

NOTE: **: A subaddress may be received from the MS
 SI: screening indicator
 PI: presentation indicator
 LI: line identity
 CLI: calling line identity

Figure 2.9: Information flow for restricting presentation of CLI when CLIR is provisioned in temporary mode with default value "presentation allowed"

2.3 Information stored in the HLR

CLIR may have the following logical states (refer to TS GSM 03.11 for an explanation of the notation):

Provisioning State	Registration State	Activation State	HLR Induction State
(Not Provisioned,	Not Applicable,	Not Active,	Not Induced)
(Provisioned,	Not Applicable,	Active and Operative,	Not Induced)

The HLR shall store the logical state of CLIR (which shall be one of the valid states listed above) on a per subscriber basis.

The HLR shall also store the subscription option "presentation mode" on a per subscriber basis.

This parameter takes one of the following values:

- permanent;
- temporary (presentation restricted);
- temporary (presentation allowed).

2.4 State transition model

The following figure shows the successful cases of transition between the applicable logical states of CLIR. The state changes are caused by actions of the service provider.

Note that error cases are not shown in the diagram as they normally do not cause a state change. Additionally, some successful requests may not cause a state change. Hence they are not shown in the diagram.

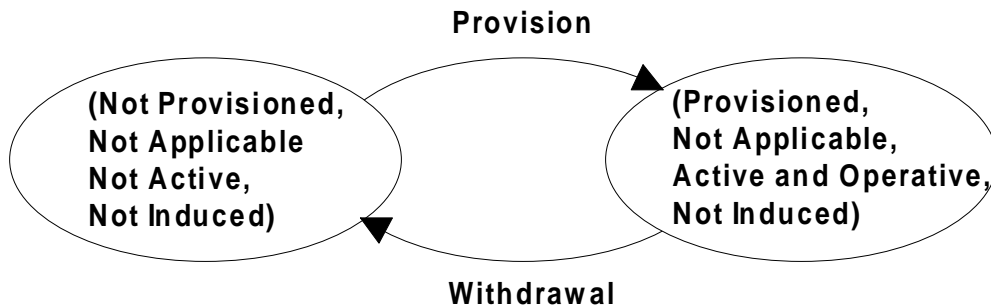

Figure 2.10: State transition model for CLIR

2.5 Transfer of information from HLR to VLR

When the subscriber registers on a VLR, the HLR shall send that VLR information about the logical state of CLIR and the presentation mode.

If the logical state of CLIR or the presentation mode is changed while a subscriber is registered on a VLR then the HLR shall inform the VLR of the new logical state of CLIR and (if the provisioning state is "Provisioned") the new presentation mode.

2.6 Information stored in the VLR

For CLIR, the VLR shall store the service state information and presentation mode received from the HLR.

2.7 Handover

Handover will have no impact on the control procedures and the operation of the service.

2.8 Interworking

The VPLMN needs to distinguish three cases in order to meet data privacy requirements in an environment where support of CLIP and CLIR is optional:

- a) the HPLMN supports CLIR, and CLIR is provisioned for the subscriber;
- b) the HPLMN supports CLIR, but CLIR is not provisioned for the subscriber;
- c) the HPLMN does not support CLIR.

In case a) the VPLMN must apply the CLIR subscription as indicated by the data sent by the HPLMN.

In case b) the VPLMN must not apply CLIR.

In case c) the VPLMN must apply an implicit CLIR subscription.

To allow the VPLMN to make this distinction, the HLR and VLR behave as follows:

- If the HLR supports CLIR, but CLIR is not provisioned for the subscriber, the HLR shall inform the VLR that CLIR is not provisioned.
- If the VLR supports CLIR, but the HLR does not support CLIR, the VLR shall behave in the same way as if CLIR (temporary (presentation restricted)) was provisioned for the subscriber, i.e. the calling line identity shall not be displayed to the called subscriber unless the called subscriber has CLIR override capability. When interrogating the service status the subscriber shall be informed that CLIR (temporary (presentation restricted)) is provided to him and is active.

3 Connected line identification presentation (COLP)

3.1 Handling of connected line identification presentation

3.1.1 Interrogation

Status check

The mobile subscriber can request the status of the supplementary service and be informed if the service is provided to him/her. This procedure is illustrated in figure 3.1.

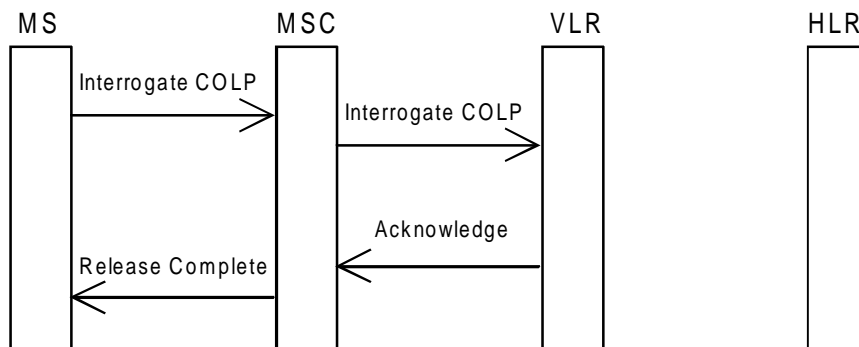

Figure 3.1: Interrogation of connected line identification presentation

3.1.2 Interactions with call forwarding supplementary services

If the forwarding user selects the option that the calling user is not notified of the call forwarding, then the calling user shall receive no forwarding notification, and the calling user shall not receive the connected user's identity when the call is answered, unless the calling user has override capability.

3.2 Functions and information flows

The following Mobile Additional Functions have been identified for the PLMN:

MAF005

Determination of the connected line identification presentation subscription

The ability of a PLMN component to determine whether the supplementary service is provisioned for the mobile subscriber. See figure 3.2.

Location: VLR.

MAF006

Determination of the connected party number for offering to the calling party

The ability of a PLMN component to determine and to forward the connected line identity and related indications to the calling party. See figure 3.3.

Location: originating MSC.

MAF039

Interaction of connected line identification presentation with the call forwarding supplementary services

The ability of a PLMN component to determine the presentation indicator of the connected party number after invocation of a call forwarding service. See figure 3.4.

Location: forwarding MSC.

The information flow is shown in figure 3.5.

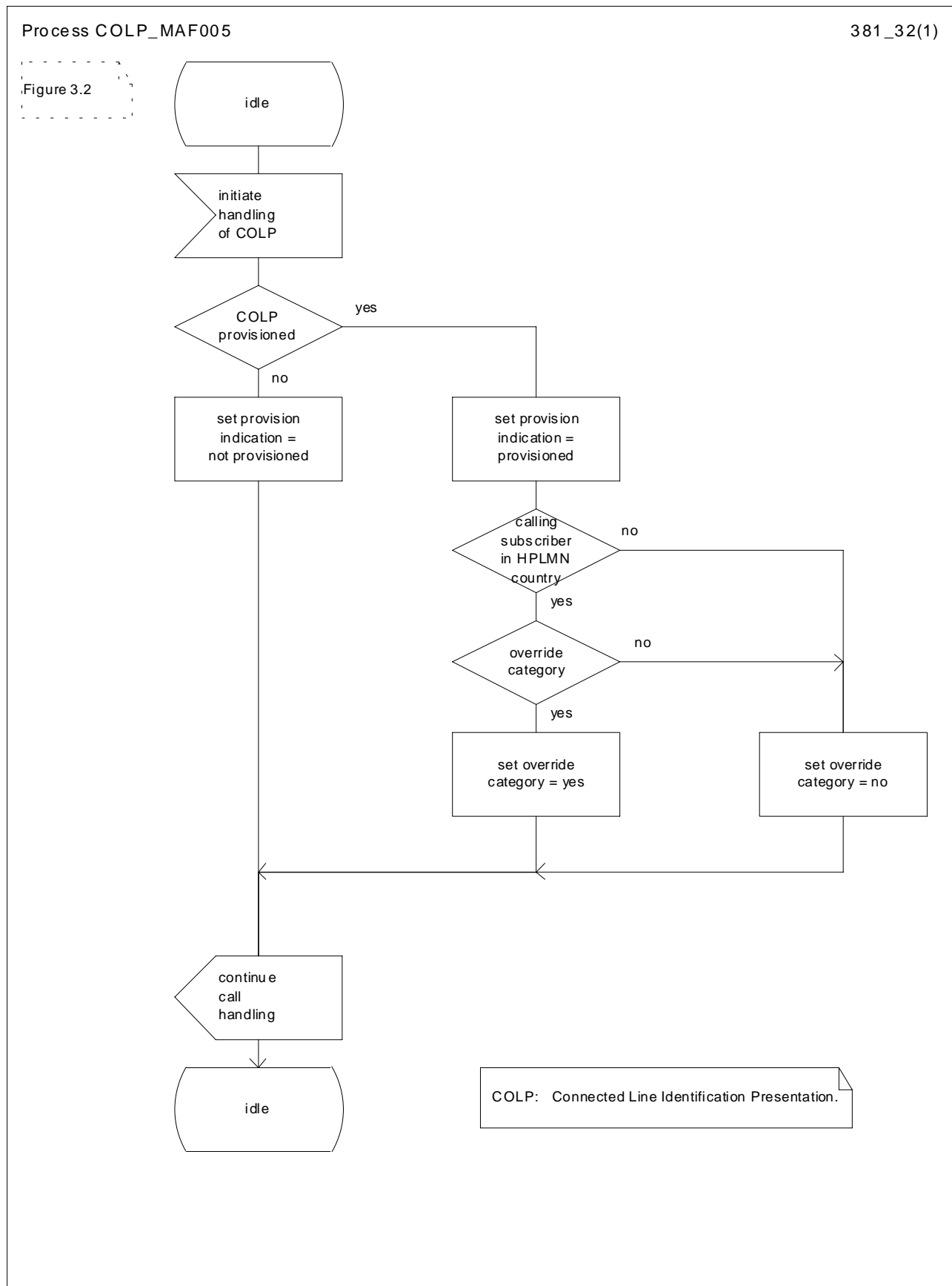

Figure 3.2: MAF005 Determination of connected line identification presentation subscription (VLR)

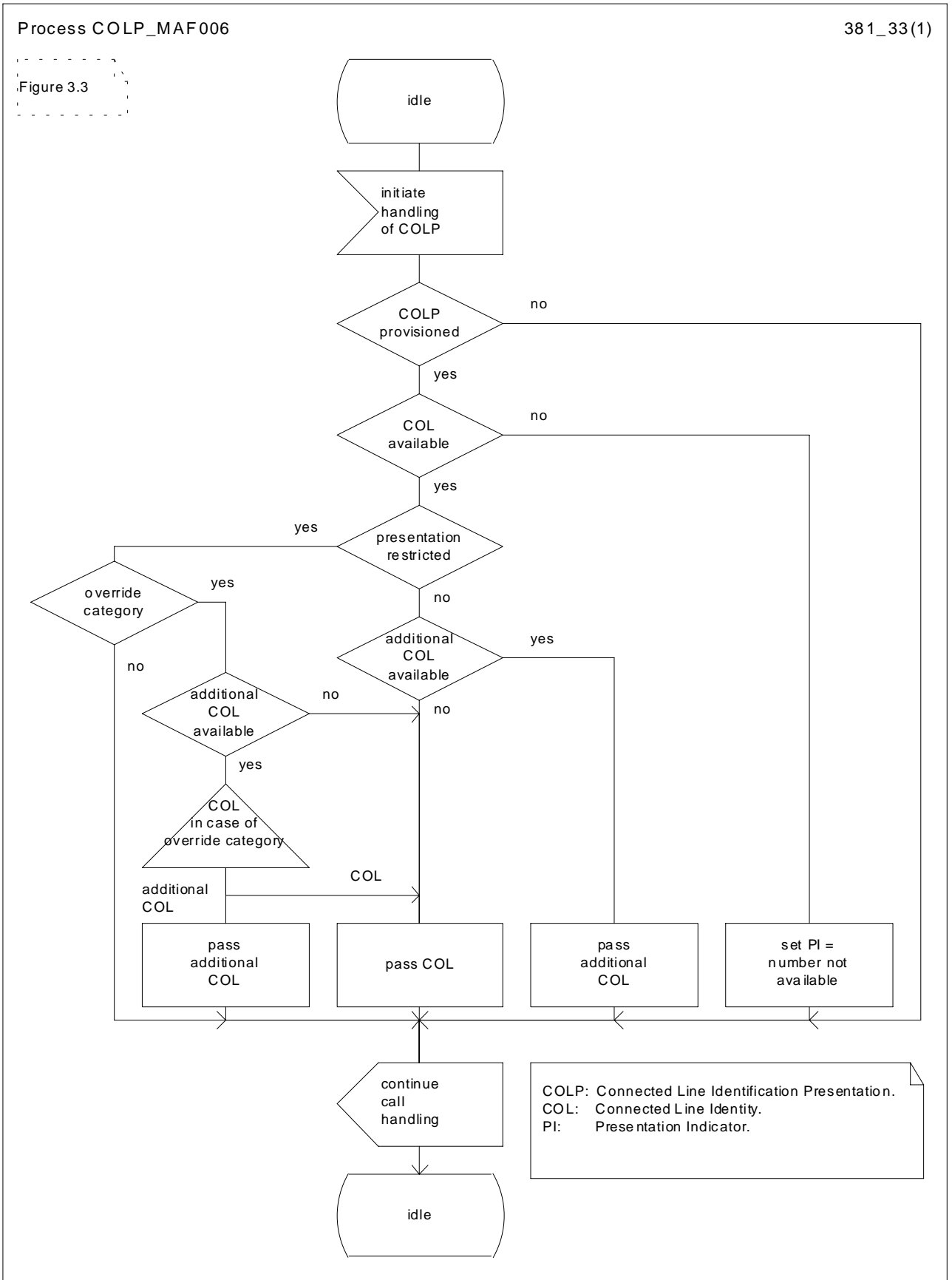

Figure 3.3: MAF006 Determination of the information for offering to the connected party (originating MSC)

Process COLP_MAF039

381_34(1)

Figure 3.4

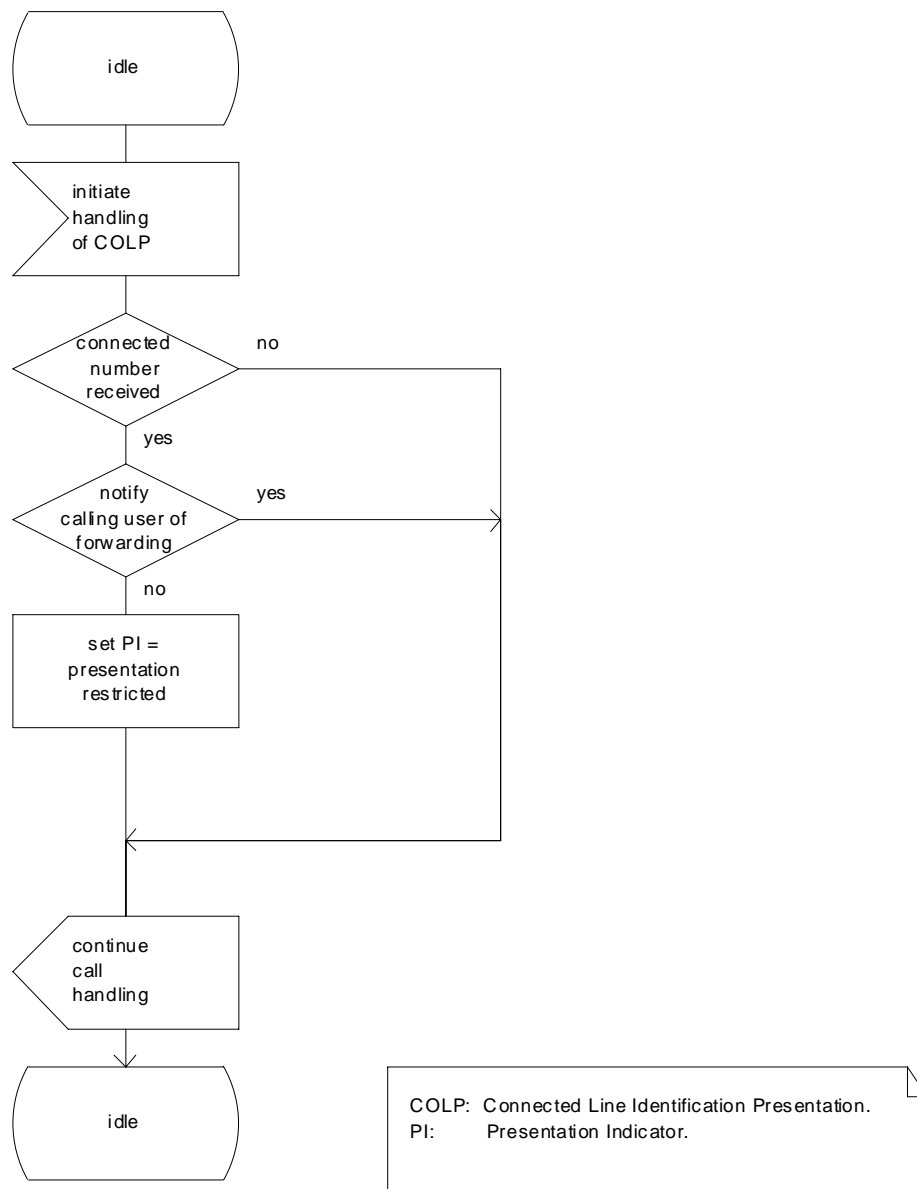
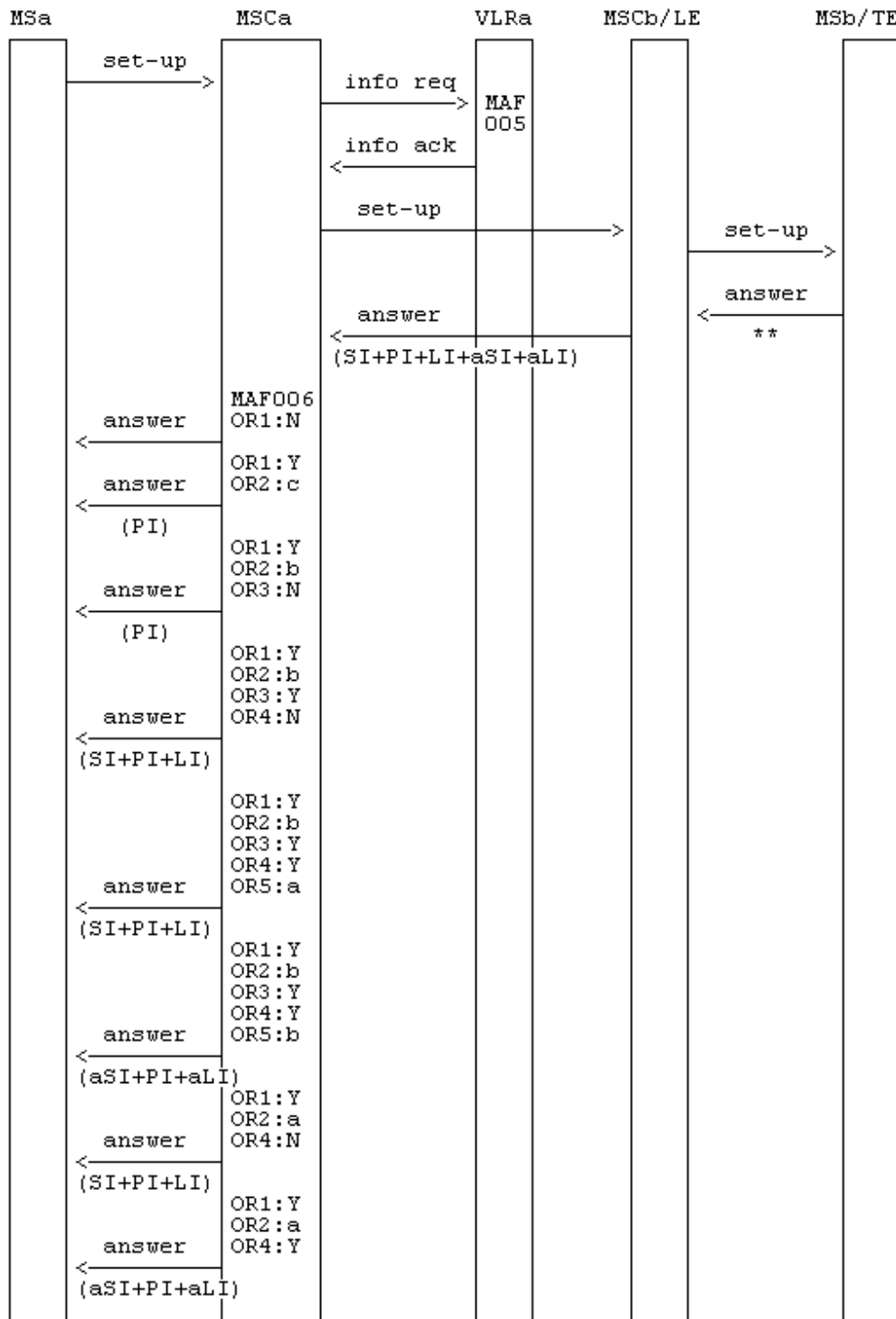

Figure 3.4: MAF039 Interaction between COLP and call forwarding services (forwarding MSC)



NOTE: OR1: COLP provisioned Y: yes N: no
 OR2: Presentation Indicator Value a: allowed b: restricted c: not available
 OR3: Override category
 OR4: additional line identity available Y: yes N: no
 OR5: COL in case of override category a: LI b: aLI
 **: A connected subaddress may be received from the MS
 info: information SI: screening indicator aSI: additional screening indicator
 req: request PI: presentation indicator
 ack: acknowledge LI: line identity aLI: additional line identity

Figure 3.5: Information flow for connected line identification presentation: mobile station to mobile station or fixed terminal

3.3 Information stored in the HLR

COLP may have the following logical states (refer to TS GSM 03.11 for an explanation of the notation):

Provisioning State	Registration State	Activation State	HLR Induction State
(Not Provisioned,	Not Applicable,	Not Active,	Not Induced)
(Provisioned,	Not Applicable,	Active and Operative,	Not Induced)

The HLR shall store the logical state of COLP (which shall be one of the valid states listed above) on a per subscriber basis.

The HLR shall also store the subscription option "override category" on a per subscriber basis.

This parameter takes one of the following values:

- yes;
- no.

3.4 State transition model

The following figure shows the successful cases of transition between the applicable logical states of COLP. The state changes are caused by actions of the service provider.

Note that error cases are not shown in the diagram as they normally do not cause a state change. Additionally, some successful requests may not cause a state change. Hence they are not shown in the diagram.

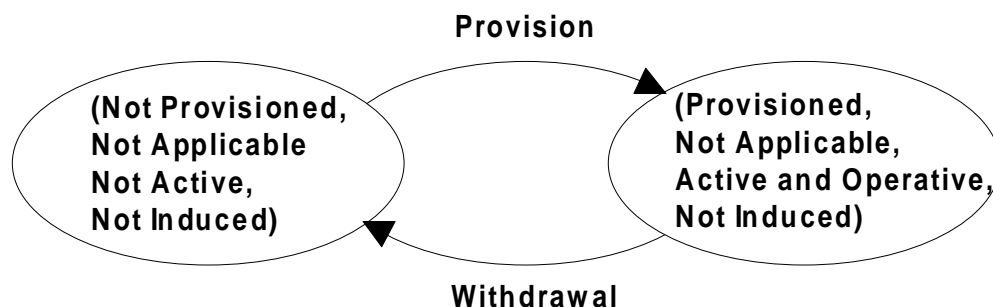

Figure 3.6: State transition model for COLP

3.5 Transfer of information from HLR to VLR

If the provisioning state for COLP is "Provisioned" then, when the subscriber registers on a VLR, the HLR shall send that VLR information about the logical state of COLP. The HLR shall send the override category if the VLR is in the HPLMN country. The HLR may send the override category if the VLR is outside the HPLMN country.

If the logical state of COLP or the override category is changed while a subscriber is registered on a VLR then the HLR shall inform the VLR of the new logical state of COLP. If the override category is changed and the provisioning state of COLP is "Provisioned" then the HLR shall inform the VLR about the new override category when the VLR is in the HPLMN country. The HLR may inform the VLR about the new override category when the VLR is outside of the HPLMN country.

3.6 Information stored in the VLR

For COLP, the VLR shall store the service state information and override category received from the HLR.

If not received from the HLR (case of roaming outside the HPLMN country), the override category shall be set to the default value "no".

3.7 Handover

Handover will have no impact on the control procedures and the operation of the service.

4 Connected line identification restriction (COLR)

4.1 Handling of connected line identification restriction

4.1.1 General

If the terminating party has connected line identification restriction provisioned and it is impossible to indicate to the originating network (due to interworking) that the number should not be presented to the originating party, the connected line identity shall not be delivered to the originating network.

4.1.2 Interrogation

Status check

The mobile subscriber can request the status of the supplementary service and be informed if the service is provided to him/her. This procedure is illustrated in figure 4.1.

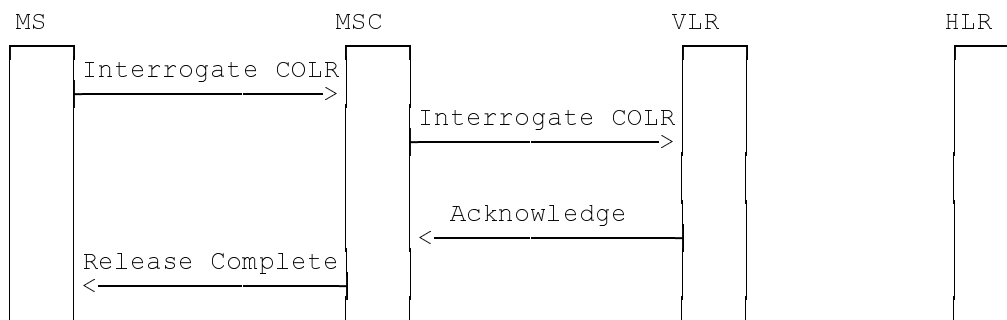

Figure 4.1: Interrogation of connected line identification restriction

4.2 Functions and information flows

The following Mobile Additional Functions have been identified for the PLMN:

MAF040

Determination of the connected line identification restriction subscription

The ability of a PLMN component to determine whether the supplementary service is provisioned for the mobile subscriber. See figure 4.2.

Location: VLR.

MAF041

Determination of the connected party number for offering to the calling party

The ability of a PLMN component to determine and to forward the connected line identity and related indications to the calling party. See figure 4.3.

Location: terminating MSC.

The information flow is shown in figures 4.4.

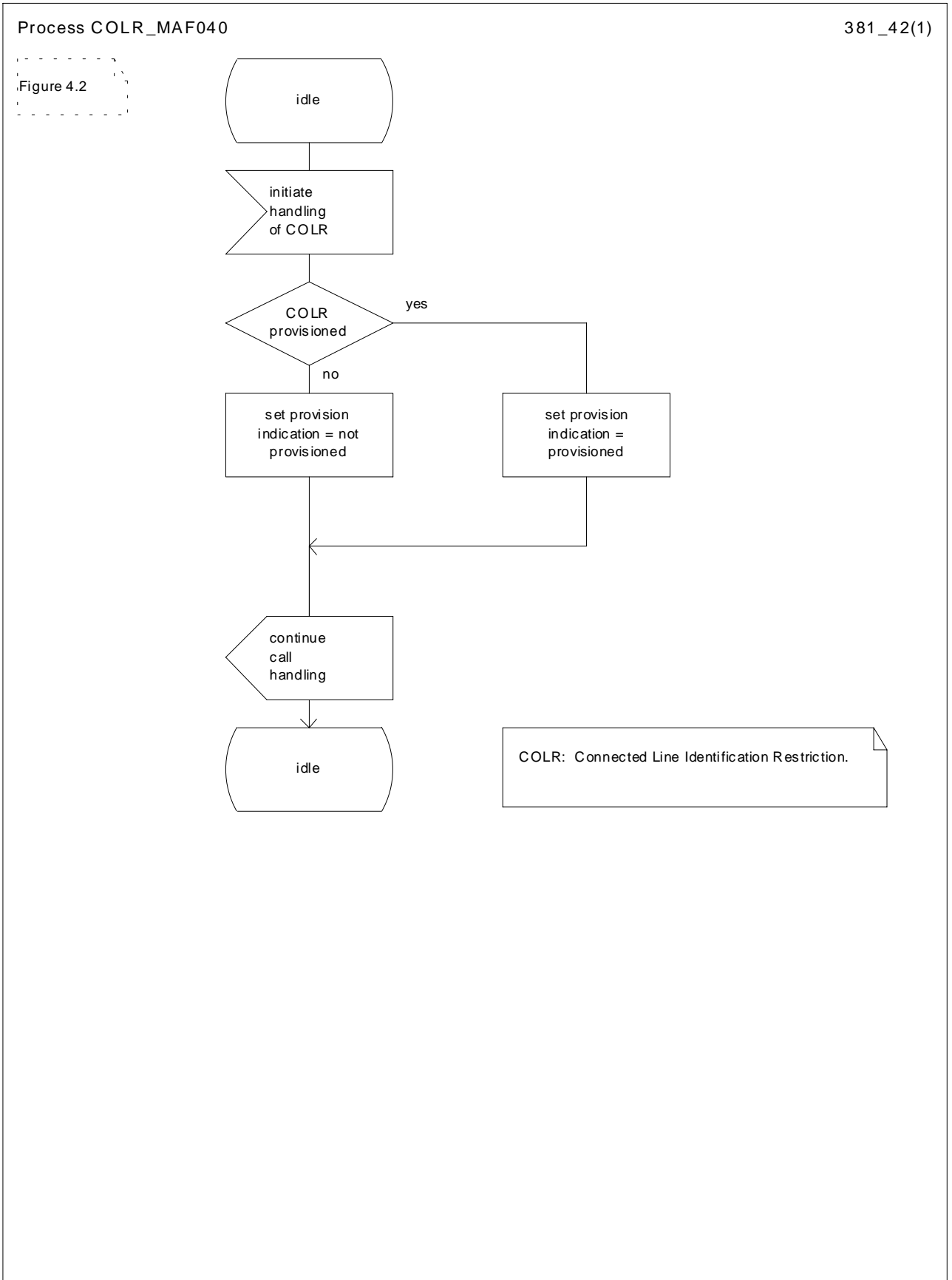

Figure 4.2: MAF040 Determination of connected line identification restriction subscription (VLR)

Process COLR_MAF041

381_43(1)

Figure 4.3

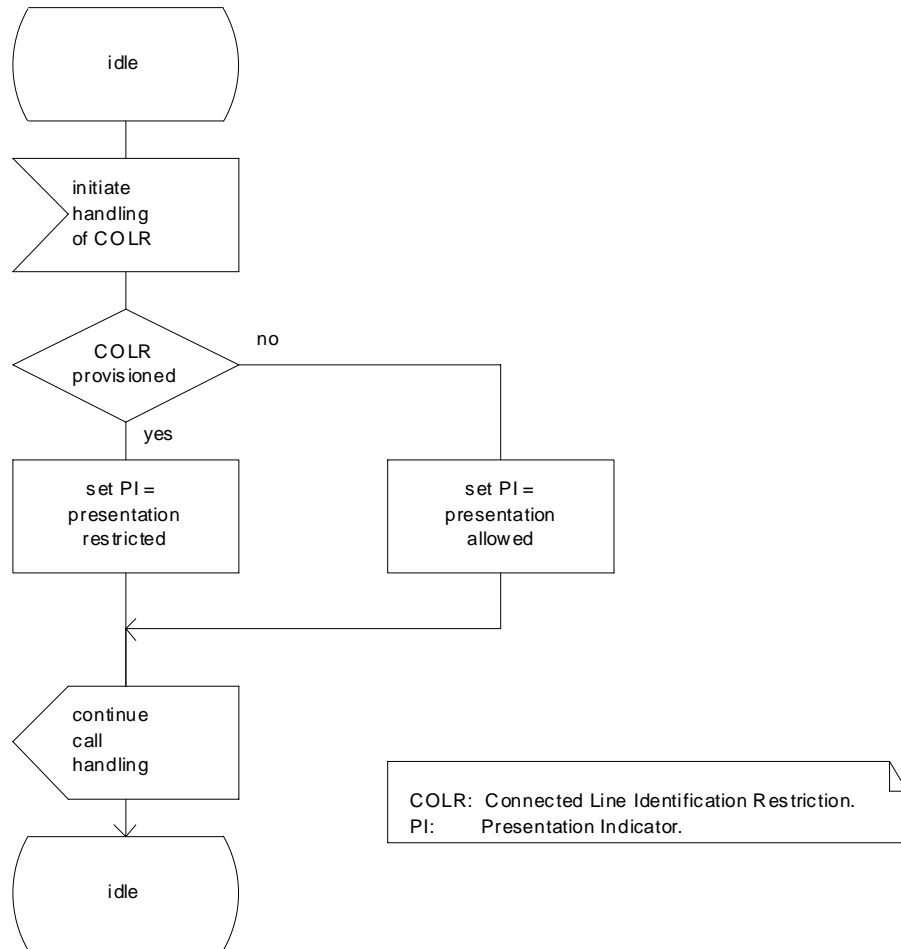
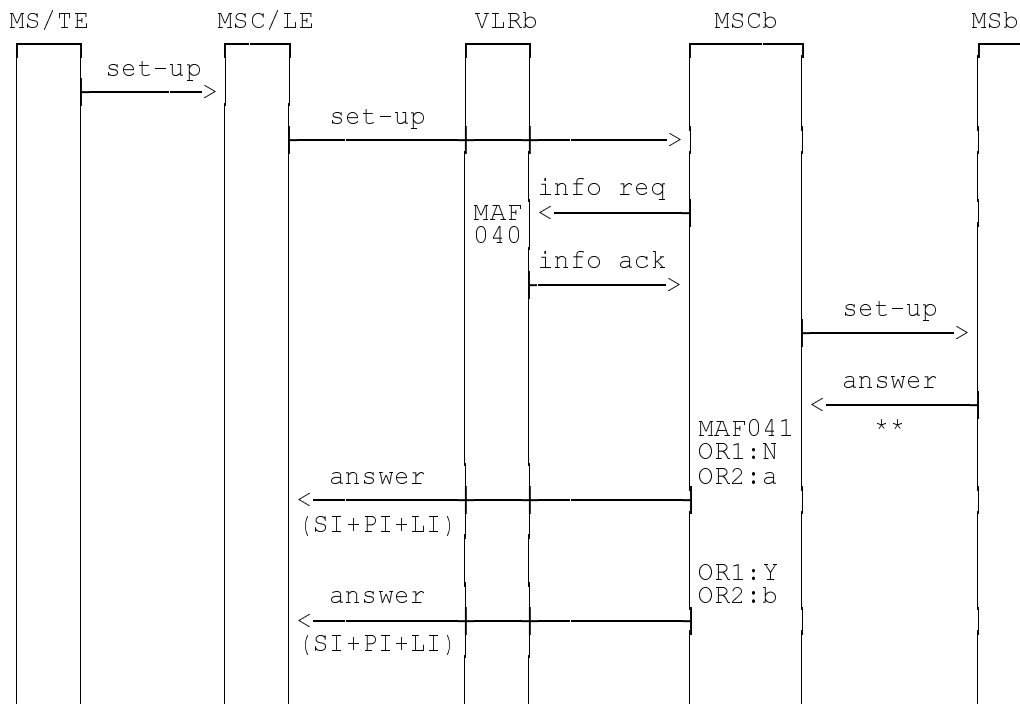

Figure 4.3: MAF041 Determination of the presentation indicator



NOTE: OR1: COLR provisioned Y: yes N: no
OR2: Presentation Indicator Value a: allowed b: restricted
OR3: Override category
**: A subaddress may be received from the MS
info: information SI: screening indicator
req: request PI: presentation indicator
ack: acknowledge LI: line identity

Figure 4.4: Information flow for connected line identification restriction: mobile station or fixed terminal to mobile station

4.3 Information stored in the HLR

COLR may have the following logical states (refer to TS GSM 03.11 for an explanation of the notation):

Provisioning State	Registration State	Activation State	HLR Induction State
(Not Provisioned,	Not Applicable,	Not Active,	Not Induced)
(Provisioned,	Not Applicable,	Active and Operative,	Not Induced)

The HLR shall store the logical state of COLR (which shall be one of the valid states listed above) on a per subscriber basis.

4.4 State transition model

The following figure shows the successful cases of transition between the applicable logical states of COLR. The state changes are caused by actions of the service provider.

Note that error cases are not shown in the diagram as they normally do not cause a state change. Additionally, some successful requests may not cause a state change. Hence they are not shown in the diagram.

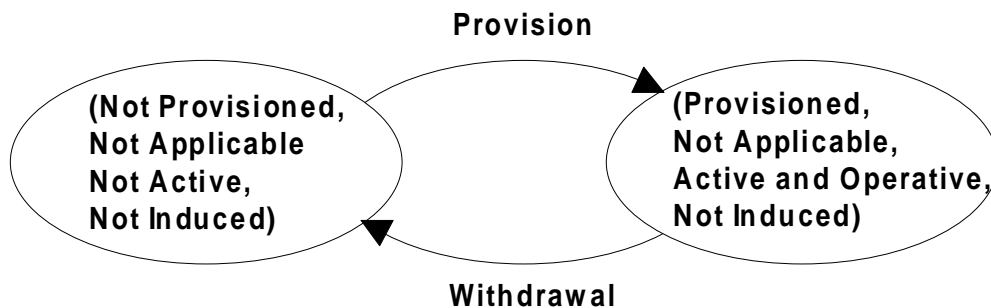

Figure 4.5: State transition model for COLR

4.5 Transfer of information from HLR to VLR

When the subscriber registers on a VLR, the HLR shall send that VLR information about the logical state of COLR.

If the logical state of COLR is changed while a subscriber is registered on a VLR then the HLR shall inform the VLR of the new logical state of COLR.

4.6 Information stored in the VLR

For COLR, the VLR shall store the service state information received from the HLR.

4.7 Handover

Handover will have no impact on the control procedures and the operation of the service.

4.8 Interworking

The VPLMN needs to distinguish three cases in order to meet data privacy requirements in an environment where support of COLP and COLR is optional:

- a) the HPLMN supports COLR, and COLR is provisioned for the subscriber;
- b) the HPLMN supports COLR, but COLR is not provisioned for the subscriber;
- c) the HPLMN does not support COLR.

In case a) the VPLMN must apply the COLR subscription as indicated by the data sent by the HPLMN.

In case b) the VPLMN must not apply COLR.

In case c) the VPLMN must apply an implicit COLR subscription.

To allow the VPLMN to make this distinction, the HLR and VLR behave as follows:

- If the HLR supports COLR, but COLR is not provisioned for the subscriber, the HLR shall inform the VLR that COLR is not provisioned.
- If the VLR supports COLR, but the HLR does not support COLR, the VLR shall behave in the same way as if COLR was provisioned for the subscriber, i.e. the connected line identity shall not be displayed to the calling subscriber unless the calling subscriber has COLR override capability. When interrogating the service status the subscriber shall be informed that COLR is provided to him and is active.

Annex A (informative): Status of Technical Specification GSM 03.81

Status of Technical Specification GSM 03.81		
Date	Version	Remarks
		No phase 1 version
January 1992	version 4.0.0	TS approved by SMG#01
June 1992	version 4.0.1	CR 03.81-01 (category D) approved by SMG#03
January 1993	version 4.0.2	CR 03.81-02 (category D) approved by SMG#05 CR 03.81-03 (category D)
April 1993	version 4.1.0	CR 03.81-04 rev 3 (category C) approved by SMG#06 Reference to MCI removed TS frozen for phase 2 by SMG#06
October 1993	version 4.1.1	TS changed to draft prETS 300 542
January 1994	version 4.2.0	CR 03.81-06 rev 1 (category F) approved by SMG#09
April 1994	version 4.3.0	CR 03.81-05 rev 4 (category F) approved by SMG#10 CR 03.81-08 (category F)
July 1994	version 4.4.0	CR 03.81-07 rev 2 (category F) approved by SMG#11
October 1994	version 4.5.0	CR 03.81-10 rev 1 (category F) approved by SMG#12 CR 03.81-11 rev 1 (category F) CR 03.81-12 (category F) CR 03.81-13 rev 1 (category F) CR 03.81-14 (category F) TS changed to final draft prETS 300 542
January 1995	version 4.5.1	TS changed to ETS 300 542 First edition
June 1996	version 4.6.0	CR 03.81-A003 rev 1 (category F) approved by SMG#19
1996	version 4.6.1	TS changed to ETS 300 542 Second edition
December 1997	version 4.7.0	CR 03.81-A004 rev 3 (category F) approved by SMG#24 WI: CAMEL Phase 1: Section 0.2.1.1 and 0.2.1.2: Definition of additional line identity Figs 1.3/1.4: Update of MAF002 and Information flow for CLIP Figs 3.3/3.5: Update of MAF006 and Information flow for COLP
June 1998	version 4.8.0	CR 03.81-A006 rev 2 (category F) approved by SMG#26 CR 03.81-A008 rev 1 (category F) (TEI)
Text and figures: WinWord 6.0 Stylesheet: C:\msoffice\templates\etsiw_61.dot		

History

Document history			
October 1993	Public Enquiry	PE 51:	1993-11-01 to 1994-02-25
November 1994	Vote	V 69:	1994-11-21 to 1995-01-13
March 1995	First Edition		
October 1996	Unified Approval Procedure (Second Edition)	UAP56:	1996-10-21 to 1997-02-14
March 1997	Second Edition		
August 1998	One-step Approval Procedure (Third Edition)	OAP 9852:	1998-08-28 to 1998-12-25
January 1999	Third Edition		