

ETSI-GSM
Technical
Specification

GSM 11.20-DCS
Version 3.13.0

UDC: 621.396.21

Key words: Digital Cellular Telecommunications System, Global System for Mobile Communications (GSM)

GSM
DCS 1800 Base Station Specification

ETSI

European Telecommunications Standards Institute
ETSI Secretariat: F-06921 Sophia Antipolis Cedex . France
Tel. + 33 92 94 42 00 Fax. + 33 93 65 47 16

Copyright European Telecommunications Standards Institute 1992.
All rights reserved.

No part may be reproduced or used except as authorised by contract or other written permission. The copyright and the foregoing restriction on reproduction and use extend to all media in which the information may be embodied.

PREFATORY NOTE

ETSI has constituted stable and consistent documents which give specifications for the implementation of the European Cellular Telecommunications System. Historically, these documents have been identified as "GSM recommendations".

Some of these recommendations may subsequently become Interim European Telecommunications Standards (I-ETSS) or European Telecommunications Standards (ETSS), whilst some continue with the status of ETSI-GSM Technical Specifications. These ETSI-GSM Technical Specifications are for editorial reasons still referred to as GSM recommendations in some current GSM documents.

The numbering and version control system is the same for ETSI-GSM Technical Specifications as for "GSM recommendations".

ETSI/TC SMG

Date : February 1996

Released by : ETSI/PT12/48V

UPDATE NOTE

ETSI Technical Specification GSM 11.20-DCS

GSM DCS 1800 Base Station Specification

Previously Updated version : 3.2.0 (April 1992)
Previously Updated version : 3.3.0 (June 1992)
Previously Updated version : 3.4.0 (November 1992)
Previously Updated version : 3.5.0 (January 1993)
Previously Updated version : 3.6.0 (April 1993)
Previously Updated version : 3.7.0 (June 1993)
Previously Updated version : 3.8.0 (October 1993)
Previously Updated version : 3.9.0 (February 1994)
Previously Updated version : 3.10.0 (April 1994)
Previously Updated version : 3.11.0 (July 1994)
Previously Updated version : 3.12.0 (October 1994)
New Updated version : 3.13.0 (February 1996)

1. Reason for Change

Changes agreed at SMG#17 (Edinburgh) as listed in section 2 are included.

2. Details of Change

CR	Section Modified	Title	Ref SMG Doc
11.20-128	as below	This CR incorporates the three CRs listed below which have previously been approved for 11.20, but not incorporated into GSM 11.20-DCS	076/96
11.20-125	Section 2	Testing of spurious emissions	259/95
11.20-126	Section 2	Testing of conducted spurious emissions from power leads	565/95
11.20-127	Section 1	Updating scope of GSM 11.20	565/95

END OF UPDATE NOTE

ETSI/TC SMG

Updated by: ETSI/PT12/48V

Date: February 1996

ETSI TECHNICAL SPECIFICATION GSM 11.20-DCS
DCS 1800 Base Station System Equipment Specification
Version 3.13.0

Table of Contents

Note: GSM 11.20-DCS consists of GSM 11.20 V3.19.0 with the following parts/pages replaced by those contained in this specification.

Section	Title	Version	Number of pages
Section 1 (Complete section)	General	3.13.0	10
Section 2, (pages 2-1 to 2-44, plus page 2-10a, 2-26a and 2-28a)	Radio Interface	3.13.0	47
Section 5, (pages 5-7 to 5-10, plus 5-23 and 5-24)	Base Station System Network Aspects	3.13.0	6
Section 6, (pages 6-31 to 6-34)	Base Station Controller Network Aspects	3.13.0	4
Section 7 (pages 7-33 to 7-50)	Base Transceiver Station Network Aspects	3.13.0	18
Annex 1 (Complete section)	General Testing Methodology	3.13.0	17
Appendix 1 (Complete section)	Number Of Samples Needed For Statistical Testing	3.13.0	9

Note: Where references are made to the GSM series of specifications this shall be taken as the series as modified by the DCS 1800 delta specifications.

1. GENERAL

=====

1.1. SCOPE

This specification contains the technical specifications for the testing of the Base Station System (BSS) of the Pan European ~~Digital Mobile Radio~~ Cellular System at 1800 MHz (DCS 1800GSM), meeting Phase 1 GSM requirements.

This specification does not contain EMC requirements for the BSS. This is specified in ETS 300 342-2; Electromagnetic compatibility (EMC) for European digital cellular telecommunication system (GSM 900MHz and DCS 1800MHz) Part 2: Base station radio and ancillary equipment. ETS 300 342-2 contains extracts from, and references to, parts of GSM 11.20 for the following EMC requirements:

- radiated emissions
- emissions, antenna ports (conducted spurious emissions from transmitter and receiver antenna connectors)
- immunity, receiver antenna port (blocking)

These technical specifications may be used as a basis for procurement and acceptance of BSSs by administrations and GSM Operators.

They do not necessarily include all the characteristics which may be required, nor do they necessarily represent the optimum performance achievable. The national administrations or GSM operators may set additional requirements.

The standardized tests in this specification are performed without any traffic load. Testing of a GSM Base Station System under traffic load conditions are outside the scope of this specification. Load testing of a BSS is a national or operator specific matter. The load testing of a BSS under traffic load may differ depending on the internal structure of a BSS. It should be noted, however, that verification of a BSS under traffic load conditions is very important.

The specifications are produced such that BSSs of different manufacturers can be connected to Mobile services Switching Centres (MSCs) of different manufacturers.

In the case of a BSS consisting of separate Base Station Controller (BSC) and one or several Base Transceiver Stations (BTSs), also these shall be interconnectable even if they are produced by different manufacturers.

It is the aim that the tests described in this specification shall be possible to perform in an automated manner with a minimum of man-machine interventions, however, such that no restrictions are placed upon the test method.

The tests in this equipment specification are based upon the full set of specifications in the GSM-series of specifications, as amended by the DCS 1800 delta-recommendations. In case of any inconsistency between this specification and the source specifications, the source specifications shall prevail.

The tests are for guidance to GSM operators for acceptance testing of Base Station Systems. It is a national or operator specific matter whether or not to perform the full set of tests. However, all the requirements are intended as mandatory unless otherwise stated. Some tests are only to be carried out if a specific option is implemented in the BSS and some requirements are included for guidance only. Some sections are also included for guidance only.

1.2. INTRODUCTION

The Base Station Systems (BSSs) specified in these specifications have to interface with:

- the Mobile Stations (MSs) over the radio interface as by the GSM 04 and 05-series of specifications,
- the Mobile Switching Centre (MSC) over the A-interface (MSC/BSS-interface) given in the GSM 08.0x-series of specifications,
- the Operation and Maintenance Centre (OMC) over the OMC-interface given in the GSM 08.0x and GSM 12.xx-series of specifications,
- the power supply,
- the environment.

In addition to these interfacing requirements the GSM Base Station systems are also defined by:

- the network and network management functions to be performed in the Base Station Systems as given in the GSM 04, 08 and 12-series of specifications,
- the transmission requirements through the Base Station System from the radio interface to a 64 kbit/s interface according to GSM 03.50 and the GSM 06-series of specifications,
- the internal BSC/BTS-interface (A-bis-interface), if used, as given in the GSM 08.5x and 08.6x-series of specifications.

The general structure of a GSM Public Land Mobile Network (PLMN) is illustrated in GSM 01.02.

A Base Station System (BSS) communicates with a number of Mobile Stations over a set of logical channels being constructed of physical channels over the radio path. The total number of logical channels in a BSS depends on the capacity needed in the BSS. The logical channel structures and access capabilities on the radio interface in a BSS are described in GSM 04.03.

A BSS communicates on the network side with the Mobile services Switching Centre (MSC) by passing the various logical channels over the A-interface (MSC/BSS-interface) as described in the GSM 08.0x-series of specifications.

The BSS also communicates with an Operations and Maintenance Centre (OMC), which performs remote network management functions, over the A-interface. Optionally a separate OMC-interface may also be provided. Irrespective of whether the A-interface or separate OMC-interface is used, throughout this specification the interface towards the OMC is referred to as the OMC-interface.

This equipment specification is structured as follows:

Section 1 includes definitions of BSS types and BSS related entities.

Section 2 contains the tests for the air interface including basic RF tests and generally tests of Layer 1 and Layer 2 functions.

Section 3 defines the Layer 1 and Layer 2 tests for the internal A-bis-interface.

Section 4 defines the Layer 1 and Layer 2 tests for the A-interface.

Section 5 verifies the network functions and transmission requirements for the integrated BSS. The network functions include the Layer 3 tests for the air interface and A-interface as well as transcoding and rate adaptation tests.

Section 6 verifies the network functions and transmission requirements for the BSC. The network functions include the Layer 3 tests for the A-bis-interface and A-interface as well as transcoding and rate adaptation tests.

Section 7 verifies the network functions and transmission requirements for the BTS. The network functions include the Layer 3 tests for the air interface and A-bis-interface as well as transcoding and rate adaptation tests.

Section 8 contains the lower layer aspects of Network Management interfacing for an integrated BSS, ie interfacing with the OMC. The Network Management functions at the application layer are tested in GSM 11.21.

Section 9 contains the lower layer aspects of Network Management interfacing for a BSC, ie interfacing with the OMC. The Network Management functions at the application layer are tested in GSM 11.21.

Section 10 contains the lower layer aspects of Network Management interfacing for a BTS, ie O&M interfacing with the OMC via the A-bis-interface. The Network Management functions at the application layer are tested in GSM 11.21.

Section 11 summarizes the test points and interfaces which are required in the BSS for operation and for acceptance testing.

Annex 1 gives general requirements on the test methods.

Annex 2 gives a list of relevant specifications for this BSS equipment specification.

Annex 3 gives physical and test parameters for fixed GSM and co-located equipment.

Annex 4 shows the elementary Layer 3 procedures for Radio Resource management (RR) and gives background information for the Layer 3 tests of the various BSS parts, BSC or BTS or the BSS as a whole.

1.3. DEFINITION OF BASE STATION SYSTEM TYPES

The BSS includes normally one set of transceivers covering the same radio coverage area consisting of a set of adjacent cells, ie an integrated BSS at one site, but may also consist of several sets of transceivers covering several radio coverage areas. In this case the functional structure in fig 1-1 applies. A set of Transceivers (TRXs) covering the same radio coverage area, ie a cell as seen by the MSs and by the network, is referred to as a Base Transceiver Station (BTS). The BTS includes in addition to the TRXs a Base Control Function (BCF) which performs common control functions in the BTS. The BTS is controlled by a Base Station Controller (BSC) over the A-bis-interface, which is optional for implementation by GSM network operators. A BSC may control several BTSSs.

The location of the equipment performing the transcoding function to 64 kbit/s can also optionally be located internally or externally (ie colocated with the MSC) to the BSS equipment. A complete BSS, as defined by the radio interface and the A-interface, includes, however, functionally the transcoding equipment. If the transcoding is performed in the BSC, four 16 kbit/s channels may be multiplexed into one 64 kbit/s channel. This multiplexing is, however, up to the operator.

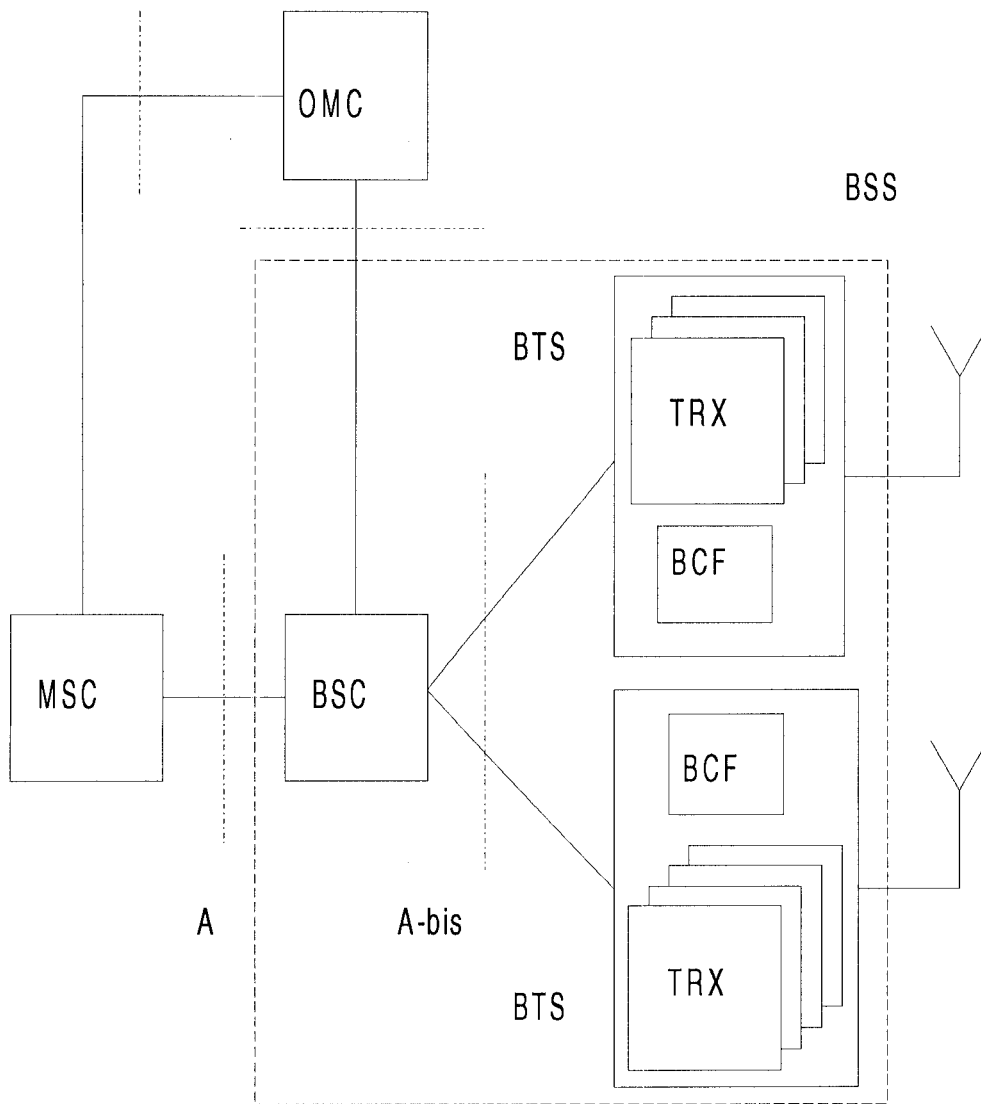

BSS=Base Station System
 BSC=Base Station Controller
 BTS=Base Transceiver Station
 BCF=Base Control Function
 TRX=Transceiver
 OMC=Operations and Maintenance Centre

Figure 1-1: Configuration of the Base Station System (BSS) when the A-bis-interface and the separate OMC-interface are implemented

The possible Base Station System types in the GSM system are consequently as indicated below and in Table 1-1:

- BSS type 1: BSS with internally located transcoding and no internal BSC/BTS-interfaces
- BSS type 2: BSS with externally located transcoding and no internal BSC/BTS-interfaces
- BSS type 3: BSS with transcoding in BTSs and internal BSC/BTS-interfaces (64 kbit/s A-bis-interface)
- BSS type 4: BSS with transcoding in BSC and internal BSC/BTS-interfaces using multiplexing of four 16 kbit/s channels into 64 kbit/s (16 kbit/s A-bis-interface)
- BSS type 5: BSS with transcoding in BSC and internal BSC/BTS-interfaces without multiplexing of 16 kbit/s channels (16/64 kbit/s A-bis-interface)
- BSS type 6: BSS with externally located transcoding and internal BSC/BTS-interfaces using multiplexing of four 16 kbit/s channels into 64 kbit/s (16 kbit/s A-bis-interface)
- BSS type 7: BSS with externally located transcoding and internal BSC/BTS-interfaces without multiplexing of 16 kbit/s channels (16/64 kbit/s A-bis-interface)

BSS type:	Integr./ distr. BSS:	A-bis-int. net bit rate:	Int./ext. transc. to BSC:	Multiplexed/ rate adapted A-bis-int.:
1	Int.	-	Int.	-
2	Int.	-	Ext.	-
3	Distr.	64	-	-
4	Distr.	16	Int.	Mult.
5	Distr.	16	Int.	Rate
6	Distr.	16	Ext.	Mult.
7	Distr.	16	Ext.	Rate

Table 1-1: Overview of BSS types in GSM

It should be noted that BBS types 5 and 7 may be modified to BSS types 4 and 6, respectively, simply by adding external multiplex equipment to them on each side of the A-bis-interface.

BSS type 1
(BSS to TRAU
interface
internal)

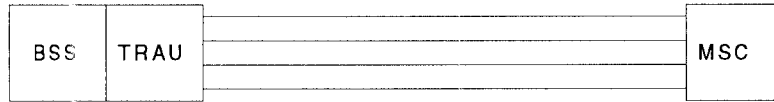

BSS type 2
(BSS to TRAU
interface
external)

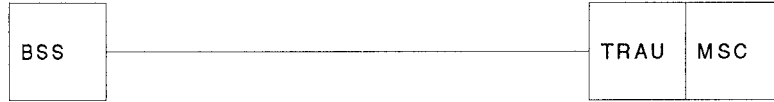

BSS type 3
(BTS to TRAU
interface
internal)

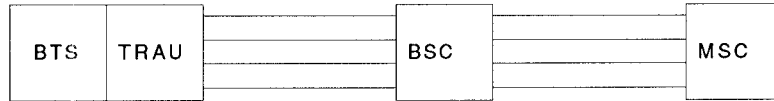

BSS type 4
(BTS to TRAU
interface
external)

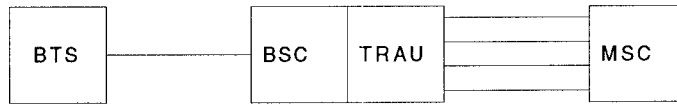

BSS type 5
(BTS to TRAU
interface
external)

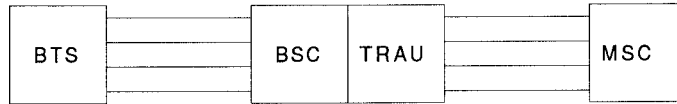

BSS type 6
(BTS to TRAU
interface
external)



BSS type 7
(BTS to TRAU
interface
external)

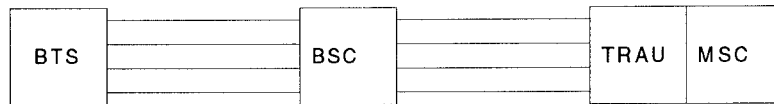

Figure 1-2: Supporting 4 TCHs in each GSM BSS type

Figure 1-2 is drawn to show the number of 64 kbit/s links required for each BSS type in order to support 4 traffic channels. However, the main message it conveys is to show whether the interface between the transcoder and the BSS and the transcoder and the BTS is internal (proprietary) or the inband remote control interface defined in GSM 08.60. For the lower layers, the BSC performs only a switching / routing function and hence its interface is driven by that of the BTS and the location of the transcoder.

The text that follows in the next two paragraphs is tabulated for quick reference in Table 1-2.

If the transcoder to BSS / BTS interface is internal, then in the case of the BSS, the BSS and the transcoder are tested using section 5. However, in the case of the BTS, the transcoder is tested using sections 5.1.4 and 5.2 and the BTS is tested using section 6, except for the transcoder tests in the sections 6.1.4, 6.2, 6.3 and 6.4, which are now not performed. When using sections 5.1.5 and 5.2 to test a transcoder internal to a BTS, occurrences of the word BSS shall be interpreted as the BTS internal interface to the transcoder.

If the transcoder to BSS / BTS interface is external due to the location of the transcoder at either the BSC site or the MSC site, then the inband remote control interface will exist as defined in GSM 08.60 between the transcoder and the BSS / BTS (BSC only switches). In these cases, the transcoder is always tested using sections 6.1.4, 6.2, 6.3 and 6.4. In the case of a BTS, it is tested using section 7. In the case of a BSS, it is tested using section 5, except the transcoder tests in sections 5.1.4 and 5.2, are now replaced by tests which check correct operation of the BSS to transcoder remote control interface i.e., those found in sections 7.1.4, 7.2, 7.3 and 7.4. When using sections 7.1.4, 7.2, 7.3 and 7.4 to test the BSS transcoder interface, occurrences of the word BTS shall be interpreted as the BSS interface to the external transcoder.

BSS type	section	applies to	section	applies to
1	5-5.1.3	BSS	5.1.4-5.2	transcoder
2	5-5.1.3 7.1.4-7.4	BSS BSS	6.1.4-6.4	transcoder
3	6-6.1.3 7-7.1.3	BSC BTS	5.1.4-5.2	transcoder
4	6-6.1.3 7	BSC BTS	6.1.4-6.4	transcoder
5	6-6.1.3 7	BSC BTS	6.1.4-6.4	transcoder
6	6-6.1.3 7	BSC BTS	6.1.4-6.4	transcoder
7	6-6.1.3 7	BSC BTS	6.1.4-6.4	transcoder

Table 1-2: Transcoding testing reference table

In addition several classes of Base Station Systems are defined by the fact that Slow Frequency Hopping (SFH), downlink Discontinuous Transmission (DTX) and downlink RF power control are optional for implementation in the BSS:

- BSS class 1: No SFH, no power control, no downlink DTX
- BSS class 2: No SFH, power control, no downlink DTX
- BSS class 3: SFH, no power control, no downlink DTX
- BSS class 4: SFH, power control, no downlink DTX
- BSS class 5: No SFH, no power control, downlink DTX
- BSS class 6: No SFH, power control, downlink DTX
- BSS class 7: SFH, no power control, downlink DTX
- BSS class 8: SFH, power control, downlink DTX

1.4. DEFINITIONS AND ABBREVIATIONS

A comprehensive list of defined terms used in the GSM specifications can be found in GSM 01.04. The following definitions and abbreviations are also included in this recommendation.

1) Base Station System (BSS)

The system of Base Station equipments (transceivers, controllers etc) which is viewed by the MSC through a single interface as defined by the GSM 08.0x-series of specifications being the entity responsible for communicating with Mobile Stations in a certain area.

The radio equipment in a BSS may cover one or more cells. If an internal A-bis-interface according to the GSM 08.5x-series and GSM 08.6x-series of specifications is implemented, the BSS shall consist of one Base Station Controller (BSC) and several Base Transceiver Stations (BTSs). The functionality of a BSS is given in GSM 08.02.

2) Base Station Controller (BSC)

A network component in the PLMN with the functions for control of one or more Base Transceiver Stations (BTSs).

3) Base Transceiver Station (BTS)

A network component which serves one cell in the cellular network and is controlled by a Base Station Controller (BSC). The BTS contains one or more Transceivers (TRXs).

4) Integrated Base Station System (BSS)

A BSS without any internal A-bis-interfaces.

5) Base Control Function (BCF)

A functional entity which handles common control functions within a Base Transceiver Station (BTS).

6) Transceiver (TRX)

A network component which can serve full duplex communication on 8 full-rate traffic channels according to recommendation GSM 05.02. If SFH is not used, the TRX serves the communication on one RF carrier.

7) Mobile services Switching Centre (MSC)

The MSC provides the interface between the PLMN and the PSTN. The MSC interfaces the PSTN on one side and the BSSs on the other side and performs all necessary functions in order to handle the calls to and from the Mobile Stations.

8) Mobile Station (MS)

A station in the mobile service intended to be used while in motion (quoted from the radio regulations no 67).

9) Operations and Maintenance Centre (OMC)

A network management entity used for remote operations and maintenance of the PLMN. The network management functions for the PLMN need to be monitored and controlled by one or more OMCs.

10) Base Station System Test Equipment (BSSTE)

A functional unit which may be used for acceptance testing of GSM Base Station Systems.

11) Cell

The area of radio coverage locally defined as seen by the Mobile Stations with a Base Station Identity Code (BSIC) and uniquely defined as seen by the network with a global Cell Identity (CI).

2. RADIO INTERFACING
=====

The tests in this section apply to an integrated BSS as well as to a BTS.

2.1. PHYSICAL INTERFACE

The physical radio interface, Layer 1, is specified in the GSM 05 series of specifications. The physical channels consist of a sequence of timeslots and a sequence of RF carriers as described in GSM 05.02 resulting in a modulation rate of 270.833 kbit/s (1625/6) accommodating 8 full rate users of speech or data. The modulation is according to GSM 05.04 and results in a carrier spacing of 200 kHz according to GSM 05.05. The interworking with the Layers 2 and 3 of the OSI model is described in GSM 04.04.

2.1.1. Frequency bands

The frequency band for the Base Station System is given in Table 2-1.

TX:	RX:
935-960 MHz	890-915 MHz
1805-1880 MHz	1710-1785 MHz

Table 2-1: Frequency bands for GSM Base Station Systems

It is up to the ~~GSM-PLMN~~ DCS 1800 operator to choose any subset of the carrier frequencies in this band (or the complete set) on a location basis.

2.1.2. Channels and channel numbering

The carrier frequencies (RF channels) have the following numbers and frequencies according to GSM 05.05 (n = carrier number, n = 1 to 124):

$$\begin{aligned}
 & \text{F1}(n) = 890.200 \text{ MHz} + (n-1) \times 0.200 \text{ MHz} && \text{(lower band = RX)} \\
 & \text{Fu}(n) = \text{F1}(n) + 45.000 \text{ MHz} && \text{(upper band = TX)} \\
 & \text{F1}(n) = 1710.200 \text{ MHz} + (n-512) \times 0.200 \text{ MHz} && \text{(lower band = RX)} \\
 & \text{Fu}(n) = \text{F1}(n) + 95.000 \text{ MHz} && \text{(upper band = TX)} \\
 & (512 \leq n \leq 885)
 \end{aligned}$$

Many tests in section 2.1 shall be performed with appropriate frequencies in the bottom, middle and top of the operating frequency band specified by the operator or by the manufacturer. These are denoted as RF channels B, M and T.

2.1.3. Frequency hopping

Slow frequency hopping (SFH) may optionally be implemented in each Base Station System as an operator choice. The BSS shall be able to switch to any frequency in the GSM band allocated to this BSS on a timeslot per timeslot basis.

The detailed description of the frequency hopping scheme is described in GSM 05.02. The switching requirements for SFH appears in section 2.1.6 and 2.1.7 in accordance with GSM 05.05.

2.1.4. RF power control

RF power control functions may optionally be implemented in GSM Base Station Systems according to GSM 05.08. If applicable, the BSS shall be able to hop between any defined power level on a timeslot per timeslot basis. The switching and stability requirements appear in section 2.1.6 in this specification. Other requirements in this specification apply whether RF power control is supported or not.

2.1.5. Downlink discontinuous transmission (DTX)

Downlink discontinuous transmission (DTX), as defined in the GSM 06-series of specifications for full-rate speech channels and in GSM 04.22 and GSM 08.20 for non-transparent data, may optionally be implemented in the downlink BSS (transmitter). All requirements in this specification, unless otherwise stated, apply whether downlink DTX is used or not.

2.1.6. Transmitters

All tests in this section shall be conducted on Base Station Systems fitted with a full complement of Transceivers for the configuration. Measurements shall be made at the BSS Tx antenna connector (including any TX combiner) or at internal test points and interfaces as defined in section 11.2 in this specification, unless otherwise stated.

Unless otherwise stated the tests in this section shall be performed under normal and extreme test conditions.

Power levels are expressed in dBm, assuming a 50 ohms impedance.

2.1.6.1. Static Layer 1 functions

DEFINITION

The static Layer 1 transmitter functions verified in these tests are the RF parts, the multiplexing and multiple access functions, the enciphering functions, the interleaving and the channel encoding on the transmit side. For further information see GSM 05.01, GSM 05.02, GSM 05.03 and GSM 05.05.

METHOD OF MEASUREMENT

If Slow Frequency Hopping (SFH) is supported by the BSS, the BSS shall be hopping over the maximum range and number of carriers possible for the test environment and which are available in the BSS configuration. If SFH is not supported, the test shall be performed for the radio frequency channels B, M and T. In both cases the tests shall be repeated with varying RF equipment until all the RF equipment in the BSS configuration is tested on all available carrier frequencies.

The BSS shall be transmitting a normal GSM modulated signal and the signal shall be received in the BSSTE. A known bit sequence exceeding a length of a superframe (1326 TDMA-frames) shall be input before channel encoding in the BSS and a bit sequence shall be output after channel decoding in the BSSTE. The propagation conditions shall be static and non-limiting for the measurement.

All channel types shall be tested.

REQUIREMENTS

The output bit sequence shall be bit exact for all channel types.

2.1.6.2. Modulation, phase error and mean frequency error

DEFINITION

The GSM modulation scheme is Gaussian Minimum Shift Keying (GMSK) with normalized bandwidth $BT=0.3$. This measurement verifies the correct implementation of the GMSK pulse shaping filtering (equivalent premodulation filter) and the suppression of all contributions to frequency error and phase error during the active part of a timeslot.

For further information see GSM 05.04, GSM 05.05 and GSM 05.10.

METHOD OF MEASUREMENT

All carriers in the configuration shall be switched on transmitting full power in all timeslots for 1 hour. Then the following measurement shall be carried out.

If Slow Frequency Hopping (SFH) is supported by the BSS, the BSS shall be hopping over the maximum range and number of carriers possible for the test environment and which are available in the configuration. If SFH is not supported, the test shall be performed for the radio frequency channels B, M and T. In both cases the test shall be repeated for each RF equipment existing in the configuration.

The transmitted signal from the BSS shall be extracted in the BSSTE for a pseudo-random known bitstream of encrypted bits into the BSS modulator. The pseudo-random bitstream shall be any 148 bit subsequence of the 511 bit pseudo-random bitstream defined in recommendation CCITT V.52. This pseudo-random bitstream may be generated by another pseudo-random bitstream inserted before channel encoding in the BSS and shall generate at least 200 different bursts. The phase trajectory (phase versus time) for the useful part of the timeslots (147 bits in the centre of the burst - see GSM 05.04 and GSM 05.10 for further information) shall be extracted with a resolution of at least 2 samples per modulating bit. The RF receiver parts of the BSSTE are assumed not to be limiting the measurement.

The theoretical phase trajectory from the known pseudo-random bitstream shall be calculated in the BSSTE for a GMSK pulse shaping.

The phase difference trajectory shall be calculated as the difference between the measured and the theoretical phase trajectory. The mean frequency error across the burst shall then be calculated as the derivative of the regression line of the phase difference trajectory. The regression line shall be calculated using the Mean Square Error (MSE) method.

The phase error is then finally the difference between the phase difference trajectory and its linear regression line.

REQUIREMENTS

The phase error shall not exceed:

5 degrees rms
20 degrees peak

The mean frequency error across the burst shall not exceed:

0.05 ppm

The requirements apply whether Slow Frequency Hopping (SFH) is used or not in the BSS. The requirements apply to each burst under normal and extreme test conditions and exposed to vibration (see Annex 1).

2.1.6.3. Mean transmitted RF carrier power

DEFINITION

The mean transmitted RF carrier power is the power delivered to the TX combiner on the radio frequency channel under test. This test verifies the power step accuracy across the frequency range.

For further information see recs GSM 05.05 and GSM 05.08.

METHOD OF MEASUREMENT

For this specific measurement the power shall be measured at the input of the TX combiner. However, the measurement method can be directly applied also to the output of the TX combiner, but in that case it is up to the network operator to specify the power level requirements. If measured at the output of the TX combiner, the TX combiner shall have the maximum number of carriers connected to it so that the measurement can be used as a reference for the measurement of transmitted carrier power versus time in section 2.1.6.4.

All carriers in the configuration shall be switched on transmitting full power in all timeslots for 1 hour. Then the following measurement shall be carried out.

The BSS shall be configured with the radio frequency channels B, M and T. If SFH is supported by the BSS, the BSS shall be hopping over these 3 frequencies.

The BSS under test shall be set to transmit 3 adjacent timeslots in a TDMA-frame at the same power level. The power level shall then be measured on a timeslot basis over the useful part of the middle timeslot averaged over more than 1000 timeslots. Only timeslots with a power level higher than ~~40 dB~~ -25 dB relative to the expected value shall be included in the averaging process. Whether SFH is supported or not, the measurement shall be carried out on all of the 3 frequencies in turn.

For the definition of useful part of the timeslot see Figure 2-1, and for further details GSM 05.04 and GSM 05.10. For timing on a per timeslot basis each timeslot may contain 156.25 modulating bits, or 2 timeslots may contain 157 and 6 timeslots 156 modulating bits according to GSM 05.10.

The power shall be measured at each nominal power level as specified below or by the manufacturer or by the operator. The test shall be repeated with varying RF equipment until each RF equipment in the configuration is tested.

The BCCH carrier shall specifically be tested over its specified power levels.

REQUIREMENTS

TRX power class:	Maximum peak power:	Tolerance (dB):
1	320 W	0, +3
2	160 W	"
3	80 W	"
4	40 W	"
<u>1-5</u>	20 W	<u>-0, +3</u> "
<u>2-6</u>	10 W	"
<u>3-7</u>	5 W	"
<u>4-8</u>	2.5 W	"

Table 2-2: Power level classes for a GSM BSS

The BSS shall always be able to use the maximum peak power corresponding to its TRX power class given in Table 2-2 with its tolerances, and at least 6 power steps of 2 ± 1.0 ~~0.5~~ dB down.

As an option, the BSS can use downlink RF power control. In this case up to 15 power level steps for RF power control may be used starting from the measured power level (level 0) corresponding to the TRX power class and the more than 6 power steps defined above and down to level 15.

If downlink RF power control is used, then from the minimum power level for the BSS equipment the increasing power levels shall form an increasing monotonic sequence and the step size between 2 adjacent levels shall be 2 ± 1.5 dB.

If downlink RF power control is used, the absolute power level accuracy shall be better than ± 3 dB under normal test conditions and ± 4 dB under extreme test conditions for all RF power control levels, starting from power level 1.

2.1.6.4. Transmitted RF carrier power versus time

DEFINITION

This section defines:

- 1) The time during which the transmitted power envelope must be stable (the useful part of the timeslot).
- 2) The stability limits.
- 3) The maximum output power when nominally off between time slots.

It does not attempt to measure the detail of the power ramps, this is measured as adjacent channel power in section 2.1.6.5. For further information see GSM 05.02, GSM 05.04, GSM 05.05 and GSM 05.08.

METHOD OF MEASUREMENT

The BSS shall be configured with the radio frequency channels B, M and T. Three adjacent timeslots in a TDMA-frame shall be used. All other timeslots in the TDMA-frame shall be off.

Power measurements are made with a detector bandwidth of BW, where BW shall be at least 1 MHz when measuring the top portion of the burst and at least 300 kHz when measuring the rising and falling transitions. Power is measured continuously at the antenna connector of the combined transmitters for the maximum RF carrier configuration defined by the manufacturer or the operator at each of the 3 frequencies in turn. Timing is related to T₀ which is the transition time from bit 13 to bit 14 of the midamble training sequence for each timeslot. For timing on a per timeslot basis each timeslot may contain 156.25 modulating bits, or 2 timeslots may contain 157 and 6 timeslots 156 modulating bits according to GSM 05.10. On a per timeslot basis also, the 0 dB reference point in Figure 2-1 is defined as the average power during the useful part of the burst.

All 3 timeslots shall be configured with the same power (P_{min} or P_{max}, in turn) and the timeslot power sequence (TS1, TS2, TS3) = (P_{eff}P_{idle}, P_{max}, P_{eff}P_{idle}) and (P_{eff}P_{idle}, P_{min}, P_{eff}P_{idle}) shall be displayed or stored for at least 100 complete cycles of the timeslot power sequence on each of the 3 frequencies. In the case of SFH, all 3 timeslots need to be active and hopping, while in the case of no SFH, only the middle timeslot (TS2) needs to be active.

P_{max}, P_{min} and P_{eff}P_{idle} are the maximum power level (level 0), the minimum power level (level 1-15) and the power when a timeslot is idle for the BSS configuration (see also Figure 2-2).

The measurement shall be repeated for each RF equipment existing in the configuration.

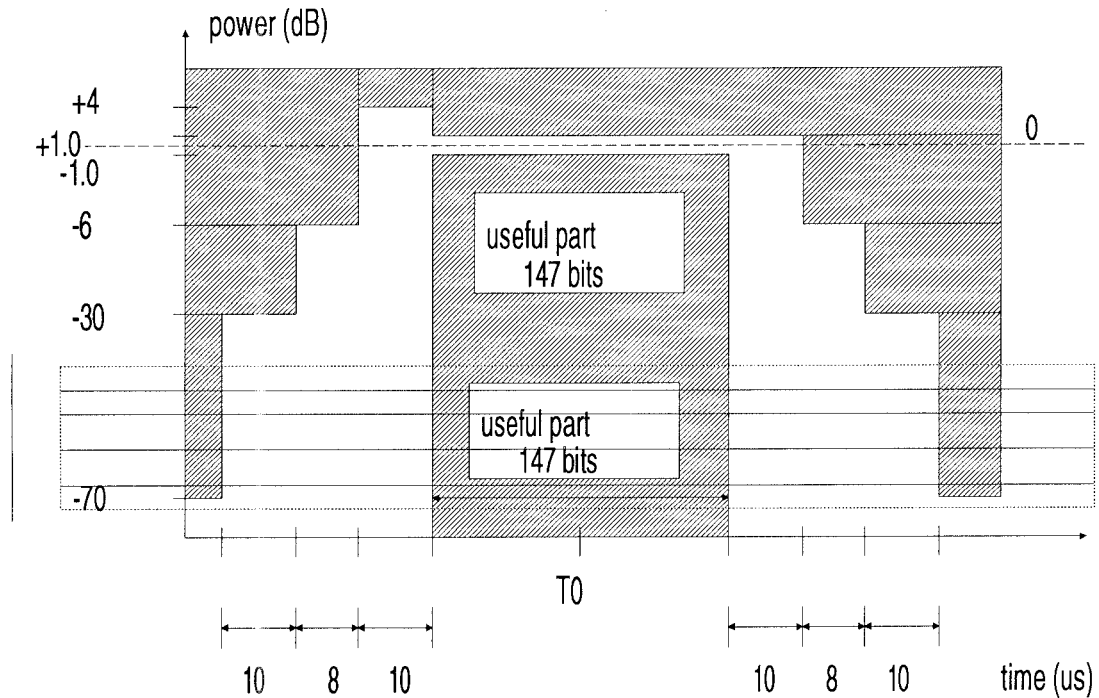

$$147 \text{ bits} = 542.8 \text{ us} = 7056/13 \text{ us}$$

$$1 \text{ timeslot} = 576.9 \text{ us} = 156.25 \text{ bits}$$

Figure 2-1: Power/time mask for power ramping of normal bursts

REQUIREMENTS

The power/time profile Figure 2-1 under normal test conditions shall be met. No requirements are given for any other transitions.

If RF power control is supported by the BSS, the value P_{min} of Figure 2-1 shall be within the limits defined in section 2.1.6.3 over the useful part of the timeslot.

For the timeslot "off" condition the power level shall remain at the $P_{idlePoff}$ value for all timeslots. ~~In case the power level being very low, ie when the Poff value of -70 dB results in a lower absolute value than -36 dBm, then Poff shall be -36 dBm.~~

NOTE: The time mask in Figure 2-1 exceeds the timeslot length. In case consecutive timeslots are active, there are other requirements like phase trajectory, adjacent channel spectrum etc which will guarantee satisfactory operation.

2.1.6.5. Adjacent channel power

DEFINITION

The modulation and power level switching spectra can produce significant interference in the GSM DCS 1800 and adjacent bands. The effect on the spectrum due to the continuous modulation spectrum and due to the switching transients do not occur at the same time and are therefore specified separately:

- 1) Continuous modulation spectrum
- 2) Switching transients spectrum

For further information see GSM 05.05.

2.1.6.5.1. Continuous modulation spectrum

METHOD OF MEASUREMENT

The BSS shall be configured with the radio frequency channels B, M and T.

- a) One timeslot shall be set up to transmit full power modulated with a pseudo-random bit sequence of encrypted bits. The pseudo-random bit sequence may be generated by another pseudo-random bit sequence inserted before channel encoding in the BSS. The other timeslots shall be off. The power shall then be measured selectively with video averaging over 50 - 90 % of the useful part of the timeslot (see GSM 05.05), excluding the midamble, at one of the carriers in the configuration with the test equipment parameters below. The averaging shall be over at least 500 timeslots and only timeslots where the power exceeds ~~40 dB~~ -25 dB relative to the expected value shall be included in the averaging process. In case of SFH, any of the carriers may be used. In case of no SFH, the actually transmitted carrier must be used.

Up to +/- 1800 MHz:

Resolution bandwidth: 30 kHz
Video bandwidth : 30 kHz
Zero frequency scan

Beyond +/-1800 MHz and in RX band:

Resolution bandwidth: 100 kHz
Video bandwidth : 100 kHz
Zero frequency scan

The power shall also be measured with the following offsets from the carrier frequency:

100, 200, 250, 400 kHz and
600 to 1800 kHz in steps of 200 kHz.

- b) With all timeslots at the same power level, step a) shall be repeated for all nominal power levels defined by the manufacturer or by the operator for the BSS.
- c) Step a) shall be repeated, except that the resolution bandwidth shall be set to ~~30 kHz~~ 100 kHz, and the power level shall be measured over the frequency range 1710 to 1785 MHz ~~890 to 915 MHz~~ in 200 kHz steps.
- d) The whole measurement shall be performed sequentially for all the 3 carriers in the configuration and the test shall be repeated until all the RF equipment in the BSS configuration is tested on all the 3 frequencies.

REQUIREMENTS

The power measured shall in all above cases never exceed the limits shown in Table 2-3 under normal test conditions.

~~If the resulting absolute value from Table 2-3 is below -36 dBm, the requirement shall be replaced by -36 dBm for offsets of 400 to 1800 kHz inclusive.~~

The following exceptions and minimum measurement levels shall apply:

1. Above 600 kHz and below 6 MHz offset from the carrier up to 3 DCS1800 200 kHz RF channels may fail the above test, but the measured level in these channels must be below -36 dBm.
2. Above 6 MHz offset from the carrier and up to the edge of the transmit band, the test may be failed up to 12 times where a level of up to -36 dBm is permitted.
3. If the limit according to table 2-3 is below -57 dBm, a value of -57 dBm shall be used instead.

The figures in the table below, at the listed frequencies from carrier (kHz), are the maximum level (dB) relative to a measurement in a 30 kHz bandwidth on the carrier.

Power level (dBm):	Maximum relative level (dB) at carrier offsets (kHz):					
	0	100	200	250	400	600 1800
>=43	0	+0.5	30	33	60	70
41	0	+0.5	30	33	60	68
39	0	+0.5	30	33	60	66
37	0	+0.5	30	33	60	64
35	0	+0.5	30	33	60	62
<=33	0	+0.5	30	33	60	60

Power level (dBm):	Maximum relative level (dB) at carrier offsets (kHz):							
	0	100	200	250	400	600-1800	1800-6000	>6000
≥ 43	0	+0.5	-30	-33	-60	-70	-70	-80
41	0	+0.5	-30	-33	-60	-68	-70	-80
39	0	+0.5	-30	-33	-60	-66	-70	-80
37	0	+0.5	-30	-33	-60	-64	-68	-80
35	0	+0.5	-30	-33	-60	-62	-66	-80
≤ 33	0	+0.5	-30	-33	-60	-60	-66	-80

Table 2-3: Continuous modulation spectrum - maximum limits

For all power levels tested the maximum power measured at step c) in the range 1710 MHz to 1785 MHz ~~890 to 915 MHz~~ shall be -98 dBm ~~-103 dBm~~.

2.1.6.5.2. Switching transients spectrum

METHOD OF MEASUREMENT

The BSS shall be configured with the radio frequency channels B, M and T.

- a) All timeslots shall be set up to transmit full power modulated with a pseudo-random bit sequence. The power shall then be measured continuously at the offsets listed below from one of the carriers in the configuration with the test equipment parameters below. In case of SFH, any of the carriers may be used. In case of no SFH, the actually transmitted carrier must be used.

Resolution bandwidth: 30 kHz
Video bandwidth : 100 kHz
Zero frequency scan
Peak hold enabled

The following offsets from the carrier frequency shall be used:

400, 600, 1200, and 1800 kHz

- b) If no RF power control is supported by the BSS, the test in step a) shall be repeated with the power/timeslot profile of Figure 2-3, and if supported, with the power/timeslot profile of Figure 2-2. The test shall be carried out with SFH disabled and enabled, if supported.
- c) With all timeslots at the same power level, step a) shall be repeated for all nominal power levels defined by the manufacturer or by the operator for the BSS.
- d) The whole measurement shall be performed sequentially for all the 3 carriers in the configuration and the test shall be repeated until all the RF equipment in the BSS configuration is tested on all the 3 frequencies.

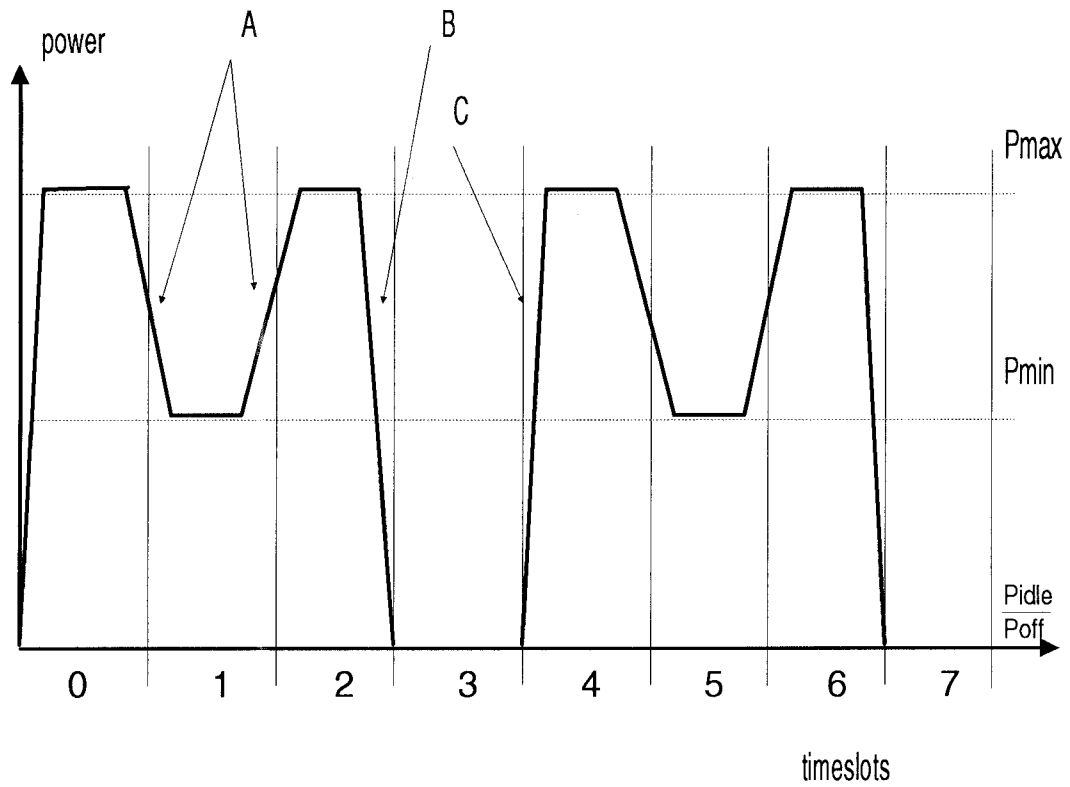

Figure 2-2: Power/timeslot configuration (RF power control)

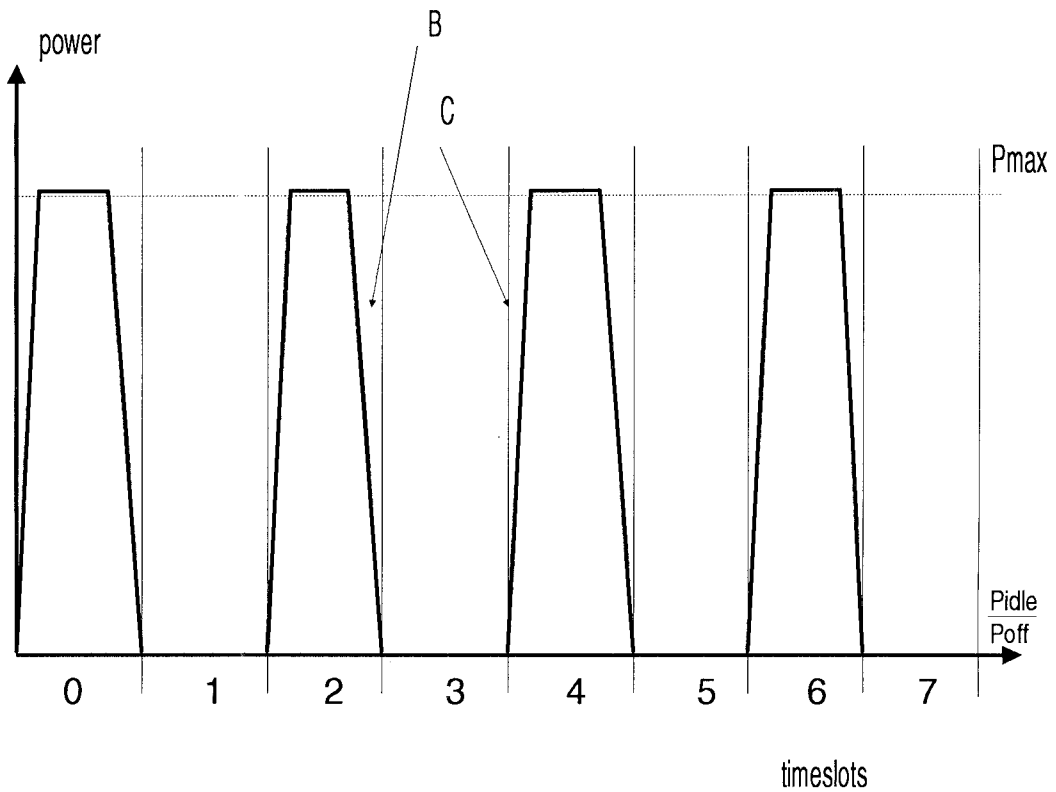

Figure 2-3: Power/timeslot configuration (no RF power control)

REQUIREMENTS

The power measured shall in any case never exceed the limits shown in Table 2-4 under normal test conditions, or -36 dBm, whichever value is highest. These requirements shall in no case be more stringent than 3 dB above the figures given in Table 2-3 for the relevant power level. (Note that for the table below "dBc" means relative to the maximum BSS peak power.)

Offset (kHz):	Power (dBc):
400	- <u>50</u> <u>60</u>
600	- <u>58</u> <u>69</u>
1200	- <u>66</u> <u>75</u>
1800	- <u>66</u> <u>79</u>

Table 2-4: Switching transients spectrum - maximum limits

NOTE: For a high-power BSS/BTS, the value in Table 2-4 will always exceed -36 dBm. In such a case, the measurement in section 2.1.6.6 of TX spurious emissions may be unnecessary in the BSS TX band close to the carrier.

2.1.6.6. Spurious emissions from the transmitters

DEFINITION

Spurious emissions are emissions at frequencies other than those of the carrier, sidebands and adjacent channels associated with normal modulation and switching covered in 2.1.6.5, radiated by the equipment (cabinet radiation), at the antenna connector or into the power leads (conducted spurious emissions). This measurement covers the spurious emissions conducted from the BSS transmitter antenna connectors or radiated from the BSS transmitters while in operation covering also switching transients close to the carrier.

For further information see GSM 05.05.

NOTE: The requirement for conducted spurious emissions from power leads is contained in ETS 300 342-2.

METHOD OF MEASUREMENT

Spurious emissions shall be measured as:

- a) The power level of any discrete signal measured in a 50 ohms load at the antenna socket (conducted spurious emissions).
- b) The effective radiated power radiated by the cabinet and structure of the equipment (cabinet radiation).

The BSS shall be operated in Slow Frequency Hopping (SFH) mode, if applicable. The radio frequency channels B, M and T shall be allocated to the BSS and every other timeslot in the 3 carriers shall be transmitting full power. If no SFH is supported by the BSS, each of these frequencies shall be tested in turn. If SFH is supported, the BSS shall hop on these 3 frequencies. The test shall be repeated until all the RF equipment in the BSS configuration is tested on all the 3 frequencies.

The measurements shall be performed in accordance with Table 2-5 with peak hold enabled.

Frequency band:	Frequency offset:	Resolution bandwidth:
935 - 960 MHz	(offset from carrier)	
1805 - 1880 MHz	(offset from carrier)	
(BSS TX band)	>= 600 kHz	10 kHz
	>= 1.8 MHz	30 kHz
	>= 6.0 MHz	100 kHz
890 - 915 MHz	all	30 kHz
1710 - 1785 MHz	all	30 kHz
otherwise	(offset from BSS TX band)	
	>= 2 MHz	30 kHz
	>= 5 MHz	100 kHz
	>= 10 MHz	300 kHz
	>= 20 MHz	1 MHz
	>= 30 MHz	3 MHz

Table 2-5: Spurious emissions measurements

For a swept measurement, with a continuous max hold, a single sweep shall be performed, which shall meet the following requirement:

Resolution bandwidth (kHz) >= 4.615 ms
Sweep rate (kHz/ms)

If the max hold function is sampled (i.e. not continuous in time), then the number of samples made for each frequency interval equal to the resolution bandwidth shall be at least 1250 (the number of bit periods in the frame). The samples shall be either evenly or randomly distributed throughout the TDMA frame period.

For a stepped measurement, the increment in frequency shall not exceed the resolution bandwidth.

If the max hold is continuous, the measurement period on each frequency shall be at least 4.615 ms.

If the max hold function is sampled (i.e. not continuous in time), then the number of samples made for each frequency shall

be at least 1250 (the number of bit periods in the frame). The samples shall be either evenly or randomly distributed throughout the TDMA frame period.

NOTE: For low search frequencies, the resolution bandwidth must be lower than the search frequency.

In the range 9 kHz - 100 kHz, the resolution bandwidth shall be 1 kHz, and in the range 100 kHz - 10 MHz it shall be 10 kHz. The requirements shall be unchanged.

METHOD OF MEASURING CONDUCTED SPURIOUS AT THE ANTENNA CONNECTOR

The antenna output connector shall be connected to a spectrum analyser or selective voltmeter, having an input impedance of 50 ohms. If the detecting device is not calibrated in terms of power input, the level of any detected components shall be determined by a substitution method using a signal generator.

In the BSS RX band the measurement technique shall be that in 2.1.6.5.1, continuous modulation, step c.

METHOD OF MEASURING THE EFFECTIVE RADIATED POWER

A test site fulfilling the requirements in recommendation CEPT T/R 24-01 annex 1 (Technical characteristics and test conditions for radio equipment in the land mobile service intended primarily for analogue speech) shall be used. The BSS shall be placed at the specified height on a non-conducting support and shall be operated from a power source via a RF filter to avoid radiation from the power leads.

Radiation of any spurious components shall be detected by the test antenna and receiver and cover the frequency range 30 MHz to 12.75 GHz.

At each frequency at which a component is detected, the sample shall be rotated to obtain maximum response and the effective radiated power of that component determined by a substitution measurement. The measurement shall be repeated with the test antenna in the orthogonal polarisation plane.

In order to simplify the test, the rotation is only required for the actual BSS configured with 1 active Transceiver (TRX). If an A-bis-interface is used, both the BSC and the BTS shall be tested.

REQUIREMENTS

The power level of the conducted spurious emissions or the effective radiated power shall not exceed the levels in Table 2-6 under normal test conditions.

Frequency Band:	Maximum Level:
Radiated:	
30 MHz - 1000 MHz	-36 dBm
1000 MHz - 12.75 GHz	-30 dBm
Antenna connector:	
9 kHz - 1000 MHz	-36 dBm
1000 MHz - 12.75 GHz	-30 dBm

Table 2-6: Maximum level of TX spurious emissions

This requirement shall be met for every frequency for at least one out of up to three measurements.

NOTE: for spurious emissions of Gaussian noise, there is a finite probability that the requirement may not be met due to the statistical distribution of amplitude with a low probability of occurrence of an amplitude many times the mean value (a "high peak"). With a peak hold measurement, this cannot be distinguished from a discrete spurious emission which is present continuously. The test may therefore be performed up to three times, and the requirement must be met at each frequency at least once. If the requirement is not met at a particular frequency for any of three measurements, the probability of this being due to a "high peak" is extremely low.

NOTE: For the filter bandwidth quoted in the test method some difficulties may be experienced with the noise floor above the required measurement limit. This will depend on the gain of the test antenna, and adjustment of the measuring system bandwidth is permissible.

2.1.6.7. Intermodulation attenuation

DEFINITION

The intermodulation attenuation is a measure of the capability of an RF transmit equipment to inhibit the generation of signals in its non-linear elements caused by the presence of the carrier and an interfering signal reaching the equipment via its antenna.

For further information see GSM 05.05.

METHOD OF MEASUREMENT

If SFH is supported by the BSS, it shall be disabled during this measurement.

The antenna output of the RF transmit equipment under test, including the combiner, shall be connected to a coupling device, presenting to the RF equipment a load with an impedance of 50 ohms.

The unwanted test signal shall be unmodulated and the frequency shall be x MHz above the frequency of the RF transmit equipment under test. The carrier power level transmitted by the RF transmit equipment shall be the maximum power specified for the equipment and the unwanted test signal power level shall be adjusted 30 dB below. The test signals are indicated in Figure 2-4.

The power level of the test signal shall be measured at the antenna output end of the coaxial cable, when disconnected from the RF transmit equipment and then correctly matched into 50 ohms. The antenna output power of the RF transmit equipment shall be measured directly at the antenna output terminal connected to an artificial antenna.

Any intermodulation components shall then be measured in the band indicated in Tables 2-7a and 2.7b by means of a selective measuring device. The length of the coaxial cable between the antenna output and the coupling device shall be varied until the maximum level of the intermodulation component considered is obtained.

This measurement shall be repeated with the test signal at a frequency below the transmitted frequency.

When the above measurements are performed precautions must be taken, so that non-linearities in the selective measuring device do not influence the results appreciably. Furthermore it should be ensured that intermodulation components which may be generated by non-linear elements in the test equipment (eg signal generator, coupling device, selective measuring device) are sufficiently reduced. The RF transmit equipment under test and the test signal source shall be physically separated in such a way that the measurement is not influenced by direct radiation.

A possible measurement set-up is shown in Annex 1.7.

The intermodulation attenuation is expressed as the ratio in dB of the output power level of the transmitter under test to the power level of the highest intermodulation component.

The tests shall be repeated until all the RF equipment in the BSS configuration has been tested on all the frequencies given in Tables 2-7a and 2.7b.

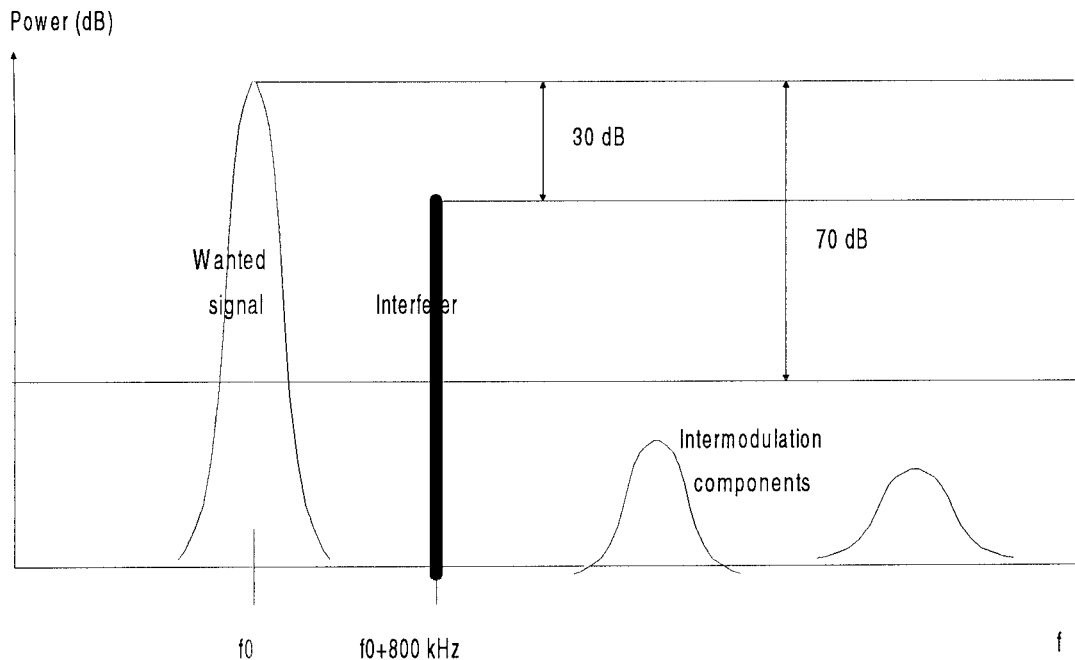

Figure 2-4: Example of TX intermodulation attenuation

REQUIREMENTS

Under normal test conditions, at frequencies offset from the wanted signal carrier frequency by more than 6 MHz, the measured intermodulation components shall never exceed the limits given in Table 2.7a. These limits apply to all the RF transmitting equipment in the BSS configuration.

NOTE 1: In the BSS Rx band the measurement technique shall be that in 2.1.6.5.1, Continuous Modulation Spectrum, step c.

NOTE 2: The value Y should be chosen such that the 3rd, 5th or 7th order intermodulation product falls on the RX band.

NOTE 3: In some cases, the level of acceptable spurious emission outside of the BSS receive band may be greater than the specified intermodulation limit. In these cases, the intermodulation components shall not exceed the limits specified in test 2.1.6.6 using the same measurement settings. The level of specified spurious emission is not constant over the whole band.

Tx RF Channel	Test Signal displacement (x)	Limit	Frequency Band	Measurement Bandwidth
B, M, T	0.8 MHz	-70 dBc	100 kHz - 12.75 GHz	300 kHz
M	Y MHz	103 dBm	890 - 915 MHz	30 kHz
M	Y MHz	-98 dBm	1710 - 1785 MHz	100 kHz

Table 2-7a: Maximum transmitter intermodulation limits for frequencies greater than 6 MHz offset from TX RF carrier frequency

Under normal test conditions, at frequencies offset from the wanted signal carrier frequency by less than 6 MHz, the measure intermodulation components shall never exceed those given in Table 2-7b. These limits apply to all the RF transmitting equipment in the BSS configuration.

NOTE 4: At frequencies offset from the carrier frequency by less than 1.8 MHz the modulation mask will dominate. In this case the level of intermodulation components shall not exceed the limits specified in test 2.1.6.5 using the same measurement settings.

NOTE 5: In some cases, the level of acceptable radiated spurious may be greater than the specified intermodulation limit. In these cases, the intermodulation components shall not exceed the limits specified in test 2.1.6.6 using the same measurement settings.

Tx RF Channel	Test Signal displacement (x)	Limit	Measurement Bandwidth	Frequency Band
B, M, T	0.8 MHz	-70 dBc	30 kHz	1.8 MHz - 6 MHz
B, M, T	0.8 MHz	see NOTE 4		< 1.8 MHz

Table 2-7b: Maximum transmitter intermodulation limits for frequencies less than 6 MHz offset from TX RF channel carrier frequency

2.1.6.8. Intra Base Station System intermodulation attenuation

DEFINITION

When transmitters and carriers are combined to feed a single antenna, or are operating in the close vicinity of each other, the leakage of each carrier into the other transmitters and the presence of non-linear elements will cause intermodulation products to appear. The level of these spurious must be controlled.

Outside of the ~~GSM-DCS 1800~~ Band, intermodulation products are included in the spurious emissions tests of section 2.1.6.6. This specification and test refers to intermodulation products inside the DCS 1800 GSM-Base Station System Tx Band of 1805 - 1880 MHz ~~935 - 960 MHz~~ and BSS Rx Band of 1710 - 1785 MHz ~~890 - 915 MHz~~.

NOTE: Individual administrations may require that this band be reduced to that part of the spectrum allocated to a single network operator, and for the spurious emissions test of section 2.1.6.6 to be extended accordingly.

For further information see GSM 05.05.

METHOD OF MEASUREMENT

If SFH is supported by the BSS, it shall be disabled during this measurement.

The BTS shall be configured with a full compliment of transceivers. Each RF transmit equipment shall be operated at the maximum power specified and with modulation applied.

For the measurement in the transmit band the equipment shall be operated at equal and minimum frequency spacings specified for the BSS configuration under test.

For the measurement in the receive band the equipment shall be operated with such a channel configuration that at least 3rd order intermodulation products fall into the receive band. Only these intermodulation frequencies have to be measured.

The measurement shall be carried out at the antenna connector of the Base Station System, using a frequency selective instrument which shall provide a 50 ohm termination to the Base Station System.

A possible measurement setup for this test is given in Annex 1.7.

The power of any intermodulation product shall be measured by a peak measuring equipment except for the receive band where the measurement conditions described in 2.1.6.5.1 step c, continuous modulation spectrum, shall be used. The measurement bandwidth shall be either 30 kHz or 300 kHz as specified in Tables 2-8a and 2-8b.

In the transmit band, the intermodulation components shall be measured at frequency offsets above the uppermost and below the lowermost carriers.

REQUIREMENTS

In the receive band the measured intermodulation components shall never exceed the values given in Table 2-8a under normal test conditions.

Frequency Band	Measurement BW	Limit
890 - 915 MHz	30 kHz	103 dBm
<u>1710 - 1785 MHz</u>	<u>30 kHz</u>	<u>-98 dBm</u>

Table 2-8a: Maximum intra-BSS Receive Band transmitter intermodulation limits

In the transmit band ~~(935 - 960 MHz)~~ (1805 - 1880 MHz), at offsets greater than 1.8 MHz, the measured intermodulation components shall never exceed the greater of the limits given in Table 2-8b, under normal test conditions.

Frequency Band	Measurement BW	Limit
1.8 MHz - 6.0 MHz	30 kHz	36 dBm / 70 dBe
> 6.0 MHz	300 kHz	36 dBm / 70 dBe
<u>1.8 MHz - 6.0 MHz</u>	<u>30 kHz</u>	<u>-30 dBm / -70 dBc</u>
<u>> 6.0 MHz</u>	<u>300 kHz</u>	<u>-30 dBm / -70 dBc</u>

Table 2-8b: Maximum intra-BSS Transmit Band transmitter intermodulation limits

At a frequency offset of less than 1.8 MHz the modulation mask will dominate. The level of intermodulation components shall not exceed the levels specified in test 2.1.6.5 using the same measurement settings.

NOTE: ~~-36 dBm~~ -30 dBm corresponds to the value for spurious emissions. However, the measurement BW is not necessarily the same.

NOTE: ~~The value of 103 dBm is based on a receiver sensitivity of -104 dBm, a cochannel rejection of 9 dB, a TX RX antenna coupling loss of 30 dB, a multiple interference margin of 10 dB and a measurement bandwidth expansion factor of 10 dB.~~

2.1.7. Receivers

All tests in this section shall be conducted on Base Station Systems fitted with a full complement of Transceivers for the configuration. Measurements shall be made at the BSS Rx antenna

connector or at internal test points and interfaces as defined in section 11.2 in this specification, and include any Rx multicoupler.

Where noted Rx measurements are to be made with all transmitters operated at full configuration power. A Tx-Rx coupling loss of 30 dB is assumed throughout this section. It is up to the operator or the manufacturer to use other values. If other values are used, some of the requirements in this section might need modification.

All tests in this section are compliance tests. The measurement of any real parameters is a national or operator specific matter. If some real values are wanted, eg the static reference sensitivity level (section 2.1.7.3) and receiver intermodulation rejection (section 2.1.7.7) could together give a good view of the quality of the receiver and of the quality of the signal processing parts and the RF parts of it, respectively.

The tests in this section assume that the receiver is not equipped with diversity. For receivers with diversity, the tests may be performed by applying the specified signals to one of the receiver inputs, and terminating or disabling the other(s). The tests and requirements are otherwise unchanged.

NOTE: The GSM recommendations do not specify the performance of diversity receivers. The specification of alternative or additional tests on diversity reception is therefore a national or operator specific matter.

In all the relevant subsections in this section all Bit Error Ratio (BER), Residual BER (RBER) and Frame Erasure Ratio (FER) measurements shall be carried out according to the general rules for statistical testing in Annex 1. Where error ratios are given, "4.0 E-3" means "4.0 times 10 to the power of -3".

The power level values given in the text assume a load impedance of 50 ohms for power quoted in dBm and (dBuV(emf)).

Unless otherwise stated the tests in this section shall be performed under normal and extreme test conditions.

2.1.7.1. Static Layer 1 receiver functions (nominal error ratios)

DEFINITION

The static Layer 1 receiver functions verified in these tests are the RF parts, the multiplexing and multiple access functions, any existing equalizer, the deciphering functions, the deinterleaving and the channel decoding on the receive side. Also the maximum input level of the receiver is verified.

The measurements are recorded as nominal error ratios (Bit Error Ratio - BER) at a logical reference point that represents the performance before channel decoding. This measurement shall be performed for TCH/FS only using unprotected class II bits extracted after channel decoding, but before any extrapolation. Therefore, the results obtained are representative of the logical

reference point before channel decoding. For further information see GSM 05.01, GSM 05.02, GSM 05.03 and GSM 05.05.

METHOD OF MEASUREMENT

If Slow Frequency Hopping (SFH) is supported by the BSS, the BSS shall be hopping over the maximum range and number of carriers possible for the test environment and which are available in the BSS configuration. If SFH is not supported, the test shall be performed for the radio frequency channels B, M and T. In both cases the tests shall be repeated until all the RF equipment in the BSS configuration is tested on all specified carrier frequencies and all available TCH/FS timeslots.

A test signal with normal modulation originating from the BSSTE shall be applied to the BSS receiver input. The unprotected class II bits obtained from the BSS receiver after channel decoding and before any extrapolation shall be compared with the unprotected class II bits originating from the BSSTE. The level of the test signal shall be varied between -85 dBm (28 dBuV(emf)) and -23 (90 dBuV(emf)) inclusive. ~~A inclusive. A is 10 dBm (103 dBuV(emf)) for static propagation conditions and 40 dBm (73 dBuV(emf)) for the multipath conditions listed below.~~

REQUIREMENTS

Multipath condition:	BER:
<u>Static up to -40 dBm (73 dBuV(emf))</u>	1.0 E-4
<u>Static up to -23 dBm (90 dBuV(emf))</u>	5.0 E-3
EQ50	3.0 E-2

Table 2-9: Nominal error ratios before channel decoding

The nominal error ratios shall not exceed the values given in Table 2-9 under normal test conditions.

2.1.7.2. Error detection mechanisms

DEFINITION

In GSM 05.03 a Cyclic Redundancy Check (CRC) is defined for detection of erroneous Layer 2 frames or speech frames. For full-rate speech channels also additional error detecting capabilities using some soft information are needed due to DTX operation when no useful signal is transmitted to the receiver. This test verifies the reliability of the overall Bad Frame Indication (BFI) presented to the full-rate speech decoder and the Frame Erasure Indication (FEI) used on control channels. For further information see also GSM 05.05.

METHOD OF MEASUREMENT

1. A signal as specified in section 2.1.7.5 for the interferer shall be input with a level of -85 dBm (28 dBuV(emf)) on the channels TCH/FS and SDCCH with their Associated Control Channels (SACCH and FACCH), and RACH in turn. The BSS must be configured to receive these channels and the resulting bitstream in the BSS after channel decoding, including the BFI or FEI as appropriate, shall be recorded for each channel type.
2. Step 1 shall be repeated without any signal on the channel under test.

REQUIREMENTS

For the TCH/FS, less than 1 undetected bad speech frame (BFI=0) shall occur on average in a period of 10 s.

For the RACH, less than 0.02% of the frames shall be detected as error free (FEI=0).

On the TCH/FS and SDCCH with their ACCHs, for those frames believed to be FACCH, SACCH or SDCCH frames, less than 0.002% of these frames shall be detected as error free (FEI=0).

2.1.7.3. Static reference sensitivity level

DEFINITION

The static reference sensitivity level of the receiver is the level of signal at the receiver input with a standard test signal at which the receiver will produce after demodulation and channel decoding data with a Frame Erasure Ratio (FER), Residual Bit Error Ratio (RBER) or Bit Error Ratio (BER) better than or equal to that specified for a specific channel type under static propagation conditions. For further information see GSM 05.05.

METHOD OF MEASUREMENT

If Slow Frequency Hopping (SFH) is supported by the BSS, the BSS shall be hopping over the maximum range and number of carriers possible for the test environment and which are available in the BSS configuration. If SFH is not supported, the test shall be performed for the radio frequency channels B, M and T. In both cases the tests shall be repeated until all the RF equipment in the BSS configuration is tested on all available carrier frequencies.

All carriers in the BSS configuration shall be on and transmitting full power in all timeslots other than the one used in the test.

A test signal with normal GSM modulation shall be applied to the BSS RX antenna connector on a chosen timeslot. The input signal before channel encoding in the BSSTE is compared with the signal which is obtained from the BSS receiver after channel decoding. The level of the test signal shall be -104 dBm (9 dBuV(emf)). The 2 adjacent timeslots to the wanted shall have a level 30 dB above the wanted signal. All other timeslots shall be off.

REQUIREMENTS

The error performance given in Table 2-10 shall be met for all channel types under normal and extreme test conditions. For the measurement on the TCH/FS using class II bits the BSS shall also be exposed to vibration.

NOTE: The only control channel listed in Table 2-10 is the SDCCH since the performance of this channel is basically the same as BCCH, AGCH and PCH, and worse than that of SACCH and FACCH. The requirement to be used for the FACCH and the SACCH is consequently the same as for the SDCCH.

Channel type:	FER:	BER:	RBER:
SDCCH	0.10 %	-	-
RACH	0.50 %	-	-
TCH/F9.6	-	1.0 E-5	-
TCH/F4.8	-	-	-
TCH/F2.4	-	-	-
TCH/H4.8	-	1.0 E-5	-
TCH/H2.4	-	-	-
TCH/FS	0.10 %	-	-
- class Ib	-	-	0.40/- %
- class II	-	-	2.0 %
TCH/HS	[tbd]	[tbd]	[tbd]

Table 2-10: Static error performance limits at RX sensitivity level

NOTE: The value of - in Table 2-10 may be between 1 and 1.6, but must be the same for both occurrences.

2.1.7.4. Multipath reference sensitivity level

DEFINITION

The multipath reference sensitivity level of the receiver is the level of signal at the receiver input with a standard test signal at which the receiver will produce after demodulation and channel decoding data with a Frame Erasure Ratio (FER), Residual Bit Error Ratio (RBER) or Bit Error Ratio (BER) better than or equal to that specified for a specific channel type under multipath propagation conditions. For further information see GSM 05.05.

METHOD OF MEASUREMENT

As for static reference sensitivity level in section 2.1.7.4, but with SFH disabled if supported by the BSS.

The level of the test signal shall be -104 dBm (9 dBuV(emf)), but in this case the test signal is applied to the BSS RX antenna connector through a Multipath Fading Simulator (MFS). The power level of the test signal is referred to the output of the Multipath Fading Simulator (the BSS RX antenna input) in accordance with the measurement of the 0 dB reference point for the transmitted carrier power versus time in section 2.1.6.4 without interfering timeslots and excluding the hard limit of -40 dB. The measurement shall be performed for all channel types in Table 2-11.

REQUIREMENTS

The error performance given in Table 2-11 shall be met for all channel types and for all the multipath propagation profiles given in Table 2-11 under normal test conditions.

NOTE: The only control channel listed in Table 2-11 is the SDCCH since the performance of this channel is basically the same as BCCH, AGCH and PCH, and worse than that of SACCH and FACCH. The requirement to be used for the FACCH and the SACCH is consequently the same as for the SDCCH.

Channel type / error measure:		Error ratios (%):		
		TU50:	RA250:	HT100:
SDCCH	(FER)	13 %	8.0 %	12.0 %
RACH	(FER)	13 %	12 %	13 %
TCH/F9.6	(BER)	0.50 %	0.10 %	0.70 %
TCH/F4.8	(BER)	1.0 E 4	1.0 E 4	1.0 E 4
TCH/F2.4	(BER)	2.0 E 4	1.0 E 5	1.0 E 5
TCH/H4.8	(BER)	0.50 %	0.10 %	0.70 %
TCH/H2.4	(BER)	2.0 E 4	1.0 E 4	1.0 E 4
TCH/FS	(FER)	6.0 - %	2.0 - %	7.0 - %
class Ib	(RBER)	0.40/- %	0.20/- %	0.50/- %
class II	(RBER)	8.0 %	7.0 %	9.0 %
TCH/HS	(tbd)	[tbd]	[tbd]	[tbd]

Channel type /		Error ratios (%):		
error measure:		TU50:	RA130:	HT100:
SDCCH	(FER)	8.0 %	8.0 %	8.0 %
RACH	(FER)	13 %	12 %	13 %
TCH/F9.6	(BER)	0.40 %	0.10 %	0.70 %
TCH/F4.8	(BER)	1.0 E-4	1.0 E-4	1.0 E-4
TCH/F2.4	(BER)	1.0 E-5	1.0 E-5	1.0 E-5
TCH/H4.8	(BER)	0.40 %	0.10 %	0.70 %
TCH/H2.4	(BER)	1.0 E-4	1.0 E-4	1.0 E-4
TCH/FS	(FER)	4.0a%	2.0a%	7.0a%
- class Ib	(RBER)	0.30/a%	0.20/a%	0.50/a%
- class II	(RBER)	8.0 %	7.0 %	9.0 %
TCH/HS	(tbd)	[tbd]	[tbd]	[tbd]

Table 2-11: Multipath error performance limits
at RX sensitivity level

NOTE: The value of a in Table 2-11 may be between 1 and 1.6, but must be the same for both occurrences in each channel condition; it may be different for different channel conditions.

2.1.7.5. Reference interference level

DEFINITION

The reference interference level is a measure of the capability of the receiver to receive a wanted modulated signal without exceeding a given degradation due to the presence of an unwanted modulated signal at the same carrier frequency (cochannel interference) or at any adjacent carrier frequencies (adjacent channel interference). For further information see GSM 05.05.

METHOD OF MEASUREMENT

If Slow Frequency Hopping (SFH) is supported by the BSS, it shall be disabled during this measurement. Only for the test of the multipath condition TU3 SFH shall be enabled.

When SFH is used in the test, the BSS shall be hopping over the maximum range and number of carriers possible for the test environment and which are available in the BSS configuration. If SFH is not supported, the test shall be performed for the radio frequency channels B, M and T. In both cases the tests shall be repeated until all the RF equipment in the BSS configuration is tested on all specified carrier frequencies. All carriers in the BSS configuration shall be on and transmitting full power in all timeslots other than the one used in the test.

- a) The two input signals shall be connected to the receiver via a combining network. When testing each signal shall be connected through a Multipath Fading Simulator (MFS) as described in Annex 1. The 2 multipath fading channels shall be uncorrelated.

The wanted signal shall have normal GSM modulation, and the interfering signal shall be continuous and have GSM modulation without midamble. The interferer shall be modulated with a pseudo-random bitstream.

The interfering signal shall have an offset to the wanted signal as given in Table 2-12. In the case of Slow Frequency Hopping (SFH) the interfering signal shall be on the same frequency channel as the wanted signal over the useful part of the timeslot burst. The referred power level for both signals shall be the average power into the BSS RX antenna connector. This average power can be determined by using an integration period, as defined in Annex 1 Table A1-2, as appropriate for the channel.

- b) The wanted signal shall have the power level -85 dBm (28 dBuV(emf)).

NOTE: The level of -85 dBm (28 dBuV(emf)) is used in order to clearly distinguish the effects of noise from the effect of interference.

c) The unwanted signal shall then be switched on with an input level relative to the wanted signal as given in Table 2-12. For offsets greater than 0 kHz only the multipath propagation condition TU50 need to be tested.

Interferers offset:	Relative level:
0 kHz	-9 dB
200 kHz	9 dB
400 kHz	41 dB

Table 2-12: Cochannel and adjacent channel interference rejections

REQUIREMENTS

Channel type / error measure:	Error ratios (%):			
	TU3 (no SFH):	TU3 (SFH):	TU50:	RA250:
SDCCH (FER)	22 %	9.0 %	13 %	8.0 %
RACH (FER)	15 %	15 %	16 %	13 %
TCH/F9.6 (BER)	8.0 %	0.30 %	0.80 %	0.20 %
TCH/F4.8 (BER)	3.0 %	1.0 E 4	1.0 E 4	1.0 E 4
TCH/F2.4 (BER)	3.0 %	1.0 E 5	3.0 E 5	1.0 E 5
TCH/H4.8 (BER)	8.0 %	0.30 %	0.80 %	0.20 %
TCH/H2.4 (BER)	4.0 %	1.0 E 4	2.0 E 4	1.0 E 4
TCH/FS (FER)	21 %	3.0 %	6.0 %	3.0 %
class Ib (RBER)	2.0/- %	0.20/- %	0.40/- %	0.20/- %
class II (RBER)	4.0 %	8.0 %	8.0 %	8.0 %
TCH/HS (tbd)	[tbd]	[tbd]	[tbd]	[tbd]

Channel type / error measure:	Error ratios (%):			
	TU1.5 (no SFH)	TU1.5 (SFH)	TU50:	RA130:
SDCCH (FER)	22 %	4.0 %	8.0 %	8.0 %
RACH (FER)	15 %	15 %	16 %	13 %
TCH/F9.6 (BER)	8.0 %	0.30 %	0.30 %	0.20 %
TCH/F4.8 (BER)	3.0 %	1.0 E-4	1.0 E-4	1.0 E-4
TCH/F2.4 (BER)	3.0 %	1.0 E-5	1.0 E-5	1.0 E-5
TCH/H4.8 (BER)	8.0 %	0.30 %	0.30 %	0.20 %
TCH/H2.4 (BER)	4.0 %	1.0 E-4	1.0 E-4	1.0 E-4
TCH/FS (FER)	21 a %	3.0 a %	3.0 a %	3.0 a %
- class Ib (RBER)	2.0/a %	0.20/a %	0.25/a %	0.20/a %
- class II (RBER)	4.0 %	8.0 %	8.1 %	8.0 %
TCH/HS (tbd)	[tbd]	[tbd]	[tbd]	[tbd]

Table 2-13: Multipath error performance limits
at RX interference level

NOTE: The value of a—in Table 2-13 may be between 1 and 1.6, but must be the same for both occurrences in each channel condition; it may be different for different channel conditions.

The error performance of any channel type for any multipath propagation condition given in Table 2-13 shall not be worse than the error ratios given in Table 2-13 under normal test conditions. For control channels not listed in Table 2-13 the requirements for the SDCCH apply.

2.1.7.6. Blocking and spurious response rejection

DEFINITION

Blocking and spurious response rejection is a measure of the ability of a BSS receiver to receive a wanted GSM modulated signal in the presence of an interfering signal; the level of the interfering signal is higher for the test of blocking than for spurious response.

METHOD OF MEASUREMENT

- 1) This measurement is carried out in three stages:
 - i) an optional preliminary test to identify frequencies of interfering signal which require more detailed investigation.
 - ii) measurement of blocking performance.
 - iii) measurement of spurious response performance; this test need only be performed at those frequencies of interfering signal at which the specification for blocking is not met.
- 2) The BSS shall be configured to operate as close to the centre of the band as is possible. If Slow frequency hopping is supported by the BSS, it shall be disabled during these measurements.
- 3) The two RF signals shall be fed into the receiver antenna connector of the BSS using a combining network. One of the signals shall be at the operating frequency of the receiver, shall be modulated with normal GSM modulation, and shall be at a level of -101dBm (12dBuV(emf)).The measurement is only performed under static propagation conditions.

NOTE: Care should be taken to ensure that spurious outputs or broadband noise from the signal generator used for the interfering signal do not affect the measurements.

PRELIMINARY TEST

- 4) This optional test may be performed to reduce the number of measurements required in step 8. If it is performed, this shall be at the frequencies specified below.

- 5) The test shall be performed for an interfering signal at all frequencies which are integer multiples of 200kHz, and which fall within one or more of the frequency ranges listed below, but excluding frequencies which exceed 12.75GHz or are less than 600kHz from the wanted signal:
- i) from 1610 MHz to 1885 MHz ~~790MHz to 1015MHz~~ inclusive.
 - ii) from $F_{lo} - (IF_1 + IF_2 + \dots + IF_n + \underline{37.5 \text{ MHz}} \underline{12.5 \text{ MHz}})$
to
 $F_{lo} + (IF_1 + IF_2 + \dots + IF_n + \underline{37.5 \text{ MHz}} \underline{12.5 \text{ MHz}})$.
 - iii) from $IF_1 - 400\text{kHz}$ to $IF_1 + 400\text{kHz}$.
 - iv) All of the ranges:
 $mF_{lo} - IF_1 - 200\text{kHz}$ to $mF_{lo} - IF_1 + 200\text{kHz}$
and
 $mF_{lo} + IF_1 - 200\text{kHz}$ to $mF_{lo} + IF_1 + 200\text{kHz}$
 - v) All integer multiples of 10MHz

Where:-

F_{lo} - is the frequency of the local oscillator applied to the first receiver mixer.

$IF_1 \dots IF_n$ - are the n intermediate frequencies.

m - is all positive integers.

NOTE: The frequency ranges defined above align with ETS 300 086.

To reduce test time, a shortened test procedure according to Annex 1 of this specification may be used, with an upper limit of measurement of 4GHz.

- 6) The interfering signal shall be frequency modulated with a modulation frequency of 2kHz and a peak deviation of +/- 100kHz.

NOTE: This is to produce a dense spectrum inside the receiver bandwidth, to maximise the probability of detecting a response from data clocks etc.

- 7) For separations between the wanted and interfering signals of 95 MHz ~~45MHz~~ or less, the level of the interfering signal at the receiver input shall be ~~-3dBm (-110dBuV(emf))~~ -15 dBm (98 dBuV(emf)). For greater separations, the level of the interfering signal shall be +10dBm (123dBuV(emf)).

The Residual Bit Error Ratio (RBER) for the TCH/FS channel using class II bits shall be measured. All frequencies at which the RBER exceeds 10% shall be recorded for further study. A relaxed statistical significance may be used for this measurement, compared to that of step 9).

BLOCKING TEST

- 8) If the preliminary test has been performed, this test shall be performed at all frequencies which have been recorded at step 7. If the preliminary test has not been performed, this test shall be performed at all frequencies specified in step 5.

The interfering signal shall be unmodulated, and shall have a level at the receiver input as specified in Table 2-14.

- 9) The RBER for the TCH/FS channel using class II bits shall be measured. All frequencies at which the RBER exceeds the value of Table 2-10 shall be recorded.

NOTE: The methodology for the measurement of BER is described in Annex 1.

Frequency of interfering signal (emf))	Level dBm	(dBuV
<u>1688.8 MHz</u> 868.8 MHz or less <u>1805.2 MHz</u> 935.2 MHz or greater	0	(113)
<u>1690 MHz</u> 870MHz to (fo - 800kHz) 100) (fo + 800kHz) to <u>1805 MHz</u> 935MHz	<u>-25</u> -13	(<u>88</u>
(fo - 600kHz) and (fo + 600kHz) (<u>78</u> 90)	<u>-35</u> -23	

fo is the frequency of the wanted signal

Table 2-14: Level of interfering signal for blocking

SPURIOUS RESPONSE

- 10) This test shall be performed at all frequencies which have been recorded at step 8. The interfering signal shall be unmodulated, and shall have a level of -43dBm (70dBuV (EMF)).
- 11) The RBER for TCH/FS channel using class II bits shall be measured.

REQUIREMENTS

For step 9) (blocking), the recorded frequencies shall meet all of the following requirements :

- | i) For measurement frequencies which are 95 MHz ~~45MHz~~ or less from the wanted signal, the total number does not exceed twelve ~~six~~.
- | ii) For measurement frequencies which are 95 MHz ~~45MHz~~ or less from the wanted signal, no more than three are consecutive.
- | iii) For measurement frequencies which are more than 95 MHz ~~45MHz~~ from the wanted signal, the total number does not exceed twenty four.
- | iv) For measurement frequencies which are more than 95 MHz ~~45MHz~~ below the wanted signal, no more than three are consecutive.

For step 11) (spurious response), the RBER shall never exceed the value of Table 2-10.

2.1.7.7. Intermodulation rejection

DEFINITION

The intermodulation rejection is a measure of the linearity of the receiver RF parts. It expresses the capability of the receiver to receive a wanted modulated signal without exceeding a given degradation due to the presence of two or more unwanted signals with a specific frequency relationship to the wanted signal frequency. For the worst case the third order intermodulation rejection should be regarded only.

For further information see GSM 05.05.

METHOD OF MEASUREMENT

If SFH is supported by the BSS, it shall be disabled during this measurement. The measurement is performed only under static conditions for the TCH/FS using class II bits. The measurement shall be performed for the radio frequency channels B, M and T and until all the RF equipment in the BSS configuration has been tested on all 3 frequencies.

Three signal generators shall be applied to the receiver via a combining network. The first signal generator is an unwanted signal and shall be adjusted to a frequency separated by 8 channel separations above the wanted signal frequency and shall be continuous and modulated by a pseudo-random bit sequence with a periodicity greater than or equal to 511 bits. The second generator is also an unwanted signal and shall be unmodulated. It shall be adjusted to a frequency separated by 4 channel separations above the wanted signal frequency. The third signal is the wanted signal and shall be modulated with another pseudo-random bitstream. The various signals are illustrated in Figure 2-5.

The wanted signal shall have a power level of -101 dBm (12 dBuV(emf)). The two unwanted signal generators shall have the same power level being -49 dBm (64 dBuV(emf)). The RBER of the TCH/FS class II bits shall then be measured.

The measurement shall be repeated with the unwanted signal frequencies below the carrier of the wanted signal.

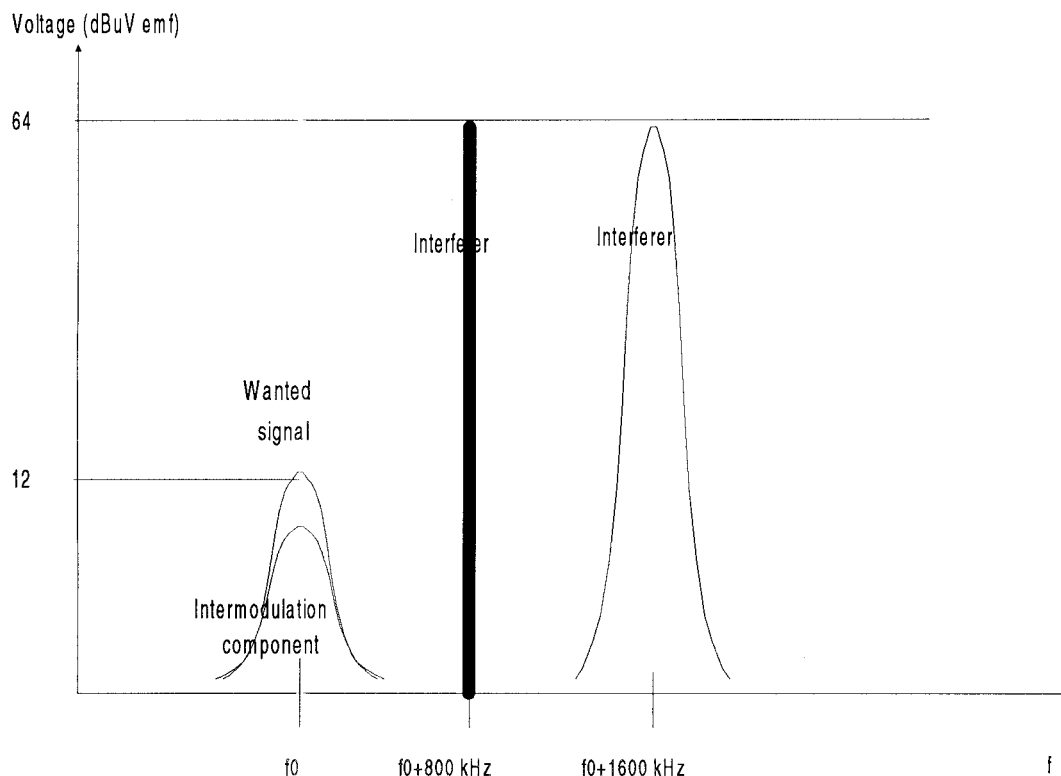

Figure 2-5: Example of RX intermodulation rejection

REQUIREMENTS

The error performance in Table 2-10 shall always be met.

2.1.7.8. Spurious emissions from the BSS receivers

DEFINITION

Spurious emissions are emissions at frequencies other than those of the carrier, sidebands and adjacent channels associated with normal modulation and switching covered in 2.1.6.5, radiated by the equipment (cabinet radiation), at the antenna connector or into the power leads (conducted spurious emissions). This specification covers spurious emissions from the BSS receivers only when no transmitters are active.

For further information see GSM 05.05.

METHOD OF MEASUREMENT

Spurious emissions shall be measured as in section 2.1.6.6 (spurious emissions from the BSS transmitters), but with the BCCH carrier switched off and no signals applied to the BSS receivers.

The BSS shall be operated in Slow Frequency Hopping (SFH) mode, if applicable. The radio frequency channels B, M and T shall be allocated to the BSS. If no SFH is supported by the BSS, each of these frequencies shall be tested in turn. If SFH is supported, the BSS shall hop on these 3 frequencies. The test shall be repeated until all the RF equipment in the BSS configuration is tested on all the 3 frequencies.

REQUIREMENTS

The power level of the conducted spurious emissions or the effective radiated power shall never exceed the levels in Table 2-15 under normal test conditions.

Frequency Band:	Maximum Level:
Power leads:	
9 kHz - 10 MHz	72 dBuV(pd)
10 MHz - 30 MHz	72 dBuV(pd)
Radiated:	
30 MHz - 1000 MHz	-57 dBm
1000 MHz - 12.75 GHz	-47 dBm
Antenna connector:	
9 kHz - 1000 MHz	-57 dBm
1000 MHz - 12.75 GHz	-47 dBm

Table 2-15: Maximum level of RX spurious emissions

NOTE: 72 dBuV(pd) corresponds to 4mV. This is the limit given in the recommendation CEPT T/TR 02-02.

2.1.8. Radio Link Management

The tests in this section shall be performed under normal test conditions unless otherwise stated.

2.1.8.1. General

This section describes the functions of the BSS which gain, maintain and release access to the radio link, the main objective being to provide a stable link for the higher protocol layers whilst hiding, as far as possible, the properties of the radiopath.

The detailed operation of these functions can be found in GSM 05.08 and GSM 05.10. Some requirements are also found in GSM 05.02.

2.1.8.2. Synchronisation

The BSS shall provide control information to the MS so that its transmissions arrive at the BSS within the allocated timeslot window and within the correct frequency tolerance.

2.1.8.2.1. Absolute Frequency Tolerance

The BSS carrier frequency generated for any channel shall have an absolute frequency tolerance better than 0.05 ppm. This is measured in terms of the mean frequency error in section 2.1.6.2.

2.1.8.2.2. Relative Frequency Tolerance

The different carriers transmitted by a BSS shall all be derived from the same frequency source.

2.1.8.2.3. Timing Tolerance

DEFINITION

The timing tolerance between channels or different carriers of the BSS is the relative time between bits of the same bit number (BN) in timeslots of the same timeslot number (TN) and frame number (FN) transmitted simultaneously from one BSS on two different radio frequency channels.

METHOD OF MEASUREMENT

If SFH is supported by the BSS, it shall be disabled during this test.

The BCCH shall be used as the reference channel to measure the relative timing of a channel on all other carriers which may be transmitted simultaneously. The results shall be analyzed to ensure that the relative timing between any of the channels which are transmitted simultaneously meets the requirement.

The number of RF channels which may be transmitted simultaneously is dependent on the BSS configuration.

- 1) The BSSTE shall establish a TCH using timeslot 0 in the TDMA frame structure (TN=0) on a specific frequency.
- 2) The relative timing between this frequency and the BCCH frequency shall be measured at the leading edge of bit 14 of the training sequence (BN=74) and the result shall be recorded. TDMA-frames carrying Frequency Correction bursts or Synchronization bursts (T3=0,1,10,11,20,21,30,31,40,41) shall be excluded.
- 3) Steps 1 and 2 shall be carried out with the TCH at the RF channels B, M and T, but avoiding the use of the same frequency as the BCCH.
- 4) Step 3 shall be carried out with the BCCH at the RF channels B, M and T, but avoiding the use of the same frequency as the TCH. The BCCH frequency shall be offset to the closest used RF channel in case they coincide.
- 5) Step 4 shall be carried out for all the carriers that may be transmitted simultaneously with the BCCH until all the RF equipment in the BSS configuration has been tested.
- 6) The timing measurement shall be used to establish the maximum time difference between any two channels.

REQUIREMENTS

The timing difference (as established in step 6) between the different carriers transmitted by a BSS/BTS shall be less than 1/4 bit, measured at the BSS/BTS antenna connector.

2.1.8.2.4. Synchronisation of Data Clocks

The BSS clocking and timebase shall be derived from the same frequency source used for RF generation. It is optional for a BSS to be able to transmit and receive synchronization signals for network synchronization.

2.1.8.3. Frame structure

This section verifies that the BSS correctly generates TDMA frames and is capable of receiving transmitted bursts from Mobile Stations generated according to GSM recommendations. For further information see GSM 05.02.

Only certain specified combinations of logical channels are permitted. These are tested implicitly in other parts of this recommendation.

2.1.8.3.1. BCCH Multiframe

DEFINITION

The BCCH multiframe consist of 51 TDMA frames. This channel broadcasts general information on a BSS per BSS basis. The frequency information is carried on the Frequency Correction Channel (FCCH) and the synchronisation is transmitted on the Synchronisation Channel (SCH). For further information see GSM 05.02.

METHOD OF MEASUREMENT

The BSS is configured with a BCCH carrier. This is monitored in the BSSTE.

The BSSTE shall search for the Frequency Correction burst.

The BSSTE shall then search for the Synchronisation burst.

REQUIREMENTS

The BSSTE shall detect Frequency Correction bursts at $T3 = 0, 10, 20, 30$ and 40 and for no other $T3$ ($T3 = FN \bmod 51$, $FN =$ TDMA frame number).

The BSSTE shall also detect synchronization bursts at $T3 = 1, 11, 21, 31,$ and 41 and for no other $T3$.

At the SCH the BSSTE shall detect the BSIC set up for the BTS/BSS. This applies to any BSIC. The BSSTE shall also detect the correct RFN for the various $T3$ s.

2.1.8.3.2. Transmit-receive delay

At the MS the start of the frame on the uplink is delayed by a fixed period of 3 timeslots from the start of the TDMA frame on the downlink. This is regarded to be tested implicitly during other tests.

2.1.8.3.3. TDMA-frame structure

DEFINITION

One TDMA frame consists of eight timeslots, with an average length of 156.25 bit periods. This may be achieved by setting all timeslots to be 156.25 bit periods or setting timeslots 0 and 4 to 157 bit periods and the remaining (1, 2, 3, 5, 6, 7) to 156 bit periods. This section will test that the BSS conforms to the declared frame structure.

METHOD OF MEASUREMENT

The BSS shall be configured to generate multiframes with a channel combination which gives a contiguous stream of normal or dummy bursts as defined in GSM 05.02 for more than one frame. If SFH is supported by the BSS, it shall be disabled during this measurement.

The slot lengths will be measured between the leading edge of the 14th bit of the training sequence for that slot and the leading edge of the 14th bit of the training sequence for the next slot.

REQUIREMENTS

The measurements shall conform to the frame structure a) or b) stated by the manufacturer.

- a) The length of each timeslot shall be 156.25 bit periods.
- b) The length of timeslots 0 and 4 shall be 157 bit periods and the length of the remaining (1, 2, 3, 5, 6, 7) shall be 156 bit periods.

2.1.8.3.4. SACCH multiframe

A SACCH multiframe consists on Layer 1 of 26 TDMA frames used for full-rate or half-rate traffic channels. The detailed definition of a SACCH multiframe is in GSM 05.02.

The SACCH multiframe is considered implicitly tested by other tests.

2.1.8.4. Radio link measurements

Whilst calls are being established and for their duration, the reception quality shall be continuously assessed in the BSS as criteria for handover and RF power control algorithms. The following criteria may be employed in order to perform this assessment:

- Signal strength (RXLEV)
- Signal quality (RXQUAL)
- MS-BSS distance
- Idle channel level.

The strategy used for making the decision to initiate handover based on above parameters is up to the operator. However, the BSS shall be able to report the measured results as a response to a specific O&M-message as defined by the operator or the manufacturer, if used in the RF power control and handover algorithm.

For the tests in this section the BSS shall be hopping over the maximum range and number of carriers possible for the test environment and which are available in the BSS configuration, if Slow Frequency Hopping (SFH) is supported by the BSS. If SFH is not supported, the tests in this section shall be performed for the radio frequency channels B, M and T. In both cases the tests shall be repeated until all the RF equipment in the BSS configuration is tested on all specified carrier frequencies.

2.1.8.4.1. Signal Strength

DEFINITION

The received signal level (RXLEV) shall be available as a criterion for the RF power control and handover process. When measured in the BSS the RXLEV will be based upon received signal levels from TCH's and DCCH's measured over a range of -110 dBm to -48 dBm sampled and averaged for the duration of one SACCH multiframe. The RXLEV shall be measured for all timeslots and radio frequencies assigned to a BSS in order to measure both signal levels and interference levels for channel assignment and handover.

METHOD OF MEASUREMENT

The BSSTE shall establish a call setup with the BSS and the RXLEV of the assigned channel shall be output from the BSS in the O&M-message.

The signal level from the BSSTE shall be adjusted over the level range -110.5 dBm to -47.5 dBm in 1 dB steps.

The measurement shall be performed under static propagation conditions only.

REQUIREMENTS

For any 20 dB portion of the range -110 dBm to -48 dBm no measured values shall deviate more than +/- 1 dB from the regression line of that 20 dB portion.

The absolute accuracy of any value between -110 dBm and -70 dBm shall be better than +/- 4 dB under normal test conditions.

From -110 dBm to -48 dBm the absolute accuracy shall be within +/- 6 dB under normal and extreme test conditions.

The RXLEV value shall nominally be mapped to the received signal level as in Table 2-16.

It is optional for the BSS to be able to report values below the reference sensitivity of -104 dBm.

RXLEV	Power level:
0	less than -110 dBm
1	-110 dBm to -109 dBm
2	-109 dBm to -108 dBm
.	.
.	.
62	-49 dBm to -48 dBm
63	greater than -48 dBm

Table 2-16: Signal level estimation requirements

2.1.8.4.2. Signal quality

DEFINITION

The signal quality is a Bit Error Ratio (BER) related quality estimate of the channel quality on a TCH or SDCCH. This estimate shall be derived in the BSS and may be used in the handover and RF power control algorithms. For further information see GSM 05.08.

METHOD OF MEASUREMENT

A call shall be set up between the BSSTE and the BSS.

A pseudo-random known bit sequence shall be input before channel encoding in the BSSTE and received in the BSS.

The signal level shall be varied such that the BER on the wanted TCH measured at the logical interface point before channel decoding in the BSS are within all the BER ranges for the RXQUAL values in Table 2-17 in turn.

The logical reference point before channel decoding may be obtained by using the unprotected class II bits after channel decoding before any extrapolation is applied. Half-rate channels are measured by first establishing a full-rate channel, measuring the error ratio and then establishing a half-rate channel and checking the indicated error ratio.

For each BER range an O&M-message as defined by the operator or the manufacturer shall be input on the OMC-interface after a few seconds and periodically once every SACCH multiframe (480 ms) requesting the signal quality level for the TCH/FS. The test shall be carried out using more than 1000 reports per BER range and with and without uplink DTX.

The measurement shall be performed under the propagation conditions static and TU50.

RXQUAL:	BER range:	Mean value:
0	< 0.2 %	0.14 %
1	0.2 % - 0.4 %	0.28 %
2	0.4 % - 0.8 %	0.57 %
3	0.8 % - 1.6 %	1.13 %
4	1.6 % - 3.2 %	2.26 %
5	3.2 % - 6.4 %	4.53 %
6	6.4 % - 12.8%	9.05 %
7	> 12.8	18.10 %

Table 2-17: Signal quality estimation requirements

REQUIREMENTS

The RXQUAL levels shall be mapped to the actual BER as listed in Table 2-18 in the relative number of cases shown in Table 2-18.

Table 2-18a shows the minimum probability that a specified value of RXQUAL shall be reported for a BER within the range as indicated in the table under static propagation conditions.

Table 2-18b shows the minimum probability that a specified value of RXQUAL or an adjacent value shall be reported for a BER within the range as indicated in the table under TU50 multipath propagation conditions.

RXQUAL:	BER range:	Relative number of cases on correct RXQUAL value:		
		Full rate:	Half rate:	DTX:
0	< 0.10%	90 %	90 %	65 %
1	0.26% - 0.30 %	75 %	60 %	35 %
2	0.51% - 0.64 %	85 %	70 %	45 %
3	1.0% - 1.3 %	90 %	85 %	45 %
4	1.9% - 2.7 %	90 %	85 %	60 %
5	3.8% - 5.4 %	95 %	95 %	70 %
6	7.6% - 11.0%	95 %	95 %	80 %
7	> 15.0	95 %	95 %	85 %

Table 2-18a: Signal quality estimation requirements (static)

Rel. number of cases on correct or 2 adjacent RXQUAL values:				

RXQUAL:	BER range:	Full rate:	Half rate:	DTX:

0	< 0.10%	85 %	85 %	85 %
1	0.26% - 0.30 %	85 %	75 %	75 %
2	0.51% - 0.64 %	85 %	70 %	25 %
3	1.0% - 1.3 %	90 %	80 %	35 %
4	1.9% - 2.7 %	90 %	85 %	50 %
5	3.8% - 5.4 %	90 %	90 %	65 %
6	7.6% - 11.0%	90 %	90 %	80 %
7	> 15.0	90 %	90 %	90 %

Table 2-18b: Signal quality estimation requirements (TU50)

2.1.8.4.3. MS-BSS distance

The BSS shall be able to continuously monitor the delay in the transmission from the MS relative to the expected signal from an MS at zero range. This is required to give Timing Advance information to the MS. For further information see GSM 05.10. This information of the delay (up to 63 bits) may also be used as a criteria for initiating handover at the cell boundary (MAX_MS_RANGE). For further information see GSM 05.08.

The MS-BSS distance assessment is considered tested by the tests of adaptive Time Alignment in section 2.1.8.6.

2.1.8.4.4. Idle channel signal level

As in section 2.1.8.4.1 but no call shall be set up. However, a normal GSM modulated signal is output from the BSSTE on the relevant idle channel. The test shall only be performed under normal test conditions and without SFH.

2.1.8.5. RF power control and handover

Adaptive RF power control is an optional requirement employed to minimise the transmitted power of the BSS whilst maintaining the quality of the radio link, thus minimising interference to cochannel MSs.

The RF power level employed in the BSS may be based upon the measurements reported by the MS and/or the measurements carried out by the BSS.

The strategy employed for RF power control and handover is to be determined by the network operator.

2.1.8.5.1. BCCH power level

The power level of the BCCH shall remain constant at all times and shall be monitored during other tests. However, ramping between timeslots is allowed (see sections 2.1.6.3 and 2.1.6.4).

2.1.8.6. Adaptive frame alignment

DEFINITION

Adaptive frame alignment is the mechanism by which the timeslots transmitted by the MS are initially and dynamically adjusted in time so that the received timeslots in the BSS always fall within the correct time window. This mechanism is controlled by the BSS.

The adaptive frame alignment mechanism is needed since the guard time between timeslots in the timeslot structure is not long enough to cope with MS-BSS propagation delays due to absolute distance. The MS timing is initially adjusted (initial alignment) when accessing the BSS, and is then continuously adjusted for relative distance variations during the call (dynamic alignment).

See GSM 05.10 and GSM 03.30 for further information.

METHOD OF MEASUREMENT

If Slow Frequency Hopping (SFH) is supported by the BSS, it shall be disabled during this measurement. The tests shall be performed for the radio frequency channels B, M and T.

During the tests timeslots 0 and 1 (and 1 and 2) on the same carrier shall be considered simultaneously, and the Timing Advance (TA) value signalled to the 2 Mobile Stations concerning adjacent timeslots shall be monitored and compared.

Both the 2 adjacent timeslots shall be exposed to the following propagation conditions in turn:

- a) Static,
- b) TU50,
- c) HT100,
- d) RA130.~~RA250~~.

The propagation conditions for the 2 timeslots shall be independent.

5.1.3.1. System information

DEFINITION

The system information procedure is used by the BSS to modify the information contents to be transmitted on the SACCH when a dedicated resource has been set up or on the BCCH when no dedicated resource has been set up (or in fact always). The BSS will send SYSTEM INFORMATION messages type 1-4 on the BCCH and SYSTEM INFORMATION messages type 5-6 on the SACCH. The system information is always controlled by O&M. The timing requirements for when to send the different SYSTEM INFORMATION messages are described in GSM 05.02.

METHOD OF TEST

1. An O&M message as defined by the operator or the manufacturer shall be input on the OMC-interface commanding the BSS to modify the broadcast information to go on the BCCH or SACCH. The response on any interface shall be recorded.
2. A dedicated resource shall be set up between the radio interface and the MSC-interface. The response on any interface shall be recorded.
3. The dedicated resource shall be released, and steps 1 and 2 shall be repeated until all the SYSTEM INFORMATION messages type 1-6 (including types 2bis and 5bis) are verified.

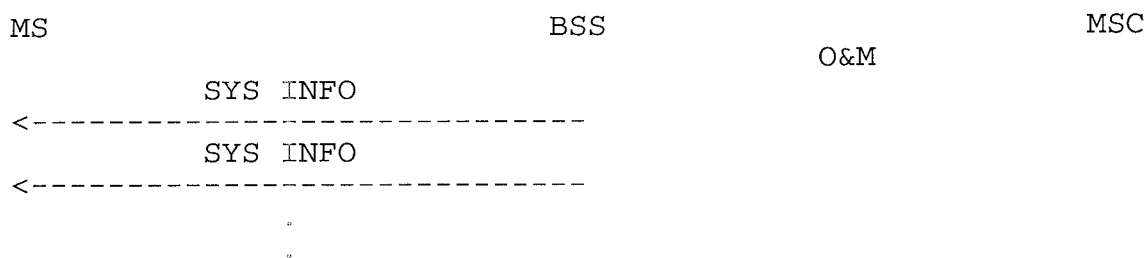

Figure 5-1: System information - normal case

The messages from the BSSTE will be:

1. O&M MESSAGES

REQUIREMENTS

In the case of step 1, SYSTEM INFORMATION messages of the type 1 to 4 (including type 2bis) shall occur on the radio interface on the BCCH. The information contents shall correspond to what is set by O&M.

In the case of step 2, SYSTEM INFORMATION messages of the type 5 to 6 (including type 5bis) shall occur on the radio interface on the SACCH, and the SYSTEM INFORMATION messages of the type 1 to 4 (including type 2bis) shall continue to occur on the radio interface on the BCCH. The information contents shall correspond to what is set by O&M.

In the case of step 3, the requirements in steps 1 and 2 apply.

The messages from the BSS shall be:

1-3.SYSTEM INFORMATION TYPE 1

Cell channel description
RACH control parameters

1-3.SYSTEM INFORMATION TYPE 2

Neighbour cells description
PLMN permitted
RACH control parameters

| 1-3.SYSTEM INFORMATION TYPE 2bis

| Neighbour cells description (extension)
| RACH control parameters

1-3.SYSTEM INFORMATION TYPE 3

Cell identity
Location area identification
Control channel descriptions
Cell options
Cell selection parameters
RACH control parameters

1-3.SYSTEM INFORMATION TYPE 4

Location area identification
Cell selection parameters
RACH control parameters
(CBCH) channel description
(CBCH) mobile allocation

| 2-3.SYSTEM INFORMATION TYPE 5

Neighbour cells descriptions

| 2-3.SYSTEM INFORMATION TYPE 5bis

| Neighbour cells descriptions (extension)

42-3.SYSTEM INFORMATION TYPE 6

Cell identity
Location area identification
Cell options
PLMN permitted
Cell description

5.1.3.2. Service requests in SABM frames

DEFINITION

When the MS first accesses the network on a signalling link, it is in order to request a kind of service. The requests can be one of the following Layer 3 messages:

LOCATION UPDATING
CM SERVICE REQUEST
PAGING RESPONSE
IMSI DETACH
CM REESTABLISHMENT REQUEST

These Layer 3 messages are transferred in the LAPDm SABM frame setting up the LAPDm signalling link. The CM SERVICE REQUEST may concern a normal call or eg a Short Message Service (SMS).

METHOD OF TEST

1. The random access by MS and immediate assignment procedure in section 5.1.3.3 shall be carried out to assign a dedicated resource. Then a LAPDm SABM frame shall be input on the radio interface with an information field as given above. The response on any interface shall be recorded.
2. Step 1 shall be repeated for all the Layer 3 messages indicated above.
3. Step 1 shall be repeated with a message not defined above.

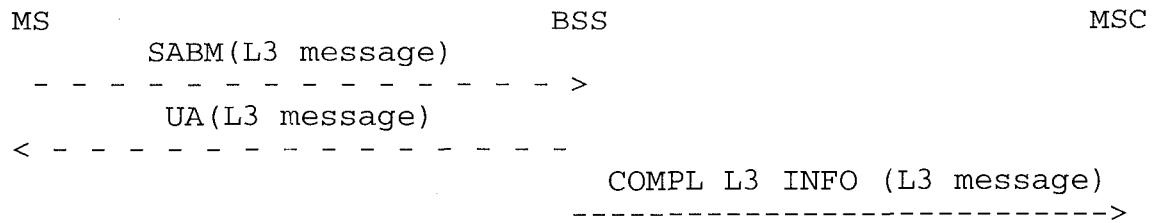

Figure 5-2: Service requests in SABM frames - normal case

The messages from the BSSTE will be:

1,2.SABM(LOCATION UPDATING REQUEST)

Location updating type
Ciphering key sequence number
Location area identification
Mobile Station classmark 1
Mobile identity

1,2.SABM(CM SERVICE REQUEST)

CM service type
Ciphering key sequence number
Mobile Station classmark 2
Mobile identity

1,2.SABM(PAGING RESPONSE)

Ciphering key sequence number
Mobile Station classmark 2
Mobile identity

1,2.SABM(IMSI DETACH INDICATION)

Mobile Station classmark 1
Mobile identity

1,2.SABM(CM REESTABLISHMENT REQUEST)

Ciphering key sequence number
Location area identification
Mobile Station classmark 2
Mobile identity

3. LAYER 3 MESSAGE

In the case of step 6, a CLEAR COMPLETE message shall occur on the MSC-interface and the radio resources in the BSS shall be available for use by other calls.

In the case of step 7, a CLEAR REQUEST message shall occur on the MSC-interface with the cause value "radio interface message failure".

NOTE: There are indications that the cause value in the CLEAR REQUEST message in step 7 may change !!

In the case of step 8, a HANDOVER FAILURE message shall occur on the MSC-interface with the cause value "radio interface failure, reversion to old channel".

The messages from the BSS shall be:

4. HANDOVER REQUIRED

Cause
Response request = yes
Cell identifier list preferred
Current radio environment
Environment of BS "n"

5. HANDOVER COMMAND

Cell description
Channel description
Handover reference
Power command
Synchronization indication
Frequency Short List
Frequency List
Cell channel description
Channel mode
Channel description
Channel mode 2
Frequency channel sequence
Mobile allocation
Starting time

6. CLEAR COMPLETE

--

7. CLEAR REQUEST

Cause = as in text

8. HANDOVER FAILURE

Cause = as in text
RR cause = PAR1

5.1.3.8. External handover as seen from the new BSS
-----5.1.3.8.1. Non-synchronized network

DEFINITION

This procedure allows the MSC to request resources from a BSS in a manner similar to that used for the assignment case and terminates the handover seen from the MS. It is used during handover with the new BSS for allocation of the necessary resources before the MS accesses the BSS and covers the procedure defined in GSM 08.08 as:

- handover resource allocation

METHOD OF TEST

1. O&M-messages as defined by the operator or the manufacturer shall be input on the OMC-interface setting the timer T3105 to an appropriate value B, the parameter Nyl to an appropriate value C, restricting the BSS to choose only one dedicated channel and disabling queuing on handover requests, if supported.
2. A HANDOVER REQUEST message shall be input on the MSC-interface. The message shall contain an indication of the type of channel needed and the terrestrial resource to be used. The channel shall be a TCH and the terrestrial resource to be used shall be A. The response on any interface shall be recorded.
3. An O&M-message as defined by the operator or the manufacturer shall be input on the OMC-interface commanding the BSS to block the terrestrial resource A. Then the step 2 shall be repeated concerning the terrestrial resource A.
4. An O&M-message as defined by the operator or the manufacturer shall be input on the OMC-interface commanding the BSS to put all TCHs out of service. Then step 2 shall be repeated. The response on any interface shall be recorded.
5. Step 2 shall be repeated, and then HANDOVER ACCESS messages shall be input on the radio interface on the main signalling link (the correct physical channel) with the same handover reference number as in the HANDOVER REQUEST ACKNOWLEDGE message output in step 2. The response on any interface shall be recorded. No further messages shall be input.

METHOD OF TEST

1. An O&M message as defined by the operator or the manufacturer shall be input on the OMC-interface setting the system information to be sent on the SACCH or BCCH. The response on any interface shall be recorded. This shall be repeated until all SYSTEM INFORMATION types 1 to 4 (including type 2bis) are verified.

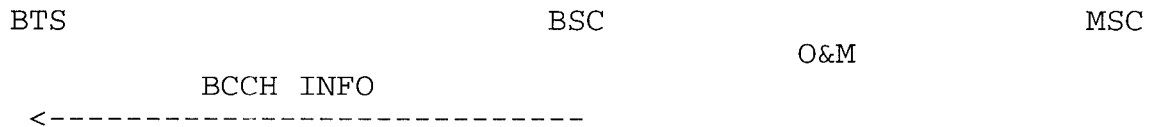

Figure 6-25: Broadcast information modify - normal case

The messages from the BSSTE will be:

1. O&M MESSAGES

REQUIREMENTS

In the case of step 1, a BCCH INFORMATION message shall occur on the A-bis-interface with the new BCCH parameters.

The messages from the BSC shall be:

1. BCCH INFORMATION

Channel number
System information type = 1, 2, 2bis, 3, 4
Layer 3 information (SYS INFO)
Starting time

6.1.3.26. Immediate assignment -----

When the MS initially accesses the BTS, the BSC immediately assigns a dedicated resource.

The immediate assignment procedure is seen as implicitly tested by the channel activation procedure (random access by MS) in section 6.1.3.10.

6.1.3.27. Short Message Service Cell Broadcast (SMSCB) -----

NOTE: As the procedure to initiate the SMS Cell Broadcast function in the BSC is not specified, this function will not be tested for the BSC.

6.1.3.28. Radio resource indication

DEFINITION

The radio resource indication procedure is used by the BTS to report to the BSC on the interference levels on idle channels.

METHOD OF TEST

1. The BSSTE shall continuously input RF RESOURCE INDICATION messages to the BSC over the A-bis-interface with an interval of A.
2. An O&M message as defined by the operator or the manufacturer shall be input on the OMC-interface setting the thresholds for the spontaneous RESOURCE INDICATION messages. Then a RESOURCE REQUEST message indicating "spontaneous indication" shall be input on the MSC-interface. The response on any interface shall be recorded.
3. The environment shall be set up to trigger a spontaneous RESOURCE INDICATION message from the BSC. The response on any interface shall be recorded.
4. A RESOURCE REQUEST message indicating "one single indication" shall be input on the MSC-interface. The response on any interface shall be recorded.
5. A RESOURCE REQUEST message indicating "periodic indication" and a periodicity of $T3=B>0$ shall be input on the MSC-interface. The response on any interface shall be recorded.
6. A RESOURCE REQUEST message indicating "no indication" shall be input on the MSC-interface. The response on any interface shall be recorded.

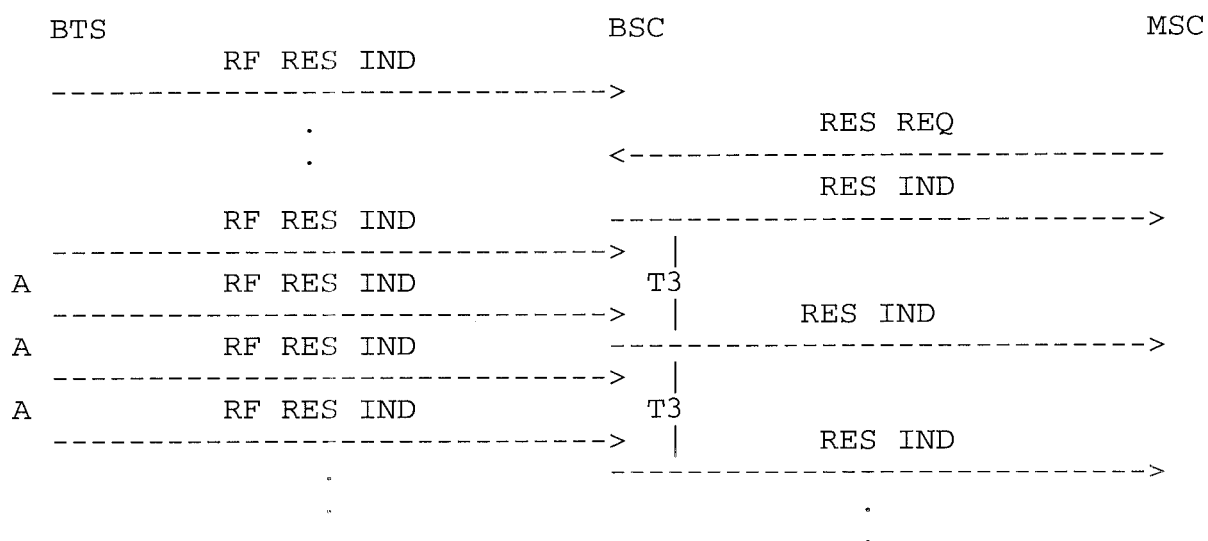

Figure 6-28: Radio resource indication - normal case

The messages from the BSSTE will be:

1. RF RESOURCE INDICATION

Resource information

2. O&M MESSAGES

2. RESOURCE REQUEST

Periodicity

Cell identifier

Resource indication method = as in text

4-6.RESOURCE REQUEST

Periodicity = none, B, none

Cell identifier

Resource indication method = as in text

REQUIREMENTS

In the case of step 3, a RESOURCE INDICATION message shall occur on the MSC-interface reflecting the information in the latest RF RESOURCE INDICATION message.

In the case of step 4, a RESOURCE INDICATION message shall occur immediately on the MSC-interface reflecting the information in the latest RF RESOURCE INDICATION message.

In the case of step 5, RESOURCE INDICATION messages shall occur repeatedly on the MSC-interface with an interval $T3=B$ each reflecting the information in the latest RF RESOURCE INDICATION messages.

In the case of step 6, no further RESOURCE INDICATION messages shall occur on the MSC-interface.

The messages from the BSC shall be:

3-5.RESOURCE INDICATION

Resource available

Cell identifier

6.1.3.29. SACCH filling information modify

DEFINITION

The SACCH filling information modify procedure is used by the BSC to change the system information content generally to be transmitted on the SACCH.

METHOD OF TEST

1. An O&M message as defined by the operator or the manufacturer shall be input on the OMC-interface commanding the BSC to modify the system information to be transmitted on the BCCH or SACCH. The response on any interface shall be recorded. This shall be repeated until all the SYSTEM INFORMATION messages type 5 and 6 (including type 5bis) are verified.

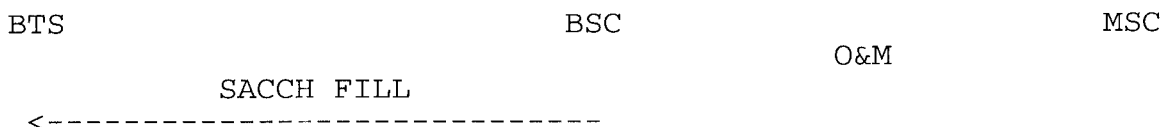

Figure 6-29: SACCH filling information modify - normal case

The messages from the BSSTE will be:

1. O&M MESSAGES

REQUIREMENTS

In the case of step 1, a SACCH FILLING message shall occur on the A-bis-interface with the new system information to go in the SYSTEM INFORMATION messages type 5 and 6 (including type 5bis).

The messages from the BSC shall be:

2. SACCH FILLING

System information type = 5, 5bis, 6
Layer 3 information (SYS INFO)
Starting time

6.1.3.30. Flow control

The flow control procedure on the A-bis-interface is used to indicate to the BSC if there is some kind of overload situation in the BTS, eg on the TRX processor, on the downlink CCCH or on the ACCH, by sending an OVERLOAD message to the BSC. The BSC will then try to reduce the load on the BTS. The signalling procedure is given in GSM 08.58.

The method of reducing the load is a national or operator specific matter. Consequently, the procedure is not tested.

REQUIREMENTS

In the case of step 2, PAGING REQUEST messages type 1, 2 or 3 shall occur on the radio interface on the correct paging subchannel of the PCH. On all other paging subchannels fill PAGING REQUEST messages (type of identity = no identity) or other valid Layer 3 messages shall occur.

The messages from the BTS shall be:

2. PAGING REQUEST TYPE 1

Page mode
Mobile identity
Mobile identity

2. PAGING REQUEST TYPE 2

Page mode
TMSI
TMSI
Mobile identity

2. PAGING REQUEST TYPE 3

Page mode
TMSI
TMSI
TMSI
TMSI

7.1.3.23. Delete indication

The delete indication procedure is used by the BTS to indicate to the BSC that a UNIT DATA REQUEST message containing a message transparent to the BTS, ie IMMEDIATE ASSIGNMENT, has been deleted due to overload on the downlink CCCH. For further information see GSM 08.58.

This procedure may be tested generating an overload situation on the downlink CCCH. Load testing of a BTS is outside the scope of this specification. Load testing of a BTS is a national or operator specific matter.

7.1.3.24. CCCH load indication

The CCCH load indication procedure is used by the BTS to inform the BSC that the load on the CCCH exceeds a certain threshold. For further information see GSM 08.58.

The fact that the BTS is able to generate such a message may be tested by imposing a certain load on the CCCH. Load testing of the BTS is, however, outside the scope of this specification. Load testing of the BTS is a national or operator specific matter.

7.1.3.25. Broadcast information modify

DEFINITION

The broadcast information modify procedure is used by the BSC to set new BCCH parameters to be transmitted from the BTS. The signalling procedure is specified in GSM 08.58 and the timing requirements for the SYSTEM INFORMATION messages are specified in GSM 05.02.

METHOD OF TEST

1. A BCCH INFORMATION message shall be input on the A-bis-interface setting the system information to go on the BCCH. The message concerned shall be SYSTEM INFORMATION type 1. The response on any interface shall be recorded.
2. Step 1 shall be repeated for SYSTEM INFORMATION types 2-4 (including type 2bis).

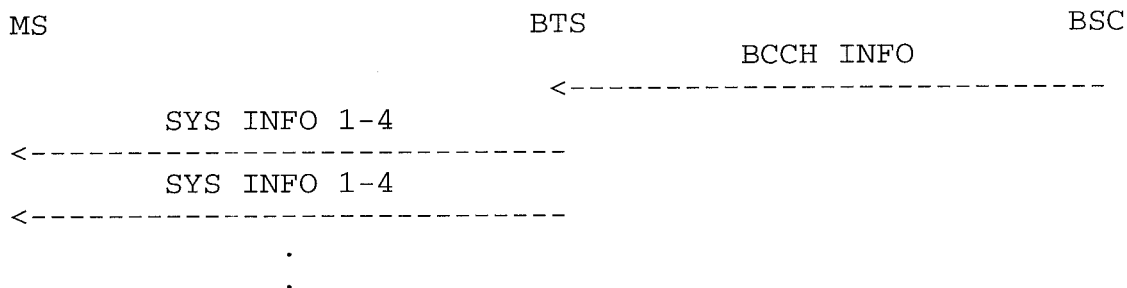

Figure 7-25: Broadcast information modify - normal case

The messages from the BSSTE will be:

1. BCCH INFORMATION

Channel number
System information type = 1
Layer 3 information (SYS INFO)
Starting time

2. BCCH INFORMATION

Channel number
System information type = 2, 2bis, 3, 4
Layer 3 information (SYS INFO)
Starting time

REQUIREMENTS

In the case of step 1, a SYSTEM INFORMATION message of the type 1 shall occur continuously on the radio interface on the BCCH with the new system information parameters.

In the case of step 2, SYSTEM INFORMATION messages of the type 2-4 (including type 2bis) shall occur continuously on the radio interface on the BCCH with the new system information parameters.

The messages from the BTS shall be:

1. SYSTEM INFORMATION TYPE 1

Cell channel description
RACH control parameters

2. SYSTEM INFORMATION TYPE 2

Neighbour cells description
PLMN permitted
RACH control parameters

2. SYSTEM INFORMATION TYPE 2bis

Neighbour cells description (extension)
RACH control parameters

2. SYSTEM INFORMATION TYPE 3

Cell identity
Location area identification
Control channel descriptions
Cell options
Cell selection parameters
RACH control parameters

2. SYSTEM INFORMATION TYPE 4

Location area identification
Cell selection parameters
RACH control parameters
(CBCH) channel description
(CBCH) mobile allocation

7.1.3.26. Immediate assignment

DEFINITION

When the MS initially accesses the BTS, a dedicated resource is immediately allocated by the BSC.

METHOD OF TEST

1. An IMMEDIATE ASSIGNMENT COMMAND message shall be input on the A-bis-interface requesting a normal immediate assignment. The response on any interface shall be recorded.
2. Step 1 shall be repeated for the immediate assignment types "extended" and "rejection", in turn.

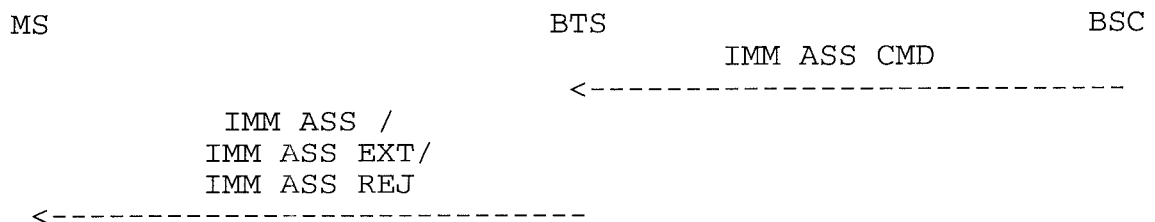

Figure 7-26: Immediate assignment - normal case

The messages from the BSSTE will be:

1. IMMEDIATE ASSIGNMENT COMMAND

Channel number
Immediate assignment information = IMM ASS
MS identity

2. IMMEDIATE ASSIGNMENT COMMAND

Channel number
Immediate assignment information = IMM ASS EXT, IMM ASS REJ
MS identity

REQUIREMENTS

In the case of step 1, an IMMEDIATE ASSIGNMENT message shall occur on the radio interface. The page mode may be set by the BTS.

In the case of step 2, an IMMEDIATE ASSIGNMENT EXTENDED message and an IMMEDIATE ASSIGNMENT REJECT shall occur on the radio interface. The page mode may in both cases be set by the BTS.

The messages from the BTS shall be:

1. IMMEDIATE ASSIGNMENT

- Page mode
- Channel description
- Request reference
- Timing advance
- Mobile allocation
- Starting time

2. IMMEDIATE ASSIGNMENT EXTENDED

- Page mode
- Channel description 1
- Request reference 1
- Timing advance 1
- Channel description 2
- Request reference 2
- Timing advance 2
- Mobile allocation
- Starting time

2. IMMEDIATE ASSIGNMENT REJECT

- Page mode
- Request reference
- Wait indication
- Request reference
- Wait indication
- Request reference
- Wait indication
- Request reference
- Wait indication

7.1.3.27. Short Message Service Cell Broadcast (SMSCB)

DEFINITION

This procedure is used by the BSC to request the transmission of an SMS Cell Broadcast block on the CBCH by the BTS. The signalling procedure is given in GSM 08.58.

METHOD OF TEST

1. The BTS shall be configured with a CBCH active with SDCCH/4 or SDCCH/8.
2. An SMS BROADCAST REQUEST message shall be input on the A-bis-interface. The response on any interface shall be recorded.

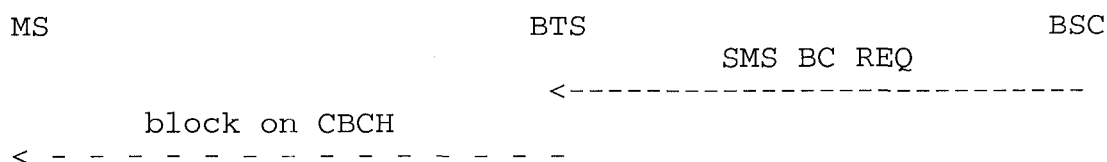
Figure 7-27: SMS Cell Broadcast - normal case

The messages from the BSSTE will be:

2. SMS BROADCAST REQUEST

Channel number
SMSCB information

REQUIREMENTS

In the case of step 2, a block shall occur on the radio interface on the CBCH exactly as given in the SMSCB information element in the SMS BROADCAST REQUEST message input on the A-bis-interface.

7.1.3.28. Radio resource indication

DEFINITION

The radio resource indication procedure provides interference levels on idle channels in a BTS to the BSC. The periodicity with which this is reported is set by the OMC.

METHOD OF TEST

1. The BTS shall be configured with a set of half-rate channels and a set of full-rate channels.
2. An O&M-message as defined by the operator or the manufacturer over the A-bis-interface shall set the timer [tbd] to a value B. The response on any interface shall be recorded.

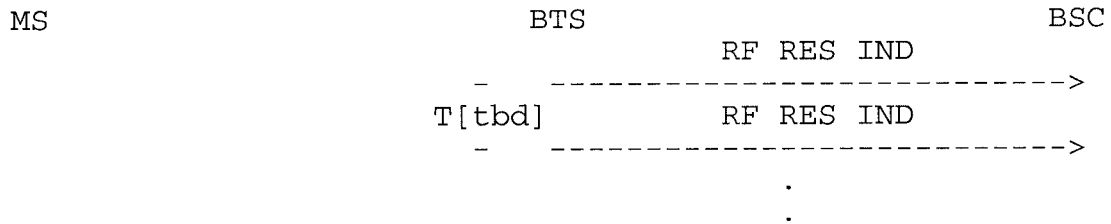
Figure 7-28: Radio resource indication - normal case

The messages from the BSSTE will be:

2. O&M MESSAGES

REQUIREMENTS

In the case of step 2, RF RESOURCE INDICATION messages shall occur repeatedly on the A-bis-interface with an interval B indicating the resources used for half-rate and full-rate channels.

The messages from the BTS shall be:

2. RF RESOURCE INDICATION

Resource information = as in text

7.1.3.29. SACCH filling information modify

DEFINITION

The SACCH filling information modify procedure is used by the BSC to change the system information content to be transmitted on the SACCH to a specific Mobile Station.

METHOD OF TEST

1. A dedicated resource shall be set up between the radio interface and the A-bis-interface. Then a SACCH FILLING message modifying the system information to be transmitted on the SACCH shall be input on the A-bis-interface. The response on any interface shall be recorded until all the SYSTEM INFORMATION messages type 5-6 (including type 5bis) are verified.

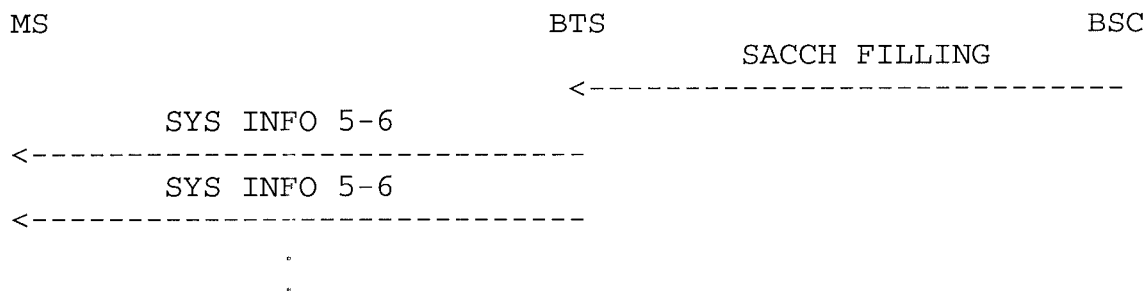

Figure 7-29: SACCH filling information modify - normal case

The messages from the BSSTE will be:

1. SACCH FILLING

System information type = 5, 5bis, 6
Layer 3 information (SYS INFO)
Starting time

REQUIREMENTS

In the case of step 1, a SYSTEM INFORMATION message of the type 5-6 (including type 5bis) shall occur on the radio interface on the SACCH.

The messages from the BTS shall be:

1. SYSTEM INFORMATION TYPE 5

Neighbour cells descriptions

1. SYSTEM INFORMATION TYPE 5bis

Neighbour cells descriptions (extension)

1. SYSTEM INFORMATION TYPE 6

Cell identity
Location area identification
Cell options
PLMN permitted
Cell description

7.1.3.30. Flow control

The flow control procedure on the A-bis-interface is used to indicate to the BSC if there is some kind of overload situation in the BTS, eg on the TRX processor, on the downlink CCCH or on the ACCH. The BSC will then try to reduce the load on the BTS. The signalling procedure is given in GSM 08.58.

The overload situation will take part of the load testing of a BTS and is outside the scope of the standardized acceptance tests in this specification. Load testing of a BTS is a national or operator specific matter.

7.1.3.31. Error reporting

DEFINITION

The error reporting procedure is used by the BTS in order to report to the BSC when it detects an erroneous message. The erroneous messages are defined in GSM 08.58.

METHOD OF TEST

1. A dedicated resource shall be set up between the radio interface and the A-bis-interface.
2. An erroneous message shall be input on the A-bis-interface. The response on any interface shall be recorded.

NOTE: The test is carried out for the erroneous messages on the A-bis-interface only. It should be noted that the ERROR REPORT message might also be used for erroneous messages on the radio interface. It is not specified, however.

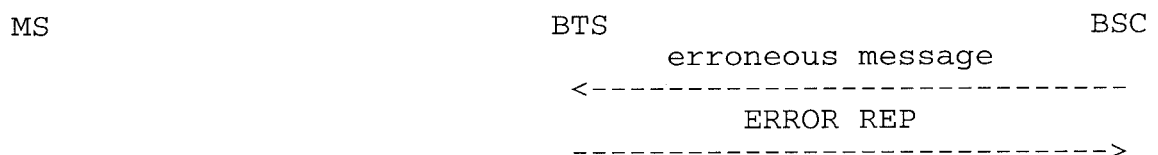

Figure 7-31: Error reporting - normal case

REQUIREMENTS

In the case of step 2, an ERROR REPORT message shall occur on the A-bis-interface with an appropriate cause value. The information elements of the message shall correspond to the erroneous message input.

The messages from the BTS shall be:

2. ERROR REPORT

Cause
Message identifier
Channel number
Link identifier
Message indicator
Erroneous message

7.1.4. Transcoding/rate adaptation functions

When multiplexing four speech/data channels to one 64 kbit/s link between BTS and BSC, the transcoder/rate adaptation functions as tested for the BSS as a whole in section 5.1.4 are put in the BSC with some additional A-interface specific functions in the BSC and BTS, resulting in an intermediate rate of 16 kbit/s per user channel at the A-bis-interface.

Otherwise (using a 64 kbit/s A-bis-interface) the transcoding and rate adaptation functions are all located in the BTS, and all tests of the BTS shall be carried out exactly as for the BSS as a whole using the A-bis-interface instead of the A-interface.

This section applies only to a BTS using a 16 kbit/s A-bis-interface.

7.1.4.1. Full-rate speech related transcoding functions

Speech related transcoding functions are 2 stages of speech transcoding in uplink and downlink, and uplink and downlink functions for support of Discontinuous Transmission (DTX).

For further information see GSM 06.01, GSM 06.10, GSM 06.11, GSM 06.12, GSM 06.31 and GSM 06.32.

7.1.4.1.1. Uplink speech transcoding - step 1

Not applicable to a BTS using a 16 kbit/s A-bis-interface.

7.1.4.1.2. Uplink speech transcoding - step 2

Not applicable to a BTS using a 16 kbit/s A-bis-interface.

7.1.4.1.3. Uplink receiver DTX functions

DEFINITION

The overall operation of the full rate DTX receiver functions are described in GSM 06.31, consisting of, apart from the channel decoder, a SID frame detection function which is part of the Speech Handler in the BTS.

The side information to be transmitted uplink from the BTS with the speech frame over the A-bis-interface is a binary Bad Frame Indication (BFI) flag, a binary Time Alignment Flag (TAF) and a ternary Silence Descriptor (SID) flag.

The channel decoder including the BFI is tested in section 2.1.

METHOD OF TEST

A call shall be set up on a full rate speech TCH, and then traffic frames being the special test frame defined in section 5.1.4.1.3 shall be input on the radio interface. The radio transmission conditions shall be non-limiting.

The test shall be repeated, but SID frames shall be input instead of the special test frames. The radio transmission conditions shall be non-limiting.

The test shall be repeated with SID frames, and the radio transmission conditions shall be varied until the SID flag on the A-bis-interface has been set to both 1 and 2.

REQUIREMENTS

When the special test frames are input on the radio interface, TRAU frames containing (BFI,SID)=(0,0) shall occur on the A-bis-interface.

When SID frames are input on the radio interface, TRAU frames containing (BFI,SID)=(0,2) shall occur on the A-bis-interface under non-limiting radio transmission conditions.

When SID frames are input on the radio interface under limiting radio transmission conditions, TRAU frames containing BFIs of 0 and 1 and SIDs of 0, 1 or 2 shall occur on the A-bis-interface.

Under all conditions, when the input test frame or SID frame on the radio interface comes in the middle of a SACCH multiframe according to GSM 05.08, the TAF flag shall be set to 1. Otherwise TAF=0.

7.1.4.1.4. Downlink speech transcoding - step 1

Not applicable to a BTS using a 16 kbit/s A-bis-interface.

7.1.4.1.5. Downlink speech transcoding - step 2

Not applicable to a BTS using a 16 kbit/s A-bis-interface.

7.1.4.1.6. Downlink transmitter DTX/VAD functions

It is a national or operator specific matter whether or not to implement downlink DTX in a BTS.

DEFINITION

If implemented, the overall operation of the full rate DTX transmitter functions are described in GSM 06.31, consisting of, apart from the channel encoder, an SP flag handling and monitoring function which in this case is the Speech Handler in the BTS.

The side information to be transmitted with the speech frame over the A-bis-interface is a binary flag Speech (SP). SP=1 indicates that the TRAU frame is a speech frame and SP=0 indicate that the TRAU frame is a special SID-frame. This flag is used in the BTS for control of the radio transmission.

The channel encoder is tested in section 2.1.

METHOD OF TEST

A call shall be set up on a full rate speech TCH, and then TRAU frames with random traffic bits accompanied with SP=0 or 1 in a random order shall be input on the A-bis-interface.

REQUIREMENTS

On the radio interface the following full rate "speech" traffic frames shall be transmitted on the air on the TCH/FS:

1. All frames with SP=1.
2. The first frame with SP=0 after one or more with SP=1.
3. Those marked with SP=0 and occurring in the middle of the SACCH multiframe as defined in GSM 05.08.

No other frames with SP=0 shall be transmitted on the air.

NOTE: Due to the block diagonal interleaving scheme defined for the TCH/FS, every traffic frame is transmitted in 8 TDMA frames. Since every TDMA frame contains 2 different traffic frames, there is not a one to one mapping between traffic frames "on" and TDMA frames transmitted on the air.

7.1.4.2. Data rate adaptation functions

If multiplexing of four data-channels to one 64 kbit/s link between BTS and BSC is applied, an intermediate rate adaptation function is needed. Hereby the radio interface data rates are converted via the standard CCITT V.110 80 bit frame to a modified CCITT V.110 72 bit frame at 16 kbit/s at the A-bis-interface, and vice versa. This function is performed by using the RA1/RA1' function and a new RAA function.

This intermediate modified CCITT V.110 72 bit frame at the A-bis interface is then further rate adapted in the BSC to 64 kbit/s at the A-interface by using the new RAA function and the RA2 function.

The additional coding of the "TRAU" frames for control of the remote transcoder/rate adaptation at the BSC/MSC site is tested in section 7.3.

The tests in this section apply only to a BTS using a 16 kbit/s A-bis-interface. If a 64 kbit/s A-bis-interface is used, the BTS shall be tested as the BSS as a whole in section 5.1.4.2 using the A-bis-interface instead of the A-interface.

7.1.4.2.1. Uplink rate adaptation in the BTS

DEFINITION

For the radio interface data rate of 12, 6 and 3.6 kbit/s, the modified CCITT V.110 60 or 36 bit frames shall be transformed via the CCITT V.110 80 bit frame to the modified CCITT V.110 72 bit frame at the rate of 16 kbit/s at the A-bis-interface.

METHOD OF TEST

a) Radio interface data rate of 12 kbit/s (transparent data)

One radio interface frame consisting of a sequence of 4 modified CCITT V.110 60 bit frames according to Figure 3 in GSM 04.21 shall be input to the BTS on the dedicated TCH. The user data shall be pseudo-random. The received data on the A-bis-interface shall be recorded.

b) Radio interface data rate of 6 kbit/s (transparent data)

One radio interface frame consisting of a sequence of 4 modified CCITT V.110 60 bit frames according to Figure 4 in GSM 04.21 shall be input to the BTS on the dedicated TCH. The user data shall be pseudo-random. The received data on the A-bis-interface shall be recorded.

c) Radio interface data rate of 3.6 kbit/s (transparent data)

One radio interface frame consisting of a sequence of 4 modified CCITT V.110 36 bit frames according to Figure 5 in GSM 04.21 shall be input to the BTS on the dedicated TCH. The user data shall be pseudo-random. The received data on the A-bis-interface shall be recorded.

d) Non-transparent data

One RLP frame consisting of a sequence of four modified CCITT V.110 60 bit frames for non-transparent data according to Figure 3 in GSM 08.20 shall be input to the BTS on the dedicated TCH. The user data shall be pseudo-random. The received data on the A-bis-interface shall be recorded.

If DTX is possible the test shall be repeated with no radio input on the radio interface (uplink DTX).

REQUIREMENTS

- a) The received data shall correspond to the transmitted data according to the modified CCITT V.110 72 bit frame, transformed via the CCITT V.110 80 bit frame, as stated in section 4.7.1 in 08.60. The mapping shall be as stated in section 5.1 in GSM 04.21. The received user data shall be bit-exact.
- b) As for a) except that the mapping shall be as stated in section 5.2 and 5.3 respectively in GSM 04.21.
- c) As b).
- d) As for a) except that the received modified CCITT V.110 72 bit frame shall be transformed via the modified CCITT V.110 80 bit frame for non-transparent data as stated in Figure 2 in GSM 08.20.

In the case of uplink DTX being applied on the radio interface, the BTS will interpret whatever it receives as data. Therefore, the data bits in the TRAU frames will be indeterminate.

7.1.4.2.2. Downlink rate adaptation in the BTS

DEFINITION

The modified CCITT V.110 72 bit frame at the A-bis-interface at the rate of 16 kbit/s shall be transformed, via the CCITT V.110 80 bit frame, to the modified CCITT V.110 60 bit frame or 36 bit frame at a radio interface data rate of 12, 6 or 3.6 kbit/s.

METHOD OF MEASUREMENT

a-c) Transparent data

Four modified CCITT V.110 72 bit frames as output from the BSC in the downlink according to the requirements in section 6.1.4.2.1 case a-c), shall be input to the BTS in turn on the A-bis-interface. The received data on the radio interface shall be recorded.

d) Non-transparent data

One RLP frame (TRAU frame) consisting of four modified CCITT V.110 72 bit frames for non-transparent data as output from the BSC in the downlink according to the requirements in section 6.1.4.2.1 case d), shall be input to the BTS on the A-bis-interface. The received data on the radio interface shall be recorded.

If DTX is possible the test shall be repeated with DTX active in the BTS and setting all the E1 bits in the TRAU frames to 1.

REQUIREMENTS

- a) The received data shall correspond to the modified CCITT V.110 60 bit frame according to section 5.1 in GSM 04.21.
- b) The received data shall correspond to the modified CCITT V.110 60 bit frame according to section 5.2 in GSM 04.21.
- c) The received data shall correspond to the modified CCITT V.110 36 bit frame according to section 5.3 in GSM 04.21.
- d) The received data shall correspond to the modified CCITT V.110 60 bit frame for non-transparent data according to Figure 3 in GSM 08.20, and the mapping stated in sections 5.1/5.2 in GSM 04.21.

In the case of DTX being active in the BTS and the E1 bits are set to 1, no frame shall be transmitted on the radio interface.

In all cases the received user data shall be bit-exact.

7.2. TRANSMISSION REQUIREMENTS FOR THE BTS

This section includes the necessary transmission requirements for the transmission through the Base Transceiver Station (BTS) in principle from the radio interface to the A-bis-interface, or in the opposite direction. The overall transmission requirements for the DCS 1800 GSM-PLMN are given in GSM 03.50, of which the PLMN transmission delay objective has been distributed to the various system entities as illustrated in GSM 03.05.

For speech channels the transmission through the BTS is completely digital and hence, the only relevant transmission requirement is the transmission delay through the BTS. The delay is specified for data channels as well as for speech channels.

7.2.1. Uplink TCH delay through the BTS (64 kbit/s A-bis-interface)

DEFINITION

The uplink delay is the time difference between the time of the end of the timeslot carrying the last burst with information from a defined frame over the radio interface and the time when the first bit of a defined frame has been received on the 64 kbit/s A-bis-interface by the BSSTE.

METHOD OF MEASUREMENT

As for the BSS as a whole in section 5.2.1, but using the A-bis-interface and the above definition.

ANNEX 1. GENERAL TESTING METHODOLOGY

=====

Tests shall be made under normal test conditions and also, where stated, under extreme test conditions as defined in section A1.2.

The requirements in this section apply to any BSS type or part of a BSS.

A1.1. GENERAL CONDITIONS

The general conditions during the tests shall be according to the relevant parts of recommendation CEPT T/R 24-01 annex 1 (Technical characteristics and test conditions for radio equipment in the land mobile service intended primarily for analogue speech) with the exceptions and additions defined in the subsections below.

A1.1.1. Test signals at the line input of the transmitting unit

The transmitting unit shall be supplied by the measuring equipment connected to the line input. The impedance of the line input circuit shall be according to CCITT recommendation G.703.

A1.1.2. Test signals at the line output of the receiving unit

A measuring equipment connected to line output of the receiving unit shall be able to verify the output signal. The nominal impedance of the line output circuit shall be according to CCITT recommendation G.703.

A1.2. TEST CONDITIONS, POWER SOURCES AND AMBIENT TEMPERATURES

The test conditions, test power sources and ambient temperatures during the tests shall be according to the relevant parts of recommendation CEPT T/R 24-01 annex 1 (Technical characteristics and test conditions for radio equipment in the land mobile service intended primarily for analogue speech) with the exceptions and additions defined in Annex 3.

A1.3. ACCEPTED UNCERTAINTY OF MEASUREMENT EQUIPMENT

The uncertainties of the measurement equipment indicated below are allowed. The uncertainties shall be taken into account in the test setup by correcting the setup with the relevant uncertainty values.

If the measurement equipment has better tolerances, the actual tolerance shall be used for the correction rather than the values indicated below.

1)	D.C. voltage	+/- 1 %
2)	A.C. mains voltage	+/- 1 %
3)	A.C. mains frequency	+/- 0.5 %
4)	Radio frequency	+/- 20 Hz
5)	Radio-frequency voltage	+/- 0.5 dB
6)	Radio-frequency power	+/- 0.5 dB
7)	Radio frequency carrier power	+/- 10 %
8)	Impedance of artificial loads, combining units, cable, plugs, attenuators, etc.	+/- 5 %
9)	Source impedance of generators and input impedance of measuring receivers	+/- 5 %
10)	Attenuation by attenuators	+/- 0.5 dB
11)	Temperature	+/- 1 deg C
12)	Humidity	+/- 5 %
13)	Transmission delay	+/- 0.1 ms
14)	Radio interface bit timing	+/- 0.1 us

A1.4. TESTING OF STATISTICAL PARAMETERS

When measuring statistical parameters like Bit Error Ratios (BERs) or Frame Erasure Ratios (FERs), the statistical nature of the error events may result in a natural variance in the observed test results. This variance will depend on the number of events observed. Consequently, due to such statistical limitations with the aim to reduce the test time to a minimum, some overall requirements should be met, indicating a certain confidence in the observed results.

Defining a "good" BSS as a BSS which on a long term basis (tested over an infinite time) meets the system requirement for an individual test, and a "bad" BSS as a BSS which on a long term basis fails the system requirement for an individual test, the overall requirements are the following:

1. The probability of passing a "good" BSS must be as high as possible.
2. The probability of passing a "bad" BSS must be as low as possible.

A1.4.1. General theoretical methodology

Statistical parameters are measured as a number of error events M within a set of observed events (or samples) N , and the ratio M/N is used as the estimated value. This estimate has a given uncertainty due to the limited statistical material, ie the number of samples N . The general methodology to ensure correct PASS / FAIL decisions is outlined in the following.

Given a random variable X_i output from a random process indicating error/no error, the probability of an error is p and consequently, the probability of no error is $1-p$. The expected value $E(X_i)$ and variance $\text{Var}(X_i)$ as given in (A1.1), according to the binomial probability distribution.

$$E(X_i) = p \quad (\text{A1.1a})$$

$$\text{Var}(X_i) = p - p^2 \quad (\text{A1.1b})$$

If the number of samples of the event is N , the average X of the random variables X_i is of interest, which has the expected value $E(X)$ and variance $\text{Var}(X)$ given in (A1.2), assuming that the random variables X_i are independent.

$$E(X) = p \quad (\text{A1.2a})$$

$$\text{Var}(X) = (p - p^2)/N \quad (\text{A1.2b})$$

Assuming that the error probability p is small, the formula can be simplified as in (A1.3).

$$E(X) = p \quad (\text{A1.3a})$$

$$\text{Var}(X) = p/N \quad (\text{A1.3b})$$

Furthermore, if the number of samples N is great, the probability density of X may be assumed to be Gaussian and the confidence intervals needed to support the overall requirements in section A1.4 above can easily be found.

Assuming that a "good" BSS has the real performance P_g when measured over an infinite time and that a "bad" BSS has the corresponding performance P_b , the relationships to the system requirement P_s are the following:

$$P_g \leq P_s \quad (A1.4a)$$

$$P_b > P_s \quad (A1.4b)$$

Irrespective of the values of P_g and P_b , the aim would ideally be to guarantee that the probabilities of passing a "good" BSS, $P(\text{PASS}|P_g)$ and the probability of failing a "bad" BSS, $P(\text{FAIL}|P_b)$ are as high as possible. Given a certain P_g and a certain P_b , this can be done by increasing the number of samples N until the distributions around P_g and P_b are "narrow" enough, ie the variances are sufficiently reduced, so that there is sufficient space in between for a test requirement P_t with the required confidence. The principle is illustrated in Figure A1-1 with $P_g=P_s$.

In practice, the above ideal approach can not be used since when P_g or P_b get very close to P_s , the needed number of samples to reduce the variances would be infinite. However, what can be done is to represent P_g by the worst-case P_s and to have a certain confidence of failing a BSS which is a given amount worse than P_s , ie with a fixed P_b . This will, however, give less confidence in failing a "bad" BSS which has a performance closer to P_s . This is the exact principle illustrated in Figure A1-1.

The test requirement P_t will then be as in equation (A1.5) for the overall requirements depending on P_s and P_b , and on the needed number of samples N :

$$P_t = P_s + G (P_s/N)^{1/2} \quad (\text{A1.5a})$$

$$P_t = P_b - B (P_b/N)^{1/2} \quad (\text{A1.5b})$$

G and B are the ordinates (in fact the inverse Gaussian Q-function) giving the normalized Gaussian distribution confidence intervals required for passing a "good" BSS and failing a "bad" BSS, respectively.

Finally, if the ratio P_b/P_s is fixed, the number of samples is given by the following equation (A1.6).

$$N = \frac{(G + K^{1/2} B)^2}{(K - 1) P_s} \quad , P_b = K P_s \quad (\text{A1.6})$$

A1.4.2. Detailed theoretical methodology

The total number of statistical tests indicated in appendix 1 (excluding blocking, intermodulation etc) are 95, and the rules of the tests shall be as follows:

- In order to pass a BSS it must pass all tests.
- A single test which fails should be repeated once. If the BSS fails a 2nd time, the BSS has failed.

This means that the overall probability of passing a good BSS through all the tests is lower than for the individual tests.

Taking into account the total of ~~95~~ 96 tests, assuming that the outcomes of the tests are independent, and requiring that the total probability of passing a "good" BSS shall be equal to the total probability of failing a "bad" BSS, the overall confidence requirements in section A1.4 above shall ideally be as follows on a test by test basis:

$$P(\text{PASS} | P_s) \geq 99.9\% \quad (\text{ie } G = 3.09)$$

$$P(\text{FAIL} | P_b) \geq 95.0\% \quad (\text{ie } B = 1.65)$$

With the above assumptions, the total probabilities of passing a "good" BSS and failing a "bad" BSS will be around 91.0%.

NOTE: If for some reason not all ~~95~~ 96 tests are carried out, then the probability of failing a "bad" BSS, $P(\text{FAIL}|\text{Pb})$, must be increased accordingly.

Since the test requirement P_t will lie somewhere in between the system requirement P_s and P_b , and that an uncertainty in test equipment resulting from imperfections in the randomness of pseudo-random generators etc can be expected to give errors of the order of $\pm 5\%$, the ratio P_b/P_s should be 2.

Under idealized assumptions, the resulting minimum number of samples needed to meet the overall confidence requirements is indicated as a function of the system requirement P_s using (A1.6) in Table A1-1.

The ratio of the test requirement P_t to the system requirement P_s will in this case be:

$$P_t = 1.57 P_s$$

NOTE: It is possible to reduce the needed number of samples. In that case the ratio P_b/P_s must be increased, or the confidence levels must be reduced, see equation (A1.5). It is preferable to keep the confidence and to increase P_b/P_s . However, the accepted error rate P_t , and P_b , should not deviate too much from the system requirement P_s , especially for high P_s . In order to have meaningful requirements it may even be desirable to reduce P_b/P_s for high P_s .

Error rate P_s :	Min no of samples:
1.0 E-1	300
1.0 E-2	3 000
1.0 E-3	30 000
1.0 E-4	300 000
1.0 E-5	3 000 000

Table A1-1: Minimum number of samples for statistical testing

A1.4.3. Limitations and corrections to the theoretical methodology

The idealized assumptions resulting in Table A1-1 are:

1. All random variables X_i (error events) are assumed to be independent.
2. The observed random variable X is assumed to have a Gaussian distribution.
3. All random variables X_i (error events) are assumed to be outputs of stationary random processes with identical distributions.
4. The system requirement P_s is assumed to be sufficiently small.

A1.4.3.1. Independent errors

The assumption that all error events are independent does not strictly hold. The fact that error events are mutually dependent, would increase the variance of the observed random variable X , and consequently, the number of samples needed for the confidence required should be multiplied by some factor indicating the number of error events which on average are completely correlated.

- For FERs the events occur so seldomly that the events may be regarded as independent (factor of 1), the exception being TCH/FS and FACCH which should have a factor of 2.
- Since a convolutional decoder on average will produce burst errors of the order of the constraint length, BERs and RBERS should have a factor of 5.

Generally, the situation will be such that a "good" BSS will have a performance P_g which is better than P_s . Consequently, the number of samples found in all cases by (A1.6) should be multiplied by an additional factor of 2.

A1.4.3.2. Gaussian distribution

The assumption of a Gaussian distribution for the observed random variable X should hold in most cases due to the high number of samples used.

A1.4.3.3. Stationary random processes

The assumption that the error events are outputs of stationary random processes with identical distributions holds generally for static propagation conditions. However, for multipath propagation conditions this is not true. On the other hand, the multipath radio channel may be assumed to be stationary for short periods of time. Taking into account the worst-case situation of flat fading where the distance between fades is a wavelength, the channel may be assumed to change eg 10 times per wavelength and to be short term stationary in between. This means that all the different random variables X_i (error events) have a different p_i and consequently different $E(X_i)$ and $\text{Var}(X_i)$. Since all p_i are unknown and only the random variable X , which is the average of all X_i , is observed against a system requirement P_s , the statistical parameters of (A1.7) result in the case of multipath propagation conditions assuming that all p_i are independent.

$$E(X) = 1/N \sum_{i=1}^N p_i = p \quad (\text{A1.7a})$$

$$\text{Var}(X) = p/N - 1/N^2 \sum_{i=1}^N p_i^2 \quad (\text{A1.7b})$$

Also in this case the variance can (and must) be simplified to p/N if all p_i are small. However, in this case the second term of (A1.7b) is dominated by the greatest p_i and the simplification is less valid than for static propagation conditions. Nevertheless, the needed number of samples given by (A1.6) is conservative because the variance would ideally be lower. On the other hand, if the fact that the different p_i are likely to be correlated with positive correlation is taken into account, $\text{Var}(X)$ will increase and the simplification to p/N might be adequate.

Since under multipath conditions the observed random variable X results from an average of a set of random processes, we must ensure that the average takes into account a sufficient number of processes to get an overall stationary process. Requiring an average over 1000 wavelengths (or 10 000 processes if the channel is updated every 10th of a wavelength), the resulting observation period needed is indicated in Table A1-2 if the logical channel in question occupies the basic physical channel all the time. The percentage of the time "on the air" for the logical channel must also be taken into account and consequently, the observation period indicated in Table A1-2 will be increased by an inverse frame filling factor.

Multipath condition:	Time per Wavelength:	Req. observation period:
TU1.5 ₃	<u>800 ms</u>	<u>400 ms</u> 800 s 400 s
TU50	24 ms	24 s
HT100	12 ms	12 s
RA130 ₂₅₀	<u>9.6 ms</u>	<u>5 ms</u> 9.6 s 5 s

Table A1-2: Required observation periods under multipath

A1.4.3.4. Low error ratios

The assumption that the system requirement P_s is sufficiently small holds generally. However, when reaching a high P_s , eg around $1.0 \text{ E-}1$, the approximation in (A1.3) is not strictly accurate. However, using the correct variance would decrease the needed number of samples, so the assumptions give conservative results.

A1.4.3.5. Total corrections

As a conclusion, the various limitations of the assumptions discussed in the above sections all lead to different increases of the needed number of samples to obtain the required confidence. The different increases must all be taken into account by taking the highest increase, and calculated number of samples are indicated in appendix 1. The overall confidence resulting is possibly slightly lower than 99.9% and 95.0%, but it should be quite close. Considering as well that the different tests are likely to be correlated, will make the overall probabilities of passing a "good" BSS and failing a "bad" BSS higher than indicated.

NOTE: The worst case in terms of test time it is the static sensitivity performance for the SACCH/T, giving 7.9 hours. On average, the test times are around ~~35.6~~ 45.0 min and range from 5.0 s.

A1.4.4. Alternative experimental methodology

The alternative experimental methodology indicated in this section could be used to verify, or possibly modify, the needed number of samples indicated in the previous sections. This would be most useful in the case of multipath propagation conditions where the statistics of the radio channel are very complicated and can not easily fit into simple formulae.

The approach is indicated in the following, and should be carried out once and for all for each multipath propagation condition, for each channel and for each type of error event according to section A1.4.5 to assess the needed number of samples. Then, it can be used ever after for any BSS.

1. Record the number of error events for N_p periods of N_s samples (events) under static propagation conditions for an average system requirement P_s and for a given type of error event on a given channel.
2. Estimate the error ratio $ER_i = M_i/N_s$ for each of the N_p periods.
3. Consider the average ER of all ER_i and estimate the expected value $E(ER)$ and the variance $Var(ER)$:

$$m = E(ER) = 1/N_p \sum_{i=1}^{N_p} ER_i \quad (A1.8a)$$

$$s^2 = Var(ER) = 1/N_p \sum_{i=1}^{N_p} ER_i^2 - m^2 \quad (A1.8b)$$

The test requirement P_t is found as follows:

$$P_t = P_s + G s \quad (A1.9a)$$

and

$$P_t = K P_s - B s \quad (A1.9b)$$

4. The test shall be repeated with a different number of samples N_s until the test requirement P_t differs with less than +/- 5% in (A1.9a) and (A1.9b).

The initial number of samples N_s should be as indicated in appendix 1 and the number of tests N_p should be 100.

The average system requirement P_s should be around $1.0 \text{ E-}2$. It can then be assumed that the needed number of samples N_s is inversely proportional to P_s .

A1.4.5. Detailed definition of error events

1) Frame Erasure Ratio (FER):

The frame is defined as erased if the error detection functions in accordance with GSM 05.03 indicate an error. For full-rate speech this is the result of a 3 bit Cyclic Redundancy Check (CRC), for signalling the result of the FIRE code or other block code used. For data traffic the FER is not defined.

NOTE: For full-rate speech it would ideally be better if the Bad Frame Indication (BFI) is used as frame erasure indication since this is what is directly related to the subjective quality of the perceived speech. For the moment no requirements relate to the BFI, however.

It is very difficult to assess what is subjectively the optimum combination of Frame Erasure Ratio (FER) and Residual Bit Error Ratio (RBER). This must therefore be avoided and it is essential that the BFI is optimized towards the ideal frame erasures independent of the processing to obtain it, and that the BFI is not biased towards $\text{BFI}=0$ or $\text{BFI}=1$.

2) Residual Bit Error Ratio (RBER):

The RBER is defined as the residual Bit Error Ratio (BER) in frames which have not been declared as erased.

3) Bit Error Ratio (BER):

The BER is the overall Bit Error Ratio (BER) independent of frame erasures or when erased frames are not defined.

A1.5. SHORTENED TEST PROCEDURES

Throughout this equipment specification the tests are described in such a way that each and every test should verify the relevant system requirement under all conditions of relevance to it. A limited effort has been made, however, to limit the testing to some extent. However, to fully characterize a BSS, it is necessary to carry out all the tests specified.

This section gives general guidance on how to limit the overall test time for all tests taking into account the relationship between the various system requirements themselves, and the relationship between the various system requirements concerning the various test parameters.

For tests not treated below, no specific guidance is given. However, intelligent sequencing of the tests can generally reduce test time. This sequencing has to some extent been carried out already.

A1.5.1. Radio Frequency (RF) tests

Most of the RF tests should be carried out under normal test conditions only.

Most RF tests should be carried out using frequencies B, M and T and with varying RF equipment until all the RF equipments in the configuration are tested. Generally, the testing of all the different RF equipments on the frequencies B, M and T could be distributed over all tests provided that an RF equipment is tested on all the 3 frequencies B, M and T some time during all tests. The number of RF equipments depends on the structure and the size of the BSS.

NOTE: If SFH is not supported by the BSS, the frequencies could be generated by a set of RF equipments which either all can dynamically be tuned to all TX frequencies, or which each have a fixed frequency during operation. In both cases all RF equipments must be tested on frequencies B, M and T.

If SFH is supported by the BSS, the testing depends on the TX frequency hopping scheme, whether the hopping is carried out on RF or on baseband. If baseband SFH is used, the BSS will consist of a set of RF equipments which will not change dynamically in frequency. In that case, all RF equipments must be tested on frequencies B, M and T. If RF SFH is used, each RF equipment will hop dynamically on B, M and T and only one test for each RF equipment is required.

Many of the receiver tests should be tested with a variety of multipath conditions for all logical channels. Provided the static reference sensitivity level is tested for all logical channels, testing of only one multipath condition per logical channel may be sufficient given that all multipath conditions are tested for some channels. This should at least verify the existence of appropriate equalization capabilities. For the reference interference level the same applies.

A1.6. DESCRIPTION OF SPECIAL TEST EQUIPMENT

A1.6.1. Base Station System Test Equipment (BSSTE)

The BSSTE is a functional tool for the purpose of acceptance testing of GSM Base Station Systems. The BSSTE functionally carries out all tests described in this equipment specification.

A1.6.2. Fading and multipath propagation simulator

A Multipath Fading Simulator (MFS) shall be included in the radio interface performance measurements to simulate realistic wideband multipath propagation over the mobile radio channel. The following set of standard multipath propagation conditions, as specified by COST 207 and described in GSM 05.05, shall be supported:

1. Typical Urban terrain (TU)
2. Rural terrain (RA)
3. Hilly terrain (HT)

In addition the MFS shall support a special multipath profile, designed to verify the equalization capabilities of the receiver:

4. Equalizer (EQU)

The multipath profiles shall all be simulated over a range of vehicle speeds from ~~3~~ 1.5 km/h to ~~250~~ 130 km/h. The speeds ~~3~~ 1.5, 50, 100 and ~~250~~ 130 km/h shall be used in particular.

The details of the multipath conditions and the corresponding requirements on the MFS itself are to be found in GSM 11.10 (Mobile Station Conformity Specification).

The MFS is functionally a part of the BSSTE as described in section A1.6.1 in this specification, but may physically be a separate piece of equipment.

A1.7. Measurement Set-Ups for TX-Intermodulation

The following test set-ups are examples for possible solutions for the measurements according to chap. 2.1.6.7 and 2.1.6.8. These measurements are very difficult to perform due to the extreme requirements of the dynamic range. To get reproducible measurements precautions must be taken, so that non-linearities in the test set-up do not influence the measurement results.

Note 1: Care must be exercised in creating the test set-up and good quality cables and connectors must be used. Cables should be physically secured and not disturbed unless necessary.

Note 2: Connectors shall be free of ferro-magnetic substances. Different surface materials on both connectors as well as the applied torque of the connection have an influence on the intermod-performance .

Note 3: Power attenuators normally have an insufficient intermod-performance at high power input levels. Therefore it is recommended to use long cables for attenuation where high power is applied.

A1.7.1. Test set-up for Intermodulation Attenuation (2.1.6.7.)

It is necessary to use different set-ups for the measurement of IM-products in the RX band and outside the RX band.

A1.7.1.1. RX-Band:

A recommended test set-up for the intermodulation attenuation in the receive band is illustrated in fig. A 1-2. A directional coupler is used with the measurement performed on the primary line connector. Sufficient filtering is provided by the duplexer so that the spectrum analyser operates in its linear range. The injected signal is amplified and filtered to provide sufficient isolation to inhibit self generated intermodulation products in the test set-up.

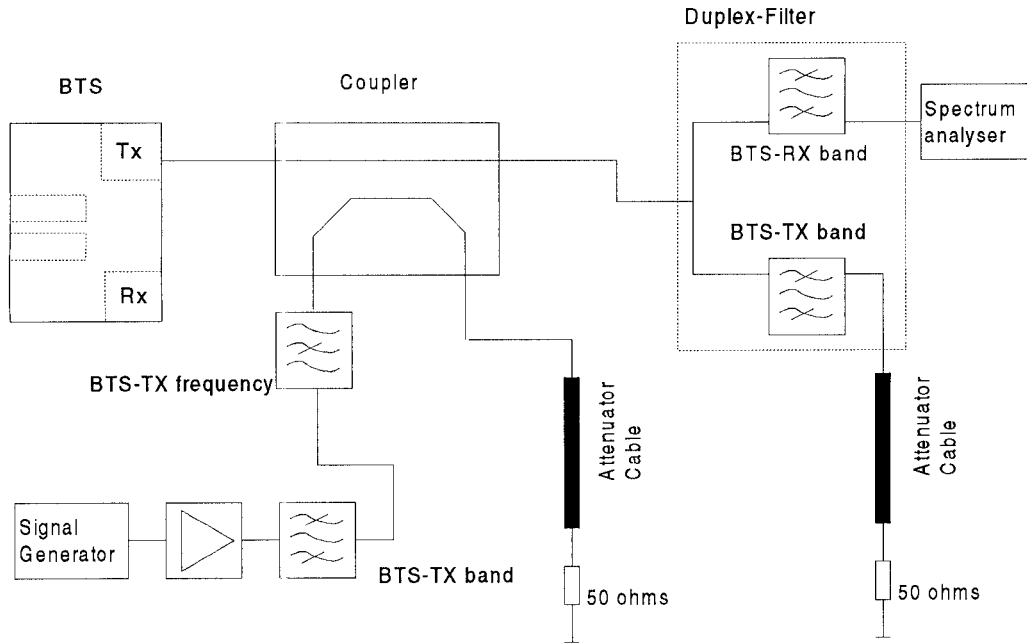

Fig A1-2: Test set-up for Intermodulation Attenuation (2.1.6.7.)
RX-Band

A1.7.1.2. Outside RX Band:

A recommended test set-up for the intermodulation attenuation outside the receive band is illustrated in fig. A 1-3. The coupling device shall be specified to operate over sufficient bandwidth to comply with the measurement requirements.

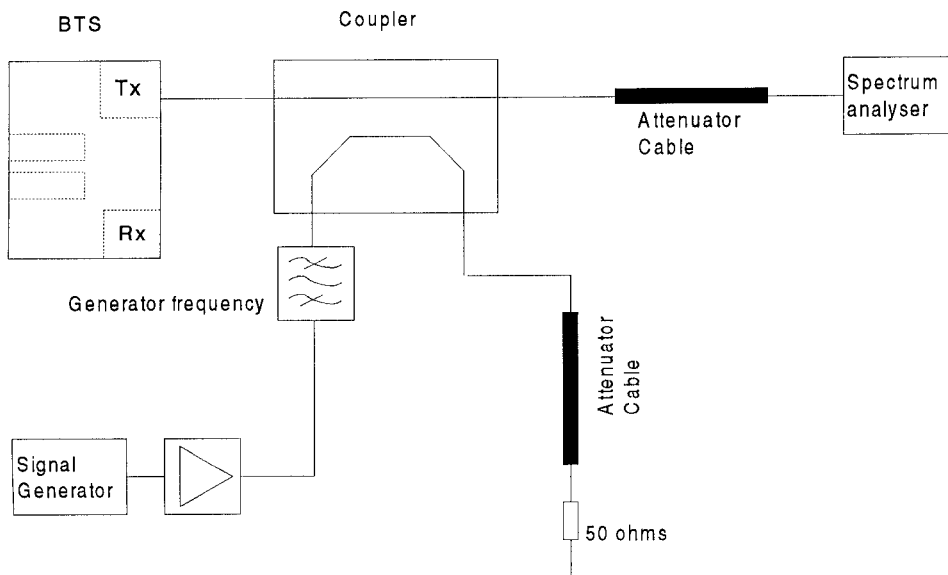

Fig A1-3: Test set-up for Intermodulation Attenuation (2.1.6.7.)
outside RX-Band

A1.7.2. Test set-up for Intra BSS Intermodulation Attenuation (2.1.6.8.)

It is necessary to use different set-ups for the measurement of IM-products in the RX band and in the TX band.

A1.7.2.1. RX-Band:

A recommended test set-up for the intra base station intermodulation attenuation in the receive band is illustrated in fig. A 1-4.

The stop band attenuation of the duplex filter has to be high enough to guarantee that the spectrum analyser is working in its linear range.

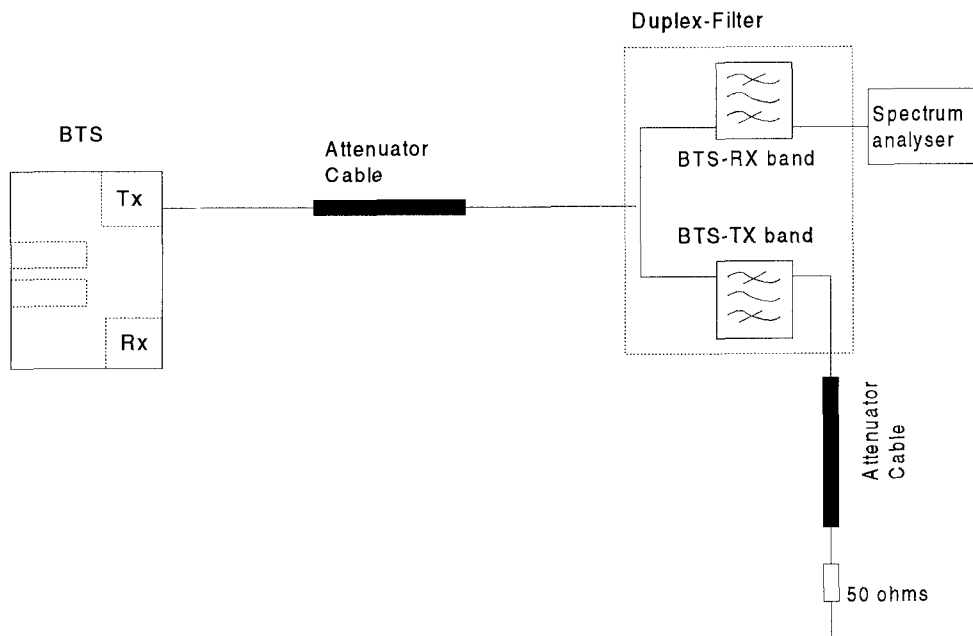

Fig A1-4: Test set-up for Intra Base station Intermodulation Attenuation (2.1.6.8.) RX-Band

A1.7.2.2. TX-Band:

A recommended test set-up for the intra base station intermodulation attenuation inside the transmit band is illustrated in fig. A 1-5. To decrease the dynamic range requirement of the spectrum analyser external filters should be used.

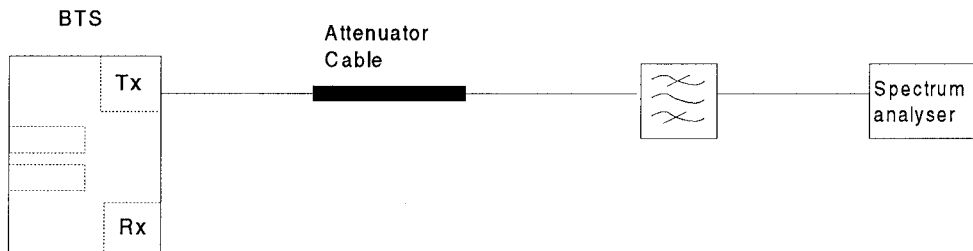

Fig A1-5: Test set-up for Intra Base station Intermodulation Attenuation (2.1.6.8.) TX-Band

APPENDIX 1. NUMBER OF SAMPLES NEEDED FOR STATISTICAL TESTING

=====

In the following, the needed number of samples and the resulting test time for ~~9596~~ different tests defined in section 2 are given based on the theoretical methodology outlined in section A1.4.3. The total test time for these tests amounts to around ~~56.472.0~~ hours, and the average time per test is ~~35.645~~ min.

It should be noted that time consuming tests like the test for blocking and spurious response rejection are not included.

APP1.1. CONTROL CHANNELS

SDCCH:

(FER: 4.25 events/s, frame filling = 4/51)

Prop. cond.:	Error rate:	Stat. sign.:	Indep. sampl.:	Station. proc.:	Samples:	Time: (s)
static	FER=0.10%	30 000	2		60 000	14 117.6
TU50	FER=10%	300	2	1 301	1 301	306.1
RA250	FER=8.0%	375	2	271	750	176.5
HT100	FER=9.0%	333	2	651	666	156.7
TU3	FER=22%	136	2	21 675	21 675	5 100.0
TU3 (SFH)	FER=4.0%	750	2	21 675	21 675	5 100.0
TU50	FER=10%	300	2	1 301	1 301	306.1
RA250	FER=8.0%	375	2	271	750	176.5
static	FER=0.10%	30 000	2	-	60 000	14 117.6
TU50	FER=8.0%	375	2	1 301	1 301	306.1
RA130	FER=8.0%	375	2	521	750	176.5
HT100	FER=8.0%	375	2	651	750	176.5
TU1.5	FER=22%	136	2	43 350	43 350	10 200.0
TU1.5 (SFH)	FER=9.0%	333	2	43 350	43 350	10 200.0
TU50	FER=8.0%	375	2	1 301	1 301	306.1
RA130	FER=8.0%	375	2	521	750	176.5

RACH:

(FER: 217 events/s, frame filling = 1)

Prop. cond.:	Error rate:	Stat. sign.:	Indep. sampl.:	Station. proc.:	Samples:	Time: (s)
static	FER=0.50%	6 000	2		12 000	55.3
TU50	FER=13%	231	2	5 208	5 208	24.0
RA250	FER=12%	250	2	1 085	1 085	5.0
HT100	FER=13%	231	2	2 604	2 604	12.0
TU3	FER=15%	200	2	86 800	86 800	400.0
TU3(SFH)	FER=15%	200	2	86 800	86 800	400.0
TU50	FER=16%	188	2	5 208	5 208	24.0
RA250	FER=13%	231	2	1 085	1 085	5.0
static	FER=0.50%	6 000	2	-	12 000	55.3
TU50	FER=13%	231	2	5 208	5 208	24.0
RA250	FER=12%	250	2	1 085	1 085	5.0
HT100	FER=13%	231	2	2 604	2 604	12.0
TU3	FER=15%	200	2	86 800	86 800	400.0
TU3(SFH)	FER=15%	200	2	86 800	86 800	400.0
TU50	FER=16%	188	2	5 208	5 208	24.0
RA250	FER=13%	231	2	1 085	1 085	5.0
static	FER=0.50%	6 000	2	-	12 000	55.3
TU50	FER=13%	231	2	5 208	5 208	24.0
RA130	FER=12%	250	2	2 087	2 087	10.0
HT100	FER=13%	231	2	2 604	2 604	12.0
TU1.5	FER=15%	200	2	173 600	173 600	800.0
TU1.5(SFH)	FER=15%	200	2	173 600	173 600	800.0
TU50	FER=16%	188	2	5 208	5 208	24.0
RA130	FER=13%	231	2	2 087	2 087	10.0

SACCH/T:

(FER: 2.1 events/s, frame filling = 1/26)

Prop. cond.:	Error rate:	Stat. sign.:	Indep. sampl.:	Station. proc.:	Samples:	Time: (s)
static	FER=0.10%	30 000	2		60 000	28 571.4
TU50	FER=10%	300	2	1 311	1 311	624.3
RA250	FER=8.0%	375	2	273	750	357.1
HT100	FER=9.0%	333	2	656	666	317.1
TU3	FER=22%	136	2	21 840	21 840	10 400.0
TU3(SFH)	FER=4.0%	750	2	21 840	21 840	10 400.0
TU50	FER=10%	300	2	1 311	1 311	624.3
RA250	FER=8.0%	375	2	273	750	357.1
static	FER=0.10%	30 000	2	-	60 000	28 571.4
TU50	FER=8.0%	375	2	1 311	1 311	624.3
RA130	FER=8.0%	375	2	525	750	357.1
HT100	FER=8.0%	375	2	656	750	357.1
TU1.5	FER=22%	136	2	43 680	43 680	20 800.0
TU1.5(SFH)	FER=9.0%	333	2	43 680	43 680	20 800.0
TU50	FER=8.0%	375	2	1 311	1 311	624.3
RA130	FER=8.0%	375	2	525	750	357.1

SACCH/C:

(FER: 2.13 events/s, frame filling = 4/102)

Prop. cond.:	Error rate:	Stat. sign.:	Indep. sampl.:	Station. proc.:	Samples:	Time: (s)
static	FER=0.10%	30 000	2		60 000	28 169.0
TU50	FER=10%	300	2	1 304	1 304	612.2
RA250	FER=8.0%	375	2	272	750	352.1
HT100	FER=9.0%	333	2	652	666	312.7
TU3	FER=22%	136	2	21 726	21 726	10 200.0
TU3(SFH)	FER=4.0%	750	2	21 726	21 726	10 200.0
TU50	FER=10%	300	2	1 304	1 304	612.2
RA250	FER=8.0%	375	2	272	750	352.1
static	FER=0.10%	30 000	2	-	60 000	28 169.0
TU50	FER=8.0%	375	2	1 304	1 304	612.2
RA130	FER=8.0%	375	2	523	750	352.1
HT100	FER=8.0%	375	2	652	750	352.1
TU1.5	FER=22%	136	2	43 452	43 452	20 400.0
TU1.5(SFH)	FER=9.0%	333	2	43 452	43 452	20 400.0
TU50	FER=8.0%	375	2	1 304	1 304	612.2
RA130	FER=8.0%	375	2	523	750	352.1

FACCH/F:

(FER: 50 events/s, frame filling = 24/26)

Prop. cond.:	Error rate:	Stat. sign.:	Indep. sampl.:	Station. proc.:	Samples:	Time: (s)
static	FER=0.10%	30 000	4		120 000	2 400.0
TU50	FER=10%	300	4	1 300	1 300	26.0
RA250	FER=8.0%	375	4	271	1 500	30.0
HT100	FER=9.0%	333	4	650	1 333	26.7
TU3	FER=22%	136	4	21 667	21 667	433.3
TU3(SFH)	FER=4.0%	750	4	21 667	21 667	433.3
TU50	FER=10%	300	4	1 300	1 300	26.0
RA250	FER=8.0%	375	4	271	1 500	30.0
static	FER=0.10%	30 000	4	-	120 000	2 400.0
TU50	FER=8.0%	375	4	1 300	1 500	30.0
RA130	FER=8.0%	375	4	521	1 500	30.0
HT100	FER=8.0%	375	4	650	1 500	30.0
TU1.5	FER=22%	136	4	43 334	43 334	866.7
TU1.5(SFH)	FER=9.0%	333	4	43 334	43 334	866.7
TU50	FER=8.0%	375	4	1 300	1 500	30.0
RA130	FER=8.0%	375	4	521	1 500	30.0

FACCH/H:

(FER: 25 events/s, frame filling = 12/26)

Prop. cond.:	Error rate:	Stat. sign.:	Indep. sampl.:	Station. proc.:	Samples:	Time: (s)
static	FER=0.10%	30 000	4		120 000	4 800.0
TU50	FER=10%	300	4	1 300	1 300	52.0
RA250	FER=8.0%	375	4	271	1 500	60.0
HT100	FER=9.0%	333	4	650	1 333	53.3
TU3	FER=22%	136	4	21 667	21 667	866.7
TU3 (SFH)	FER=4.0%	750	4	21 667	21 667	866.7
TU50	FER=10%	300	4	1 300	1 300	52.0
RA250	FER=8.0%	375	4	271	1 500	60.0
static	FER=0.10%	30 000	4	-	120 000	4 800.0
TU50	FER=8.0%	375	4	1 300	1 500	60.0
RA130	FER=8.0%	375	4	521	1 500	60.0
HT100	FER=8.0%	375	4	650	1 500	60.0
TU1.5	FER=22%	136	4	43 334	43 334	1733.4
TU1.5 (SFH)	FER=9.0%	333	4	43 334	43 334	1733.4
TU50	FER=8.0%	375	4	1 300	1 500	60.0
RA130	FER=8.0%	375	4	521	1 500	60.0

BCCH/AGCH/PCH/SCH:

Not applicable to the BSS !

APP1.2. DATA TRAFFIC CHANNELS

TCH/F9.6:

(BER: 12000 events/s, frame filling = 24/26)

Prop. cond.:	Error rate:	Stat. sign.:	Indep. sampl.:	Station. proc.:	Samples:	Time: (s)
static	BER=1.0E-5	3000 000	10	-	30000 000	2 500.0
TU50	BER=0.50%	6 000	10	312 000	312 000	26.0
RA250	BER=0.10%	30 000	10	65 000	300 000	25.0
HT100	BER=0.70%	4 286	10	156 000	156 000	13.0
TU3	BER=8.0%	375	10	5200 000	5200 000	433.3
TU3(SFH)	BER=0.30%	10 000	10	5200 000	5200 000	433.3
TU50	BER=0.30%	10 000	10	312 000	312 000	26.0
RA250	BER=0.20%	15 000	10	65 000	150 000	12.5
static	BER=1.0E-5	3000 000	10	-	30000 000	2 500.0
TU50	BER=0.40%	7 500	10	312 000	312 000	26.0
RA130	BER=0.10%	30 000	10	125 000	300 000	25.0
HT100	BER=0.70%	4 286	10	156 000	156 000	13.0
TU1.5	BER=8.0%	375	10	10400 000	10400 000	866.7
TU1.5(SFH)	BER=0.30%	10 000	10	10400 000	10400 000	866.7
TU50	BER=0.80%	3750	10	312 000	312 000	26.0
RA130	BER=0.20%	15 000	10	125 000	150 000	12.5

TCH/H4.8:

(BER: 6000 events/s, frame filling = 12/26)

Prop. cond.:	Error rate:	Stat. sign.:	Indep. sampl.:	Station. proc.:	Samples:	Time: (s)
static	BER=1.0E-5	3000 000	10	-	30000 000	5 000.0
TU50	BER=0.50%	6 000	10	312 000	312 000	52.0
RA250	BER=0.10%	30 000	10	65 000	300 000	50.0
HT100	BER=0.70%	4 286	10	156 000	156 000	26.0
TU3	BER=8.0%	375	10	5200 000	5200 000	866.7
TU3(SFH)	BER=0.30%	10 000	10	5200 000	5200 000	866.7
TU50	BER=0.30%	10 000	10	312 000	312 000	52.0
RA250	BER=0.20%	15 000	10	65 000	150 000	25.0
static	BER=1.0E-5	3000 000	10	-	30000 000	5 000.0
TU50	BER=0.40%	7 500	10	312 000	312 000	52.0
RA130	BER=0.10%	30 000	10	125 000	300 000	50.0
HT100	BER=0.70%	4 286	10	156 000	156 000	26.0
TU1.5	BER=8.0%	375	10	10400 000	10400 000	1733.4
TU1.5(SFH)	BER=0.30%	10 000	10	10400 000	10400 000	1733.4
TU50	BER=0.80%	3750	10	312 000	312 000	52.0
RA130	BER=0.20%	15 000	10	125 000	150 000	25.0

TCH/F4.8:

(BER: 6000 events/s, frame filling = 24/26)

Prop. cond.:	Error rate:	Stat. sign.:	Indep. sampl.:	Station. proc.:	Samples:	Time: (s)
TU50	BER=1.0E-4	300 000	10	156 000	3000 000	500.0
RA250	BER=1.0E-4	300 000	10	32 500	3000 000	500.0
HT100	BER=1.0E-4	300 000	10	78 000	3000 000	500.0
TU3	BER=3.0%	1 000	10	2600 000	2600 000	433.3
TU3 (SFH)	BER=1.0E-4	300 000	10	2600 000	3000 000	500.0
TU50	BER=1.0E-4	300 000	10	156 000	3000 000	500.0
RA250	BER=1.0E-4	300 000	10	32 500	3000 000	500.0
TU50	BER=1.0E-4	300 000	10	156 000	3000 000	500.0
RA130	BER=1.0E-4	300 000	10	62 500	3000 000	500.0
HT100	BER=1.0E-4	300 000	10	78 000	3000 000	500.0
TU1.5	BER=3.0%	1 000	10	5200 000	5200 000	866.7
TU1.5 (SFH)	BER=1.0E-4	300 000	10	5200 000	5200 000	866.7
TU50	BER=1.0E-4	300 000	10	156 000	3000 000	500.0
RA130	BER=1.0E-4	300 000	10	62 500	3000 000	500.0

TCH/F2.4:

(BER: 3600 events/s, frame filling = 24/26)

Prop. cond.:	Error rate:	Stat. sign.:	Indep. sampl.:	Station. proc.:	Samples:	Time: (s)
TU50	BER=2.0E-5	1500 000	10	93 600	15000 000	4 166.7
RA250	BER=1.0E-5	3000 000	10	3 900	30000 000	8 333.3
HT100	BER=1.0E-5	3000 000	10	46 800	30000 000	8 333.3
TU3	BER=3.0%	1 000	10	1560 000	1560 000	433.3
TU3 (SFH)	BER=1.0E-5	3000 000	10	1560 000	30000 000	8 333.3
TU50	BER=3.0E-5	1000 000	10	93 600	10000 000	2 777.8
RA250	BER=1.0E-5	3000 000	10	3 900	30000 000	8 333.3
TU50	BER=1.0E-4	300 000	10	93 600	3000 000	8 33.3
RA130	BER=1.0E-5	3000 000	10	7 500	30000 000	8 333.3
HT100	BER=1.0E-5	3000 000	10	46 800	30000 000	8 333.3
TU1.5	BER=3.0%	1 000	10	3120 000	3120 000	866.7
TU1.5 (SFH)	BER=1.0E-5	3000 000	10	3120 000	30000 000	8 333.3
TU50	BER=1.0E-5	3000 000	10	93 600	30000 000	8 333.3
RA130	BER=1.0E-5	3000 000	10	7 500	30000 000	8 333.3

TCH/H2.4:

(BER: 3600 events/s, frame filling = 12/26)

Prop. cond.:	Error rate:	Stat. sign.:	Indep. sampl.:	Station. proc.:	Samples:	Time: (s)
TU50	BER=2.0E-4	150 000	10	187 200	1500 000	416.7
RA250	BER=1.0E-4	300 000	10	39 000	3000 000	833.3
HT100	BER=1.0E-4	300 000	10	93 600	3000 000	833.3
TU3	BER=4.0%	750	10	3120 000	3120 000	866.7
TU3 (SFH)	BER=1.0E-4	300 000	10	3120 000	3120 000	866.7
TU50	BER=2.0E-4	150 000	10	187 200	1500 000	416.7
RA250	BER=1.0E-4	300 000	10	39 000	3000 000	833.3
TU50	BER=1.0E-4	300 000	10	187 200	3000 000	833.3
RA130	BER=1.0E-4	300 000	10	75 000	3000 000	833.3
HT100	BER=1.0E-4	300 000	10	93 600	3000 000	833.3
TU1.5	BER=4.0%	750	10	6240 000	6240 000	1733.4
TU1.5 (SFH)	BER=1.0E-4	300 000	10	6240 000	6240 000	1733.4
TU50	BER=1.0E-4	300 000	10	187 200	3000 000	833.3
RA130	BER=1.0E-4	300 000	10	75 000	3000 000	833.3

APP1.3. SPEECH TRAFFIC CHANNELS

TCH/FS:

(FER: 50 events/s, RBER class Ib: 6600 events/s,
RBER class II: 3900 events/s, frame filling = 24/26)

Prop. cond.:	Error rate:	Stat. sign.:	Indep. sampl.:	Station. proc.:	Samples:	Time: (s)
static	FER=0.10%	30 000	4		120 000	2 400.0
	Ib RBER=0.40%	7 500	10		75 000	11.4
	II RBER=2.0%	1 500	10		15 000	3.8
TU50	FER=6.0%	500	4	1 300	2 000	40.0
	Ib RBER=0.40%	7 500	10	171 600	171 600	26.0
	II RBER=8.0%	375	10	101 400	101 400	26.0
RA250	FER=2.0%	1 500	4	271	6 000	120.0
	Ib RBER=0.20%	15 000	10	35 750	150 000	22.7
	II RBER=7.0%	429	10	21 125	21 125	5.4
HT100	FER=7.0%	429	4	650	1 716	34.3
	Ib RBER=0.50%	6 000	10	85 800	85 800	13.0
	II RBER=9.0%	333	10	50 700	50 700	13.0
TU3	FER=21%	143	4	21 667	21 667	433.3
	Ib RBER=2.0%	1 500	10	2860 000	2860 000	433.3
	II RBER=4.0%	750	10	1690 000	1690 000	433.3
TU3 (SFH)	FER=3.0%	1 000	4	21 667	21 667	433.3
	Ib RBER=0.20%	15 000	10	2860 000	2860 000	433.3
	II RBER=8.0%	375	10	1690 000	1690 000	433.3
TU50	FER=6.0%	500	4	1 300	2 000	40.0
	Ib RBER=0.40%	7 500	10	171 600	171 600	26.0
	II RBER=8.0%	375	10	101 400	101 400	26.0
RA250	FER=3.0%	1 000	4	271	4 000	80.0
	Ib RBER=0.20%	15 000	10	35 750	150 000	22.7
	II RBER=8.0%	375	10	21 125	21 125	5.4
static	II RBER=1.0E 4	300 000	10		3000 000	769.2
EQU50	II RBER=3.0%	1 000	10	101 400	101 400	26.0

static	FER=0.10%	30 000	4	-	120 000	2 400.0
	Ib RBER=0.40%	7 500	10	-	75 000	11.4
	II RBER=2.0%	1 500	10	-	15 000	3.8
TU50	FER=4.0%	750	4	1 300	3 000	60.1
	Ib RBER=0.30%	10 000	10	171 600	171 600	26.0
	II RBER=8.0%	375	10	101 400	101 400	26.0
RA130	FER=2.0%	1 500	4	521	6 000	120.0
	Ib RBER=0.20%	15 000	10	68 750	150 000	22.7
	II RBER=7.0%	429	10	40 625	40 625	10.4
HT100	FER=7.0%	429	4	650	1 716	34.3
	Ib RBER=0.50%	6 000	10	85 800	85 800	13.0
	II RBER=9.0%	333	10	50 700	50 700	13.0

TU1.5	FER=21%	143	4	43 334	43 334	866.7
	Ib RBER=2.0%	1 500	10	5720 000	5720 000	866.7
	II RBER=4.0%	750	10	3380 000	3380 000	866.7
TU1.5(SFH)	FER=3.0%	1 000	4	43 334	43 334	866.7
	Ib RBER=0.20%	15 000	10	5720 000	5720 000	866.7
	II RBER=8.0%	375	10	3380 000	3380 000	866.7
TU50	FER=3.0%	1 000	4	1 300	4 000	80.0
	Ib RBER=0.25%	12 000	10	171 600	171 600	26.0
	II RBER=8.1%	370	10	101 400	101 400	26.0
RA130	FER=3.0%	1 000	4	521	4 000	80.0
	Ib RBER=0.20%	15 000	10	71 500	150 000	22.7
	II RBER=8.0%	375	10	42 250	42 250	10.8

static	II RBER=1.0E-4	300 000	10	-	3000 000	769.2
static	II RBER=5.0E-3	6 000	10	-	60 000	15.4
EQU50	II RBER=3.0%	1 000	10	101 400	101 400	26.0

TCH/HS:

For further study !