



GSM TECHNICAL SPECIFICATION

GSM 03.40

December 1995

Version 5.0.0

Source: ETSI TC-SMG

Reference: TS/SMG-040340Q

ICS: 33.060.50

Key words: Digital cellular telecommunications system, Global System for Mobile communications (GSM)



Digital cellular telecommunications system (Phase 2+); Technical realization of the Short Message Service (SMS) Point-to-Point (PP) (GSM 03.40)

ETSI

European Telecommunications Standards Institute

ETSI Secretariat

Postal address: F-06921 Sophia Antipolis CEDEX - FRANCE

Office address: 650 Route des Lucioles - Sophia Antipolis - Valbonne - FRANCE

X.400: c=fr, a=atlas, p=etsi, s=secretariat - **Internet:** secretariat@etsi.fr

Tel.: +33 92 94 42 00 - Fax: +33 93 65 47 16

Copyright Notification: No part may be reproduced except as authorized by written permission. The copyright and the foregoing restriction extend to reproduction in all media.

© European Telecommunications Standards Institute 1995. All rights reserved.

Contents

Foreword	7
Introduction	7
1 Scope	9
2 Normative references	9
2.1 Definitions and abbreviations	10
2.1.1 Definitions	11
2.2.2 Abbreviations	13
3 Services and service elements	13
3.1 Basic services	14
3.2 Short Message Service elements	15
3.2.1 Validity-Period	15
3.2.2 Service-Centre-Time-Stamp	15
3.2.3 Protocol-Identifier	15
3.2.4 More-Messages-to-Send	15
3.2.5 Delivery of Priority and non-Priority Messages	16
3.2.6 Messages-Waiting	16
3.2.7 Alert-SC	18
3.2.8 Options concerning MNRF, MCEF and MWD	18
3.2.9 Status report capabilities	19
3.2.10 Reply Path	19
3.3 Unsuccessful short message TPDU transfer SC -> MS	20
3.3.1 Errors occurring during transfer of TPDU to MS	20
3.3.2 Errors occurring after TPDU arrives at MS	20
3.4 Unsuccessful short message TPDU transfer MS -> SC	22
3.4.1 Errors occurring during transfer of TPDU to SC	22
3.4.2 Errors occurring after TPDU arrives at SC	22
3.5 Use of Supplementary Services in combination with the Short Message Service	22
3.6 Applicability of Operator Determined Barring to the Short Message Service	22
3.7 Multiple short message transfer	22
4 Network architecture	23
4.1 Basic network structure	23
4.2 Transfer on link 3	24
5 Service Centre and PLMN interconnection	24
5.1 Service centre connection	24
5.2 Routing requirements	24
5.2.1 Mobile terminated short message	24
5.2.2 Mobile originated short message	24
6 Service Centre functionality	25
6.1 Service Centre capabilities	25
6.2 SC functional requirements	25
7 MS functionality	26
7.1 MS capabilities	26
7.2 MS configuration	26
8 MSC functionality	27
8.1 MSC functionality related to SM MT	27

8.1.1	Functionality of the SMS-GMSC	27
8.1.2	Functionality of the MSC	28
8.2	MSC functionality related to SM MO	28
8.2.1	Functionality of the MSC	28
8.2.2	Functionality of the SMS-IWMSC	29
8.3	SMS-IWMSC functionality related to alerting	29
9	Protocols and protocol architecture	30
9.1	Protocol element features	30
9.1.1	Octet and Bit transmission order	30
9.1.2	Numeric and alphanumeric representation	30
9.1.2.1	Integer representation	30
9.1.2.2	Octet representation	31
9.1.2.3	Semi-octet representation	31
9.1.2.4	Alphanumeric representation	32
9.1.2.5	Address fields	32
9.2	Service provided by the SM-TL	34
9.2.1	General	34
9.2.2	PDU Type repertoire at SM-TL	34
9.2.2.1	SMS-DELIVER type	35
9.2.2.1a	SMS-DELIVER-REPORT type	37
9.2.2.2	SMS-SUBMIT type	38
9.2.2.2a	SMS-SUBMIT-REPORT type	40
9.2.2.3	SMS-STATUS-REPORT type	41
9.2.2.4	SMS-COMMAND type	43
9.2.3	Definition of the TPDU parameters	44
9.2.3.1	TP-Message-Type-Indicator (TP-MTI)	44
9.2.3.2	TP-More-Messages-to-Send (TP-MMS)	44
9.2.3.3	TP-Validity-Period-Format (TP-VPF)	44
9.2.3.4	TP-Status-Report-Indication (TP-SRI)	44
9.2.3.5	TP-Status-Report-Request (TP-SRR)	45
9.2.3.6	TP-Message-Reference (TP-MR)	45
9.2.3.7	TP-Originating-Address (TP-OA)	45
9.2.3.8	TP-Destination-Address (TP-DA)	45
9.2.3.9	TP-Protocol-Identifier (TP-PID)	45
9.2.3.10	TP-Data-Coding-Scheme (TP-DCS)	47
9.2.3.11	TP-Service-Centre-Time-Stamp (TP-SCTS)	47
9.2.3.12	TP-Validity-Period	48
9.2.3.13	TP-Discharge-Time (TP-DT)	48
9.2.3.14	TP-Recipient-Address (TP-RA)	48
9.2.3.15	TP-Status (TP-ST)	48
9.2.3.16	TP-User-Data-Length (TP-UDL)	50
9.2.3.17	TP-Reply-Path (TP-RP)	50
9.2.3.18	TP-Message-Number (TP-MN)	50
9.2.3.19	TP-Command-Type (TP-CT)	50
9.2.3.20	TP-Command-Data-Length (TP-CDL)	51
9.2.3.21	TP-Command-Data (TP-CD)	51
9.2.3.22	TP-Failure-Cause (TP-FCS)	52
9.2.3.23	TP-User-Data-Header-Indicator (TP-UDHI)	53
9.2.3.24	TP-User Data (TP-UD)	53
9.2.3.24.1	Concatenated Short Messages	54
9.2.3.24.2	Special SMS Message Indication	55
9.2.3.25	TP-Reject-Duplicates (TP-RD)	56
9.2.3.26	TP-Status-Report-Qualifier (TP-SRQ)	56
9.3	Service provided by the SM-RL	57
9.3.1	General	57
9.3.2	Protocol element repertoire at SM-RL	57
9.3.2.1	RP-MO-DATA	57
9.3.2.2	RP-MT-DATA	58
9.3.2.3	RP-ACK	58

9.3.2.4	RP-ERROR.....	58
9.3.2.5	RP-ALERT-SC	59
9.3.2.6	RP-SM-MEMORY-AVAILABLE	59
10	Fundamental procedures within the point-to-point SMS.....	60
10.1	Short message mobile terminated	60
10.2	Short message mobile originated.....	69
10.3	Alert transfer	73
11	Mapping of error causes between RP layers	76
11.1	Mobile Terminated short message transfer	76
11.2	Memory available notification	76
11.3	Mobile Originated short message transfer.....	77
Annex A (Informative):	Protocol stacks for interconnecting SCs and MSCs	78
Annex B (Informative):	Information now contained in GSM 03.38.....	79
Annex C (Informative):	Short message information flow	80
Annex D (Informative):	Mobile Station reply procedures.....	97
D.1	Introduction.....	97
D.2	The scope of applicability.....	97
D.3	Terminology.....	97
D.4	The reply path requesting procedure.....	98
D.5	The reception of an original MT SM	98
D.6	The submission of the reply MO SM	98
D.7	Usage of SCs for replying	99
D.8	Replying possibilities for phase 1 mobile stations	99
D.9	The resulting service for originating SMEs	99
History	100

Blank page

Foreword

This Global System for Mobile communications Technical Specification (GTS) has been produced by the Special Mobile Group (SMG) Technical Committee (TC) of the European Telecommunications Standards Institute (ETSI).

This GTS describes the point-to-point Short Message Service (SMS) of the digital cellular telecommunications system (Phase 2/Phase 2+).

This GTS is a TC-SMG approved GSM technical specification version 5, which contains GSM Phase 2+ enhancements/features to the version 4 GSM technical specification. The European Telecommunications Standard from which this Phase 2+ GTS has evolved is Phase 2 GSM ETS 300 536 edition 3 (GSM 03.40 version 4.12.0).

GTS are produced by TC-SMG to enable the GSM Phase 2 + specifications to become publicly available, prior to submission for the formal ETSI standards approval procedure to become European Telecommunications Standards (ETS). This ensures the earliest possible access to GSM Phase 2+ specifications for all Manufacturers, Network operators and implementors of the Global System for Mobile communications.

The contents of this GTS are subject to continuing work within TC-SMG and may change following formal TC-SMG approval. Should TC-SMG modify the contents of this GTS it will then be republished by ETSI with an identifying change of release date and an increase in version number as follows:

Version 5.x.y

where:

- y the third digit is incremented when editorial only changes have been incorporated in the specification;
- x the second digit is incremented for all other types of changes, i.e. technical enhancements, corrections, updates, etc.

NOTE: TC-SMG has produced documents which give the technical specifications for the implementation of the digital cellular telecommunications system. Historically, these documents have been identified as GSM Technical Specifications (GSM-TSs). These TSs may have subsequently become I-ETTs (Phase 1), or ETs/ETSI Technical Reports (ETRs) (Phase 2). TC-SMG has also produced ETSI GSM TSs which give the technical specifications for the implementation of Phase 2+ enhancements of the digital cellular telecommunications system. These version 5.x.x GSM Technical Specifications may be referred to as GTs.

Introduction

The Point-to-Point Short Message Service (SMS) provides a means of sending messages of limited size to and from GSM mobiles. The provision of SMS makes use of a Service Centre, which acts as a store and forward centre for short messages. Thus a GSM PLMN needs to support the transfer of short messages between Service Centres and mobiles.

Two different point-to-point services have been defined: mobile originated and mobile terminated. Mobile originated messages will be transported from an MS to a Service Centre. These may be destined for other mobile users, or for subscribers on a fixed network. Mobile terminated messages will be transported from a Service Centre to an MS. These may be input to the Service Centre by other mobile users (via a mobile originated short message) or by a variety of other sources, e.g. speech, telex, or facsimile.

Blank page

1 Scope

This Global System for Mobile communications Technical Specification (GTS) describes the point-to-point Short Message Service (SMS) of the GSM PLMN system. It defines:

- the services and service elements;
- the network architecture;
- the Service Centre functionality;
- the MSC functionality (with regard to the SMS);
- the routing requirements,
- the protocols and protocol layering;

for the Teleservices 21 and 22, as specified in the GSM 02.03 (ETS 300 502).

The use of radio resources for the transfer of short messages between the MS and the MSC is described in GSM 04.11 (ETS 300 559) "Point-to-Point Short Message Service Support on Mobile Radio Interface", and is dealt with in that specification.

The network aspects of Short Message Service provision are outside the scope of this specification (i.e. the provision of network connectivity between the PLMN subsystems). The required and assumed network service offered to the higher layers is defined in this specification.

The Cell Broadcast Short Message Service (Teleservice 23) is a separate service, and is described in GSM 03.41 (ETS 300 537) 'Technical Realization of the Short Message Service - Cell Broadcast'.

2 Normative references

This GTS incorporates by dated and undated references, provisions from other publications. These normative references are cited at the appropriate places in the text and the publications are listed hereafter. For dated references, subsequent amendments to or revisions of any of these publications apply to this GTS only when incorporated in it by amendment or revision. For undated references, the latest edition of the publication referred to applies.

- | | |
|-----|---|
| [1] | GSM 01.04 (ETR 100): "European digital cellular telecommunication system (Phase 2); Abbreviations and acronyms". |
| [2] | GSM 02.03 (ETS 300 502): "European digital cellular telecommunication system (Phase 2); Teleservices supported by a GSM Public Land Mobile Network (PLMN)". |
| [3] | GSM 02.04 (ETS 300 503): "European digital cellular telecommunication system (Phase 2); General on supplementary services". |
| [4] | GSM 02.41 (ETS 300 513): "European digital cellular telecommunication system (Phase 2); Operator determined barring". |
| [5] | GSM 03.02 (ETS 300 522): "European digital cellular telecommunication system (Phase 2); Network architecture". |
| [6] | GSM 03.08 (ETS 300 526): "European digital cellular telecommunication system (Phase 2); Organisation of subscriber data". |
| [7] | GSM 03.11 (ETS 300 529): "European digital cellular telecommunication system (Phase 2); Technical realization of supplementary services". |
| [8] | GSM 03.15 (ETS 300 533): "European digital cellular telecommunication system (Phase 2); Technical realization of operator determined barring". |
| [9] | GSM 03.38 (ETS 300 628): "European digital cellular telecommunication system (Phase 2); Alphabets and language-specific information". |

- [10] GSM 03.41 (ETS 300 537): "European digital cellular telecommunication system (Phase 2); Technical realization of Short Message Service Cell Broadcast (SMSCB)".
- [11] GSM 03.47 (ETR 106): "European digital cellular telecommunication system (Phase 2); Example protocol stacks for interconnecting Service Centre(s) (SC) and Mobile-services Switching Centre(s) (MSC)".
- [12] GSM 04.08 (ETS 300 557): "European digital cellular telecommunication system (Phase 2); Mobile radio interface layer 3 specification".
- [13] GSM 04.11 (ETS 300 559): "European digital cellular telecommunication system (Phase 2); Point-to-Point (PP) Short Message Service (SMS) support on mobile radio interface".
- [14] GSM 07.05 (ETS 300 585): "European digital cellular telecommunication system (Phase 2); Use of Data Terminal Equipment - Data Circuit terminating Equipment (DTE - DCE) interface for Short Message Service (SMS) and Cell Broadcast Service (CBS)".
- [15] GSM 09.02 (ETS 300 599): "European digital cellular telecommunication system (Phase 2); Mobile Application Part (MAP) specification".
- [16] GSM 11.11 (ETS 300 608): "European digital cellular telecommunication system (Phase 2); Specification of the Subscriber Identity Module - Mobile Equipment (SIM - ME) interface".
- [17] CCITT Recommendation E.164 (Blue Book): "Numbering plan for the ISDN era".
- [18] CCITT Recommendation E.163 (Blue Book): "Numbering plan for the international telephone service".
- [19] CCITT Recommendation Q.771: "Specifications of Signalling System No.7; Functional description of transaction capabilities".
- [20] CCITT Recommendation T.100 (Blue Book): "International information exchange for interactive videotex".
- [21] CCITT Recommendation T.101 (Blue Book): "International interworking for videotex services".
- [22] CCITT Recommendation X.121 (Blue Book): "International numbering plan for public data networks".
- [23] CCITT Recommendation X.400 (Blue Book): "Message handling system and service overview".

2.1 Definitions and abbreviations

NOTE: Use of hyphens and full stops:

Care is needed when reading this specification as names containing words separated by hyphens have different meaning than when separated with full stops. E.g. TS-Status-Report-Request is a parameter within a TS-Submit primitive, whilst TS-Status-Report. Request is a primitive in its own right.

2.1.1 Definitions

active MS: A switched-on mobile station with a SIM module attached.

alert-SC: Service element provided by a GSM PLMN to inform an SC which has previously initiated unsuccessful short message delivery attempt(s) to a specific MS, that the MS is now recognized by the PLMN to have recovered operation.

status report: SC informing the originating MS of the outcome of a short message submitted to an SME.

Gateway MSC For Short Message Service (SMS-GMSC): A function of an MSC capable of receiving a short message from an SC, interrogating an HLR for routing information and SMS info, and delivering the short message to the VMSC of the recipient MS.

Interworking MSC For Short Message Service (SMS-IW MSC): A function of an MSC capable of receiving a short message from within the PLMN and submitting it to the recipient SC.

Messages-Waiting (MW): Service element that makes a PLMN store information (Messages-Waiting-Indication), listing those SCs that have made unsuccessful short message delivery attempts to MSs in that PLMN.

Messages-Waiting-Indication (MWI): Data to be stored in the HLR and VLR with which an MS is associated, indicating that there is one or more messages waiting in a set of SCs to be delivered to the MS (due to unsuccessful delivery attempt(s)).

Messages-Waiting-Data (MWD): A part of the MWI to be stored in the HLR. MWD consists of an address list of the SCs which have messages waiting to be delivered to the MS.

Mobile-Station-Memory-Capacity-Exceeded-Flag (MCEF): A part of the MWI to be stored in the HLR. MCEF is a boolean parameter indicating if the address list of MWD contains one or more entries because an attempt to deliver a short message to an MS has failed with a cause of MS Memory Capacity Exceeded.

Mobile-Station-Not-Reachable-Flag (MNRF): The part of the MWI to be stored in the VLR and the HLR. MNRF is a boolean parameter indicating if the address list of MWD contains one or more entries because an attempt to deliver a short message to an MS has failed with a cause of Absent Subscriber.

More-Messages-To-Send (MMS): Information element offering an MS receiving a short message from an SC the information whether there are still more messages waiting to be sent from that SC to the MS.

priority: Service element enabling the SC or SME to request a short message delivery attempt to an MS irrespective of whether or not the MS has been identified as temporarily absent.

protocol-identifier: Information element by which the originator of a short message (either an SC or an MS) may refer to a higher layer protocol.

reply path procedure: A mechanism which allows an SME to request that an SC should be permitted to handle a reply sent in response to a message previously sent from that SME to another SME. This may happen even though the SC may be unknown to the SME which received the initial message.

report: Response from either the network or the recipient upon a short message being sent from either an SC or an MS. A report may be a delivery report, which confirms the delivery of the short message to the recipient, or it may be a failure report, which informs the originator that the short message was never delivered and the reason why.

When issued by the Service Centre, the delivery report confirms the reception of the Short Message by the SC, and not the delivery of the Short Message to the SME.

When issued by the Mobile Station, the delivery report confirms the reception of the Short Message by the Mobile Station, and not the delivery of the Short Message to the user.

replace short message type: A range of values in the Protocol Identifier which allows an indication to be sent with a short message (MT or MO) that the short message is of a particular type allowing the receiving MS or the SC to replace an existing message of the same type held in the SC, the ME or on the SIM, provided it comes:

- in MT cases: from the same SC and originating address;
- in MO cases: from the same MS.

Service Centre (SC): Function responsible for the relaying and store-and-forwarding of a short message between an SME and an MS. The SC is not a part of the GSM PLMN, however MSC and SC may be integrated.

short message: Information that may be conveyed by means of the Short Message Service described in this specification.

Short Message Entity (SME): An entity which may send or receive Short Messages. The SME may be located in a fixed network, an MS, or an SC.

SMS-STATUS-REPORT: Short message transfer protocol data unit informing the receiving MS of the status of a mobile originated short message previously submitted by the MS, i.e. whether the SC was able to forward the message or not, or whether the message was stored in the SC for later delivery.

SMS-COMMAND: Short message transfer protocol data unit which enables an MS to invoke an operation at the SC. An MS may then, for example, delete a short message, cancel a Status Report Request, enquire about the status of a short message or request another function to be performed by the SC.

The type of operation is indicated by the TP-Command-Type and the particular SM to operate on is indicated by the TP-Message-Number and the TP-Destination-Address. Receipt of an SMS-COMMAND is confirmed by an RP-ACK or RP-ERROR. In the case of certain SMS-COMMANDs, an SMS-STATUS-REPORT may be sent, where the outcome of the SMS-COMMAND is passed in its TP-Status field.

SMS-DELIVER: Short message transfer protocol data unit containing user data (the short message), being sent from an SC to an MS.

SMS-SUBMIT: Short message transfer protocol data unit containing user data (the short message), being sent from an MS to an SC.

Service-Centre-Time-Stamp (SCTS): Information element offering the recipient of a short message the information of when the message arrived at the SM-TL entity of the SC. The time of arrival comprises the year, month, day, hour, minute, second and time zone.

Validity-Period (VP): Information element enabling the originator MS to indicate the time period during which the originator considers the short message to be valid.

2.2.2 Abbreviations

For the purposes of this GTS, the following abbreviations apply

E.163	CCITT Rec. E.163 (Blue Book)
E.164	CCITT Rec. E.164 (Blue Book)
ACSE	Association Control Service Element
SM MT	Short Message Mobile Terminated Point-to-Point
SM MO	Short Message Mobile Originated Point-to-Point
SM-AL	Short Message Application Layer
SM-TL	Short Message Transfer Layer
SM-RL	Short Message Relay Layer
SM-LL	Short Message Lower Layers
SM-TP	Short Message Transfer Layer Protocol
SM-RP	Short Message Relay Layer Protocol
SM-TS	Short Message Transfer Service
SM-RS	Short Message Relay Service
T.100	CCITT Rec. T.100 (Blue Book)
T.101	CCITT Rec. T.101 (Blue Book)
TPDU	Transfer protocol data unit
X.121	CCITT Rec. X.121 (Blue Book)
X.400	CCITT Rec. X.400 (Blue Book)

In addition to those above, definitions used in this GTS are listed in GSM 01.04.

3 Services and service elements

The SMS provides a means to transfer short messages between a GSM MS and an SME via an SC. The SC serves as an interworking and relaying function of the message transfer between the MS and the SME.

This specification describes only the short message point-to-point services between the MS and SC. It may, however, refer to possible higher layer applications.

3.1 Basic services

The short message point-to-point services comprise two basic services:

- SM MT (Short Message Mobile Terminated Point-to-Point);
- SM MO (Short Message Mobile Originated Point-to-Point).

SM MT denotes the capability of the GSM system to transfer a short message submitted from the SC to one MS, and to provide information about the delivery of the short message either by a delivery report or a failure report with a specific mechanism for later delivery; see Figure 03.40/1.

SM MO denotes the capability of the GSM system to transfer a short message submitted by the MS to one SME via an SC, and to provide information about the delivery of the short message either by a delivery report or a failure report. The message must include the address of that SME to which the SC shall eventually attempt to relay the short message; see Figure 03.40/2.

The text messages to be transferred by means of the SM MT or SM MO contain up to 140 octets.

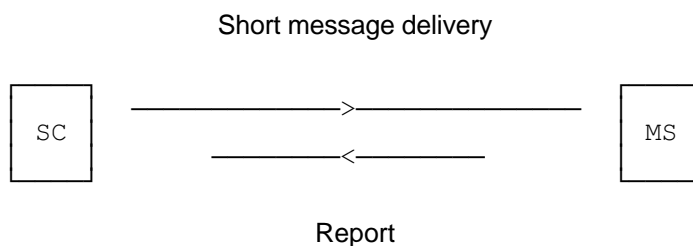

Figure 03.40/1: The Short Message Service mobile terminated, point-to-point.

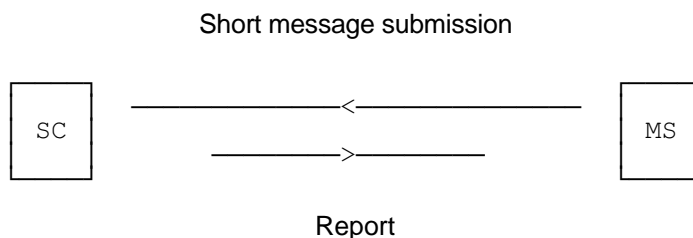

Figure 03.40/2: The Short Message Service mobile originated, point-to-point.

An active MS shall be able to receive a short message TPDU (SMS-DELIVER) at any time, independently of whether or not there is a speech or data call in progress. A report will always be returned to the SC; either confirming that the MS has received the short message, or informing the SC that it was impossible to deliver the short message TPDU to the MS, including the reason why.

An active MS shall be able to submit a short message TPDU (SMS-SUBMIT) at any time, independently of whether or not there is a speech or data call in progress. A report will always be returned to the MS; either confirming that the SC has received the short message TPDU, or informing the MS that it was impossible to deliver the short message TPDU to the SC, including the reason why.

NOTE: When the transmission or reception of a short message coincide with a change of state in the MS, i.e. from busy to idle or from idle to busy, or during a handover, the short message transfer might be aborted.

It is also possible for two short messages to be received in sequence having the same originating address and identification, i.e. message reference number (MO) or SC Timestamp (MT). Such a situation may be due to errors at the RP or CP layers (e.g. during inter MSC handover) where it may be a duplicated message or otherwise it may be a valid new message.

The receiving entity should therefore make provision to check other parameters contained in the short message to decide whether the second short message is to be discarded.

3.2 Short Message Service elements

The SMS comprises 7 elements particular to the submission and reception of messages:

- Validity-Period;
- Service-Centre-Time-Stamp;
- Protocol-Identifier;
- More-Messages-to-Send;
- Priority;
- Messages-Waiting;
- Alert-SC.

3.2.1 Validity-Period

The Validity-Period is the information element which gives an MS submitting an SMS-SUBMIT to the SC the possibility to include a specific time period value in the short message (TP-Validity-Period field, see section 9). The TP-Validity-Period parameter value indicates the time period for which the short message is valid, i.e. for how long the SC shall guarantee its existence in the SC memory before delivery to the recipient has been carried out.

3.2.2 Service-Centre-Time-Stamp

The Service-Centre-Time-Stamp is the information element by which the SC informs the recipient MS about the time of arrival of the short message at the SM-TL entity of the SC. The time value is included in every SMS-DELIVER (TP-Service-Centre-Time-Stamp field, see section 9) being delivered to the MS.

3.2.3 Protocol-Identifier

The Protocol-Identifier is the information element by which the SM-TL either refers to the higher layer protocol being used, or indicates interworking with a certain type of telematic device.

The Protocol-Identifier information element makes use of a particular field in the message types SMS-SUBMIT, SMS-DELIVER and SMS-COMMAND TP-Protocol-Identifier (TP-PID).

3.2.4 More-Messages-to-Send

The More-Messages-to-Send is the information element by which the SC informs the MS that there is one or more messages waiting in that SC to be delivered to the MS. The More-Messages-to-Send information element makes use of a boolean parameter in the message SMS-DELIVER, TP-More-Messages-to-Send (TP-MMS).

3.2.5 Delivery of Priority and non-Priority Messages

Priority is the information element provided by an SC or SME to indicate to the PLMN whether or not a message is a priority message.

Delivery of a non-priority message will not be attempted if the MS has been identified as temporarily absent (see section 3.2.6).

Delivery of a non-priority message will be attempted if the MS has not been identified as temporarily absent irrespective of whether the MS has been identified as having no free memory capacity (see section 3.2.6).

Delivery of a priority message will be attempted irrespective of whether or not the MS has been identified as temporarily absent, or having no free memory capacity.

3.2.6 Messages-Waiting

The Messages-Waiting is the service element that enables the PLMN to provide the HLR and VLR with which the recipient MS is associated with the information that there is a message in the originating SC waiting to be delivered to the MS. The service element is only used in case of previous unsuccessful delivery attempt(s) due to temporarily absent mobile or MS memory capacity exceeded. This information, denoted the Messages-Waiting-Indication (MWI), consists of Messages-Waiting-Data (MWD), the Mobile-Station-Not-Reachable-Flag (MNRF) and the Mobile-Station-Memory-Capacity-Exceeded-Flag (MCEF) located in the HLR, and the Mobile-Station-Not-Reachable-Flag (MNRF) located in the VLR. Figure 03.40/3 shows an example.

HLR;

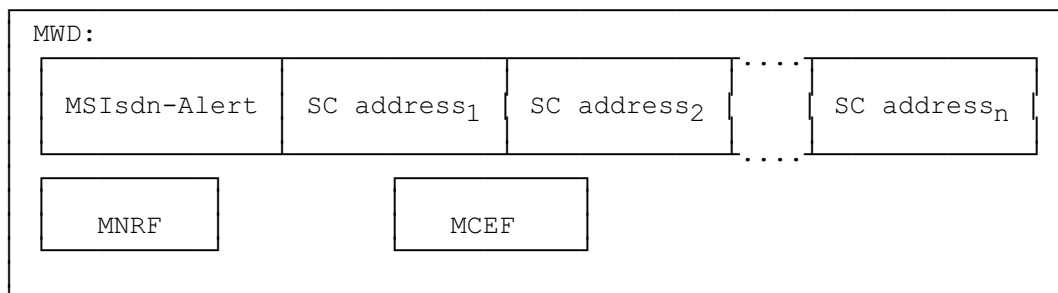

VLR;

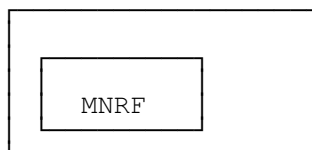

Figure 03.40/3: Example of how information on one MS can be put in relation to SC(s) in order to fulfil the requirement of Alert-SC mechanism.

The MWD shall contain a list of addresses (SC-Addr) of SCs which have made previous unsuccessful delivery attempts of a message (see section 5). In order to be able to send alert messages to every SC which has made unsuccessful delivery attempts to an MS, the HLR shall store the MSIsdn-Alert (see section 3.2.7) together with references to the SC addresses. The requirements placed upon the HLR are specified in GSM 03.08. The description of how the HLR is provided with SC and MS address information is given in GSM 09.02.

The Mobile-Station-Memory-Capacity-Exceeded-Flag (MCEF) within the HLR is a boolean parameter with the value TRUE when the list MWD contains one or more list elements because an attempt to deliver a short message to an MS has failed with a cause of MS Memory Capacity Exceeded, and with the value FALSE otherwise.

The Mobile-Station-Not-Reachable-Flag (MNRF) within the HLR and the VLR is a boolean parameter with the value TRUE when the list MWD contains one or more list elements because an attempt to deliver a short message to an MS has failed with a cause of Absent Subscriber, and with the value FALSE otherwise.

The MWD, MCEF and MNRF are updated in the following way:

- 1a) When a mobile terminated short message delivery fails due to the MS being temporarily absent (i.e. either IMSI DETACH flag is set or there is no response from the MS to a paging request), the SC address is inserted into the MWD list (if it is not already present) and the MNRF is set (if it is not already set), as described in section 10.
- 1b) When a mobile terminated short message delivery fails due to the MS memory capacity being exceeded, the SC address is inserted into the MWD list (if it is not already present) and the MCEF is set (if it is not already set), as described in section 10.
- 1c) If the MSIsdn used by the SC to address the recipient MS for alerting purposes is different from the MSIsdn-Alert of the MS (see section 3.2.7), the HLR returns the MSIsdn-Alert to the SC within the failure report, see "1c Failure report" in figures 03.40/15 and /16.
- 2a) When either the HLR or VLR detects that the MS (with a non-empty MWD and the MCEF clear in the HLR and the MNRF set in the VLR) has recovered operation (e.g. has responded to a paging request), the HLR directly or on request of the VLR will invoke operations to alert the SCs within the MWD (see section 3.2.7 and section 10). Once the Alert SC operations have been invoked, the MNRF is cleared. After each SC is alerted by the HLR, the address for that SC is deleted from the MWD. If the MCEF is set in the HLR, the HLR clears the MNRF, but does not invoke operations to alert the SCs within the MWD and data are not cleared from the MWD.
- 2b) When the HLR receives (via the MSC and the VLR) a notification that the MS (with a non-empty MWD and the MCEF set in the HLR) has memory capacity available to receive one or more short messages, the HLR will invoke operations to alert the SCs within the MWD (see section 3.2.7 and section 10). Once the Alert SC operations have been invoked, the MNRF is cleared in the VLR and the MCEF and MNRF are cleared in the HLR. After each SC is alerted by the HLR, the address for that SC is deleted from the MWD.
- 2c) When the HLR receives from the SMS-GMSC a notification that a short message has been successfully delivered from an SC to an MS for which the MCEF is set and the MWD are not empty, the HLR will invoke operations to alert other SCs within the MWD (see section 3.2.7 and section 10). Once the Alert SC operations have been invoked, the MCEF and MNRF are cleared in the HLR. After each SC is alerted by the HLR, the address for that SC is deleted from the MWD. The SC which successfully delivered the message is also deleted from the MWD, if present.
- 2d) When the HLR receives (via the MSC and the VLR) a notification that the MS has memory capacity available to receive one or more short messages but the MCEF is not set and the MWD are empty, the HLR acknowledges the notification but does not alert any service centre.

3.2.7 Alert-SC

The Alert-SC is the service element, which may be provided by some GSM PLMNs, to inform the SC that an MS

- 1) to which a delivery attempt has failed because the MS is not reachable or because the MS memory capacity was exceeded;

and

- 2) which is now recognized by the PLMN:
 - a) to have resumed operation (e.g. to have responded to a paging request); or
 - b) to have memory newly available (which implies that the mobile is reachable).

is again ready to receive one or more short messages. The SC may - on reception of an Alert-SC - initiate the delivery attempt procedure for the queued messages destined for this MS.

To each MS there may be allocated several MSIsdns. When the HLR is to alert an SC that an MS is again attainable it will use a specific MSIsdn value for this purpose; in this specification called MSIsdn-Alert.

NOTE: Repeated delivery attempts from the SC may be of two types:

- i) A repeated delivery attempt because the SC has been informed that the MS is active and available to receive short messages.
- ii) An autonomous repeated delivery attempt by the SC.

The application of these two options is defined by the providers of the SC and the network.

3.2.8 Options concerning MNRF, MCEF and MWD

Setting the Mobile-Station-Not-Reachable-Flag (MNRF) in the VLR is mandatory. It is also mandatory for the VLR to send the 'MS Present' message (see section 10) to the HLR when the MS has been detected as becoming active and then to clear MWF.

The Messages-Waiting-Data (MWD, the Mobile-Station-Not-Reachable-Flag (MNRF) and the Mobile-Station-Memory-Capacity-Exceeded-Flag (MCEF)) within the HLR are optional, but if one is implemented all must be implemented. This is linked to the transmission of the 'Alert SC' message.

The following describes what happens when a delivery fails.

Case 1: MWD, MNRF and MCEF are implemented in the HLR

In the case of a delivery failure (to an MS) with cause Absent Subscriber, the MSC requests the HLR to add, if needed, a new entry in the MWD with cause Absent Subscriber. This new entry contains the SC address. The HLR sets its copy of the MNRF. The SC is notified of the failure and also of the MWD setting in the HLR within the Report message (see section 10).

In the case of a delivery failure (to an MS) with cause Mobile Station Memory Capacity Exceeded, the MSC requests the HLR to add, if needed, a new entry in the MWD with cause Mobile Station Memory Capacity Exceeded. This new entry contains the SC address. The HLR sets the MCEF. The SC is notified of the failure and also of the MWD setting in the HLR within the Report message (see section 10).

If the HLR indicates that it is able to store the SC address, then the SC will receive an Alert SC message when the MS becomes active.

If the HLR indicates that it is unable to store the SC address (e.g. because MWD is full), then the only way to ensure delivery is for the SC to try to retransmit the message periodically.

When the HLR receives the MS Present message, if the MCEF is clear it sends an Alert SC message to the concerned SC and updates MWD.

When the HLR receives the MS Memory Capacity Available message, it sends an Alert SC message to the concerned SC, updates MWD and clears the MCEF.

Case 2: MWD, MNRF and MCEF are not implemented in the HLR

In the case of a delivery failure, the SC is notified that the HLR is unable to store its address in the MWD. The SC must retransmit the short message periodically in order to ensure delivery.

The HLR discards the MS Present message received from the VLR without any failure or error report.

The HLR discards the MS Memory Capacity Available message received from the MS via the MSC and the VLR without any failure or error report.

3.2.9 Status report capabilities

The SMS also offers to the SC the capabilities of informing the MS of the status of a previously sent mobile originated short message. The status of the message can be:

- Successfully delivered to the SME;
- The SC was not able to forward the message to the SME. The reason can be an error of permanent or temporary nature. Permanent errors can be e.g. validity period expired, invalid SME address. Errors of temporary nature can be e.g. SC-SME connection being down, SME temporarily unavailable.

This is achieved by the SC returning a status report TPDU (SMS-STATUS-REPORT) to the originating MS when the SC has concluded the status of the short message. The status report may be initiated by a status report request within the mobile originated short message. The status report TPDU is treated as an SMS-DELIVER TPDU by the SC when it comes to delivery procedures e.g. the alerting mechanism.

The SC may also return to a non-MS SME the status of a mobile terminated short message. This is however outside the scope of this specification.

The status report capabilities of the SMS are optional, i.e. the choice of whether to offer status report or not is left to the SC operator.

3.2.10 Reply Path

Reply Path specified in this specification provides a way of both requesting and indicating a service centre's commitment to deliver a reply from the replying MS to the originating SME.

Annex D deals with MS procedures, which in general are outside the scope of GSM specifications. However, for advanced use of the SMS, including both application level protocols and human responses, it is of vital importance to guarantee that a reply-supporting MS is able to reply on every SM, to every SME capable of receiving such reply short messages.

3.3 Unsuccessful short message TPDU transfer SC -> MS

Unsuccessful message transfer SC -> MS may be caused by a variety of different errors. The description of the occurrence of the different errors and how to handle and transfer the error indications is given in GSM 04.08, GSM 04.11 and GSM 09.02.

The different error indications which the SMS-GMSC shall be capable of returning to the SC following an unsuccessful short message TPDU transfer SC-> MS, are given in Table 03.40/1. In some cases, additional diagnostic information may be provided.

3.3.1 Errors occurring during transfer of TPDU to MS

These errors are generally due to barring or unsupported service in the PLMN or MS. An error indication is returned to the SC from the SMS-GMSC, but further diagnostic information from the MS will not be available.

3.3.2 Errors occurring after TPDU arrives at MS

These errors may occur due to the MS not supporting optional short message service features, or in connection with a short message application. An error indication shall be returned to the SC from the SMS-GMSC. Additionally, a TPDU (SMS-DELIVER-REPORT) containing diagnostic information may be conveyed from the MS to the originating SC, transparently through the PLMN, by means defined in GSM 04.11 and GSM 09.02. The sending of the diagnostic information is optional at the MS, but when it is sent, the PLMN shall convey the information to the SC, and the SC shall support reception of the information.

Table 03.40/1: Error indications related to mobile terminated short message transfer which may be transferred to the originating SC.

Error indication	S¹⁾	Meaning
Unknown subscriber	P	The PLMN rejects the short message TPDU because there is not allocated an IMSI or a directory number for the mobile subscriber in the HLR (see GSM 09.02).
Teleservice not provisioned	P	The PLMN rejects the short message TPDU because the recipient MS has no SMS subscription (see GSM 09.02).
Call barred	T	The PLMN rejects the short message TPDU due to barring of the MS (see GSM 09.02, description of the Barring supplementary service, GSM 02.04 and 03.11), and description of Operator Determined Barring, GSM 02.41 and 03.15).
Facility not supported	T	The VPLMN rejects the short message TPDU due to no provision of the SMS in the VPLMN (see GSM 09.02).
Absent subscriber	T	The PLMN rejects the short message TPDU because - there was no paging response, (see GSM 04.08) - the IMSI record is marked detached (see GSM 09.02), or - the MS is subject to roaming restrictions (see 'Roaming not allowed', GSM 09.02).
MS busy for MT SMS	T	The PLMN rejects the short message TPDU because of congestion encountered at the visited MSC. Possible reasons include any of the following events in progress: - short message delivery from another SC - IMSI detach - Location Update - paging - emergency call - call setup
SMS lower layers capabilities not provisioned	T	The PLMN rejects the short message TPDU due to MS not being able to support the Short Message Service. The short message transfer attempt is rejected either due to information contained in the class-mark, or the MSC not being able to establish connection at SAPI = 3 (see GSM 04.08 and GSM 09.02).
Error in MS	T	The PLMN rejects the short message TPDU due to an error occurring within the MS at reception of a short message, e.g.lack of free memory capacity or protocol error.
Illegal Subscriber	P	The PLMN rejects the short message TPDU because the MS failed authentication
Illegal Equipment	P	The PLMN rejects the short message TPDU because the IMEI of the MS was black-listed in the EIR
System failure	T	The PLMN rejects the short message TPDU due to network or protocol failure others than those listed above (see GSM 09.02)
Memory Capacity Exceeded	T	The MS rejects the short message since it has no memory capacity available to store the message

1) : Status (Permanent or Temporary)

The relation between the two sets of error indications is given in the table 03.40/1. Each error is classified as either 'Temporary' or 'Permanent'. This classification gives an indication of whether or not it is probable that the MS becomes attainable within a reasonable period, and so provides the recommended action to be taken by the SC, i.e. either to store the message for later transfer, or to discard it.

3.4 Unsuccessful short message TPDU transfer MS -> SC

The error indications related to mobile originated short message transfer which may be transferred to the originating MS are given in GSM 04.11. In some cases, additional diagnostic information may be provided.

3.4.1 Errors occurring during transfer of TPDU to SC

These errors are generally due to barring or unsupported service in the PLMN. An error indication is returned to the MS from the MSC, but further diagnostic information from the SC will not be available.

3.4.2 Errors occurring after TPDU arrives at SC

These errors may occur due to the SC not supporting optional short message service features, or in connection with a short message application. An error indication shall be returned to the MS from the MSC. Additionally, a TPDU (SMS-SUBMIT-REPORT) containing diagnostic information may be conveyed from the SC to the originating MS, transparently through the PLMN, as defined in GSM 09.02 and GSM 04.11. The sending of the diagnostic information is optional at the SC, but when it is sent, the PLMN shall convey the information to the MS, and the MS shall support reception of the information.

NOTE: The SMS-SUBMIT-REPORT is part of the negative acknowledgement to the mobile originated short message, and is not part of the status report capabilities described in section 3.2.9.

3.5 Use of Supplementary Services in combination with the Short Message Service

Only a sub-set of the Supplementary Services defined in GSM 02.04 and 03.11 may be used in combination with the Short Message Service. This sub-set comprises the following Supplementary Services:

All the 5 Barring services

3.6 Applicability of Operator Determined Barring to the Short Message Service

The network feature Operator Determined Barring (see GSM 02.41) applies to the Short Message Service.

If a short message fails due to operator determined barring then an appropriate error cause is returned to the originator.

3.7 Multiple short message transfer

To avoid the need for a mobile to be paged, authenticated etc. for each message waiting in the Service Centre, the SC may indicate to the GMSC that there are more messages to send. When this indication is given, MAP procedures are invoked such that this indication is passed to the VMSC, and the VMSC does not release the MS until all short messages waiting in the SC have been transferred.

4 Network architecture

4.1 Basic network structure

The exchange of messages between an MS and an SME involves the entities shown in Figure 03.40/4.

The basic network structure of the SMS is depicted in Figure 03.40/5.

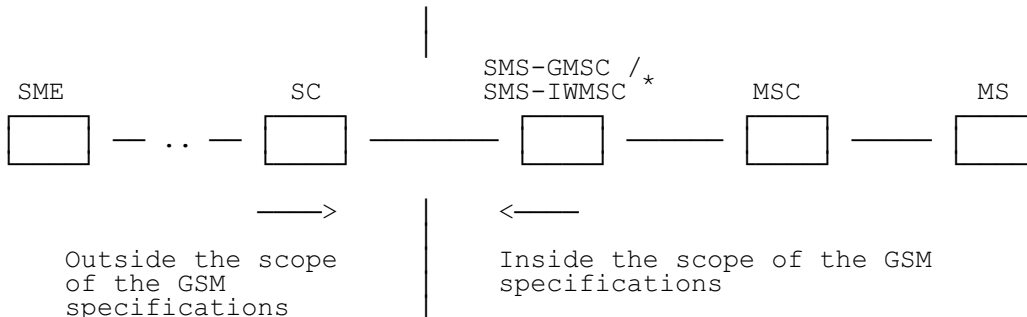

*) : SMS-GMSC when the short message is transferred from the SC to the MS, SMS-IWMSC when the short message is transferred from the MS to the SC. The SC may be integrated with the SMS-GMSC/SMS-IWMSC.

Figure 03.40/4: Entities involved in the provision of SM MT and SM MO: SC, SMS-GMSC/SMS-IWMSC, MSC and MS.

The links of Figure 03.40/5 support the short message transfer in the following way:

- message transfer on link 1 is described in section 5;
- the operations performed on links 2 and 4 is described in GSM 09.02;
- message transfer on link 3 is described in section 4.2;
- message transfer on link 5 is supported by protocol described in GSM 04.11.

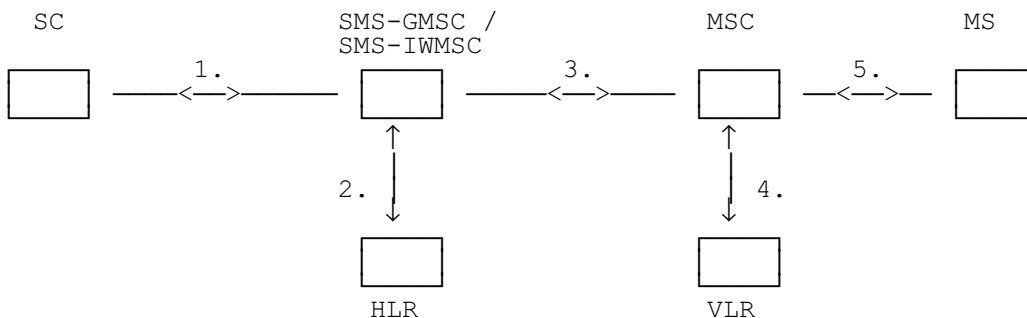

Figure 03.40/5: The main network structure serving as a basis for the short message transfer.

4.2 Transfer on link 3

The link 3 is used to support communications between MSCs (MSC, SMS-GMSC, SMS-IWMSC). Two cases can be distinguished according to whether or not the MSCs are located in the same PLMN.

In the first case, the link definition is left to the operators. For example, this link may use:

- PSPDN or
- CCITT SS no 7 (according to GSM 09.02).

In the second case, CCITT SS no 7 shall be used over link 3 according to GSM 09.02, unless otherwise bilaterally agreed.

5 Service Centre and PLMN interconnection

This specification deals with the SC only with regard to the interchange of messages between SC and MS. Only the requirements put upon the SC by the SMS functionality are specified in this specification.

5.1 Service centre connection

One SC may be connected to several PLMNs, and may be connected to several MSCs (SMS-GMSCs or SMS-IWMSCs) within one and the same PLMN.

The SC is addressed from the mobile by an E.164 number in the numbering plan of the PLMN to which the SC is connected. This E.164 number shall uniquely identify the SC to that PLMN.

There may be an intermediate network between the PLMN and the SC; in this case the PLMN must autonomously make a connection to the SC using the SC address in this intermediate network.

No mandatory protocol between the SC and the MSC below the transfer layer is specified by GSM; this is a matter for agreement between SC and PLMN operators. However, Annex A provides an example protocol stack which could be used.

5.2 Routing requirements

5.2.1 Mobile terminated short message

The SC sends the short message to the SMS-GMSC. The SMS-GMSC interrogates the HLR to retrieve routing information necessary to forward the short message, and then sends the message to the relevant MSC, transiting other networks if necessary. The MSC then sends the short message to the MS.

5.2.2 Mobile originated short message

The MS sends the short message to the MSC. The MS will always address the required SC by an E.164 address. The visited PLMN will route the message to the appropriate SMS-IWMSC in the SC's PLMN, transiting other networks if necessary.

6 Service Centre functionality

In this specification, only the SC functionality related to the short message point-to-point service between the SC and the MS is specified.

6.1 Service Centre capabilities

The SC should be capable of

- submitting a short message to an MS, retaining the responsibility of the message until
 - 1) the report has been received; or
 - 2) the Validity-Period expires.
- receiving a report from the PLMN;
- receiving a short message from an MS;
- returning a report to the PLMN for a previously received short message.

6.2 SC functional requirements

The detailed functionality of the SC is outside the scope of this specification, and is for the SC operator to define. However, the following functional requirements are mandatory for all SCs in order to support the SM-TP (see section 9) towards the PLMN:

- 1) To identify each SMS-DELIVER sent to an MS in a unique way, a time stamp value is included in the field TP-Service-Centre-Time-Stamp, TP-SCTS, of the SMS-DELIVER. The time stamp gives the time when the message arrived at the SC with the accuracy of a second. If two or more messages to the same MS arrive at the SC within one second, the SC shall modify the time stamp of those messages in such a way that
 - a) all messages to the MS contain different time stamps;
 - b) the modification of the time stamps is kept to a minimum.
- 2) The SC is only allowed to have one outstanding SMS-DELIVER (i.e. a message for which a report has not been received) to a specific MS at a given time.
- 3) The SC shall be able to initiate overwriting of short messages previously received by the SC if requested by the same originating address (MS or any other source) by use of the same message type.

7 MS functionality

In this specification, only the MS functionality related to the short message point-to-point service between the SC and the MS is specified.

7.1 MS capabilities

The MS, when equipped for SMS, should be capable of

- submitting a short message TPDU to an SC, retaining the responsibility of the message until:
 - 1) the report arrives from the network; or
 - 2) a timer expires.
- receiving a short message TPDU from an SC;
- returning a delivery report to the network for a previously received short message;
- receiving a report from the network;
- notifying the network when it has memory capacity available to receive one or more short messages when it has previously rejected a short message because its memory capacity was exceeded;
- notifying the SC when a short message is intended to replace a short message the MS has previously submitted to the same destination address.

It is recommended that an MS supporting both replying and automatic SC selection (as specified in section D.2 of Annex D) follows procedures specified in Annex D when replying to MT short messages with MO short messages.

It is recommended that an MS supporting a capability for requesting a reply path follows procedures specified in Annex D.

7.2 MS configuration

The reference configuration is assumed as in Figure 03.40/6, i.e. only the case where the terminal is integrated in the MS is considered.

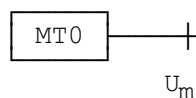

Figure 03.40/6: Reference configuration of the MS which apply to the SMS.

Note: It is foreseen that a terminal interface may be offered, e.g. for higher layer protocols, memory capacity reasons or to be able to type in mobile originated messages. This terminal interface is regarded as an implementation option, although, where offered, it must be based upon an R- or S-reference point. TS GSM 07.05 provides an example based on the R reference point.

8 MSC functionality

The overall requirements to the MSC with respect to handling of the Short Message Service point-to-point is to cater for the routing and necessary intermediate buffering of the short messages.

8.1 MSC functionality related to SM MT

8.1.1 Functionality of the SMS-GMSC

When receiving a short message TPDU from the SC, the SMS-GMSC is responsible for the following operations:

- reception of the short message TPDU,
- inspection of the parameters,

NOTE: The SMS-GMSC may be identical to the MSC.

if parameters are incorrect:

- returning the appropriate error information to the SC in a failure report (see section 9 and 10).

if errors are not found within parameters:

- interrogating the HLR ('sendRoutingInfoForShortMsg', see section 10); retrieving routing information or possible error information,

if HLR is returning error information:

- returning the appropriate error information to the SC in a failure report (see section 9 and 10).

if no errors are indicated by the HLR:

- transferring the short message TPDU to the MSC using the routing information obtained from the HLR ('forwardShortMessage', see section 10).

When receiving the report associated with the short message from the MSC (positive or negative outcome of 'forwardShortMessage', see section 10), the SMS-GMSC is responsible for the following operations:

if the report indicates successful delivery:

- notifying the HLR of the successful delivery, which will cause the HLR to alert any service centres whose addresses are stored in the MWD for the MS.

if the report is a failure report indicating 'absent subscriber' (see section 3.3):

- requesting the HLR to insert the address of the originating SC into the MWD (if implemented) with cause Absent Subscriber ('setMessageWaitingData', see section 9 and 10);
- establishing, where necessary, a link with the addressed SC (see section 5);
- creating and sending the report to the SC (see section 9 and 10).

if the report is a failure report indicating 'MS memory capacity exceeded' (see section 3.3):

- requesting the HLR to insert the address of the originating SC into the MWD (if implemented) with cause MS Memory Capacity Exceeded ('setMessageWaitingData', see sections 9 and 10);
- establishing, where necessary, a link with the addressed SC (see section 5);
- creating and sending the report to the SC (see sections 9 and 10).

8.1.2 Functionality of the MSC

When receiving a short message TPDU from the SMS-GMSC ('forwardShortMessage', see section 10), the MSC is responsible for the following operations:

- reception of the short message TPDU;
- retrieving information from the VLR ('sendInfoFor-MT-SMS', see section 10); location area address and, when appropriate, error information,

if errors are indicated by the VLR:

- returning the appropriate error information to the SMS-GMSC in a failure report (negative outcome of 'forwardShortMessage' see section 10 and 11),

if no errors are indicated by the VLR:

- transferring the short message to the MS (see GSM 04.11).

When receiving a confirmation that the message is received by the MS (see GSM 04.11):

- relaying the delivery confirmation to the SMS-GMSC in a delivery report (positive outcome of 'forwardShortMessage', see section 10 and 11).

When receiving a failure report of the short message transfer to the MS (see GSM 04.11):

- returning the appropriate error information to the SMS-GMSC in a failure report (negative outcome of 'forwardShortMessage', see section 10).

When receiving a notification from the MS that it has memory available to receive one or more short messages (see GSM 04.11):

- relaying the notification to the VLR ('mSMemoryCapacityAvailable', see section 10).

if errors are indicated by the VLR:

- returning the appropriate error information to the MS in a failure report (negative outcome of 'ReadyForSM', see section 10 and 11).

8.2 MSC functionality related to SM MO

8.2.1 Functionality of the MSC

When receiving a short message TPDU from the MS, the MSC is responsible for the following operations:

- reception of the short message TPDU (see GSM 04.11)
- retrieving information from the VLR ('sendInfoForMO-SMS', see section 10); the MSISDN of the MS and, when appropriate, error information. The retrieval of information from the VLR is followed by the VLR investigating the MWF (to be used in the alerting procedure, see section 10)

if errors are indicated by the VLR:

- returning the appropriate error information to the MS in a failure report (negative outcome of 'sendInfoForMO-SMS' see section 10 and 11),

if no errors are indicated by the VLR:

- inspection of the TPDU parameters.

if parameters are incorrect:

- returning the appropriate error information to the MS in a failure report (see GSM 04.11).

if no parameter errors are found:

- examination of the destination address;

NOTE: The SMS-IWMSC may be identical to the MSC.

- transferring the short message TPDU to the SMS-IWMSC ('forwardShortMessage', see section 10).

When receiving the report of the short message from the SMS-IWMSC (positive or negative outcome of the 'forwardShortMessage', see section 10), the MSC is responsible for the following operations:

- relaying the report to the MS (see GSM 04.11).

8.2.2 Functionality of the SMS-IWMSC

When receiving a short message TPDU from the MSC ('forwardShortMessage', see section 10), the SMS-IWMSC is responsible for the following operations:

- reception of the short message TPDU;
- establishing, where necessary, a link with the addressed SC (see section 5);
- transferring the short message TPDU to the SC (if the address is valid).

If a report associated with the short message is received from the SC, the SMS-IWMSC is responsible for the following operations:

- relaying of the report to the MSC (positive or negative outcome of 'forwardShortMessage', see section 10).

If a report associated with the short message is not received from the SC before a timer expires or if the SC address is invalid, the SMS-IWMSC is responsible for the following operations:

- returning the appropriate error information to the MSC in a failure report (negative outcome of 'forwardShortMessage', see section 10).

The value of the timer is dependent on the protocol between the SC and the SMS-IWMSC.

8.3 SMS-IWMSC functionality related to alerting

When receiving an alert from the HLR ('alertServiceCentre', see section 10), the SMS-IWMSC is responsible for the following operations:

- inspect the SC address;
- generate an RP-Alert-SC (see section 9);
- transferring the RP-Alert-SC to the SC.

NOTE: If the SC address is not valid, then no further action will be taken.

9 Protocols and protocol architecture

The protocol layers of the SMS are structured as shown in Figure 03.40/7.

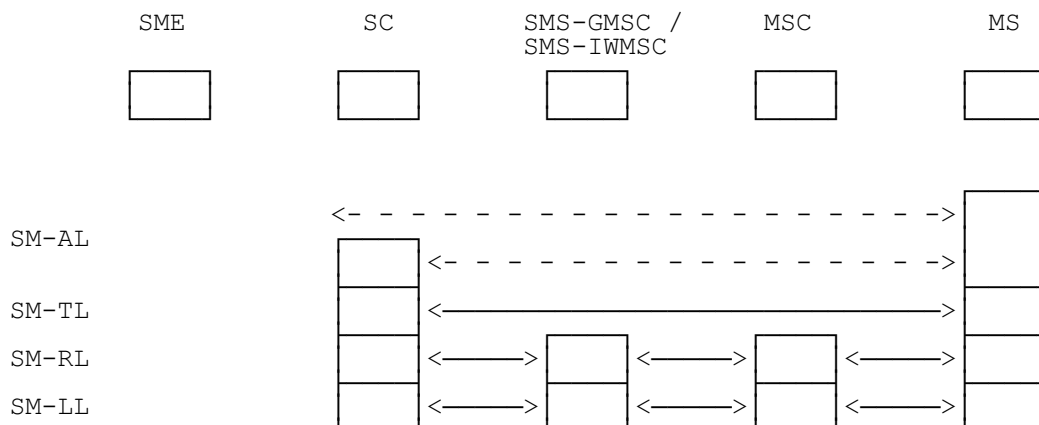

Figure 03.40/7: Protocol layer overview for the Short Message Service point-to-point.

This specification specifies the protocol at the SM-TL, the service offered by the SM-TL at the MS and the SC, and the service offered by the SM-RL at the SC.

9.1 Protocol element features

9.1.1 Octet and Bit transmission order

The octets are transmitted according to their individual numbering; the octet with the lowest number being transmitted first. The bits within each octet are transmitted according to their individual numbering also; the bits with the lowest internal number being transmitted first.

9.1.2 Numeric and alphanumeric representation

For parameters within the TPDU, there are four ways of numeric representation: Integer representation, octet, semi-octet and alphanumeric representation.

9.1.2.1 Integer representation

Wherever the bits from a number of octets, complete or in fractions, are to represent an integer, the interpretation will be according to the following:

- 1) Between octets: The octets with the lowest octet numbers will contain the most significant bits.
- 2) Within an octet: The bits with the highest bit numbers will be the most significant.

Below is given an example of octet and bit representation and transmission order of an integer represented field.

Let the 2 rightmost bits of octet no 5, the complete octet no 6 and 7, and the 3 leftmost bits of octet no 8 represent an integer, as shown in Figure 03.40/8.

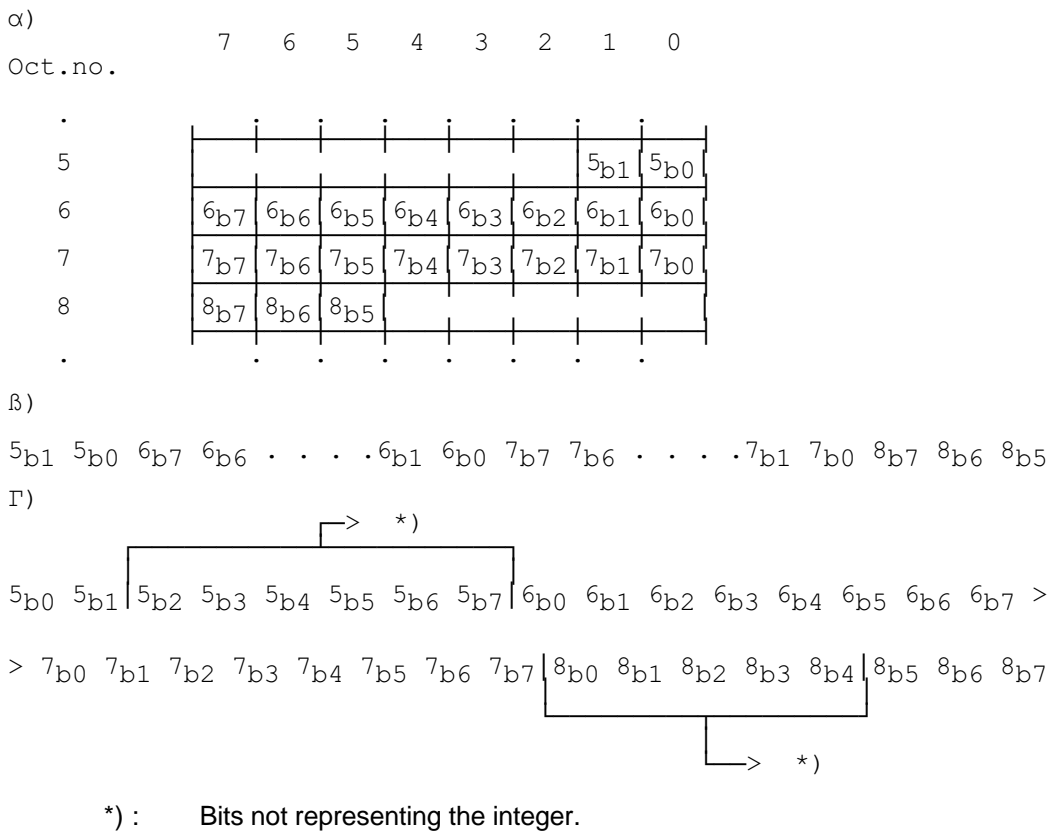

Figure 03.40/8: 21 bits from the octets 5, 6, 7, and 8 in a short message α) will represent an integer as shown in β), and will be transmitted in an order as shown in Γ).

9.1.2.2 Octet representation

A field which is octet represented, will always consist of a number of complete octets. Each octet within the field represents one decimal digit. The octets with the lowest octet numbers will contain the most significant decimal digits.

9.1.2.3 Semi-octet representation

A field which is semi-octet represented, will consist of a number of complete octets and - possibly - one half octet. Each half octet within the field represents one decimal digit. The octets with the lowest octet numbers will contain the most significant decimal digits. Within one octet, the half octet containing the bits with bit numbers 0 to 3, will represent the most significant digit.

In the case where a semi-octet represented field comprises an odd number of digits, the bits with bit numbers 4 to 7 within the last octet are fill bits and shall always be set to '1111'.

Within each semi octet, the bits with the highest bit numbers will be the most significant.

Below is given an example:

Octet no:

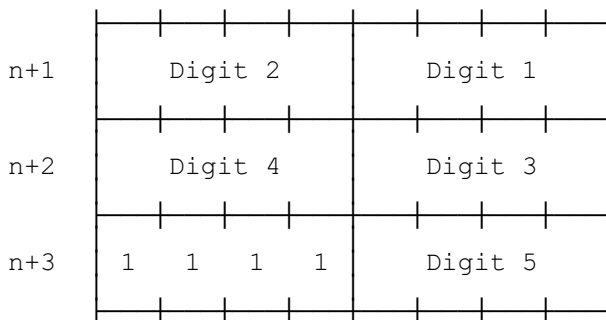

9.1.2.4 Alphanumeric representation

A field which uses alphanumeric representation will consist of a number of 7-bit characters represented as the default alphabet defined in GSM 03.38.

9.1.2.5 Address fields

Address fields used by SM-RL are specified in TS GSM 04.11 and 09.02.

Each address field of the SM-TL consists of the following sub-fields: An Address-Length field of one octet, a Type-of-Address field of one octet, and one Address-Value field of variable length; as shown below:

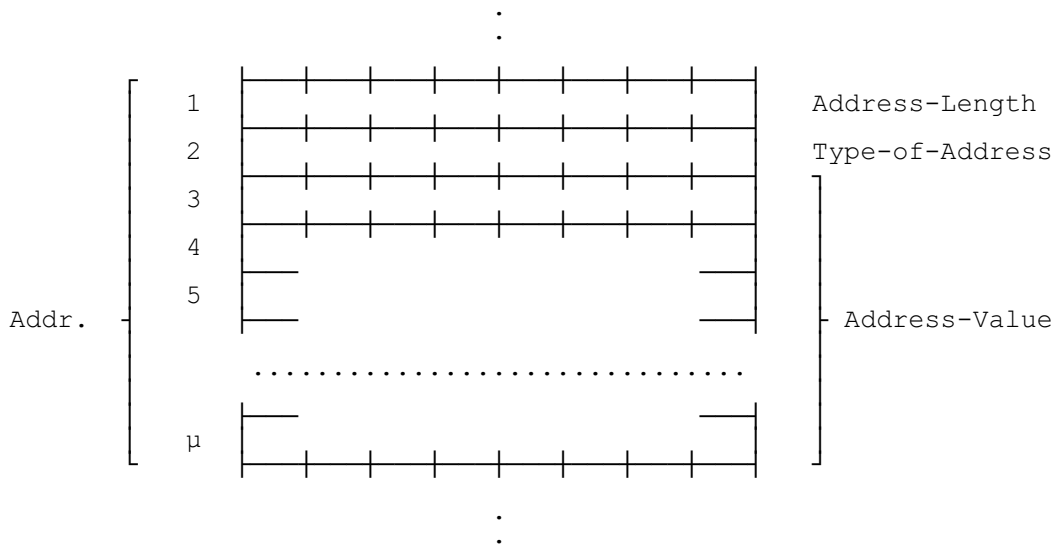

The Address-Length field is an integer representation of the number of useful semi-octets within the Address-Value field, i.e excludes any semi octet containing only fill bits.

The Type-of-Address field format is as follows:

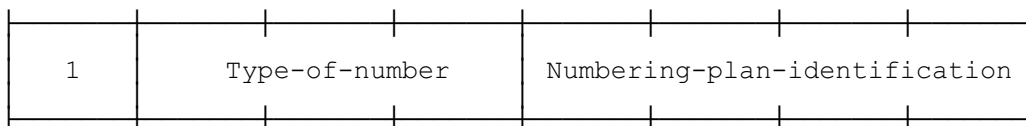

Type-of-number:

Bits	6	5	4	
	0	0	0	Unknown ¹⁾
	0	0	1	International number ²⁾
	0	1	0	National number ³⁾
	0	1	1	Network specific number ⁴⁾
	1	0	0	Subscriber number ⁵⁾
	1	0	1	Alphanumeric, (coded according to GSM TS 03.38 7-bit default alphabet)
	1	1	0	Abbreviated number
	1	1	1	Reserved for extension

The MS will not interpret reserved values but will store them as received.

The SC may reject messages with a type of number containing a reserved value or one which is not supported.

- 1) 'Unknown' is used when the user or network has no a priori information about the numbering plan. In this case, the Address-Value field is organized according to the network dialling plan, e.g. prefix or escape digits might be present.
- 2) The international format shall be accepted also when the message is destined to a recipient in the same country as the MSC.
- 3) Prefix or escape digits shall not be included.
- 4) 'Network specific number' is used to indicate administration/service number specific to the serving network, e.g. used to access an operator.
- 5) 'Subscriber number' is used when a specific short number representation is stored in one or more SCs as part of a higher layer application. (Note that 'Subscriber number' shall only be used in connection with the proper PID referring to this application).

Numbering-plan-identification (applies for Type-of-number = 000,001,010)

Bits	3	2	1	0	
	0	0	0	0	Unknown
	0	0	0	1	ISDN/telephone numbering plan (E.164/E.163)
	0	0	1	1	Data numbering plan (X.121)
	0	1	0	0	Telex numbering plan
	1	0	0	0	National numbering plan
	1	0	0	1	Private numbering plan
	1	0	1	0	ERMES numbering plan (ETSI DE/PS 3 01-3)
	1	1	1	1	Reserved for extension

All other values are reserved.

For Type-of-number = 101 bits 3,2,1,0 are reserved and shall be transmitted as 0000. Note that for addressing any of the entities SC, MSC or MS, Numbering-plan-identification = 0001 will always be used. However, for addressing the SME, any specified Numbering-plan-identification value may be used.

The MS will not interpret reserved values but will store them as received.

The SC may reject messages with a type of number containing a reserved value or one which is not supported.

Within the Address-Value field, either a semi-octet or an alphanumeric¹⁾ representation applies.

The maximum length of the full address field (Address-Length, Type-of-Address and Address-Value) is 12 octets.

1) Applies only to addressing at the SM-TL.

9.2 Service provided by the SM-TL

9.2.1 General

The Short Message Transfer Layer (SM-TL) provides a service to the Short Message Application Layer (SM-AL). This service enables the SM-AL to transfer short messages to its peer entity, receive short messages from its peer entity and receive reports about earlier requests for short messages to be transferred.

In order to keep track of messages and reports about those messages, primitives between the SM-AL and SM-TL contain a Short Message Identifier (SMI), which is a reference number for the message associated with the primitive. This Short Message Identifier is mapped to and from the Short Message Identifier used between the SM-TL and the Short Message Relay Layer (SM-RL). The Short Message Identifier is not carried between entities and therefore a given message may have different SMIs at the MS and SC sides (see section 9.3.1 below).

The SM-TL communicates with its peer entity by the protocol described in the following sections.

9.2.2 PDU Type repertoire at SM-TL

The SM-TL comprises the following six PDUs:

- SMS-DELIVER, conveying a short message from the SC to the MS
- SMS-DELIVER-REPORT, conveying a failure cause (if necessary)
- SMS-SUBMIT, conveying a short message from the MS to the SC.
- SMS-SUBMIT-REPORT, conveying a failure cause (if necessary)
- SMS-STATUS-REPORT, conveying a status report from the SC to the MS
- SMS-COMMAND, conveying a command from the MS to the SC.

9.2.2.1 SMS-DELIVER type

Basic elements of the SMS-DELIVER type:

Abbr.	Reference	P ¹⁾	R ²⁾	Description
TP-MTI	TP-Message-Type-Indicator	M	2b	Parameter describing the message type.
TP-MMS	TP-More-Messages-to-Send	M	b	Parameter indicating whether or not there are more messages to send
TP-RP	TP-Reply-Path	M	b	Parameter indicating that Reply Path exists.
TP-UDHI	TP-User-Data-Header-Indicator	O	b	Parameter indicating that the TP-UD field contains a Header
TP-SRI	TP-Status-Report-Indication	O	b	Parameter indicating if the SME has requested a status report.
TP-OA	TP-Originating-Address	M	2-12o	Address of the originating SME.
TP-PID	TP-Protocol-Identifier	M	o	Parameter identifying the above layer protocol, if any
TP-DCS	TP-Data-Coding-Scheme	M	o	Parameter identifying the coding scheme within the TP-User-Data.
TP-SCTS	TP-Service-Centre-Time-Stamp	M	7o	Parameter identifying time when the SC received the message.
TP-UDL	TP-User-Data-Length	M	l	Parameter indicating the length of the TP-User-Data field to follow.
TP-UD	TP-User-Data	M	3)	

- 1) Provision; Mandatory (M) or Optional (O).
- 2) Representation; Integer (l), bit (b), 2 bits (2b), Octet (o), 7 octets (7o), 2-12 octets (2-12o)
- 3) Dependent on the TP-DCS

Layout of SMS-DELIVER:

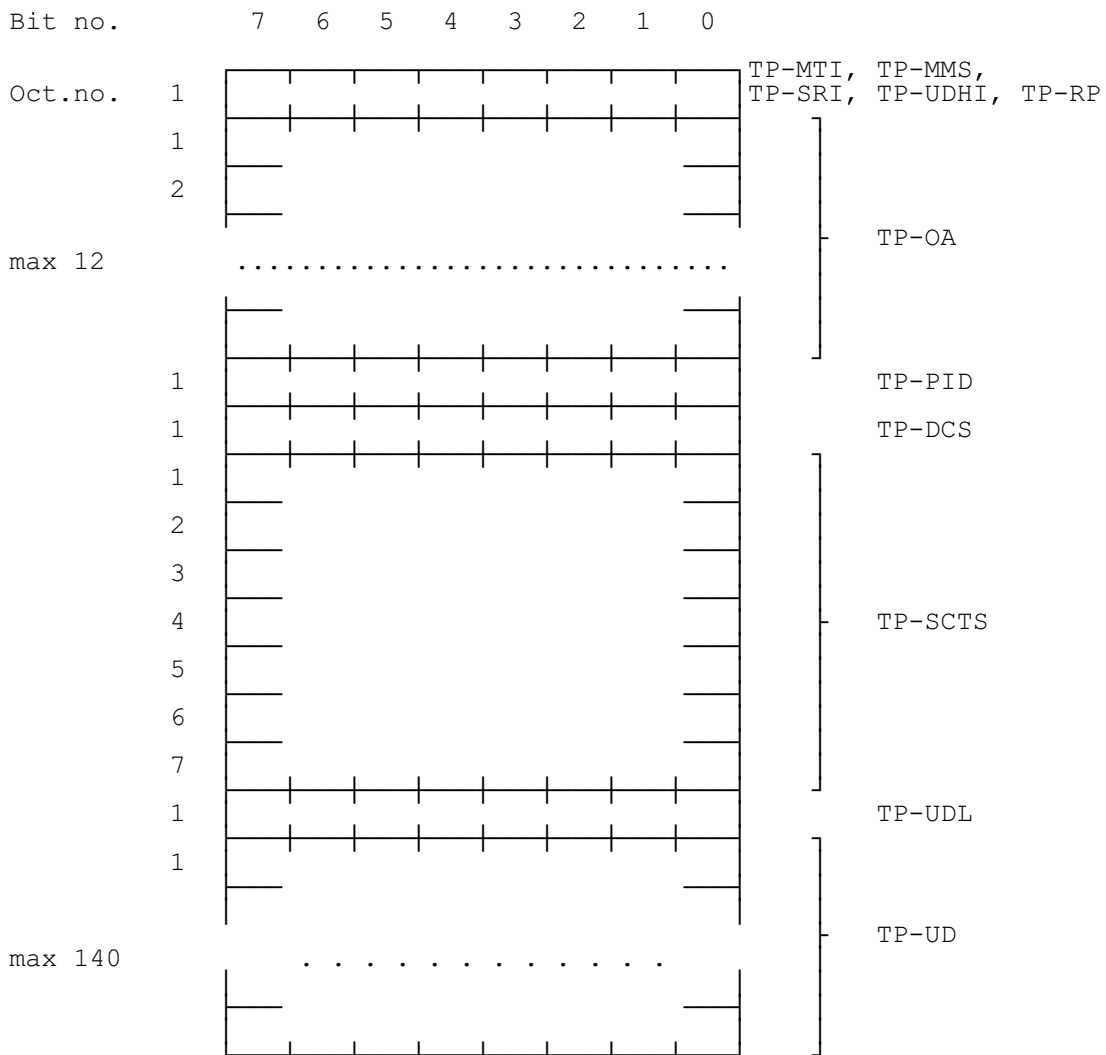

NOTE: Any unused bits will be set to zero by the sending entity and will be ignored by the receiving entity.

9.2.2.1a SMS-DELIVER-REPORT type

Basic elements of the SMS-DELIVER-REPORT type:

Abbr.	Reference	p1)	p2)	Description
TP-MTI	TP-Message-Type-Indicator	M	2b	Parameter describing the message type
TP-FCS	TP-Failure-Cause	M	I	Parameter indicating the reason for SMS-DELIVER failure

- 1) Provision: Mandatory (M) or Optional (O)
- 2) Representation: Integer (I), bit (b), 2bits (2b), octet (o)

Layout of SMS-DELIVER-REPORT:

Bit no.		7	6	5	4	3	2	1	0	
Oct. No.	1									TP-MTI
	1									TP-FCS

The SMS-DELIVER-REPORT TPDU is carried as a RP-User-Data element within a RP-ERROR PDU, and is part of a negative acknowledgement to a SMS-DELIVER or SMS-STATUS-REPORT.

Bits 7 - 2 in octet 1 are presently unused and the sender shall set them to zero. If any of these bits is non-zero, the receiver shall not examine the other field and shall treat the TP-Failure-Cause as "Unspecified error cause".

9.2.2.2 SMS-SUBMIT type

Basic elements of the SMS-SUBMIT type:

Abbr.	Reference	p1)	p2)	Description
TP-MTI	TP-Message-Type-Indicator	M	2b	Parameter describing the message type.
TP-RD	TP-Reject-Duplicates	M	b	Parameter indicating whether or not the SC shall accept an SMS-SUBMIT for an SM still held in the SC which has the same TP-MR and the same TP-DA as a previously submitted SM from the same OA
TP-VPF	TP-Validity-Period-Format	M	2b	Parameter indicating whether or not the TP-VP field is present.
TP-RP	TP-Reply-Path	M	l	Parameter indicating the request for Reply Path.
TP-UDHI	TP-User-Data-Header-Indicator	O	b	Parameter indicating that the TP-UD field contains a Header.
TP-SRR	TP-Status-Report-Request	O	b	Parameter indicating if the MS is requesting a status report.
TP-MR	TP-Message-Reference	M	l	Parameter identifying the SMS-SUBMIT.
TP-DA	TP-Destination-Address	M	2-12o	Address of the destination SME.
TP-PID	TP-Protocol-Identifier	M	o	Parameter identifying the above layer protocol, if any
TP-DCS	TP-Data-Coding-Scheme	M	l	Parameter identifying the coding scheme within the TP-User-Data.
TP-VP	TP-Validity-Period	O	o/7o	Parameter identifying the time from where the message is no longer valid.
TP-UDL	TP-User-Data-Length	M	l	Parameter indicating the length of the TP-User-Data field to follow.
TP-UD	TP-User-Data	M	3)	

1) Provision; Mandatory (M) or Optional (O).

2) Representation; Integer (l), bit (b), 2 bits (2b), Octet (o), 7 octets (7o), 2-12 octets (2-12o).

3) Dependent on the TP-DCS

Layout of SMS-SUBMIT:

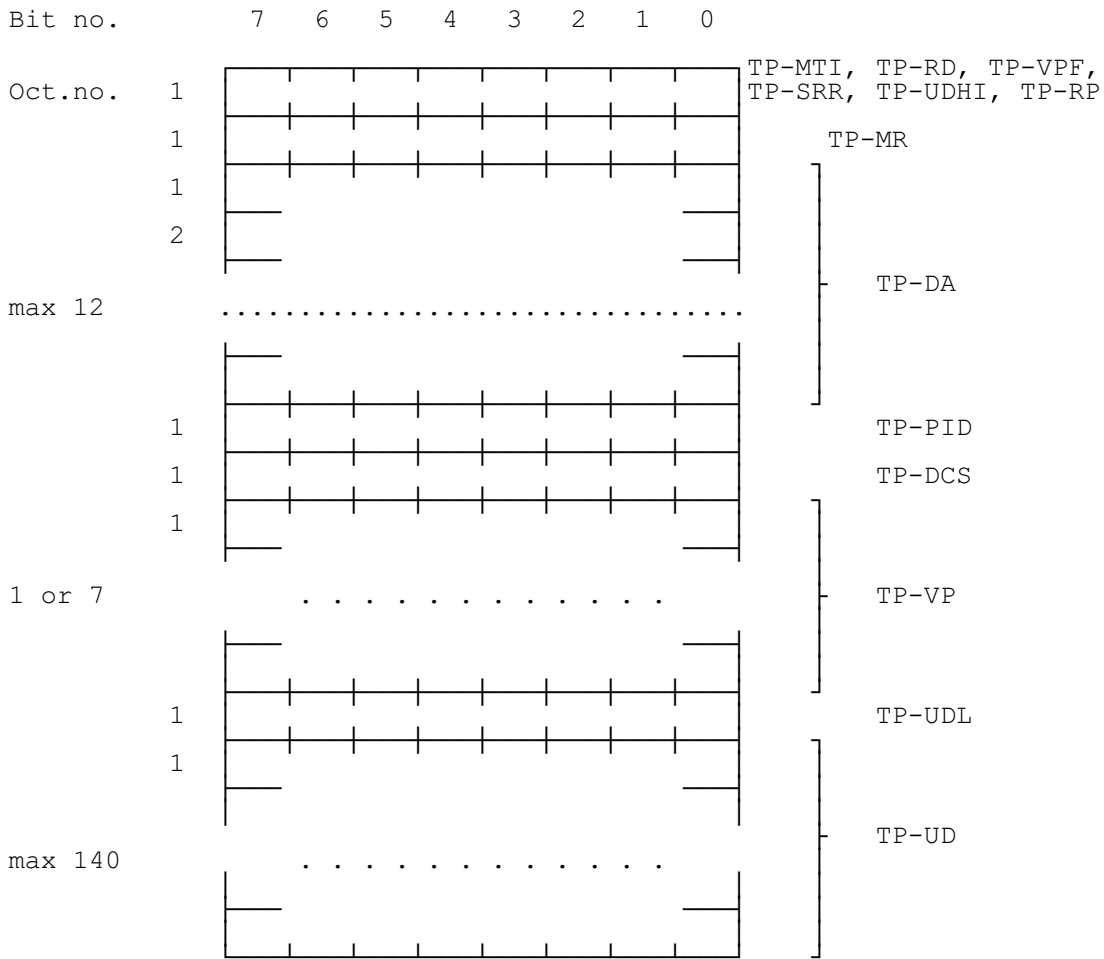

NOTE: Any unused bits will be set to zero by the sending entity and will be ignored by the receiving entity.

9.2.2.2a SMS-SUBMIT-REPORT type

Basic elements of the SMS-SUBMIT-REPORT type:

Abbr.	Reference	p1)	p2)	Description
TP-MTI	TP-Message-Type-Indicator	M	2b	Parameter describing the message type
TP-FCS	TP-Failure-Cause	M	l	Parameter indicating the reason for SMS-SUBMIT failure

- 1) Provision: Mandatory (M) or Optional (O)
- 2) Representation: Integer (l), bit (b), 2bits (2b), octet (o)

Layout of SMS-SUBMIT-REPORT:

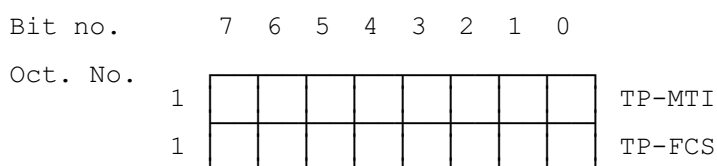

The SMS-SUBMIT-REPORT TPDU is carried as a RP-User-Data element within a RP-ERROR PDU, and is part of a negative acknowledgement to a SMS-SUBMIT or SMS-COMMAND.

Bits 7 - 2 in octet 1 are presently unused and the sender shall set them to zero. If any of these bits is non-zero, the receiver shall not examine the other field and shall treat the TP-Failure-Cause as "Unspecified error cause".

9.2.2.3 SMS-STATUS-REPORT type

Basic elements of the SMS-STATUS-REPORT type:

Abbr.	Reference	P ¹⁾	R ²⁾	Description
TP-MTI	TP-Message-Type-Indicator	M	2b	Parameter describing the message type
TP-MR	TP-Message-Reference ³⁾	M	l	Parameter identifying the previously submitted SMS-SUBMIT
TP-MMS	TP-More-Messages-to-Send	M	b	Parameter indicating whether or not there are more messages to send
TP-RA	TP-Recipient-Address	M	2-12o	Address of the recipient of the previously submitted mobile originated short message
TP-SCTS	TP-Service-Centre-Time-Stamp	M	7o	Parameter identifying time when the SC received the previously sent SMS-SUBMIT
TP-DT	TP-Discharge-Time	M	7o	Parameter identifying the time associated with a particular TP-ST outcome
TP-ST	TP-Status	M	o	Parameter identifying the status of the previously sent mobile originated short message

- 1) Provision: Mandatory (M) or Optional (O).
- 2) Representation: Integer (l), bit (b), 2 bits (2b), Octet (o), 7 octets (7o), 2-12 octets (2-12o)
- 3) Where the SMS-STATUS-REPORT is the result of an SMS-COMMAND and the TP-Command-Type was an Enquiry, the TP-MR returned in the SMS-STATUS-REPORT shall be the TP-MN which was sent in the SMS-COMMAND (i.e. the TP-MR of the previously submitted SM to which the Enquiry refers).

Layout of SMS-STATUS-REPORT:

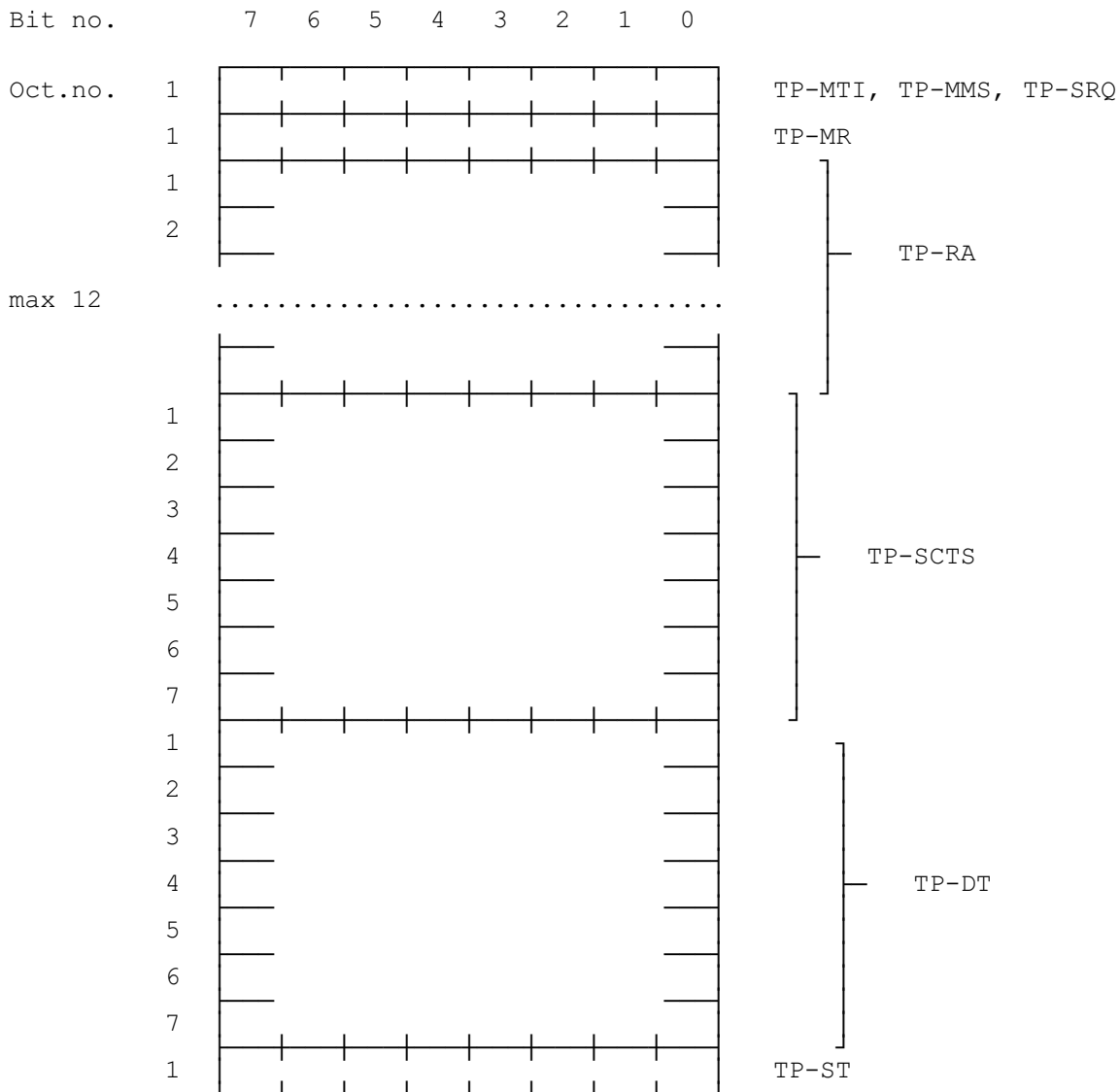

NOTE: Any unused bits will be set to zero by the sending entity and will be ignored by the receiving entity.

9.2.3 Definition of the TPDU parameters**9.2.3.1 TP-Message-Type-Indicator (TP-MTI)**

The TP-Message-Type-Indicator is a 2-bit field, located within bits no 0 and 1 of the first octet of SMS-DELIVER, SMS-SUBMIT, SMS-STATUS-REPORT or SMS-COMMAND and to be given the following values:

	bit0	bit1	Message type
Bit no 0,1:	0	0	SMS-DELIVER (in the direction SC to MS)
	0	0	SMS-DELIVER REPORT (in the direction MS to SC)
	0	1	SMS-STATUS-REPORT (in the direction SC to MS)
	0	1	SMS-COMMAND (in the direction MS to SC)
	1	0	SMS-SUBMIT (in the direction MS to SC)
	1	0	SMS-SUBMIT-REPORT (in the direction SC to MS)
	1	1	Reserved

9.2.3.2 TP-More-Messages-to-Send (TP-MMS)

The TP-More-Messages-to-Send is a 1-bit field, located within bit no 2 of the first octet of SMS-DELIVER and SMS-STATUS-REPORT, and to be given the following values:

Bit no 2:	0	More messages are waiting for the MS in this SC
	1	No more messages are waiting for the MS in this SC

NOTE: In the case of SMS-STATUS-REPORT this parameter refers to messages waiting for the mobile to which the status report is sent. The term message in this context refers to SMS-messages or status reports.

9.2.3.3 TP-Validity-Period-Format (TP-VPF)

The TP-Validity-Period-Format is a 2-bit field, located within bit no 3 and 4 of the first octet of SMS-SUBMIT, and to be given the following values:

	bit3	bit4	
Bit no 3,4:	0	0	TP-VP field not present
	0	1	TP-VP field present and integer represented (relative)
	1	0	Reserved
	1	1	TP-VP field present and semi-octet represented (absolute)

Any reserved values may be rejected by the SC.

9.2.3.4 TP-Status-Report-Indication (TP-SRI)

The TP-Status-Report-Indication is a 1-bit field, located within bit no. 5 of the first octet of SMS-DELIVER, and to be given the following values:

Bit no. 5:	0	A status report will not be returned to the SME
	1	A status report will be returned to the SME

9.2.3.5 TP-Status-Report-Request (TP-SRR)

The TP-Status-Report-Request is a 1-bit field, located within bit no. 5 of the first octet of SMS-SUBMIT and SMS-COMMAND, and to be given the following values:

Bit no. 5:	0	A status report is not requested
	1	A status report is requested

9.2.3.6 TP-Message-Reference (TP-MR)

The TP-Message-Reference field gives an integer representation of a reference number of the SMS-SUBMIT or SMS-COMMAND submitted to the SC by the MS. The MS increments TP-Message-Reference by 1 for each SMS-SUBMIT or SMS-COMMAND being submitted. The value to be used for each SMS-SUBMIT is obtained by reading the Last-Used-TP-MR value from the SMS Status data field in the SIM (see TS GSM 11.11) and incrementing this value by 1. After each SMS-SUBMIT has been submitted to the network, the Last-Used-TP-MR value in the SIM is updated with the TP-MR that was used in the SMS-SUBMIT operation. The reference number may possess values in the range 0 to 255. The value in the TP-MR assigned by the MS is the same value which is received at the SC.

In the case where no acknowledgement is received in response to an SMS-SUBMIT or SMS-COMMAND, then the MS may automatically repeat the SMS-SUBMIT or SMS-COMMAND but must use the same TP-MR value. The number of times the MS may repeat the SMS-SUBMIT or SMS-COMMAND is an implementation matter.

If all automatic attempts fail (including the case where no automatic repeat is provided), the user shall be informed. The failed message shall be stored in the mobile in such a way that the user can request a retransmission using the same TP-MR value, without needing to re-enter any information. Such storage need only be provided for a single failed message, the one most recently attempted.

The SC may discard an SMS-SUBMIT or SMS-COMMAND which has the same TP-MR value as the previous SMS-SUBMIT or SMS-COMMAND received from the same originating address.

A phase 2 or later ME using a phase 1 SIM cannot read or update the TP-Message-Reference from/to the SIM, and so the ME shall always retain the Last-Used-TP-MR value in its own memory, to be used only in the case of a phase 1 SIM.

The SMS-STATUS-REPORT also contains a TP-Message-Reference field. The value sent to the MS will be the same as the TP-Message-Reference value generated by the MS in the earlier SMS-SUBMIT or SMS-COMMAND to which the status report relates.

9.2.3.7 TP-Originating-Address (TP-OA)

The TP-Originating-Address field is formatted according to the formatting rules of address fields.

9.2.3.8 TP-Destination-Address (TP-DA)

The TP-Destination-Address field is formatted according to the formatting rules of address fields.

9.2.3.9 TP-Protocol-Identifier (TP-PID)

The TP-Protocol-Identifier parameter serves the purposes indicated in section 3.2.3. It consists of one octet, and the bits in the octet are used as follows:

The MS will not interpret reserved or unsupported values but shall store them as received.

The SC may reject messages with a TP-Protocol-Identifier containing a reserved value or one which is not supported.

bits	usage
7 6	
0 0	Assigns bits 0..5 as defined below
0 1	Assigns bits 0..5 as defined below
1 0	reserved
1 1	Assigns bits 0-5 for SC specific use

In the case where bit 7 = 0 and bit 6 = 0,
bit 5 indicates telematic interworking:
value = 0 : no interworking, but SME-to-SME protocol
value = 1 : telematic interworking

In the case of telematic interworking, the following five bit patterns in bits 4..0 are used to indicate different types of telematic devices:

4...0	
00000	implicit - device type is specific to this SC, or can be concluded on the basis of the address
00001	telex (or teletex reduced to telex format)
00010	group 3 telefax
00011	group 4 telefax
00100	voice telephone (i.e. conversion to speech)
00101	ERMES (European Radio Messaging System)
00110	National Paging system (known to the SC)
00111	Videotex (T.100/T.101)
01000	teletex, carrier unspecified
01001	teletex, in PSPDN
01010	teletex, in CSPDN
01011	teletex, in analog PSTN
01100	teletex, in digital ISDN
01101	UCI (Universal Computer Interface, ETSI DE/PS 3 01-3)
01110..01111	(reserved, 2 combinations)
10000	a message handling facility (known to the SC)
10001	any public X.400-based message handling system
10010	Internet Electronic Mail
10011..10111	(reserved, 5 combinations)
11000..11110	values specific to each SC, usage based on mutual agreement between the SME and the SC (7 combinations available for each SC)
11111	A GSM mobile station. The SC converts the SM from the received TP-Data-Coding-Scheme to any data coding scheme supported by that MS (e.g. the default).

If bit 5 has value 1 in an SMS-SUBMIT PDU, it indicates that the SME is a telematic device of a type which is indicated in bits 4..0, and requests the SC to convert the SM into a form suited for that device type. If the destination network is ISDN, the SC must also select the proper service indicators for connecting to a device of that type.

If bit 5 has value 1 in an SMS-DELIVER PDU, it indicates that the SME is a telematic device of a type which is indicated in bits 4..0.

If bit 5 has value 0 in an SMS-DELIVER PDU, the value in bits 4..0 identifies the SM-AL protocol being used between the SME and the MS.

Note that for the straightforward case of simple MS-to-SC short message transfer the Protocol Identifier is set to the value 0.

In the case where bit 7 = 0, bit 6 = 1, bits 5..0 are used as defined below

5...0	
000000	Short Message Type 0
000001	Replace Short Message Type 1
000010	Replace Short Message Type 2
000011	Replace Short Message Type 3
000100	Replace Short Message Type 4
000101	Replace Short Message Type 5
000110	Replace Short Message Type 6
000111	Replace Short Message Type 7
001000..011110	Reserved
011111	Return Call Message
100000..111111	Reserved

A short message type 0 indicates that the ME must acknowledge receipt of the short message but may discard its contents.

The Replace Short Message feature is optional for the ME and the SIM but if implemented it shall be performed as described here.

For MT short messages, on receipt of a short message from the SC, the MS shall check to see if the associated Protocol Identifier contains a Replace Short Message Type code.

If such a code is present, then the MS will check the associated SC address and originating address and replace any existing stored message having the same Protocol Identifier code, SC address and originating address with the new short message and other parameter values. If there is no message to be replaced, the MS shall store the message in the normal way.

If a Replace Short Message Type code is not present then the MS will store the message in the normal way.

In MO short messages the SC reacts similarly but only the address of the originating MS or any other source is checked.

A Return Call Message indicates to the MS to inform the user that a call (e.g. a telephone call) can be established to the address specified within the TP-OA. The RP-OA contains the address of the SC as usual. The message content (if present) gives displayable information (e.g. the number of waiting voice messages). The message is handled in the same way as all other messages of the Replace Short Message Types.

9.2.3.10 TP-Data-Coding-Scheme (TP-DCS)

The TP-Data-Coding-Scheme is defined in GSM 03.38.

9.2.3.11 TP-Service-Centre-Time-Stamp (TP-SCTS)

The TP-Service-Centre-Time-Stamp field is given in semi-octet representation, and represents the local time in the following way:

	Year:	Month:	Day:	Hour:	Minute:	Second:	Time Zone
Digits: (Semi-octets)	2	2	2	2	2	2	2

The Time Zone indicates the difference, expressed in quarters of an hour, between the local time and GMT. In the first of the two semi-octets, the first bit (bit 3 of the seventh octet of the TP-Service-Centre-Time-Stamp field) represents the algebraic sign of this difference (0 : positive, 1 : negative).

The Service-Centre-Time-Stamp, and any other times coded in this format, represents the time local to the sending entity. The Time Zone code enables the receiver to calculate the equivalent time in GMT from the other semi-octets in the Service-Centre-Time-Stamp, or indicate the time zone (GMT, GMT+1H etc.), or perform other similar calculations as required by the implementation.

9.2.3.12 TP-Validity-Period

The TP-Validity-Period field is given in either integer or semi-octet representation. In the first case, the TP-Validity-Period comprises 1 octet, giving the length of the validity period, counted from when the SMS-SUBMIT is received by the SC. In the second case, the TP-Validity-Period comprises 7 octets, giving the absolute time of the validity period termination.

In the first case, the representation of time is as follows:

TP-VP value	Validity period value
0 to 143	$(\text{TP-VP} + 1) \times 5 \text{ minutes}$ (i.e. 5 minutes intervals up to 12 hours)
144 to 167	$12 \text{ hours} + ((\text{TP-VP} - 143) \times 30 \text{ minutes})$
168 to 196	$(\text{TP-VP} - 166) \times 1 \text{ day}$
197 to 255	$(\text{TP-VP} - 192) \times 1 \text{ week}$

In the second case, the representation of time is identical to the representation of the TP-Service-Centre-Time-Stamp.

9.2.3.13 TP-Discharge-Time (TP-DT)

The TP-Discharge-Time field indicates the time at which a previously submitted SMS-SUBMIT was successfully delivered to or attempted to deliver to the recipient SME or disposed of by the SC.

In the case of "transaction completed" the time shall be the time of the completion of the transaction. In the case of "SC still trying to transfer SM" the time shall be the time of the last transfer attempt. In the case of "permanent or temporary error - SC not making any more transfer attempts" the time shall be the time of either the last transfer attempt or the time at which the SC disposed of the SM according to the Status outcome in TP-ST.

The TP-Discharge-Time is given in semi-octet representation in a format identical to the TP-SCTS.

9.2.3.14 TP-Recipient-Address (TP-RA)

The TP-Recipient-Address field indicates the address of the SME that was the destination of the previously submitted mobile originated short message being subject to the status report. The field is formatted according to the formatting rules of address fields.

9.2.3.15 TP-Status (TP-ST)

The TP-Status field indicates the status of a previously submitted SMS-SUBMIT and certain SMS COMMANDS for which a Status -Report has been requested. It consists of one octet and the bits in the octet are used as follows:

The MS will not interpret any reserved values but shall store them as received.

bits	value/usage
7	0 Bits 0..6 as defined below
6...0	Indicate whether the previously submitted short message was successfully forwarded to the SME, or whether an error condition has been encountered, as follows:
	Short message transaction completed
0000000	Short message received by the SME
0000001	Short message forwarded by the SC to the SME but the SC is unable to confirm delivery
0000010	Short message replaced by the SC
	Reserved values
0000011..0001111	Reserved
0010000..0011111	Values specific to each SC
	Temporary error, SC still trying to transfer SM
0100000	Congestion
0100001	SME busy
0100010	No response from SME
0100011	Service rejected
0100100	Quality of service not available
0100101	Error in SME
0100110..0101111	Reserved
0110000..0111111	Values specific to each SC
	Permanent error, SC is not making any more transfer attempts
1000000	Remote procedure error
1000001	Incompatible destination
1000010	Connection rejected by SME
1000011	Not obtainable
1000100	Quality of service not available
1000101	No interworking available
1000110	SM Validity Period Expired
1000111	SM Deleted by originating SME
1001000	SM Deleted by SC Administration
1001001	SM does not exist (The SM may have previously existed in the SC but the SC no longer has knowledge of it or the SM may never have previously existed in the SC)
1001010..1001111	Reserved
1010000..1011111	Values specific to each SC
	Temporary error, SC is not making any more transfer attempts
1100000	Congestion
1100001	SME busy
1100010	No response from SME
1100011	Service rejected
1100100	Quality of service not available
1100101	Error in SME
1100110..1101001	Reserved

1101010..1101111	Reserved
1110000..1111111	Values specific to each SC

bits	value/usage
7	1 Bits 0..6 reserved

9.2.3.16 TP-User-Data-Length (TP-UDL)

If the TP-User-Data is coded using the default alphabet, the TP-User-Data-Length field gives an integer representation of the number of characters within the TP-User-Data field to follow.

If the TP-User-Data-Header field is included in the TP-User-Data field then the TP-User-Data-Length field still gives an integer representation of the number of septets in the entire TP-User-Data field and includes the TP-User-Data-Header field in its count.

If the TP-User-Data is coded using 8-bit data, the TP-User-Data-Length field gives an integer representation of the number of octets within the TP-User-Data field to follow.

For other Data Coding Schemes, see GSM 03.38.

9.2.3.17 TP-Reply-Path (TP-RP)

The TP-Reply-Path is a 1-bit field, located within bit no 7 of the first octet of both SMS-DELIVER and SMS-SUBMIT, and to be given the following values:

Bit no 7:	0	TP-Reply-Path parameter is not set in this SMS-SUBMIT/DELIVER
	1	TP-Reply-Path parameter is set in this SMS-SUBMIT/DELIVER

Please refer to Annex D for details about the Reply procedures.

9.2.3.18 TP-Message-Number (TP-MN)

The TP-Message-Number is an 8-bit field allowing an MS to refer uniquely to an SM in the SC which that MS has previously submitted. The TP-MN value is the TP-MR value of a previously submitted SM.

9.2.3.19 TP-Command-Type (TP-CT)

The TP-Command-Type is an 8-bit field specifying the type of operation that the SC is to perform. It has the following values:

Value	Command Description	Status Report Request Value
00000000	Enquiry relating to previously submitted short message	1
00000001	Cancel Status Report Request relating to previously submitted short message	0
00000010	Delete previously submitted Short Message	0
00000011	Enable Status Report Request relating to previously submitted short message	0
00000100..00011111	Reserved	unspecified
11100000..11111111	Values specific for each SC	1 or 0

The SC will return an RP-Error with an appropriate TP-Failure-Cause for any TP-Command value which is reserved, unsupported or invalid or the actioning of the command has failed.

The SC will return an RP-ACK if the actioning of the Command has succeeded.

A successful Enquiry will result in the SC sending a SMS-STATUS-REPORT for the SM to which the Enquiry refers. In the case where the SC has a number of SMs which have the same TP-MR, the same TP-DA and have come from the same originating address the SC will send a SMS-STATUS-REPORT for each SM.

In the case where a TP-Command is to Delete a previously submitted short message, the SC will send a Status Report indicating that the SM has been deleted if the original Submit SM request requested a status Report.

9.2.3.20 TP-Command-Data-Length (TP-CDL)

The TP-Command-Data-Length field is used to indicate the number of octets contained within the TP-Command-Data-field. If this field is set to zero, the TP-Command-Data field will not be present.

9.2.3.21 TP-Command-Data (TP-CD)

The TP-Command-Data field contains data relating to the operation requested by the MS which is to be performed at the SC. The maximum length of this field is 157 octets. The usage and provision of the optional TP-Command-Data field will be determined by the function selected by the TP-Command-Type field.

9.2.3.22 TP-Failure-Cause (TP-FCS)

The TP-Failure-Cause field is used to report the reason for failure to transfer or process a short message. It consists of a single octet used as follows:

TP-FCS Value (Hex)	Meaning	When used	
		MO	MT
00 - 7F	Reserved		
80 - 8F	TP-PID errors		
80	Telematic interworking not supported	x	
81	Short message Type 0 not supported	x	x
82	Cannot replace short message	x	x
83 - 8E	Reserved		
8F	Unspecified TP-PID error	x	x
90 - 9F	TP-DCS errors		
90	Data coding scheme (alphabet) not supported	x	
91	Message class not supported		x
92 - 9E	Reserved		
9F	Unspecified TP-DCS error	x	x
A0 - AF	TP-Command Errors		
A0	Command cannot be actioned	x	
A1	Command unsupported	x	
A2 - AE	Reserved		
AF	Unspecified TP-Command error	x	
B0	TPDU not supported	x	x
B1 - BF	Reserved		
C0	SC busy	x	
C1	No SC subscription	x	
C2	SC system failure	x	
C3	Invalid SME address	x	
C4	Destination SME barred	x	
C5	SM Rejected-Duplicate SM	x	
C6 - CF	Reserved		
D0	SIM SMS storage full		x
D1	No SMS storage capability in SIM		x
D2	Error in MS		x
D3	Memory Capacity Exceeded	x	x
D4 - DF	Reserved		
E0 - FE	Values specific to an application	x	x
FF	Unspecified error cause	x	x

NOTE: Any reserved codes which are received should be treated as an unspecified error cause.

MT and MO refer to the overall mobile terminated and mobile originated services; not the direction of transmission of TP-FCS.

9.2.3.23 TP-User-Data-Header-Indicator (TP-UDHI)

The TP-User-Data-Header-Indicator is a 1 bit field within bit 6 of the first octet of an SMS-SUBMIT and SMS-DELIVER PDU and has the following values.

Bit no. 6	0	The TP-UD field contains only the short message
	1	The beginning of the TP-UD field contains a Header in addition to the short message

9.2.3.24 TP-User Data (TP-UD)

The TP-User-Data field contains up to 140 octets of user data.

The TP-User-Data field may comprise just the short message itself or a Header in addition to the short message depending upon the setting of TP-UDHI.

Where the TP-UDHI value is set to 0 the TP-User-Data field comprises the short message only.

Where the TP-UDHI value is set to 1 the first octets of the TP-User-Data field contains a Header in the following order starting at the least significant octet of the TP-User-Data field.

FIELD	LENGTH
Length of User Data Header	1 octet
Information-Element-Identifier 'A'	1 octet
Length of Information-Element 'A'	1 octet
Information-Element 'A' Data	1 to 'n' octets
Information-Element-Identifier 'B'	1 octet
Length of Information-Element 'B'	1 octet
Information-Element 'B' Data	1 to 'n' octets
Information-Element-Identifier 'n'	1 octet
Length of Information-Element 'n'	1 octet
Information-Element 'n' Data	1 to 'n' octets

The definition of the TP-User-Data-Length field which immediately precedes the 'Length of User Data Header' is unchanged and will therefore be the total length of the TP-User-Data field including the Header, if present. (see 9.2.3.16)

The 'Length-of-Information-Element' fields shall be the integer representation of the number of octets within its associated 'Information-Element-Data' field which follows and shall not include itself in its count value.

The 'Length-of-User-Data-Header' field shall be the integer representation of the number of octets within the 'User-Data-Header' information fields which follow and shall not include itself in its count.

The Information Element Identifier octet shall be coded as follows:

VALUE (hex)	MEANING
00	Concatenated short messages
01	Special SMS Message Indication
03	Value not used to avoid misinterpretation as <LF> character
Other values	Reserved for future use

A receiving entity shall ignore any value which is not understood or supported.

The SM itself may be coded as 7 or 8 bit data.

If 7 bit data is used then padding octets (1A hex) are inserted after the last Information element data octet so that there is a multiple of 7 octets for the entire TP-UD header. This is to ensure that the SM itself starts on an octet boundary so that an earlier phase mobile will be capable of displaying the SM itself although the TP-UD Header in the TP-UD field may not be understood.

If 8 bit data is used then padding is not necessary. An earlier phase mobile will be able to display the SM itself although the TP-UD header may not be understood.

It is also possible for mobiles not wishing to support the TP-UD header to check the value of the TP-UDHI bit in the SMS-Deliver PDU and the first octet of the TP-UD field and skip to the start of the SM and ignore the TP-UD header.

9.2.3.24.1 Concatenated Short Messages

This facility allows short messages to be concatenated to form a longer message.

In the case of 8-bit data, the maximum length of the short message within the TP-UD field is 134 (140-6) octets.

In the case of 7 bit data, the maximum length of the short message within the TP-UD field is 152 (160-8) characters.

The maximum length of a concatenated short message is 38760 (255*152) characters or 34170 (255*134) octets. The Information-Element-Data field contains information set by the application in the SMS-SUBMIT so that the receiving entity is able to re-assemble the short messages in the correct order. Each concatenated short message contains a reference number which together with the originating address and Service Centre address allows the receiving entity to discriminate between concatenated short messages sent from different originating SMEs and/or SCs.

The Information-Element-Data octets shall be coded as follows.

Octet 1	Concatenated short message reference number This octet shall contain a modulo 256 counter indicating the reference number for a particular concatenated short message. This reference number shall remain constant for every short message which makes up a particular concatenated short message.
Octet 2	Maximum number of short messages in the concatenated short message. This octet shall contain a value in the range 0 to 255 indicating the total number of short messages within the concatenated short message. The value shall start at 1 and remain constant for every short message which makes up the concatenated short message. If the value is zero then the receiving entity shall ignore the whole Information Element.

Octet 3 Sequence number of the current short message.
 This octet shall contain a value in the range 0 to 255 indicating the sequence number of a particular short message within the concatenated short message. The value shall start at 1 and increment by one for every short message sent within the concatenated short message. If the value is zero or the value is greater than the value in octet 2 then the receiving entity shall ignore the whole Information Element.

9.2.3.24.2 Special SMS Message Indication

There are three levels of "Message Waiting" indication provided within this specification. The first level is to set the Protocol Identifier to "Return Call message", which indicates that a message is waiting and relies on the text of the message to supply the detail. The second level uses the Data Coding Scheme with or without Return Call Message (see GSM 03.38) to indicate the type of message waiting and whether there are some messages or no messages. The third level is described here, and provides the maximum detail level for analysis by the mobile, i.e. an indication of the number and type of messages waiting in systems connected to the PLMN. This third level is provided for future flexibility, as it cannot immediately be used without compatibility problems with the earliest phase mobiles. It is envisaged that this scheme can start to be used once mobiles supporting TP-UDH become widely available.

This information may be stored by the MS in a form other than an SMS message, for example an indicator may be shown if the number of messages is non-zero or removed if the number of messages is zero. The MS may also store actual number of messages waiting and provide some other MMI to access this information. Text may be included by the SMS Service Centre for backward compatibility with the earliest phase mobiles and the Data Coding Scheme may also be used to convey this information in parallel for backward compatibility with "middle" phase mobiles (which support the use of Data Coding Scheme for Message Waiting Indication but not the use of TP-UDH for Message Waiting Indication).

The information-Element octets shall be coded as follows:

Octet 1 Message Indication type and Storage

Bit 7 Indicates whether or not the message shall be stored.

Bit 7

0 Discard message after updating indication
 1 Store message

In the event of a conflict between this setting and the setting of the Data Coding Scheme (see TS GSM 03.38) then the message shall be stored if either the DCS indicates this, or Octet 1 above indicates this.

Bits 6..0 show the message indication type

000 0000 Voice Message Waiting
 000 0001 Fax Message Waiting
 000 0010 Electronic Mail Message Waiting
 000 0011 Other Message Waiting (see TS GSM 03.38 for definition of "other")

Other values are reserved for future use

Octet 2 Message Count

This octet shall contain a value in the range 0 to 255 indicating the number of messages of the type specified in Octet 1 waiting. The value 255 shall be taken to mean 255 or greater.

If more than one type of message is required to be indicated within one SMS message, then further octets must be used, as in the following example:

[01] Length of TP-UDH [0D]

[02] IEI = Special SMS Message Indication [01]

[03] Length = 02

[04] Octet 1 = Voice Mail, do not store [00]

[05] Octet 2 = 04 Messages

[06] IEI = Special SMS Message Indication [01]

[07] Length = 02

[08] Octet 1 = Fax Mail, Store [81]

[09] Octet 2 = 02 Messages

[10] Fill [1A]

[11] Fill [1A]

[12] Fill [1A]

[13] Fill [1A]

[14] Fill [1A]

9.2.3.25 TP-Reject-Duplicates (TP-RD)

The TP-Reject-Duplicates is a 1 bit field located within bit 2 of the first octet of SMS-SUBMIT and has the following values.

Bit no. 2:	0	Instruct the SC to accept an SMS-SUBMIT for an SM still held in the SC which has the same TP-MR and the same TP-DA as a previously submitted SM from the same OA.
	1	Instruct the SC to reject an SMS-SUBMIT for an SM still held in the SC which has the same TP-MR and the same TP-DA as the previously submitted SM from the same OA. In this case an appropriate TP-FCS value will be returned in the SMS-SUBMIT-REPORT.

9.2.3.26 TP-Status-Report-Qualifier (TP-SRQ)

The TP-Status-Report-Qualifier is a 1 bit field located within bit 5 of the first octet of SMS-STATUS-REPORT and has the following values

Bit no. 5:	0	The SMS-STATUS-REPORT is the result of a SMS-SUBMIT.
	1	The SMS-STATUS-REPORT is the result of an SMS-COMMAND e.g. an Enquiry.

9.3 Service provided by the SM-RL

9.3.1 General

The Short Message Relay Layer (SM-RL) provides a service to the Short Message Transfer Layer (SM-TL). This service enables the SM-TL to send Transfer Protocol Data Units (TPDUs) to its peer entity, receive TPDUs from its peer entity and receive reports about earlier requests for TPDUs to be transferred.

In order to keep track of TPDUs and reports about those TPDUs, primitives between the SM-TL and SM-RL contain a Short Message Identifier (SMI), which is a reference number for the TPDU associated with the primitive. This Short Message Identifier is not carried via the SM-RL protocol of section 9.3.2. It is carried via the relay layer service between the SC and GMSC. It is also carried by SM-RL of GSM 04.11, between the visited MSC and MS. The parameter is not carried by MAP but is mapped to and from the TCAP dialogue Identifier (see CCITT recommendation Q.771, "Blue Book") at the GMSC and the visited MSC (therefore the Message Identifier at the SC/GMSC interface is not the same as at the visited MSC/MS interface).

The SM-RL communicates with its peer entity by the protocol described in the following sections.

9.3.2 Protocol element repertoire at SM-RL

Different protocols are required between different pairs of SM-RL entities. Those are described in other GSM specifications. This section gives a survey of the different information elements which have to be conveyed between those entities. (Note that the notation of the protocol and information elements may vary between different GSM specifications).

The SM-RL comprises the following 6 protocol elements:

RP-MO-DATA	for transferring a TPDU from MS to SC
RP-MT-DATA	for transferring a TPDU from SC to MS
RP-ACK	for acknowledging an RP-MO-DATA, an RP-MT-DATA or an RP-SM-MEMORY-AVAILABLE
RP-ERROR	for informing of an unsuccessful RP-MO-DATA or an RP-MT-DATA transfer attempt
RP-ALERT-SC	for alerting the SC that the MS has recovered operation (information sent from the HLR to the SC)
RP-SM-MEMORY-AVAILABLE	for notifying the network that the MS has memory available to accept one or more short messages (information sent from the MS to the HLR)

9.3.2.1 RP-MO-DATA

Basic elements of the RP-MO-DATA type.

Abbr.	Reference	p1)	Description
RP-OA	RP-Originating-Address	++-	Address of the originating MS.
RP-DA	RP-Destination-Address	-++	Address of the destination SC.
RP-UD	RP-User-Data	+++	Parameter containing the TPDU

- 1) Provision on the links SC<->MSC, MSC<->MSC and MSC<->MS indicated by 'xxx', where x may be either '+' or '-', dependent on whether the parameter is mandatory or not on the respective link.

9.3.2.2 RP-MT-DATA

Basic elements of the RP-MT-DATA type.

Abbr.	Reference	P1)	Description
RP-PRI	RP-Priority-Request	+-	Parameter indicating whether or not the short message transfer should be stopped if the originator SC address is already contained in the MWD.
RP-MMS	RP-More-Messages-To-Send	OO-	Parameter indicating that there are more messages waiting in the SC
RP-OA	RP-Originating-Address	+++	Address of the originating SC.
RP-DA	RP-Destination-Address	+-	Address of the destination MS.
RP-UD	RP-User-Data	+++	Parameter containing the TPDU

- 1) Provision on the links SC<->MSC, MSC<->MSC and MSC<->MS indicated by 'xxx', where x may be '+', '-' or 'O', dependent on whether the parameter is mandatory, not present or optional on the respective link.

9.3.2.3 RP-ACK

The RP-ACK does not contain any specific information elements.

9.3.2.4 RP-ERROR

Basic elements of the RP-ERROR type.

Abbr.	Reference	P1)	Description
RP-MSI	RP-MW-Set-Indication	+-	Parameter indicating whether or not the MWI has been up-dated. 2)
RP-CS	RP-Cause	+++	Parameter identifying the error type. The RP-Cause parameter gives the reason why a short message transfer attempt fails. In practice three relay layer protocols are used - SC to GMSC/IW MSC (see GSM 03.47), MAP (see GSM 09.02) and via the radio interface (see GSM 04.11)
RP-MSIsdn	RP-international--MS-ISDN-number	+-	MSIsdn-Alert of the MS, see section 3.2.7 2)
RP-UD	RP-User-Data	- - -	Parameter containing a TPDU

- 1) Provision on the links SC<->MSC, MSC<->MSC and MSC<->MS indicated by 'xxx', where x may be either '+' or '-', dependent on whether the parameter is mandatory or not on the respective link.
- 2) Only present when the RP-ERROR is transferred from the SMS-IW MSC to the SC.

9.3.2.5 RP-ALERT-SC

Basic elements of the RP-ALERT-SC type:

Abbr.	Reference	p1)	Description
RP-MSIsdn	RP-International-MS-ISDN-Number	M	MSIsdn of the MS.

- 1) Provision; Mandatory (M).

9.3.2.6 RP-SM-MEMORY-AVAILABLE

Basic elements of the RP-SM-MEMORY-AVAILABLE type:

Abbr.	Reference	p1)	Description
RP-IMSI	RP-International-Mobile-Subscriber-Identity	++-	IMSI of the MS.

- 1) Provision on the links HLR<->VLR, VLR<->MSC and MSC<->MS indicated by 'xxx', where x may be either '+' or '-', dependent on whether the parameter is mandatory or not present on the respective link.

10 Fundamental procedures within the point-to-point SMS

The point-to-point SMS comprises 3 fundamental procedures:

- 1) Short message mobile terminated. This procedure consists of all necessary operations to:
 - a) transfer a short message or status report from the SC to the MS
 - b) return a report to the SC, containing the result of the message transfer attempt.
- 2) Short message mobile originated. This procedure consists of all necessary operations to:
 - a) transfer a short message from the MS to the SC
 - b) return a report to the MS, containing the result of the message transfer attempt.
- 3) Transfer of an Alert. This procedure consists of all necessary operations for an HLR or a VLR to initiate a transfer of an Alert to a specific SC, informing the SC that the MS has recovered operation.

GSM 09.02 defines operations necessary for the provision of the Short Message Service point-to-point. The operations defined in section 10 describe the requirement that the Short Message Service puts upon the network functionality. If discrepancies exist in nomenclature, it is the GSM 09.02 that will be the reference.

Annex C indicates the flow of primitives and parameters during the short message transfer between the SC and the MS. Both the Mobile terminated and the Mobile originated cases are covered.

10.1 Short message mobile terminated

The entities involved in this procedure are depicted in Figure 03.40/14.

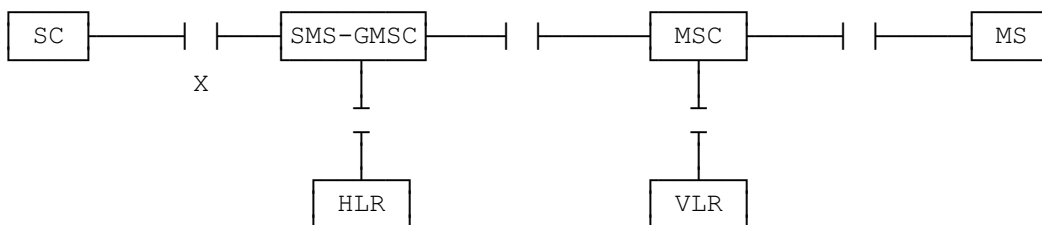

Figure 03.40/14: Interfaces involved in the Short message mobile terminated procedure. GSM 03.02. X is the interface between an MSC and an SC as defined in section 5.

NOTE: Since the short message mobile terminated procedure covers the functionality required at SM-RL for transferring TPDUs from SC to MS, the procedure described covers both short message (SMS-DELIVER) and status report (SMS-STATUS-REPORT) transfer. The term "short message transfer" therefore, in this section, covers both cases.

In Figure 03.40/15, sequence diagrams are shown for the following basic situations of short message mobile terminated transfer attempt:

- Successful short message transfer;
- Short message transfer attempt failing due to error at the SMS-GMSC;
- Short message transfer attempt failing due to negative outcome of HLR information retrieval;
- Short message transfer attempt failing due to error at the MSC;
- Short message transfer attempt failing due to negative outcome of VLR information retrieval;
- Short message transfer attempt failing due to erroneous message transfer on the radio path.

References to the relevant specifications of the different operations are given in section 4.

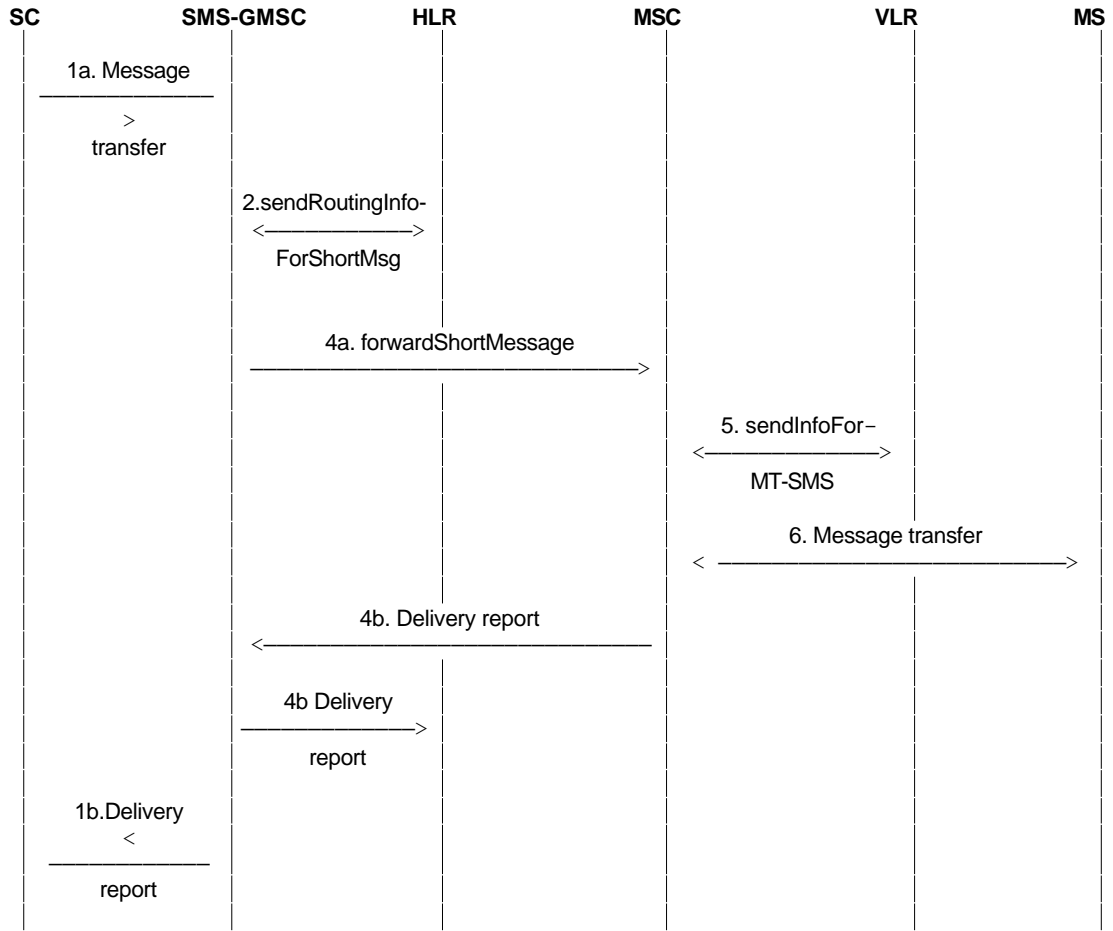

-----> : Operation invocation or message transfer.
 <-----> : Successful operation invocation or message transfer including report.

Figure 03.40/15a): Successful short message transfer attempt.

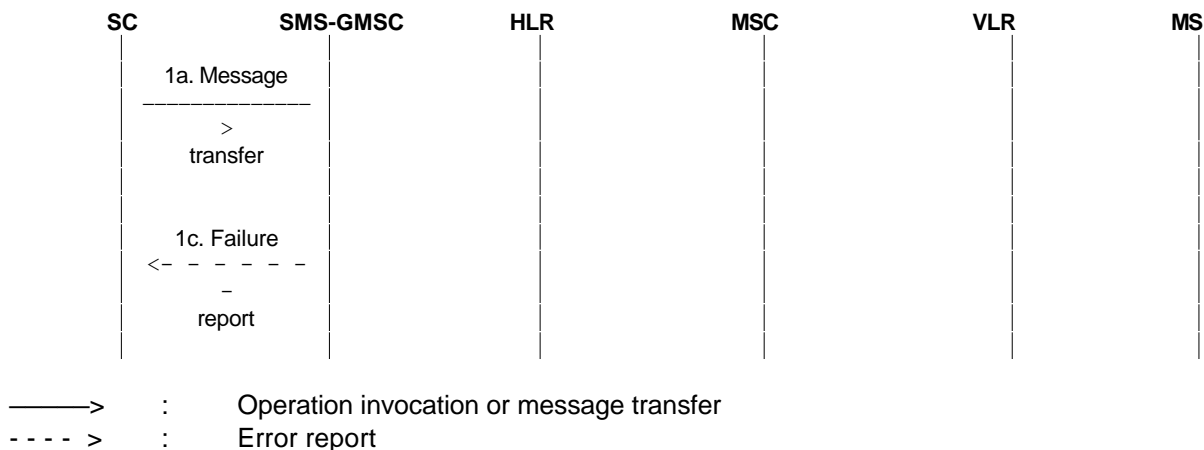

Figure 03.40/15b): Short message transfer attempt failing due to error at the SMS-GMSC.

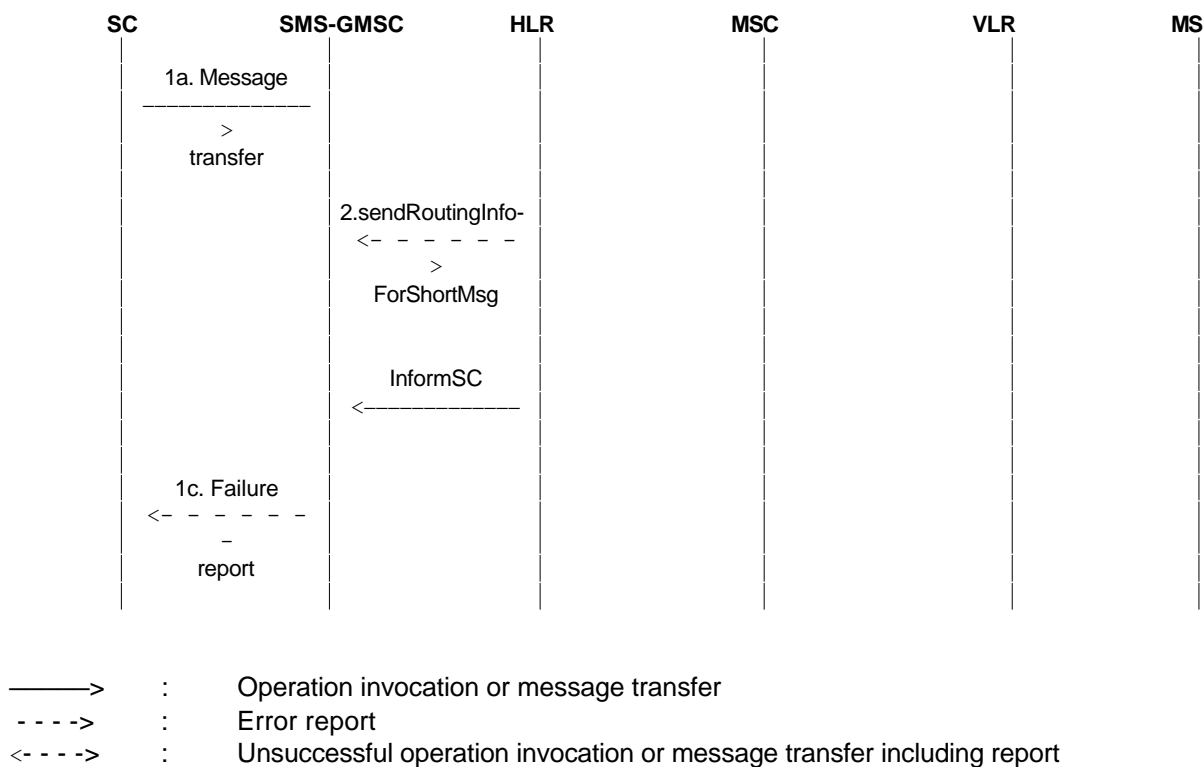
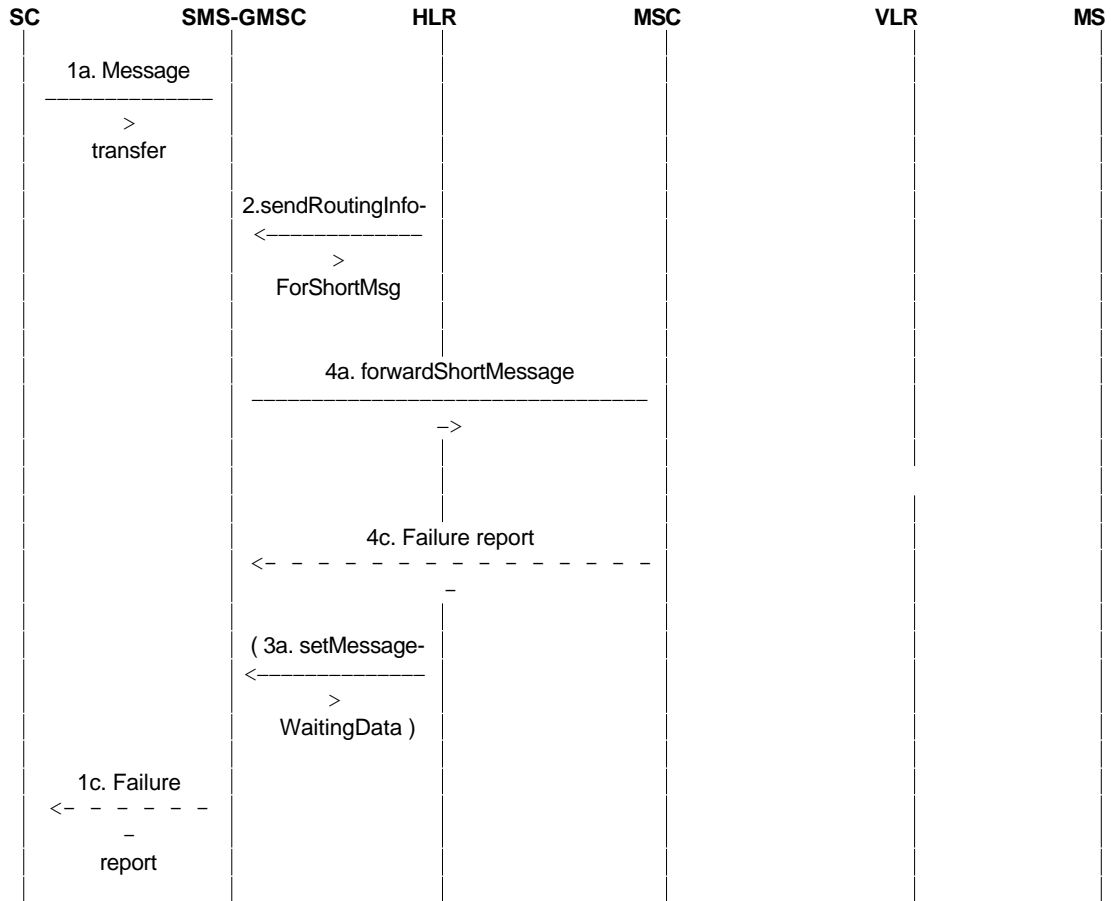
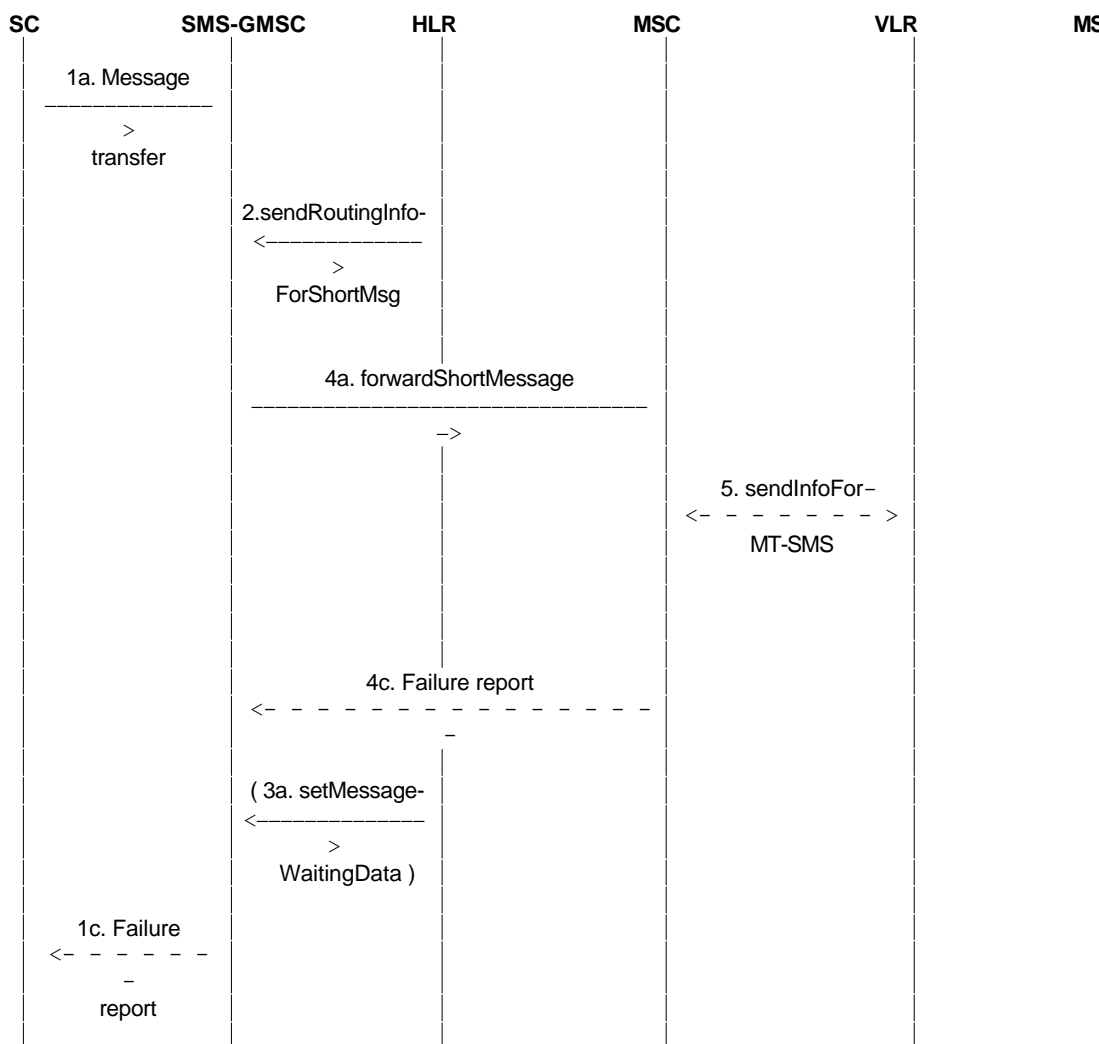

Figure 03.40/15c): Short message transfer attempt failing due to negative outcome of HLR information retrieval.



- > : Operation invocation or message transfer
- <———> : Successful operation invocation or message transfer including report
- - - -> : Error report
- <- - - -> : Unsuccessful operation invocation or message transfer including error report (or with missing confirmation)

Figure 03.40/15d): Short message transfer attempt failing due to error at the MSC.



- > : Operation invocation or message transfer
- <——> : Successful operation invocation or message transfer including report
- - - -> : Error report
- <- - - -> : Unsuccessful operation invocation or message transfer incl. error report (or with missing confirmation)

Figure 03.40/15e): Short message transfer attempt failing due to negative outcome of VLR information retrieval.

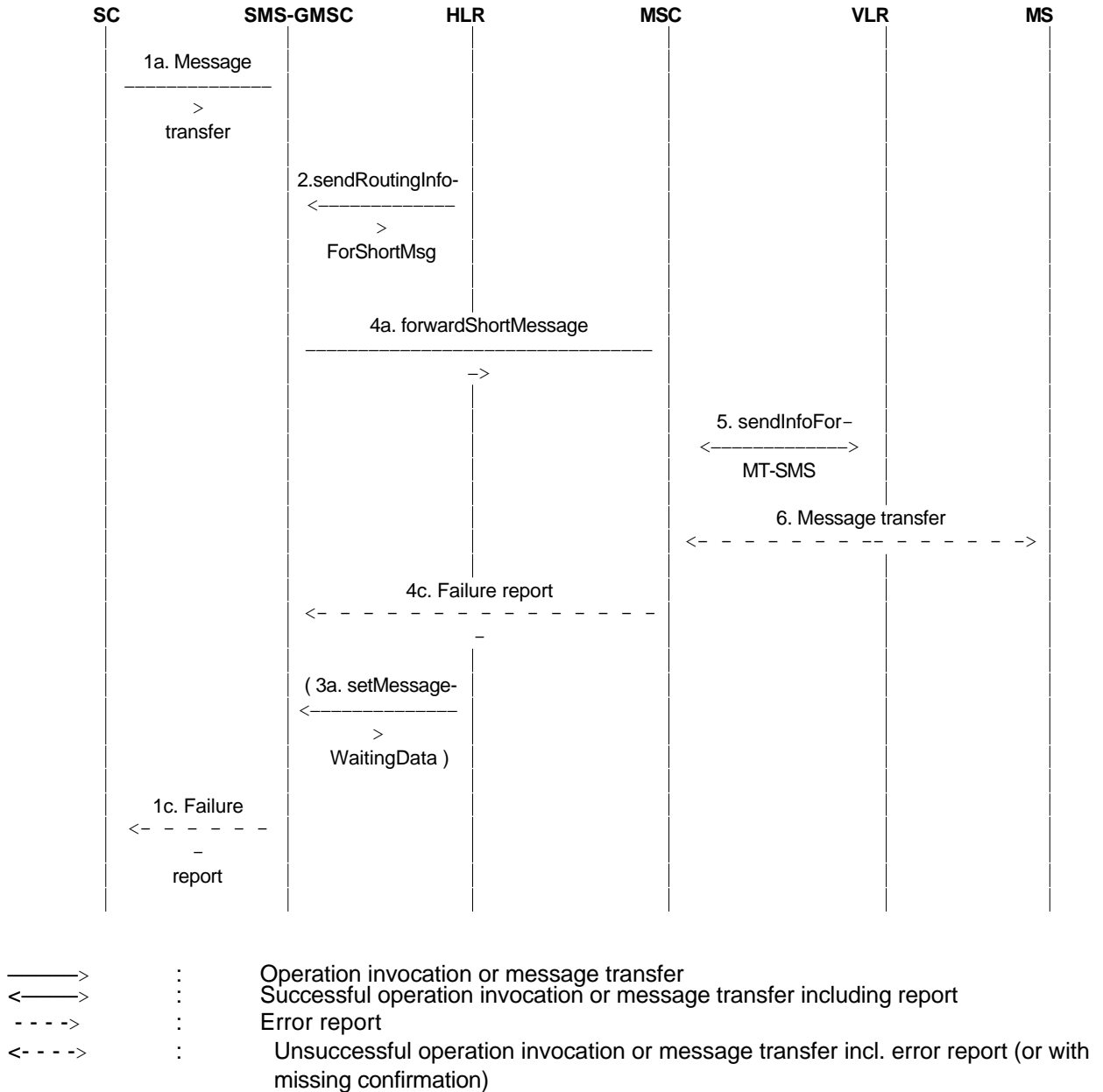

Figure 03.40/15f): Short message transfer attempt failing due to erroneous message transfer on the radio path.

Operation 1: Message transfer SC -> SMS-GMSC

This operation is used to transfer a short message from an SC to an SMS-GMSC.

The operation consists of:

- the transfer of a message containing the TPDU from the SC to the SMS-GMSC (see '1a. Message transfer' in Figure 03.40/15); and
- the return of either a 'Failure report' (see 1c. in Figure 03.40/15) or a 'Delivery report' (see 1b. in Figure 03.40/15).

'Failure report' is returned to the SC when the SMS-GMSC has received indication from another entity (MSC or HLR) the procedure was unsuccessful. The error indications which the SMS-GMSC may receive from the MSC, HLR, VLR or MS enable the SMS-GMSC to return one of the error indications given in section 3.3 back to the SC.

Operation 2: sendRoutingInfoForShortMsg

The operation is an interrogation of the HLR by the SMS-GMSC to retrieve information necessary to forward the short message.

Operation 3: setMessageWaitingData

The operation provides a means for the SMS-GMSC to request the HLR to add an SC address to the MWD, and is activated when the SMS-GMSC receives an absent subscriber indication from the MSC or when the SMS-GMSC receives a failure report for a short message transfer with cause MS Memory Capacity Exceeded. The Return Result optionally contains the MSIsdn-Alert.

The operation consists of:

- the transfer of a message, containing the MSISDN of the MS to which the short message was addressed, the SC-address and the cause (Absent Subscriber or MS memory capacity exceeded) for setting the MWD, from the SMS-GMSC to the HLR (see 3. in figure 03.40/15).

Operation 4: forwardShortMessage

The operation provides a means for the SMS-GMSC to transfer a short message to the MSC at which the MS is currently located.

The operation works in tandem with the forwarding of the short message from the MSC to the MS. Thus, the outcome of the operation comprises either success, i.e. that the message has been delivered to the MS; or a failure that may be caused by several reasons, e.g. failure in the transfer SMS-GMSC -> MSC, MS being detached, or no paging response.

Operation 5: sendInfoForMT-SMS

The operation provides a means for the MSC to retrieve subscriber information from VLR for mobile terminated short message transfer. The operation may be associated with an authentication procedure, as shown in Figure 03.40/16. Unsuccessful retrieval (e.g. absent subscriber) is indicated by a cause indication to the SMS-GMSC.

An overall depiction of how operation 5 interacts with signalling on the radio path is given in Figure 03.40/16.

It should be noted that the MNRF setting is implicitly carried out when the message transfer is denied due to IMSI DETACH.

Operation 6: Message transfer MSC -> MS

The operation is used to transfer a short message from the MSC to the MS.

If the transfer is not successful, e.g. due to the MS losing radio coverage after having successfully authenticated, a failure report (RP-ERROR) is returned to the SMS-GMSC. In this case, MWD and MCEF will be updated only for the case where the transfer fails with cause MS Memory Capacity Exceeded.

If the MS notifies the network that the MS has been unable to accept a short message because its memory capacity has been exceeded, then the ME will set the memory capacity Exceeded Notification flag if present.

Operation 7: InformSC

The operation is used to transfer the MSIsdn-Alert from the HLR to the SMS-GMSC in case of the error Absent Subscriber given as an answer to the operation SendRoutingInfoForSM.

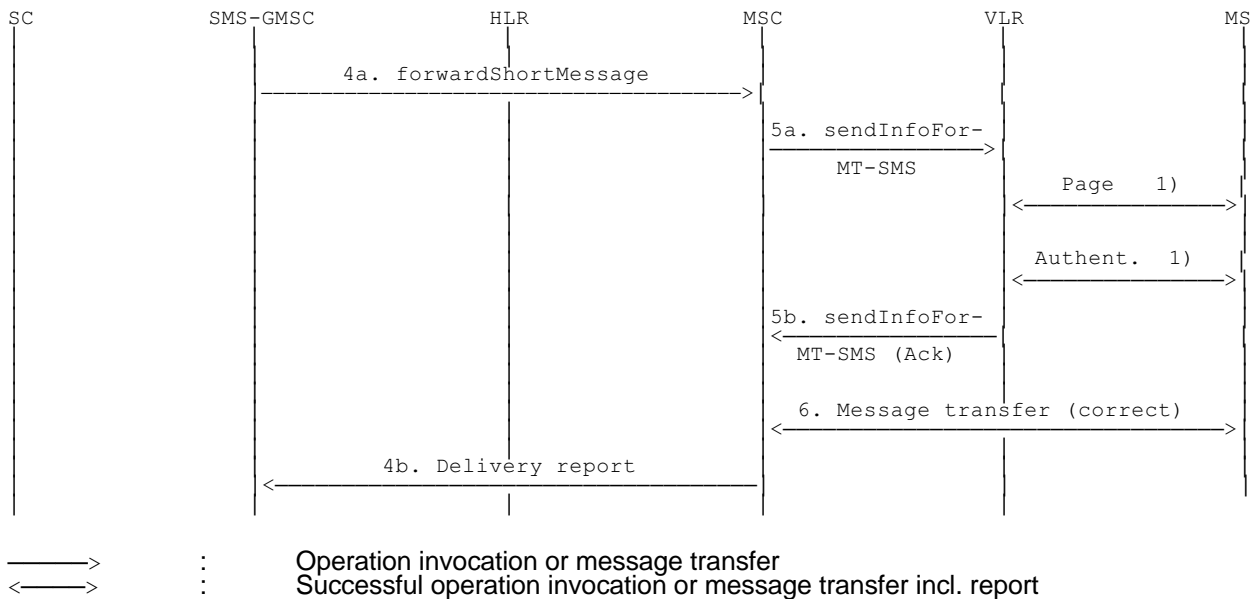

References:

- 1) : Described in GSM 04.08 and GSM 09.02

Figure 03.40/16a): 'Send information for MT SMS' procedure; error free case.

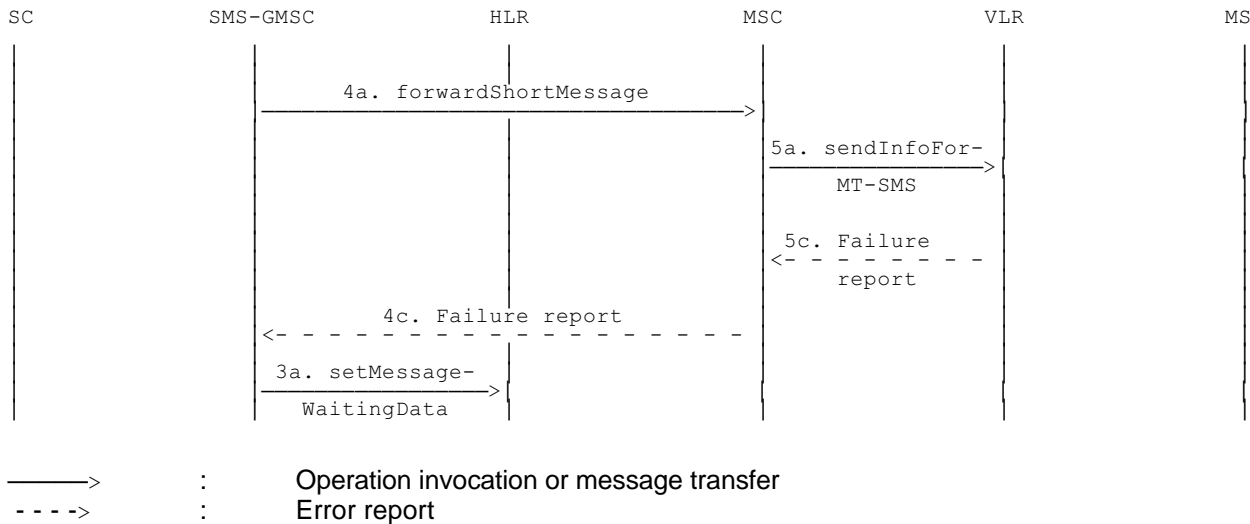
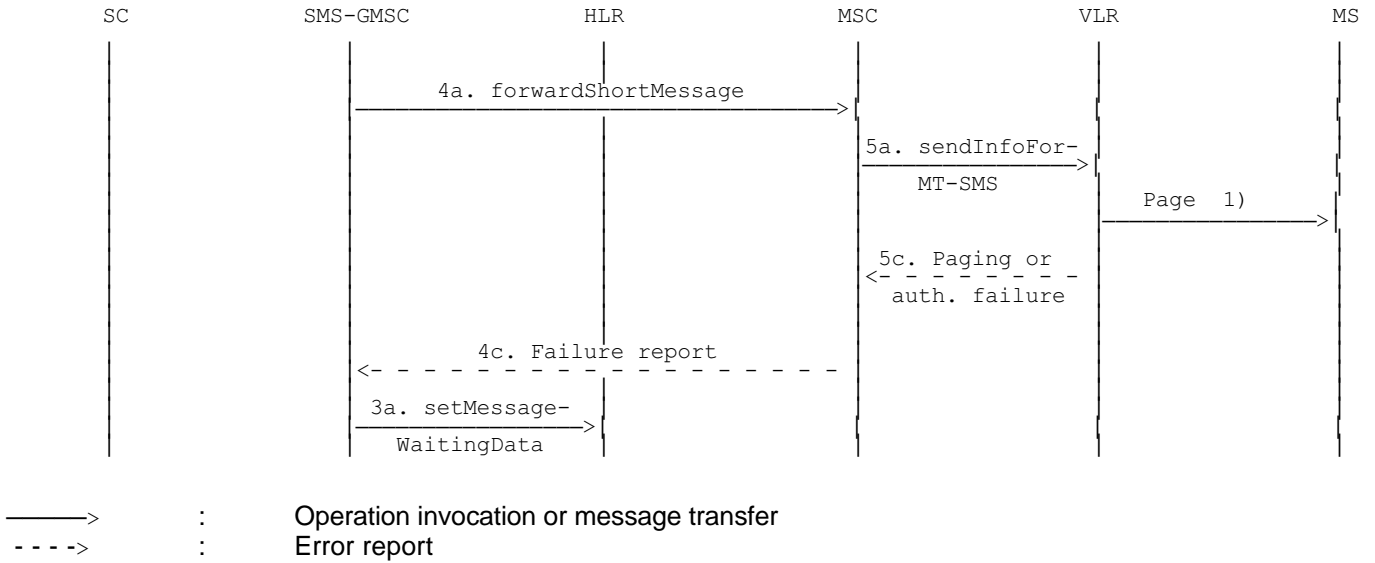

Figure 03.40/16b): 'Send information for MT SMS' procedure; erroneous case: absent subscriber (e.g. IMSI DETACH).



References:

1) : Described in GSM 04.08 and GSM 09.02

Figure 03.40/16c): 'Send information for MT SMS' procedure; erroneous case: Absent subscriber (e.g. no paging response).

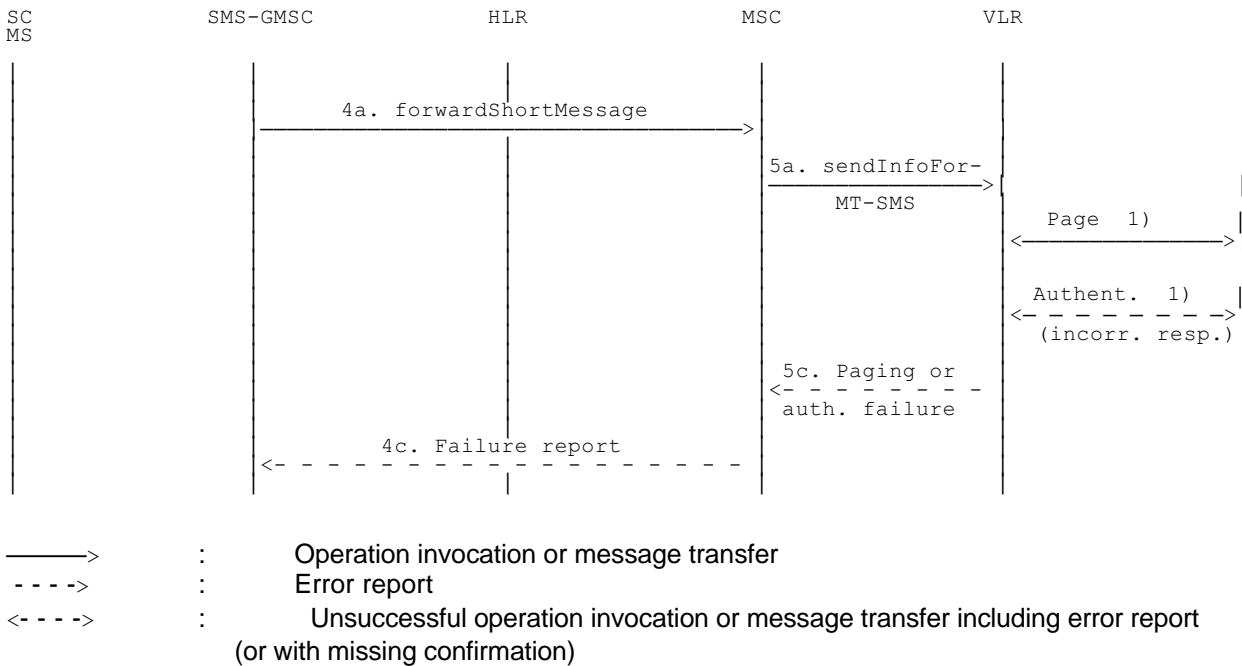

References:

1) : Described in GSM 04.08 and GSM 09.02

Figure 03.40/16d): 'Send information for MT SMS' procedure; incorrect authentication.

10.2 Short message mobile originated

The entities involved in this procedure is depicted in Figure 03.40/17.

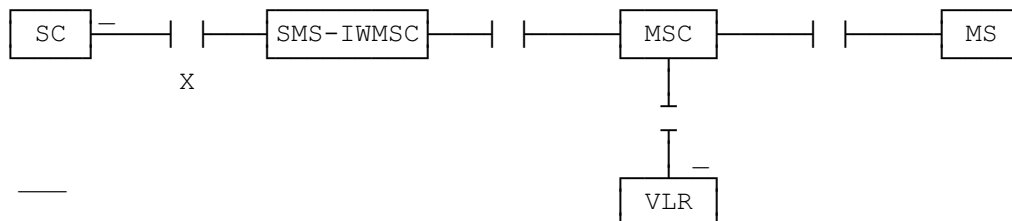

Figure 03.40/17: Interfaces involved in the Short message mobile originated procedure. GSM 03.02. X is the interface between an MSC and an SC as defined in chapter 5.

Note that since the short message mobile originated procedure covers the functionality required at SM-RL for transferring TPDUs from SC to MS, the procedure described covers both short message (SMS-SUBMIT) and command (SMS-COMMAND) transfer. The term "short message transfer" therefore in this section, covers both cases.

In Figure 03.40/18, sequence diagrams for the following basic situations of short message mobile terminated transfer attempt:

- Successful short message transfer;
- Short message transfer attempt failing due to error at the MSC;
- Short message transfer attempt failing due to negative outcome of VLR information retrieval;
- Short message transfer attempt failing due to error at the SMS-IWMSC;
- Short message transfer attempt failing due to error at the SC.

References to the relevant specifications of the different operations are given in section 4.

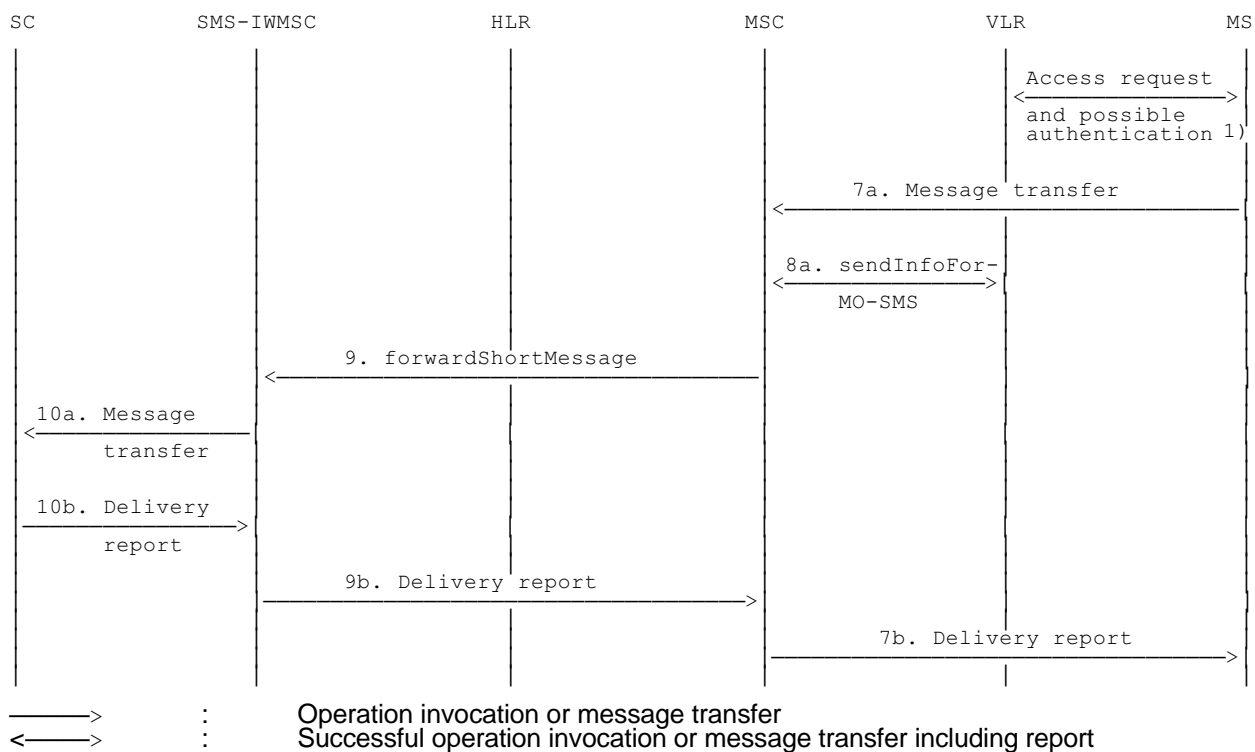

References:

1) : Described in GSM 04.08 and GSM 09.02

Figure 03.40/18a): Successful short message transfer attempt.

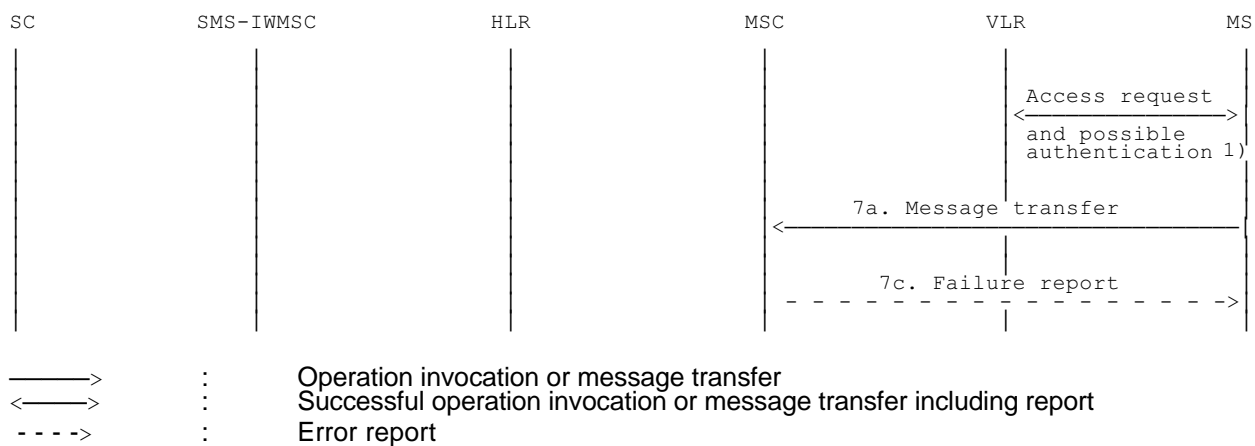

References:

1) : Described in GSM 04.08 and GSM 09.02

Figure 03.40/18b): Short message transfer attempt failing due to error at the MSC.

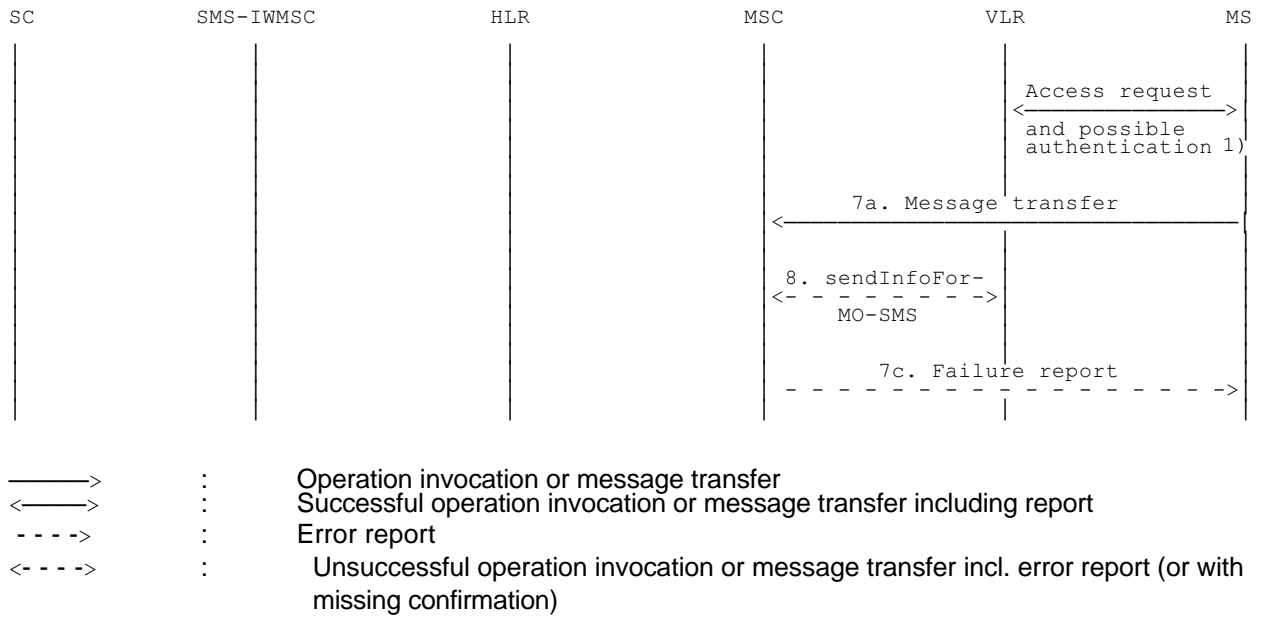

References:

1) : Described in GSM 04.08 and GSM 09.02

Figure 03.40/18c): Short message transfer attempt failing due to negative outcome of VLR information retrieval.

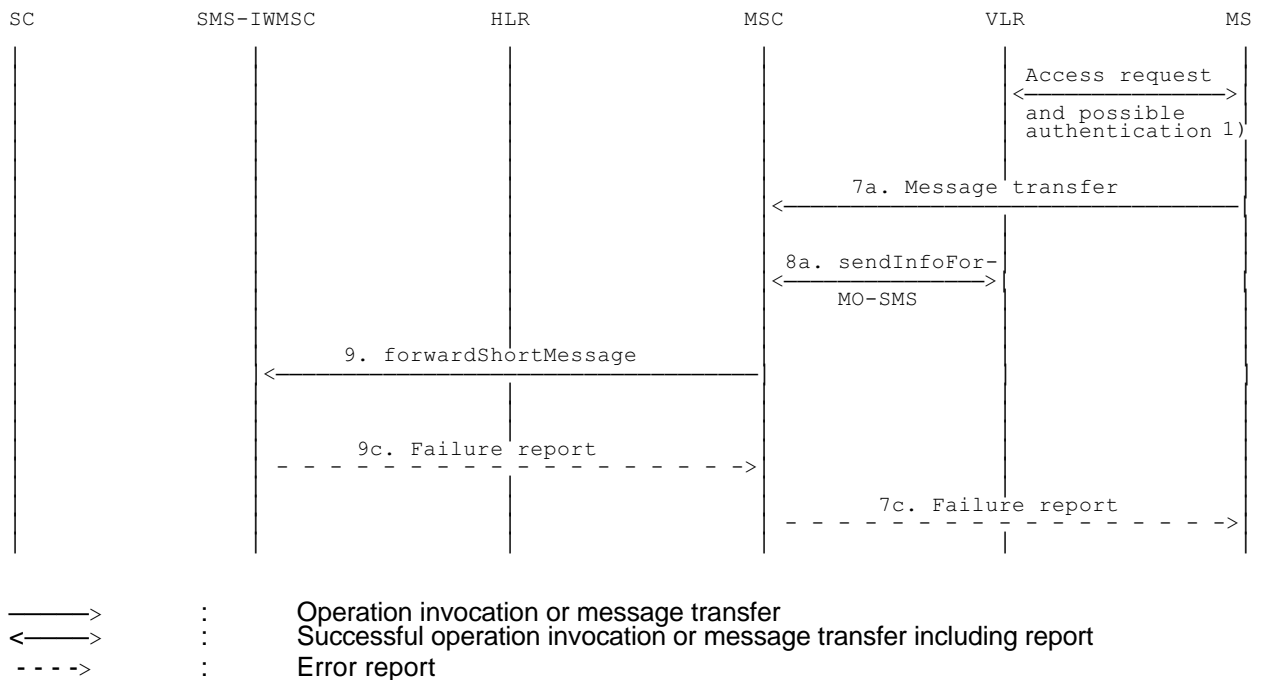

References:

1) : Described in GSM 04.08 and GSM 09.02

Figure 03.40/18d): Short message transfer attempt failing due to error at the SMS-IWMSC.

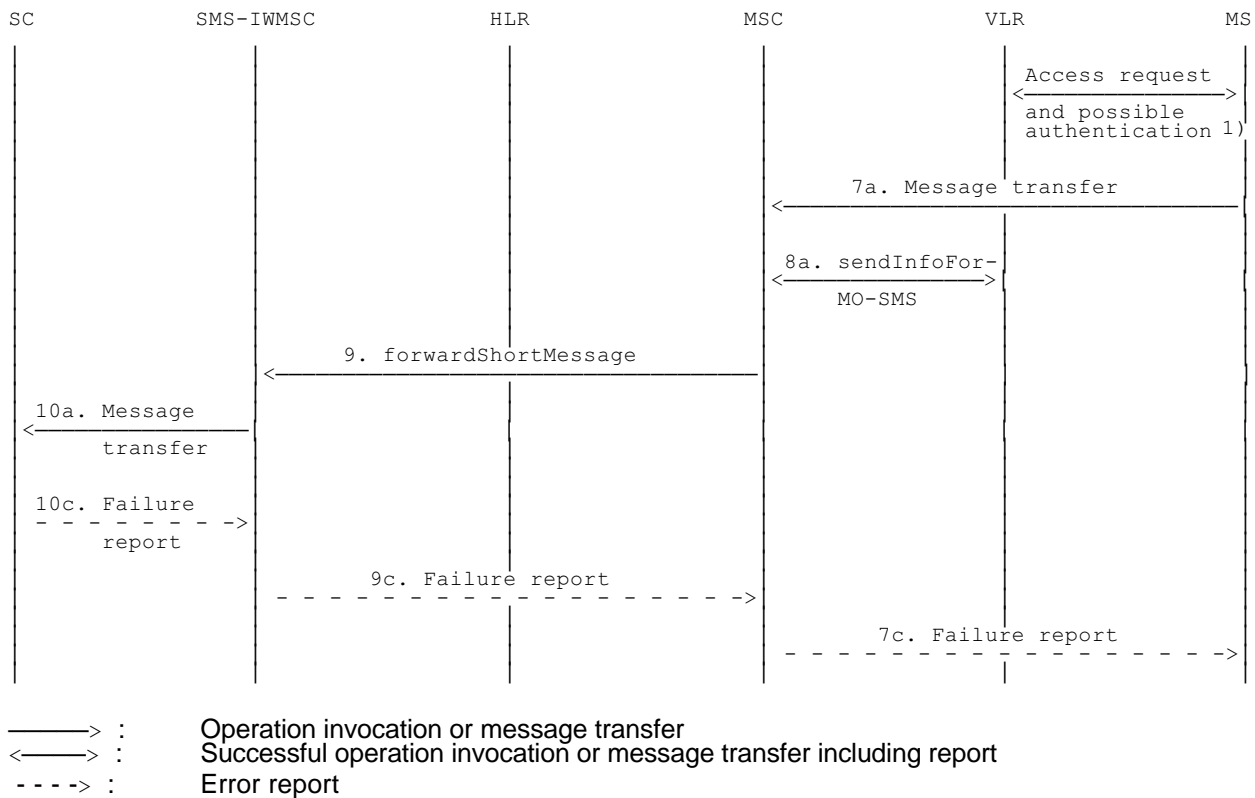

References:

- 1) : Described in GSM 04.08 and GSM 09.02.

Figure 03.40/18e): Short message transfer attempt failing due to error at the SC.

Operation 7: Message transfer MS -> MSC

The operation is used to transfer a short message from the MS to the MSC.

Operation 8: sendInfoForMO-SMS

The operation provides a means for the MSC to verify from the VLR that the mobile originated short message transfer does not violate supplementary services invoked or restrictions imposed using the network feature Operator Determined Barring.

A successful VLR response carries the MSIsdn of the originating MS being transferred to the SC at SM-RL.

Operation 9: forwardShortMessage

The operation provides a means for the MSC to transfer a short message to the SMS-IWMSC.

The procedure is required if the serving MSC cannot access the SC directly, e.g. because it has no connection to SC (see section 5).

The procedure works in tandem with the forwarding of the short message from the SMS-IWMSC to the SC. Thus, the outcome of the operation comprises either success, i.e. that the message has been delivered to the SC; or a failure that may be caused by several reasons, e.g. failure in the transfer MSC --> SMS-IWMSC, SC does not comply.

Operation 10: Message transfer SMS-IWMSC -> SC

The operation is used to transfer a short message from an SMS-IWMSC to an SC, and consists of

- the transfer of a message containing the TPDU from the SMS-IWMSC to the SC (see '8a. Message transfer' in Figure 03.40/18); and
- the return of either a 'Failure report' (see 8c. in Figure 03.40/18) or a 'Delivery report' (see 8b. in Figure 03.40/18).

'Failure report' is returned to the MS when the SMS-IWMSC has received indication from the network or the SC that the procedure was unsuccessful.

10.3 Alert transfer

The entities involved in this procedure are depicted in Figure 03.40/19.

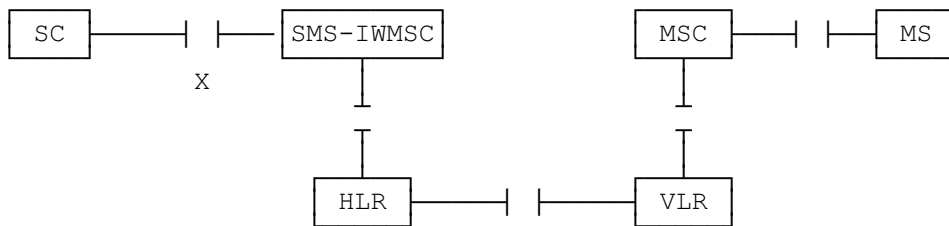

Figure 03.40/19: Interfaces involved in the Alert procedure. X is the interface between an SC and an MSC as defined in section 5.

This procedure consists of the operations shown in Figure 03.40/20.

Three cases are distinguished:

- The MS becomes reachable when the MNRF is set but the MCEF is not set (figure 03.40/20a);
- The MS becomes reachable when both the MNRF and the MCEF are set (figure 03.40/20b);
- The MS notifies the network that it has memory available to receive one or more short messages when the MCEF is set (figure 03.40/20c).

The operations between MSC and VLR, between HLR and VLR and between HLR and SMS-IWMSC are specified in GSM 09.02. The operation between MS and MSC is specified in GSM 04.11. References to specifications of other operations are given in section 4.

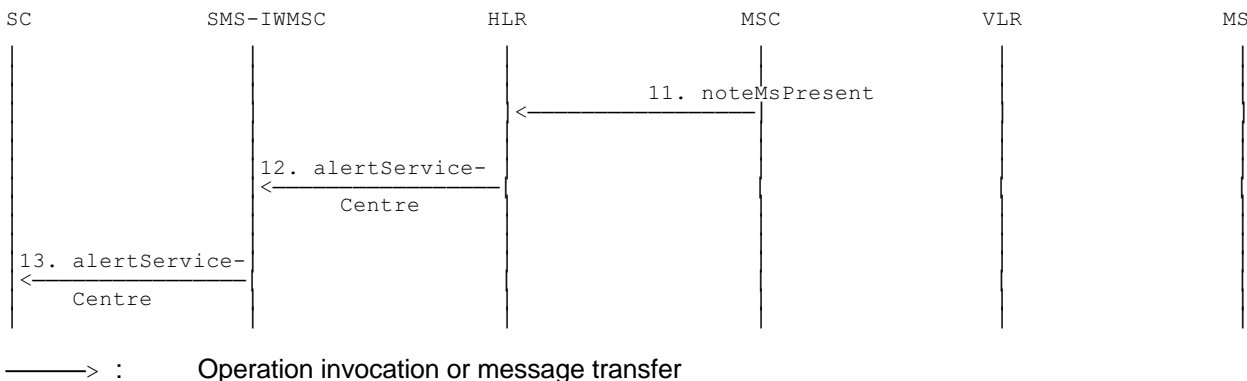
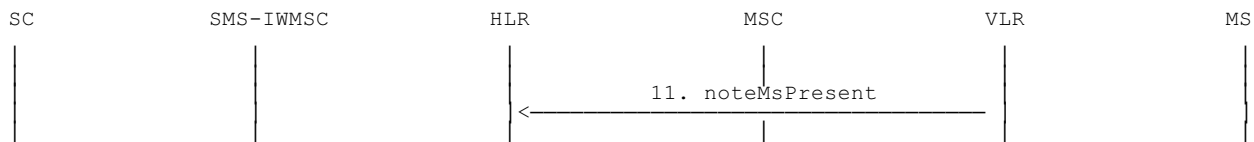
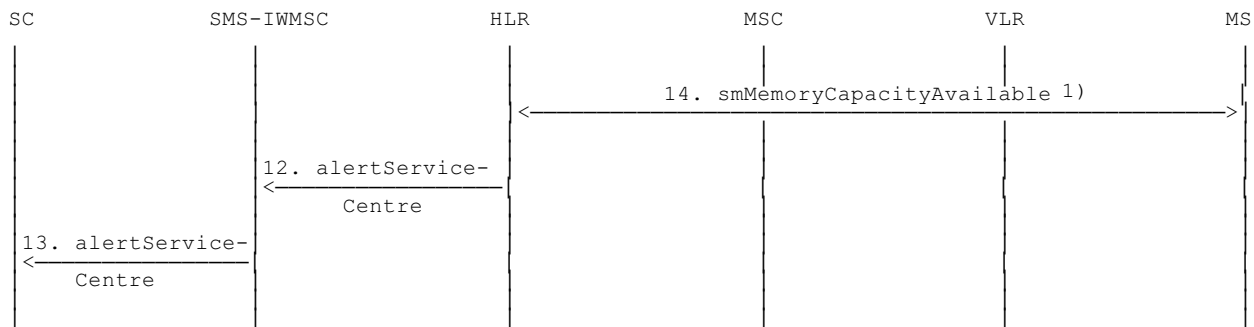

Figure 03.40/20a: The alert procedure when the MS becomes reachable, MNRF is set and MCEF is not set.



————> : Operation invocation or message transfer

Figure 03.40/20b: The alert procedure when the MS becomes reachable, MNRF is set and MCEF is set.



————> : Operation invocation or message transfer
 <———— : Successful operation invocation or message transfer including report

References:

1) : Described in GSM 04.11 and GSM 09.02

Figure 03.40/20c; The alert procedure when the MS notifies the network that it has memory available to receive one or more short messages and MCEF is set.

Operation 11: noteMsPresent

The operation provides a means to transfer alert information from VLR to HLR.

The procedure is activated when the VLR detects that the MS is active, i.e. when the MS responds to a paging request.

Operation 12: alertServiceCentre

The operation provides a means to transfer alert information from HLR to MSC.

Operation 13: alertServiceCentre

The operation provides a means to transfer alert information from an SMS-IWMSC to an SC.

The operation consists of transfer of a message ('RP-ALERT-SC') from the SMS-IWMSC to the SC.

Operation 14: smMemoryCapacityAvailable

The operation provides a means for the MS to notify the network that it has memory available to receive one or more short messages.

The following applies if the memory capacity available notification flag is implemented in the SIM.

The operation consists of transfer of a message ('RP-SM-MEMORY-AVAILABLE') from the MS to the HLR, and the return of an acknowledgement to the MS. When the MS rejects a short message due to lack

of available memory capacity the need to transfer notification shall be stored in the SIM. After a attempt to transfer the RP-SM-Memory-Available message the following applies:

If the MS receives a positive acknowledgement it will unset the memory capacity exceeded notification flag in the SIM and exit this procedure.

If the MS receives a negative acknowledgement indicating a permanent failure condition (as specified in GSM 04.11) it will unset the memory capacity exceeded notification flag in the SIM and exit the procedure.

If the MS receives a negative acknowledgement indicating a temporary failure condition (as specified in GSM 04.11) or receives no acknowledgement or an indication of failure by lower layers, it will repeat the attempt to transfer the message in accordance with procedures defined in GSM 04.11. If these repeat procedures fail, the mobile will unset the memory capacity exceeded notification flag in the SIM and exit this procedure.

If memory capacity has become available because memory is cleared, the value of the memory capacity exceeded notification flag is read. If the flag is set, the MS notifies the network that memory capacity is now available as described above.

When the mobile is powered up or the SIM is inserted, the mobile shall check the memory capacity exceeded notification flag in the SIM; if the flag is set and the SIM has memory available to receive a short message the mobile shall attempt to notify the network that it has memory available, as described above.

11 Mapping of error causes between RP layers

This section describes the interworking between the relay layers on the air interface (i.e. between the servicing MSC and the mobile station), and within the network (i.e. between servicing MSC, and VLR, HLR, or GMSC).

11.1 Mobile Terminated short message transfer

If errors are indicated by the VLR after invocation of the 'sendInfoFor-MT-SMS' operation, the appropriate error information is returned to the SMS-GMSC in a failure report as specified in TS GSM 09.02 (negative outcome of 'forwardShortMessage' see section 10),

If errors are detected by the MSC during the transfer on the air interface, the error cause returned in the return error of the MAP procedure ForwardShortMessage shall be set as follows:

Failure at the MSC	Return error to be included in the MAP-proc
RP-ERROR message with error cause:	
22 Memory capacity exceeded	SM_DeliveryFailure with cause 'MemoryCapacityExceeded' ¹⁾
Other error causes	SM_DeliveryFailure with cause 'equipmentProtocolError' ¹⁾
CP or lower layer error (e.g. RR, layer 2 failure) ²⁾	SM_DeliveryFailure with cause 'equipmentProtocolError' ¹⁾
Mobile has no SM capability	SM_DeliveryFailure with cause 'equipmentNotSM-Equiped' ¹⁾⁰
TR1N timeout ²⁾ MNSMS-error-ind (No SAPI 3)	SM_DeliveryFailure with cause 'equipmentProtocolError' ¹⁾

1) For definition of MAP error SM_DeliveryFailure and its parameter "cause" see TS GSM 09.02.

2) The error causes of the RP-ERROR message, the CP layer and timer TR1N are defined in TS GSM 04.11.

11.2 Memory available notification

If errors are indicated by the HLR (via the VLR) after invocation of the 'ReadyForSM' operation, the MSC shall return the appropriate error information to the MS in a failure report (i.e. a RP-ERROR message) containing the following error cause:

Return error from ReadyForSM (Alert Reason is "memory available")	Cause value in the RP-ERROR message
DataMissing	38 Network out of order
UnexpectedDataValue	38 Network out of order
UnknownSubscriber	30 Unknown Subscriber
FacilityNotSupported	69 Requested facility not implemented
System Failure	38 Network out of order

NOTE: The coding and the use of the RP-ERROR message is specified in TS GSM 04.11.

11.3 Mobile Originated short message transfer

If errors are indicated by the VLR after invocation of the 'sendInfoForMO-SMS' operation.(see section 10), the MSC shall return the appropriate error information to the MS in a failure report (i.e. a RP-ERROR message) containing the following error cause:

Return error from SendInfoForMO-SMS	Cause value in the RP-ERROR message
DataMissing	38 Network out of order
UnexpectedDataValue	38 Network out of order
TeleserviceNotProvisioned	50 Requested facility not subscribed
CallBarred	
- barringServiceActive	10 Call barred
- operatorBarring	8 Operator determined barring

NOTE: The coding and the use of the RP-ERROR message is specified in TS GSM 04.11.

If errors are indicated by the SMS-IWMSC (negative outcome of the 'forwardShortMessage'), the MSC shall send a failure report (i.e. a RP-ERROR message) to the MS, with the error cause coded as follows:

Return error from ForwardShortMessage	Cause value in the RP-ERROR message
DataMissing	38 Network out of order
FacilityNotSupported	69 Requested facility not implemented
UnexpectedDataValue	38 Network out of order
SM-DeliveryFailure cause: unknownSC	1 Unassigned number
SM-DeliveryFailure cause: SC-Congestion	42 Congestion
SM-DeliveryFailure cause: invalidSME-Addr	21 Short message transfer rejected
SM-DeliveryFailure cause: subscriberNotSC-Subscriber	28 Unidentified subscriber
Local or lower layer failure (e.g. reject condition, timer expired or transaction abort)	38 Network out of order

NOTE: The coding and the use of the RP-ERROR message is specified in TS GSM 04.11.

Annex A (Informative): Protocol stacks for interconnecting SCs and MSCs

No mandatory protocol between the Service Centre (SC) and the Mobile Switching Centre (MSC) below the transfer layer is specified by GSM; this is a matter of agreement between SC and PLMN operators.

Some example protocols are provided in GSM 03.47 to assist SC and PLMN operators. These are based on the following principles, which SC and PLMN operators are recommended to follow even if they choose not to use one of the examples given in GSM 03.47:

The protocol(s) between SC and MSC below transfer layer should:

- a) provide the service defined for SM-RL (see Section 9.3);
- b) be based on widely accepted telecommunications protocols in the public domain;
- c) permit open interconnection.

Annex B (Informative): Information now contained in GSM 03.38

Annex B held information that is now contained in GSM 03.38.

Annex C (Informative): Short message information flow

The diagrams in this annex describe the flow of primitives and parameters during the short message transfer. These diagrams refer to specifications GSM 03.40, 04.11 and 09.02. The parameters in dotted lines are optional. The abbreviations used in diagrams are listed below. The relevant specifications are given in parentheses. (*) stands for a common GSM abbreviations and (-) for a general abbreviation.

CM	Call Management (*)
CS	CauSe (-)
DA	Destination Address (-)
DCS	Data Coding Scheme (03.40)
DI	Dialogue Identifier TCAP
GMSCA	Gateway MSC Address
HLR	Home Location Register (*)
IMSI	International Mobile Subscriber Identity (*)
MAL	MSIsdn-Alert (03.40)
MMS	More Messages to Send (03.40)
MR	Message Reference (03.40)
MS	Mobile Station (*)
MSC	Mobile services Switching Centre (*)
MSCA	MSC Address
MSI	Mobile waiting Set Indication (03.40)
MSIsdn	Mobile Station ISDN number (*)
MSM	More Short Messages (09.02)
MSRN	Mobile Station Roaming Number (*)
MT	Message Type (04.11)
MTI	Message Type Indicator (04.11)
MWS	Message Waiting Set (03.40)
OA	Originating Address (-)
OC	Operation Code (09.02)
PCI	Protocol Control Information (-)
PDI	Protocol DIscriminator (*)
PRI	PRiority (03.40)
RCT	ReCeption Time (03.40)
REA	REcipient Address (03.40)
RL	ReLay function (04.11)
RP	Reply Path (03.40)
SC	Service Centre (03.40)
SCA	Service Centre Address (03.40)
SCTS	Service Centre Time Stamp (03.40)
SM	Short Message (03.40)
SM-AL	Short Message Application Layer (03.40)
SME	Short Message Entity (03.40)
SMI	Short Message Identifier (03.40)
SM-RL	Short Message Relay Layer (03.40, 04.11)
SMS-GMSC	Short Message Service Gateway MSC (03.40)
SMS-IWMSC	Short Message Service Interworking MSC (03.40)
SoR	Status of Report (03.40)
SM-TL	Short Message Transfer Layer (03.40)
SRI	Status Report Indication (03.40)
SRR	Status Report Request (03.40)
ST	STatus (03.40)
TCAP	Transaction Capabilities Application Part (-)
TID	Transaction Identifier (*)
UD	User Data (-)
UDL	User Data Length (03.40)
VLR	Visitor Location Register (*)
VP	Validity Period (03.40)
VPF	Validity Period Format (03.40)

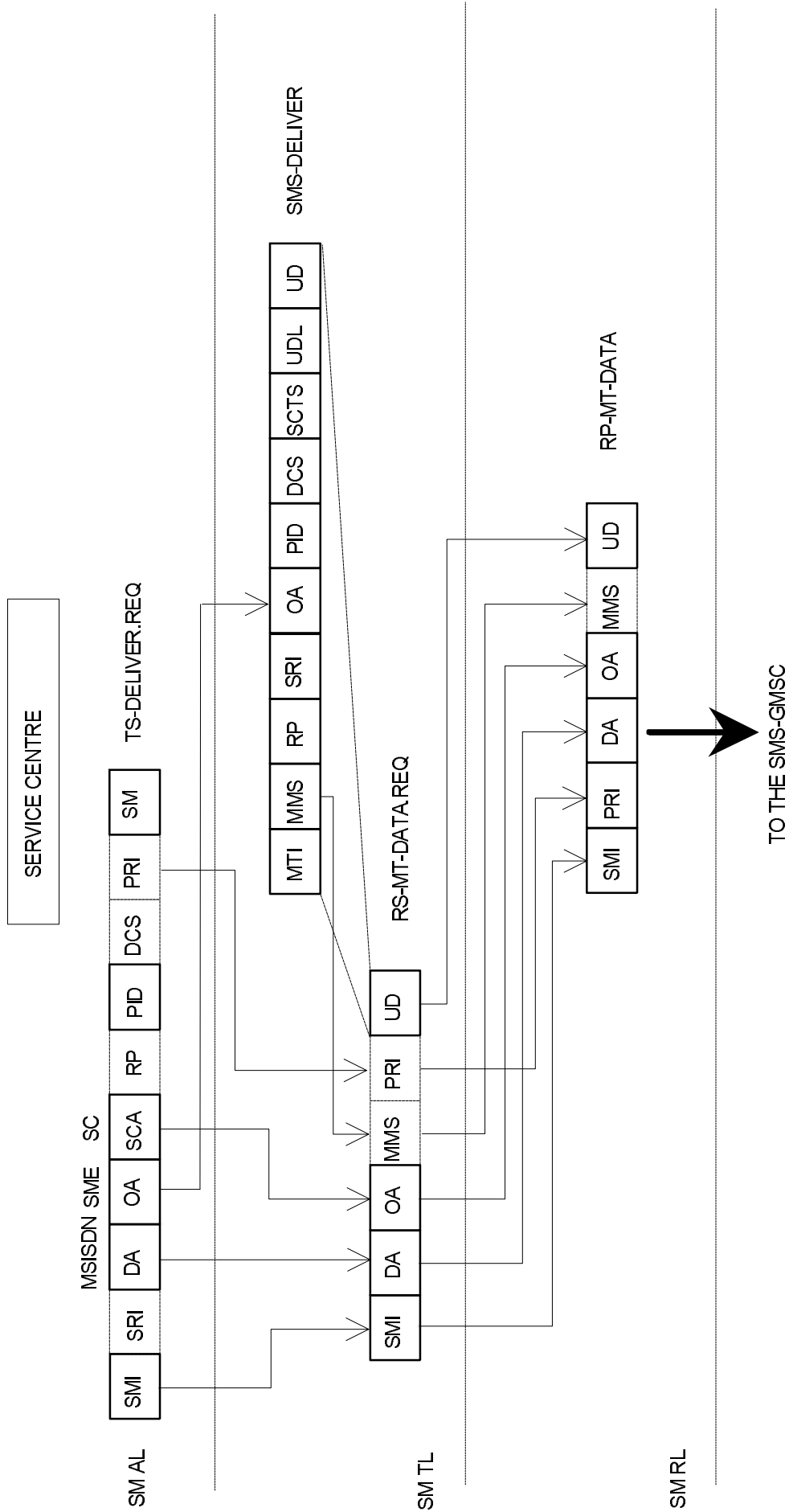

Note: SMI is not carried via SM-RL of section 9.3.5 but is carried via the relay service between the SC and GMSC (see section 9.3.4.1)

Figure 1.1: Mobile terminated short message

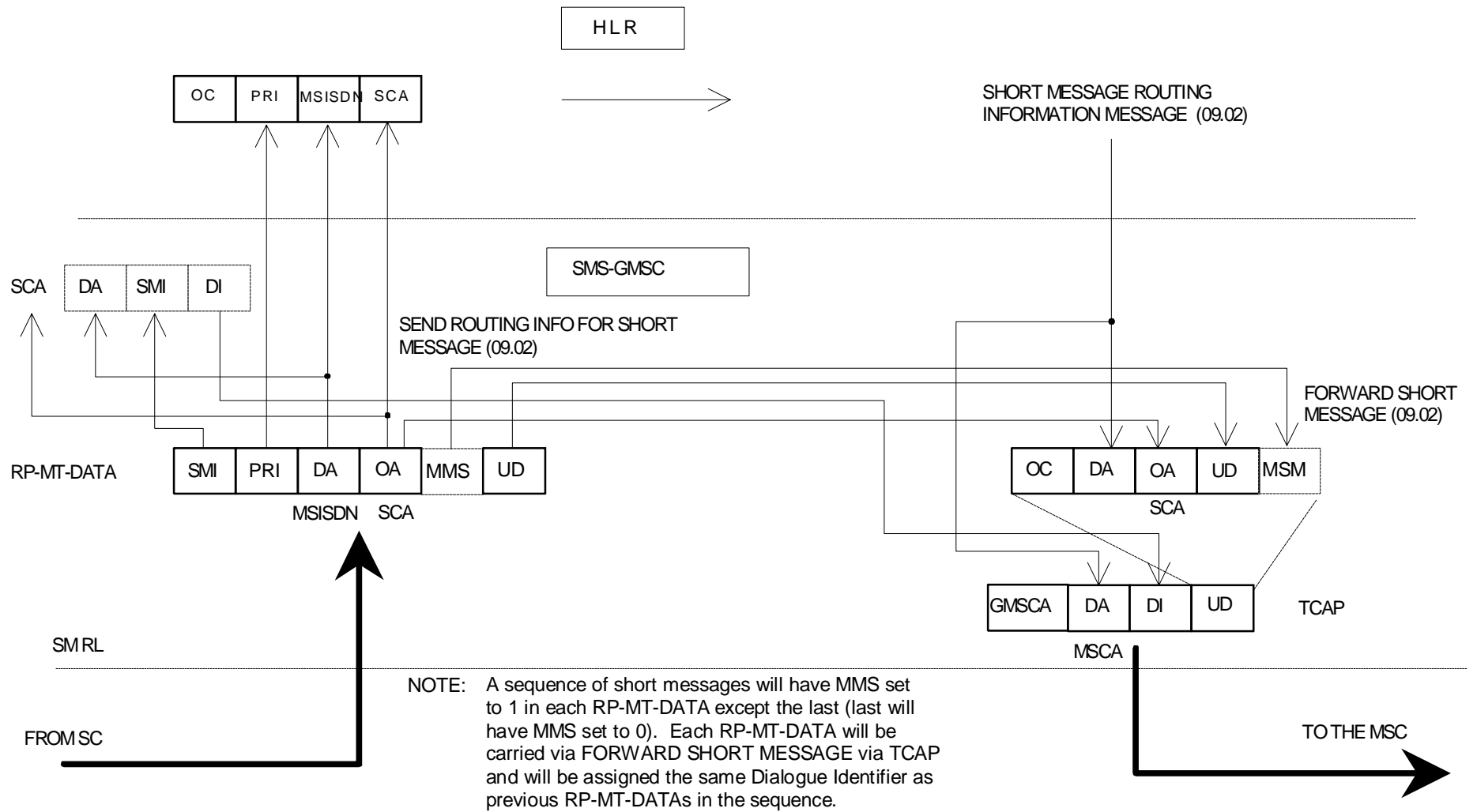

Figure 1.2: Mobile terminated short message

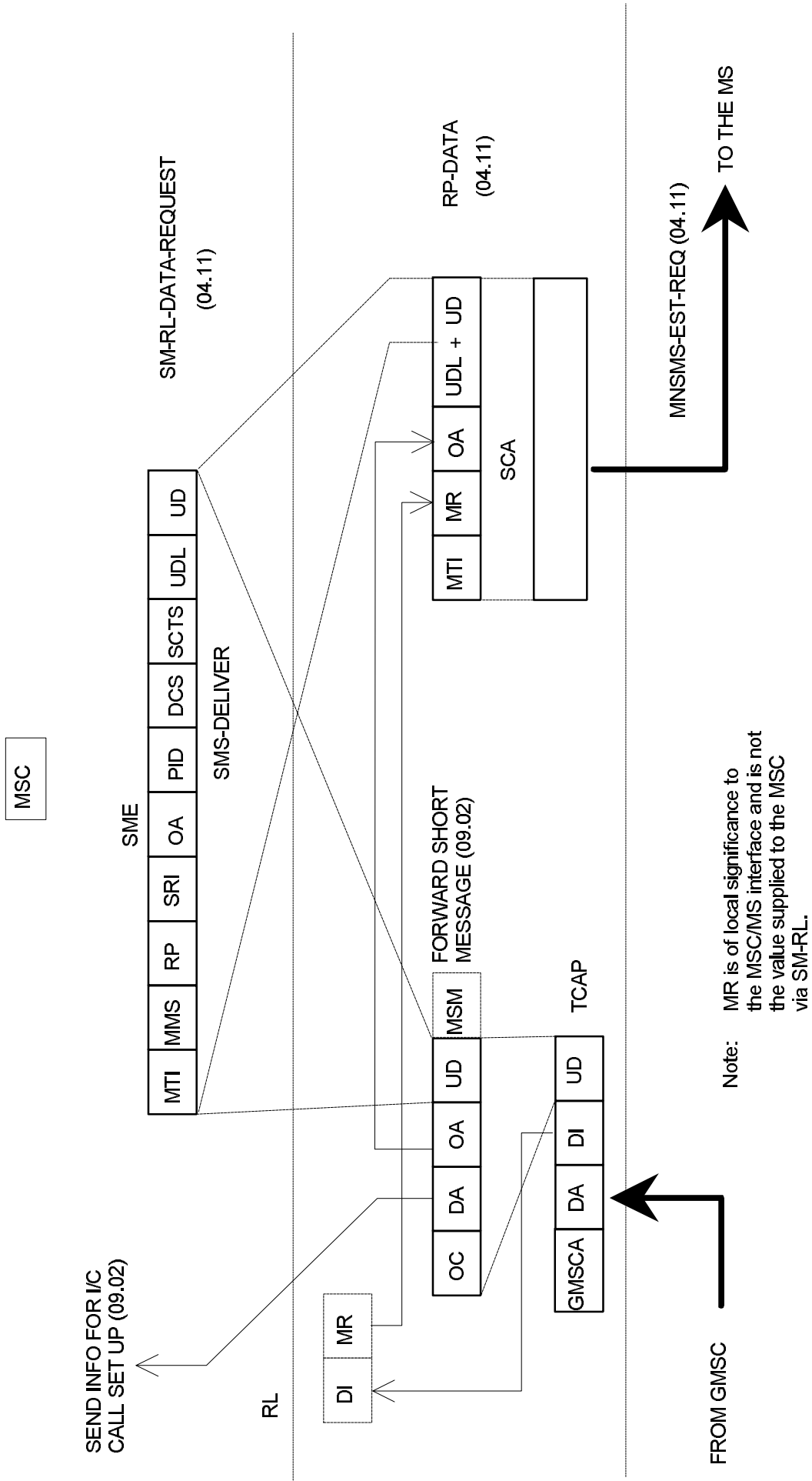

Figure 1.3: Mobile terminated short message

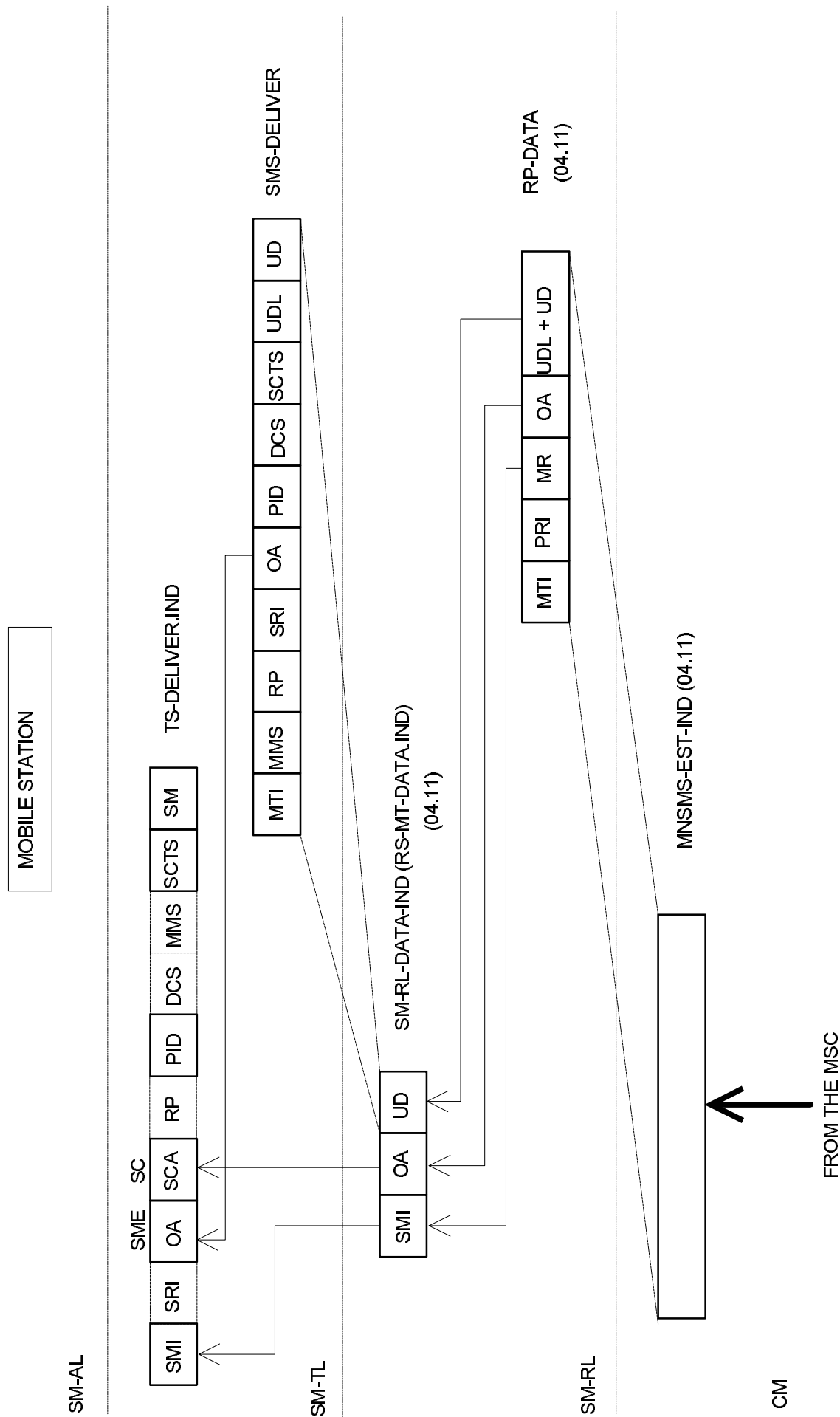

Figure 1.4: Mobile terminated short message

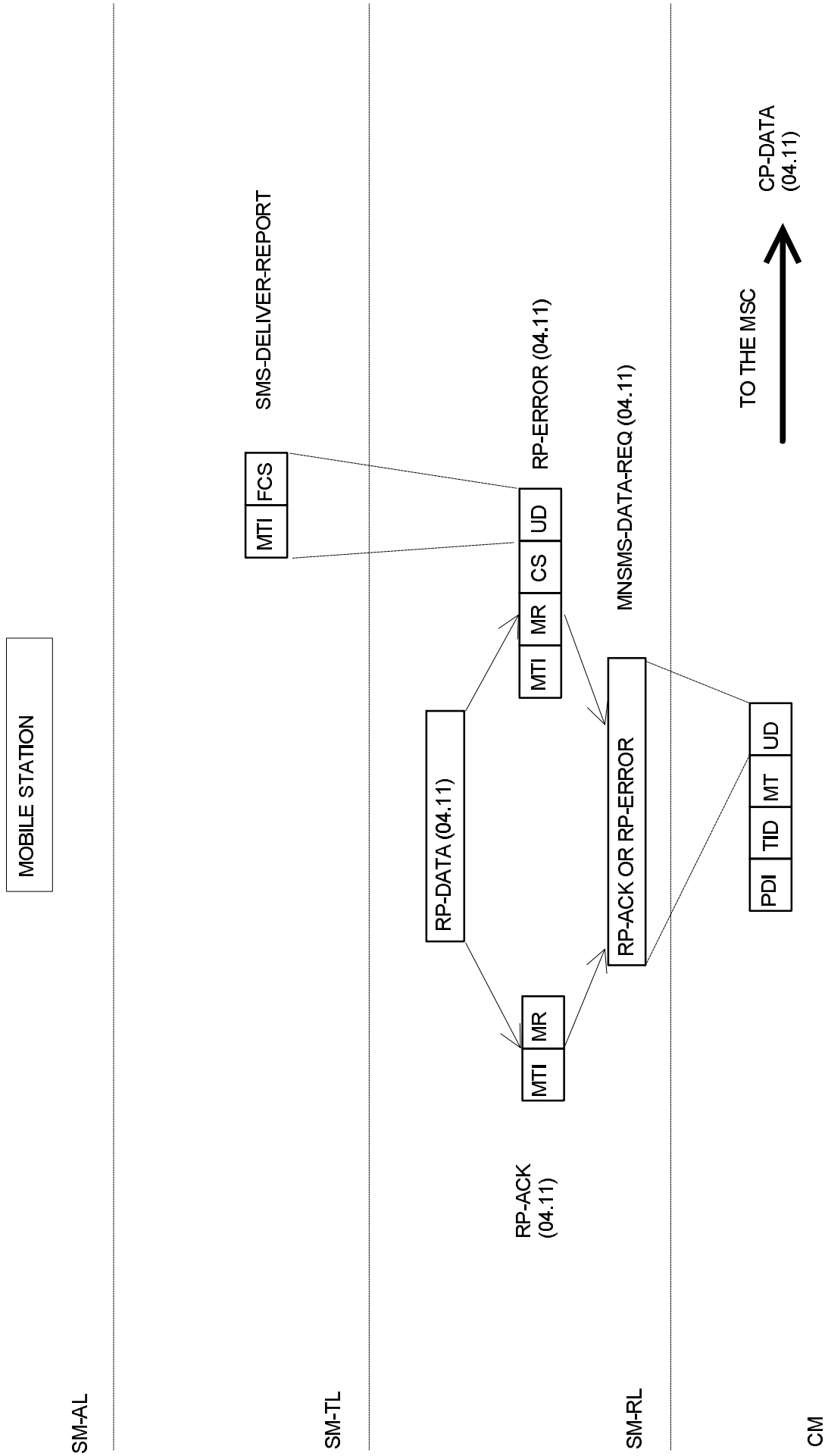

Figure 2.1: Acknowledgement in the MT case

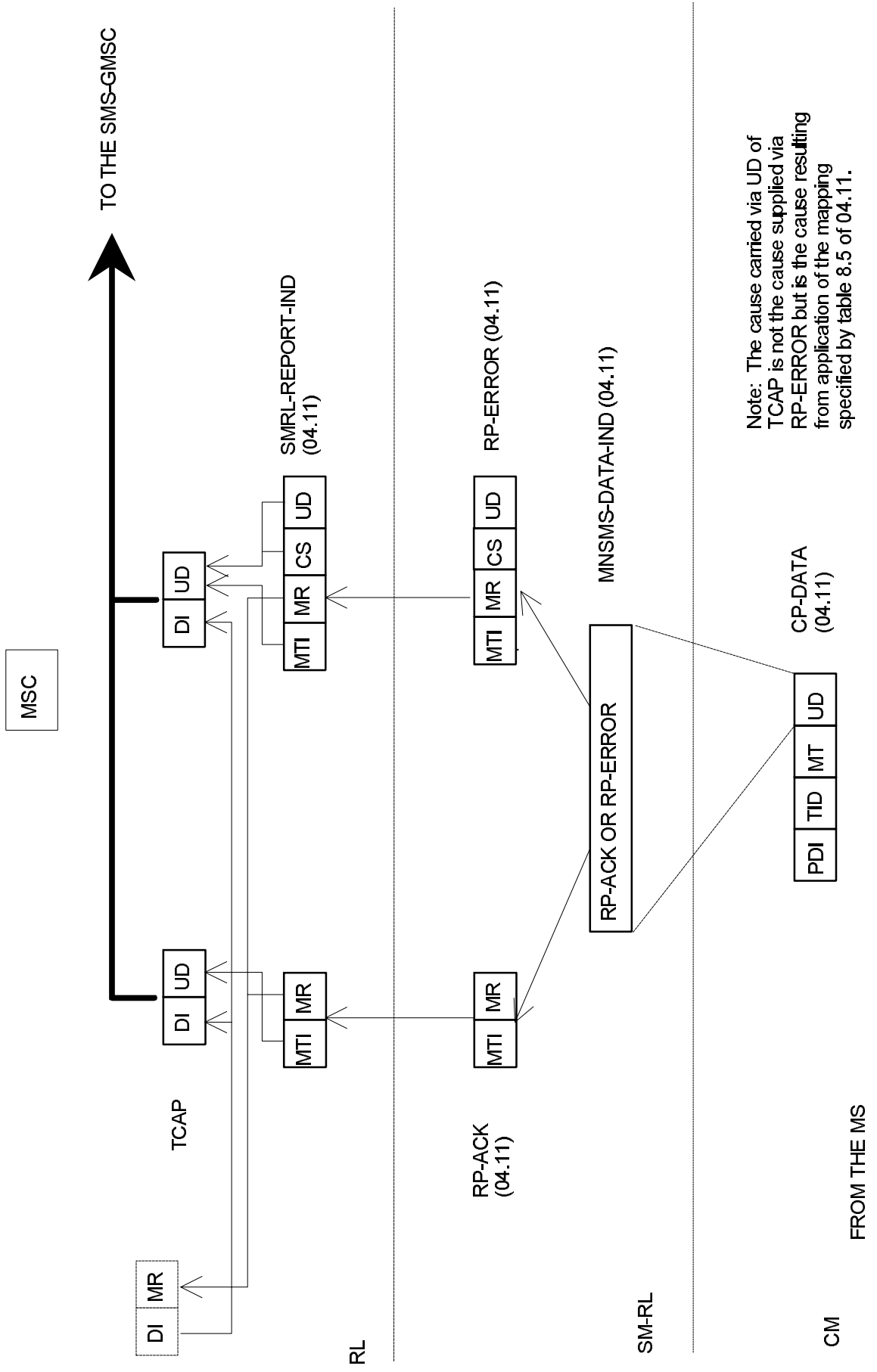

Figure 2.2: Acknowledgement in the MT case

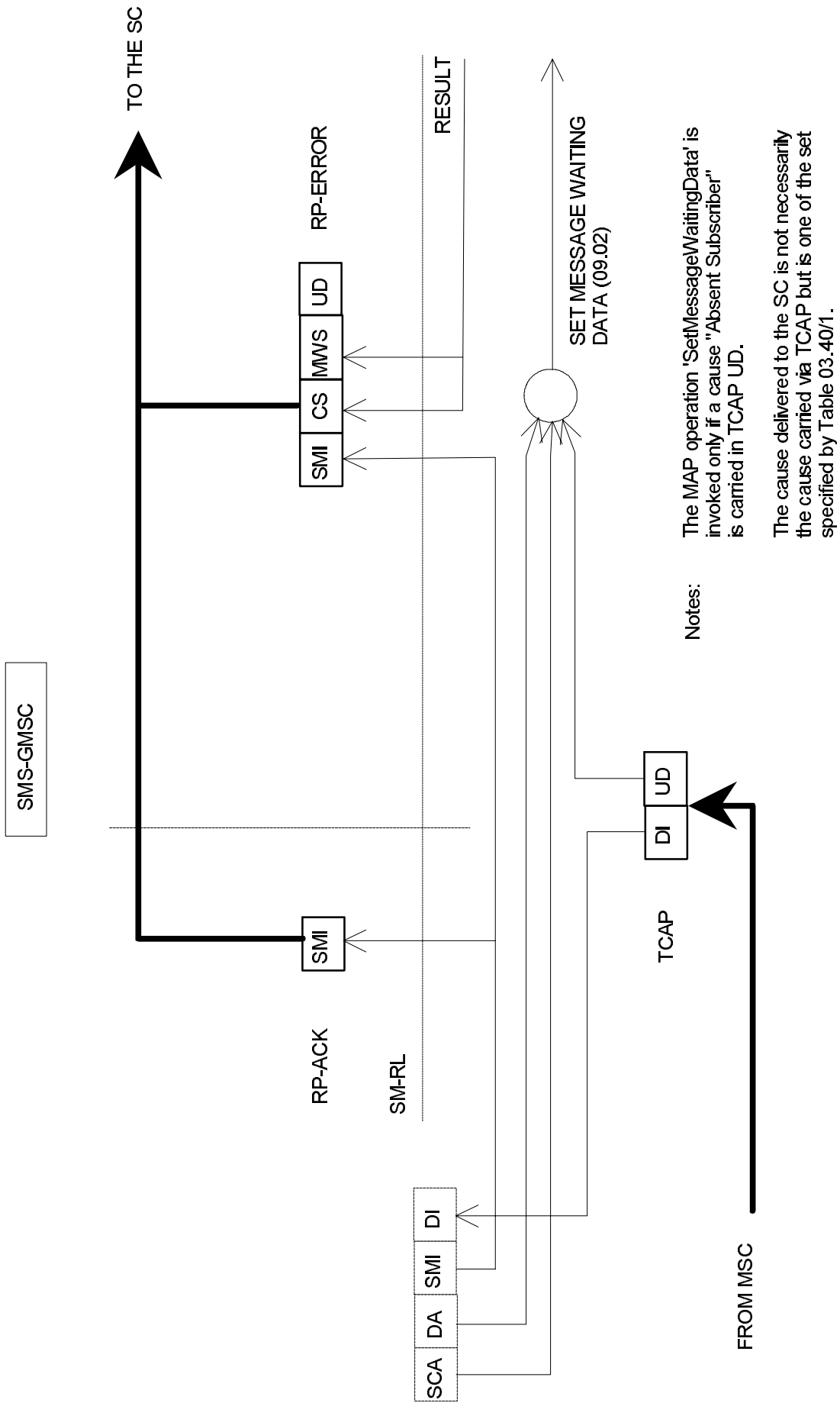

Figure 2.3a: Acknowledgement in the MT case

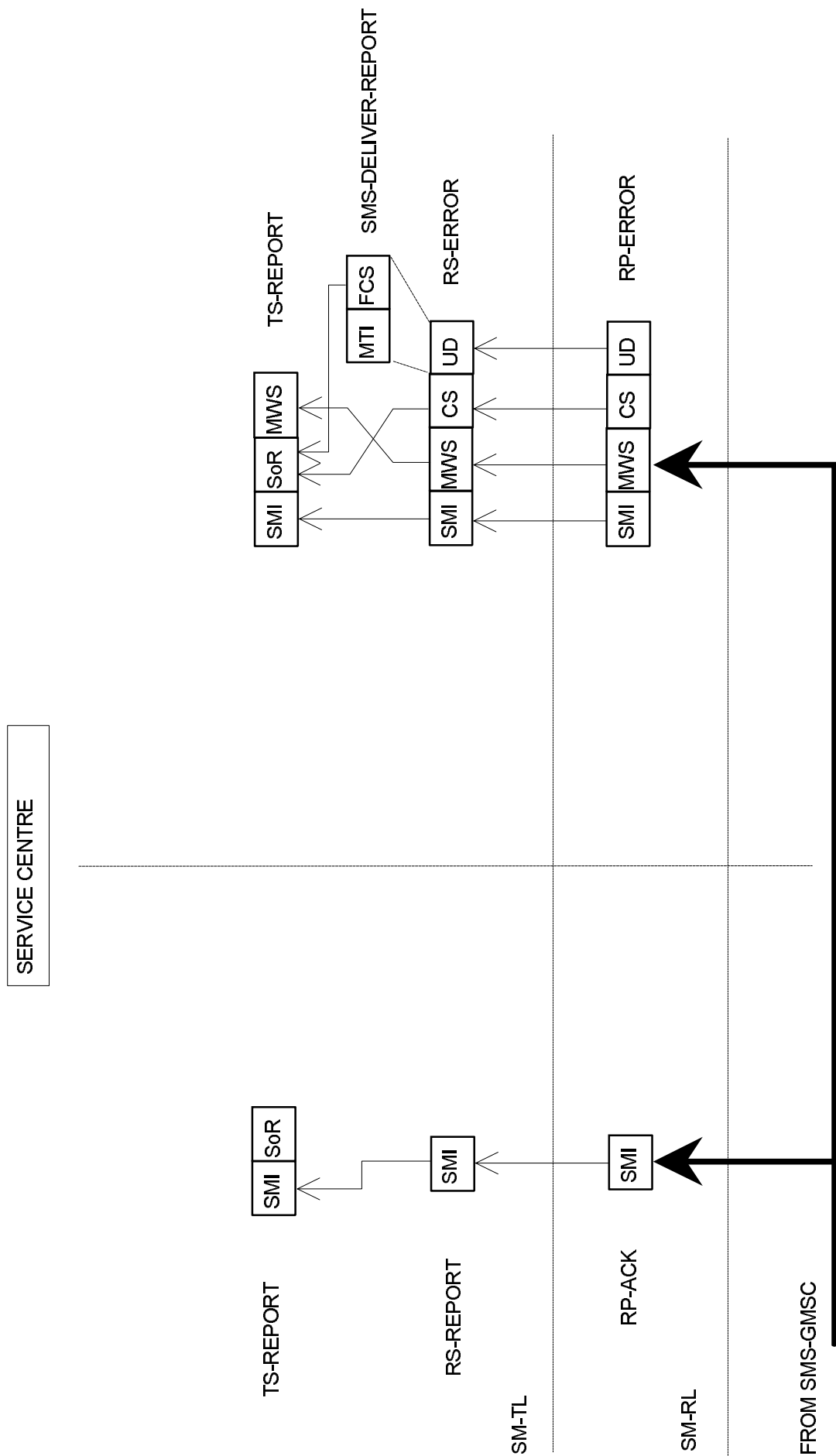
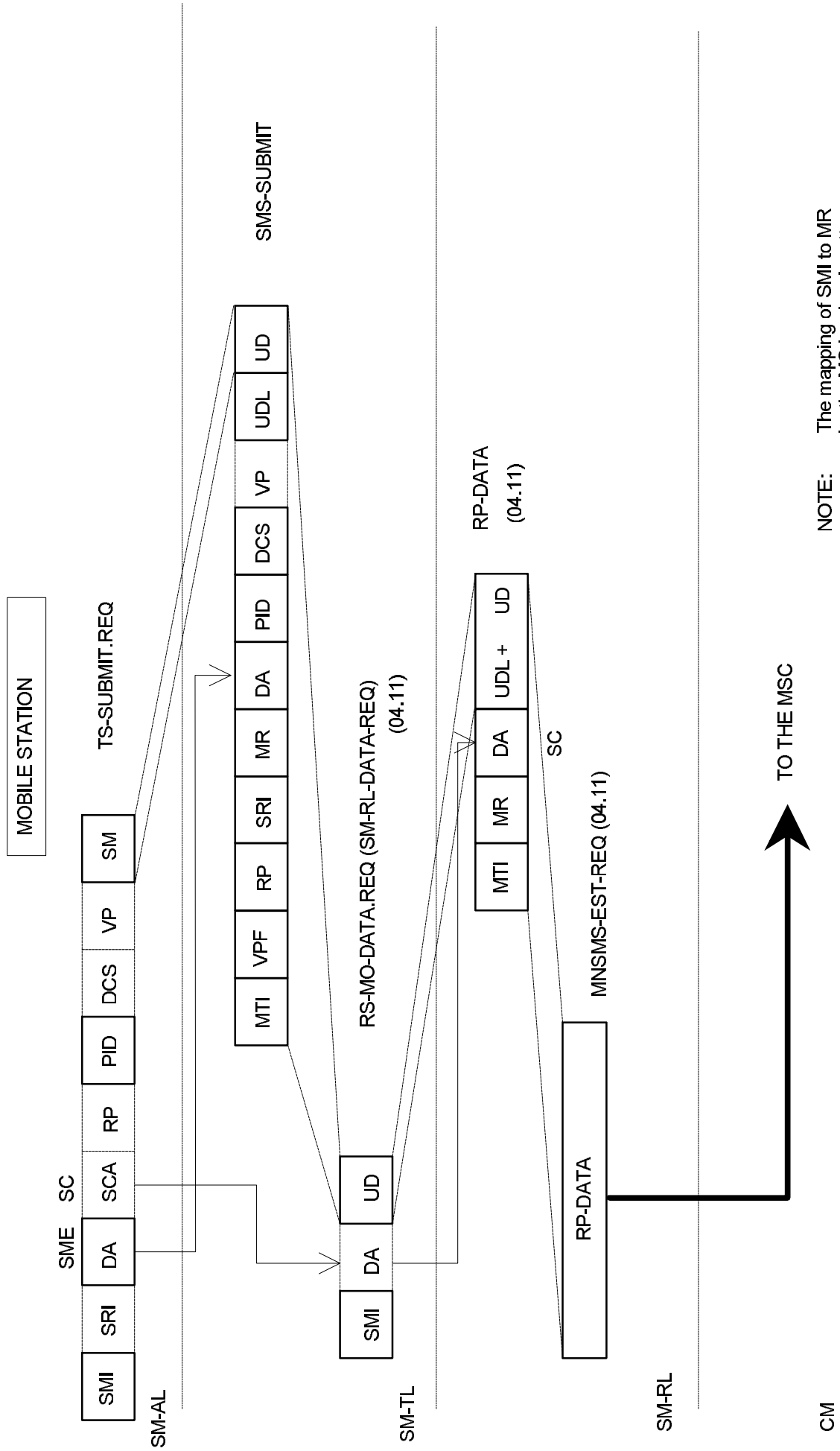

Figure 2.3b Acknowledgement in the MT case



NOTE: The mapping of SMI to MR by the MS is a local matter.

Figure 3.1: Mobile originated short message

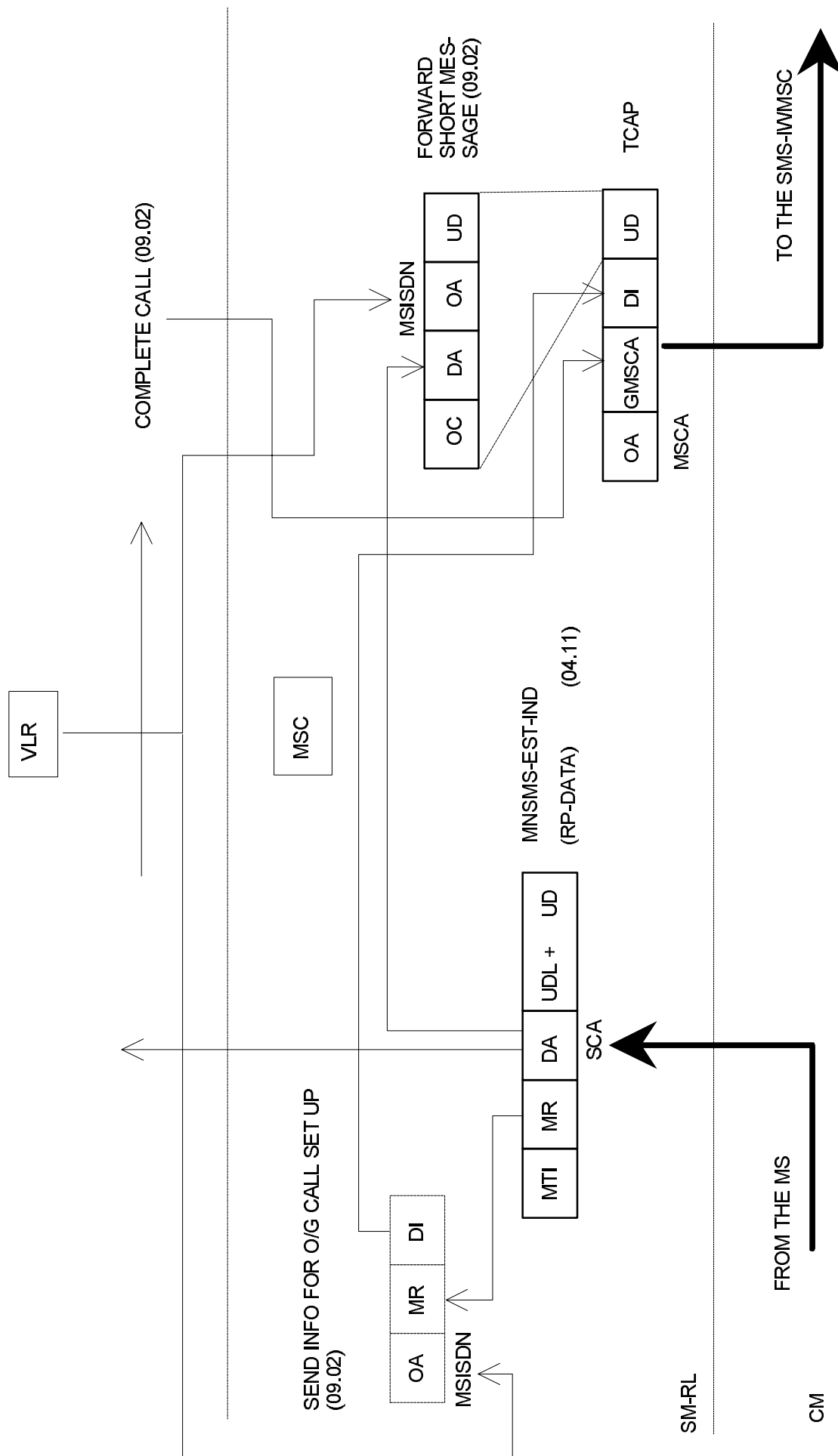

Figure 3.2: Mobile originated short message

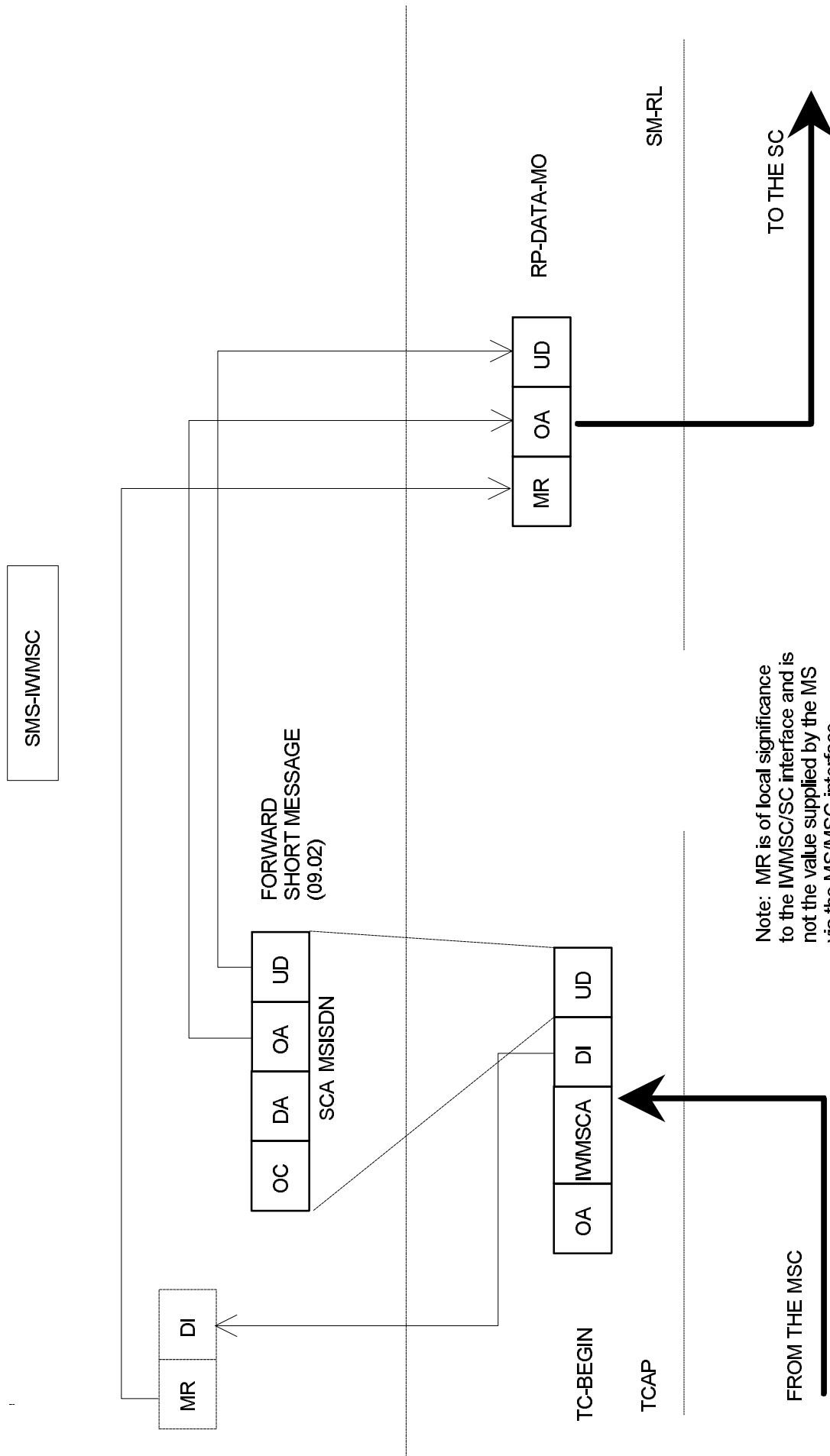

Figure 3.3: Mobile originated short message

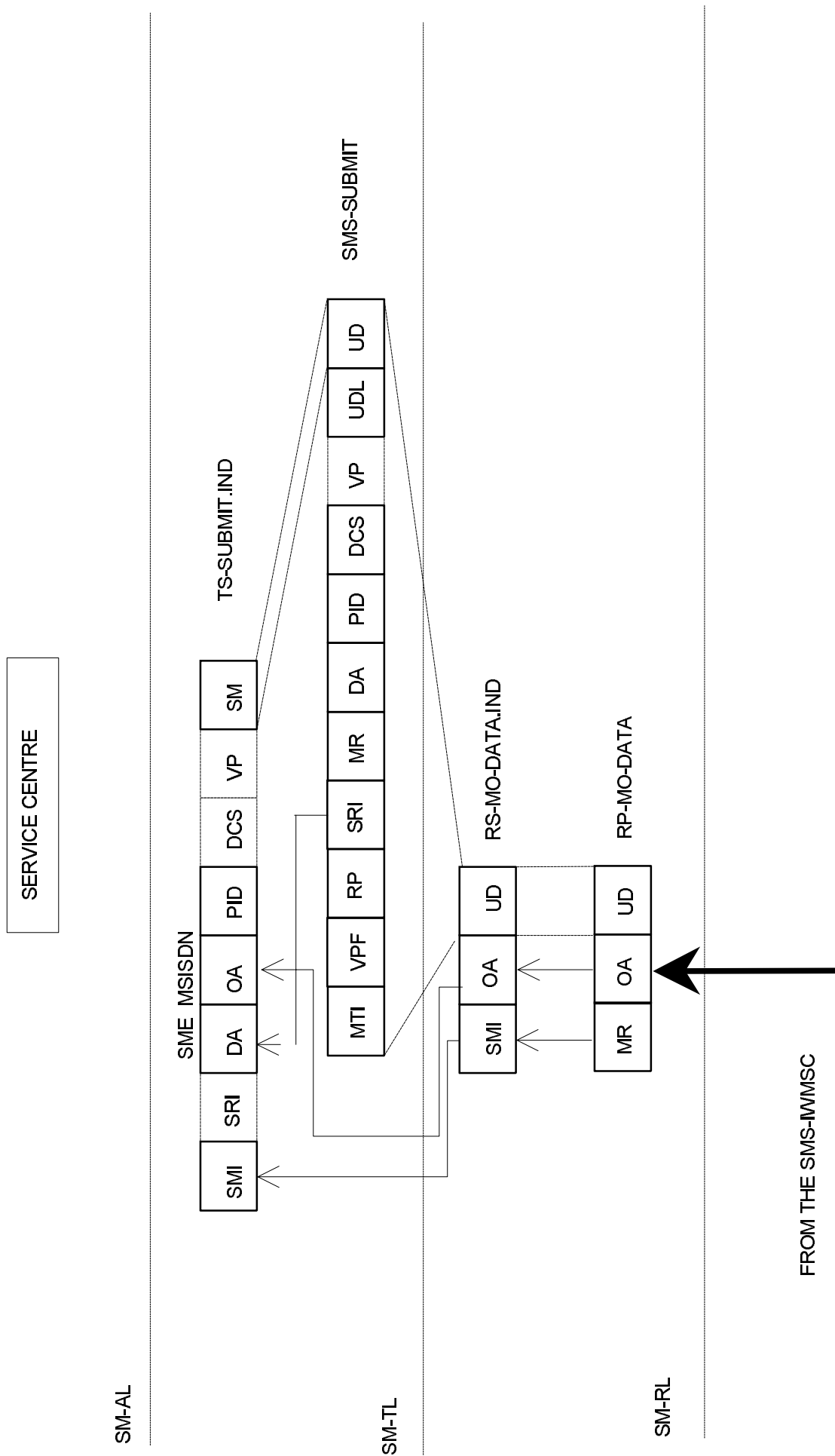

Figure 3.4: Mobile originated short message

SERVICE CENTRE

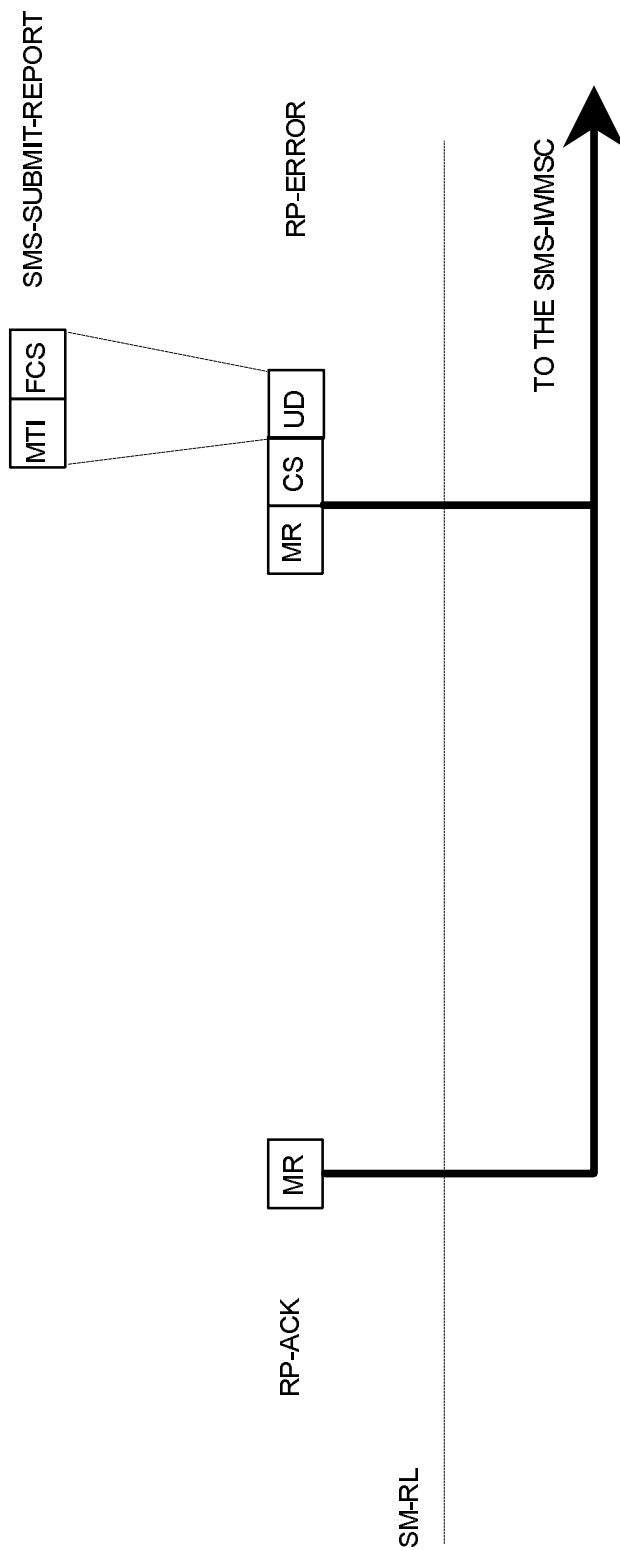

Figure 4.1a: Acknowledgement in the MO case

SMS-IM/MS

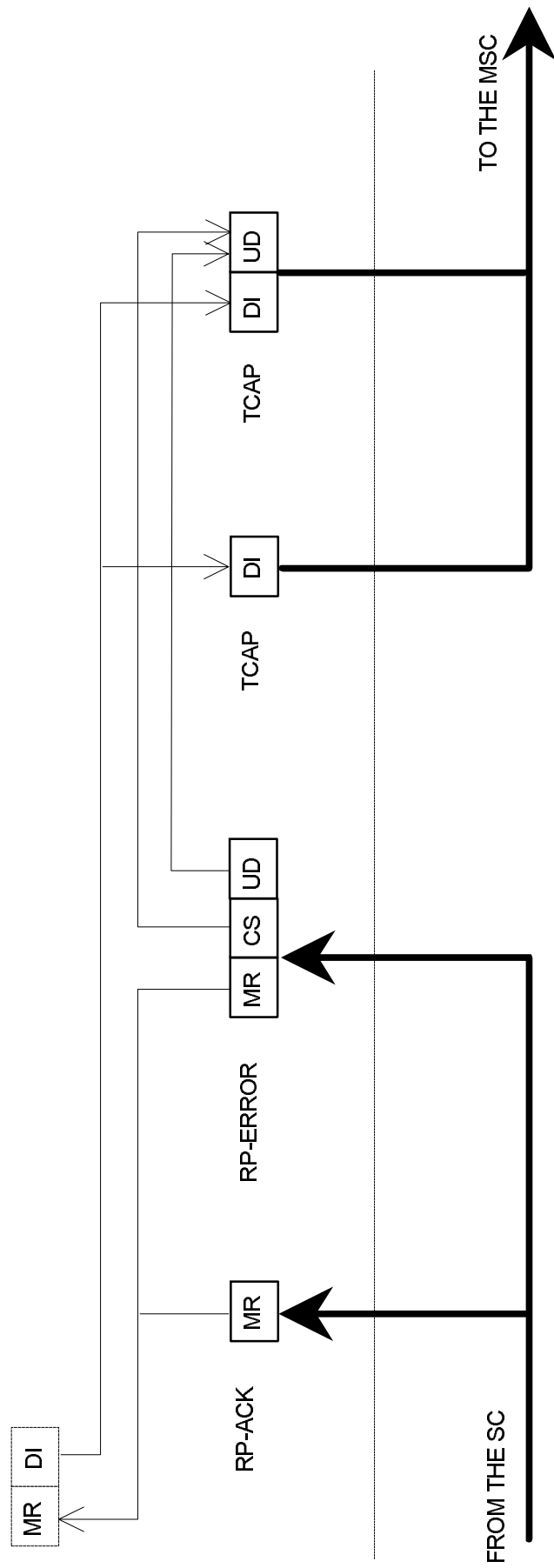

Figure 4.1b: Acknowledgement in the MO case

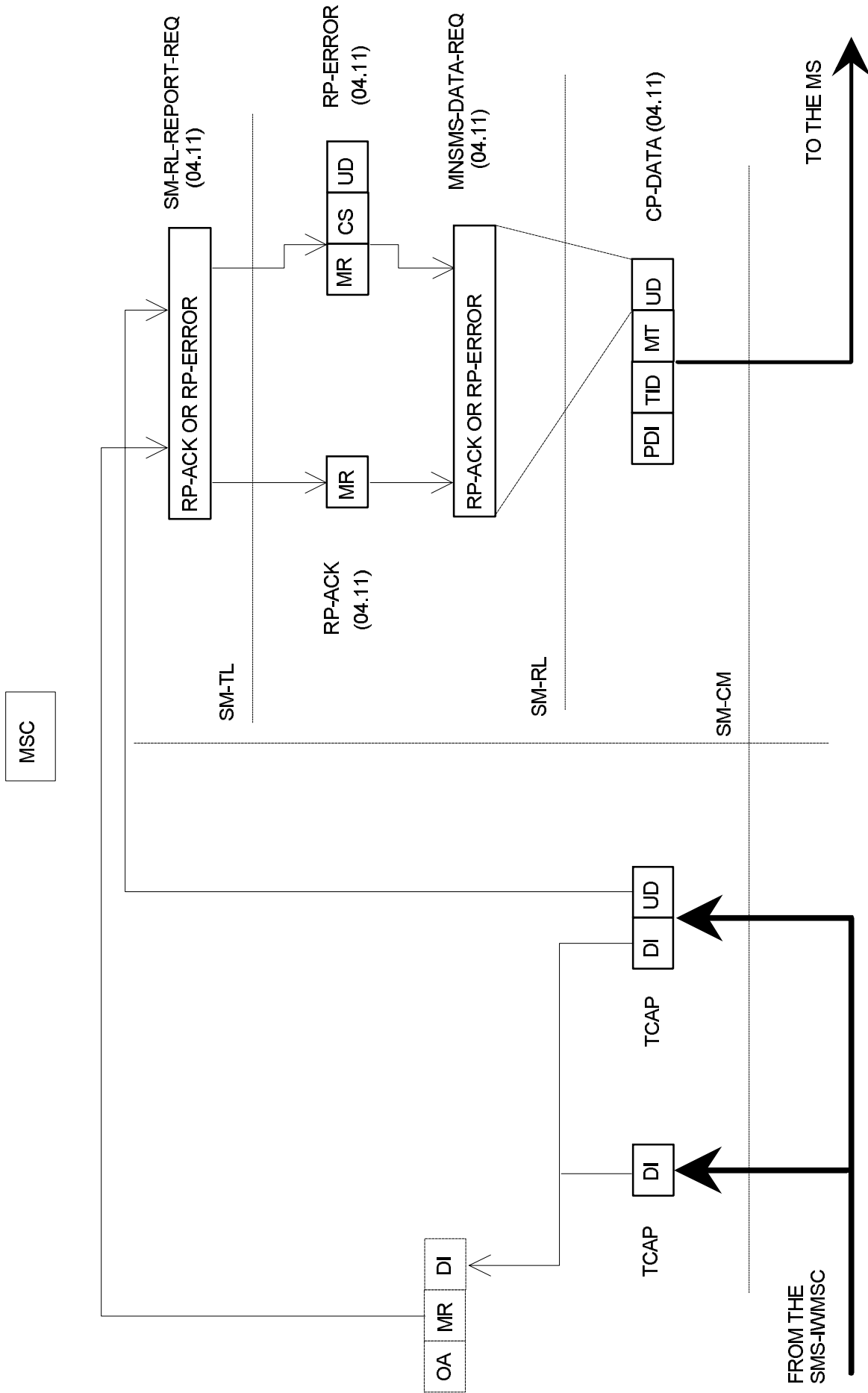

Figure 4.2: Acknowledgement in the MO case

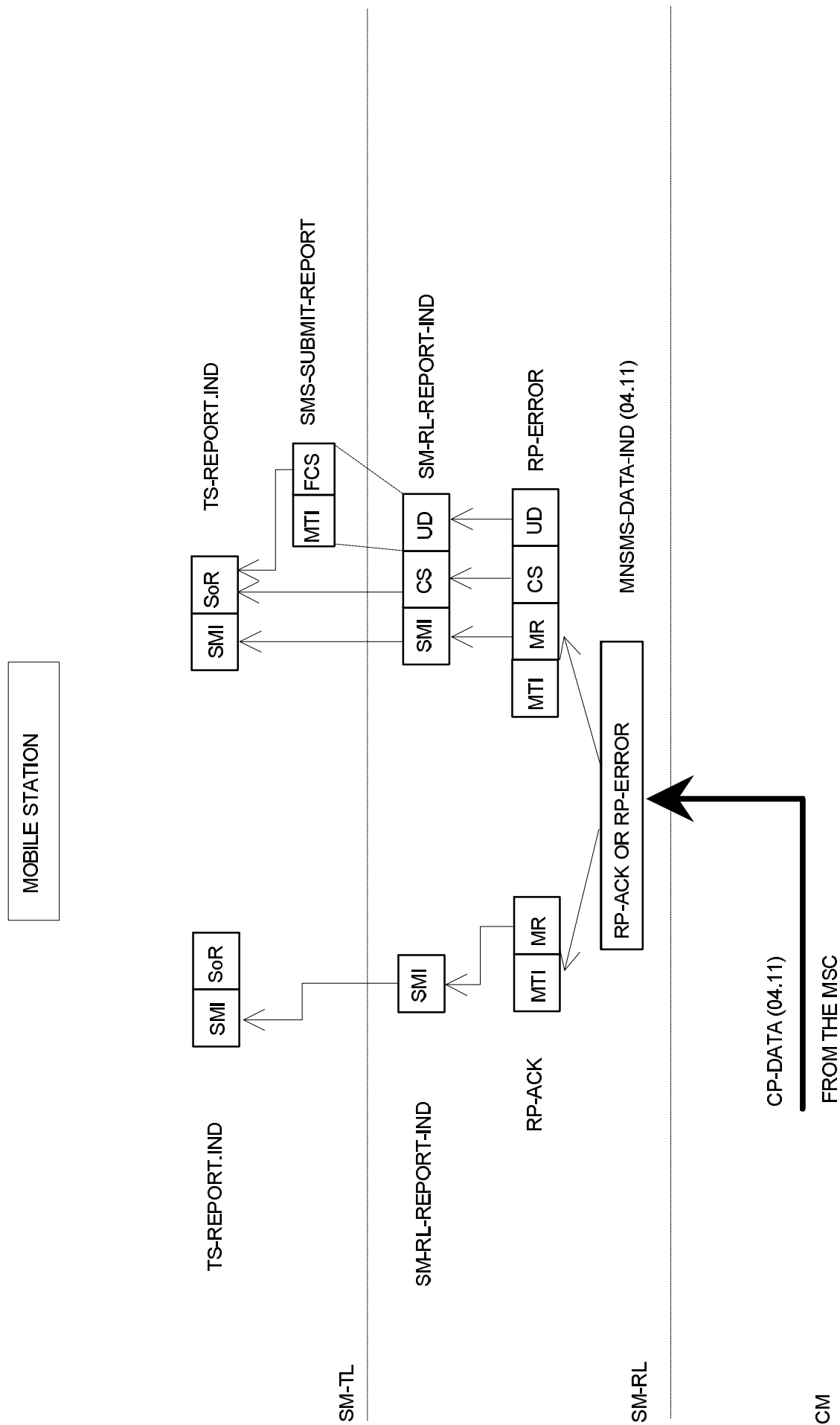

Figure 4.3: Acknowledgement in the MO case

Annex D (Informative): Mobile Station reply procedures

D.1 Introduction

The reply procedures specified in this annex should be followed by a mobile station when replying to a short message, i.e. when generating a MO SM in response to a received MT SM, addressed to the originator of that MT SM. The main purpose of this annex is to specify how the MS selects the service centre for delivering that MO SM: an arbitrary SME may only be reached by submitting the reply SM to a specific SC, known to be able of delivering to that SME.

D.2 The scope of applicability

The reply procedures in sections 5 and 6 of this annex should be followed by every MS which fulfils the following criteria:

- 1) The MS automatically selects the value for the RP-Destination-Address parameter in RP-MO-DATA, or the MS has the SC address within the SM-RL entity. (That is to say: the human user is not obliged to manually key in the SC address for every MO short message).
- 2) The MS or an application within it supports some form of replying to a MT SM with a MO SM. (That is to say: in the process of generating the reply MO SM, any reference whatsoever, implicit or explicit, is made to the original MT SM.).
- 3) The replying support of (2) is to be equally available towards every SME.

When an SME submits an SM to an SC for delivery, it may request that the SC sets the TP-Reply-Path parameter in the SM to be delivered. If the submitting SME is an MS, the reply path requesting procedure; in section 4 of this annex may be applied. However, an SC may support the reply procedures without supporting the reply path requesting procedure; in that case, the SC sets the TP-Reply-Path parameter on another basis, which must be the case if the SM originates from an SME which is not an MS.

D.3 Terminology

An originating SME submits an original SM to an original SC, which delivers the original MT SM to a replying MS. The replying MS sends back a reply MO SM, a MO SM which is generated (automatically or by human operations) in response to the original MT SM, and which is addressed to the originating SME.

If the originating SME is an MS, the original MT SM is submitted within an SMS-SUBMIT PDU; we say that reply path is requested if the TP-Reply-Path parameter is set in the SMS-SUBMIT PDU of the original MT SM.

We say that reply path exists if the TP-Reply-Path parameter was set in the SMS-DELIVER PDU of the original MT SM; we say that reply path does not exist otherwise.

The replying MS may have a default SC which is normally used for delivering all the MO short messages originated from the replying MS. Alternatively, a human user or automatic application may specify a selected SC for delivering a particular SM (thus the term selected SC refers to an SC address selected for one short message only).

D.4 The reply path requesting procedure

The discussion in this section applies to cases when the originating SME is a mobile station only. The reply procedures discussed in the sections to follow this one are independent of the type of the originating SME.

The reply path is requested by the originating SME (an MS) by setting the TP-Reply-Path parameter in the SMS SUBMIT PDU of the original SM. If the original SC supports reply path requesting for the originating SME (an MS), it will take notice of the TP-Reply-Path parameter in the SMS-SUBMIT PDU and set the TP-Reply-Path parameter in the SMS-DELIVER PDU of the original MT SM towards the replying MS. Hence, reply path exists for the replying MS towards the originating SME (an MS).

D.5 The reception of an original MT SM

When a replying MS receives an original MT SM, it then has

- 1) originating SME = TP-Originating-Address in the SMS-DELIVER PDU,
- 2) original SC = RP-Originating-Address in RPS-MT-DATA, and
- 3) reply path exists / reply path does not exist = TP-Reply-Path in SMS-DELIVER PDU (set / not set).

D.6 The submission of the reply MO SM

According to section 5, the replying MS knows if

- a) reply path exists or
- b) reply path does not exist.

We then specify that when submitting the reply MO SM, the replying MS should use parameters as follows:

- 1) TP-Destination-Address in SMS-SUBMIT PDU = originating SME,
- 2a) If reply path exists:
RP-Destination-Address in RP-MO-DATA = original SC,
- 2b) If reply path does not exist:
RP-Destination-Address in RS-MO-DATA = selected SC or default SC or original SC,
- 3a) If reply path exists:
after submitting one reply MO SM, the reply path does not exist any more.

In case (2b), it is allowed to use the original SC or the default SC, but then there is no guarantee that the original/default SC will deliver the reply MO SM. (The original SC may refuse to deliver, if the replying MS is not its subscriber; the default SC may be unable to deliver, if it has no access path to the originating SME.)

Requirement (3a) states that the case (a), reply path exists, holds for one reply MO SM only (per original MT SM).

D.7 Usage of SCs for replying

The specification in this annex supports the following way of replying.

The original MT SM and the reply MO SM are delivered by the same SC, the original SC. This principle maximises the probability that the SC can e.g. route the reply MO SM to the proper data network for reaching the originating SME; this principle is a must, if the originating SME is integrated within the original SC.

If the original SC by any means whatsoever knows that it is both willing and able to deliver one (potential) reply MO SM, it may indicate this fact by setting the TP-Reply-Path parameter in the original MT SM. The original SC thus commits itself to delivering one reply MO SM; let us call this reply delivery commitment.

One reason for the SC to make the reply delivery commitment may be the reply path requesting procedure specified in section 4 on this annex.

The reply path commitment is not valid forever, but the original SC may have e.g. a time limit for maintaining this commitment.

D.8 Replying possibilities for phase 1 mobile stations

The phase 2 mobile stations should support the procedures in this annex (if they fulfil the criteria in section 2 of it). Yet, phase 1 mobile stations, too, may apply steps (1) and (2a) in section 6 of this annex, i.e. reply via the original SC, automatically or manually (by choosing selected SC = original SC), despite the fact that the TP-Reply-Path parameter will be ignored by them. The delivery of the reply MO SM cannot be guaranteed in this case, yet the possibility of delivery may be improved (especially if the originating SME is not an MS.)

D.9 The resulting service for originating SMEs

As the consequence of the replying procedures specified in this annex, all SMEs and applications within them may assume that replying from all mobile stations is always possible, provided that the mobile stations do support the proper replying mechanism itself (human response in context with the original MT SM, automatic replying by an application, application level protocols, etc.).

History

Document history	
October 1995	Creation of Version 5.0.0 (Version 4.12.0 + AR019)
December 1995	Publication of Version 5.0.0
February 1996	Converted into Adobe Acrobat Portable Document Format (PDF)