

ETSI ES 202 765-2 V1.2.1 (2014-05)



**Speech and multimedia Transmission Quality (STQ);
QoS and network performance metrics and
measurement methods;
Part 2: Transmission Quality Indicator combining
Voice Quality Metrics**

Reference

RES/STQ-210

Keywords

performance, QoS, user, voice

ETSI

650 Route des Lucioles
F-06921 Sophia Antipolis Cedex - FRANCE

Tel.: +33 4 92 94 42 00 Fax: +33 4 93 65 47 16

Siret N° 348 623 562 00017 - NAF 742 C
Association à but non lucratif enregistrée à la
Sous-Préfecture de Grasse (06) N° 7803/88

Important notice

The present document can be downloaded from:

<http://www.etsi.org>

The present document may be made available in electronic versions and/or in print. The content of any electronic and/or print versions of the present document shall not be modified without the prior written authorization of ETSI. In case of any existing or perceived difference in contents between such versions and/or in print, the only prevailing document is the print of the Portable Document Format (PDF) version kept on a specific network drive within ETSI Secretariat.

Users of the present document should be aware that the document may be subject to revision or change of status. Information on the current status of this and other ETSI documents is available at

<http://portal.etsi.org/tb/status/status.asp>

If you find errors in the present document, please send your comment to one of the following services:

http://portal.etsi.org/chaicor/ETSI_support.asp

Copyright Notification

No part may be reproduced or utilized in any form or by any means, electronic or mechanical, including photocopying and microfilm except as authorized by written permission of ETSI.

The content of the PDF version shall not be modified without the written authorization of ETSI.

The copyright and the foregoing restriction extend to reproduction in all media.

© European Telecommunications Standards Institute 2014.

All rights reserved.

DECT™, **PLUGTESTS™**, **UMTS™** and the ETSI logo are Trade Marks of ETSI registered for the benefit of its Members. **3GPP™** and **LTE™** are Trade Marks of ETSI registered for the benefit of its Members and of the 3GPP Organizational Partners.

GSM® and the GSM logo are Trade Marks registered and owned by the GSM Association.

Contents

Intellectual Property Rights	5
Foreword.....	5
1 Scope	6
2 References	6
2.1 Normative references	6
2.2 Informative references.....	6
3 Abbreviations	7
4 Introduction	8
5 Measurement type	10
6 Voice quality scale	10
7 List of indicators.....	10
7.1 Post Dialling Delay	10
7.2 Media establishment delay	11
7.3 Unsuccessful call ratio.....	11
7.4 Premature release probability.....	11
7.5 Level of active speech signal at reception.....	12
7.6 Noise level at reception	12
7.7 Noise to signal ratio at reception.....	13
7.8 Speech signal attenuation (or gain) after transmission.....	13
7.9 Talker echo delay	14
7.10 Talker echo attenuation	15
7.11 Listening speech quality	16
7.12 Listening speech quality stability	18
7.13 End-to-end delay	19
7.14 End-to-end delay variation	20
7.15 Frequency responses at the reception.....	21
8 Measurement frequency	21
9 Duration of test calls.....	21
10 Measurement configurations	22
10.1 VoIP services.....	22
10.2 VoIP services in triple play context.....	22
11 Measurement locations and their distribution	22
11.1 Measurement location requirements.....	22
11.2 Method to determine measurement locations	23
12 Results presentation.....	24
12.1 One-view visualization of performances	24
12.1.1 Pie diagram with all indicators	24
12.1.2 Pie diagram with mandatory indicators	25
12.2 Non-compliant limits for result visualization.....	25
13 Publication of the results	26
Annex A (normative): Indicator stability formulation	27
A.1 Presentation	27
A.2 Formulation	27
A.3 Graphic illustration of the formulation.....	28
A.4 Some examples of stability indicator calculated on Listening Speech Quality.....	30

Annex B (normative):	Calibration to take into account the frequency response of transducers	32
B.1	Method presentation	33
B.1.1	Sending	33
B.1.2	Sending	33
B.1.3	Global communication	33
B.1.4	Applications	33
Annex C (informative):	Echo presentation	34
C.1	Talker echo	34
C.2	Listener echo	34
Annex D (informative):	Examples of measurement point distribution	35
D.1	Example of France	35
D.2	Example of Switzerland	36
History		39

Intellectual Property Rights

IPRs essential or potentially essential to the present document may have been declared to ETSI. The information pertaining to these essential IPRs, if any, is publicly available for **ETSI members and non-members**, and can be found in ETSI SR 000 314: "*Intellectual Property Rights (IPRs); Essential, or potentially Essential, IPRs notified to ETSI in respect of ETSI standards*", which is available from the ETSI Secretariat. Latest updates are available on the ETSI Web server (<http://ipr.etsi.org>).

Pursuant to the ETSI IPR Policy, no investigation, including IPR searches, has been carried out by ETSI. No guarantee can be given as to the existence of other IPRs not referenced in ETSI SR 000 314 (or the updates on the ETSI Web server) which are, or may be, or may become, essential to the present document.

Foreword

This ETSI Standard (ES) has been produced by ETSI Technical Committee Speech and multimedia Transmission Quality (STQ).

The present document is part 2 of a multi-part deliverable covering the QoS and network performance metrics and measurement methods as identified below:

EG 202 765-1: "General considerations";

ES 202 765-2: "Transmission Quality Indicator combining Voice Quality Metrics";

EG 202 765-3: "Network performance metrics and measurement methods in IP networks";

ES 202 765-4: "Indicators for supervision of Multiplay services".

1 Scope

The present document aims at identifying and defining indicators and methodologies for a use in a context of end-user quality characterization and supervision of voice telephony services.

In this context the measurements and metric determinations are performed by analysing signals accessible on user-end services and not on the network. In order to mirror the reality in terms of access to the services at the user-end, measurements and analyses are performed on electrical signals by excluding the electro-acoustic part of the end equipment, however the probe adaptation to the electric interface of the end user equipment takes into account the electro-acoustic characteristics of this terminal.

All the indicators presented and defined in the present document are objective indicators obtained by instrumental measurement methods.

2 References

References are either specific (identified by date of publication and/or edition number or version number) or non-specific. For specific references, only the cited version applies. For non-specific references, the latest version of the reference document (including any amendments) applies.

Referenced documents which are not found to be publicly available in the expected location might be found at <http://docbox.etsi.org/Reference>.

NOTE: While any hyperlinks included in this clause were valid at the time of publication ETSI cannot guarantee their long term validity.

2.1 Normative references

The following referenced documents are necessary for the application of the present document.

Not applicable.

2.2 Informative references

The following referenced documents are not necessary for the application of the present document but they assist the user with regard to a particular subject area.

- [i.1] Recommendation ITU-T P.800: "Methods for subjective determination of transmission quality".
- [i.2] Recommendation ITU-T P.862: "Perceptual evaluation of speech quality (PESQ): An objective method for end-to-end speech quality assessment of narrow-band telephone networks and speech codecs".
- [i.3] Recommendation ITU-T P.862.1: "Mapping function for transforming P.862 raw result scores to MOS-LQO".
- [i.4] Recommendation ITU-T P.862.3: "Application guide for objective quality measurement based on Recommendations P.862, P.862.1 and P.862.2".
- [i.5] Recommendation ITU-T P.800.1: "Mean Opinion Score (MOS) terminology".
- [i.6] Recommendation ITU-T E.800: "Terms and definitions related to quality of service and network performance including dependability".
- [i.7] Recommendation ITU-T E.845: "Connection accessibility objective for the international telephone service".

- [i.8] ETSI EG 201 769: "Speech Processing, Transmission and Quality Aspects (STQ); QoS parameter definitions and measurements; Parameters for voice telephony service required under the ONP Voice Telephony Directive 98/10/EC".
- [i.9] Recommendation ITU-T P.56: "Objective measurement of active speech level".
- [i.10] Recommendation ITU-T O.41: "Psophometer for use on telephone-type circuits".
- [i.11] Recommendation ITU-T G.131: "Talker echo and its control".
- [i.12] Recommendation ITU-T G.168: "Digital network echo cancellers".
- [i.13] Recommendation ITU-T G.114: "One-way transmission time".
- [i.14] Recommendation ITU-T P.505: "One-view visualization of speech quality measurement results".
- [i.15] ETSI EG 201 377 (all parts): "Speech and multimedia Transmission Quality (STQ); Specification and measurement of speech transmission quality".
- [i.16] Recommendation ITU-T H.323: "Packet-based multimedia communications systems".
- [i.17] Recommendation ITU-T H.225.0: "Call signalling protocols and media stream packetization for packet-based multimedia communication systems".
- [i.18] Recommendation ITU-T P.50: "Artificial voices".
- [i.19] Recommendation ITU-T P.501: "Test signals for use in telephony".
- NOTE: This Recommendation includes an electronic attachment containing test signals for telephony applications.
- [i.20] ETSI TR 102 506: "Speech and multimedia Transmission Quality (STQ); Estimating Speech Quality per Call".
- [i.21] Recommendation ITU-T P.863: "Perceptual objective listening quality assessment".
- [i.22] Recommendation ITU-T P.863.1: "Application Guide for Recommendation ITU-T P.863".
- [i.23] Recommendation ITU-T P.800.2: "Mean opinion score interpretation and reporting".

3 Abbreviations

For the purposes of the present document, the following abbreviations apply:

ADSL	Asymmetrical Digital Subscriber Line
ATA	Analog Telephone Adapter
BAS	Broadband Access
DSLAM	Digital Subscriber Line Access Multiplexer
GPS	Global Positioning System
GSM	Global System for Mobile communications
HATS	Head And Torso Simulator
IP	Internet Protocol
IPTV	Internet Protocol Television
ISDN	Integrated Services Digital Network
ITU-T	International Telecommunication Union - Telecommunication standardization sector
MGCP	Media Gateway Control Protocol
MOS	Mean Opinion Score
MOS-LQON	Mean Opinion Store-Listening Quality Objective Narrow-band
MOS-LQOSW	Mean Opinion Store-Listening Quality Objective Super Wide band
mV	millivolt
PC	Personal Computer
PDD	Post Dialling Delay
PESQ	Perceptual Evaluation of Speech Quality
PSTN	Public Switched Telephone Network

RTP	Real Time Protocol
SIP	Session Initiation Protocol
UMTS	Universal Mobile Telecommunications Service
VoIP	Voice over Internet Protocol

4 Introduction

The assessment of transmission quality based on voice quality metrics is already addressed in several standards at ETSI (e.g. EG 201 377 [i.15] series) and elsewhere (mostly Recommendations ITU-T from the P and G series). These different documents address the measurement methodologies in terms of metrics, threshold, data acquisition or modelling of subjective opinion.

The objective of the present document is to complement this material with practical requirements of use in the context of service verification and benchmark on a large and representative scale from the point of view of the end-users or of the regulatory authorities. This has been made necessary by the current or recent evolutions of the telecommunication sector:

- the competitive environment, in particular in voice services, where public protocols with high quality services have been replaced by a multitude of service providers with less guarantees, and where clients can very easily change their service providers;
- the development of time varying quality in telecommunications, first in mobile offers (due to mobility and irregular network coverage), but now also for fixed services (mostly VoIP);
- the cohabitation, interaction and competition between services based on different technologies.

Voice transmission quality is now recognized as a differentiating factor, but it remains very difficult to quantify.

To achieve the goal mentioned beforehand, there are several existing possibilities, not fully satisfying:

- Customer surveys. This is by far the cheapest way to assess the perception of end users. But the bias introduced by other factors such as price, as well as the fact that voice quality itself is rarely questioned, and if so not in a satisfactory way, make this source not really reliable (one never knows before a survey what are the problems encountered by end users).
- Pseudo-subjective tests, with a few human testers assessing the quality of real links in several situations. This method has the major drawback of its lack of reproducibility, and is often applied without using the standard metrics and quality scales that can be found in standards like Recommendation ITU-T P.800 [i.1]. It is also very long to run and not really cheap in the current competitive context where so many offers have to be assessed and it is not easily applicable in a context of quality changing over time.
- Objective tests. This is the most reliable way, although it is also based on sampling and can be very costly in the case of a large deployment of probes or robots.

The present document assumes that this last family of methodology answers the needs of a reliable comparison of telephony offers and is applied without combination with other methods.

What matters the most is the point of view of the end-users. What they perceive is not only the result of the transmission of a signal across a network; the processing of this signal at the sending and at the receiving sides also has big importance. Therefore, it seems obvious not to use passive network monitoring systems to assess end-to-end voice quality, but rather active systems simulating the behaviour of the end users, including the terminal. A big advantage of such an approach is that it is highly technical and protocol agnostic, and therefore compliant with the expectations of users, which are not judging voice quality of PSTN, GSM or VoIP services following different criteria.

A last important aspect addressed in the present document is the practical organization of measurement campaigns in order to get a realistic and reliable vision of the services as perceived by the end-users. In particular, the questions of the periodicity of measurement and of the geographical coverage (i.e. more generally the sampling approach).

In order to mirror the reality in terms of access to the services, a reliable measurement or supervision system should provide the possibility to collect information from probes or robots adapted to the most common interfaces available.

This includes:

- analogue access (for the simulation of PSTN or of analogue phones behind an ATA box or an ADSL modem);
- ISDN access;
- handset (for any wireline terminal);
- electrical input and output (for PC soundcards or for any wireless terminal);
- GSM;
- UMTS;
- Ethernet with IP phone termination (SIP, Recommendation ITU-T H.323 [i.16], MGCP, etc.).

Any combination of end-to-end connection between the types of access mentioned here has to be considered when a measurement campaign is scheduled. Nevertheless there are practical limitations:

- the number of measurements for a given type of access should be in proportion with its level of use in a real scenario;
- the number of probes and of measurement results available will be adapted to the real needs as well as to the capacity (mostly in terms of cost and processing capability) of the entity running these measurements.

Figure 4.1 shows these different configurations and interfaces.

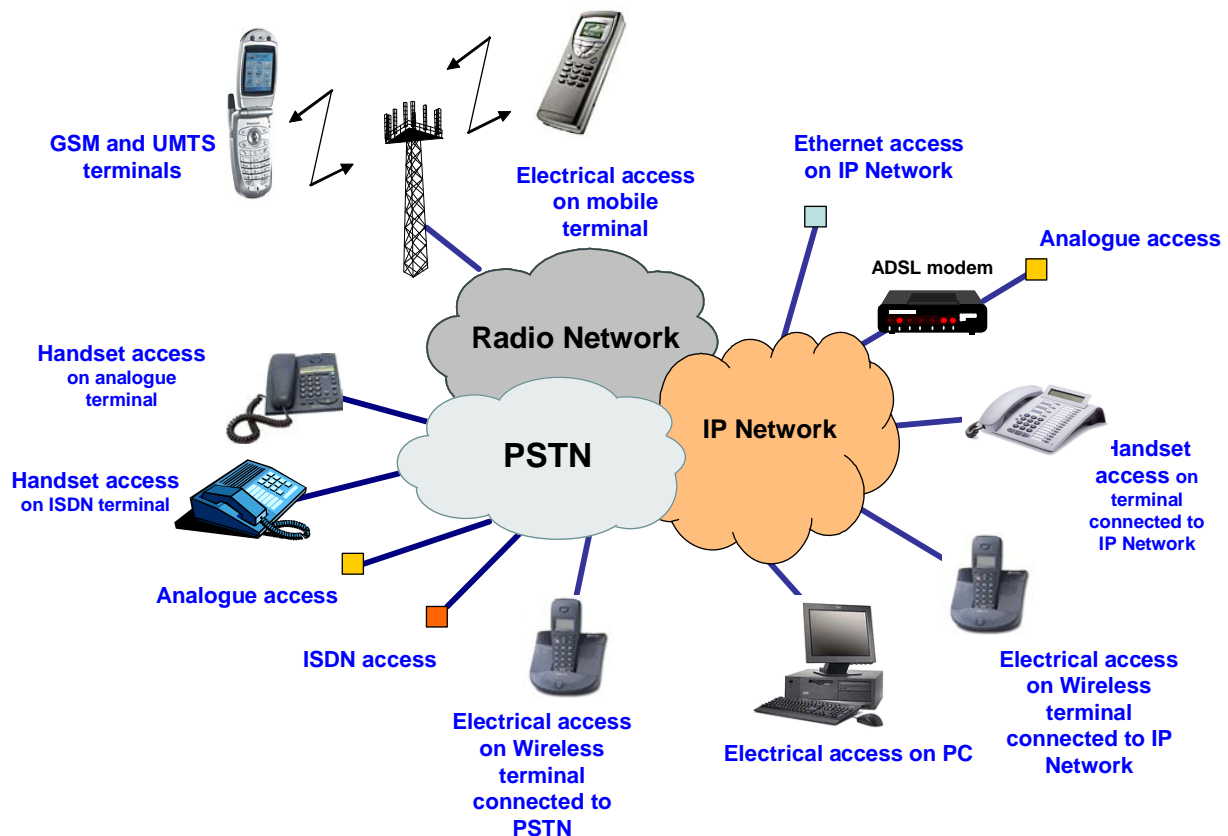

Figure 4.1: Possible configurations and interfaces in context of user characterization

5 Measurement type

To perform quality services assessments, there are two different methods: intrusive and non intrusive measurements.

The non intrusive measurements are not really adapted to end user surveys because it requires installing probes at the user's terminals.

The intrusive measurements are more adapted to end user surveys because probe connection with end user terminals is easier. Compared to non intrusive measurements, the intrusive methods have an advantage: the opportunity for voice quality assessment to use models with references such as Recommendation ITU-T P.862 [i.2] (see also Recommendations ITU-T P.862.1 [i.3] and P.862.3 [i.4] concerning mapping functions and application guide) or Recommendation P.863 [i.21] (see also Recommendation ITU-T P.863.1 [i.22] concerning application guide) which give results close to subjective perception of the speech quality.

In this context, the intrusive measurements using models working with references for speech quality assessment will be performed for end user survey.

6 Voice quality scale

It is important to consider that telephony has entered an era where traditional narrowband services will cohabit with new services offering wideband audio capacities. For end-users, these are not separated kind of services. Therefore, the assessment of transmission quality of voice should now be based on common metrics and objective quality levels and scales, in replacement of the existing narrow-band only ones. In this context, it is appropriate to use the MOS-LQOSW scale to characterize voice quality of narrow-band, wideband and super wideband services. See Recommendation ITU-T P.800.1 [i.5] for more information on MOS terminology.

7 List of indicators

The indicators for the context of end-user quality survey of voice services are given in the following clauses.

It should be noted that the indicators defined below do not completely cover the conversational quality. Additional indicators may be:

- double talk performance parameters;
- switching characteristics parameters.

7.1 Post Dialling Delay

Definition	Post Dialling Delay (PDD) evaluates service availability to set up calls in an acceptable delay. It is linked to the service architecture complexity, and to the performance of the constituting network elements. Post Dialling Delay is the time interval between the end of dialling by the caller and the reception back by him of the appropriate ringing tone or recorded announcement. Metric determines on one of the two access of the communication.
Assessment method	Indicator determines sequentially from the two access of call configuration. This indicator characterizes only the caller part of the configuration.
Unit	Millisecond with an integer value.
Standardization reference	
Significant	Mandatory.
Comment	This indicator has to be separated between call types (IP to IP, IP to PSTN, IP to mobile, etc.) for a detailed analysis. The objective set up in for universal telephony service has been set up to 2 900 ms in the French regulator recommendation.

7.2 Media establishment delay

Definition	Time determines on one of the two access of the communication, between off hook of the called and the beginning of voice signal receive.
Assessment method	Indicator determines sequentially from the two access of call configuration. On an IP access this indicator may be assessed by using a non-intrusive probe, such as a protocol analyser. Media establishment delay may be evaluated through the analysis of media flows and signalling. For Recommendation ITU-T H.323 protocol [i.16] the flow establishment delay corresponds to the time elapsed between the emission of the Recommendation ITU-T H.225.0 [i.17] "CONNECT" message and the arrival of the first IP packet including speech signal.
Unit	Millisecond with an integer value.
Standardization reference	
Significant	Optional.
Comment	This indicator has to be separated between caller and called site for a detailed analysis.

7.3 Unsuccessful call ratio

Definition	Ratio of unsuccessful calls to the total number of call attempts in a specified time period. An unsuccessful call is a call attempt to a valid number, properly dialled following dial tone, where neither called party busy tone, nor ringing tone, nor answer signal, is recognized on the access line of the calling user within 30 seconds from the instant when the address information required for setting up a call is received by the network.
Assessment method	Indicator determines sequentially from the two access of call configuration.
Unit	% with the resolution of 1 digit after the decimal point.
Standardization reference	Recommendations ITU-T E.800 [i.6], ITU-T E.845 [i.7], EG 201 769 [i.8].
Significant	Mandatory.
Comment	The limit of 30 seconds is the default set-up of a timer in SS7 protocol.

7.4 Premature release probability

Definition	This indicator characterizes the ability to release a service. It is based on the measurement of the number of released communications in comparison with the number of established communications. Released communications are defined as communications released before voluntary action from one of the ends of the transmission.
Assessment method	
Unit	% with the resolution of 1 digit after the decimal point.
Standardization reference	Recommendation ITU-T E.800 [i.6].
Significant	Optional.

7.5 Level of active speech signal at reception

Definition	<p>Level of speech signal received after transmission.</p> <p>The level of the signal heard by the user has an impact on the quality he will perceive. A too low signal will be hardly audible and masked by the noise, while a too high level will be painful.</p> <p>Therefore, a measurement of the speech signal level is necessary to ensure a good listening comfort.</p>
Assessment method	<p>The received decoded signal used for instance by Recommendation ITU-T P.862 [i.2] or Recommendation ITU-T P.863 [i.21] can be used to assess this parameter.</p> <p>A typical method for the measurement of this parameter, based on a sample by sample approach and a moving threshold between noise and speech, is given in Recommendation ITU-T P.56 [i.9].</p>
Unit	dBm with the resolution of 1 digit after the decimal point.
Standardization reference	Recommendation ITU-T P.56 [i.9].
Significant	Optional.
Comment	<p>Each sample of signal has a level, generally expressed in mV. The mean speech level is the transformation on an appropriate logarithmic scale of the mean signal voltage.</p> <p>The samples taken into account for this measurement are the ones seen as speech (the others are taken into account for noise measurements).</p> <p>It is recommended to fall within classical speech levels values, i.e. between -25 dBm and -10 dBm.</p>

7.6 Noise level at reception

Definition	<p>Level of noise determines at reception in non-speech segment of speech sample.</p> <p>Noise other than the speech signal can have characteristics that can become disagreeable, for instance if they have a varying spectrum (crowd noise for instance). But the more important source of annoyance due to noise is simply its level.</p>
Assessment method	<p>The received decoded signal used for instance by Recommendation ITU-T P.862 [i.2] or Recommendation ITU-T P.863 [i.21] can be used to assess this parameter.</p> <p>The measurement of these parameters is normally performed as for speech signal level (see clause 7.5), but on the samples identified as non-speech.</p>
Unit	dBmOp with the resolution of 1 digit after the decimal point.
Standardization reference	Recommendation ITU-T O.41 [i.10].
Significant	Optional.
Comment	<p>Each sample of signal has a level, generally expressed in mV. The mean noise level is the transformation on an appropriate logarithmic scale of the mean signal voltage of the noise samples.</p> <p>To get a more accurate noise level measure, a frequency transform needs to be done in order to apply a <i>psophometric</i> weighting (see Recommendation ITU-T O.41 [i.10]).</p> <p>It is recommended not to have noises louder than -50 dBmOp.</p>

7.7 Noise to signal ratio at reception

Definition	Difference between the active vocal level and the level of noise at the reception. Noise other than the speech signal can have characteristics that can become disagreeable, for instance if they have a varying spectrum (crowd noise for instance). But the more important source of annoyance due to noise is simply its level, and particularly the relative level compared to speech.
Assessment method	Combination of speech signal level (see clause 7.5) and noise level (see clause 7.6) can replace noise to signal ratio indicator. The received decoded signal used for instance by Recommendation ITU-T P.862 [i.2] or Recommendation ITU-T P.863 [i.21] can be used also to assess this parameter. Speech signal level/noise level = SNR. Indicator determines in the two directions of transmission.
Unit	dB with the resolution of 1 digit after the decimal point.
Standardization reference	Recommendation ITU-T P.56 [i.9].
Significant	Optional.
Comment	It is recommended not to have SNR lower than 30 dB.

7.8 Speech signal attenuation (or gain) after transmission

Definition	Variation metric of the speech signal level (if one knows the sending speech level, they are even redundant). Speech signal attenuation after transmission is the difference between the active vocal level at receiving and sending access.
Assessment method	The received decoded signal used for instance by Recommendation ITU-T P.862 [i.2] or Recommendation ITU-T P.863 [i.21] can be used to assess this parameter. Once the speech signal level has been computed (see clause 7.5), it is compared with the level of the sent signal. The attenuation is the difference between these two levels. There are other methods to compute this parameter, based for instance on intrusive measurement made with sine waves and a specific weighting function. Indicator determines in the two directions of transmission.
Unit	dB with the resolution of 1 digit after the decimal point.
Standardization reference	
Significant	Optional.
Comment	It is recommended to comply with PSTN attenuation rules, i.e. an attenuation between 6 dB and 10 dB.

7.9 Talker echo delay

Definition	<p>In telecommunications, the term echo describes delayed and unwanted feedback of the send signal into the receive path. The so-called echo source is the reflection point between send and receive directions, which could be one of the following causes:</p> <ul style="list-style-type: none"> • 4-wire/2-wire Hybrid Circuits (multiple reflections possible); • coupling in handset cords; • structure borne coupling in handsets; • acoustical coupling between earpiece and microphone. <p>This phenomenon is characterized by two parameters: its attenuation and its delay. See annex C for a more detailed discussion of talker echo and the related listener echo. With the increased delays present in today's IP networks, echo has the potential to be much more perceivable and annoying than in classical PSTN.</p> <p>In order to achieve a similar user perception with higher delays the attenuation of the talker echo should be increased, i.e. active echo cancellation is necessary.</p> <p>In practice it can be observed that in some cases, either the cancelling does not occur, or it is not fully performing.</p> <p>Echo is characterized by two parameters: its attenuation and its delay. The less attenuation and/or the more delay, the more the echo will become annoying.</p> <p>Echo delay is the time it takes for the speech signal to go from the mouth of a subscriber back to the ear of the same subscriber, with one or more reflections occurring along the transmission path.</p>
Assessment method	Indicator determines sequentially from the two access of call configuration.
Unit	Milliseconds with an integer value.
Standardization reference	Recommendation ITU-T G.131 [i.11].
Significant	Optional.
Comment	For fully digital networks the talker echo delay can be assumed to be equivalent to twice the mean one-way delay.

7.10 Talker echo attenuation

Definition	<p>In telecommunications, the term echo describes delayed and unwanted feedback of the sent signal into the receive path. The so-called echo source is the reflection point between send and receive directions, which could be one of the following causes:</p> <ul style="list-style-type: none"> • 4-wire/2-wire Hybrid Circuits (multiple reflections possible); • coupling in handset cords; • structure borne coupling in handsets; • acoustical coupling between earpiece and microphone. <p>This phenomenon is characterized by two parameters: its attenuation and its delay. See annex C for a more detailed discussion of talker echo and the related listener echo. With the increased delays present in today's IP networks, echo has the potential to be much more perceivable and annoying than in classical PSTN.</p> <p>In order to achieve a similar user perception with higher delays the attenuation of the talker echo should be increased, i.e. active echo cancellation is necessary.</p> <p>In practice it can be observed that in some cases, either the cancelling does not occur, or it is not fully performing.</p> <p>Echo is characterized by two parameters: its attenuation and its delay. The less attenuation and/or the more delay, the more the echo will become annoying.</p> <p>Echo attenuation is the difference of level between the sending level and the (delayed) receiving level both measured at the same subscriber while he is talking.</p>
Assessment method	Indicator determines sequentially from the two access of call configuration.
Unit	dB with a resolution of one decimal.
Standardization reference	Recommendations ITU-T G.131 [i.11] and ITU-T G.168 [i.12].
Significant	Optional.
Comment	<p>If active echo cancellation is used, Recommendation ITU-T G.168 [i.12] should be applied; VoIP should provide echo attenuation of 55 dB. If the delay under all circumstances is known to not exceed 50 ms lower values for the talker echo attenuation (down to 35 dB) may be acceptable (see annex C).</p> <p>Echo annoyance depends on two metrics: the attenuation and the delay. For a similar attenuation level greater the delay is more important the annoyance will be for the user(s).</p> <p>Echo-Annoyance factor is defined as K. $K = EA - 40 \times \text{Log} \left[\frac{(1 + \text{delay}/10)}{(1 + \text{delay}/150)} \right] + 6 \times \exp(-0,3 \times \text{delay}^2)$</p> <p>NOTE: It is recognized that, besides insufficient echo talker attenuation, short term echo artefacts may occur which are not covered by this measurement.</p>

7.11 Listening speech quality

Definition	Represents the intrinsic quality of speech signal after transmission. This indicator takes into account the degradations generated on the signal by the transmission links.
Assessment method	<p>Two models are available for voice quality evaluation:</p> <ul style="list-style-type: none"> • Recommendation ITU-T P.862 [i.2] with the mapping functions according to Recommendation ITU-T P.862.1 [i.3]; adapted to assess narrow band communications; • Recommendation ITU-T P.863 [i.21]; adapted to assess narrow band, wide band and super wide band communications. <p>Both models determine a Mean Opinion Score - Listening Quality Objective (MOS-LQO) which is an objective view on the quality of the voice signal as it may be perceived by the customer.</p> <p>The MOS-LQO score is obtained by comparing speech samples:</p> <ul style="list-style-type: none"> • the original signal sent by the far end of the connection; • the degraded signal received at the local end, where the measurement is applied. <p>Since during a call, speech quality can vary, several MOS-LQO scores should be determined in series during the same call. So for a given transmission way, listening speech quality performance during the call is defined by the mean value of MOS-LQO measurements (in the same direction).</p> <p>The voice quality indicator should be determined in both transmission directions. It is important that speech quality analyses are performed for the same call according to the direction of transmission. It is also important that speech quality analyses are performed from the beginning to the end of the call, by alternating the direction of transmission for the MOS-LQO score determination. If the first evaluation is made in the direction A to B, the second evaluation should be realized in the direction B to A, the third in the direction A to B, the fourth in the direction B to A and so on. Hence the number of analyses will be equal for each transmission direction.</p> <p>The use of the Recommendation ITU-T P.862 [i.2] has some limitations. Recommendation ITU-T P.862.3 [i.4] provides some important remarks that should be taken into account in the objective quality evaluation of speech conforming to Recommendations ITU-T P.862 [i.2] and P.862.1 [i.3]. The use of the Recommendation ITU-T P.863 [i.21] also has limitations. Recommendation ITU-T P.863.1 [i.22] provides important explanations that should be taken into account in the objective quality evaluation of speech. Users of Recommendation ITU-T P.862 [i.2] and users of Recommendation ITU-T P.863 [i.21] should understand and follow the respective guidance given with these Recommendations.</p>
Unit	Note between 1 (= very bad) and 5 (= excellent) determines on MOS-LQO scale with a resolution of one digit after the decimal point.
Standardization reference	Recommendations ITU-T P.800.1 [i.5], ITU-T P.800.2 [i.23], ITU-T P.862 [i.2], ITU-T P.862.1 [i.3], ITU-T P.862.3 [i.4], ITU-T P.863 [i.21] and ITU-T P.863.1 [i.22]. TR 102 506 [i.20]
Significant Comment	<p>Mandatory.</p> <p>General comments:</p> <p>The value of this indicator depends on the used codec, but also on impairments like IP packet loss or low signal to noise ratio.</p> <p>To make easier result comparisons, it is recommended to use the same speech samples and quality scales in all test configurations.</p> <p>Recommendations ITU-T P.862 [i.2] and ITU-T P.863 [i.21] are measuring listening quality and do not take into account impairments affecting conversational quality, like the end-to-end delay or echo.</p> <p>It is also a one-way indicator; therefore it has to be measured separately in both transmission directions, with no average between them afterwards.</p> <p>This indicator should be evaluated separately for each call type (IP to IP, IP to PSTN, IP to Mobile, etc.) for a detailed analysis.</p> <p>MOS-LQO scales:</p> <p>The implementation of Recommendation ITU-T P.862 [i.2] with the mapping functions according to Recommendation ITU-T P.862.1 [i.3] involves the determination of a MOS-LQO indicator on a narrowband scale (MOS-LQON). This implementation applies only on narrowband conditions.</p>

The implementation of Recommendation ITU-T P.863 [i.21] in the super-wideband mode involves the determination of a MOS-LQO indicator on a super-wideband scale (MOS-LQOSW). This implementation applies on narrow-band, wide-band and super wide-band conditions.

Because super-wideband scale is not a simple extension of the narrowband scale, it is not possible to map a narrowband score to a super-wideband scale or the other way.

Choice of model:

Recommendation ITU-T P.863 [i.21] should be preferred.

But if Recommendation ITU-T P.862 [i.2] is already being used for characterization in a purely narrowband context, and if this context is not likely to be concerned by modification of the time scale of received signals (e.g. by the application of time warping mechanisms), then this Recommendation can still be used.

Reference signal:

Particular attention should be paid to the choice of the test signal (reference signal).

The reference signal used with the Recommendation P.863 [i.21] should comply with different constraints (transparency, duration, active speech level, noise floor, etc.).

The full list of tests required to validate the reference signal is described in the Application Guide, Recommendation ITU-T P.863.1 [i.22].

Settings:

To characterize a given configuration, it is recommended to perform at least 25 to 30 measurements before calculating a mean value of the MOS-LQO. This mean value of the MOS-LQO could be calculated as in TR 102 506 [i.20].

Recommendation ITU-T P.863 [i.21] has the ability to assess the voice quality by taking account of speech level modification. Nevertheless, it is highly recommended to enable the level alignment option.

7.12 Listening speech quality stability

Definition	<p>It is well known that for IP networks, delay within the network can vary significantly, due to congestion or indeed due to route changes during a session. Delay variations in the network can be compensated to some extent through good jitter buffer design in the receiver. Furthermore, packet loss in the network can occur due either to severe congestion (buffer overflows) or routing problems, or in a receiver terminal due to jitter buffer overflow. These factors will impact on the quality of the service.</p> <p>Concerning voice over IP, a single measurement of speech quality once at the very beginning of a call is not enough. They should be analysed all along the duration of the call, typically several minutes.</p> <p>This metric represents the stability of the voice quality during a communication of several minutes long. This indicator takes into account the degradations generated on the signal by the transmission links.</p>
Assessment method	<p>Several measurements of MOS-LQO score performed with Recommendation ITU-T P.862 [i.2] with the adapted mapping function or Recommendation ITU-T P.863 [i.21] (see clause 7.11) are performed in series within the same call.</p> <p>The assessment of Listening Speech Quality Stability is performed in 5 steps. The generic formulation is presented in annex A.</p> <p>For stability indicator about Listening Speech Quality, THRESHOLD1 = 0,1 and the linear weighting function applies in order to express Stability (ST-MOS) on a 0 to 100 scale. By definition Stability equals 100 when no instability occurs and Stability ST-MOS equals 0 when instability is equal or more than 0,4.</p> <p>ST-MOS is calculated as:</p> <ul style="list-style-type: none"> • ST-MOS = 100 - (250 × INS_MOS); and • ST-MOS = 0 if [100-(250 × INS_MOS)] < 0. <p>This indicator is determined in the two directions of transmission.</p>
Unit	Statistics on MOS-LQO score variation are plotted on a 0 to 100 scale.
Standardization reference	
Significant	Mandatory.
Comment	The determination of this indicator is meaningful only if MOS-LQO scores are determined from the beginning to the end of the call by making successive analyses for alternating transmission directions.

7.13 End-to-end delay

Definition	<p>Represent the global delay from one access to the other one. This indicator takes into account the transmission delay on networks but also processing delay in sending and receiving terminals.</p> <p>End-to-end delay is one of the components of perceived voice quality, may be the major one in VoIP. A great delay impacts negatively on QoS perceived by customer.</p>
Assessment method	<p>The end-to-end delay is the delay from mouth to ear, which means the transmission delay over the whole transmission path. For the purpose of the present document, end-to-end delay does not take into account the transducers delay (loudspeaker and microphone) while measurements are done at the electrical interfaces of the end terminals.</p> <p>To measure end-to-end delay it is needed to ensure a synchronization of both transmission ends of the measurement device. This synchronization may be done by GPS clocks when the two ends are distant. When ends are co-located synchronization may be done directly by the analyser.</p> <p>To assess the metric, the clock accuracy of the analyzer (or two analyzer parts) should be better than 10 ppm.</p> <p>Since during the call, end-to-end delay can vary, several measurements of delay are performed in series during the same call. So for a given transmission way, end-to-end delay performance during the call is defined by the mean value of delay measurements (in the same direction).</p> <p>The end-to-end delay is determined in both directions of transmission. It is important that delay measurements are performed during the same call according to the direction of transmission. It is also important that delay measurements are performed from the beginning to the end of the communication, by alternating the direction of transmission. If the first evaluation of delay is performed in the direction A to B, the second evaluation should be realized in the direction B to A, the third in the direction A to B, the fourth in the direction B to A and so on. Hence the number of analyses will be equal for each transmission direction.</p> <p>The end-to-end delay is calculated as the mean value of measurements in each transmission direction.</p>
Unit	Millisecond with an integer value.
Standardization reference	Recommendation ITU-T G.114 (session 1) [i.13].
Significant	Mandatory.
Comment	<p>The metric measurement needs time synchronization between the two parts of the analyzer connected to the both access of the communication path.</p> <p>The recommendations (Recommendation ITU-T G.114 [i.13] in particular) indicate not going beyond 150 ms in one-way.</p>

7.14 End-to-end delay variation

Definition	<p>End-to-end delay variation can occur, principally caused by changes within the network but also by sender and receiver terminals (e.g. Jitter buffer). This will have an impact on the quality of the service.</p> <p>Concerning voice over IP, the single measurement of end-to-end delay once at the very beginning of a call is not enough. It should be analysed all along the duration of the call, typically several minutes.</p> <p>This metric defines the stability of end-to-end audio delay during a communication of several minutes.</p>
Assessment method	<p>Several measurements of delay (according to clause 7.13) are performed in series, or the delay is measured at every short period within the same call. The results are reported in terms of statistics.</p> <p>End-to-end delay variation is defined from an indicator of the stability of delay variation, over a single communication.</p> <p>As for listening speech quality, the calculation of this indicator is performed in 5 steps. The generic formulation is presented in annex A.</p> <p>For stability indicator about end-to-end delay, THRESHOLD1 = 5 and the linear weighting function applies in order to express Stability (ST-Delay) on a 0 to 100 scale. By definition Stability equals 100 when no instability occurs and Stability ST-Delay equals 0 as soon as instability reaches or is greater than 10.</p> <p>ST-Delay is calculated as the following linear weighting:</p> <ul style="list-style-type: none"> • $ST\text{-Delay} = 100 - (10 \times INS_Delay)$, and • $ST\text{-Delay} = 0$ if $[100 - (10 \times INS_Delay)] < 0$. <p>This indicator is determined in the two ways of transmission.</p>
Unit	Statistics on delay variation are plotted on a 0 to 100 scale.
Standardization reference	
Significant	Mandatory.
Comment	The determination of this indicator is meaningful only if end-to-end delays are determined from the beginning to the end of the call by making successive analyses for alternating transmission directions.

7.15 Frequency responses at the reception

Definition	<p>Narrow-band telephony should transmit signals between 300 Hz and 3 400 Hz. Wide-band telephony should transmit signals between 50 Hz and 7 000 Hz.</p> <p>The objective of this measurement is to see what bandwidth is used, and also to see whether a partial and unwanted bandwidth limitation is present.</p> <p>Frequency response is the gain (or attenuation) of the level of speech signal after transmission according to frequency.</p>
Assessment method	<p>The received decoded signal as defined in Recommendation ITU-T P.862 [i.2] or Recommendation ITU-T P.863 [i.21] can be used also to assess this parameter.</p> <p>In general, a simple spectral transformation of the signal is enough. The attenuation or level of the signal is then measured for a selected number of frequencies (or frequency bands).</p> <p>For the purpose of the present document the measurement of the receiving frequency response needs to take into account the characteristics of the terminals transducers (loudspeaker and microphone). The analyses are done at the electrical interfaces of the terminals, it is necessary to ensure a calibration of the frequency response of the transducers. This calibration offers the possibility to adapt the electrical measurement values and to assess the actual frequency response at the receiving end (see calibration method in annex B).</p>
Unit	Boolean (pass or fail) compared to a mask or value representing size of the frequency band used.
Standardization reference	
Significant	Optional.

8 Measurement frequency

Measurements need to take into account the possible variations of quality versus time. In this context, it is important to adapt the measurement frequency with the possible variations of quality. So it does not seem reasonable to go beyond 10 to 15 minutes between two consecutive calls on the same connection. A measurement frequency of 4 or 5 analysis by hour is adapted to end-user quality survey of voice services. This recommended measurement frequency applies for all indicators defined in clause 7 of the present document.

9 Duration of test calls

Measurements need also to take into account the possible variations of quality during a call. In this context, it is important to adapt duration of test calls with the possible variations of quality inside the same communication. So, it does not seem reasonable to decrease call duration below 3 minutes. The duration of test calls should allow a correct determination of voice quality stability and end-to-end delay stability. Therefore, 5 minutes seems to be a relevant duration for an accurate assessment. Such duration of test calls is applied only for two indicators: the listening speech quality and the end-to-end delay metrics (defined in clause 7 of the present document). During the call period test, these two metrics are periodically measured in order to determine stability of speech quality and variation of end-to-end delay at the end of the call.

10 Measurement configurations

Measurement configurations should represent the use cases of telephony services.

10.1 VoIP services

For VoIP services, there are several use cases, but the most important of them (in terms of traffic) are:

- IP to PSTN;
- IP to Mobile; and
- IP to IP.

In the context, for VoIP services, the 3 configurations IP to PSTN, IP to mobile and IP to IP have to be analyzed. It means that for every "point of measure" (define by the measurement frequency), the 3 configurations are analysed. These 3 analyses can be performed sequentially.

10.2 VoIP services in triple play context

In case of VoIP services included in triple play offers (data, VoIP, IPTV) it is necessary to assess the voice service alone and in the multiple usage condition, e.g. Voice + TV, Voice + peer-to-peer downloading, voice + TV + peer-to-peer downloading.

11 Measurement locations and their distribution

11.1 Measurement location requirements

Quality assessment of telephony service using an intrusive method (based on test calls) has the advantage of precisely analysing voice quality over defined configurations. This advantage is due to taking benefit of an end-to-end analysis using test signals. The whole transmission path is taken into account and the result is well correlated with user's perception.

The main drawback of this kind of analysis is to provide a limited view of the quality, because restricted to the analysed test configurations. It is known that for some kinds of transmission (e.g. packet transmission such as IP Protocol) the measurements done on one configuration are not easily applicable to the overall services.

Concerning VoIP several factors may influence telephony service quality and may introduce quality differences from one configuration to other, from a location to another one. Among these factors the engineering rules applied by the operator or service provider and the offer subscribed by the users. Other factors may be the network architecture including several equipments (home gateway, DSLAM, BAS, Call Server, Media Gateway, etc.) in the transmission path and several manufacturers for each type of equipment.

Hence a combination of configurations may dramatically increase and as a consequence differences in quality may occur for the same telephony offer. It should also be indicated that the capabilities of traffic flow may change from a geographical location to another one depending on the number of users and on network dimensions.

Only one measurement termination is not enough to obtain a macroscopic view of the service quality offered to the users. Ideally it should be necessary to deploy an analysis point per configuration but economic costs associated to probes (to buy and to install) are not realistic.

If only one analysis point and one analysis point per configuration are not satisfactory solutions for the supervision of the quality of IP telephony services, it is clear that more important the point number is better the service supervision will be. It is also important that the measurement points be located over the whole areas covered by the telephony offer but also that these measurement points be spread according to the size of "area".

In these conditions we can define 5 types of geographical areas to be covered by the analysis points:

- "Areas" with more than 1 000 000 inhabitants.
- "Areas" from 500 000 to 1 000 000 inhabitants.
- "Areas" from 250 000 to 500 000 inhabitants.
- "Areas" from 25 000 to 250 000 inhabitants.
- "Areas" with less than 25 000 inhabitants.

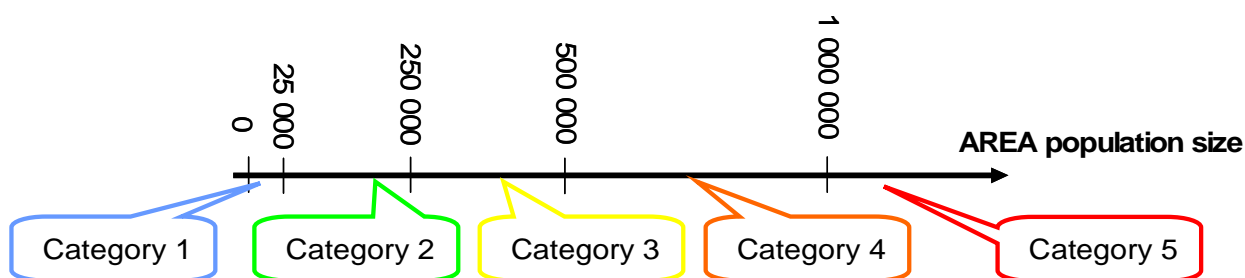

Figure 11.1: Definition of 5 "area" categories depending on population size

The term "area" can correspond to different perimeters according to its definition. "Area" can correspond to the strict perimeter of cities or to the perimeter of a set of cities making an urban continuity. It can also correspond to a large perimeter of several cities not realizing a continuous urban pattern. The definition of "area" is specific in every country and has to take into account its characteristics (population size, urbanization mode, administration perimeters, etc.). Consequently, the definition of "area" is to be considered separately in every country.

We may also define 2 types of offer perimeters:

- Offers addressed to a potential population of users greater or equal to 10 000 000 (group 1).
- Offers addressed to a potential population of users lower than 10 000 000 (group 2).

For offers of group 1 at least 10 analysis points are to be distributed over the 5 types of geographic areas.

For offers of group 2 at least 5 analysis points are to be distributed over the 5 types of geographic areas.

11.2 Method to determine measurement locations

The following method can be applied to determine the location of the different measurement points.

For a country:

- First step consists of determining the minimum number of required measurement point locations. For that purpose, it is necessary to know the potential population of users addressed by telephony offers because as described in clause 11.1, the population size determines the minimum number of analysis points required for this country. If the population of users is less than 10 million, 5 analysis points are required. But if population of users is greater or equal to 10 million then 10 analysis points are required.
- Second step is to define the area perimeter by taking into account the specificities of this country.
- Third step is to identify the different areas and to classify them into the 5 categories as defined above. When area classification is done, we identify the number of effective categories. According to the country size, population size, urbanization mode, and to the definition of area perimeter, it is possible that there is no area classified in category 5 or in category 1. In that case the effective number of categories is less than 5.
- Fourth step is to choose a first series of measurement points by respecting the requirement of at least one measurement location by effective category.

- Fifth step is to complete (if necessary) the location distribution with a second series of measurement points by respecting the requirement on the minimum number of measurement points (minimum number determined at the first step). In steps 4 and 5, it is recommended to choose the location of analysis points by respecting a rather homogeneous geographical distribution.

To illustrate this method of choice and allocation of measurement points, two examples are presented in annex D.

12 Results presentation

For reporting, the presentation of each metric will be made separately. Each metric will be presented on its own scale.

For each indicator, presentation results consist at least of presenting metric value, number of measurements to determine the metric value and measurement standard deviation.

But in order to give a quick overview of all quality parameters, a specific representation (overview visualization defined in Recommendation ITU-T P.505 [i.14]) of the metric value will be used. This representation reveals at one glance the strengths and weaknesses of telephony services by reference to non-compliant limits.

12.1 One-view visualization of performances

The one-view visualization is based on a circular presentation of indicators ("pie diagram") where each metric value represents a circle segment of the diagram.

12.1.1 Pie diagram with all indicators

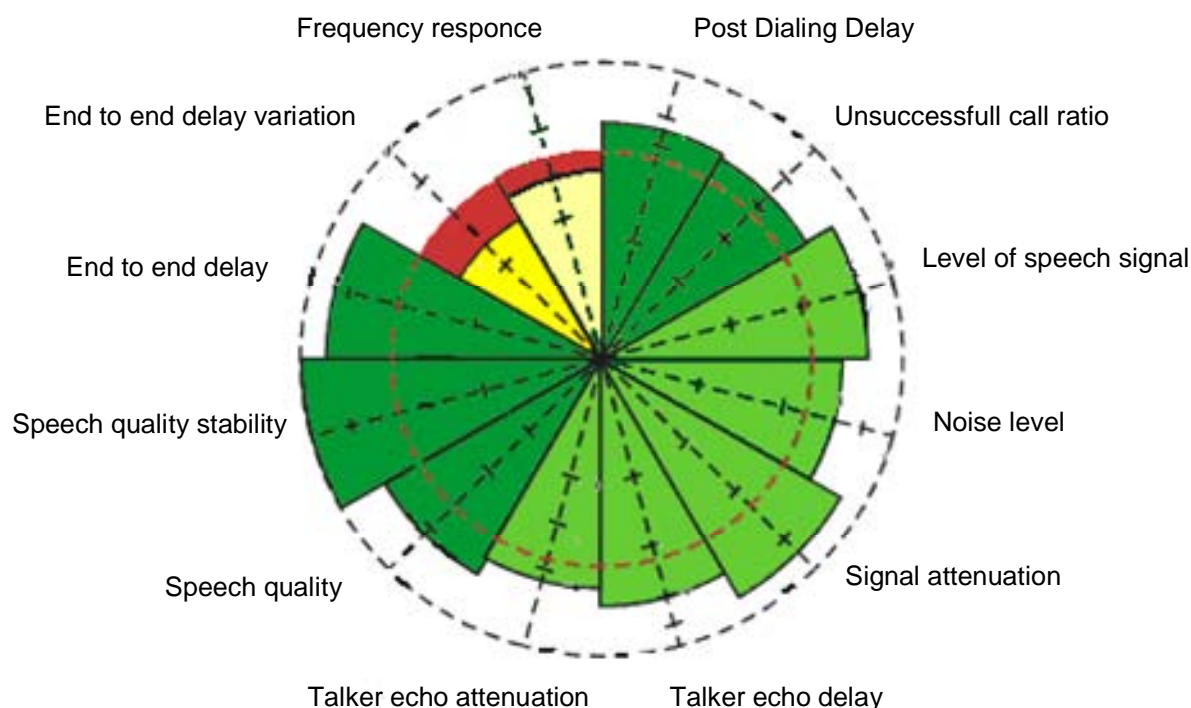

NOTE: This representation is associated to one of the transmission paths.

Figure 12.1: Example of "pie diagram" representation performed with all the indicators (mandatory and optional)

12.1.2 Pie diagram with mandatory indicators

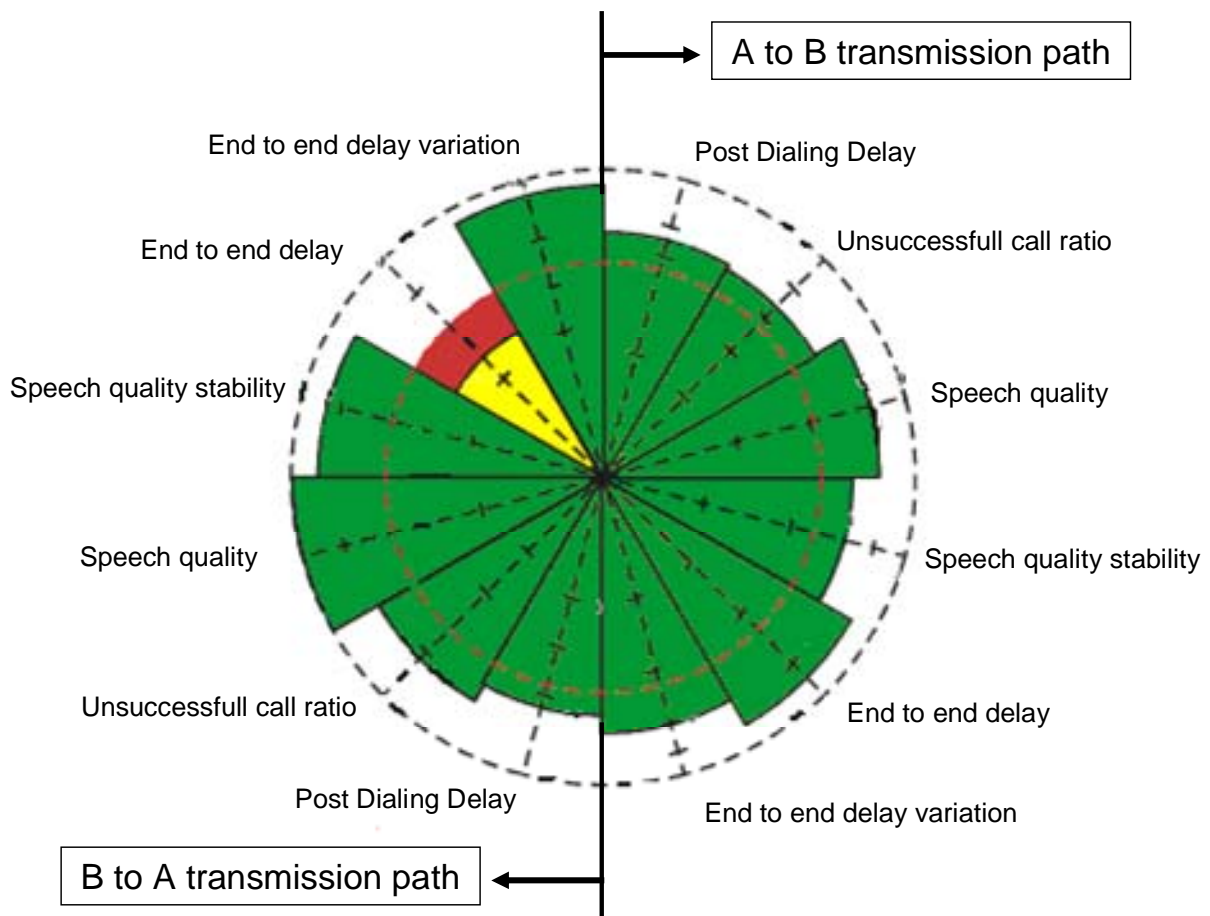

NOTE: This representation presents performances in both transmission paths.

Figure 12.2: Example of "pie diagram" representation performed with only mandatory the indicators

12.2 Non-compliant limits for result visualization

Table 12.1

Indicator name	Value of non-compliant limit	Unit
Post Dialling Delay	6 000	Millisecond
Media establishment delay	1 000	Millisecond
Unsuccessful call ratio	2	%
Premature release probability		%
Level of active speech signal		dBm
Noise level		dBm0p
Noise to signal ratio		dB
Speech signal attenuation		dB
Echo-Annoyance factor		
Listening speech quality		
Listening speech quality stability		
End-to-end delay	200	Millisecond
End-to-end delay variation		
Frequency response		

NOTE: When we will have elements allowing to fix new compliant limit, table 12.1 will be amended.

13 Publication of the results

For the supervision of a telephony offer, a publication of the characterization results of this offer can be published in a monthly, weekly or even daily way.

For the supervision and the comparison of several telephony offers, a publication of the characterization results of these offers can be published in a monthly and/or weekly way. A daily publication is not adapted to these particular conditions because it corresponds to too short an analysis window giving no real sense to the comparisons.

Annex A (normative): Indicator stability formulation

A.1 Presentation

The purpose is to assess stability indicators for different metrics like listen speech quality and end-to-end delay. These stability indicators should characterize metric stability during the call.

For speech quality, the stability indicator should be independent of the intrinsic quality of the codec because stability indicator completes speech quality indicator. So, stability indicator is based on derived formulation. It is a "simple" formulation, easy to be implemented.

It is also a dynamic indicator, i.e. it can be determined during the call and does not need that the communication is ended to begin the determination.

A.2 Formulation

The assessment of METRIC Stability (ST-METRIC) may be defined in 5 steps:

- 1) To measure the METRIC periodically over the duration of one communication. N measurements provide N METRIC values.
- 2) For each METRIC (i) value i from 2 to N, METRIC_GAP(i) is calculated as the absolute difference with the previous value METRIC (i-1):

$$\text{METRIC_GAP}(i) = |\text{METRIC}(i) - \text{METRIC}(i-1)|$$

- 3) In order to take into account the subjective perception and measurement accuracy, METRIC_GAP (i) is set to 0 when the difference is equal or lower to THRESHOLD1:

if METRIC_GAP (i) > (2 x THRESHOLD1), then METRIC_GAP (i) = METRIC_GAP (i);

if THRESHOLD1 < METRIC_GAP (i) ≤ 2 x THRESHOLD1, then METRIC_GAP (i) = [METRIC_GAP (i) x 2] - (2 x THRESHOLD1);

if METRIC_GAP (i) ≤ THRESHOLD1, then METRIC_GAP (i) = 0.

- 4) The instability (INS_METRIC) associated to the METRIC over the whole N measurements is defined by mean value of METRIC_GAP (i).

$$\text{INS_METRIC} = 1/(N-1) \sum \text{METRIC_GAP}(i) \text{ with } i = [2:N].$$

- 5) A linear weighting function is applied in order to express Stability ST-METRIC on a 0 to 100 scale.

This formulation can be used to determine Listen Speech Quality Stability (ST-MOS) and end-to-end delay Stability (ST-Delay).

For these two metrics, only THRESHOLD1 value and linear weighting function are specifics.

A.3 Graphic illustration of the formulation

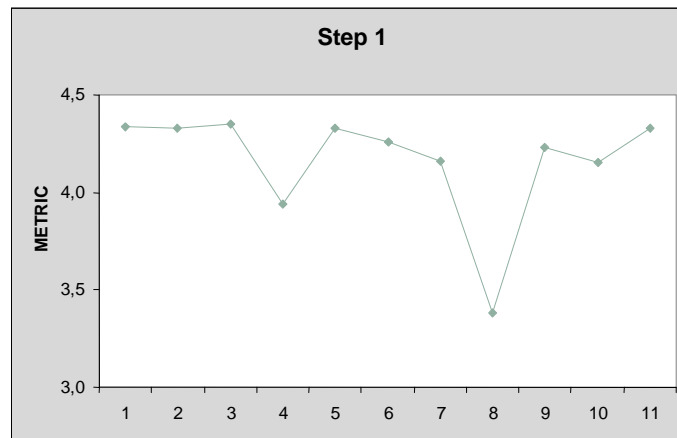

NOTE: N METRIC value is determined during a call.

Figure A.1

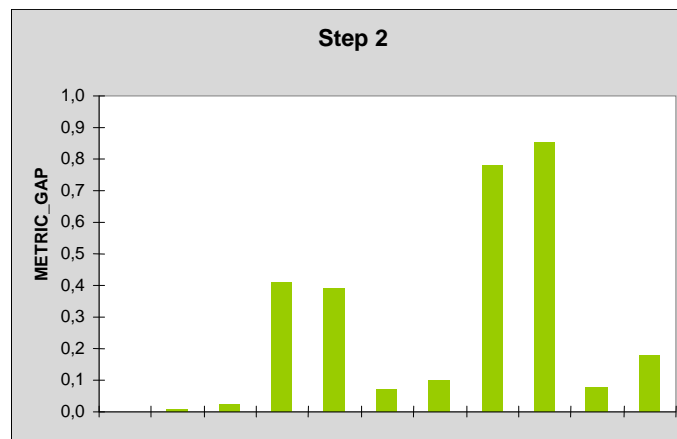

NOTE: For each METRIC value the difference with the previous value is calculated.

Figure A.2

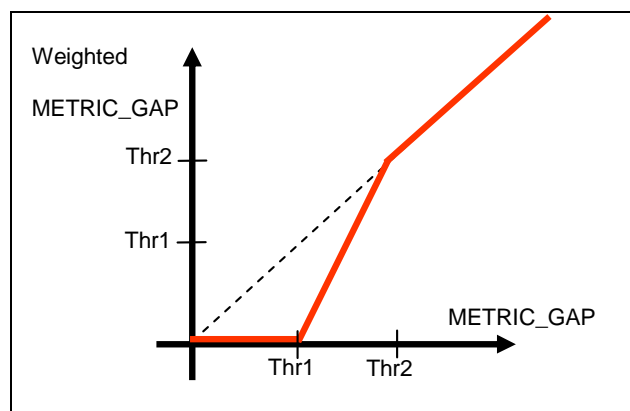

NOTE: The weighted function applies to METRIC_GAP values:
 Thr1 = THRESHOLD1 and Thr2 = 2 x THRESHOLD1.

Figure A.3

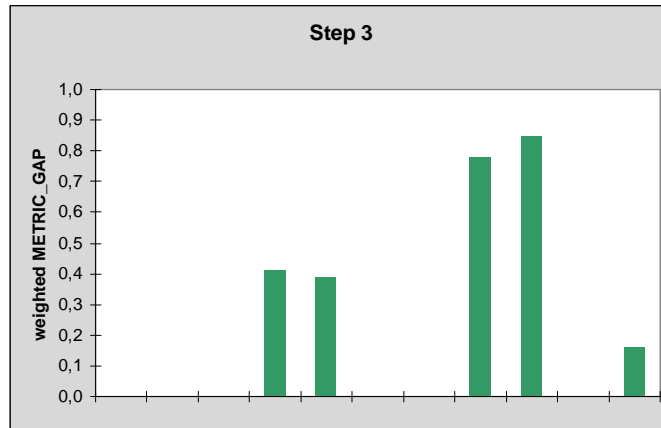

NOTE: Weighted METRIC_GAP calculated with the weighted function.

Figure A.4

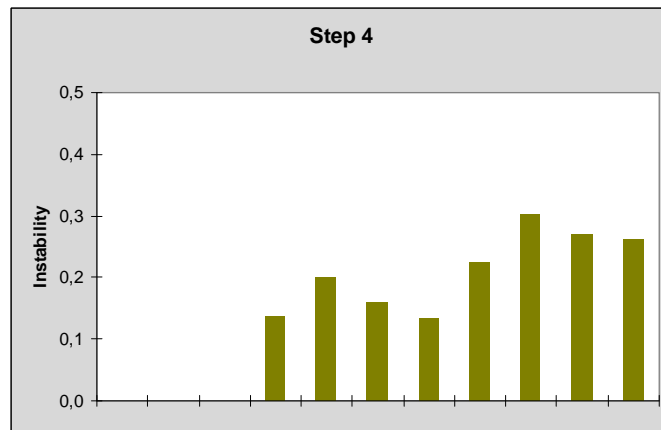

NOTE: The METRIC instability is calculated for each METRIC_GAP value.

Figure A.5

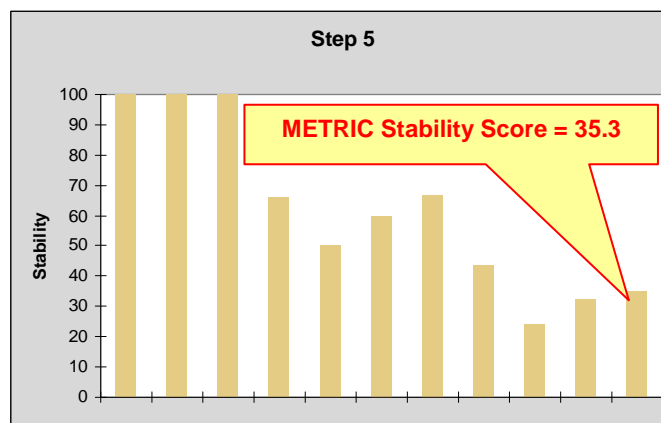

NOTE: Stability score is calculated for each instability value and the last value represents the METRIC stability score for the call.

Figure A.6

A.4 Some examples of stability indicator calculated on Listening Speech Quality

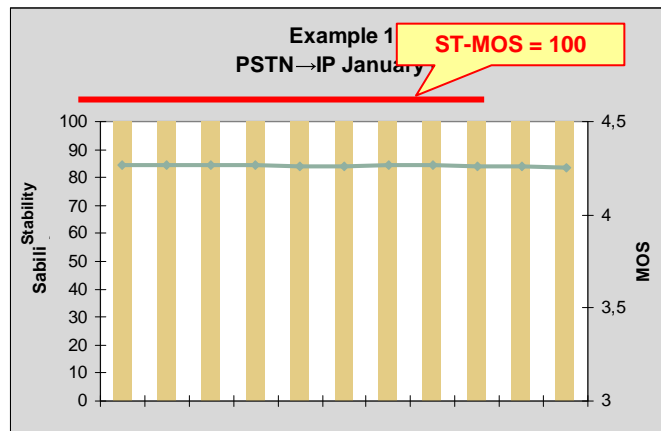

Figure A.7

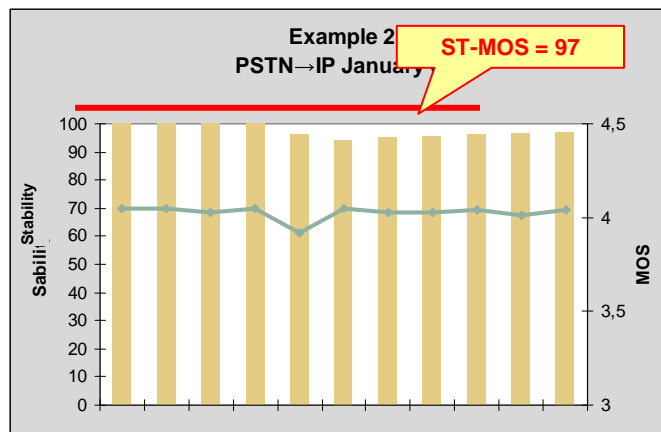

Figure A.8

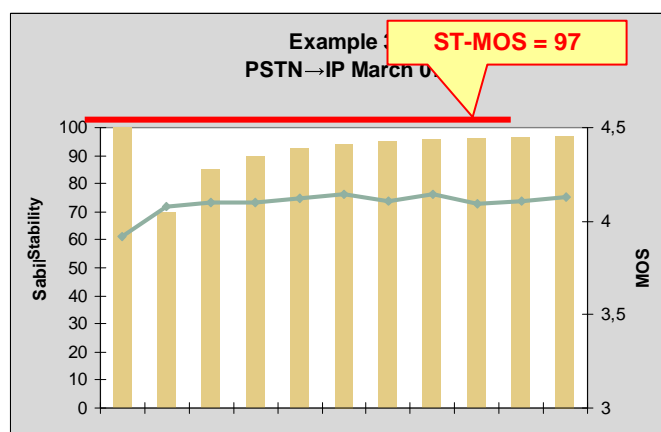

Figure A.9

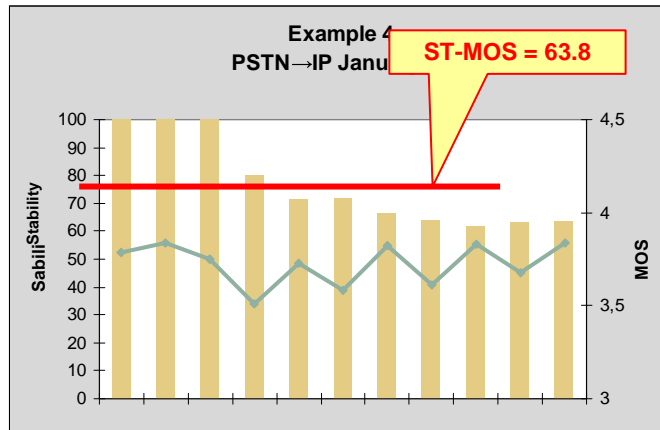

Figure A.10

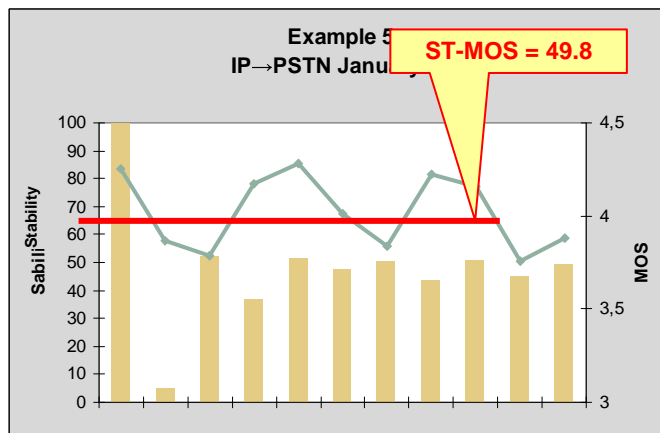

Figure A.11

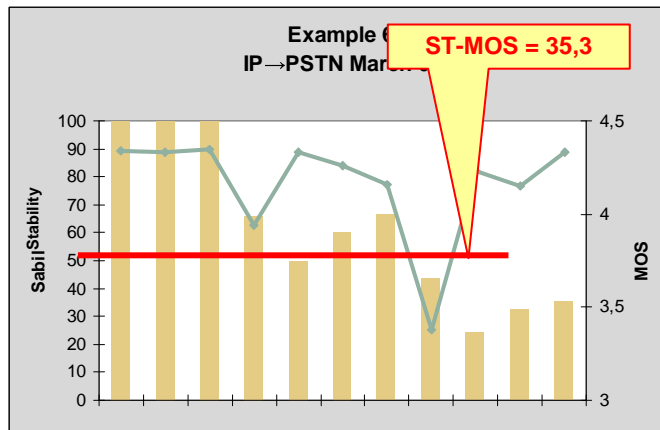

Figure A.12

Annex B (normative): Calibration to take into account the frequency response of transducers

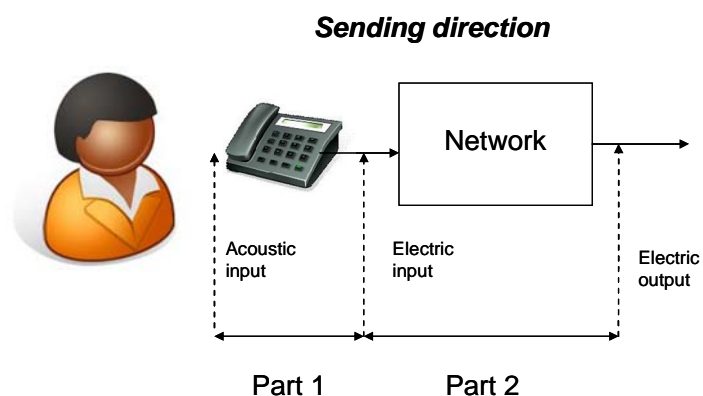

Figure B.1

In most cases quality evaluation is performed for part 2 (electric to electric), but it is necessary to take into account the influence of part 1 (acoustic to electric).

Measurements taking into account acoustic are more complex (necessity of quiet environment, defined stimuli, etc.).

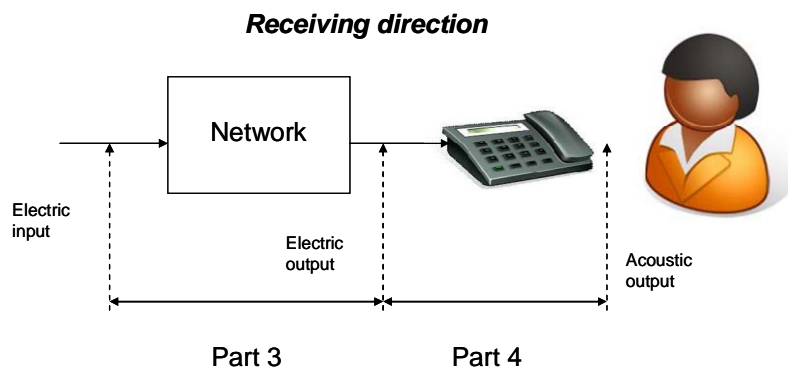

Figure B.2

For receiving, the problem is the same, electric to acoustic (part 4) has to be taken into account, with the same difficulties as for sending.

B.1 Method presentation

B.1.1 Sending

Make a transfer function for part 1. Artificial voice (Recommendation ITU-T P.50 [i.18] or Recommendation ITU-T P.501 [i.19] signal) can be used or any desired signal with HATS as artificial mouth.

For measurement of part 2 two options:

- Resulting signal can be used for analyzing the network.
- Transfer function obtained can be inserted in measurement (the transfer function used here is electric to electric taking into account HATS).

B.1.2 Sending

Make a transfer function for part 4. Artificial voice (Recommendation ITU-T P.50 [i.18] or Recommendation ITU-T P.501 [i.19] signal) can be used or any desired signal (with HATS as measuring system).

The obtained transfer function is applied to the result of measurement of part 3.

B.1.3 Global communication

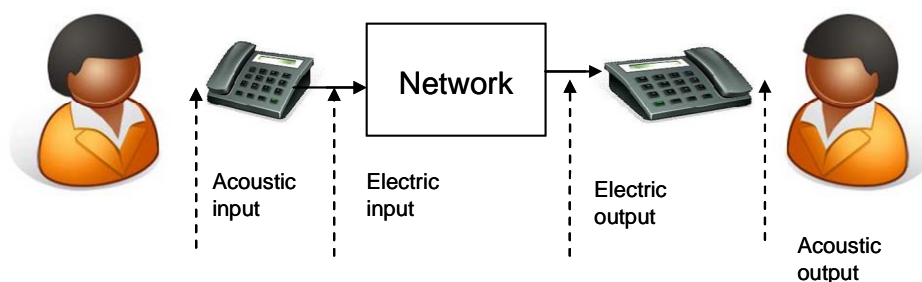

Figure B.3

The first transfer function (sending part of terminal) will be applied to signal at input of network and the second transfer function (receiving part of terminal) will be applied to resulting signal.

B.1.4 Applications

Network with defined terminals:

- Transfer functions are measured at the beginning for the terminal and all following measurements can be made without taking into account the acoustic part.

Network using unknown terminals:

- A first characterization can be made with transfer function corresponding to a standard (average) terminal.

Annex C (informative): Echo presentation

C.1 Talker echo

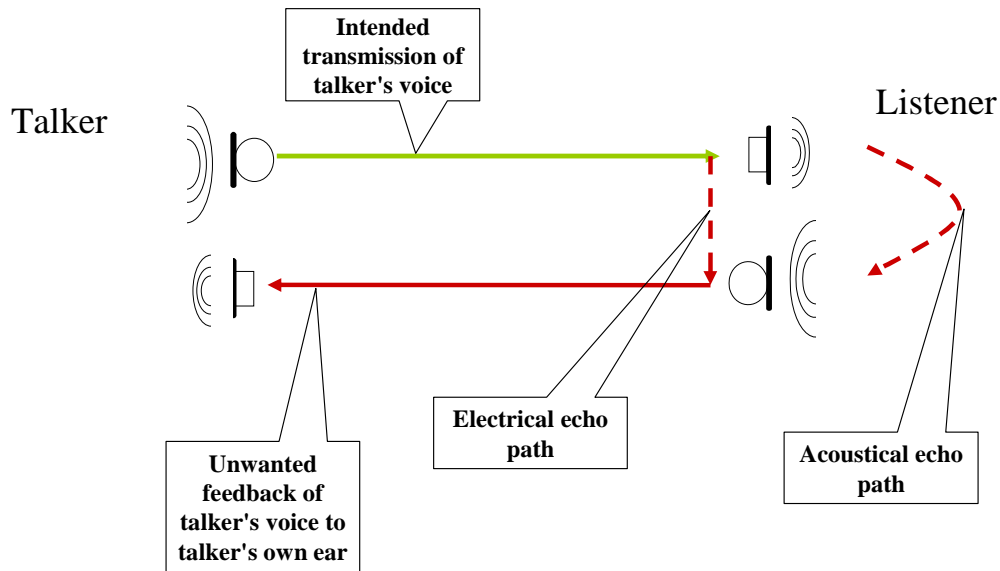

Figure C.1

C.2 Listener echo

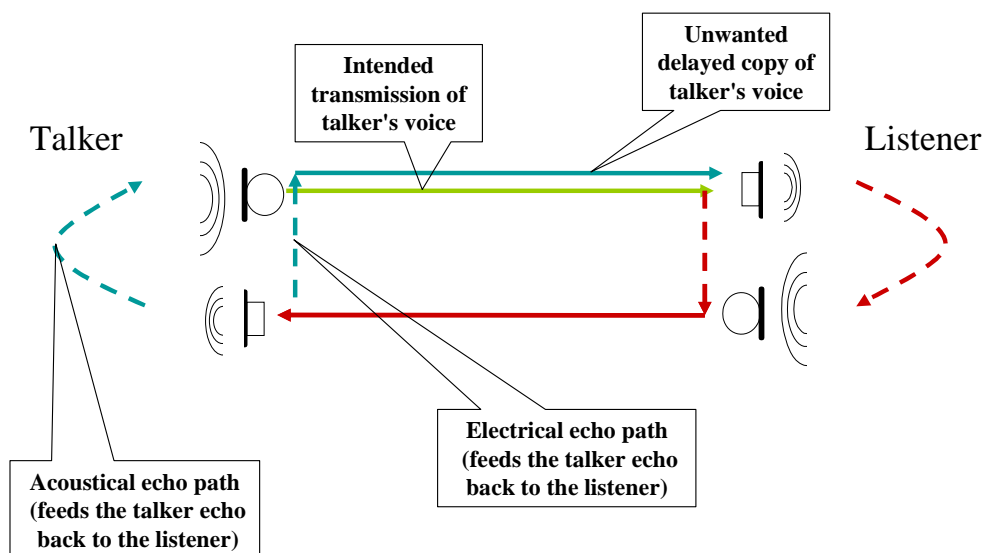

Figure C.2

Annex D (informative): Examples of measurement point distribution

In this annex, two hypothetical examples are presented to illustrate the method of choice and allocation of measurement points described in clause 11.2.

D.1 Example of France

Step 1: Determination of the minimum number required of measurement point locations

Population size in France = 63 800 000. In this context, the supervision of telephony offers needs at least 10 measurement point locations.

Step 2: Definition of area perimeter

Considering the topology of the urbanization in France, it makes sense to define the term area as perimeter of a set of cities making an urban continuity.

Step 3: Identification of the different areas and classification into the 5 area categories defined in clause 11.1

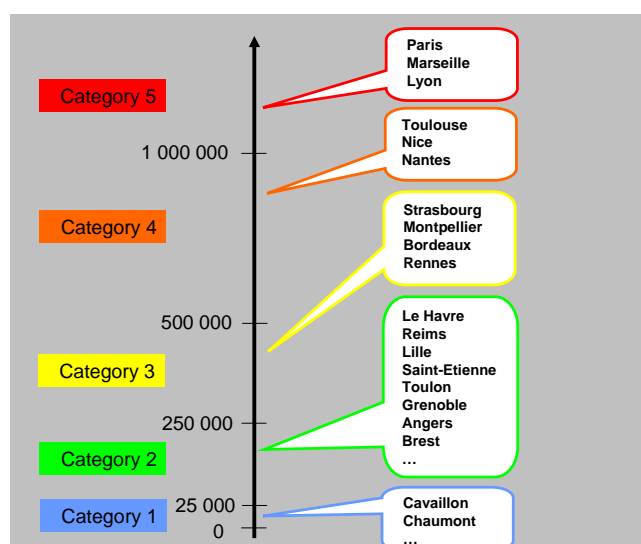

Figure D.1

We notice for France 5 effective area categories.

Step 4: Choice of a first series of measurement points

Respecting the requirement of at least one measurement location by effective category, the first series of measurement points can be this one:

- Category 5: Paris.
- Category 4: Toulouse.
- Category 3: Bordeaux.
- Category 2: Dijon.
- Category 1: Lannion.

This first identification is realized by distributing the measurement points geographically.

Step 5: Complete the location distribution

5 other measurement points are defined to respect the requirement that at least 10 measurement point locations are needed for the supervision of telephony services in France. The second series of measurement points can be this one:

- Category 5: Marseille, Lyon.
- Category 4: Nantes.
- Category 3: Strasbourg.
- Category 2: Lille.

This second identification is realized by distributing the measurement points geographically and also by taking into account that the French population lives mainly in cities (75 %). In these conditions, two areas in category 5 are preferred to another measurement point in category 1.

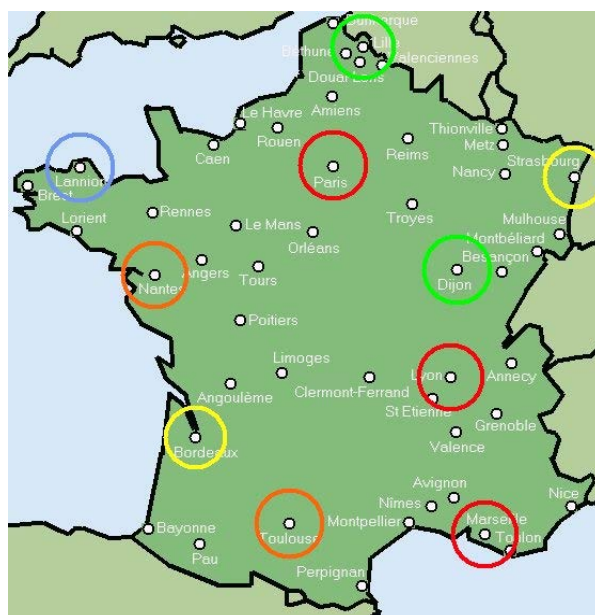

Figure D.2

D.2 Example of Switzerland

Step 1: Determination of the required minimum number of measurement point locations

Population size in Switzerland = 7 590 000. In this context, the supervision of telephony offers needs at least 5 measurement point locations.

Step 2: Definition of area perimeter

It makes sense to define the term area as perimeter of cities.

Step 3: Identification of the different areas and classification into the 5 area categories defined in clause 11.1

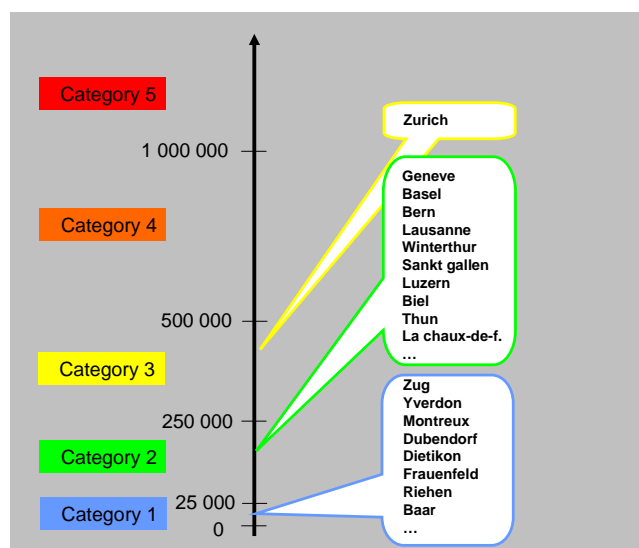

Figure D.3

We notice for Switzerland 3 effective area categories.

Step 4: Choice of a first series of measurement points

Respecting the requirement of at least one measurement location by effective category, the first series of measurement points can be this one:

- Category 3: Zurich.
- Category 2: Geneva.
- Category 1: Locarno.

This first identification is realized by distributing the measurement points geographically.

Step 5: Complete the location distribution

Two other measurement points are defined to respect the requirement that at least 5 measurement point locations are needed for the supervision of telephony services in Switzerland. The second series of measurement points can be this one:

- Category 2: Bern.
- Category 1: Altdorf.

This second identification is realized by distributing the measurement points geographically and also by taking into account the Swiss area size (lower than 250 000 thus classified in categories 1 and 2). The choice of the measurement points (realized in steps 4 and 5) also takes into account a specificity of Switzerland: 3 regions associated with different languages (French, German and Italian).

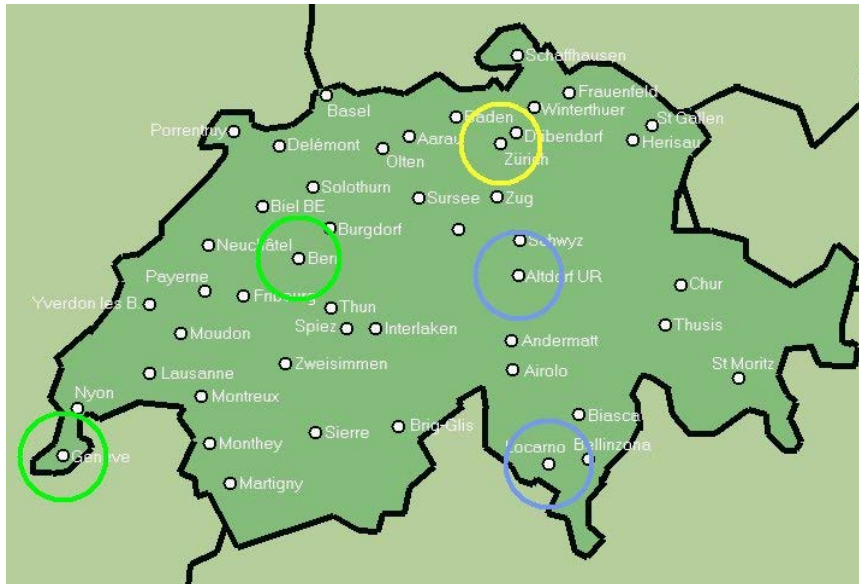

Figure D.4

History

Document history		
V1.1.1	February 2009	Publication as EG 202 765-2
V1.1.3	May 2010	Publication
V1.1.4	July 2010	Publication
V1.2.1	March 2014	Membership Approval Procedure MV 20140511: 2014-03-12 to 2014-05-12
V1.2.1	May 2014	Publication