



**Satellite Earth Stations and Systems (SES);
Harmonised Standard for fixed and in-motion
Earth Stations communicating with
non-geostationary satellite systems (NEST)
in the 11 GHz to 14 GHz frequency bands
covering essential requirements
of article 3.2 of Directive 2014/53/EU**

Reference

DEN/SES-00402

Keywords

broadband, earth station, mobile, regulation,
satellite

ETSI

650 Route des Lucioles
F-06921 Sophia Antipolis Cedex - FRANCE

Tel.: +33 4 92 94 42 00 Fax: +33 4 93 65 47 16

Siret N° 348 623 562 00017 - NAF 742 C
Association à but non lucratif enregistrée à la
Sous-Préfecture de Grasse (06) N° 7803/88

Important notice

The present document can be downloaded from:
<http://www.etsi.org/standards-search>

The present document may be made available in electronic versions and/or in print. The content of any electronic and/or print versions of the present document shall not be modified without the prior written authorization of ETSI. In case of any existing or perceived difference in contents between such versions and/or in print, the only prevailing document is the print of the Portable Document Format (PDF) version kept on a specific network drive within ETSI Secretariat.

Users of the present document should be aware that the document may be subject to revision or change of status. Information on the current status of this and other ETSI documents is available at
<https://portal.etsi.org/TB/ETSIDeliverableStatus.aspx>

If you find errors in the present document, please send your comment to one of the following services:
<https://portal.etsi.org/People/CommiteeSupportStaff.aspx>

Copyright Notification

No part may be reproduced or utilized in any form or by any means, electronic or mechanical, including photocopying and microfilm except as authorized by written permission of ETSI.

The content of the PDF version shall not be modified without the written authorization of ETSI.
The copyright and the foregoing restriction extend to reproduction in all media.

© European Telecommunications Standards Institute 2017.
All rights reserved.

DECT™, **PLUGTESTS™**, **UMTS™** and the ETSI logo are Trade Marks of ETSI registered for the benefit of its Members.
3GPP™ and **LTE™** are Trade Marks of ETSI registered for the benefit of its Members and of the 3GPP Organizational Partners.
GSM® and the GSM logo are Trade Marks registered and owned by the GSM Association.

Contents

Intellectual Property Rights	7
Foreword.....	7
Modal verbs terminology.....	7
Introduction	7
1 Scope	9
2 References	10
2.1 Normative references	10
2.2 Informative references.....	10
3 Definitions, symbols and abbreviations	11
3.1 Definitions	11
3.2 Symbols.....	12
3.3 Abbreviations	13
4 Technical requirements specifications	14
4.1 General	14
4.1.1 Environmental profile	14
4.1.2 Mechanical and electrical design	14
4.1.2.1 General.....	14
4.1.3 Operating configurations	14
4.1.4 Presentation of equipment for testing purposes	14
4.1.5 Choice of model for testing	15
4.2 Conformance requirements	15
4.2.1 EIRP density mask.....	15
4.2.1.1 Justification	15
4.2.1.2 Specification.....	15
4.2.1.3 Conformance tests.....	15
4.2.2 Antenna beam pointing.....	15
4.2.2.1 Pointing accuracy.....	15
4.2.2.1.1 Purpose	15
4.2.2.1.2 Antenna Beam Pointing error	15
4.2.2.2 Pointing error detection.....	15
4.2.2.2.1 Purpose	15
4.2.2.2.2 Pointing error detection specification	16
4.2.2.3 Conformance tests.....	16
4.2.3 Off-axis spurious radiation	16
4.2.3.1 Justification	16
4.2.3.2 Specification.....	16
4.2.3.3 Conformance tests.....	17
4.2.4 On-axis spurious radiation	17
4.2.4.1 Justification	17
4.2.4.2 Specification.....	17
4.2.4.2.1 "Carrier-on" radio state.....	17
4.2.4.2.2 "Carrier-off" and "Emissions disabled" radio states	18
4.2.4.3 Conformance tests.....	18
4.2.5 Carrier suppression	18
4.2.5.1 Justification	18
4.2.5.2 Specification.....	18
4.2.5.3 Conformance tests.....	18
4.2.6 Cessation of emissions.....	18
4.2.6.1 Justification	18
4.2.6.2 Specification.....	18
4.2.6.2.1 Specification 1: Mode of cessation of emissions	18
4.2.6.2.2 Specification 2: Conditions under which the NEST shall cease emissions	19
4.2.6.2.3 Specification 3: Cessation of emissions	19

4.2.6.2.4	Specification 4: Fault conditions	20
4.2.6.3	Conformance tests	20
4.2.7	Identification of the NEST and its location	20
4.2.7.1	Justification	20
4.2.7.2	Specification	20
4.2.7.3	Conformance tests	20
4.2.8	Control and Monitoring Functions (CMFs)	21
4.2.8.1	NEST States	21
4.2.8.1.1	General	21
4.2.8.1.2	CMF state diagram	22
4.2.8.2	Processor monitoring	23
4.2.8.2.1	Justification	23
4.2.8.2.2	Specification	23
4.2.8.2.3	Conformance tests	24
4.2.8.3	Transmit subsystem monitoring	24
4.2.8.3.1	Justification	24
4.2.8.3.2	Specification	24
4.2.8.3.3	Conformance tests	24
4.2.8.4	Power-on/Reset	24
4.2.8.4.1	Justification	24
4.2.8.4.2	Specification	24
4.2.8.4.3	Conformance tests	24
4.2.8.5	Control Channel (CC) and Response Channel (RC)	24
4.2.8.5.1	Justification	24
4.2.8.5.2	Specification	25
4.2.8.5.3	Conformance tests	25
4.2.8.6	Network control commands	25
4.2.8.6.1	Justification	25
4.2.8.6.2	Specification	26
4.2.8.6.3	Conformance tests	26
4.2.8.7	Initial burst transmission	26
4.2.8.7.1	Justification	26
4.2.8.7.2	Specification	26
4.2.8.7.3	Conformance tests	26
4.2.8.8	Inhibition of transmissions	27
4.2.8.8.1	Justification	27
4.2.8.8.2	Specification	27
4.2.8.8.3	Conformance tests	27
4.2.9	Receive antenna off-axis gain pattern	27
4.2.9.1	Justification	27
4.2.9.2	Specification	27
4.2.9.3	Conformance tests	28
4.2.10	Blocking performance	28
4.2.10.1	Justification	28
4.2.10.2	Specification	28
4.2.10.3	Conformance tests	28
4.2.11	Adjacent Signal Selectivity	28
4.2.11.1	Justification	28
4.2.11.2	Specification	28
4.2.11.3	Conformance tests	29
5	Testing for compliance with technical requirements	29
5.1	Environmental conditions for testing	29
5.2	Essential radio test suites	29
6	Test methods for all aspects of the NEST	29
6.1	General	29
6.1.1	General requirements	29
6.1.2	Interpretation of measurement results	30
6.1.3	Measuring receiver	31
6.2	Off-axis spurious radiation	31
6.2.1	General	31

6.2.2	Test method	31
6.2.2.1	General	31
6.2.2.2	Multi-carrier operation	32
6.2.3	Measurements up to 1 000 MHz	32
6.2.3.1	Test site	32
6.2.3.2	Measuring receivers	33
6.2.3.3	Procedure	33
6.2.4	Measurements above 1 000 MHz	33
6.2.4.1	General	33
6.2.4.2	Identification of the significant frequencies of spurious radiation	33
6.2.4.2.1	Test site.....	33
6.2.4.2.2	Procedure.....	34
6.2.4.3	Measurement of radiated power levels of identified spurious radiation.....	34
6.2.4.3.1	Test site.....	34
6.2.4.3.2	Procedure.....	34
6.2.4.4	Measurement of conducted spurious radiation at the antenna flange.....	35
6.2.4.4.1	Test site.....	35
6.2.4.4.2	Procedure.....	36
6.3	On-axis spurious radiation.....	36
6.3.1	Test method	36
6.3.1.1	General	36
6.3.1.2	Test site	36
6.3.1.3	Method of measurement.....	36
6.3.1.3.1	General	36
6.3.1.3.2	Method of measurement at the antenna flange	37
6.3.1.3.3	Method of measurement for an EUT with antenna.....	39
6.4	EIRP density.....	40
6.4.1	General.....	40
6.4.2	Test method A radiated measurement.....	40
6.4.3	Test method B conducted measurement	40
6.5	Carrier suppression.....	40
6.5.1	Test method	40
6.6	Antenna beam pointing	40
6.6.1	General.....	40
6.6.2	Test methods.....	41
6.7	Cessation of emissions of the NEST	41
6.7.1	General.....	41
6.7.2	Test Method.....	41
6.7.2.1	Required documentation	41
6.7.2.2	Cessation of emissions from the "Transmission enabled" state	41
6.7.2.3	Cessation of emission from the "Transmission disabled" state	41
6.7.2.4	Cessation of emission from the "Initial Phase" state	42
6.7.2.4.1	EUTs transmitting initial bursts.....	42
6.7.2.4.2	EUTs not transmitting initial bursts.....	42
6.7.2.5	"Single action" means of cessation of emissions.....	43
6.7.2.6	Fault conditions	43
6.8	Identification of NEST and location determination.....	44
6.8.1	Test arrangement	44
6.8.2	Test method	44
6.9	Control and monitoring functions	44
6.9.1	General.....	44
6.9.2	Test arrangement	44
6.9.3	Processor monitoring- Test method	44
6.9.4	Transmit subsystem monitoring-Test method.....	45
6.9.5	Power-on/Reset-Test method.....	45
6.9.6	Control Channel and Response Channel -Test method.....	45
6.9.7	Network Control commands-Test method.....	46
6.9.8	Initial burst transmission-Test method.....	47
6.9.9	Inhibition of transmission-Test method	48
6.10	Antenna off-axis gain pattern	48
6.10.1	Test Method.....	48
6.10.1.1	Test site	48

6.10.1.2	Method of measurement for EUT antenna with linear polarization	48
6.10.1.3	Method of measurement for antennas with circular polarization	49
6.11	Blocking performance	49
6.11.1	Test method	49
6.12	Adjacent Signal Selectivity	50
Annex A (informative):	Relationship between the present document and the essential requirements of Directive 2014/53/EU	51
Annex B (informative):	Bibliography	53
Annex C (informative):	Change history	54
History		55

Intellectual Property Rights

IPRs essential or potentially essential to the present document may have been declared to ETSI. The information pertaining to these essential IPRs, if any, is publicly available for **ETSI members and non-members**, and can be found in ETSI SR 000 314: "*Intellectual Property Rights (IPRs); Essential, or potentially Essential, IPRs notified to ETSI in respect of ETSI standards*", which is available from the ETSI Secretariat. Latest updates are available on the ETSI Web server (<https://ipr.etsi.org>).

Pursuant to the ETSI IPR Policy, no investigation, including IPR searches, has been carried out by ETSI. No guarantee can be given as to the existence of other IPRs not referenced in ETSI SR 000 314 (or the updates on the ETSI Web server) which are, or may be, or may become, essential to the present document.

Foreword

This draft Harmonised European Standard (EN) has been produced by ETSI Technical Committee Satellite Earth Stations and Systems (SES), and is now submitted for the combined Public Enquiry and Vote phase of the ETSI standards EN Approval Procedure.

The present document has been prepared under the Commission's standardisation request C(2015) 5376 final [i.1] to provide one voluntary means of conforming to the essential requirements of Directive 2014/53/EU on the harmonisation of the laws of the Member States relating to the making available on the market of radio equipment and repealing Directive 1999/5/EC [i.8].

Once the present document is cited in the Official Journal of the European Union under that Directive, compliance with the normative clauses of the present document given in table A.1 confers, within the limits of the scope of the present document, a presumption of conformity with the corresponding essential requirements of that Directive, and associated EFTA regulations..

Proposed national transposition dates	
Date of latest announcement of this EN (doa):	3 months after ETSI publication
Date of latest publication of new National Standard or endorsement of this EN (dop/e):	6 months after doa
Date of withdrawal of any conflicting National Standard (dow):	18 months after doa

Modal verbs terminology

In the present document "**shall**", "**shall not**", "**should**", "**should not**", "**may**", "**need not**", "**will**", "**will not**", "**can**" and "**cannot**" are to be interpreted as described in clause 3.2 of the [ETSI Drafting Rules](#) (Verbal forms for the expression of provisions).

"**must**" and "**must not**" are **NOT** allowed in ETSI deliverables except when used in direct citation.

Introduction

The present document is part of a set of standards developed by ETSI and is designed to fit in a modular structure to cover all radio and telecommunications terminal equipment within the scope of the RE Directive [i.8]. The modular structure is shown in ETSI EG 201 399 [i.2].

The present document is largely based on ETSI EN 303 979 [i.5], for ESOMPs operating with NGSO satellites.

The present document may also be applicable to the frequency band 14,0 GHz to 14,50 GHz (Earth-to-space) and 10,70 GHz to 12,75 GHz (space-to-Earth) subject to national regulation.

Annex A (normative) provides HS Requirements specifications.

Annex B (informative) Bibliography covers other supplementary information.

Recital 10 of Directive 2014/53/EU [i.8] states that "*in order to ensure that radio equipment uses the radio spectrum effectively and supports the efficient use of radio spectrum, radio equipment should be constructed so that: in the case of a transmitter, when the transmitter is properly installed, maintained and used for its intended purpose it generates radio waves emissions that do not create harmful interference, while unwanted radio waves emissions generated by the transmitter (e.g. in adjacent channels) with a potential negative impact on the goals of radio spectrum policy should be limited to such a level that, according to the state of the art, harmful interference is avoided; and, in the case of a receiver, it has a level of performance that allows it to operate as intended and protects it against the risk of harmful interference, in particular from shared or adjacent channels, and, in so doing, supports improvements in the efficient use of shared or adjacent channels.*"

Recital 11 of Directive 2014/53/EU [i.8] states that "*although receivers do not themselves cause harmful interference, reception capabilities are an increasingly important factor in ensuring the efficient use of radio spectrum by way of an increased resilience of receivers against harmful interference and unwanted signals on the basis of the relevant essential requirements of Union harmonisation legislation.*"

As a consequence, the present document includes both transmitting and receiving parameters aiming to maximize the efficient use of radio spectrum.

1 Scope

The present document specifies technical characteristics and methods of measurements for fixed and in-motion Earth Stations communicating with non-geostationary satellite systems (NEST) in the 11 GHz to 14 GHz FSS frequency bands, which have the following characteristics:

- The NEST is designed for both in-motion and stationary operation.
- The NEST operates in-motion on various platforms such as trains, maritime vessels, aircraft and other vehicles and, therefore, may be subject to occasional disturbances and interruptions in the satellite link.
- The NEST is operating as part of a satellite system used for the provision of broadband communications.
- The NEST is comprised of all the equipment, electrical and mechanical, from the antenna itself to the interface with other communications equipment on a mobile platform.
- The NEST comprises one or more emitters and the system overview as given in figure 1 should be interpreted accordingly.
- The transmit and receive frequencies are shown in table 1.

Table 1: Frequency bands

	Frequency Bands
Transmit (Earth-to-space)	14,0 GHz to 14,50 GHz
Receive (space-to-Earth)	10,70 GHz to 12,75 GHz

- The NEST transmits within the frequency range from 14,0 GHz to 14,50 GHz.
- The NEST receives within the range from 10,70 GHz to 12,75 GHz.
- The NEST transmits at elevation angles relative to the local horizon of 50° or greater.
- The NEST uses linear or circular polarization.
- The NEST communicates with non-geostationary satellites.
- The NEST is designed for unattended operation.
- The NEST is controlled and monitored by a Network Control Facility (NCF). The NCF is outside the scope of the present document.

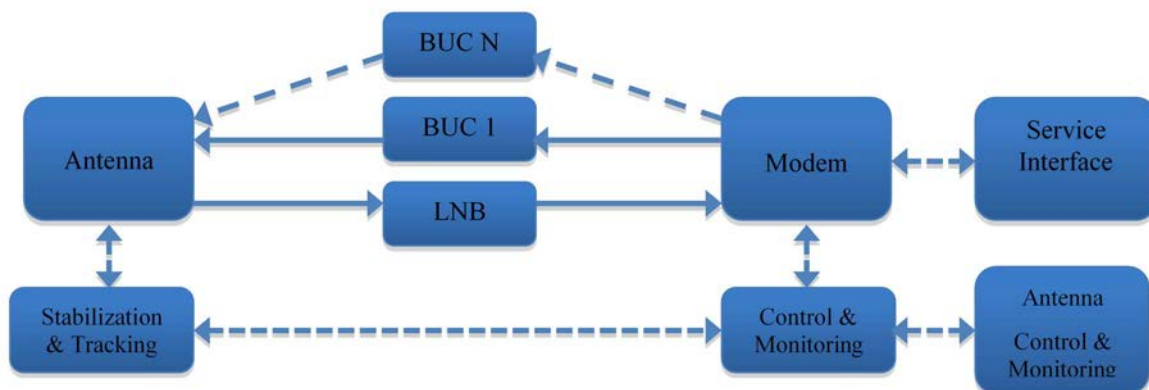

Figure 1: NEST System Overview

The present document applies to the NEST with its ancillary equipment and its various telecommunication ports, and when operated within the boundary limits of the operational environmental profile as declared by the applicant and when installed as required by the applicant's declaration or in the user documentation.

The present document covers the essential requirements of article 3.2 of Directive 2014/53/EU under the conditions identified in annex A.

2 References

2.1 Normative references

References are specific, identified by date of publication and/or edition number or version number. Only the cited version applies.

Referenced documents which are not found to be publicly available in the expected location might be found at <https://docbox.etsi.org/Reference/>.

NOTE: While any hyperlinks included in this clause were valid at the time of publication, ETSI cannot guarantee their long term validity.

The following referenced documents are necessary for the application of the present document.

- [1] CISPR 16-1-1 Edition 4.0 (2015): "Specification for radio disturbance and immunity measuring apparatus and methods - Part 1-1: Radio disturbance and immunity measuring apparatus - Measuring apparatus".
- [2] CISPR 16-1-4 Edition 3.0 (2010): "Specification for radio disturbance and immunity measuring apparatus and methods - Part 1-4: Radio disturbance and immunity measuring apparatus - Antennas and test sites for radiated disturbance measurements".

2.2 Informative references

References are either specific (identified by date of publication and/or edition number or version number) or non-specific. For specific references, only the cited version applies. For non-specific references, the latest version of the referenced document (including any amendments) applies.

NOTE: While any hyperlinks included in this clause were valid at the time of publication, ETSI cannot guarantee their long-term validity.

The following referenced documents are not necessary for the application of the present document but they assist the user with regard to a particular subject area.

- [i.1] Commission Implementing Decision C(2015) 5376 final of 04.08.2015 on a standardisation request to the European Committee for Electrotechnical Standardisation and to the European Telecommunications Standards Institute as regards radio equipment in support of Directive 2014/53/EU of the European Parliament and of the Council.
- [i.2] ETSI EG 201 399: "Electromagnetic compatibility and Radio spectrum Matters (ERM); A guide to the production of Harmonized Standards for application under the Radio & Telecommunication Terminal Equipment Directive 1999/5/EC (R&TTE) and a first guide on the impact of the Radio Equipment Directive 2014/53/EU (RED) on Harmonized Standards".
- [i.3] ETSI TS 103 052: "Electromagnetic compatibility and Radio spectrum Matters (ERM); Radiated measurement methods and general arrangements for test sites up to 100 GHz".
- [i.4] ITU Radio Regulations (edition 2016).
- [i.5] ETSI EN 303 979 (V2.1.2): "Satellite Earth Stations and Systems (SES); Harmonised EN for Earth Stations on Mobile Platforms (ESOMP) transmitting towards satellites in non-geostationary orbit in the 27,5 GHz to 29,1 GHz and 29,5 GHz to 30,0 GHz frequency bands covering the essential requirements of article 3.2 of the Directive 2014/53/EU".
- [i.6] Recommendation ITU-R S.1503-2, Section 3.1: "Generation of Earth Station e.i.r.p density masks".

- [i.7] ETSI TR 100 028 (all parts) (V1.4.1) (12-2001): "Electromagnetic compatibility and Radio spectrum Matters (ERM); Uncertainties in the measurement of mobile radio equipment characteristics".
- [i.8] Directive 2014/53/EU of the European Parliament and of the Council of 16 April 2014 on the harmonisation of the laws of the Member States relating to the making available on the market of radio equipment and repealing Directive 1999/5/EC.

3 Definitions, symbols and abbreviations

3.1 Definitions

For the purposes of the present document, the terms and definitions given in Directive 2014/53/EU [i.8] and the following apply:

ancillary equipment: equipment used in connection with a NEST

NOTE: Equipment is considered as ancillary if the three following conditions are met:

- the equipment is intended for use in conjunction with the NEST to provide additional operational and/or control features (e.g. to extend control to another position or location); and
- the equipment cannot be used on a standalone basis, to provide user functions independently of the NEST; and
- the absence of the equipment does not inhibit the operation of the NEST.

antenna controller: equipment used to maintain antenna stabilization and tracking accuracy based on inputs from the Control and Monitoring Function

applicant: manufacturer or his authorized representative within the European Community or the person responsible for placing the apparatus on the market

carrier-off radio state: radio state in which the NEST may transmit and does not transmit any carrier

NOTE 1: The phrase "the NEST may transmit" means that all the conditions for transmission are satisfied (e.g. in a state where transmissions are permitted, no failure detected, and the NEST is correctly pointed towards the satellite).

NOTE 2: The existence of a "Carrier-off" radio state depends on the system of transmission used. For NESTs designed for continuous transmission mode there may be no "Carrier-off" state.

carrier-on radio state: radio state in which the NEST may transmit and transmits a carrier

Control Channel (CC): channel or channels by which NESTs receive and send control information from and to the NCF

EIRP_{max}: maximum EIRP capability of the NEST as declared by the applicant

EIRP density mask: EIRP density mask (dBW/40kHz) declared by the applicant for the simulation described in the Recommendation ITU-R S.1503-2 [i.6] to demonstrate compliance with ITU Radio Regulations Article 22 limits [i.4]

emissions disabled radio state: radio state in which the NEST may not emit

NOTE: Examples of cases where the NEST is in this radio state:

- before system monitoring pass, before the control channel is received,
- when a failure is detected,
- when an NEST is commanded to disable, and
- when the NEST is in a location requiring cessation of emissions.

external control channel: control channel which is either:

- (i) carried by the NEST network via the same or another satellite, but not within the internal protocol of the NEST system; or
- (ii) carried by any other radio communication system

external response channel: response channel which is either:

- (i) carried by the NEST network via the same or another satellite, but not within the internal protocol of the NEST system; or
- (ii) carried by any other radio communication system

integral antenna: antenna which may not be removed during the tests according to the applicant's statement

internal control channel: control channel which is carried by the NEST network via the same satellite as used for transmission of user data and within the internal protocol structure of the NEST system

internal response channel: response channel which is carried by the NEST network via the same satellite as used for transmission of user data and within the internal protocol structure of the NEST system

Network Control Facility (NCF): set of functional entities that, at system level, monitor and control the correct operation of the NEST and, if appropriate, all of the NESTs in a network

nominated bandwidth: bandwidth of the NEST radio frequency transmission declared by the manufacturer

NOTE 1: The nominated bandwidth is wide enough to encompass all spectral elements of the transmission that have a level greater than the specified spurious radiation limits. The nominated bandwidth is wide enough to take account of the transmit carrier frequency stability. This definition is chosen to allow flexibility regarding adjacent channel interference levels that will be taken into account by operational procedures depending on the exact transponder carrier assignment situation.

NOTE 2: The nominated bandwidth is centred on the transmit frequency and is larger than the occupied bandwidth. However, the manufacturer should be aware that the larger the declared nominated bandwidth, the fewer channels will be available within the assigned band.

off-axis angle: angle between the direction of the axis of the antenna main beam and the considered direction

removable antenna: antenna which may be removed during the tests according to the applicant's statement

Response Channel (RC): channel by which the NEST transmit monitoring information to the NCF

spurious radiation: in the present document, any radiation outside the nominated bandwidth

transmission disabled state: radio state in which the NEST is not authorized to transmit by the NCF

transmission enabled state: radio state in which the NEST is authorized to transmit by the NCF

wanted signal occupied bandwidth (BW):

- for a digital modulation scheme: the width of the signal spectrum 10 dB below the maximum in-band power density;
- for an analogue modulation scheme: the width of a frequency band such that, below the lower and above the upper frequency limits, the mean power emitted is equal to 0,5 % of the total mean power of the emission

3.2 Symbols

For the purposes of the present document, the following symbols apply:

dB _i	ratio of an antenna gain to the gain of an isotropic antenna, expressed in decibels
dB _{sd}	Ratio expressed in decibels relative to the spectral density

dBW	ratio of a power to 1 watt, expressed in decibels
dBpW	ratio of a power to 1 picowatt, expressed in decibels
dB μ V/m	ratio of an electric field to 1 μ V/m, expressed in decibels (20 log(electric field / 1 μ V/m))

3.3 Abbreviations

For the purposes of the present document, the following abbreviations apply:

BW	Wanted Signal occupied Bandwidth
CC	Control Channel
CCF	Control Channel reception Failure
CCR	Control Channel correctly Received
CENR	Cessation of Emissions Not Required
CEPT	Conférence Européenne des Postes et Télécommunications (European Conference of Postal and Telecommunications)
CER	Cessation of Emissions Required
CISPR	Comité International Spécial des Perturbations Radioélectriques (International Special Committee on Radio Interference)
CMF	Control and Monitoring Functions
DC	Direct Current
EIRP _{max}	Maximum EIRP transmitted by the NEST
ECC	Electronic Communications Committee (of CEPT)
EIRP	Effective Isotropic Radiated Power
EMC	Electro-Magnetic Compatibility
epfd \uparrow	Uplink equivalent power flux-density
EUT	Equipment Under Test
FEC	Forward Error Correction
FSS	Fixed Satellite Service
GEUT	Gain of EUT
GSO	Geostationary Satellite Orbit
HPA	High Power Amplifier
IPR	Intellectual Property Rights
LNB	Low-Noise Block Down converter
LO	Local Oscillator
LV	Low Voltage
NCF	Network Control Facility
NEST	Earth Station communicating with NGSO satellite system
NGSO	Non Geostationary Satellite Orbit
R&TTE	Radio and Telecommunications Terminal Equipment
RBW	Reference BandWidth
RC	Response Channel
RE	Radio Equipment
RED	Radio Equipment Directive
RF	Radio Frequency
RMS	Root Mean Square
SMF	System Monitoring Fail
SMP	System Monitoring Pass
STE	Special Test Equipment
TxD	Transmission Disable command
TxE	Transmission Enable command
VBW	Video BandWidth

4 Technical requirements specifications

4.1 General

4.1.1 Environmental profile

The manufacture shall declare the environmental profile of the NEST equipment and the environmental standard(s) under which they are compliant. The environmental profile shall include conditions for both survivability and operation. The declared environmental profile shall include, but not be limited to, a statement of conditions regarding: velocity, tangential and longitudinal acceleration, temperature range, damp heat, dry heat, relative humidity stress, shock and vibration, antenna pressure pulses and pressure gradients.

The equipment shall comply with the performance requirements of the present document under all operational environmental conditions.

4.1.2 Mechanical and electrical design

4.1.2.1 General

The equipment submitted by the applicant shall be designed, constructed and manufactured in accordance with good engineering practice and with the aim of minimizing harmful interference to other equipment and services.

4.1.3 Operating configurations

Operation of the NEST shall be able to comply with national regulations, including the use of sub-bands as authorized. The manufacturer shall declare all operational parameters including the maximum EIRP, EIRP densities in use, modulation and occupied bandwidth.

The manufacturer shall declare the number of carrier signals of the NEST that may be radiated simultaneously. The specifications in this clause 4 shall be applied to such configuration as declared by the Applicant.

Under operational conditions an NEST may dynamically change the occupied bandwidth and other transmission parameters (e.g. FEC, modulation, symbol rate) of the transmitted signal.

For the purposes of verifying that the NEST complies with these specifications, the applicant shall declare the worst-case combination of transmission parameters that would produce the EIRP density mask, as declared by the manufacturer.

4.1.4 Presentation of equipment for testing purposes

NEST equipment submitted for testing, where applicable, shall fulfil the requirements of the present document on all frequencies over which it is intended to operate.

The applicant shall submit one or more samples of the equipment as appropriate for testing.

Additionally, technical documentation and operating manuals, sufficient to allow testing to be performed, shall be supplied.

The performance of the NEST equipment submitted for testing shall be representative of the performance of the corresponding production model. The applicant shall offer equipment complete with any auxiliary equipment needed for testing.

The applicant shall declare the frequency range(s), the range of operation conditions and power requirements, as applicable, in order to establish the appropriate test conditions.

4.1.5 Choice of model for testing

If an NEST equipment has several optional features, considered not to affect the RF parameters then the tests need only to be performed on one sample of the equipment configured with that combination of features considered to create the highest unintentional emissions.

In addition, when a device has the capability of using different dedicated antennas or other features that affect the RF parameters, at least the worst combination of features from an emission point of view as agreed between the applicant and the test laboratory shall be tested.

Where the transmitter is designed with adjustable output power, then all transmitter parameters shall be measured using the highest maximum mean power spectral density level, as declared by the applicant.

The choice of model(s) for testing shall be recorded in the test report.

4.2 Conformance requirements

4.2.1 EIRP density mask

4.2.1.1 Justification

For the protection of GSO satellite networks.

4.2.1.2 Specification

The applicant shall declare the values of EIRP density mask that have been used for the purpose of carrying out simulations specified in Recommendation ITU-R S.1503-2 [i.6] in order to comply with the $epfd\uparrow$ limits specified in Article 22 of the Radio Regulations [i.4]. These values shall be used as a means of testing the NEST.

The applicant shall declare which operating mode corresponds to the maximum EIRP density and provide the means for the NEST to be placed in this mode for test.

4.2.1.3 Conformance tests

Conformance tests shall be carried out in accordance with clause 6.4.

4.2.2 Antenna beam pointing

4.2.2.1 Pointing accuracy

4.2.2.1.1 Purpose

To validate that the antenna points correctly within the $\delta\phi_{\max}$.

4.2.2.1.2 Antenna Beam Pointing error

The antenna beam pointing error is a difference between true azimuth and elevation position related to a given RF boresight of the NEST and the azimuth and elevation reported by the antenna control and tracking system.

The Applicant shall declare the maximum antenna beam pointing error $\delta\phi_{\max}$.

4.2.2.2 Pointing error detection

4.2.2.2.1 Purpose

Protection to GSO satellites from NEST emissions caused by erroneous beam pointing.

4.2.2.2.2 Pointing error detection specification

Pointing error detection:

- The NEST shall have the means to detect antenna beam pointing errors specified in clause 4.2.2.1.2. This detection shall be performed over the range of azimuth and elevation angles for the intended purposes as declared by applicant.
- The NEST, when in the "Carrier-on" radio state, shall enter the "Carrier-off" radio state when the antenna beam pointing error has exceeded the maximum pointing error, $\delta\phi_{\max}$. The NEST shall not re-enter the "Carrier-on" radio state until the pointing error is within $\delta\phi_{\max}$.
- The applicant shall declare the maximum inhibit time (IT_{\max}) that the NEST can remain in "Transmission enabled" state and "Carrier off" radio state (see also clause 4.2.8.8). If the pointing error threshold is exceeded for more than IT_{\max} then the NEST shall enter the "Initial phase" state.

NOTE: $\delta\phi_{\max}$ could be exceeded when the NEST is in any other state other than "Carrier-on" radio state. In this case, the behaviour of the NEST is in accordance with clause 4.2.6.

4.2.2.3 Conformance tests

Conformance tests shall be carried out in accordance with clause 6.6.

4.2.3 Off-axis spurious radiation

4.2.3.1 Justification

To limit the level of interference to terrestrial and satellite radio services.

4.2.3.2 Specification

The following specifications apply to the NEST transmitting at Equivalent Isotropically Radiated Power (EIRP) values up to and including $EIRP_{\max}$.

- 1) The electric field strength level of any radiation from the NEST in the frequency range from 30 MHz to 1 GHz shall not exceed the limits specified in table 2.

Table 2: Limits of radiated field strength at a test distance of 10 m in a 120 kHz bandwidth

Frequency range	Quasi-peak limits
30 MHz to 230 MHz	30 dB μ V/m
230 MHz to 1 000 MHz	37 dB μ V/m

The Quasi Peak detector shall be in accordance with CISPR 16-1-1 [1].

- 2) When the NEST is in the "Emissions disabled" radio state, the off-axis spurious EIRP from the NEST shall not exceed the limits in table 3, for all off-axis angles greater than 7°.

Table 3: Limits of spurious EIRP - "Emissions disabled" radio state

Frequency band	EIRP limit	Measurement bandwidth
1,0 GHz to 2,0 GHz	52 dBpW	1 MHz
2,0 GHz to 10,7 GHz	58 dBpW	1 MHz
10,7 GHz to 21,2 GHz	64 dBpW	1 MHz
21,2 GHz to 60,0 GHz	70 dBpW	1 MHz

The lower limits shall apply at the transition frequency.

- 3) In the "Carrier-on" and "Carrier-off" radio states, the off-axis spurious EIRP density from the NEST, shall not exceed the limits in table 4, for all off-axis angles greater than 7°.

Table 4: Limits of spurious EIRP-"Carrier-on" and "Carrier-off" radio states

Frequency band	EIRP limit	Measurement bandwidth
1,0 GHz to 2,0 GHz	53 dBpW	1 MHz
2,0 GHz to 3,4 GHz	59 dBpW	1 MHz
3,4 GHz to 10,7 GHz	65 dBpW	1 MHz
10,7 GHz to 13,75 GHz	71 dBpW	1 MHz
13,75 GHz to 14,0 GHz	95 dBpW (see Note)	10 MHz
14,50 GHz to 14,75 GHz	95 dBpW (see Note)	10 MHz
14,75 GHz to 21,2 GHz	71 dBpW	1 MHz
21,2 GHz to 27,35 GHz	77 dBpW	1 MHz
27,35 GHz to 27,50 GHz	85 dBpW	1 MHz
27,50 GHz to 30,00 GHz	85 dBpW	1 MHz
30,00 GHz to 31,00 GHz	85 dBpW	1 MHz
31,00 GHz to 31,15 GHz	85 dBpW	1 MHz
31,15 GHz to 60,0 GHz	77 dBpW	1 MHz
NOTE: This limit may be exceeded in a frequency band which shall not be greater than 125 MHz, centred on the carrier frequency, provided that the considered frequency is within the nominated bandwidth or spurious EIRP density at the considered frequency is 40 dB below the maximum on-axis EIRP density of the signal (within the nominated bandwidth) expressed in dBW/1 MHz.		

The lower limits shall apply at the transition frequency.

- 4) These limits are applicable to the complete NEST equipment, including cabling between the units.

4.2.3.3 Conformance tests

Conformance tests shall be carried out in accordance with clause 6.2.

4.2.4 On-axis spurious radiation

4.2.4.1 Justification

To limit the level of interference to satellite radio services.

4.2.4.2 Specification

4.2.4.2.1 "Carrier-on" radio state

The following specification applies to the NEST transmitting at EIRP values up to $EIRP_{max}$.

In the 14,0 GHz - 14,50 GHz band the EIRP spectral density of the spurious radiation outside the nominated bandwidth centred on the carrier centre frequency shall not exceed 14 - K dBW in any 1 MHz band.

Where K is the factor that accounts for a reduction on the on-axis spurious radiation level in case of multiple NESTs operating on the same frequency and the value is given by one the following cases:

- 1) For the case where only one NEST transmits at any one time on a given carrier frequency, the value of K is 0.
- 2) For the case where several NESTs are expected to transmit simultaneously on a given carrier frequency at the same EIRP then $K = 10 \log(N)$ where N is the maximum number of these NESTs. The value of N and the operational conditions of the system shall be declared by the applicant.

- 3) For the case where several NESTs are expected to transmit simultaneously on a given carrier frequency at different EIRP levels then $K = 10 \log (EIRP_{Aggregate} / EIRP_{term})$, where:

- $EIRP_{term}$ is the on-axis EIRP (Watts) of the NEST within the nominated bandwidth.

The value of $EIRP_{Aggregate}$ and the operational conditions of the NEST network shall be declared by the applicant.

NOTE 1: The on-axis spurious radiations, outside the band 14.0 GHz to 14,50 GHz, are indirectly limited by clause 4.2.3.2. Consequently no specification is needed.

NOTE 2: Intermodulation limits inside the band of 14,0 GHz to 14,50 GHz are to be determined by system design and are subject to satellite operator specifications.

For NESTs designed to transmit several carriers on different frequencies simultaneously (multicarrier operation), the above limits only apply to each individual carrier when transmitted alone.

4.2.4.2.2 "Carrier-off" and "Emissions disabled" radio states

In the 14,0 GHz to 14,50 GHz band the EIRP spectral density of the spurious radiation outside the nominated bandwidth shall not exceed -11 dBW in any 1 MHz band.

4.2.4.3 Conformance tests

Conformance tests shall be carried out in accordance with clause 6.3.

4.2.5 Carrier suppression

4.2.5.1 Justification

To allow for the satisfactory suppression of transmissions of the NEST by the NCF, under any fault condition and under any cessation of emissions condition (see clause 4.2.6 for definition).

4.2.5.2 Specification

In the "Carrier-off" and in the "Emissions disabled" radio states the on-axis EIRP density shall not exceed 0 dBW in any 1 MHz band within the nominated bandwidth.

4.2.5.3 Conformance tests

Conformance tests shall be carried out in accordance with clause 6.5.

4.2.6 Cessation of emissions

4.2.6.1 Justification

Cessation of emissions of the NEST where the NEST is not allowed to transmit.

4.2.6.2 Specification

4.2.6.2.1 Specification 1: Mode of cessation of emissions

The following three modes of cessation of emissions shall be implemented:

- a) the NCF determines that the NEST shall cease emissions;
- b) the NEST autonomously determines that it shall cease emissions;

- c) a "single-action" means (e.g. operating a switch) by which a local operator may disable the NEST and thereby cease emissions.

The applicant shall declare the NEST interfaces involved in the cessation of emissions:

- the list of relevant parameters which are collected by the NEST or the NCF for determination as to whether the NEST should cease emissions;
- the list of these relevant parameters which are used by the NEST;
- the list of these relevant parameters which are transmitted by the NEST to the NCF;
- the list of the relevant parameters which are received by the NEST from the NCF;
- for the collected relevant parameters, the NEST interface(s), including the protocols, the timing, the ranges of the values, the speed of the variations and the required accuracies;
- for the relevant parameters transmitted to the NCF, the NEST interface with the NCF, including the protocols and the timing;
- for the transmission parameter received from the NCF, the NEST interface with the NCF, including the protocols and the timing.

These declared NEST interfaces shall be in accordance with the user documentation.

4.2.6.2.2 Specification 2: Conditions under which the NEST shall cease emissions

The relevant parameters and the exchange of information between the NEST and the NCF shall be sufficient to cease emissions within the location accuracy declared by the applicant.

The conditions for cessation of emissions shall take into account at least the following parameters:

- the location of the NEST and the boundaries of the authorized operating area so that cessation of emissions occurs prior to entering any exclusionary zone including any inaccuracy in determination of the geographic location of the NEST;

NOTE: The above zone may require a reduction of NEST transmit power, rather than a cessation of its emissions.

- the operating parameters specified in clauses 4.2.1 through 4.2.5;
- the carrier frequency and the authorized frequency bands.

4.2.6.2.3 Specification 3: Cessation of emissions

A condition requiring cessation of emissions occurs either when the NEST receives the command from the NCF at its input or when the NEST determines autonomously on the need to cease emissions.

When in the "Transmission enabled" state a condition requiring cessation of emissions occurs, the NEST shall cease transmissions and enter the "Initial Phase" state.

When in the "Transmission disabled" state, the NEST shall not leave that state for the "Transmission enable" state as long as a condition requiring cessation of emissions exists or the last CC command received from the NCF is a transmission disable command.

When in the "Initial phase-BurstOn" or "Initial phase-BurstOff" substate a condition requiring cessation of emissions occurs, the NEST shall cease transmissions and enter the "Initial phase-Standby" substate.

When in the "Initial phase-Standby" substate, the NEST shall not leave that state for the "Initial phase-BurstOn" or the "Transmission enabled" states as long as a condition requiring cessation of emissions exists.

The time for transition in any state from the occurrence of a condition requiring cessation of emissions to the "Emissions disabled" radio state shall not exceed 1 second.

4.2.6.2.4 Specification 4: Fault conditions

Any collection of the relevant parameters by the NEST or transmission of these parameters to the NCF, which have not been completed correctly within the required delay(s) as declared by the applicant, shall be considered as a fault condition.

Any transmission parameter not received or not correctly received from the NCF within the required delay declared by the applicant shall be considered as a fault condition.

These fault conditions shall be processed as conditions requiring cessation of emissions.

4.2.6.3 Conformance tests

Conformance tests shall be carried out in accordance with clause 6.8.

4.2.7 Identification of the NEST and its location

4.2.7.1 Justification

To fulfil the requirements for identification of individual NEST, whether operated at a fixed location or in-motion, and for potential use by duly authorized entities.

4.2.7.2 Specification

The NEST shall be designed such that it is possible for the NCF to identify which NESTs are transmitting in a given geographic area.

In the case where an external system is required, the applicant shall declare which additional means are necessary for identification of the NEST.

The NEST shall have a means of determining, reporting and logging at appropriate update rates, its geographic location within the accuracy and precision needed for the application in question, such as, but not limited to operations on:

- Vehicles and trains
- Aircraft
- Marine vessels
- Fixed locations

The applicant shall be responsible for identifying and declaring at the time of test these location requirements and the method of test.

4.2.7.3 Conformance tests

Conformance tests shall be carried out in accordance with clause 6.9.

4.2.8 Control and Monitoring Functions (CMFs)

4.2.8.1 NEST States

4.2.8.1.1 General

For the purpose of the present document the following four NEST states are defined, without presuming the effective implementation of the NEST state machine:

- "Non valid";
- "Initial phase";
- "Transmission disabled"; and
- "Transmission enabled".

The four NEST states are represented on figure 2, State Transition Diagram of the Control and Monitoring Functions (CMFs).

In the "Non-valid" state and in the "Transmission disabled" state the NEST is not allowed to transmit. In the "Transmission-enabled" state the NEST is allowed to transmit. In the "Initial phase" state the NEST is only allowed to transmit initial bursts or is waiting for a transmit enable/disable command.

The "Initial phase" is divided into three substates:

- "Initial phase-Standby" prior to the transmission of the first initial burst or when no initial bursts are transmitted;
- "Initial phase-BurstOn" during the transmission of the initial bursts;
- "Initial phase-BurstOff" between initial bursts.

NOTE: NESTs which do not transmit initial bursts have no "Initial phase-BurstOn" state and no "Initial phase-BurstOff" state.

The NEST is allowed to transmit when the following conditions for transmission are satisfied:

- in a state where transmissions are permitted;
- no failure detected;
- correctly pointed towards the satellite; and
- there is no requirement for cessation of emissions.

The following radio states of the NEST are defined:

- "Emissions disabled" when the NEST shall not transmit any carrier;
- "Carrier-off" when the NEST may transmit and does not transmit any carrier;
- "Carrier-on" when the NEST may transmit and transmits a carrier.

Table 5: NEST states and radio states of the NEST

NEST states and substates	Radio states	Examples of events
"Non valid"	"Emissions disabled"	After-power on; or After any fault; or During the checking phase.
"Initial phase"		When waiting for a transmission enable or disable command from the NCF.
"Initial phase-Standby"	"Emissions disabled"	Before the first initial burst transmissions; or In locations where no transmission is allowed.
"Initial phase-BurstOn"	"Carrier-on"	During the transmission of each initial burst, and the pointing is correct.
"Initial phase-BurstOff"	"Carrier-off"	Between initial bursts; or When the pointing threshold is exceeded.
"Transmission enabled"	"Carrier-off"	When no carrier is transmitted; or When receive synchronization is lost; or When the pointing threshold is exceeded.
	"Carrier-on"	During transmission of carrier(s), and the pointing is correct.
"Transmission disabled"	"Emissions disabled"	When a disable command from the NCF has been received and waiting for a transmission enable command from the NCF; or In locations where no transmission is allowed.

4.2.8.1.2 CMF state diagram

The following minimum set of CMFs shall be implemented in NESTs in order to minimize the probability that they originate unwanted transmissions that may give rise to harmful interference to other systems.

In the "Non-valid" state and in the "Transmission disabled" state the NEST shall not transmit. In the "Transmission-enabled" state the NEST is allowed to transmit. In the "Initial phase" state the NEST is only allowed to transmit initial bursts.

NOTE 1: The restrictions in the "Initial phase" state are for the protection of other systems when the NEST is entering the system after a power-on or a reset. These initial burst restrictions do not apply to the NEST transmissions in the "Transmission-enabled" state and once a transmission enable command has been received by the NEST the NEST may transmit or not transmit as required.

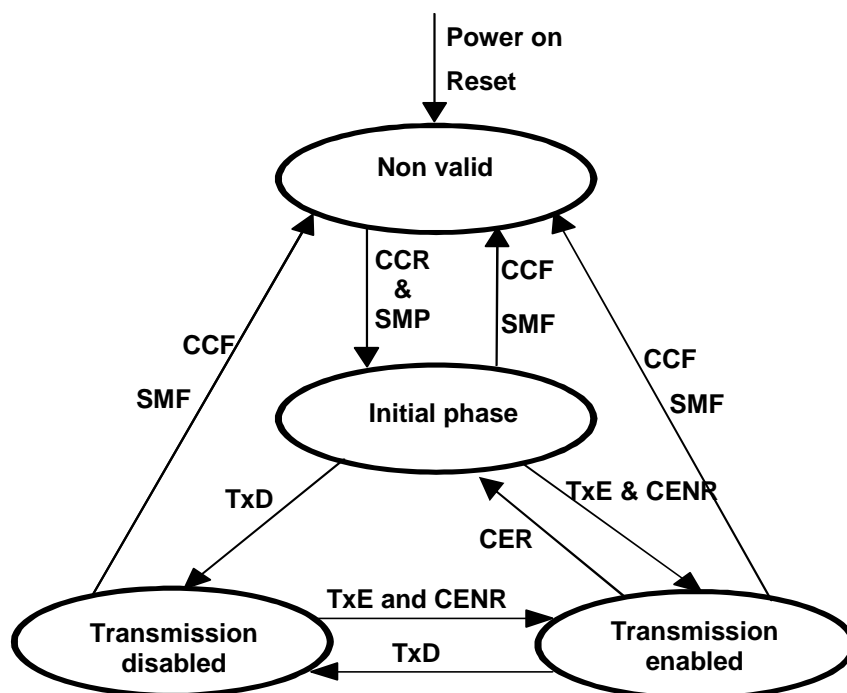

CER: Cessation of Emissions Required;
 CENR: Cessation of Emissions Not Required;
 SMP: System Monitoring Pass;
 SMF: System Monitoring Fail;
 TxE: Transmission Enable command;
 TxD: Transmission Disable command;
 CCR: Control Channel correctly Received;
 CCF: Control Channel reception Failure.

Figure 2: State transition diagram of the control and monitoring function of an NEST

NOTE 2: From "Transmission disabled" state a TxE command may also result in a transition towards the "Initial phase" state.

When the NEST transmits several carriers having different frequencies, an NEST state machine as described above may be associated with each carrier or each set of carriers. The events then apply to the subsystem associated with the specific carrier or the specific set of carriers, rather than the whole NEST.

4.2.8.2 Processor monitoring

4.2.8.2.1 Justification

To ensure that the NEST can suppress its transmissions in the event of a processor sub-system failure.

4.2.8.2.2 Specification

The NEST shall incorporate a processor monitoring function for each of its processors involved in maintaining the performance requirements of the present document and in Control and Monitoring Functions (CMF).

The processor monitoring function shall detect failures of these processors' hardware and software.

In the "Transmission enabled" state, the NEST shall enter the "Non valid" state or the "Carrier-off" radio state no later than 1 second after any fault condition occurs. In all states, the NEST shall enter the "Non valid" state within a maximum of 30 seconds after the occurrence of any persistent fault condition. Once in the "Non Valid" state, the NEST shall remain in the "Non Valid" state until the processor monitoring function has determined that all fault conditions have been cleared.

4.2.8.2.3 Conformance tests

Conformance tests shall be carried out in accordance with clause 6.9.3.

4.2.8.3 Transmit subsystem monitoring

4.2.8.3.1 Justification

To ensure the inhibition of transmissions that are potentially harmful to other systems in the event of incorrect operation of the transmit frequency generation sub-system.

4.2.8.3.2 Specification

The NEST shall monitor the operation of its transmit sub-system and shall be able to detect:

- a) loss of frequency lock; or
- b) absence of Local Oscillator (LO) output signal.
- c) exceedance of $EIRP_{max}$ or EIRP density mask.
- d) No later than 1 second after any of these fault conditions of the transmit sub-system occurs, the NEST shall enter the "Non-valid" state or the "Carrier-off" radio state until the transmit sub-system monitoring function has determined that all fault conditions have been cleared (see clause 4.2.8.2.2 for detailed specification).

4.2.8.3.3 Conformance tests

Conformance tests shall be carried out in accordance with clause 6.9.4.

4.2.8.4 Power-on/Reset

4.2.8.4.1 Justification

To demonstrate that the NEST achieves a controlled non-transmitting state following the powering of the unit, or the occurrence of a reset made by a local operator.

4.2.8.4.2 Specification

During and following a reset the NEST shall remain in the "Non-valid" state until all the conditions for entering "Initial phase" have been satisfied.

4.2.8.4.3 Conformance tests

Conformance tests shall be carried out in accordance with clause 6.9.5.

4.2.8.5 Control Channel (CC) and Response Channel (RC)

4.2.8.5.1 Justification

To ensure that the NEST cannot transmit unless it correctly receives the CC messages from the NCF.

Control Channels (CC) are used by NESTs to receive control information from the NCF and Response Channels (RCs) to respond to the NCF. For an NEST designed to operate within networks where the NCF determines that the NEST shall cease emissions, then the CCs and RCs are also used for the dialogue with the NCF.

4.2.8.5.2 Specification

4.2.8.5.2.1 Specification 1: types of CCs and RCs

- a) The NEST shall have at least one CC from the NCF. If exchange of information with the NCF is necessary for operation of the NEST then the NEST shall have at least one RC to the NCF (see clause 4.2.6). Each CC and each RC may be internal or external.

The types (internal or external) of each CC and each RC shall be declared by the applicant.

NOTE 1: The availability of the network carrying the external CC(s) and RC(s) and the numbers of external CC(s) and RC(s) are not within the scope of the present document.

NOTE 2: Some satellite operators may require that internal CC(s) and or RC(s) are available.

- b) The connection between the NCF and the NEST via the CCs and RCs shall be either permanent or shall be set up on a call by call basis through a switched network. In case of connection through a switched network the NEST shall be able to receive calls from the NCF and to initiate calls towards the NCF in order to set up the CCs and RCs.
- c) The NEST with an external CC shall not transmit without receiving an appropriate signal from the NCF indicating to the NEST that the NCF is alive and insuring that the NEST is pointing to the target satellite.

4.2.8.5.2.2 Specification 2: CC Reception

- a) The NEST shall enter the "Non-valid" state if it does not correctly receive the CC from the NCF within a period not to exceed 30 seconds. This event is called a "CC disruption":
- In the case of external CCs and RCs without permanent connection of the NCF with the NEST, the ability to receive CC messages from the NCF is the ability at any time to receive calls and messages within the timing requirements of the present document from the network through which is connected the NCF.
 - The inability to receive CC messages from the NCF may be due to the following various causes but not limited to them: no received signal from the NCF or from the network, a too low level received signal, no network accessible, the inability to lock onto the received carrier frequency, to demodulate, to decode, to receive calls and/or messages, a hardware failure or power off.
- b) The NEST shall remain in the "Non-valid" state as long as the NEST is unable to receive CC messages from the NCF.
- c) From the "Non-valid" state the NEST may enter the "Initial phase" state if the following conditions are met:
- the NEST is able to receive CC messages from the NCF; and
 - no fault conditions are present.

4.2.8.5.3 Conformance tests

Conformance tests shall be carried out in accordance with clause 6.9.6.

4.2.8.6 Network control commands

4.2.8.6.1 Justification

These requirements ensure that the NEST is capable of:

- a) retaining a unique identification in the network;
- b) receiving commands from the NCF through its CC(s) and executing those commands.

4.2.8.6.2 Specification

The NEST shall hold, in non-volatile memory, its unique identification code in the network.

The NEST shall be capable of receiving through its CCs dedicated messages (addressed to the NEST) from the NCF, and which contain:

- Transmission Enable commands (TxE);
- Transmission Disable commands (TxD).

When in the "Initial phase" or "Transmission enabled" states, once a transmission disable command is received, within 1 second the NEST shall enter into, and shall remain in the "Transmission disabled" state until the transmission disable command is superseded by a subsequent transmission enable command (see also clause 4.2.6).

When in the "Initial phase" or "Transmission disabled" states, once a transmission enable command is received, the NEST may enter into the "Transmission enabled" state.

When entering the "Initial phase" from the "Non-valid" state, the last TxE or TxD command received from the NCF may be used by the NEST to enter the "Transmission enabled" state or the "Transmission disabled" state, respectively, if since the time of reception of that command no "CC disruption" has occurred.

NOTE: The physical unit in charge of the reception of the CCs, of the transmissions of the RCs and of the CC commands reception may be a separate and independent unit from the other units of the NEST or it may be common to several NESTs.

4.2.8.6.3 Conformance tests

Conformance tests shall be carried out in accordance with clause 6.9.7.

4.2.8.7 Initial burst transmission

4.2.8.7.1 Justification

Restrictions on the initial burst transmissions are necessary to limit disturbance to other services.

4.2.8.7.2 Specification

For systems where no transmission enable command is foreseen without request from the NEST, in the "Initial phase" state the NEST may transmit initial bursts:

- a) The NEST shall only transmit initial bursts after confirming that no cessation of emission applies where the NEST is located. This confirmation shall be obtained either by local means (see clause 4.2.6) or from the NCF via an external control channel.
- b) The duty cycle of the initial burst transmission shall not exceed 0,2 %, where the duty cycle is defined as the ratio of burst duration to the duration between two successive bursts.
- c) The initial burst shall be transmitted at an EIRP not greater than $EIRP_{max}$.
- d) The duration between two successive bursts shall not be less than the required NCF response time as declared by the applicant. This response time is defined as the duration, measured at the NEST, between an initial burst transmission and the reception and processing of a transmission enable or disable command from the NCF which is never exceeded during 99 % of the cases under normal conditions in the system for which the NEST is designed, as declared by the applicant.

4.2.8.7.3 Conformance tests

Conformance tests shall be carried out in accordance with clause 6.9.8.

4.2.8.8 Inhibition of transmissions

4.2.8.8.1 Justification

To ensure the correct inhibition of transmissions that are potentially harmful to other systems and persons in the event of signal blockage.

4.2.8.8.2 Specification

NEST shall enter the "Carrier-off" radio state within a period not exceeding 1 second, whenever there is a continuous and complete loss of the signal at the receiver, and shall remain in this radio state until the receiver carrier has been restored.

If the receive carrier is not restored within IT_{\max} (see clause 4.2.2.2), then the NEST shall transition to the "Initial phase" state.

The applicant shall declare the time to transition from "Carrier off" to "Carrier on" radio state (T_{trans}) when in "Transmission enabled" state after the receive carrier is restored within IT_{\max} .

4.2.8.8.3 Conformance tests

Conformance tests shall be carried out in accordance with clause 6.9.9.

4.2.9 Receive antenna off-axis gain pattern

4.2.9.1 Justification

To protect the wanted signals from interference from terrestrial services and from other satellite services.

4.2.9.2 Specification

The maximum antenna gain of each of the co-polarized components in any direction φ degrees from the antenna main beam axis shall not exceed the following limits:

$$G = 36 - 25 \log \varphi \quad \text{dBi} \quad \text{for } \varphi_{\min} \leq \varphi < 44^\circ$$

$$G = -5 \quad \text{dBi} \quad \text{for } 44^\circ \leq \varphi \leq 75^\circ$$

$$G = 0 \quad \text{dBi} \quad \text{for } 75^\circ \leq \varphi \leq 180^\circ$$

where:

$$\varphi_{\min} = 1^\circ \text{ or } 100 \lambda/D \text{ degrees, whichever is the greater, for } D/\lambda \geq 50.$$

$$\varphi_{\min} = 2^\circ \text{ or } 114 (D/\lambda)^{-1.09} \text{ degrees, whichever is the greater, for } D/\lambda < 50.$$

D is the nominal diameter of the antenna.

In addition the maximum antenna gain of each of the cross-polarized components in any direction φ degrees from the antenna main beam axis shall not exceed the following limits:

$$G_x(\varphi) = 23 - 20 \log \varphi \quad \text{dBi} \quad \text{for } \varphi_r \leq \varphi \leq 7^\circ$$

$$G_x(\varphi) = 20,2 - 16,7 \log \varphi \quad \text{dBi} \quad \text{for } 7^\circ < \varphi \leq 32,3^\circ$$

$$G_x(\varphi) = -5 \quad \text{dBi} \quad \text{for } 32,3^\circ < \varphi \leq 75^\circ$$

$$G_x(\varphi) = 0 \quad \text{dBi} \quad \text{for } 75^\circ < \varphi \leq 180^\circ$$

where φ_r is equal to 1° or $100 \lambda/D$, whichever is greater.

4.2.9.3 Conformance tests

Conformance tests shall be carried out in accordance with clause 6.11.

4.2.10 Blocking performance

4.2.10.1 Justification

To prevent high power signals outside the receive frequency band from blocking the reception of signals inside the receive frequency band.

4.2.10.2 Specification

Receiver blocking is characterized here through gain compression for a signal inside the receive frequency band that is caused by another signal outside the receive frequency band at high power. The level of the other signal is compared to the level of a signal inside the receive frequency band that would cause the same gain compression.

Receiver blocking rejection at a particular frequency is defined as the level of a second signal at this frequency that causes a certain gain compression to a first signal inside the receive frequency band, minus the level of a second signal at a frequency inside the receive frequency band that causes the same gain compression.

The first signal shall be at the centre frequency of the receive frequency band and have a level in the operational range. The second signal shall cause a gain compression for the first signal of 1 dB.

The rejection shall comply with table 6.

Table 6: Receiver blocking rejection

Frequency	Minimum rejection
below 9 GHz	20 dB
9 GHz to 10 GHz	10 dB
14 GHz to 16 GHz	10 dB
Above 16 GHz	20 dB
NOTE: In the frequency ranges 10 GHz to 10,7 GHz and 12,75 GHz to 14 GHz, the rejection needs further studies.	

4.2.10.3 Conformance tests

Conformance tests shall be carried out in accordance with clause 6.11.

4.2.11 Adjacent Signal Selectivity

4.2.11.1 Justification

To enable reception of a wanted signal in presence of other signals on adjacent frequencies which are transmitted with high EIRP density from other satellites.

NOTE: The power level of signals transmitted from the same constellation are under control of the satellite operator. Signals transmitted from satellites in an adjacent orbit or from satellites in the GSO are attenuated by the discrimination available from antenna gain pattern.

4.2.11.2 Specification

Adjacent Signal Selectivity is a measure of a receiver's ability to receive a signal at its assigned channel frequency in the presence of an adjacent signal at a given frequency offset from the centre frequency of the assigned channel. The adjacent signal shall occupy the same bandwidth as the wanted signal. Frequency offset and relative power level of the adjacent signal compared to the wanted signal shall take the value given in table 7. BW is the wanted signal occupied bandwidth.

Table 7: Adjacent signal frequency and Power level

Signal	Centre frequency offset from wanted signal	Power level relative to wanted signal
Adjacent Carrier	BW	7 dBsd

The decrease in the measured signal to noise ratio in the presence of the stated adjacent signal shall be no more than 0,5 dB.

4.2.11.3 Conformance tests

Conformance tests shall be carried out in accordance with clause 6.12.

5 Testing for compliance with technical requirements

5.1 Environmental conditions for testing

Survivability testing shall be carried out prior to tests on the radiation and stabilization subsystems.

Tests defined in the present document shall be carried out at representative points within the boundary limits of the declared operational environmental profile.

5.2 Essential radio test suites

The essential radio test suites for a complete NEST are given in clause 6.

6 Test methods for all aspects of the NEST

6.1 General

6.1.1 General requirements

The present clause describes the general requirements for verifying that the performance of the EUT complies with the specifications. However, the specific testing methodology to be used for measuring performance is left to the applicant in order to allow the methodology to be matched to the EUT. The applicant shall maintain documentary evidence of the results obtained in performing the essential radio tests. At a minimum, the documentary evidence shall include:

- test setup (configurations, test equipment and calibration status);
- test conditions (environmental and operational parameters);
- method of testing;
- results of measurements, measurement resolution and uncertainty; and
- statement of compliance with technical specifications of the present document.

The test conditions for each test shall be representative of the intended operational environment and be noted in the test report where it has a significant effect on the measurement results.

The type, termination and length of each cable used shall be representative of the intended installation and recorded in the test report. For maximum cable lengths longer than 10 m, as declared by the applicant, the tests shall be performed with cables no shorter than 10 m.

6.1.2 Interpretation of measurement results

The interpretation of the results for the measurements described in the present document shall be as follows:

- the measured value related to the corresponding limit shall be used to decide whether an equipment meets the requirements of the present document;
- the measurement uncertainty value for the measurement of each parameter shall be recorded;
- the recorded value of the measurement uncertainty shall be wherever possible, for each measurement, equal to or less than the figures in table 8.

For the test methods, according to the present document, the measurement uncertainty figures shall be calculated in accordance with the guidance provided in ETSI TR 100 028 [i.7] and shall correspond to an expansion factor (coverage factor) $k = 1,96$ or $k = 2$ (which provide confidence levels of respectively 95 % and 95,45 % in the case where the distributions characterizing the actual measurement uncertainties are normal (Gaussian)).

Table 6 is based on such expansion factors.

Table 8: Maximum measurement uncertainties

Parameter	Maximum expanded measurement Uncertainty
Radio frequency	$\pm 1 \times 10^{-7}$
Radiated RF power ($f \leq 40$ GHz)	± 6 dB
Radiated RF power ($f > 40$ GHz)	± 8 dB
Conducted Measurements ($f \leq 18$ GHz)	$\pm 1,5$ dB
Conducted Measurements ($18 \text{ Hz} < f \leq 40$ GHz)	$\pm 2,5$ dB
Conducted Measurements ($f > 40$ GHz)	± 4 dB
Temperature	± 1 °C
Humidity	± 5 %
DC and low frequency voltages	± 3 %

"Standard" measurement equipment is available up to a frequency range of around 66 GHz with a sensitivity of -72 dBm at 18 GHz down to around -64 dBm at 40 GHz (1 MHz RBW, 3 MHz VBW, 100 MHz span). For higher frequencies the sensitivity will further decrease.

The measurement uncertainty of measurements in the range above 40 GHz (millimetre domain) will be clearly above the initially assumed 6 dB for radiated measurements below 40 GHz. A value of 8 dB seems to be more adequate. Precise values of measurement uncertainty require calibration, and there are limitations.

This maximum uncertainty value above 40 GHz is also dependent upon the maximum dimensions of the antenna of the equipment under test and is also dependent upon gain specifications of antennae.

Additional information on radiated measurements up to 100 GHz is available in ETSI TS 103 052 [i.3].

The test site and the method of measurement shall also be in accordance with CISPR 16-1-4 [2] as applicable.

Where a radome is required in operation, the tests should be conducted with the radome in place or, if testing with the radome in place is impractical, then an appropriate analytic technique shall be used to compensate for the absence of the radome.

To enable the performance tests to be carried out the use of an NCF or a Special Test Equipment (STE), made available by the applicant or system provider, may be necessary. Since this STE will be specific for the particular system, it is not possible to provide detailed specifications in the present document. However, the following baseline is provided:

- if the NEST requires to receive a modulated carrier from the satellite in order to transmit, then special test arrangements are required to simulate the satellite signal, thus enabling the NEST to transmit allowing measurement of transmission parameters;
- any characteristic of these special test arrangements which may have direct or indirect effects on the parameters to be measured shall be clearly stated by the applicant.

All tests with carrier-on shall be undertaken with the transmitter operating at $EIRP_{max}$, as per the specific requirement, and with the normal radio operating parameters, as declared by the applicant.

If the Equipment Under Test (EUT) is an NEST that requires hardware and/or software modification(s) performed by the applicant for these tests then full documentation of such modification(s) shall be provided to demonstrate that the modification(s) will simulate the required test condition, without its main characteristics being changed.

6.1.3 Measuring receiver

The term "measuring receiver" refers to a frequency-selective voltmeter or a spectrum analyser. In order to obtain the required sensitivity, a narrower measurement bandwidth may be necessary. In such cases, this shall be stated in the test report form. The bandwidth of the measuring receiver and the deployed detectors shall be as given in table 9.

Table 9: Measurement receiver parameters

Frequency range: (f)	Measuring receiver bandwidth	Detector
$30 \text{ MHz} \leq f \leq 1\,000 \text{ MHz}$	100 kHz or 120 kHz	peak/RMS (see note 1)
$1\,000 \text{ MHz} < f \leq 40 \text{ GHz}$	1 MHz	peak/RMS
$f > 40 \text{ GHz}$	1 MHz (see note 2)	peak/RMS
NOTE 1: With the values from the peak and the RMS detector the quasi peak value can be calculated for particular measurement applications.		
NOTE 2: The actual frequency accuracy shall be taken into account to determine the minimum measurement bandwidth possible.		

In case a narrower measurement bandwidth was used, the following conversion formula has to be applied:

$$B = A + 10 \log \frac{BW_{ref}}{BW_{MEASURED}}$$

Where:

- A is the value at the narrower measurement bandwidth;
- B is the value referred to the reference bandwidth; or
- use the measured value, A, directly if the measured spectrum is a discrete spectral line. (A discrete spectrum line is defined as a narrow peak with a level of at least 6 dB above the average level inside the measurement bandwidth.)

6.2 Off-axis spurious radiation

6.2.1 General

The tests for the NEST specification in clause 4.2.3.2 shall be conducted in "Carrier on", "Carrier off" and "Emissions disabled" radio states as required. The tests in "Carrier on" radio state shall be undertaken with the transmitter operating at $EIRP_{max}$.

6.2.2 Test method

6.2.2.1 General

The applicant shall declare the test methods used to identify frequencies of off-axis spurious radiation and to measure (or calculate) the radiated power levels of identified spurious radiations.

NOTE: For the purposes of this procedure, the measuring antenna is aligned to the polarization which produces the largest response between the EUT and the measuring antenna.

The tests for the specification in clause 4.2.3.2 shall be limited to the "Carrier-on" radio state. The tests shall be undertaken with the transmitter operating at $EIRP_{max}$.

The NEST may be tested with or without antenna. An "EUT with antenna" is an NEST with integral antenna. An "EUT without antenna" is an NEST with the removable antenna removed.

In the case where the NEST antenna is remotely mounted from the associated electronics, the connecting cable shall be of the same type and length as specified by the applicant in the installation manual. If the cable is normally longer than 10 m, a cable of 10 m in length may be used for the test. The type and length of cable used shall be entered in the test report.

The EUT shall be terminated with matched impedance at the terrestrial ports if recommended by the applicant in the user documentation and if there is no associated equipment connected to each port.

For frequencies up to 80 MHz the measuring antenna shall be a balanced dipole with a length equal to the 80 MHz resonant length and shall be matched to the feeder by a suitable balanced transforming device. Measurements with broad band antennas are also possible provided that the test site has been validated according to CISPR 16-1-4 [2].

For frequencies between 80 MHz and 1 000 MHz the measuring antenna shall be a balanced dipole which shall be resonant in length. Measurements with broadband antennas are also possible provided that the test site has been validated according to CISPR 16-1-4 [2].

For frequencies above 1 000 MHz the antenna shall be a horn radiator of known gain/frequency characteristics. When used for reception the antenna and any associated amplification system shall have an amplitude/frequency response within ± 2 dB of the combined calibration curves across the measurement frequency range considered for the antenna. The antenna is mounted on a support capable of allowing the antenna to be used in either horizontal or vertical polarization and at the specified height.

6.2.2.2 Multi-carrier operation

For NESTs designed to transmit simultaneously several carriers the verification up to 1 000 MHz shall be performed with one or more carriers and the verification above 1 000 MHz shall be repeated for each combination of carriers declared by the applicant.

For each combination of carriers the applicant shall declare the carriers' centre frequencies and characteristics, the maximum value of the total on-axis EIRP of the carriers and the relative levels of the carriers (in dBs) at the input or output of the HPA or antenna.

In the case of combinations of carriers with identical characteristics and when the power at the input of the HPA does not exceed the maximum input power with two carriers, the verification may be limited to the case with two carriers and with the maximum frequency separation between them.

In any other case, the number of configurations to be verified above may be limited to the cases which can be proven by the applicant, by documentary evidence or demonstration, to generate the maximum EIRP density level of the out-of-band emissions due to inter-modulation products.

6.2.3 Measurements up to 1 000 MHz

6.2.3.1 Test site

The test shall be performed either in an open area test site, a semi-anechoic chamber or an anechoic chamber. Ambient noise levels shall be at least 6 dB below the applicable unwanted emissions limit.

The open area test site shall be flat, free of overhead wires and nearby reflecting structures, sufficiently large to permit aerial placement at the specified measuring distance and provide adequate separation between aerial, test unit and reflecting structures, according to CISPR 16-1-4 [2].

For both the open area test site and the semi-anechoic chamber a metal ground plane shall be inserted on the natural ground plane and it shall extend at least 1 m beyond the perimeter of the EUT at one end and at least 1 m beyond the measurement antenna at the other end.

The distance between the EUT and the measuring antenna should be 10 m. For measurements at a different distance an inverse proportionality factor of 20 dB per decade shall be used to normalize the measured data to the specified distance for determining compliance. Care should be taken in measurement of large test units at 3 m at frequencies near 30 MHz due to near field effects.

6.2.3.2 Measuring receivers

Measuring receivers shall conform to the following characteristics:

- the response to a constant amplitude sine wave signal shall remain within ± 1 dB across the frequency range of interest;
- quasi-peak detection shall be used in a -6 dB bandwidth of 120 kHz;
- the receiver shall be operated below the 1 dB compression point.

6.2.3.3 Procedure

- a) The EUT shall be an EUT with antenna or, preferably, without antenna but with the antenna flange terminated by a dummy load.
- b) The EUT shall be in the "Carrier-on" radio state.
- c) The EUT shall be rotated through 360° and, except in an anechoic chamber, the measuring antenna shall be rotated and height varied from 1 m to 4 m above the ground plane to determine the maximum emission.
- d) All identified spurious radiation shall be measured and noted in frequency and level.

6.2.4 Measurements above 1 000 MHz

6.2.4.1 General

The spectrum analyser resolution bandwidth shall be set to the specified measuring bandwidth or as close as possible. If the resolution bandwidth is different from the specified measuring bandwidth, bandwidth correction shall be performed for the noise-like wideband spurious.

For an EUT with antenna the tests shall be performed in two stages for both the "Carrier-on" and "Carrier-off" radio states:

- Procedure a): Identification of the significant frequencies of spurious radiation.
- Procedure b): Measurement of radiated power levels of identified spurious radiation.

For an EUT without antenna the tests shall be performed in three stages for both the "Carrier-on" and "Carrier-off" radio states:

- Procedure a): Identification of the significant frequencies of spurious radiation.
- Procedure b): Measurement of radiated power levels of identified spurious radiation.
- Procedure c): Measurement of conducted spurious radiation radiated through the antenna flange.

6.2.4.2 Identification of the significant frequencies of spurious radiation

6.2.4.2.1 Test site

The identification of frequencies emitting from the EUT shall be performed either in an anechoic chamber, an open area test site or a semi-anechoic chamber with the test antenna close to the EUT and at the same height as the volume centre of the EUT.

6.2.4.2.2 Procedure

- a) The EUT shall be in the "Carrier-off" radio state.
- b) For an EUT with antenna the main beam of the antenna shall have an angle of elevation corresponding to 8 dBi antenna gain, and, for an EUT without antenna the antenna flange shall be terminated by a dummy load.
- c) The receivers shall scan the frequency band while the EUT revolves.
- d) The EUT shall be rotated through 360° and the frequency of any spurious signals noted for further investigation.
- e) For an EUT with antenna the test shall be repeated with the test antenna being in the opposite polarization.
- f) The test shall be repeated in the "Carrier-on" radio state while transmitting one modulated carrier at maximum power.

6.2.4.3 Measurement of radiated power levels of identified spurious radiation

6.2.4.3.1 Test site

The measurement of each spurious radiation noted during procedure a) of the test shall be performed on a test site that is free from reflecting objects, i.e. either an open-area test site, a semi-anechoic chamber or an anechoic chamber.

6.2.4.3.2 Procedure

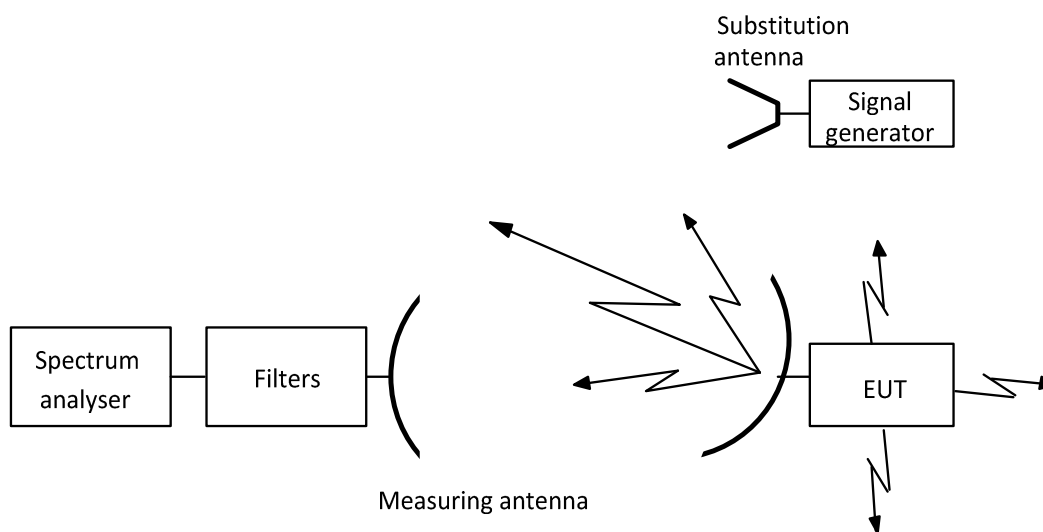

Figure 3: Test arrangement - Spurious radiation measurement above 1 000 MHz for an EUT with antenna

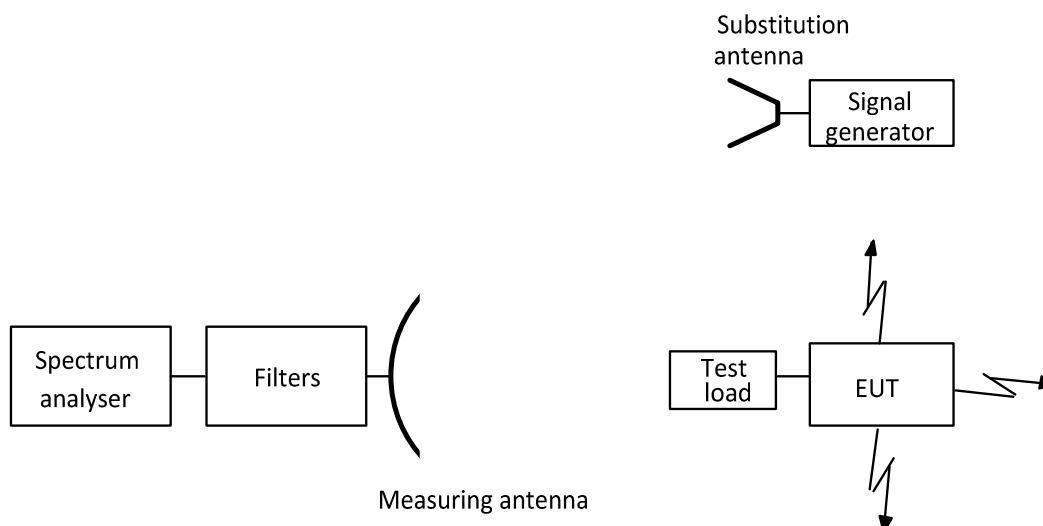

Figure 4: Test arrangement - spurious radiation measurements above 1 000 MHz for an EUT without antenna

- a) The test arrangement shall be as shown in figure 3 or 4.
- b) The EUT shall be installed at a height between 0,5 m and 1,0 m on a non-metallic turntable. For an EUT with separable components, the components shall be separated by 1 m to 2 m. For the test arrangement shown in figure 3 the main beam of the antenna shall have an angle of elevation sufficient to achieve a peak gain of 8 dBi in the direction the test receiver. Necessary precautions should be taken to avoid EUT emissions towards GSO satellite networks and NGSO satellite systems.
- c) The measuring antenna shall be positioned at a distance from the EUT (e.g. 3 m, 5 m, 10 m) relevant to the applied test site. The measuring antenna shall be adjusted in height and the EUT rotated, while the EUT is in the appropriate carrier condition, for a maximum response on the associated spectrum analyser at each spurious frequency previously identified, this response level shall be noted. The adjustment in height of the measuring antenna does not apply when an anechoic chamber is being used. The measuring antenna shall never enter the 8 dBi off-axis cone around the main beam direction.
- d) The investigation shall be repeated with the measuring antenna in the opposite polarization and the response level similarly noted.
- e) The EUT shall be replaced by the substitution antenna to which is connected a signal generator. The main beam axes of the measuring and substitution antennas shall be aligned. The distance between these antennas shall be the distance determined under test c).
- f) The substitution and measuring antennas shall be aligned in the polarization which produced the larger response between the EUT and the test antenna in steps c) and d).
- g) The output of the generator shall be adjusted so that the received level is identical to that of the previously noted largest spurious radiation.
- h) The output level of the signal generator shall be noted. The EIRP of the spurious radiation is the sum, in dB, of the signal generator output plus the substitution antenna isotropic gain minus the interconnection cable loss.

6.2.4.4 Measurement of conducted spurious radiation at the antenna flange

6.2.4.4.1 Test site

There are no requirements for the test site to be used for this test.

6.2.4.4.2 Procedure

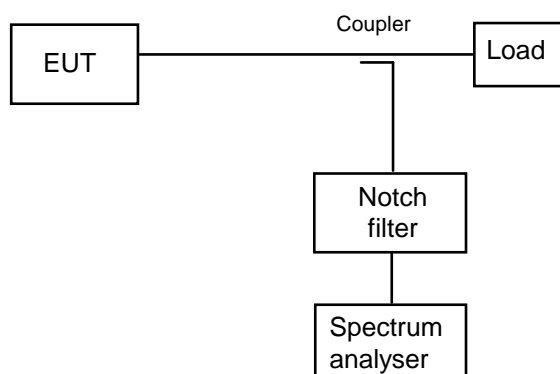

Figure 5: Test arrangement - conducted spurious radiation above the cut-off frequency

- a) The test arrangement shall be as shown in figure 5 with the notch filter being optional. In order to protect the spectrum analyser while ensuring the necessary measurement accuracy, particularly close to the carrier, if a notch filter is used it shall be tuned to the transmit carrier frequency.
- b) The frequency range from the cut-off frequency of the waveguide of the EUT to 60 GHz shall be investigated for spurious radiation while in the "Carrier-on" radio state with the carrier being at maximum power and normally modulated.
- c) To obtain the off-axis spurious EIRP value for test, the measured antenna transmit gain, measured at the frequency of the identified unwanted emission, for the off-axis angle corresponding to the angle to the horizon shall be added to the measured power density and any correction or calibration factors summated with the result.
- d) The test shall be repeated in the "Carrier-off" radio state.

6.3 On-axis spurious radiation

6.3.1 Test method

6.3.1.1 General

The tests shall be undertaken with the transmitter operating at $EIRP_{max}$.

6.3.1.2 Test site

There are no requirements for the test site to be used for this test.

6.3.1.3 Method of measurement

6.3.1.3.1 General

For NEST equipment for which measurements at the antenna flange are possible and agreed by the applicant, the measurements shall be performed at the antenna flange.

For NEST equipment for which measurements at the antenna flange are not possible or not agreed by the applicant, the measurements shall be performed with a test antenna.

6.3.1.3.2 Method of measurement at the antenna flange

6.3.1.3.2.1 General

- a) The test arrangement shall be as shown in figure 5 with the notch filter being optional. In order to protect the spectrum analyser while ensuring the necessary measurement accuracy, particularly close to the carrier, if a notch filter is used it shall be tuned to the transmit carrier frequency.
- b) The EUT shall transmit one modulated carrier continuously, or at its maximum burst rate where applicable, centred on a frequency as close to the lower limit of the operating frequency band of the EUT as possible. The EUT shall be operated at $EIRP_{max}$. The frequency range 14,0 GHz to 14,50 GHz shall be investigated.
- c) Due to the proximity of the carrier the spectrum analyser resolution bandwidth shall be set to a measurement bandwidth of 3 kHz, or as close as possible. If the measurement bandwidth is different from the specified measurement bandwidth, bandwidth correction shall be performed for noise-like wideband spurious radiation.
- d) To obtain the on-axis spurious EIRP, the antenna transmit gain shall be added to any figure obtained in the above measurement and any correction or calibration factor summated with the result. The antenna gain shall be as measured in clause 6.3.1.3.2.2 at the closest frequency to the spurious frequency.
- e) The tests in b) to e) shall be repeated with a transmit frequency in the centre of the operating frequency band.
- f) The tests in b) to e) shall be repeated with a transmit frequency as close to the upper limit of the operating frequency band of the EUT as possible.
- g) The tests in b) to f) shall be repeated in the "Carrier-off" radio state.

6.3.1.3.2.2 Antenna transmit gain

6.3.1.3.2.2.1 General

For the purpose of the present document, the antenna transmit gain is defined as the ratio, expressed in decibels (dBi), of the power that would have to be supplied to the reference antenna, i.e. an isotropic radiator isolated in space, to the power supplied to the antenna being considered, so that they produce the same field strength at the same distance in the same direction. Unless otherwise specified the gain is for the direction of maximum radiation.

For the purpose of this test the EUT is defined as the antenna and its flange. The antenna may include the reflector(s), feed, support struts and an enclosure of equal weight/distribution to any electrical equipment normally housed with the feed at the antenna focal point.

The applicant shall declare the operating frequency range of the EUT. For the tests in the clause 6.3.1.3.2.2 the following test frequencies shall be defined:

- Test Frequency A - the low test frequency shall be the middle of the lowest carrier in operating frequency range;
- Test Frequency B - the mid-range test frequency shall be the middle of the carrier that includes (or is adjacent to) the middle of the operating range; and
- Test Frequency C - the high test frequency shall be the middle of the highest carrier in the operating range.

6.3.1.3.2.2.2 Test site

This test shall be performed on either an outdoor far-field test site, compact test range or near-field scanner.

6.3.1.3.2.2.3 Method of measurement

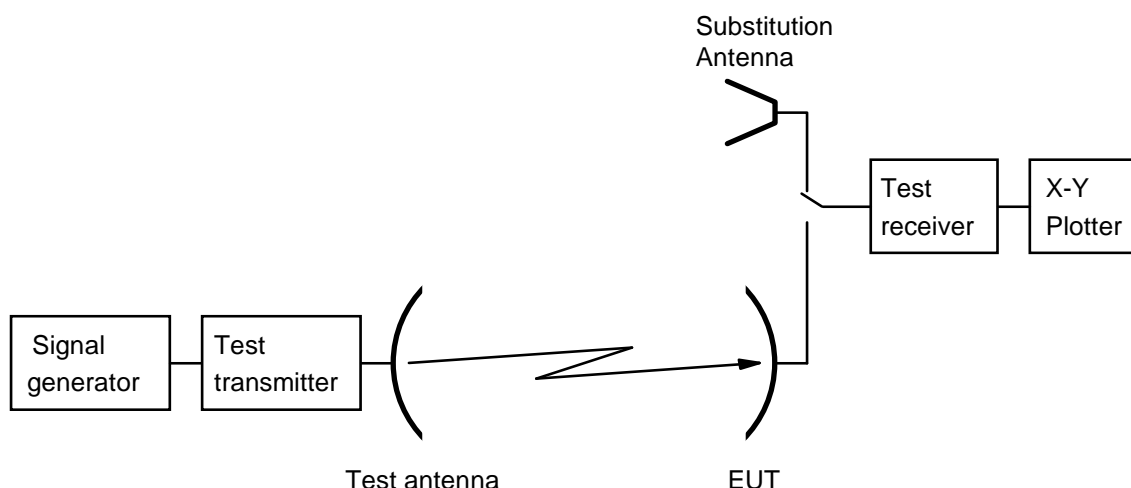

Figure 6: Test arrangement - antenna transmit gain measurement

- a) The test arrangement shall be as shown in figure 6 with the EUT connected to the test receiver. A signal proportional to the angular position from the servo mechanism shall be applied to the X-axis and the signal level from the test receiver shall be applied to the Y-axis of the plotter.
- b) A test signal at Test Frequency B shall be transmitted by the test transmitter through the test antenna. The E-plane shall be vertical. The EUT antenna main beam axis shall be aligned with the main beam axis of the test transmitter. The polarizer of the EUT antenna shall be rotated and adjusted such that the E-plane coincides with the E-plane of the test transmitter.
- c) The EUT shall be aligned to maximize the received signal and the X-Y plotter adjusted to give the maximum reading on the chart.
- d) The EUT shall be driven in azimuth in one direction through 10°.
- e) The pattern measurement is then obtained by driving the EUT in azimuth back through boresight to 10° the other side with the plotter recording the results.
- f) The EUT shall be replaced by the substitution antenna and the received signal level maximized.
- g) This level shall be recorded on the X-Y plotter.
- h) The substitution antenna shall be driven in azimuth as in d) and e).
- i) The gain of the EUT shall be calculated from:

$$G_{\text{EUT}} = L_1 - L_2 + C$$

where:

G_{EUT} is the gain of the EUT (dBi);

L_1 is the peak level obtained with the EUT (dB);

L_2 is the peak level obtained with the substitution antenna (dB);

C is the calibrated gain of the substituted antenna at the test frequency (dBi).

- j) The tests in c) to i) shall be repeated with the frequency changed to Test Frequency A.
- k) The tests in c) to i) shall be repeated with the frequency changed to Test Frequency C.
- l) The tests in b) to k) may be performed simultaneously.

6.3.1.3.3 Method of measurement for an EUT with antenna

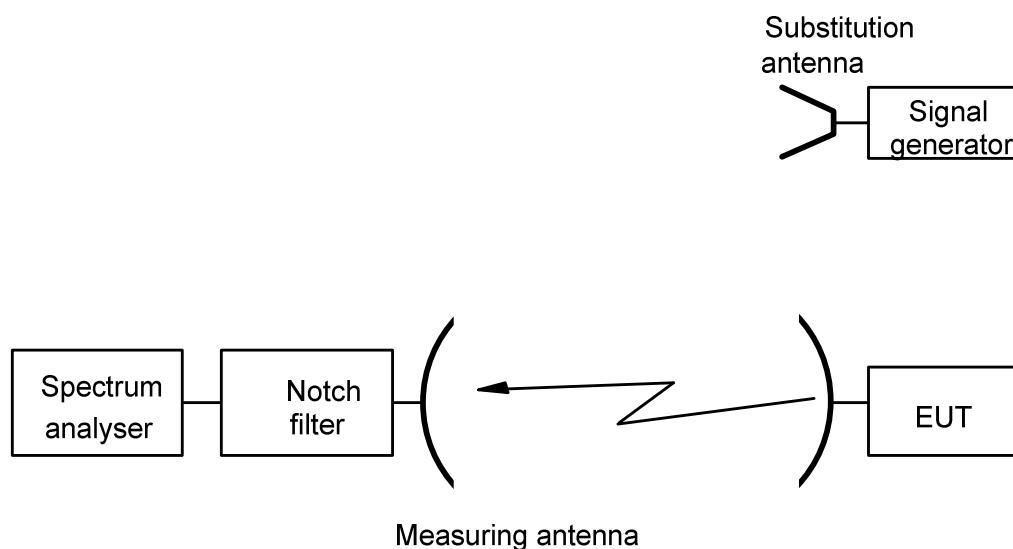

Figure 7: Test arrangement - on-axis spurious radiation measurements for an EUT with antenna

- The test arrangement shall be as shown in figure 7 with the notch filter being optional.
- The EUT shall be installed such that the units are separated by 1 m to 2 m with the indoor unit at a height between 0,5 m and 1,0 m on a non-metallic turntable.
- The spectrum analyser resolution bandwidth shall be set to the specified measuring bandwidth or as close as possible. If the resolution bandwidth is different from the specified measuring bandwidth, bandwidth correction shall be performed for noise-like wideband spurious radiation.
- The EUT shall transmit one modulated carrier continuously, or at its maximum burst rate where applicable, centred on a frequency as close to the lower limit of the operating frequency band of the EUT as possible. The EUT shall be operated at $EIRP_{max}$. The frequency range 14,0 GHz to 14,50 GHz shall be investigated and each spurious frequency shall be noted.
- Due to the proximity of the carrier the spectrum analyser resolution bandwidth shall be set to a measurement bandwidth of 3 kHz, or lower. If the measurement bandwidth is different from the specified measurement bandwidth, bandwidth correction shall be performed for noise-like wideband spurious radiation.
- The measuring antenna shall be positioned at a distance from the EUT (e.g. 3 m, 5 m, 10 m) relevant to the applied test site and shall be aligned with the EUT antenna for the transmit frequency. The measuring antenna shall be adjusted in height, while the EUT is in the appropriate carrier condition, for a maximum response on the associated spectrum analyser at each spurious frequency previously identified, this response level shall be noted. The adjustment in height of the measuring antenna does not apply when an anechoic chamber is being used.
- The EUT shall be replaced by a representative substitution antenna to which a signal generator is connected. The main beam axes of the measuring and substitution antennas shall be aligned. The distance between these antennas shall be the distance determined under test f).
- The substitution and measuring antennas shall be aligned to that polarization which produced the largest response between the EUT and the test antenna.
- The output of the generator shall be adjusted so that the received level is identical to that of the previously noted largest spurious radiation.
- The output level of the signal generator shall be noted. The EIRP of the on-axis spurious radiation is the sum, in dB, of the signal generator output plus the substitution antenna isotropic gain minus the interconnection cable loss.
- The tests in d) to j) shall be repeated with a transmit frequency in the centre of the operating frequency band.

- l) The tests in d) to j) shall be repeated with a transmit frequency as close to the upper limit of the operating frequency band of the EUT as possible.
- m) The tests in b) to l) shall be repeated in the "Carrier-off" radio state.

6.4 EIRP density

6.4.1 General

The EUT EIRP density values shall be measured and compared against the declared values of the EIRP density mask. Compliance shall be measured according to one of the two methods below.

6.4.2 Test method A radiated measurement

The test method described in 6.3 may be used. The NEST is to be operated at $EIRP_{max}$ and using a sampling bandwidth of 40 kHz to measure the EIRP density mask. Alternative sampling bandwidth may be used by applying a bandwidth correction factor to the results.

A measurement in each of the azimuth and elevation principal planes shall be made. If this is not sufficient to characterize the EIRP density mask, then measurements shall be taken at reasonable intervals throughout the angular range of operation of the EUT.

6.4.3 Test method B conducted measurement

The test method described in clause 6.3.1 may be used. The NEST is to be operated at $EIRP_{max}$ density and using a sampling bandwidth of 40 kHz to measure the power spectral density (P) in a 40 kHz bandwidth at the antenna flange. Alternative sampling bandwidth may be used by applying a bandwidth correction factor to the results.

The transmit antenna gain values declared by the Applicant shall be used to measure the EIRP density mask ($EIRP(\theta)$), using the formula:

$$EIRP(\theta) = P + G(\theta)$$

Where $G(\theta)$ is the co-polar antenna gain (dBi) of the NEST at the measurement angle, θ .

6.5 Carrier suppression

6.5.1 Test method

For the purposes of this test, the EUT shall transmit one carrier modulated continuously, or at its maximum burst rate where applicable, centred on the middle frequency of the operating frequency band as declared by the applicant. The "transmission disabled state" shall be obtained by use of the NCF or an STE, if required. For conducted measurements the maximum residual carrier power density within the nominated bandwidth shall be measured and added to the antenna on-axis gain. For radiated measurements the maximum residual EIRP density within the nominated bandwidth shall be measured and recorded. If the results obtained are within the limit given in clause 4.2.5.2, then the EUT shall be declared compliant with the requirements.

6.6 Antenna beam pointing

6.6.1 General

The antenna beam pointing test method is designed to verify the ability of the EUT to detect and correctly respond to beam pointing errors that exceed the threshold, $\delta\phi_{max}$, declared by the applicant as required in clauses 4.2.2.1.2.

For the purpose of these tests the EUT is the NEST with its antenna.

6.6.2 Test methods

There shall be a means for measuring and analysing true pointing error values declared by the applicant. The means of measuring and analysing pointing errors shall be included in the test report. The applicant may declare substitute a mechanical axis for reference if the offset between the RF boresight and this axis has been calibrated.

It shall also be verified that the EUT correctly detects an induced pointing error that has exceeded the pointing error threshold and enters the "Carrier-off" radio state no later than T seconds after the pointing error threshold is exceeded, where T is the response time declared by the applicant.

It shall be verified that the EUT re-enters the "Carrier-on" radio state only after the pointing error has been decreased and measured to be below the pointing error threshold over at least 3 successive measurements (with each measurement over a period of at least T seconds).

6.7 Cessation of emissions of the NEST

6.7.1 General

There shall be a means of simulating a condition where cessation of emissions is required. The spectrum analyser or the oscilloscope may be used to measure the time difference between the occurrence of the condition and the cessation of emissions. In all test methods, it shall be verified that the time difference does not exceed 1 second as specified in clause 4.2.6.2.3.

Where the EUT adds an operational margin around areas where cessation of emissions is required to account for the position determination accuracy and latency, the test procedure may simulate the actual behaviour of an EUT as it enters into an area where cessation of emissions is required. For example, if the EUT adds a margin of X metres around areas where cessation of emissions is required, then the test may begin with the EUT being simulated at a position more than X metres outside of an area where cessation of emissions is required. The test may then simulate the motion of the EUT towards the area where cessation of emissions is required. In any event, the EUT shall enter the "emission disabled" radio state within 1 second of entering the actual area where cessation of emissions is required.

For the purpose of these tests the EUT is the NEST either with, or without its antenna.

6.7.2 Test Method

6.7.2.1 Required documentation

The applicant shall declare the mode(s) of cessation of emissions implemented in the EUT and the NEST interfaces involved in the cessation of emissions as specified in clause 4.2.6.2.1.

The applicant shall demonstrate by documentary evidence compliance with specification 2 in clause 4.2.6.2.2 for the determination of the conditions under which the NEST shall cease emissions.

6.7.2.2 Cessation of emissions from the "Transmission enabled" state

- a) The EUT shall be set in the "Transmission enabled" NEST state.
- b) The EUT shall be set in the "Carrier on" radio state.
- c) A condition requiring the cessation of emission shall be initiated either by the STE or the EUT.
- d) It shall be verified that the EUT enters the "Emissions disabled" radio state.
- e) In order to verify that the EUT is in the "Transmission disabled" NEST state, it shall be verified that the EUT remains in the "Emissions disabled" radio state when the EUT is requested to transmit data.

6.7.2.3 Cessation of emission from the "Transmission disabled" state

- a) The EUT shall be set in the "Transmission disabled" state.

- b) A condition requiring the cessation of emission shall be initiated either by the STE or the EUT.
- c) In order to verify that the EUT remains in the "Transmission disabled" NEST state, it shall be verified that the EUT remains in the "Emissions disabled" radio state when the EUT is requested to transmit data.
- d) The STE shall send a TxE command to the EUT.
- e) In order to verify that the EUT remains in the "Transmission disabled" NEST state, it shall be verified that the EUT remains in the "Emissions disabled" radio state when the EUT is requested to transmit data.
- f) The STE shall send aTxD command to the EUT.
- g) The condition requiring the cessation of emissions shall be removed.
- h) In order to verify that the EUT remains in the "Transmission disabled "NEST state, it shall be verified that the EUT remains in the "Emissions disabled" radio state when the EUT is requested to transmit data.

6.7.2.4 Cessation of emission from the "Initial Phase" state

6.7.2.4.1 EUTs transmitting initial bursts

- a) The EUT shall be set in "Initial phase-BurstOn" state.
- b) The STE shall not send the TxE command and the EUT shall be allowed to cycle between "Initial phase-BurstOn" and "Initial phase-BurstOff" as it would under normal operations.
- c) A condition requiring the cessation of emission shall be initiated either by the STE or the EUT.
- d) It shall be verified that the EUT enters the "Emissions disabled" radio state.
- e) In order to verify that the EUT is in the "Initial phase-Standby "NEST state, it shall be verified that the EUT remains in the "Emissions disabled" radio state when the EUT is requested to transmit data.
- f) The STE shall send a TxE command to the EUT.
- g) In order to verify that the EUT remains in the "Initial phase-Standby "NEST state or enters the "Transmission disabled" NEST state, it shall be verified that the EUT remains in the "Emissions disabled" radio state when the EUT is requested to transmit data.
- h) Repeat the test steps a) through g) using a TxD command in step f) instead of the TxE command.

6.7.2.4.2 EUTs not transmitting initial bursts

This applies only to EUTs that do not transmit initial bursts (i.e. where only "Initial phase-Standby" is implemented):

- a) The EUT shall be set in "Initial phase-Standby" NEST state.
- b) The STE shall not send the TxE command to maintain the EUT in "Initial phase-Standby" NEST state.
- c) A condition requiring the cessation of emission shall be initiated either by the STE or the EUT.
- d) In order to verify that the EUT remains in the "Initial phase-Standby" NEST state, it shall be verified that the EUT remains in the "Emissions disabled" radio state when the EUT is requested to transmit data.
- e) The STE shall send a TxE command to the EUT.
- f) In order to verify that the EUT remains in the "Initial phase-Standby" NEST state or enters the "Transmission disabled" NEST state, it shall be verified that the EUT remains in the "Emissions disabled" radio state when the EUT is requested to transmit data.
- g) Repeat the test steps a) through f) using a TxD command in step e) instead of the TxE command.

6.7.2.5 "Single action" means of cessation of emissions

- a) It shall be verified that there is a "single action" means of ceasing emissions of the EUT (e.g. the switch thrown).
- b) The EUT shall be set in the "Transmission enabled" NEST state.
- c) The EUT shall be set in the "Carrier on" radio state.
- d) The "single action" means of cessation of emissions shall be activated.
- e) It shall be verified that the EUT enters the "Emissions disabled" radio state.
- f) In order to verify that the EUT is in the "Transmission disabled" NEST state, it shall be verified that the EUT remains in the "Emissions disabled" radio state when the EUT is requested to transmit data.
- g) The STE shall send a TxE command to the EUT.
- h) In order to verify that the EUT remains in the "Transmission disabled" NEST state, it shall be verified that the EUT remains in the "Emissions disabled" radio state when the EUT is requested to transmit data.
- i) The EUT shall be switched off and then switched on and the EUT shall enter the "Initial phase" NEST state without receiving a TxE from the STE.
- j) The "single action" means of cessation of emissions shall be activated.
- k) The STE shall send a TxE command to the EUT.
- l) In order to verify that the EUT remains in the "Initial phase" NEST state or enters the "Transmission disabled" NEST state, it shall be verified that the EUT remains in the "Emissions disabled" radio state when the EUT is requested to transmit data.
- m) The EUT shall be switched off and then switched on and the EUT shall enter the "Initial phase" NEST state without receiving a TxE from the STE.
- n) The STE shall send a TxD command to the EUT so that it enters the "Transmission disabled" NEST state.
- o) The "single action" means of cessation of emissions shall be activated.
- p) The STE shall send a TxE command to the EUT.
- q) In order to verify that the EUT remains in the "Transmission disabled" NEST state, it shall be verified that the EUT remains in the "Emissions disabled" radio state when the EUT is requested to transmit data.

6.7.2.6 Fault conditions

The applicant shall declare the means of generating fault conditions.

- a) The EUT shall be set in the "Transmission enabled" NEST state.
- b) The EUT shall be set in the "Carrier on" radio state.
- c) A fault condition requiring the cessation of emission shall be generated either by the STE or directly on the EUT.
- d) It shall be verified that the EUT enters the "Emissions disabled" radio state as long as the fault condition persists.
- e) Steps a) through d) shall be repeated for each fault condition declared by applicant.

6.8 Identification of NEST and location determination

6.8.1 Test arrangement

The test shall be arranged such that EUT can determine its own location, or if external means are employed, the test shall be arranged so that the EUT can be located by the means declared by the applicant. The STE shall be arranged to simulate the NCF.

The position accuracy, precision, resolution and update rates shall be declared by the applicant for the NEST type and its application in question.

6.8.2 Test method

- a) The EUT shall be in the "Transmission enabled" state.
- b) The EUT shall report its location to the STE.
- c) The difference between the reported EUT location and actual location of the EUT (as simulated in the test) shall meet the requirements declared by the applicant.

6.9 Control and monitoring functions

6.9.1 General

For the purpose of these tests the EUT is the NEST either with, or without its antenna connected.

The applicant may modify an NEST for the purpose of these tests provided that full documentation is given to prove that the modifications accurately simulate the required test conditions.

The EUT shall transmit at $EIRP_{max}$.

The measurement of the EIRP spectral density shall be limited within either the nominated bandwidth or to a 10 MHz bandwidth centred on the carrier frequency, whichever is the greater.

6.9.2 Test arrangement

The EUT shall be authorized to transmit and shall be in the "Transmission enabled" state at the commencement of each test, unless otherwise stated. The time difference between the command, or failure, and the occurrence of the expected event (e.g. the transmission suppression) shall be measured and recorded.

6.9.3 Processor monitoring- Test method

- a) Each of the processors within the EUT shall, in turn, be caused to fail.
- b) Within 1 second of such failure the EUT shall cease to transmit.
- c) It shall be confirmed that the transmissions have been suppressed within the limits of the "Carrier-off" radio state emission levels.
- d) Within 30 seconds of such failure it shall be confirmed that the transmissions have been suppressed within the limits of the "Emissions disabled" radio state emission levels.
- e) The failed processor shall be restored to normal working condition and the EUT shall restore automatically to normal working before the next processor shall be induced to fail.

6.9.4 Transmit subsystem monitoring-Test method

- a) The frequency generation subsystem within the EUT shall be caused to fail in respect of:
 - loss of frequency lock (if applicable);
 - absence of local oscillator (LO) output signal;
 - Excess power.
- b) Recognition of each failure in turn by the subsystem monitor shall constitute an SMF event.
- c) Within 1 second of such failure the EUT shall cease to transmit.
- d) It shall be observed that the transmissions have been suppressed within the limits of the "Emissions disabled" radio state emission levels.
- e) The failed elements shall be restored to normal working state and the EUT shall be restored to normal working condition before the next induced failure.

6.9.5 Power-on/Reset-Test method

- a) The EUT shall be switched off and the STE shall not transmit the CC.
- b) The EUT shall be switched on.
- c) The EUT shall not transmit during and after switching-on, and shall enter the "Non valid" state.

If a manual reset function is implemented the following test shall be performed:

- d) The EUT shall be restored to the "Initial phase" state and the STE shall transmit the CC.
- e) The EUT shall remain in the "Initial phase" state.
- f) The reset function shall be initiated.
- g) The EUT shall enter the "Non valid" state.
- h) The EUT shall be restored to the "Initial phase" state and the STE shall transmit the CC as well as a TxE.
- i) The EUT shall enter the "Transmission enabled" state.
- j) The reset function shall be initiated.
- k) The EUT shall enter the "Non valid" state.

6.9.6 Control Channel and Response Channel -Test method

For the purposes of these test, the period without correct reception of the CC (T1) shall be as specified in clause 4.2.8.5.2.2.

These test procedures require simulation of the following events:

- The CC has never been received by the EUT after power-on.
 - The CC is lost by the EUT after reception of a Transmission Enable command.
 - The CC is lost by the EUT without reception of a Transmission Enable command.
 - The CC is being lost by the EUT and a call is initiated within the period T1.
- a) Case where the CC has never been received by the EUT after power-on:
 - a1) the EUT shall be switched off and the STE shall not transmit the CC;
 - a2) the EUT shall be switched on;

- a3) the EUT shall remain in the "Non valid" state.
- b) Case where the CC is lost by the EUT after reception of a Transmission Enable command:
 - b1) the EUT shall be switched-on and the STE shall transmit the CC and a Transmission Enable command;
 - b2) the EUT shall enter the "Initial phase" state and go, if applicable, to the "Transmission enabled" state;
 - b3) a transmission request shall be initiated from the EUT;
 - b4) the STE shall stop transmitting the CC;
 - b5) within the period T1 from event b4), the EUT shall enter the "Non valid" state.
- c) Case where the CC is lost by the EUT without reception of a Transmission Enable command:
 - c1) the EUT shall be switched on and the STE shall transmit the CC;
 - c2) the EUT shall enter the "Initial phase" state;
 - c3) the STE shall stop transmitting the CC;
 - c4) the EUT shall enter in the "Non valid" state not later than T1;
 - c5) a transmission request shall be initiated and the EUT shall remain in the "Non valid" state.
- d) Case where the CC is being lost by the EUT and a call is initiated within the T1 period:
 - d1) the EUT shall be switched on and the STE shall transmit the CC;
 - d2) the STE shall stop transmitting the CC;
 - d3) within the period T1 from d2), a transmission request shall be initiated from the EUT;
 - d4) the EUT may transmit but within the T1 period the EUT shall enter the "Non valid" state.

6.9.7 Network Control commands-Test method

The tests shall be performed in the following sequence:

- Transmission Enable command;
- Transmission Disable command received in the "Transmission enabled" state;
- Transmission Disable command received in the "Initial phase" state.
- a) Transmission Enable command:
 - a1) the EUT shall be switched-on and the STE shall transmit the CC;
 - a2) the EUT shall enter the "Initial phase" state;
 - a3) a transmission request shall be initiated from the EUT, the EUT shall remain in the "Initial phase" state;
 - a4) the STE shall transmit a transmit enable command to the EUT;
 - a5) a transmission request shall be initiated from the EUT;
 - a6) the EUT shall enter the "Transmission enabled" state and shall transmit.
- b) Transmission Disable command received in the "Transmission enabled" state:
 - b1) continue from a6);
 - b2) the STE shall transmit a disable command to the EUT;
 - b3) the EUT shall enter the "Transmission disabled" state within 1 second;

- b4) a transmission request shall be initiated from the EUT;
 - b5) the EUT shall remain in the "Transmission disabled" state;
 - b6) the STE shall transmit an enable command;
 - b7) the EUT shall enter either the "Transmission enabled" state or the "Initial phase" state;
 - b8) if the EUT is in the "Transmission enable" state then the test continues with b11);
 - b9) the STE shall transmit a TxE command;
 - b10) the EUT shall enter the "Transmission enable" state;
 - b11) if a transmission request is not active any more than a new transmission request shall be initiated;
 - b12) the EUT shall transmit;
 - b13) the EUT transmission shall be terminated.
- c) Transmission disable command received in the "Initial phase" state:
- c1) the EUT shall be switched-on and the STE shall transmit the CC;
 - c2) the EUT shall enter the "Initial phase" state;
 - c3) the STE shall transmit a Transmission Disable command to the EUT;
 - c4) the EUT shall enter the "Transmission disabled" state within 1 second;
 - c5) a transmission request shall be initiated from the EUT;
 - c6) the EUT shall remain in the "Transmission disabled" state;
 - c7) the STE shall transmit a Transmission Enable command;
 - c8) the EUT shall enter either the "Transmission enabled" state or the "Initial phase" state;
 - c9) if the EUT is in the "Transmission enable" state then the test continues with c12);
 - c10) the STE shall transmit a TxE command;
 - c11) the EUT shall enter the "Transmission enable" state;
 - c12) if a transmission request is not active any more than a new transmission request shall be initiated;
 - c13) the EUT shall transmit;
 - c14) the EUT transmission shall be terminated.

6.9.8 Initial burst transmission-Test method

The applicant shall declare the initial burst duration.

The following test shall be performed in sequence:

- a) the EUT shall be switched-off and the STE shall transmit the CC;
- b) the EUT shall be switched-on;
- c) the EUT shall not transmit, except the initial bursts;
- d) it shall be verified that the specifications given in clause 4.2.8.7.2 are fulfilled.

6.9.9 Inhibition of transmission-Test method

The applicant shall declare the values for IT_{max} and IT_{trans} , as specified in clauses 4.2.2.2 and 4.2.8.8.

The receive carrier to the EUT shall be removed:

- Within 1 second of such failure the EUT shall cease to transmit.
- It shall be observed that the EUT remains in the "Transmission enabled" state and that transmissions have been suppressed within the limits of the "Carrier off" radio state emission levels given in clause 4.2.3.2, table 3.
- The receive carrier to the EUT shall be restored within IT_{max} .
- It shall be observed that the EUT enters the "Carrier on" radio state and begins transmission within IT_{trans} .
- The receive carrier to the EUT shall be removed.
- It shall be observed that after IT_{max} the EUT enters the "Initial phase" state.

6.10 Antenna off-axis gain pattern

6.10.1 Test Method

6.10.1.1 Test site

This test shall be performed on either an outdoor far field test site or compact test range. However if the near field scanner technology to convert near field measurements to far field results is proven and sufficiently accurate by reference to tests taken in both regions then antenna measurements may be taken in the near field. Fully automated systems can be used for these tests providing that the results can be proven to be as accurate as if they were done according to the specified method.

6.10.1.2 Method of measurement for EUT antenna with linear polarization

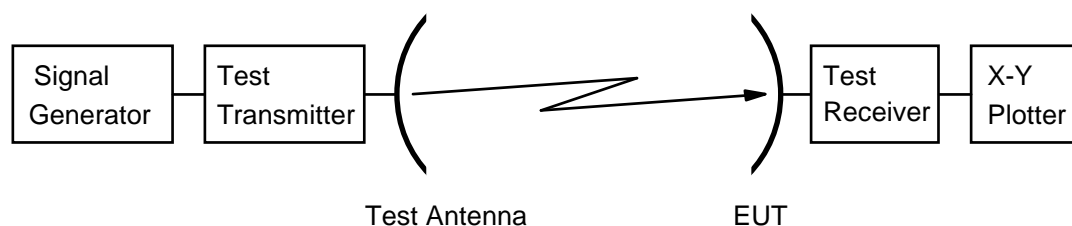

Figure 8: Test arrangement - antenna receive pattern measurement

- The test arrangement shall be as shown in figure 8 with the EUT connected to the test receiver. A linearly polarized test antenna shall be used.
- A signal proportional to the angular position from the servo mechanism shall be applied to the X-axis and the signal level from the test receiver shall be applied to the Y-axis of the plotter.
- The test frequencies shall be the centre frequency of each applicable frequency range. The E plane shall be vertical.
- The EUT shall be aligned to maximize the received signal level and the X-Y plotter shall be adjusted to give the maximum reading on the chart.
- The EUT shall be driven in azimuth through 180° .
- The pattern measurement is then obtained by driving the EUT in azimuth through 360° with the plotter recording the results.

- g) The tests in b) to e) shall be repeated with the frequency changed to the lower limit of the applicable band as declared by the manufacturer.
- h) The tests in b) to e) shall be repeated with the frequency changed to the upper limit of the applicable band as declared by the manufacturer.
- i) The tests in b) to h) shall be repeated with the frequencies changed to the others specified if the design of the equipment is such that operation is possible, but not necessarily simultaneously, in all bands.
- j) The tests in b) to h) shall be repeated with the test signal being transmitted in the H-plane instead of the E-plane.
- k) The tests in b) to h) shall be repeated with the test signal being transmitted in a plane at 45° to the H-plane.
- l) The tests in b) to h) shall be repeated with the test signal being transmitted in a plane at 90° to that in k).
- m) The tests in b) to l) shall be repeated between the angles of φ_r and 7° with the EUT rotated through 90°, or the test antenna or the polarization subsystem of the EUT rotated by 90°, to give the cross-polar measurement.

6.10.1.3 Method of measurement for antennas with circular polarization

- a) The test arrangement shall be as shown in figure 8 with the EUT connected to the test receiver. The sense of polarization for the test antenna and the antenna on the EUT shall be the same.
- b) A signal proportional to the angular position from the servo mechanism shall be applied to the X-axis and the signal level from the test receiver shall be applied to the Y-axis of the plotter.
- c) The test frequencies shall be the centre frequency of each applicable frequency range. A proper reference plane shall be selected and set vertical.
- d) The EUT shall be aligned to maximize the received signal level and the X-Y plotter shall be adjusted to give the maximum reading on the chart.
- e) The EUT shall be driven in azimuth through 180°.
- f) The pattern measurement is then obtained by driving the EUT in azimuth through 360° with the plotter recording the results.
- g) The tests in b) to e) shall be repeated with the frequency changed to the lower limit of the applicable band as declared by the manufacturer.
- h) The tests in b) to e) shall be repeated with the frequency changed to the upper limit of the applicable band as declared by the manufacturer.
- i) The tests in b) to h) shall be repeated with the frequencies changed to the others specified if the design of the equipment is such that operation is possible, but not necessarily simultaneously, in all bands.
- j) The tests in b) to h) shall be repeated with the test signal being transmitted in a plane perpendicular to the reference plane selected in c).
- k) The tests in b) to j) shall be repeated with the test antenna in different sense of circular polarization, to give the cross-polar measurement.

6.11 Blocking performance

6.11.1 Test method

- a) The output signals of two signal generators shall be combined with equal weight. The combined signal shall be coupled to the LNB input in a reasonable and appropriate way.
- b) A spectrum analyser shall be connected to the LNB output in a way that allows to supply the LNB with power.
- c) f_c is the center frequency of the receive frequency band.

- d) The first signal generator frequency shall be set to f_c .
- e) The first signal generator level shall be set to a level in the LNB operational input level range.
- f) The spectrum analyser shall be set for measuring the level of the converted first signal at the LNB output.
- g) The second signal generator frequency shall be set to $f_c - 20$ MHz.
- h) The second signal generator level shall be adjusted so that the measured level is 1 dB less than in absence of the second signal.
- i) The second signal generator level shall be noted down as reference level.
- j) The second signal generator frequency shall be set to the frequency of interest.
- k) The second signal generator level shall be adjusted so that the measured level is 1 dB less than in absence of the second signal.
- l) The rejection at the frequency of interest is equal to the second signal generator level minus the reference level determined in step i).
- m) Steps j) to l) shall be repeated for frequencies in the ranges of table 6.

NOTE: The worst case rejection in a particular frequency range can be determined after step i) by sweeping the second signal generator frequency over the frequency range and observe the gain compression, then perform steps j) to l) with the frequency where gain compression is highest.

6.12 Adjacent Signal Selectivity

For EUTs where the antenna may be removed, the test signal should be introduced into the antenna port. For integrated EUTs where it is not possible to remove the antenna, a radiated method shall be used and the method declared by the applicant.

6.12.1 Test method

- a) Two test signal generators shall be used. Each signal generator shall generate a modulated signal in the RF input frequency range and thermal noise.
- b) The test signal generators shall be set to the frequencies and levels according to table 7.
- c) The receiver shall be set to receive the signal of the first test signal generator.
- d) The second test signal generator shall be set to signal off.
- e) The noise level (or signal to noise ratio) of the first test signal generator shall be varied in order to determine the threshold reference sensitivity level.
- f) The second signal generator shall be set to signal on.
- g) The noise level (or signal to noise ratio) of the first test signal generator shall be varied in order to determine the threshold reference sensitivity level.
- h) The degradation is equal to the noise level (or signal to noise ratio) determined in step h minus that determined in step f).
- i) The result is the highest degradation found.

Annex A (informative): Relationship between the present document and the essential requirements of Directive 2014/53/EU

The present document has been prepared under the Commission's standardisation request C(2015) 5376 final [i.1] to provide one voluntary means of conforming to the essential requirements of Directive 2014/53/EU on the harmonisation of the laws of the Member States relating to the making available on the market of radio equipment and repealing Directive 1999/5/EC [i.8].

Once the present document is cited in the Official Journal of the European Union under that Directive, compliance with the normative clauses of the present document given in table A.1 confers, within the limits of the scope of the present document, a presumption of conformity with the corresponding essential requirements of that Directive and associated EFTA regulations.

Table A.1: Relationship between the present document and the essential requirements of Directive 2014/53/EU

Harmonised Standard ETSI EN 303 980				
Requirement			Requirement Conditionality	
No	Description	Reference: Clause No	U/C	Condition
1	EIRP density mask	4.2.1	U	
2	Antenna beam pointing	4.2.2	U	
3	Off axis spurious radiation	4.2.3	U	
4	On-axis spurious radiation	4.2.4	U	
5	Carrier suppression	4.2.5	U	
6	Cessation of emissions	4.2.6	U	
7	Identification of NEST and its location	4.2.7	U	
8	Control and Monitoring Functions (CMFs)	4.2.8	U	
9	Receive antenna off-axis gain pattern	4.2.9	C	Satellite communications networks may contain a central control unit that keeps received interference low by taking into account the actual antenna gain pattern of earth stations. The requirement is not relevant for earth stations that are always operated as part of such a network. The requirement is relevant in all other cases. If the receive antenna performance does not meet the requirement in clause 4.2.9, then the earth station will be subject to an additional co-frequency interference caused by its off-axis gain which is not compliant to the mask.
10	Blocking performance	4.2.10	U	
11	Adjacent Signal Selectivity	4.2.11	U	

Key to columns:

Requirement:

No A unique identifier for one row of the table which may be used to identify a requirement.

Description A textual reference to the requirement.

Clause Number Identification of clause(s) defining the requirement in the present document unless another document is referenced explicitly.

Requirement Conditionality:

U/C	Indicates whether the requirement is unconditionally applicable (U) or is conditional upon the manufacturer's claimed functionality of the equipment (C).
Condition	Explains the conditions when the requirement is or is not applicable for a requirement which is classified "conditional".

Presumption of conformity stays valid only as long as a reference to the present document is maintained in the list published in the Official Journal of the European Union. Users of the present document should consult frequently the latest list published in the Official Journal of the European Union.

Other Union legislation may be applicable to the product(s) falling within the scope of the present document.

Annex B (informative): Bibliography

- Council Directive 73/23/EEC of 19 February 1973 on the harmonization of the laws of Member States relating to Electrical Equipment designed for use within certain voltage limits (LV Directive).
- Council Directive 89/336/EEC of 3 May 1989 on the approximation of the laws of the Member States relating to electromagnetic compatibility (EMC Directive).
- Directive 2004/40/EC of the European Parliament and of the Council of 29 April 2004 on the minimum health and safety requirements regarding the exposure of workers to the risks arising from physical agents (electromagnetic fields) (18th individual Directive within the meaning of Article 16(1) of Directive 89/391/EEC).
- ETSI ETR 169 (1995): "Satellite Earth Stations and Systems (SES); Common Technical Regulations (CTRs) in the satellite earth station equipment field".
- CENELEC BS EN 60068: "Environmental testing. Test methods for vibration and shock".
- CENELEC EN 55022: "Limits and methods of measurement of radio disturbance characteristics of information technology equipment".
- SAE J1211: "Recommended Environmental Practices for Electronic Equipment Design, Recommended Practice".
- CEPT/ERC/Recommendation 74-01: "Unwanted emissions in the spurious domain".
- CENELEC EN 60529 (1991): "Degrees of protection provided by enclosures (IP code)".
- CENELEC EN 60068-2-6 (2008): "Environmental testing - Part 2-6: Test - Test Fc: Vibration (sinusoidal)".
- CENELEC EN 60068-2-11 (1999): "Environmental testing - Part 2-11: Tests - Test KA: Salt mist".
- CENELEC EN 60068-2-27 (2007): "Environmental testing - Part 2-27: Tests - Test Ea and guidance: Shock".
- ETSI TR 102 273 (all parts) (V1.2.1) (12-2001): "Electromagnetic compatibility and Radio spectrum Matters (ERM); Improvement on Radiated Methods of Measurement (using test site) and evaluation of the corresponding measurement uncertainties".
- Directive 1999/5/EC of the European Parliament and of the Council of 9 March 1999 on radio equipment and telecommunications terminal equipment and the mutual recognition of their conformity (R&TTE Directive).

Annex C (informative): Change history

Version	Information about changes
V1.1.1	First publication of the Harmonised Standard

History

Document history			
V1.1.0	March 2017	EN Approval Procedure	AP 20170625: 2017-03-27 to 2017-06-26