

Draft **ETSI EN 303 145** V1.1.5 (2015-07)



**Reconfigurable Radio Systems (RRS);
System Architecture and High Level Procedures for
Coordinated and Uncoordinated Use of TV White Spaces**

Reference

REN/RRS-0144

Keywords

architecture, GLDB, system, white space

ETSI

650 Route des Lucioles
F-06921 Sophia Antipolis Cedex - FRANCE

Tel.: +33 4 92 94 42 00 Fax: +33 4 93 65 47 16

Siret N° 348 623 562 00017 - NAF 742 C
Association à but non lucratif enregistrée à la
Sous-Préfecture de Grasse (06) N° 7803/88

Important notice

The present document can be downloaded from:
<http://www.etsi.org/standards-search>

The present document may be made available in electronic versions and/or in print. The content of any electronic and/or print versions of the present document shall not be modified without the prior written authorization of ETSI. In case of any existing or perceived difference in contents between such versions and/or in print, the only prevailing document is the print of the Portable Document Format (PDF) version kept on a specific network drive within ETSI Secretariat.

Users of the present document should be aware that the document may be subject to revision or change of status. Information on the current status of this and other ETSI documents is available at
<http://portal.etsi.org/tb/status/status.asp>

If you find errors in the present document, please send your comment to one of the following services:
<https://portal.etsi.org/People/CommitteeSupportStaff.aspx>

Copyright Notification

No part may be reproduced or utilized in any form or by any means, electronic or mechanical, including photocopying and microfilm except as authorized by written permission of ETSI.

The content of the PDF version shall not be modified without the written authorization of ETSI.
The copyright and the foregoing restriction extend to reproduction in all media.

© European Telecommunications Standards Institute 2015.
All rights reserved.

DECT™, **PLUGTESTS™**, **UMTS™** and the ETSI logo are Trade Marks of ETSI registered for the benefit of its Members.
3GPP™ and **LTE™** are Trade Marks of ETSI registered for the benefit of its Members and of the 3GPP Organizational Partners.
GSM® and the GSM logo are Trade Marks registered and owned by the GSM Association.

Contents

Intellectual Property Rights	6
Foreword.....	6
Modal verbs terminology.....	6
1 Scope	7
2 References	7
2.1 Normative references	7
2.2 Informative references.....	7
3 Definitions and abbreviations.....	8
3.1 Definitions.....	8
3.2 Abbreviations	8
4 Functional Architecture.....	9
4.1 Overview of Functional Architecture.....	9
4.2 Coordinated Usage of White Spaces	10
4.2.1 Spectrum coordination	10
4.2.1.1 Overview.....	10
4.2.1.2 Information service	10
4.2.1.3 Management service.....	10
4.2.2 High level operation sequence	10
4.3 Uncoordinated Usage of White Spaces	11
4.3.1 High level operation sequence.....	11
5 Detailed Functional Architecture	11
5.1 Architecture Description	11
5.2 Functional Description of Components.....	12
5.2.1 Database function	12
5.2.2 Geo-location function.....	12
5.2.3 Spectrum coordination function.....	13
5.2.4 Control function.....	14
5.2.5 Communication function	14
5.2.6 Interface function.....	14
5.3 Reference Points.....	15
5.3.1 Reference point A: Between a GLDB and a CRS.....	15
5.3.2 Reference point B: Between a CRS and a SC.....	16
5.3.3 Reference point C: Between SCs.....	16
5.3.4 Reference point D: Between a SC and a GLDB	17
5.4 Potential Interaction of Functionality within the spectrum coordination function	18
6 High Level Procedures	19
6.1 Procedures for Coordinated Access of White Spaces.....	19
6.1.1 Initialization procedures	19
6.1.2 Coordination service subscription procedures	19
6.1.2.1 Overview.....	19
6.1.2.2 CRS subscription procedure.....	19
6.1.2.3 CRS subscription update procedure	20
6.1.2.4 CRS subscription change procedure	21
6.1.3 Registration and authentication procedures	21
6.1.3.1 Overview.....	21
6.1.3.2 CRS registration procedure.....	22
6.1.3.3 CRS registration update procedure	22
6.1.3.4 Procedure for CRS deregistration from SC.....	23
6.1.3.5 SC authentication and registration procedure	23
6.1.3.6 SC de-authentication and de-registration procedure	24
6.1.4 Channel Access Procedures	25
6.1.4.1 Requesting CRS channel access procedure.....	25
6.1.4.2 Requesting SC channel access procedure	25
6.1.4.3 Providing available channel list procedure	26

6.1.4.4	Procedure of channel usage notification for subject CRS	27
6.1.4.5	Procedure for GLDB to SC Notification for CRS operational parameters update	27
6.1.4.6	CRS's operational parameters update request procedure from SC for incumbent protection	28
6.1.4.7	Basic Channel Access Sequence	30
6.1.4.8	Channel Access Sequence for Priority-Based Channel Assignment	31
6.1.5	Information exchange procedures	32
6.1.5.1	Providing coordination report procedure	32
6.1.6	Sensing and Measurement Procedures and Operation Sequences	33
6.1.6.1	Overview	33
6.1.6.2	Requesting measurements procedure	33
6.1.6.3	Providing periodic measurements procedure	33
6.1.6.4	Providing single measurements procedure	34
6.1.6.5	Non-Periodic measurements sequence	35
6.1.6.6	Event-Triggered Measurement Sequence	35
6.1.7	Reconfiguration Procedures and Operation Sequences	37
6.1.7.1	Reconfiguration request from SC to CRS procedure	37
6.1.7.2	Reconfiguration request from SC to GLDB procedure	38
6.1.7.3	General reconfiguration sequence between coordinated CRSs	38
6.1.7.4	CRS Request-Triggered Operational Parameter Reconfiguration	40
6.1.7.5	CRS-Measurement Triggered Priority-Based Operational Parameter Reconfiguration	43
6.1.7.6	General Priority-Based Channel Reconfiguration Sequence	45
6.1.7.7	Management of uncoordinated CRSs considering priority usage of coordinated CRSs	46
6.1.7.8	Priority Usage Request Considering Uncoordinated Channel Usage	47
6.1.7.8.1	Overview	47
6.1.7.8.2	Implementation Option A	47
6.1.7.8.3	Implementation Option B	49
6.1.7.9	Uncoordinated CRS Request Considering Priority Usage Coordinated CRS	53
6.1.7.9.1	Overview	53
6.1.7.9.2	Implementation Option A	54
6.1.7.9.3	Implementation Option B	54
6.1.7.10	Device parameter reconfiguration request from SC to CRS procedure	56
6.1.7.11	General sequence of device parameter reconfiguration request from SC to CRS for facilitating coexistence among CRSs	57
6.1.8	Inter-SC procedures	58
6.1.8.1	Reconfiguration request from master SC to CRS registered to slave SC procedure	58
6.1.8.2	Master/slave SC configuration procedure	59
6.1.8.3	Obtaining coordination set information from other SCs procedure	60
6.1.8.4	Procedures for interfering SCs discovery	61
6.1.8.4.1	Overview	61
6.1.8.4.2	GLDB-aided potential interfering SCs discovery procedure	61
6.1.8.4.3	Interfering SCs discovery procedure	62
6.1.8.5	Negotiation between SCs procedure	63
6.1.8.6	Operational Sequences for negotiation-based configuration of SCs	64
6.2	Procedures for Uncoordinated Access of White Spaces	65
7	Potential Implementation Architectures	65
7.1	High level flow chart of entities	65
7.1.1	CRS operation	65
7.1.1.1	General description	65
7.1.2	SC operation	69
7.1.2.1	General description	69
7.1.3	GLDB operation	74
7.1.3.1	General description	74
Annex A (informative):	High Level Spectrum Management Algorithms for White Spaces	77
A.1	Coexistence decision algorithms	77
A.1.1	Algorithm based on co-channel sharing via CRS network geometry classification	77
A.1.1.1	Introduction	77
A.1.1.2	Network geometry classification	77
A.1.1.3	Algorithm description	81
A.1.2	Control of spectrum utilization based on the number of CRSs	82
A.1.2.1	Introduction	82

A.1.2.2	Flowchart of the algorithm	83
A.1.3	Control of coordinated CRSs for reduced transmit power fluctuation	85
A.1.3.1	Introduction.....	85
A.1.3.2	Flowchart of the algorithm	85
A.1.4	Spectrum rearrangement among CRSs.....	86
A.1.4.1	Introduction.....	86
A.1.4.2	Flowchart of the algorithm	87
A.1.5	Resource allocation based on channel ranking.....	88
A.1.5.1	Introduction.....	88
A.1.5.2	Flowchart of the algorithm	89
A.2	Priority access management algorithms	90
A.2.1	Control of non-priority access CRSs for CRS with priority access.....	90
A.2.1.1	Introduction.....	90
A.2.1.2	Flowchart of the algorithm	91
Annex B (informative):	Possible Physical implementation examples of logical functions in	
	coordinated usage of white spaces.....	92
B.1	Possible Physical implementation examples	92
B.1.1	Third party database management.....	92
B.1.2	GLDB with spectrum coordination function	92
B.1.3	CRS with spectrum coordination function	93
B.1.4	Spectrum coordination for Multi-operators.....	94
History	95

Intellectual Property Rights

IPRs essential or potentially essential to the present document may have been declared to ETSI. The information pertaining to these essential IPRs, if any, is publicly available for **ETSI members and non-members**, and can be found in ETSI SR 000 314: "*Intellectual Property Rights (IPRs); Essential, or potentially Essential, IPRs notified to ETSI in respect of ETSI standards*", which is available from the ETSI Secretariat. Latest updates are available on the ETSI Web server (<http://ipr.etsi.org>).

Pursuant to the ETSI IPR Policy, no investigation, including IPR searches, has been carried out by ETSI. No guarantee can be given as to the existence of other IPRs not referenced in ETSI SR 000 314 (or the updates on the ETSI Web server) which are, or may be, or may become, essential to the present document.

Foreword

This draft European Standard (EN) has been produced by ETSI Technical Committee Reconfigurable Radio Systems (RRS), and is now submitted for the combined Public Enquiry and Vote phase of the ETSI standards EN Approval Procedure.

Proposed national transposition dates	
Date of latest announcement of this EN (doa):	3 months after ETSI publication
Date of latest publication of new National Standard or endorsement of this EN (dop/e):	6 months after doa
Date of withdrawal of any conflicting National Standard (dow):	6 months after doa

Modal verbs terminology

In the present document "**shall**", "**shall not**", "**should**", "**should not**", "**may**", "**need not**", "**will**", "**will not**", "**can**" and "**cannot**" are to be interpreted as described in clause 3.2 of the [ETSI Drafting Rules](#) (Verbal forms for the expression of provisions).

"**must**" and "**must not**" are **NOT** allowed in ETSI deliverables except when used in direct citation.

1 Scope

The present document defines the system architecture for the use of spectrum by White Space Devices (WSDs), specifically in the UHF TV Bands. The architecture stems from ETSI TS 102 946 [1]. The scope of the present document is to define the architecture of a system which can allow operation of WSDs based on information obtained from Geo-location databases. The architecture will consider both uncoordinated use of White Space (where there is no attempt to manage the usage of channels by different WSDs) as well as coordinated use of White Space (where some form of channel management and/or coexistence techniques are employed to efficiently use the White Space).

2 References

2.1 Normative references

References are either specific (identified by date of publication and/or edition number or version number) or non-specific. For specific references, only the cited version applies. For non-specific references, the latest version of the reference document (including any amendments) applies.

Referenced documents which are not found to be publicly available in the expected location might be found at <http://docbox.etsi.org/Reference>.

NOTE: While any hyperlinks included in this clause were valid at the time of publication, ETSI cannot guarantee their long term validity.

The following referenced documents are necessary for the application of the present document.

- [1] ETSI TS 102 946: "Reconfigurable Radio Systems (RRS); System requirements for Operation in UHF TV Band White Spaces".

2.2 Informative references

References are either specific (identified by date of publication and/or edition number or version number) or non-specific. For specific references, only the cited version applies. For non-specific references, the latest version of the reference document (including any amendments) applies.

NOTE: While any hyperlinks included in this clause were valid at the time of publication, ETSI cannot guarantee their long term validity.

The following referenced documents are not necessary for the application of the present document but they assist the user with regard to a particular subject area.

- [i.1] ETSI TR 103 067: "Reconfigurable Radio Systems (RRS); Feasibility study on Radio Frequency (RF) performance for Cognitive Radio Systems operating in UHF TV band White Spaces".
- [i.2] ECC Report 186: "Technical and operational requirements for the operation of white space devices under geo-location approach".
- [i.3] IEEE™ 802.22: "Cognitive Radio Wireless Regional Area Networks (WRAN) Medium Access Control (MAC) and Physical Layer (PHY) Specifications: Policies and Procedures for Operation in the Bands that Allow Spectrum Sharing where the Communications Devices may Opportunistically Operate in the Spectrum of the Primary Service".
- [i.4] IEEE™ 802.11: "Wireless LAN Medium Access Control (MAC) and Physical Layer (PHY) Specifications".
- [i.5] ETSI EN 301 598 (V1.1.1): "White Space Devices (WSD); Wireless Access Systems operating in the 470 MHz to 790 MHz TV broadcast band; Harmonized EN covering the essential requirements of article 3.2 of the R&TTE Directive".

3 Definitions and abbreviations

3.1 Definitions

For the purposes of the present document, the following terms and definitions apply:

coexistence: situation in which one radio system operates in an environment where another radio system having potentially different characteristics (e.g. RAT) may be using the same or different channels, and both radio systems are able to operate with some tolerable impact to each other

coordinated use of white spaces: case when each CRS uses available white space resources obtained with the help of the geo-location database and with additional knowledge of spectrum usage by its neighbour CRSs by the SC

NOTE: The case in which the SC assigns directly channels to the CRSs is also part of the coordinated use of white spaces.

coordination: ability of managing two or more CRSs to allow them to follow pre-determined operation policies such as coexistence among coordinated CRSs

coordination report: information to the CRS to make coordination decisions on its operational parameters in the information service

NOTE: This includes channel usage information, output power level, channel availability time, sensing information, as well as some initial ranking of the available channels.

coordination set: set of CRSs which may affect the performance of the CRS they are associated to

Geo-Location Database (GLDB): database approved by the relevant national regulatory authority which can communicate with WSDs and provide information on TVWS channel availability

NOTE 1: Information provided by a GLDB will include the available frequencies and associated maximum EIRP values that the WSD is permitted to use which allow for protection of the incumbent service and are derived from information provided by the WSD and the minimum required ACLR of the WSD.

NOTE 2: The GLDB consists of database and geo-location functions.

priority-based channel assignment: assignment of a channel by the SC to a CRS in such a way that the CRS can operate *alone* in such channel for a specific reservation period and in a specific area based on particular minimum protection requirements of the CRS

NOTE: CRSs assigned such channels with therefore have priority over other CRSs.

Spectrum Coordinator (SC): entity that coordinates spectrum usage of CRS based on the information obtained from geo-location database as well as supplemental spectrum usage data from different CRSs using its service

uncoordinated use of white spaces: case when each CRS independently uses available white space resources obtained with the help of the geo-location database without any help from the spectrum coordination function to coordinate spectrum usage with its neighbour CRSs

3.2 Abbreviations

For the purposes of the present document, the following abbreviations apply:

ACLR	Adjacent Channel Leakage Ratio
BC	Branch Condition
Com-SAP	Communication Service Access Point
CR	Cognitive Radio
CRS	Cognitive Radio System
C-SAP	Control Service Access Point
CSMA	Carrier Sense Multiple Access
DB-SAP	DataBase-Service Access Point
DS	Decision Status
DTV	Digital TV

EIRP	Effective Isotropic Radiated Power
GLDB	Geo-Location Database
GL-SAP	GeoLocation-Service Access Point
NAV	Network Allocation Vector
NRA	National Regulatory Authority
QoS	Quality of Service
RAT	Radio Access Technology
SAP	Service Access Point
SC	Spectrum Coordinator
SC-SAP	Spectrum Coordinator Service Access Point
SINR	Signal to Interference plus Noise Ratio
TV	TeleVision
TVWS	TV White Space
UHF	Ultra High Frequency
WSD	White Space Device

4 Functional Architecture

4.1 Overview of Functional Architecture

Figure 4.1 shows the high level functional architecture of a white space system. All the system requirements specified in ETSI TS 102 946 [1] shall be supported.

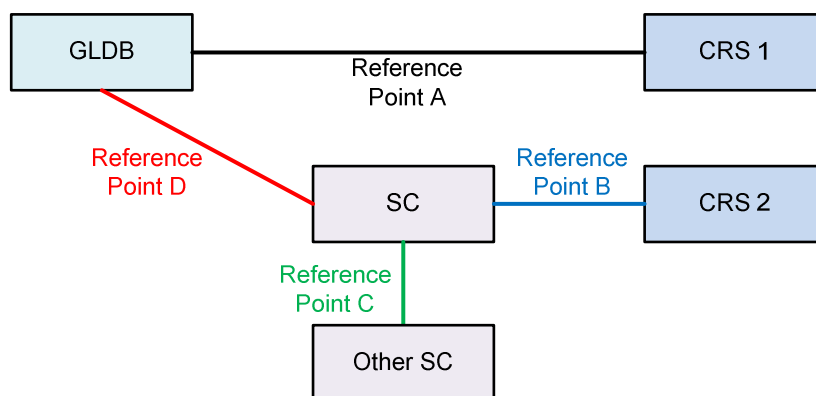

Figure 4.1: Overview of TV white spaces system

The TV white space system has three entities:

- Cognitive Radio System (CRS);
- Spectrum Coordinator (SC);
- Geolocation Database (GLDB);

and four reference points (A, B, C, and D), as shown in figure 4.1.

Each entity is defined by its functional roles and reference points with other entities.

The cognitive radio system (CRS) represents a white spaces device (WSD) or network of WSDs (i.e. a master WSD and some slave WSDs). The CRS uses available white space resources obtained with the help of geo-location database (GLDB) and/or with additional knowledge of spectrum usage by its neighbour CRSs provided by the spectrum coordinator (SC).

The GLDB provides a WSD in a CRS with location specific information on the available frequencies and associated maximum EIRP values that the WSD is permitted to use. This will allow for protection of the incumbent service and is derived from information provided by the WSD and the minimum required Adjacent Channel Leakage Ratio (ACLR) of the WSD itself.

The SC is responsible for coordinating spectrum usage of CRSs based on the information obtained from GLDB as well as additional spectrum usage data from different CRSs using its service. Different SCs are capable of communicating with each other.

The reference point A that is related to the uncoordinated usage of White Spaces is described in ETSI EN 301 598 [i.5].

4.2 Coordinated Usage of White Spaces

4.2.1 Spectrum coordination

4.2.1.1 Overview

Spectrum coordination is the mechanism with which an SC serves CRSs so that they can operate efficiently in available spectrum resources of white spaces. The SC coordinates how to manage radio resources among a set of CRSs that are potentially interfering with each other (coexistence) and allows for channel assignment requested by a CRS that wishes to operate alone on a channel and with priority over other CRSs (priority-based channel assignment). The priority-based channel assignment is managed by the SC based on some minimum protection requirements requested by the CRS, which includes minimum bandwidth, minimum SINR (or maximum allowable interference) and some guaranteed minimum availability time. The SC translates these requirements into protection criteria, which are used by the GLDB to ensure that the priority-based channel assignment is maintained in the presence of other WSDs not using the SC. The algorithms to enable coexistence and/or priority-based channel assignment are described in Annex A. From the perspective of the CRSs, coexistence and priority-based channel assignment are provided as a set of two available SC services: the information service (for coexistence only) and the management service (for both coexistence and priority-based channel assignment). Each SC shall provide at least the information service or the management service for CRSs but can also provide both of them. The information service and the management service are described in clauses 4.2.1.2 and 4.2.1.3.

4.2.1.2 Information service

For CRSs that are subscribed to the information service, an SC provides information about useful operational parameters (e.g. the operational parameters of other CRS in the available spectrum resources). In the information service, an SC does not make decision on the operational parameters to be used by those CRSs, but rather, all decisions are made by the CRS itself. However, the SC may process information about the current usage of spectrum to provide to the CRS in a manner which may facilitate the CRS decision (such as ranking the potential operational parameters according to the resulting expected performance).

4.2.1.3 Management service

For CRSs that are subscribed to the management service, a SC provides the operational parameters to be used by a CRS based on its requests and, potentially, certain QoS and usage time requirements. A CRS does not make any decision for its operational parameters (e.g. channel and transmit power) but they are determined by the SC itself.

4.2.2 High level operation sequence

An overview of coordinated usage of white spaces is shown in figure 4.2.

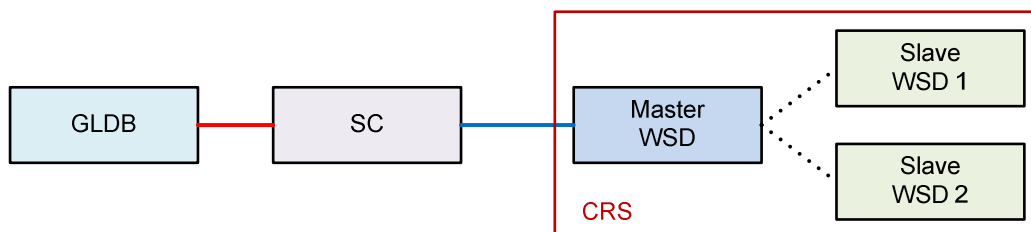

Figure 4.2: Overview of coordinated usage of white spaces system

A CRS consists of a master WSD and one or more slave WSDs. The master WSD sends device parameters to a GLDB via the SC. The SC shall act as relay and can also store the device parameters of the master WSD. The SC, during the process, maintains additional data about spectrum usage of the different CRSs using its service. This additional data contains information that reflects the current state of spectrum usage, including spectrum measurement data from WSDs, and usage maps or areas of occupancy of the different CRSs. It also contains parameters specific to the Radio Access Technology of each CRS that facilitates coexistence. A GLDB shall receive information from the master WSD about the characteristics of that WSD in order to generate operational parameters for that WSD. The GLDB provides specific operational parameters to the master WSD via the SC. During this process, the SC determines the operational parameters using the information obtained from the GLDB as well as the additional data about spectrum usage of the different CRSs, and sends these operational parameters to the master WSD in response to the request for white space access. The operational parameters determined by the SC shall not violate the protection criteria of the incumbent, and are therefore compliant with the information obtained from the GLDB. The master WSD then sends the selected channel usage parameter to the GLDB via the SC [i.2]. The SC will also update its additional spectrum usage data based on information sent by the WSD. At any time in the process of assigning channels to the CRSs, the SC could reconfigure the channel usage of the CRSs to ensure an efficient use of spectrum, such as reducing fragmentation in the available spectrum. The GLDB can use channel usage parameters sent by the SC to ensure that WSDs can operate in the presence of other WSDs not using the SC.

4.3 Uncoordinated Usage of White Spaces

4.3.1 High level operation sequence

An overview of uncoordinated usage of white spaces is shown in figure 4.3.

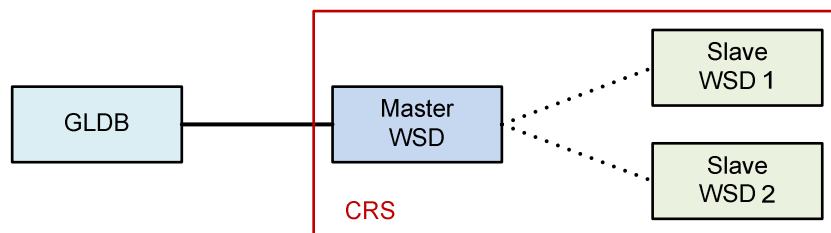

Figure 4.3: Overview of uncoordinated usage of white spaces system

A CRS consists of a master WSD and one or more slave WSDs. The master WSD shall communicate with a GLDB to obtain its operational parameters in white spaces. A GLDB shall receive information from a WSD about the characteristics of that WSD in order to generate operational parameter for that WSD. A GLDB shall maintain a record of the actual usage of the white spaces. This information could be used to enable WSDs to be readily identified if interference to incumbent users were to occur, and to allow the GLDB to know the extent to which available white spaces are being used.

5 Detailed Functional Architecture

5.1 Architecture Description

The overall system reference model is shown in figure 5.1.

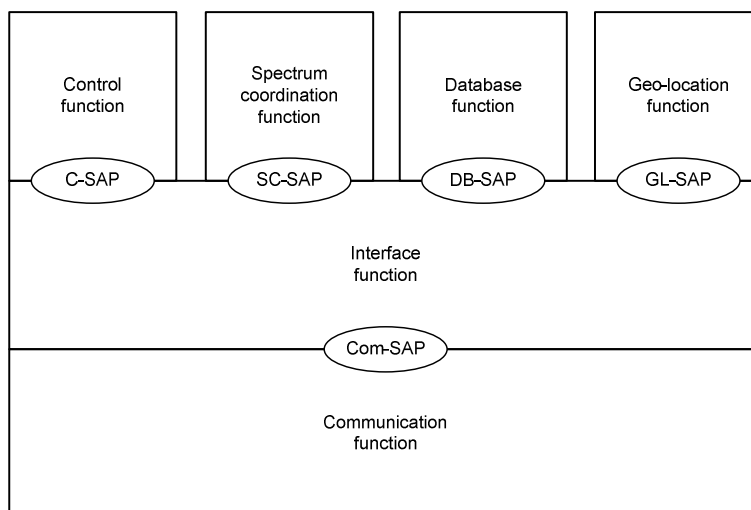

Figure 5.1: Overall system reference model

There are six logical functions for operating white space system: control function, spectrum coordination function, database function and geo-location function are the 4 key components for the system. Two additional functions (the interface function and the communication function) are general components for the system. Physical implementation examples of the overall system reference model are shown in annex B. Clause 5.2 describes in more detail the six identified logical functions.

5.2 Functional Description of Components

5.2.1 Database function

A database function is a software/hardware module that stores necessary information provided by regulators for calculating the available spectrum that a WSD in a CRS can operate on (with protection to incumbent services) as well as registration of the WSDs under regulatory requirements and for the purposes of protecting incumbent services. The reference model of database function is shown in figure 5.2.

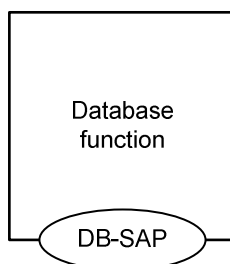

Figure 5.2: Reference model of a database function

The database function service access point (SAP) is the database SAP (DB-SAP). The DB-SAP is used by the interface function to access the services provided by the database function such as registration of CRS and provision of incumbent information.

5.2.2 Geo-location function

A geo-location function is a software/hardware module that supports the following functions:

- To calculate location specific available frequency band and associated maximum EIRP that a WSD in a CRS can use based on the information on incumbents stored in database function.
- To Interact with the SC for management of uncoordinated CRSs when considering priority usage coordinated CRSs.

The reference model of the geo-location function is shown in figure 5.3.

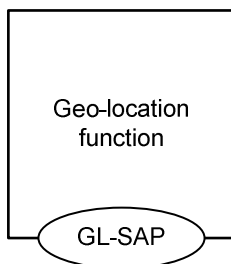

Figure 5.3: Reference model of a geo-location function

The geo-location function service access point (SAP) is the geo-location SAP (GL-SAP). GL-SAP is used by the interface function to access the services provided by the geo-location function such as calculation of location specific EIRP of a frequency band and that a WSD in a CRS can use.

5.2.3 Spectrum coordination function

A spectrum coordination function is a software/hardware module that coordinates spectrum usage of CRSs based on the information obtained from geo-location database and additional data about the spectrum usage of the different CRSs using the services of the SC. The reference model of spectrum coordination function is shown in figure 5.4. Depending on the implementation and location of the spectrum coordination function in the system (see annex B for examples) the spectrum coordination function will have one or more of the following functionalities:

Coexistence functionality: This functionality assures proper operation between different WSDs that utilize the white space, and avoidance of harmful interference between different CRSs using the same and/or adjacent channels.

Sensing and measurement functionality: The sensing functionality is responsible for the configuration of sensing in the CRS as well as the collection and combined processing of the sensing results and the measurements specific of the RAT that the CRS is using.

Priority-Based Channel assignment and negotiation functionality: This functionality allows certain CRSs or other spectrum coordination functions to assign channels and provides the necessary means for negotiation between different CRSs which may request a priority-based channel assignment for periods of time.

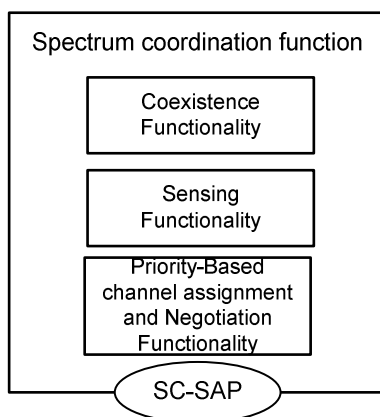

Figure 5.4: Reference model of spectrum coordination function

The spectrum coordination function service access point is the spectrum coordination SAP (SC-SAP). The coexistence functionality, sensing functionality, and priority usage and negotiation functionality all communicate with functions outside of the spectrum coordination function using the same SC-SAP. SC-SAP is used by the interface function to access the services provided by the spectrum function such as calculation of coordination parameters based on coexistence algorithms, priority-based channel assignment algorithms, etc. that a WSD in a CRS can use.

5.2.4 Control function

A control function is a hardware/software module that controls operation of a CRS in white space such as sending device parameters to GLDB/SC, receiving operational parameters from GLDB/SC, sending operational parameters and/or channel assignment to CRSs, sending channel usage parameters to GLDB/SC, sending requests to SC, and receiving responses from SC. The reference model of the control function is shown in figure 5.5.

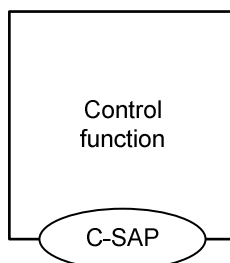

Figure 5.5: Reference model of spectrum coordination function

The control function service access point is the control SAP (C-SAP). C-SAP is used by applications to access information and parameters of GLDB and/or SC. It defines a set of generic primitives and data structures to control the CRSs and/or to obtain the information and parameters of GLDB and/or SC for application purposes. A CRS utilizing the C-SAP takes the role of an information consumer and of control application.

5.2.5 Communication function

A communication function is a hardware/software module that provides the communications protocol stack, and other communication services required by the interfaces between logical entities. The reference model of the communication function is shown in figure 5.6.

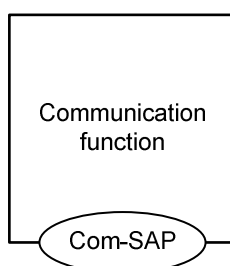

Figure 5.6: Reference model of a communication function

The communication function service access point is the communication SAP (Com-SAP). Com-SAP exchanges spectrum resources related information, device parameters, operational parameters, channel usage parameters and spectrum coordination related information between a communication function and an interface function. It abstracts communication mechanisms for use by reference points through defining a set of generic primitives and mapping these primitives to transport protocols.

5.2.6 Interface function

An interface function is an abstraction of the totality of those functional blocks realizing the reference points between a CRS and an SC, between an SC and a GLDB, between a CRS and a GLDB and between SCs. The reference model of the interface function is shown in figure 5.7.

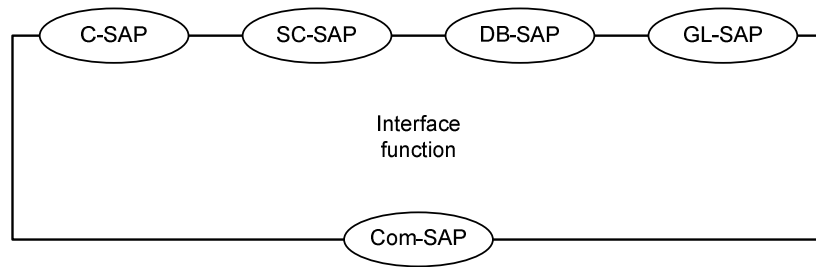

Figure 5.7: Reference model of an interface function

The interface function service access points are all the SAPs as in figure 5.7.

5.3 Reference Points

5.3.1 Reference point A: Between a GLDB and a CRS

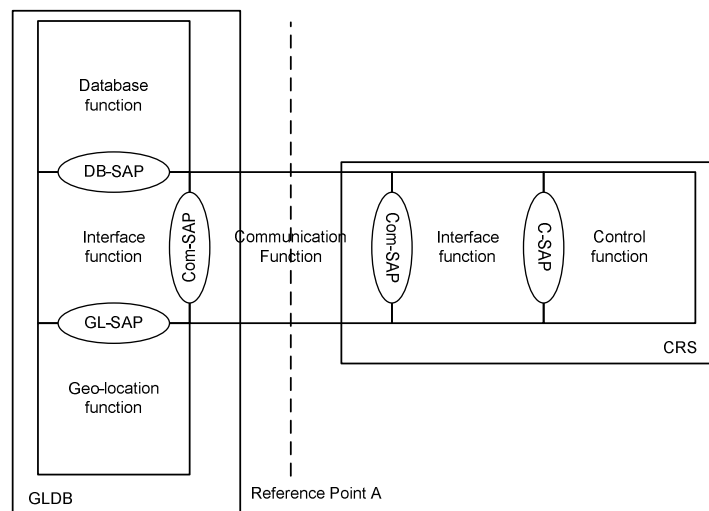

Figure 5.8: Reference point A

Reference point A is shown in figure 5.8.

Reference point A between a GLDB and a CRS is used to send the following from a CRS to a GLDB:

- CRS registration information;
- CRS device parameters;
- CRS channel usage parameters.

Reference point A between a GLDB and a CRS is used to send the following from a GLDB to a CRS:

- CRS operational parameters.

5.3.2 Reference point B: Between a CRS and a SC

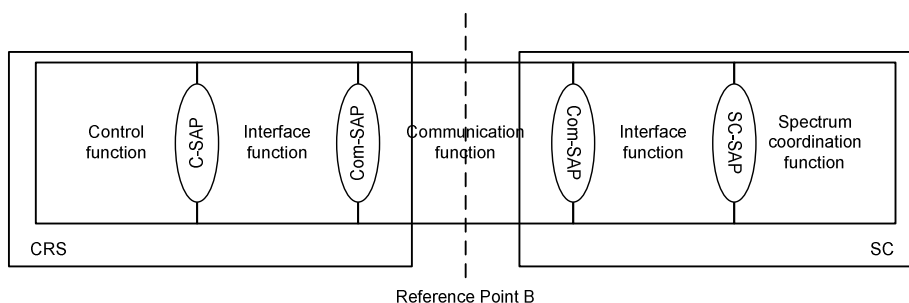

Figure 5.9: Reference point B

Reference point B is shown in figure 5.9.

Reference point B between a CRS and a SC is used to send the following from a CRS to a SC:

- CRS registration information.
- Sensing and/or Measurement results.
- Currently used RAT-specific parameters.
- Reconfiguration results (notification of spectrum use change).
- Coordination information requests.
- Priority-Based Channel assignment requests and associated parameters.
- Event indications.

Reference point B between a CRS and a SC is used to send the following from a SC to a CRS:

- Coordination information and spectrum resource usage information.
- Information requests.
- Sensing and/or Measurement requests.
- Reconfiguration requests.

5.3.3 Reference point C: Between SCs

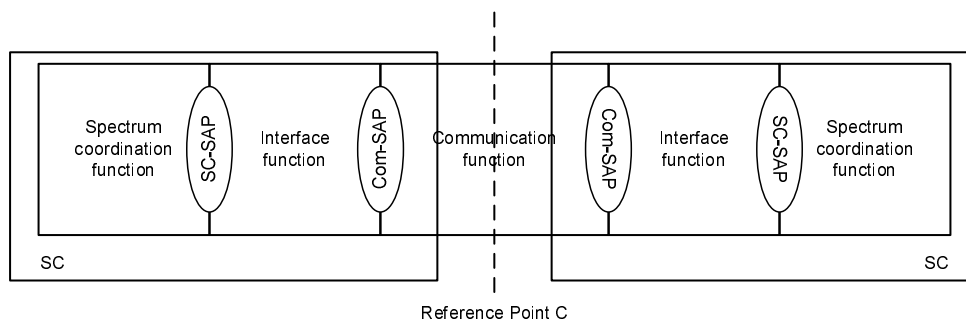

Figure 5.10: Reference point C

Reference point C is shown in figure 5.10.

Reference point C between SCs is a reference point and it is used to send the following:

- Information required for coordination between SCs.
- Information used for assistance in CRS operational parameter selection.
- Channel usage messages.
- Reconfiguration requests.
- SC negotiation messages.
- Messages for SC selection.

5.3.4 Reference point D: Between a SC and a GLDB

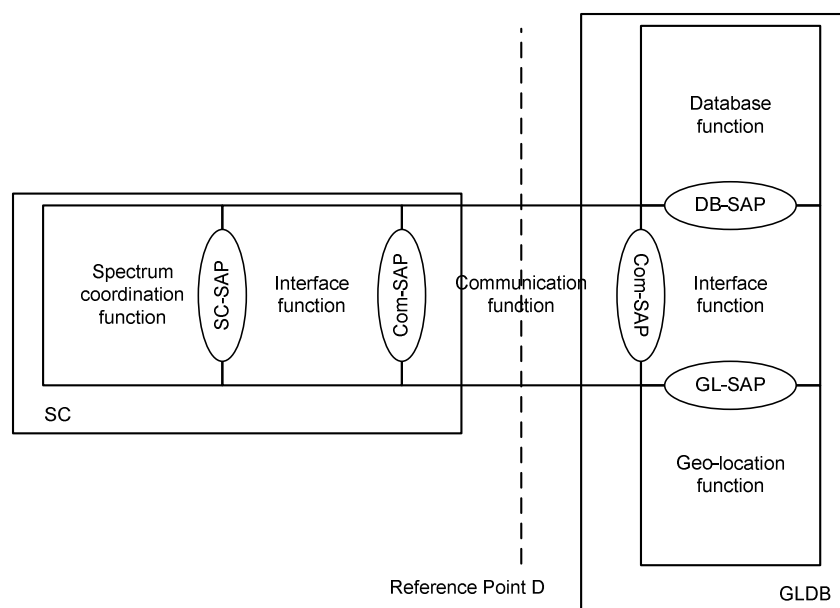

Figure 5.11: Reference point D

Reference point D is shown in figure 5.11.

Reference point D between a SC and a GLDB is used to send the following from a SC to a GLDB:

- Available spectrum resources requests.
- Request for the information required for output power level management.
- Request for channel assignment.
- Protection criteria of CRSs with priority-based channel assignment.

Reference point D between a SC and a GLDB is used to send the following from a GLDB to a SC:

- Available spectrum resources.
- Information required for output power level management.

5.4 Potential Interaction of Functionality within the spectrum coordination function

The SC has been described in clause 5.2.3. The identified SC functionalities can interact with each other through the reference points presented in the previous clause as described below.

Coexistence functionality: This functionality serves as the main engine in the spectrum coordination function. It uses the best-case operational parameters obtained from the GLDB (available channels and maximum power) and modifies these parameters to further allow different CRSs connected to the SC to operate (either on the same channel or adjacent channels) without harmful interference to each other. The coexistence functionality will collect the device parameters as well as additional RAT-specific information that is needed for coexistence from the WSD. Based on the current usage of the channels by the different WSDs, the coexistence function can request additional information to be obtained from the sensing function in order to make coexistence decisions.

Allowable reference point communications: The coexistence functionality interacts with GLDB through reference point D to obtain the allowable transmit power for a CRS (from the GLDB) in a manner similar to the communication through reference point A. It interacts through reference point B so that the CRS can request operational parameters (by providing its device parameters) to the SC. It can also provide supplemental information that allows the SC to ensure coexistence between different CRSs. CRSs are provided with one or more sets of operational parameters and coexistence information that allows them to be properly configured/reconfigured by the SC to operate in such a way as to coexist with other CRSs. This functionality also interacts with the same functionality in other SCs through reference point C for the same purpose.

Sensing and measurement functionality: The sensing and measurement functionality configures appropriate sensing in the WSDs in order to detect the presence of other WSDs or incumbents which may cause coexistence issues for the WSDs themselves. The sensing results and the specific measurements performed by the WSDs according to its RAT are collected by the sensing functionality and used by the coexistence functionality to further define the allowable channels and operational parameters for CRSs to ensure coexistence. Such sensing results and measurements are used by the SC for determining the presence of other CRSs (which may or may not be using the services of the SC) or interference from nearby incumbent services in the operating or adjacent channel which may affect the CRSs. Information from the sensing and measurement functionality can be used by the coexistence functionality to define the operational parameters of the CRSs or provide further information to the CRSs to ensure coexistence.

Allowable reference point communications: The sensing and measurement functionality interacts with the CRSs through reference point B to configure appropriate sensing and measurement to detect the presence of other WSDs or DTV systems and their operating power level. Such information is used by the coexistence function to provide further coexistence functionality (e.g. avoidance of interference from a DTV). It can also interact with the same functionality in other SCs through reference point C for the same purpose.

Priority-Based Channel Assignment and negotiation functionality: This functionality will allow the coordinated CRSs to reserve channels for priority access and provides all functionality related to negotiation between different CRSs that may request priority access for periods of time. It provides the necessary protection of systems requesting priority-based channel assignment to the GLDB (by interaction via reference point D), so that the GLDB can ensure the protection of such systems. It also collects and manages the requests for priority-based channel assignment from the CRSs, including authentication of users which are allowed to apply for priority-based channel assignment as well as negotiation for channel assignment. Such negotiation could include auctions managed by the SC, cost set through administration, or priority-based channel assignment to specific CRSs which are allowed to do so based on regulator policies.

Allowable reference point communications: The Priority-Based Channel Assignment and negotiation functionality interacts with the CRSs through reference point B to allow the CRSs to obtain priority access operational parameters from the SC and to exchange with the SC all information related to negotiation and authentication of users that are allowed to apply for priority usage. It will interact with the GLDB through reference point D in order for the SC and the GLDB to exchange information of priority access CRSs, so that protection of priority access CRSs can be ensured despite the presence of CRSs that access the GLDB through reference point A. Such communication will consist only of information of the priority usage CRSs, and not other coordinated information. Finally, it can also interact with the same functionality in other SCs through reference point C for the same purpose.

6 High Level Procedures

6.1 Procedures for Coordinated Access of White Spaces

6.1.1 Initialization procedures

A CRS shall perform the initialization procedure for the CRS to provide capability information to the SC whenever the CRS powers up or initiates communication with the SC. The capability information includes radio capability information (supported RAT, supported frequencies, supported data rates, and supported services), mobility description (fixed, slow-moving, fast moving), sensing and measurement capabilities (support of silent periods, measurement types, etc.), and RAT-specific capabilities (support of gaps for coexistence between CSMA and non-CSMA, effective control channel bandwidth reduction ability).

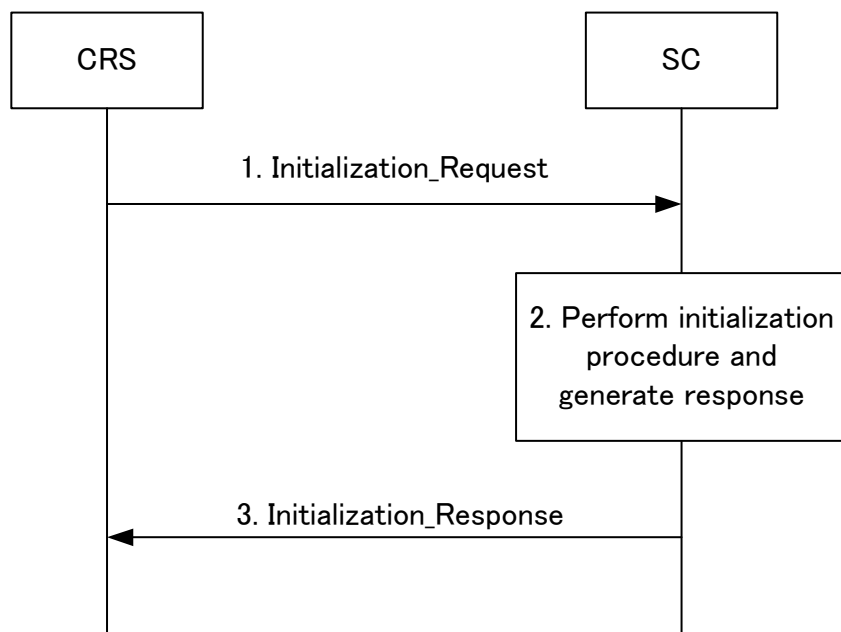

Figure 6.1: Initialization Procedure

The procedure is shown in figure 6.1 and shall be as follows:

- 1) When a CRS powers up or initiates communication with a SC, the CRS generates an Initialization_Request message and sends the Initialization_Request message to the SC which will serve this CRS.
- 2) After the SC has received the Initialization_Request message from the CRS, the SC performs the initialization, generates an Initialization_Response message and sends the Initialization_Response message to the CRS. The SC also stores all capability information for each CRS in its own local database/storage.
- 3) After the CRS has received the Initialization_Response message from the SC, the CRS processes the Initialization_Response message.

6.1.2 Coordination service subscription procedures

6.1.2.1 Overview

These procedures deal with aspects of CRS coordination service subscription of the entities as defined in the functional architecture.

6.1.2.2 CRS subscription procedure

A CRS shall perform the CRS subscription procedure when it needs to subscribe to the services of the SC. The CRS shall subscribe to either information service or management service.

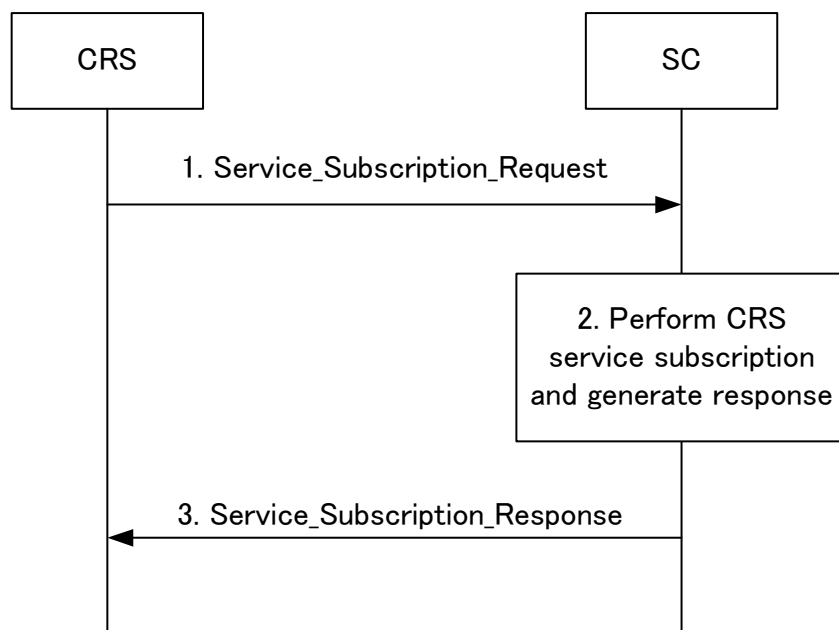

Figure 6.2: CRS Subscription Procedure

The procedure is shown in figure 6.2 and shall be as follows:

- 1) After a CRS has received a request to start operation, the CRS generates a Service_Subscription_Request message and sends the Service_Subscription_Request message to the SC which serves this CRS.
- 2) After the SC has received the Service_Subscription_Request message from the CRS, the SC performs CRS subscription and generates a Service_Subscription_Response message.
- 3) The SC sends the Service_Subscription_Response message to the CRS. After the CRS has received the Service_Subscription_Response message from the SC, the CRS processes the Service_Subscription_Response message.

6.1.2.3 CRS subscription update procedure

A CRS shall perform the CRS subscription update procedure when the CRS wants to change the type of coordination service provided by the SC or to stop its operation.

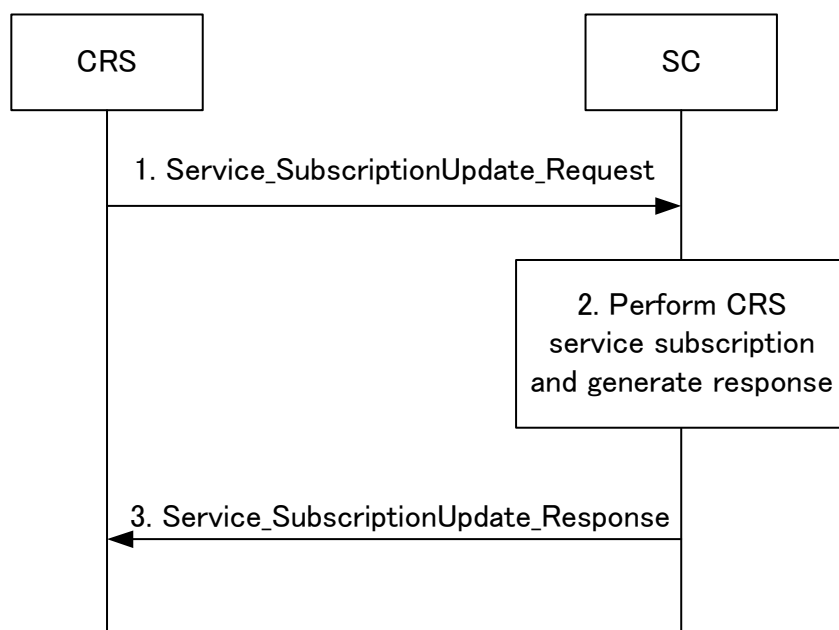

Figure 6.3: CRS Subscription Update Procedure

The procedure is shown in figure 6.3 and shall be as follows:

- 1) When a CRS wants to change the type of coordination service provided by the SC which serves this CRS or to stop its operation, the CRS generates a Service_SubscriptionUpdate_Request message and sends the Service_SubscriptionUpdate_Request message to the SC.
- 2) After the SC has received the Service_SubscriptionUpdate_Request message from the CRS, the SC performs the CRS subscription and generates a Service_SubscriptionUpdate_Response message.
- 3) The SC sends the Service_SubscriptionUpdate_Response message to the CRS. After the CRS has received the Service_SubscriptionUpdate_Response message from the SC, the CRS processes the Service_SubscriptionUpdate_Response message.

6.1.2.4 CRS subscription change procedure

A SC shall perform the CRS subscription change procedure when the SC wants to ask a CRS to change the type of coordination service provided by the SC.

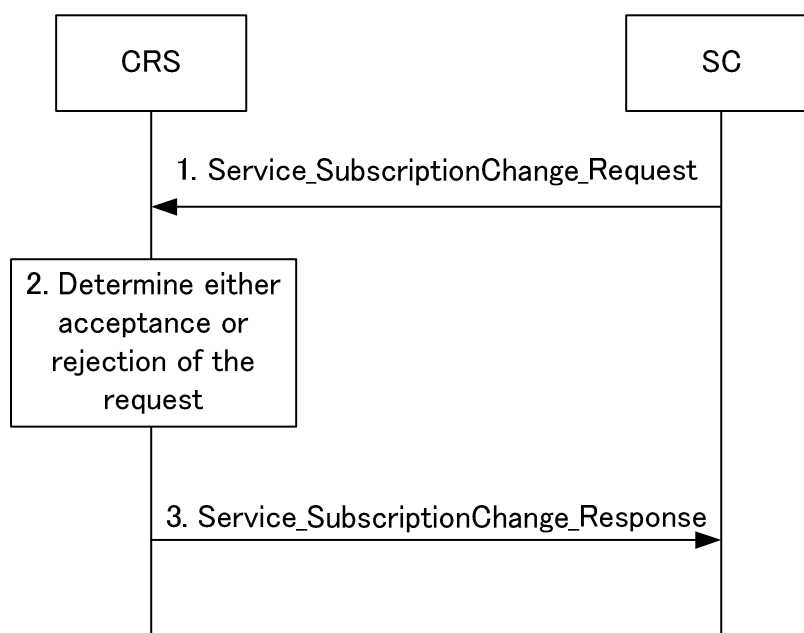

Figure 6.4: CRS Subscription Change Procedure

The procedure is shown in figure 6.4 and shall be as follows:

- 1) When a SC wants to ask the CRS which this SC serves to change the type of coordination service, the SC generates a Service_SubscriptionChange_Request message and sends the Service_SubscriptionChange_Request message to the CRS.
- 2) After the CRS has received the Service_SubscriptionChange_Request message from the SC, the CRS determines whether to accept or reject the request to change its subscription to the coordination service by the SC, generates a Service_SubscriptionChange_Response message and sends the Service_SubscriptionChange_Response message to the SC.
- 3) After the SC has received the Service_SubscriptionChange_Response message from the CRS, the SC processes the Service_Subscription_Response message.

6.1.3 Registration and authentication procedures

6.1.3.1 Overview

These procedures deal with aspects of registration and authentication of the entities as defined in the functional architecture. In order to use the services of the SC, a CRS shall first register with the SC. Likewise, an SC shall authenticate with a GLDB in order to make use of the advanced services provided by the GLDB.

6.1.3.2 CRS registration procedure

A CRS shall perform the CRS registration procedure when it has successfully finished the CRS subscription procedure.

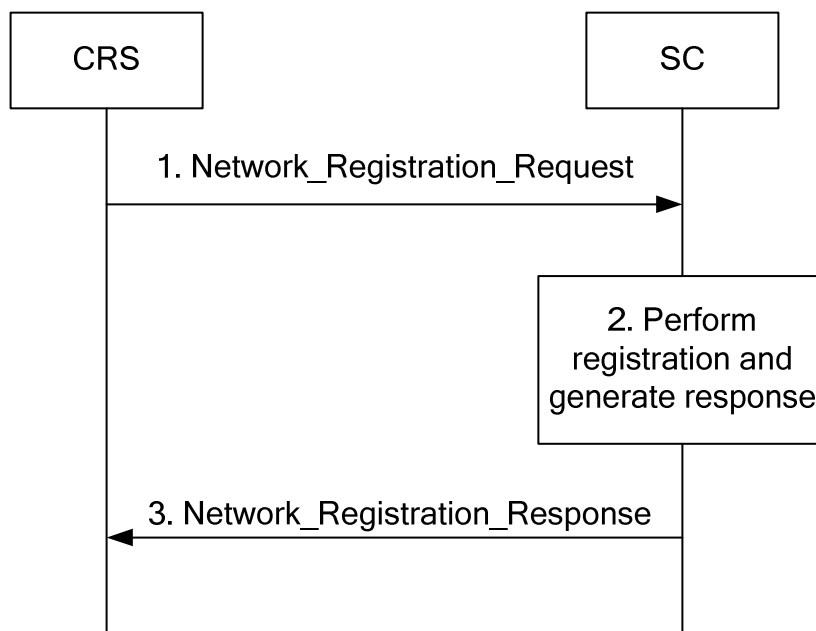

Figure 6.5: CRS Registration Procedure

The procedure is shown in figure 6.5 and shall be as follows:

- 1) When the CRS registers to the SC, the CRS generates a Network_Registration_Request message and sends it to the SC which serves the CRS.
- 2) After the SC has received the Network_Registration_Request message from the CRS, the SC performs registration and generates a Network_Registration_Response message.
- 3) The SC sends the Network_Registration_Response message to the CRS. After the CRS has received this message from the SC, the CRS processes it.

6.1.3.3 CRS registration update procedure

A CRS shall perform the CRS registration update procedure when it needs to change its registration information. The CRS may also use the update procedure to de-register from the SC.

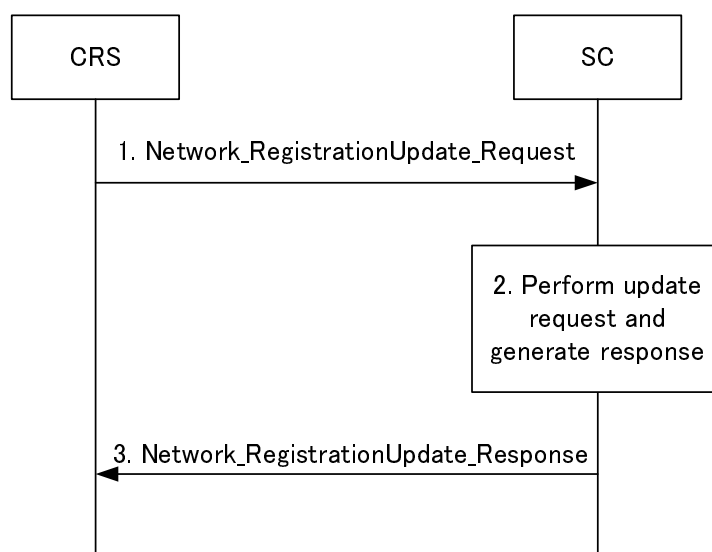

Figure 6.6: CRS Registration Update Procedure

The procedure is shown in figure 6.6 and shall be as follows:

- 1) After a CRS has received new CRS registration information, the CRS generates a Network_RegistrationUpdate_Request message and sends the Network_RegistrationUpdate_Request message to the SC.
- 2) After the SC has received the Network_RegistrationUpdate_Request message from the CRS, the SC performs the network registration update and generates a Network_RegistrationUpdate_Response message.
- 3) The SC sends the Network_RegistrationUpdate_Response message to the CRS. After the CRS has received the Network_RegistrationUpdate_Response message from the SC, the CRS processes the Network_RegistrationUpdate_Response message.

6.1.3.4 Procedure for CRS deregistration from SC

A SC shall perform the CRS deregistration procedure when the SC needs to deregister the CRS from the SC.

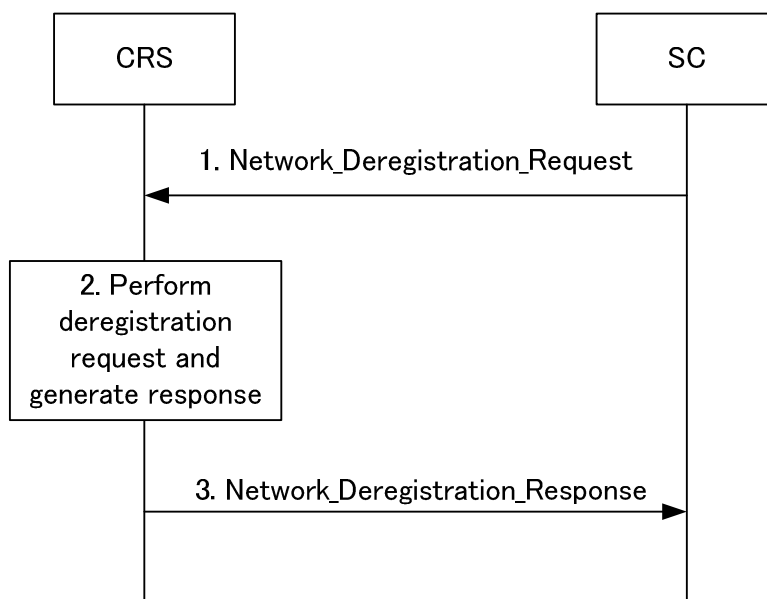

Figure 6.7: CRS De-Registration Procedure

The procedure is shown in figure 6.7 and shall be as follows:

- 1) When a SC wants to deregister the CRS served by this SC, the SC generates a Network_Deregistration_Request message and sends the Network_Deregistration_Request message to the CRS.
- 2) After the CRS has received the Network_Deregistration_Request message from the SC, the CRS performs the Network_Deregistration_Request message, generates a Network_Deregistration_Response message and sends the Network_Deregistration_Response message to the SC.
- 3) After the SC has received the Network_Deregistration_Response message from the CRS, the SC processes the Network_Deregistration_Response message.

6.1.3.5 SC authentication and registration procedure

A SC shall perform the SC authentication and registration procedure in order to register and authenticate to the GLDB. This allows the SC to obtain additional information on TVWS channels and to support use of channels with specific QoS guarantees. When registering to the GLDB, the SC first provides some rough information about the location of the users which it can support. This information can be used by the GLDB in later requests by the SC to supply channels that would be more appropriate to the SC, and serves for the SC to evaluate the amount of spectrum it can use to serve CRSs. This amount of spectrum is used by the SC to handle requests for priority-based channels and manage the spectrum for CRS requests.

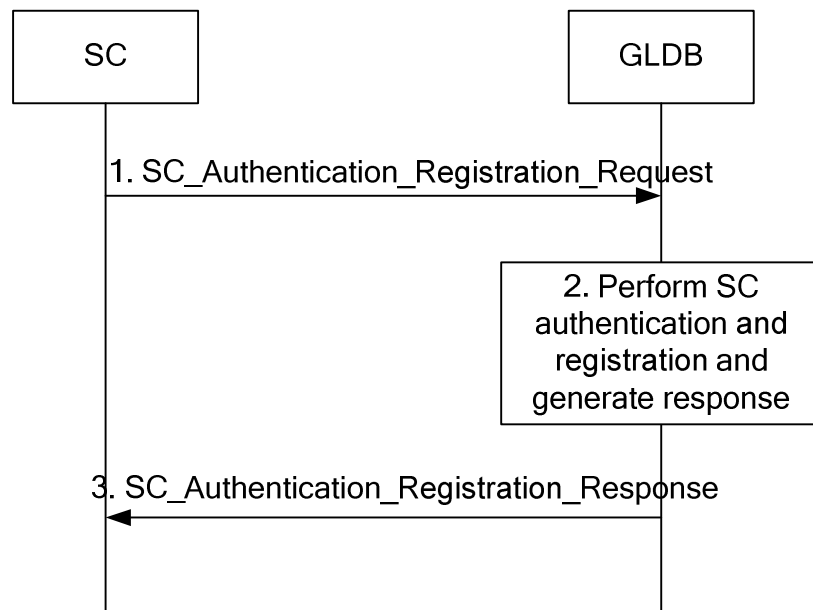

Figure 6.8: SC Authentication and Registration Procedure

The procedure is shown in figure 6.8 and shall be as follows:

- 1) Prior to obtaining spectrum for CRSs served by the SC, the SC will register with the GLDB and perform authentication. The SC generates a SC_Authentication_Registration_Request message and sends the SC_Authentication_Registration_Request message to the GLDB which includes rough location information.
- 2) After the GLDB has received the SC_Authentication_Registration_Request message from the SC, the GLDB performs authentication and registration of the SC, generates a SC_Authentication_Registration_Response message and sends the SC_Authentication_Registration_Response message to the SC, which includes rough availability information to the corresponding location.
- 3) After the SC has received the SC_Authentication_Registration_Response message from GLDB, the SC processes the SC_Authentication_Registration_Response message.

6.1.3.6 SC de-authentication and de-registration procedure

A SC shall perform the SC de-authentication and de-registration procedure when it needs to de-authenticate and de-register from the GLDB.

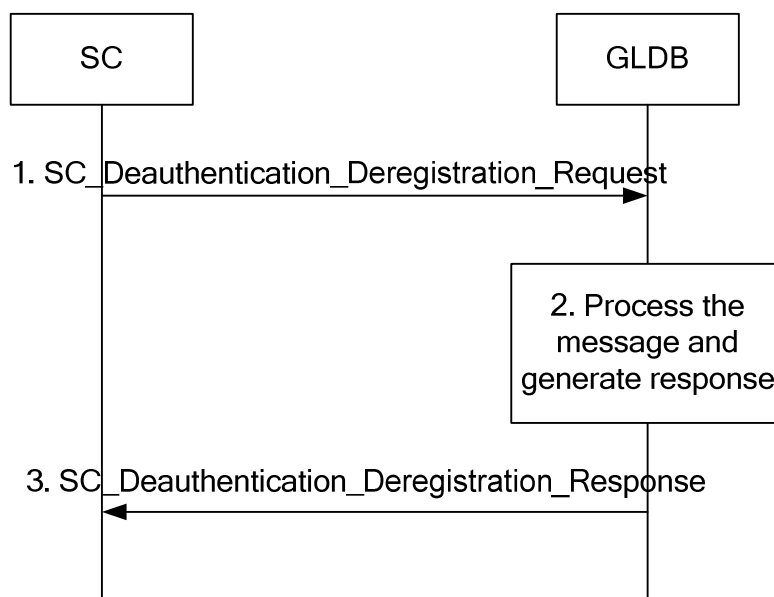

Figure 6.9: SC De-Authentication and De-Registration Procedure

The procedure is shown in figure 6.9 and shall be as follows:

- 1) Before the SC stops operation, the SC generates a SC_Deauthentication_Deregistration_Request message, and sends the SC_Deauthentication_Deregistration_Request message to the GLDB which serves this SC.
- 2) After the GLDB has received the SC_Deauthentication_Deregistration_Request message from the SC, the GLDB processes this message, generates a SC_Deauthentication_Deregistration_Response message, and sends the SC_Deauthentication_Deregistration_Response message to the SC.
- 3) After the SC has received the SC_Deauthentication_Deregistration_Response message from the GLDB, the SC processes this message.

6.1.4 Channel Access Procedures

6.1.4.1 Requesting CRS channel access procedure

A CRS shall perform the requesting CRS channel access procedure when the CRS wants to obtain the channel access information.

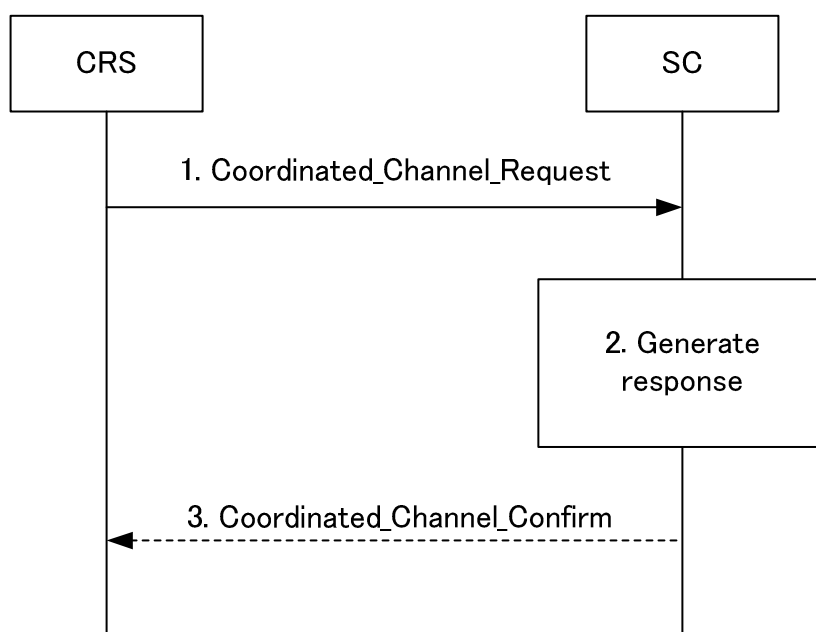

Figure 6.10: Requesting CRS Channel Access Procedure

The procedure is shown in figure 6.10 and shall be as follows:

- 1) When a CRS wants to obtain the channel access information, the CRS generates a Coordinated_Channel_Request message and send the Coordinated_Channel_Request message to the SC which serves this CRS.
- 2) After the SC has received the Coordinated_Channel_Request message from the CRS, the SC may generate a Coordinated_Channel_Confirm message.
- 3) In the case that the SC generates the channel confirm message, the SC sends the Coordinated_Channel_Confirm message to the CRS and the CRS processes the message.

6.1.4.2 Requesting SC channel access procedure

A SC shall perform the requesting SC channel access procedure when the SC wants to obtain the channel access information.

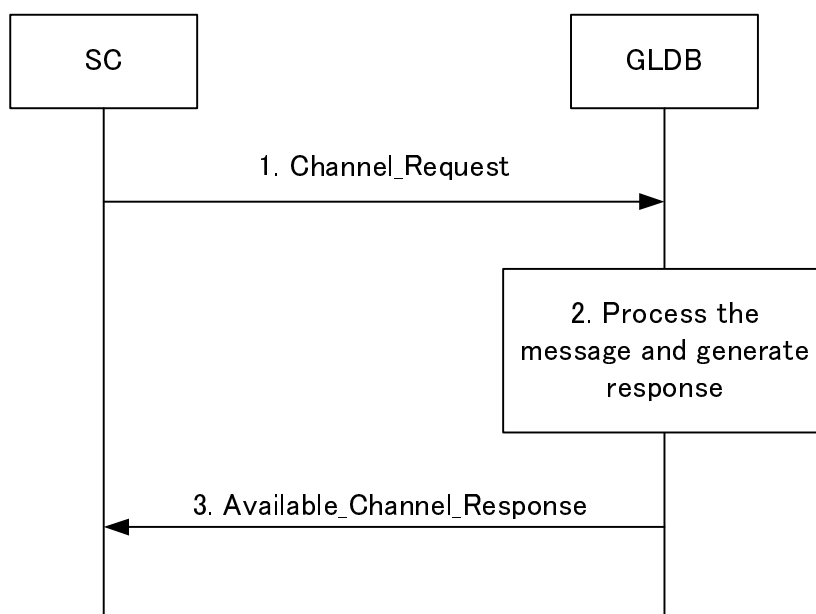

Figure 6.11: Requesting SC Channel Access Procedure

The procedure is shown in figure 6.11 and shall be as follows:

- 1) When the SC wants to obtain the channel access, it generates a Channel_Request message and sends the Channel_Request message to the GLDB which serves this SC.
- 2) After the GLDB has received the Channel_Request message from the SC, the GLDB processes the Channel_Request message, and generate an Available_Channel_Response message.
- 3) The GLDB sends the Available_Channel_Response message to the SC. After the SC has received the Available_Channel_Response message from the GLDB, the SC processes the Available_Channel_Response message.

6.1.4.3 Providing available channel list procedure

A SC shall perform the providing available channel list procedure when the SC wants to provide the available channel list for the CRS served by the SC.

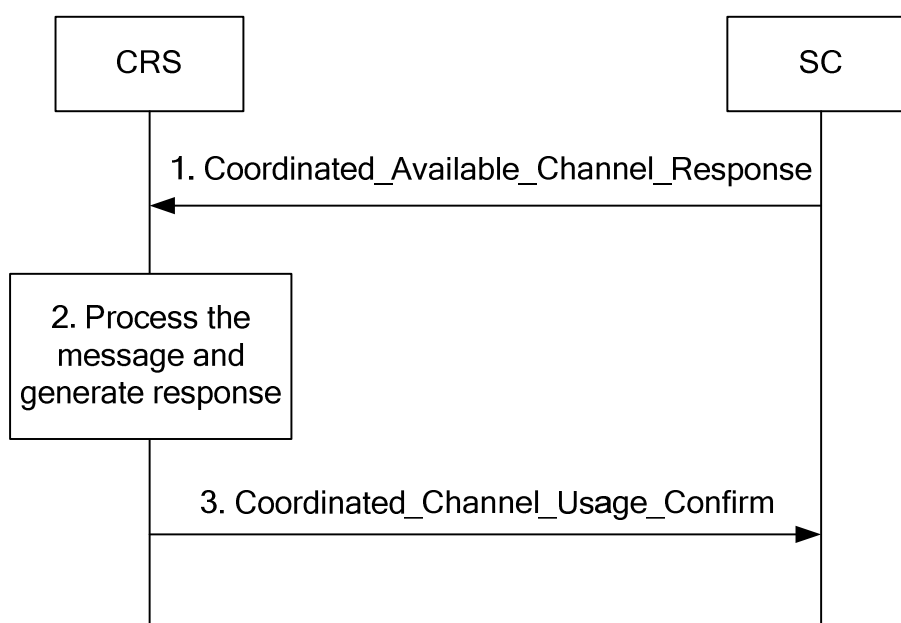

Figure 6.12: Providing Available Channel List Procedure

The procedure is shown in figure 6.12 and shall be as follows:

- 1) When a SC wants to provide the available channel list of the CRS served by the SC, the SC generates a Coordinated_Available_Channel_Response message and sends the Coordinated_Available_Channel_Response message to the CRS.
- 2) After the CRS has received the Coordinated_Available_Channel_Response message from the SC, the CRS processes the Coordinated_Available_Channel_Response message and generates a Coordinated_Channel_Usage_Confirm message.
- 3) The CRS sends the Coordinated_Channel_Usage_Confirm message to the SC. After the SC has received the Coordinated_Channel_Usage_Confirm message from the CRS, the SC processes the Coordinated_Channel_Usage_Confirm message.

6.1.4.4 Procedure of channel usage notification for subject CRS

A SC shall perform the procedure of channel usage notification for subject CRS when it has received channel usage parameters from the subject CRS.

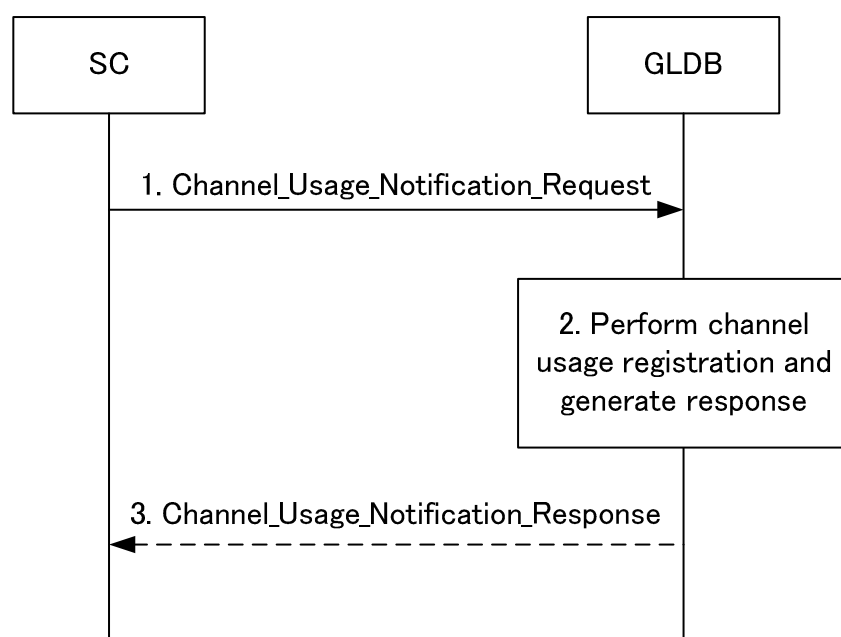

Figure 6.13: Channel Usage Notification for Subject CRS Procedure

The procedure is shown in figure 6.13 and shall be as follows:

- 1) After a SC has received channel usage parameters from the subject CRS served by the SC, the SC sends these channel usage parameters to the GLDB. The SC generates a Channel_Usage_Notification_Request message and sends the Channel_Usage_Notification_Request message to the GLDB.
- 2) After the GLDB has received the Channel_Usage_Notification_Request message from the SC, the GLDB performs channel usage notification for the subject CRS. The CRS may also generate a Channel_Usage_Notification_Response message and may send the Channel_Usage_Notification_Response message to the SC.
- 3) In the case that the GLDB generates the Channel_Usage_Notification_Response message, the SC processes it.

6.1.4.5 Procedure for GLDB to SC Notification for CRS operational parameters update

A GLDB shall perform the procedure for GLDB to SC notification for CRS operational parameters update when CRS operational parameters have been updated by the GLDB. For example, when the incumbent spectrum occupancy is changed unexpectedly, the GLDB needs to inform the SC of such changes.

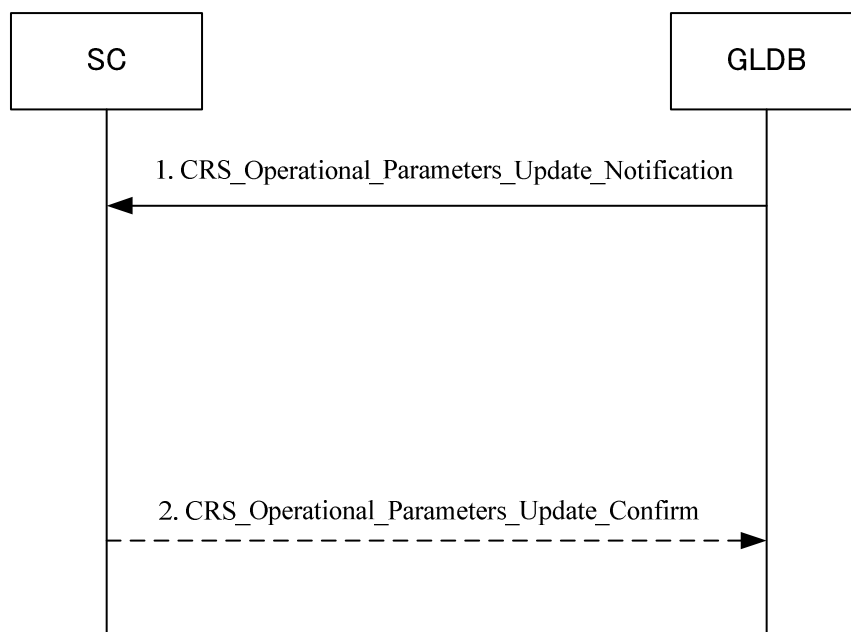

Figure 6.14: Procedure for GLDB to SC notification for CRS operational parameters update

The procedure is shown in figure 6.14 and shall be as follows:

- 1) When the GLDB needs to inform the CRSs' of changes in their operational parameters, the GLDB generates a `CRS_Operational_Parameters_Update_Notification` message, and sends the `CRS_Operational_Parameters_Update_Notification` message to the SC.
- 2) After the SC has received the `CRS_Operational_Parameters_Update_Notification` message from the GLDB, the SC processes this message, may generate a `CRS_Operational_Parameters_Update_Confirm` message, and may send the `CRS_Operational_Parameters_Update_Confirm` message to the GLDB.

6.1.4.6 CRS's operational parameters update request procedure from SC for incumbent protection

Following clause 6.1.4.5, when the SC receives the `CRS_Operational_Parameters_Update_Notification` message from the GLDB, it shall generate a `CRS_Operational_Parameters_Update_Request` message, and sends it to the specific CRS for response.

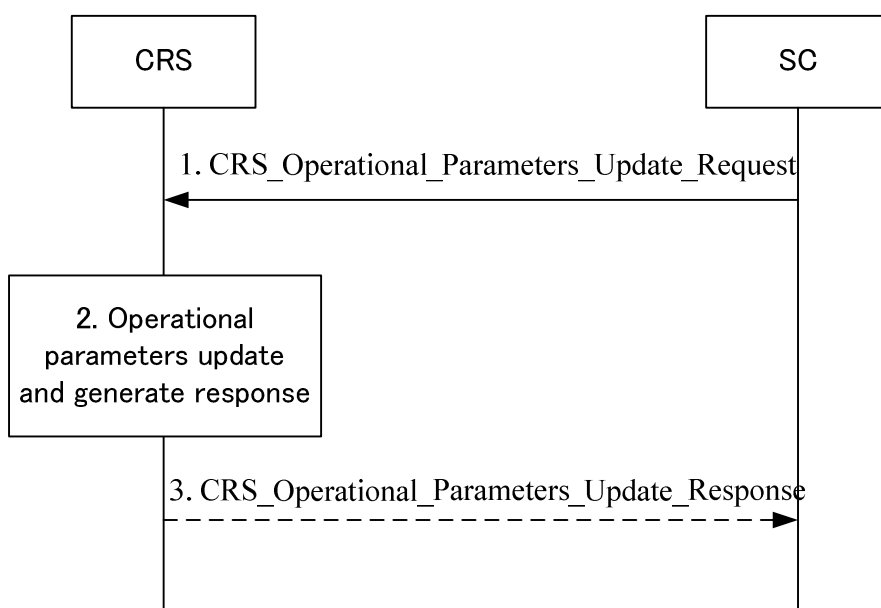

Figure 6.15: CRSs' operational parameters update request procedure from SC for incumbent protection

The procedure is shown in figure 6.15 and shall be as follows:

- 1) When the SC receives the `CRS_Operational_Parameters_Update_Request` message sent from the GLDB, it generates the `CRS_Operational_Parameters_Update_Request` message, and sends it to the specific CRS.
- 2) When the CRS receives the `CRS_Operational_Parameters_Update_Request` message, it may generate a `CRS_Operational_Parameters_Update_Response` message for acknowledgement to the SC. Alternatively, the CRS may perform the requesting CRS channel access procedure afterwards.
- 3) In the case that the CRS generates the `CRS_Operational_Parameters_Update_Response` message, it sends the `CRS_Operational_Parameters_Update_Response` message to the SC.

NOTE: In the above procedure, the SC just performs as a relay to pass the notification of the operational parameter update request from GLDB to the specific CRS; in another case, the SC could perform the "reconfiguration request from SC to CRS procedure" directly after clause 6.1.4.5.

6.1.4.7 Basic Channel Access Sequence

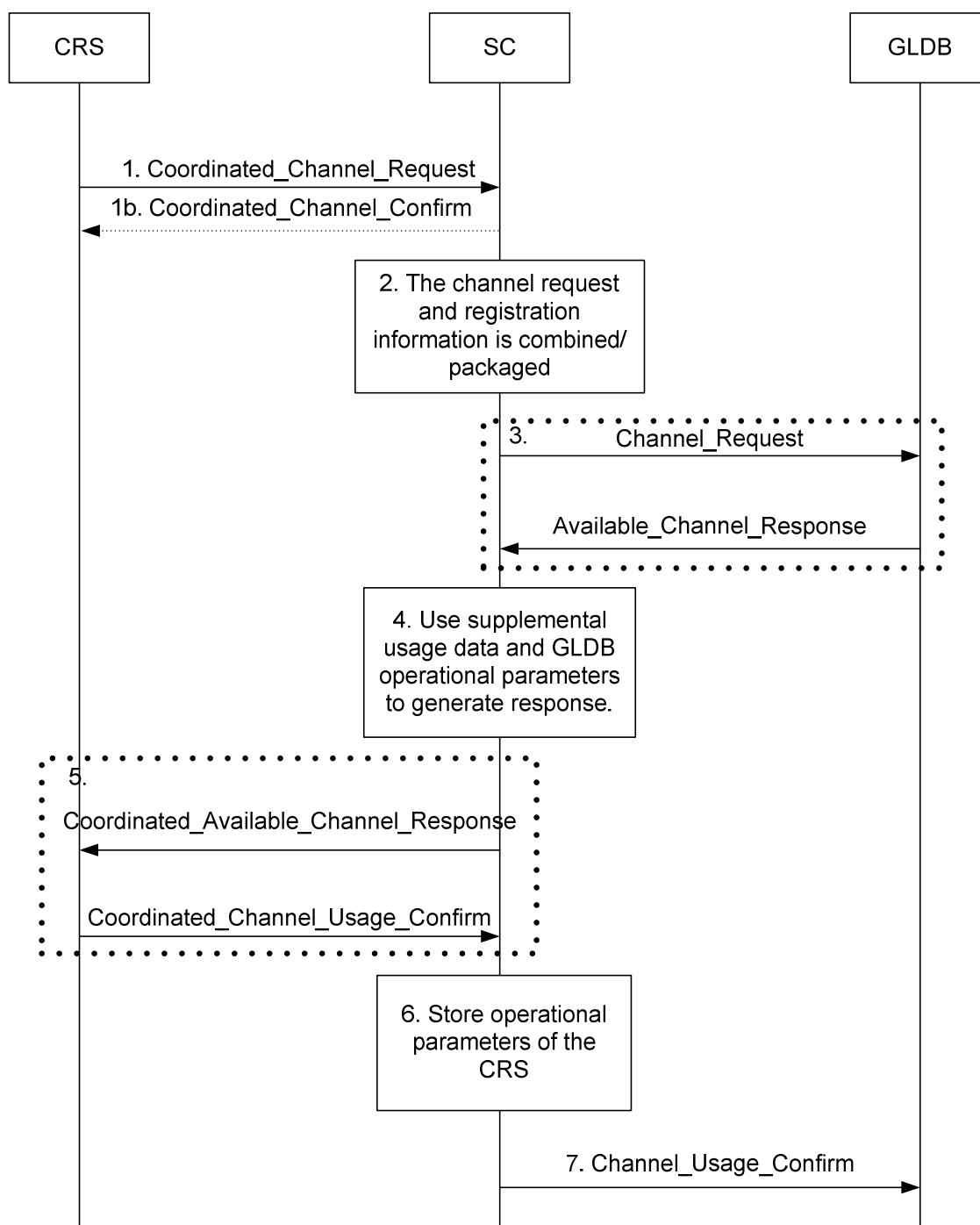

Figure 6.16: Basic Channel Access Sequence

The procedure is shown in figure 6.16 and shall be as follows:

- 1) The CRS makes a channel request to the SC. The request will contain the userID, device parameters, and basic requirements for the usage parameters (amount of spectrum, transmit power, antenna locations/coverage area). The SC may optionally confirm the reception of the message (1b).
- 2) The SC uses information from the channel request and registration information to create a request or set of suitable requests to the GLDB.
- 3) The SC makes a channel request to the GLDB using the device parameters of the CRS. The GLDB provides the possible operational parameters (available channels, corresponding power, etc.) for the CRS to the SC.

- 4) In the case of the information service, the SC adds the usage information of other systems which may cause coexistence issues to the information in the channel response as supplemental information. In the case of the management service, the SC assigns specific operational parameters for the CRS based on the supplemental channel usage information.
- 5) The SC sends the possible operational parameters and supplemental information to the CRS. In the case of the information service, the possible operational parameters are sent as a list ranked in terms of the expected quality if the CRS requests this initially. The CRS selects suitable usage parameters and sends them to the SC.
- 6) The SC stores the selected usage parameters of the CRS in order to use them for future coexistence decisions.
- 7) The SC confirms the selected channel usage parameters of the CRS to the GLDB.

6.1.4.8 Channel Access Sequence for Priority-Based Channel Assignment

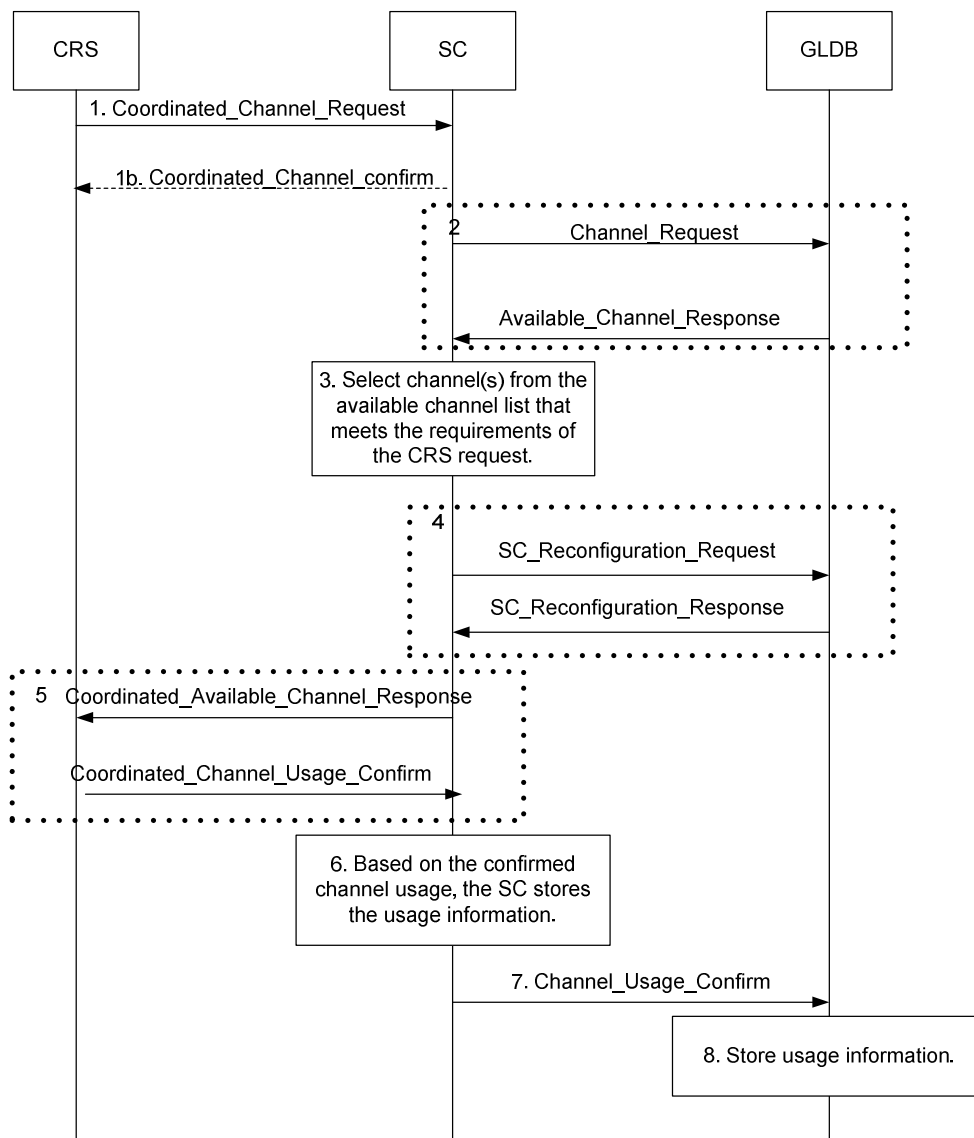

Figure 6.17: Channel Access Sequence for Priority-Based Channel Assignment

The procedure is shown in figure 6.17 and shall be as follows:

- 1) The CRS makes a channel request to the SC for priority-based channel assignment. The request will contain the basic device parameters of the CRS and specific performance requirements for the CRS (e.g. required availability time, max interference level, or quality of service during that time). The SC will optionally confirm reception of the message (1b).

- 2) The SC sends a request for channels to the GLDB. The GLDB will determine the available channels that can be assigned to the CRS while taking into account the protection of the incumbent. The GLDB provides the possible operational parameters (available channels, corresponding power, etc.) for the CRS to the SC.
- 3) The SC selects the resources from the Available_Channel_List message which meets the requirements of the CRS request, based on the channel usage information of other CRSs registered to the SC.
- 4) The SC sends the CRS device parameters and the protection criteria of the priority usage CRS derived from the CRS performance requirements (e.g. required time utilization, maximum interference) to the GLDB.
- 5) The SC sends the channel usage parameters for the CRS in the channel assignment message. The CRS confirms whether it agrees to use the specified channel usage parameters.
- 6) Based on the confirmed channel usage, the SC stores the usage information, considering that this usage corresponds to priority-based channel usage.
- 7) The SC sends the channel usage parameters of the CRS to the GLDB.
- 8) The GLDB stores the protection criteria and the selected usage parameters of the CRS. These protection criteria are treated by the GLDB as though they were incumbent protection data for the period of time in which the CRS has been given the priority-based channel assignment.

6.1.5 Information exchange procedures

6.1.5.1 Providing coordination report procedure

A SC shall perform the providing coordination report procedure when the coordination information has been changed for one or several CRSs subscribed to the information service and served by this SC.

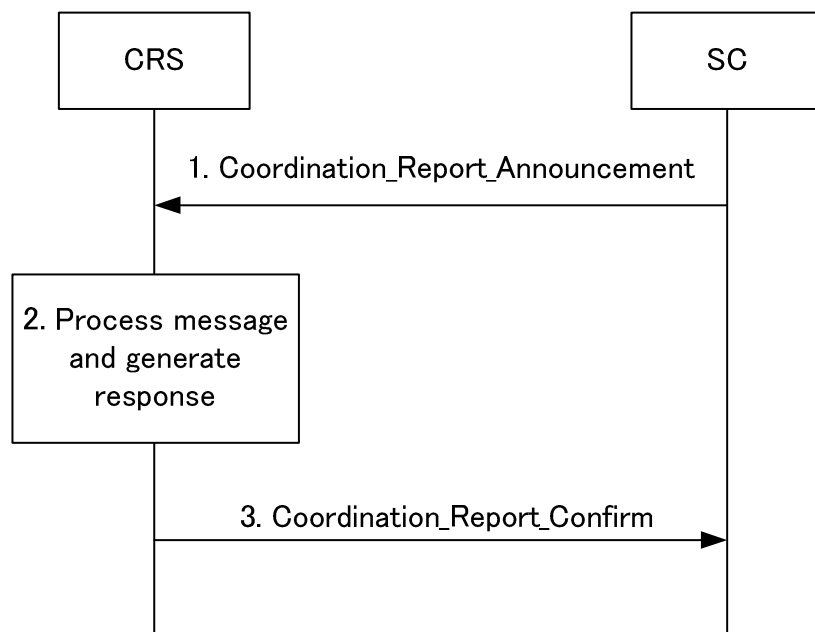

Figure 6.18: Providing Coordination Report Procedure

The procedure is shown in figure 6.18 and shall be as follows:

- 1) When the coordination information has been changed for one or several CRSs subscribed to the information service and served by a SC, the SC generates one or several Coordination_Report_Announcement messages. The number of the generated Coordination_Report_Announcement messages is equal to the number of the CRSs for which coordination information has changed. After the Coordination_Report_Announcement message has been generated, the SC sends the Coordination_Report_Announcement messages to the CRSs for which the coordination information has changed.

- 2) After the CRS has received the Coordination_Report_Announcement message from the SC, the CRS processes the Coordination_Report_Announcement message, generates a Coordination_Report_Confirm message and sends the Coordination_Report_Confirm message to the SC.
- 3) After the SC has received the Coordination_Report_Confirm message from the CRS, the SC processes the Coordination_Report_Confirm message.

6.1.6 Sensing and Measurement Procedures and Operation Sequences

6.1.6.1 Overview

The SC can configure sensing and measurements in the CRS in order to aid the SC to ensure coexistence between different CRSs, as well as to ensure a CRS can coexist despite interference from incumbents (e.g. adjacent channel interference from a strong DTV broadcast in TVWS). Sensing would consist of specific algorithms which are used for detection of other devices or systems utilizing the TVWS. In addition to sensing, the SC can obtain technology-specific measurements from a CRS and use them for coexistence decisions. Such measurements are those defined by the technology of that CRS.

In clauses 6.1.6.2 to 6.1.6.6, unless specified, the term "measurements" is used to refer both to sensing and to technology-specific measurements.

6.1.6.2 Requesting measurements procedure

An SC shall perform the requesting measurements procedure to request the CRS served by this SC to perform measurements and to request the CRS to provide measurement reports. The SC requests the CRS to perform measurements and the CRS to provide measurement reports either once per request or on scheduled basis.

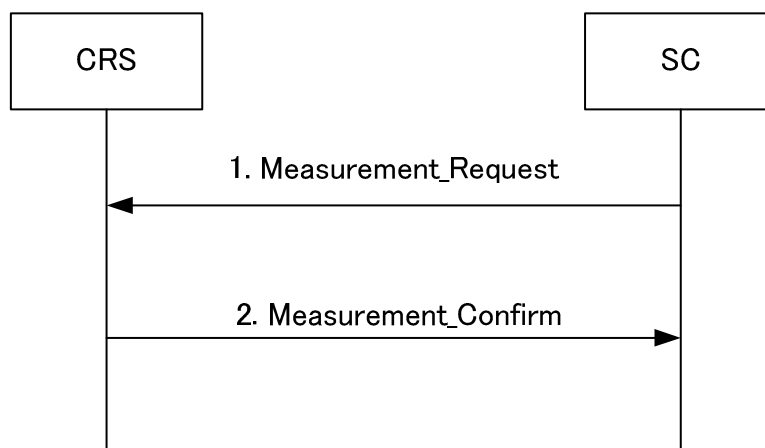

Figure 6.19: Requesting Measurements Procedure

The procedure is shown in figure 6.19 and shall be as follows:

- 1) In order for a SC to request measurements from a CRS and to obtain related measurement reports from a CRS which served by this SC, the SC generates a Measurement_Request message and sends the Measurement_Request message to the CRS. The Measurement_Request indicates the period of the measurements, channels/frequencies to be measured, type of measurement, configuration of silent periods, format of the measurement reports, etc.
- 2) After the CRS has received the Measurement_Request message from the SC, the CRS processes the Measurement_Request message, generates a Measurement_Confirm message and sends the Measurement_Confirm message to the SC. After the SC has received the Measurement_Confirm message from the CRS, the SC processes the Measurement_Confirm message.

6.1.6.3 Providing periodic measurements procedure

A CRS may be configured to perform periodic measurements and report them to the SC. A CRS shall perform the providing periodic measurement reports procedure when the SC has requested periodic measurement reports from the CRS.

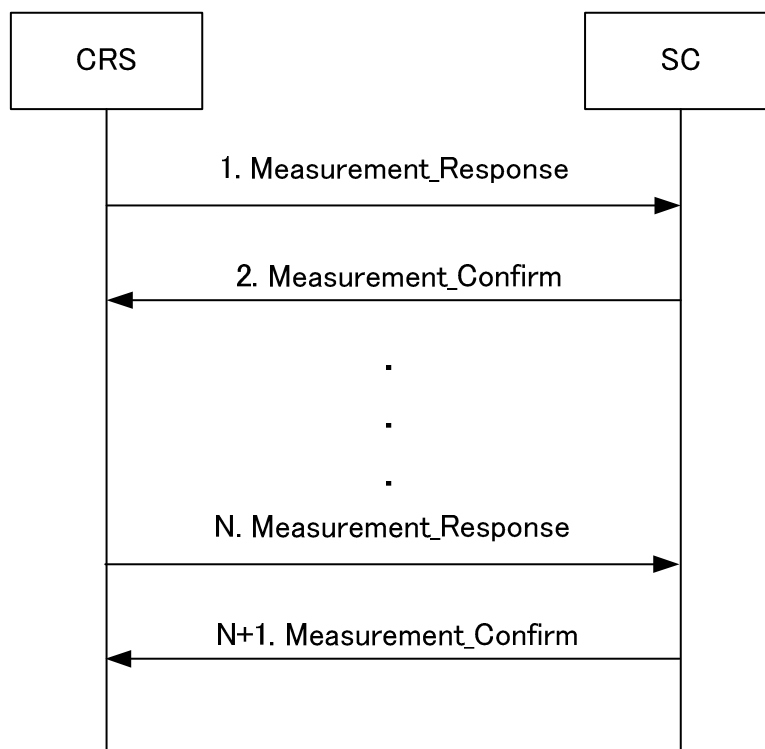

Figure 6.20: Providing Periodic Measurements Procedure

The procedure is shown in figure 6.20 and shall be as follows:

- 1) In order for a CRS to provide one of the periodic measurement reports to the SC which has earlier requested periodic measurement reports, the CRS generates a Measurement_Response message and sends the Measurement_Response message to the SC. The CRS continues generating and sending Measurement_Response messages to the SC as long as the request for periodic measurement reports is valid.
- 2) After the SC has received the Measurement_Response message from the CRS, the SC processes the Measurement_Response message, generates a Measurement_Confirm message and sends the Measurement_Confirm message to the CRS. After the CRS has received the Measurement_Confirm message from the SC, the CRS processes the Measurement_Confirm message.

6.1.6.4 Providing single measurements procedure

A CRS may be configured to perform single (non-periodic) measurements and report them to the SC. A CRS shall perform the providing single measurement reports procedure when the SC has requested single measurement reports from the CRS.

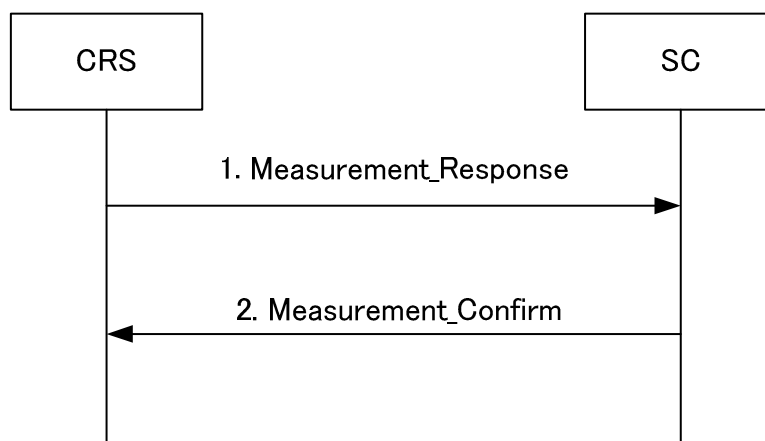

Figure 6.21: Providing Single Measurements Procedure

The procedure is shown in figure 6.21 and shall be as follows:

- 1) In order for a CRS to provide a single measurement report to the SC which has earlier requested the single measurement report, the CRS generates a Measurement_Response message and sends the Measurement_Response message to the SC.
- 2) After the SC has received the Measurement_Response message from the CRS, the SC processes the Measurement_Response message, generates a Measurement_Confirm message and sends the Measurement_Confirm message to the CRS. After the CRS has received the Measurement_Confirm message from the SC, the CRS processes the Measurement_Confirm message.

6.1.6.5 Non-Periodic measurements sequence

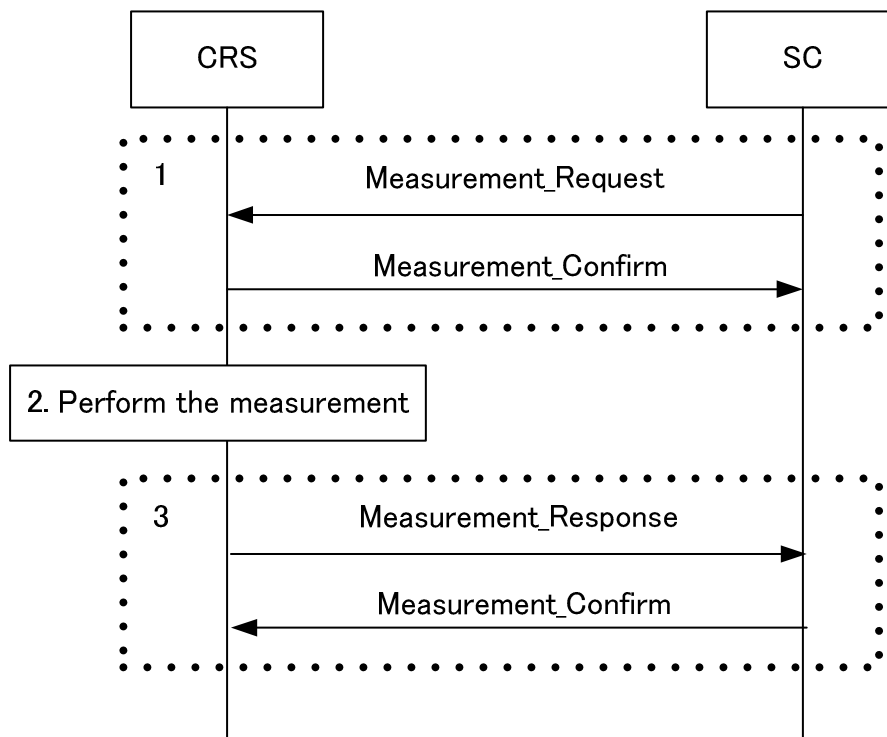

Figure 6.22: Non-Periodic Measurements Sequence

The procedure is shown in figure 6.22 and shall be as follows:

- 1) The SC performs the requesting measurements procedure by requesting the CRS to perform immediate non-periodic sensing and/or measurements.
- 2) The CRS performs the measurements (at specific devices within the system).
- 3) The CRS performs the providing single measurements procedure.

6.1.6.6 Event-Triggered Measurement Sequence

Non-periodic sensing can be triggered by an event created by a CRS (any slave in the CRS, or a master WSD, for instance). The event will detect some form of change in the environment on the channel(s) being used by the CRS, which will result in the SC requesting the CRS to perform sensing to detect the actual cause for the change.

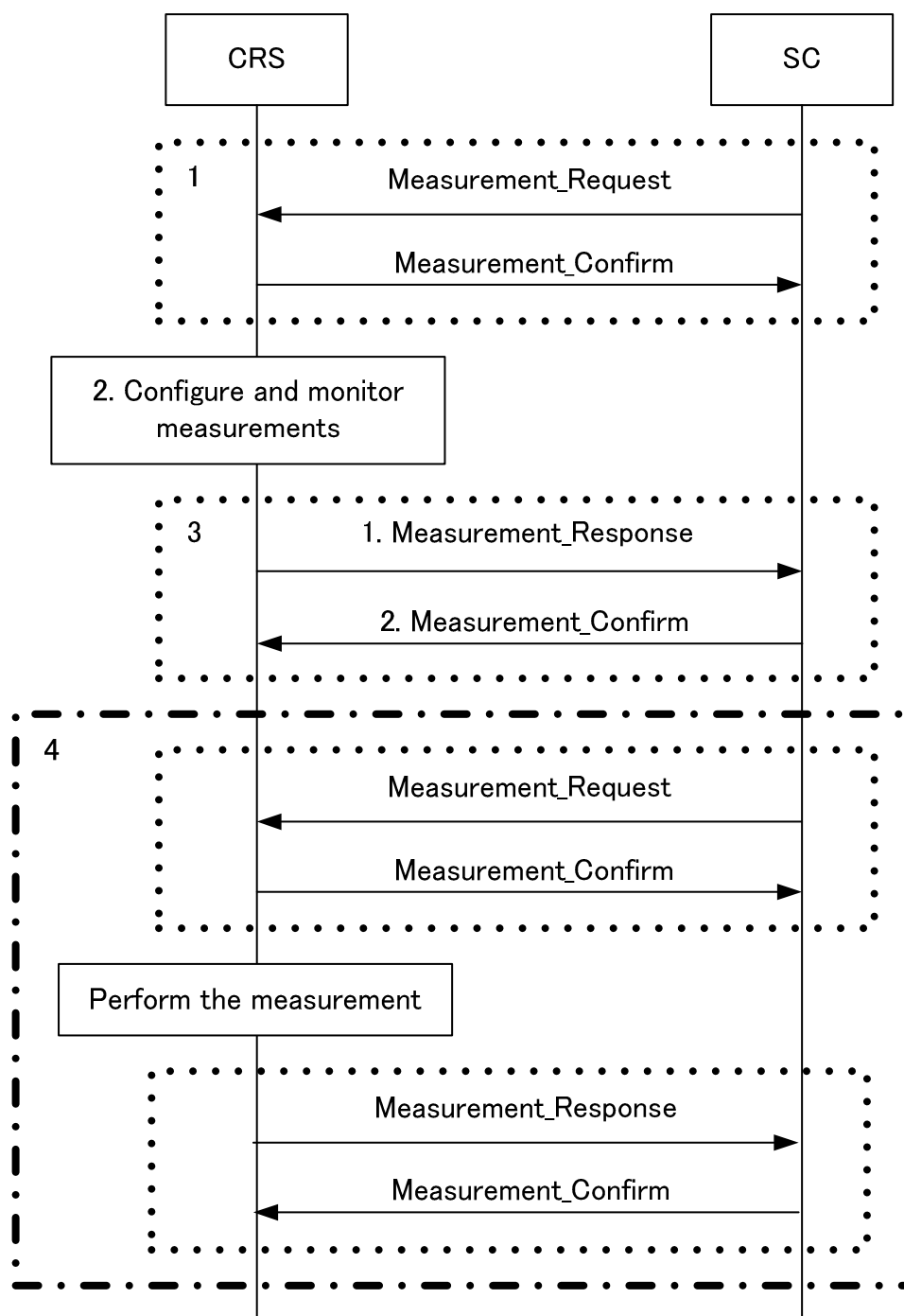

Figure 6.23: Event-Triggered Measurements Sequence

The procedure is shown in figure 6.23 and shall be as follows:

- 1) The SC performs the requesting measurements procedure with the CRS in order to send an event configuration message to each of the CR nodes and configure the event to be monitored by the CRS over channels it is actively using.
- 2) The CRS configures lower layers (e.g. the physical layer) to perform measurements technology-specific measurements for that CRS which are associated with the event. This can be done in the master WSD, slave WSDs, or both. Measurements from the lower layers are monitored, processed, and/or filtered by the CRS based on the event configuration in order to determine if the resulting technology-specific measurements trigger the event configured in the above steps.

- 3) Once an event is triggered, the CRS performs the providing single measurements procedure to send an event report to the SC to notify it of the occurrence of the event, and provide additional information related to the event.
- 4) Based on the information in step 3, the SC decides to trigger a non-periodic measurements sequence in order to request the performance of sensing by the CRS to determine the actual cause for the trigger of the event in step 2.

6.1.7 Reconfiguration Procedures and Operation Sequences

6.1.7.1 Reconfiguration request from SC to CRS procedure

The SC shall be able to reconfigure the operational parameters of a CRS through a reconfiguration request procedure. In addition, the SC shall be able to request reconfiguration of certain coexistence parameters in a CRS (assuming the CRS can support such parameters) based on changes in the usage of channels managed by the SC. The coexistence parameters may be specific to the RAT of the CRS and include, but are not limited to, the duty cycle of coexistence gaps for coexistence between CSMA and non-CSMA systems, and the reduction of the effective bandwidth of the CRS control channel to mitigate interference from strong adjacent channel incumbents.

A SC shall perform the sending of reconfiguration request from the SC to the CRS served by this SC when the SC has made a coordination decision which requires reconfiguration of the CRS.

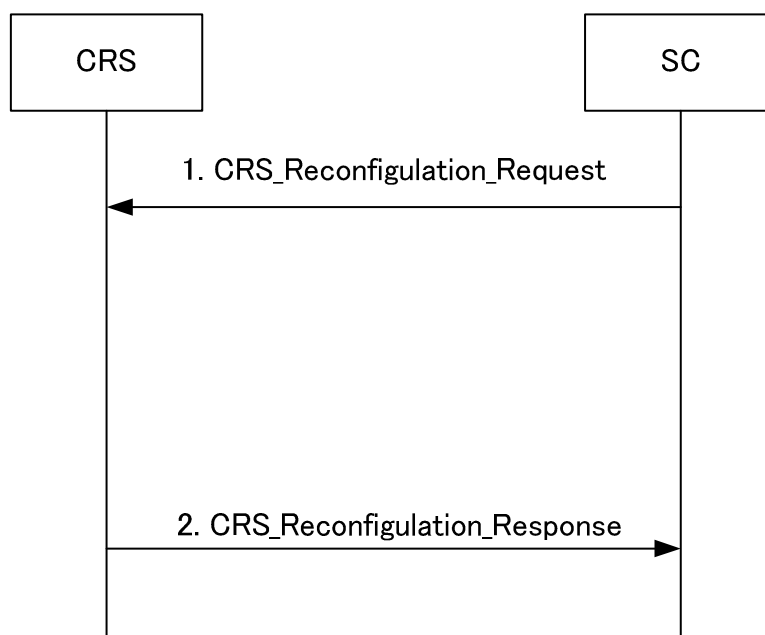

Figure 6.24: Reconfiguration Request from SC to CRS Procedure

The procedure is shown in figure 6.24 and shall be as follows:

- 1) The SC makes a coordinated decision to change the operational parameters or coexistence parameters which are supported by a CRS. This can be triggered by the request by another CRS to use the same or adjacent channel, or it may be the change in the usage of an incumbent system in the adjacent channel. After making a coordination decision, the SC generates a CRS_Reconfiguration_Request message and sends the CRS_Reconfiguration_Request message to the CRS to request a change in the operational or coexistence parameters of the CRS.
- 2) After the CRS has received the CRS_Reconfiguration_Request message from the SC, the CRS performs CRS reconfiguration using the reconfiguration information in the CRS_Reconfiguration_Request message, or (in the case of the information service) the CRS may indicate that the reconfiguration is not possible. The SC generates a CRS_Reconfiguration_Response message and sends the CRS_Reconfiguration_Response message to the SC. After the SC has received the CRS_Reconfiguration_Response message from the CRS, the SC processes the CRS_Reconfiguration_Response message.

6.1.7.2 Reconfiguration request from SC to GLDB procedure

A SC shall perform the sending resource reconfiguration request from the SC to the GLDB which serves the SC when the SC requires resource for reconfiguration of a CRS.

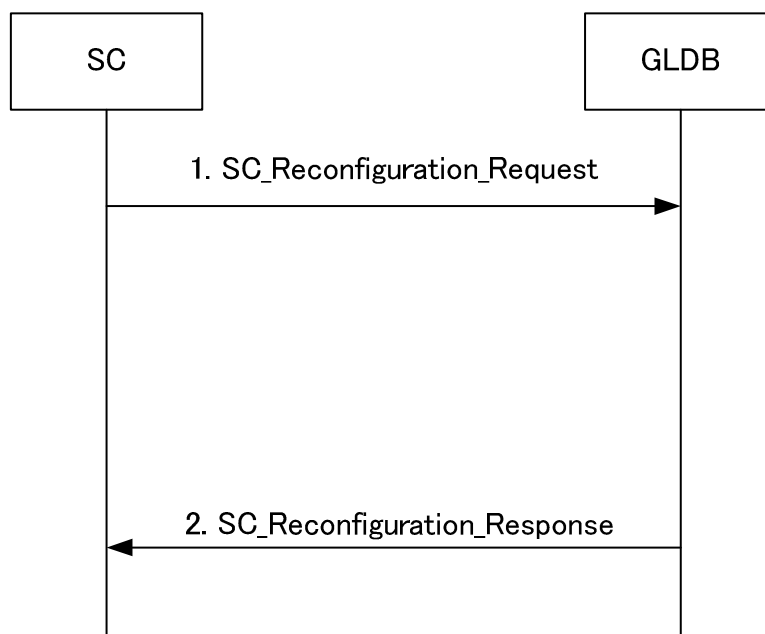

Figure 6.25: Reconfiguration Request from SC to GLDB Procedure

The procedure is shown in figure 6.25 and shall be as follows:

- 1) When an SC requires resource for reconfiguration of a CRS, the SC generates a SC_Reconfiguration_Request message and sends the SC_Reconfiguration_Request message to the GLDB which serves this SC.
- 2) After the GLDB has received the SC_Reconfiguration_Request message from the SC, the GLDB processes the SC_Reconfiguration_Request message, generate a SC_Reconfiguration_Response message and send the SC_Reconfiguration_Response message to the SC.

6.1.7.3 General reconfiguration sequence between coordinated CRSs

The SC, based on interaction with a coordinated CRS (CRS2), determines that there is a need for reconfiguration of another coordinated CRS (CRS1). For instance, this may occur when CRS1 and CRS2 use overlapping adjacent channels that incur interference to each other. The reassignment of channel usage can resolve this coexistence issue. In another instance, since the SC knows the channel usages of all CRSs, the SC can make channel usage reassignment among CRSs so that better spectrum efficiency can be achieved. Note that such reassignment is performed within the available channels given by the GLDB from the incumbent protection perspective.

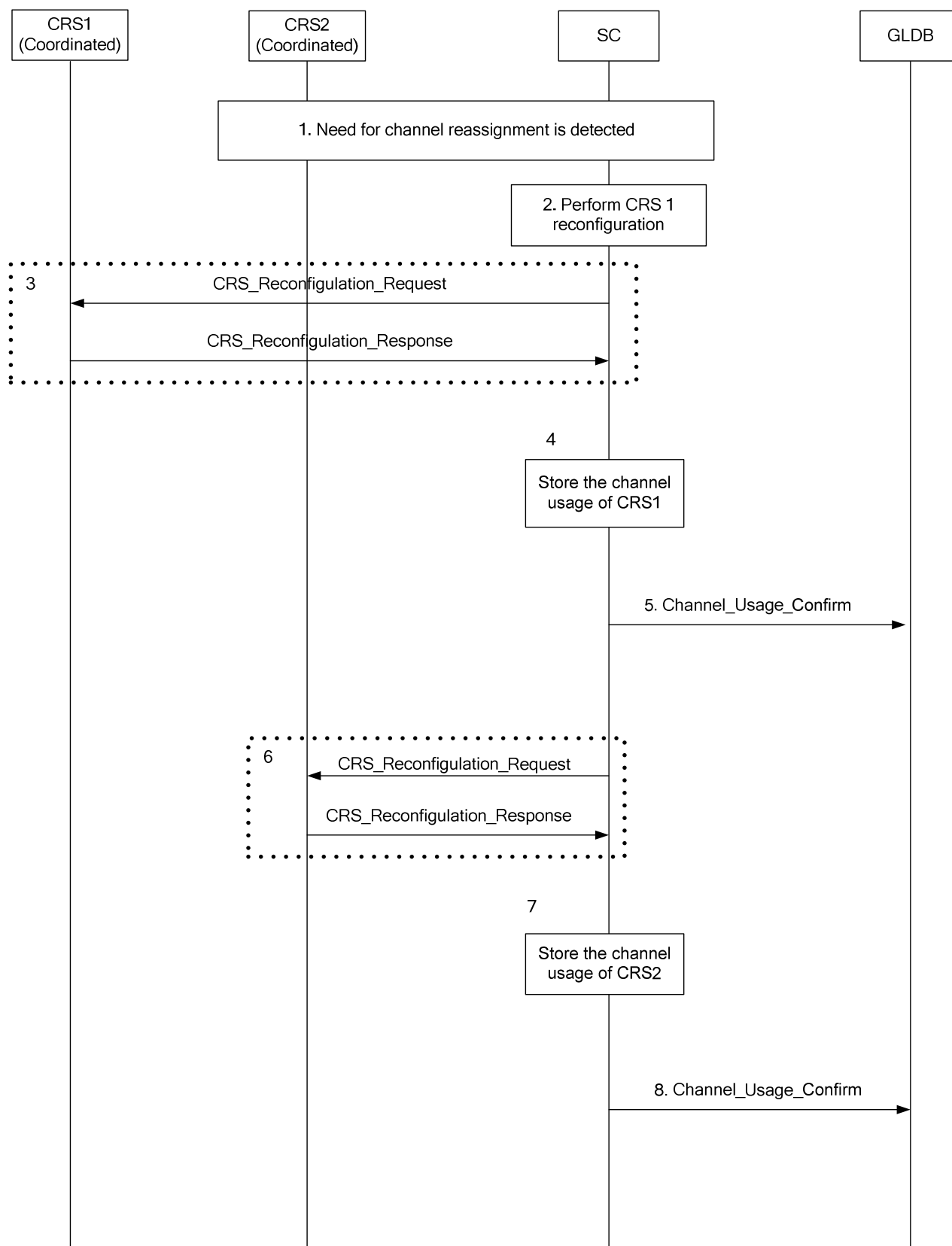

Figure 6.26: General Reconfiguration Sequence between Coordinated CRSs

The procedure is shown in figure 6.26 and shall be as follows:

- 1) The SC detects/determines the need for channel reassignment to address the needs of CRS2.
- 2) The SC performs the reconfiguration for CRS 1.

- 3) The SC performs the reconfiguration request from SC to CRS procedure for CRS 1.
- 4) The SC stores the channel usage information of CRS 1.
- 5) The SC sends the channel usage information for CRS 1 to the GLDB.
- 6) The SC performs the reconfiguration request from SC to CRS procedure for CRS 2.
- 7) The SC stores the channel usage information of CRS 2.
- 8) The SC sends the channel usage information for CRS 2 to the GLDB.

6.1.7.4 CRS Request-Triggered Operational Parameter Reconfiguration

Operational parameters can be reconfigured by the SC from a request made by a CRS. For example, the SC could realize that a CRS requiring two contiguous channels would be able to obtain them only if another CRS changes its operating channels, which would require a reconfiguration.

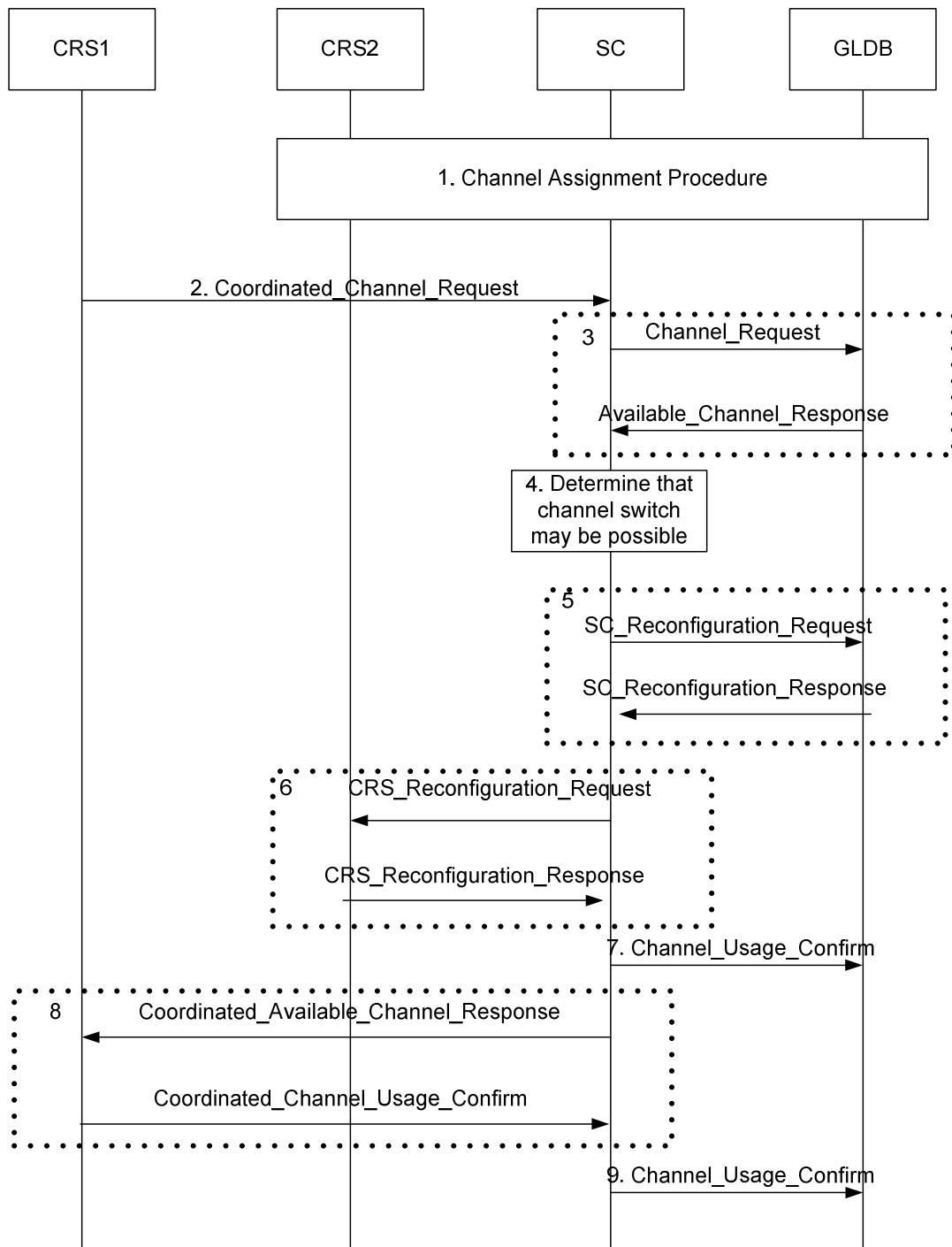

Figure 6.27: CRS Request-Triggered Operational Parameter Reconfiguration

The procedure is shown in figure 6.27 and shall be as follows:

- 1) CRS2, the SC, and the GLDB perform a basic channel assignment procedure and CRS2 is assigned some channel resources.
- 2) While CRS2 is using these channel resources, CRS1 makes a request for resources by sending its device parameters (as with a normal channel request).
- 3) The SC makes a request from the GLDB using the device parameters of CRS1. The GLDB provides the operational parameters (available channels, corresponding power, etc.) for CRS1 to the SC.

- 4) The SC determines, based on the supplemental usage information that it could benefit from the change in operational parameters of CRS2. For example, CRS1 may require two contiguous TVWS channels, and such channels would only be available if CRS2 were to change its operating channel to make the contiguous channels available.
- 5) The SC performs the SC Reconfiguration Request to GLDB procedure to reconfigure the usage of CRS2.
- 6) The SC performs the SC Reconfiguration Request to CRS procedure with CRS2.
- 7) The SC provides the operational parameters of CRS2 to the GLDB.
- 8) The SC provides the available channels to CRS1. CRS1 confirms the used channels and operational parameters to the SC.
- 9) The SC provides the operational parameters of CRS1 to the GLDB.

6.1.7.5 CRS-Measurement Triggered Priority-Based Operational Parameter Reconfiguration

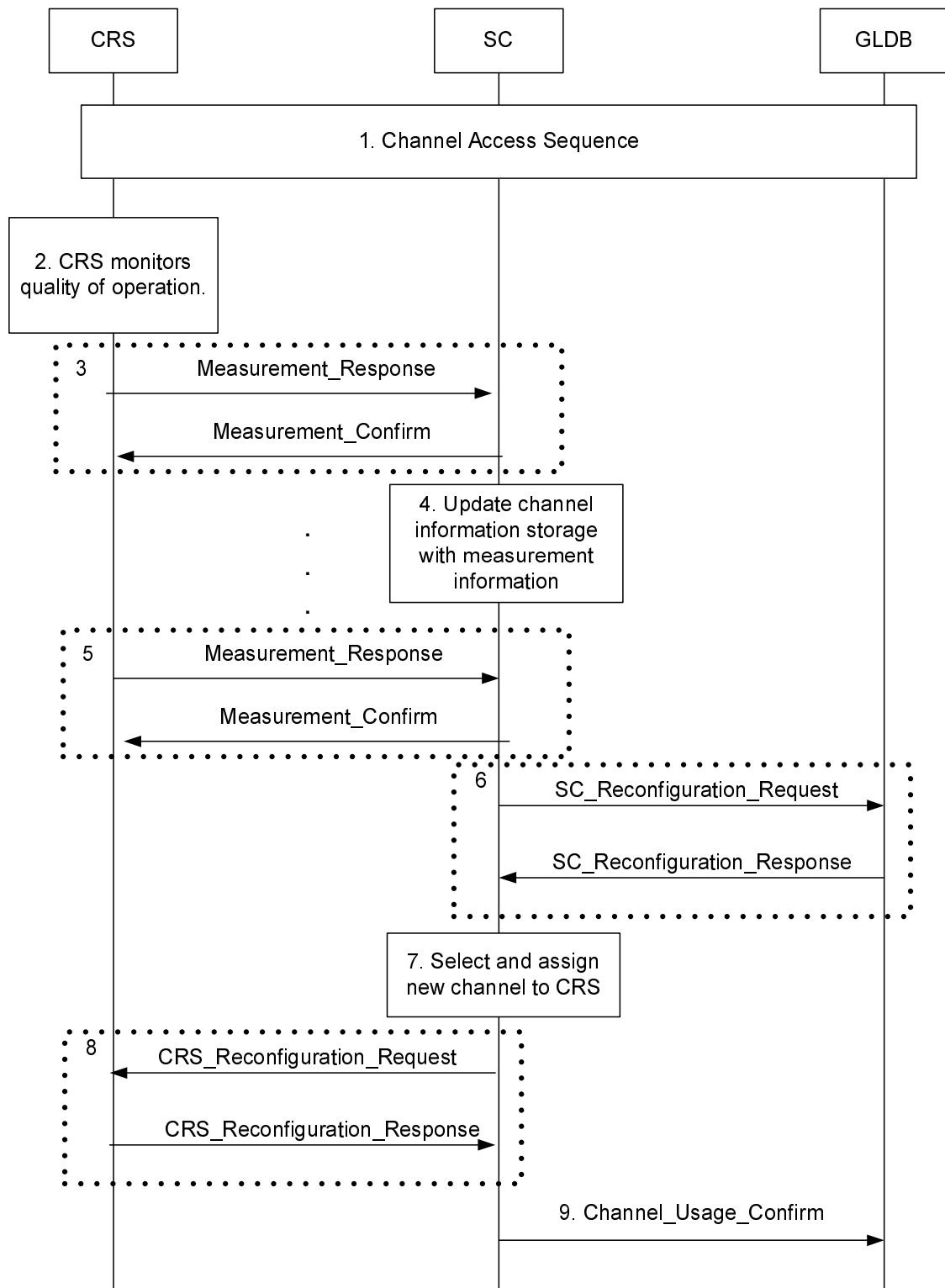

Figure 6.28: CRS Measurement Triggered Priority Based Operational Parameter Reconfiguration

The procedure is shown in figure 6.28 and shall be as follows:

- 1) The CRS, the SC, and the GLDB perform a basic channel access sequence (see procedure 6.1.3.4) and the CRS is assigned some channel resources.

- 2) While the CRS is using these channel resources, it monitors continuously the quality of its operation and measures the interference on the assigned active channels.
- 3) The CRS may send metric results from the active channel monitoring and measurements to the SC.
- 4) The SC updates its channel information storage.
- 5) In case the CRS experiences a degradation of its quality of operation due to increased interference level, it informs the SC about such situation.
- 6) The SC performs a channel reconfiguration request to the GLDB procedure to request new channels and/or device parameters from the GLDB.
- 7) The SC, upon receiving a channel reconfiguration response from the GLDB, selects and assigns the new channels to CRS.
- 8) The SC performs a channel reconfiguration request to CRS to provide a new set of channel resources to address the degradation.
- 9) The SC, upon receiving a reconfiguration response from the CRS, confirms the new CRS operation parameters to the GLDB.

6.1.7.6 General Priority-Based Channel Reconfiguration Sequence

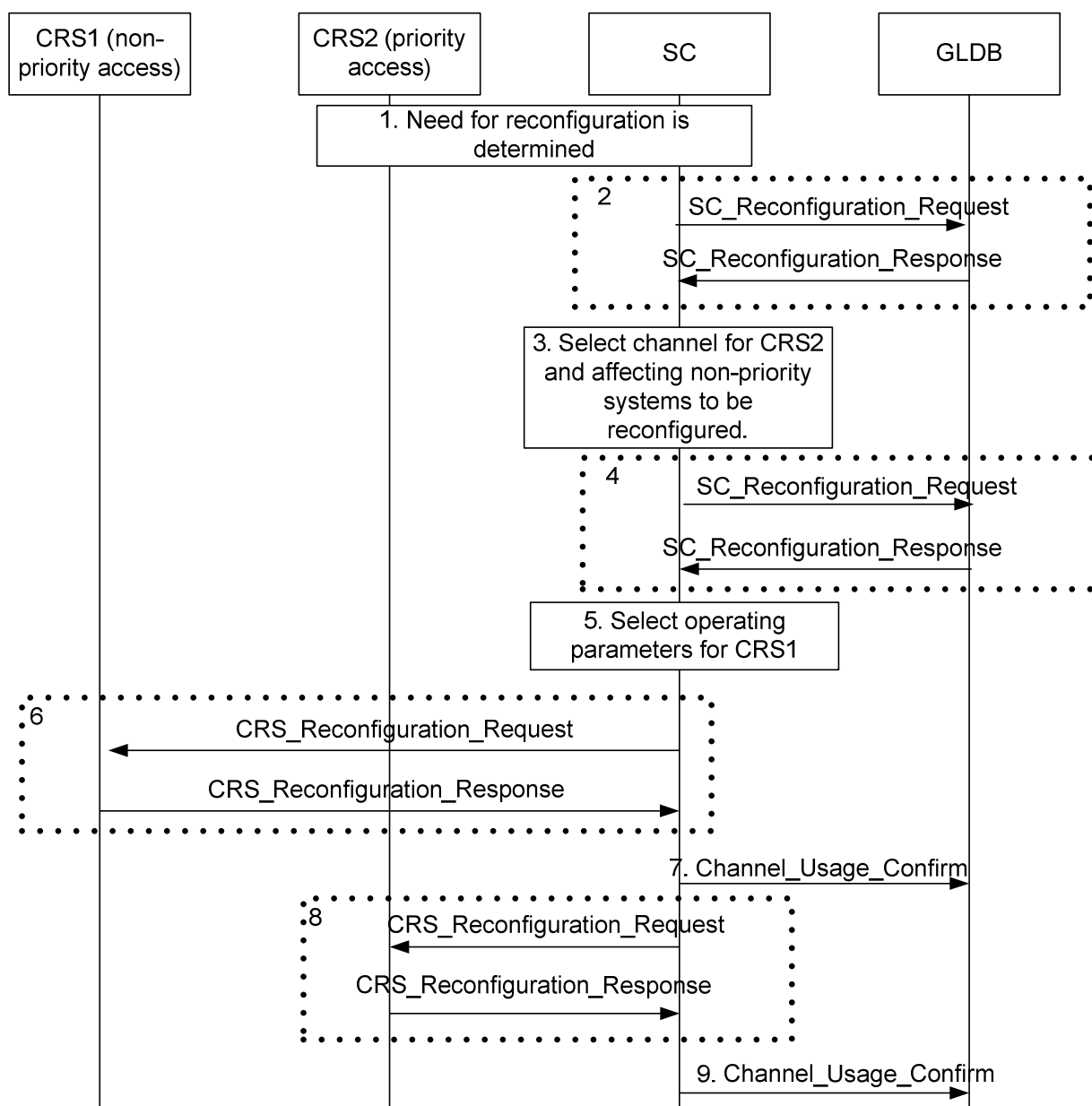

Figure 6.29: General Priority-Based Channel Reconfiguration Sequence

The procedure is shown in figure 6.29 and shall be as follows:

- 1) The SC, based on interaction with a priority access CRS (CRS2), determines that there is a need for reconfiguration of other non-priority CRSs (CRS1). For instance, this may occur when CRS2 would like to use TVWS for priority access, but no available channels on which priority access can be granted currently exist. Another situation would be when CRS2 (which is already operating in TVWS) experiences congestion on the channel(s) it is using.
- 2) Upon detection of this scenario, the SC would send a request for reconfiguration to the GLDB to query initial or additional channels which may be used for CRS2. The reconfiguration response will provide the possible operational parameters (available channels, corresponding power, etc.) for CRS2 to the SC.
- 3) The SC selects the appropriate channels to be utilized by CRS2, and also determines the non-priority access systems which need to be reconfigured to allow CRS2 to operate with priority access.
- 4) The SC sends a request for reconfiguration to the GLDB to query the available channels and operating parameters for CRS1.

- 5) The SC will select a new set of operating parameters for CRS1 to allow CRS2 to operate in priority usage.
- 6) The SC performs a SC reconfiguration request to CRS procedure with CRS1 to force CRS1 to reconfigure its operation. Such reconfiguration could allow, for example, evacuation of CRS1 from the usage of the channel that will be selected for priority usage of CRS2, or movement of CRS1 from the current channel to another channel where other non-priority access systems may be operating (in order to allow the current channel to be used for priority access).
- 7) The SC sends the channel usage parameters of CRS1 to the GLDB.
- 8) The SC performs a SC reconfiguration request to CRS procedure with CRS2 to configure CRS2 with the new operating parameters for CRS2 to operate on.
- 9) The SC sends the channel usage parameters of CRS2 to the GLDB.

6.1.7.7 Management of uncoordinated CRSs considering priority usage of coordinated CRSs

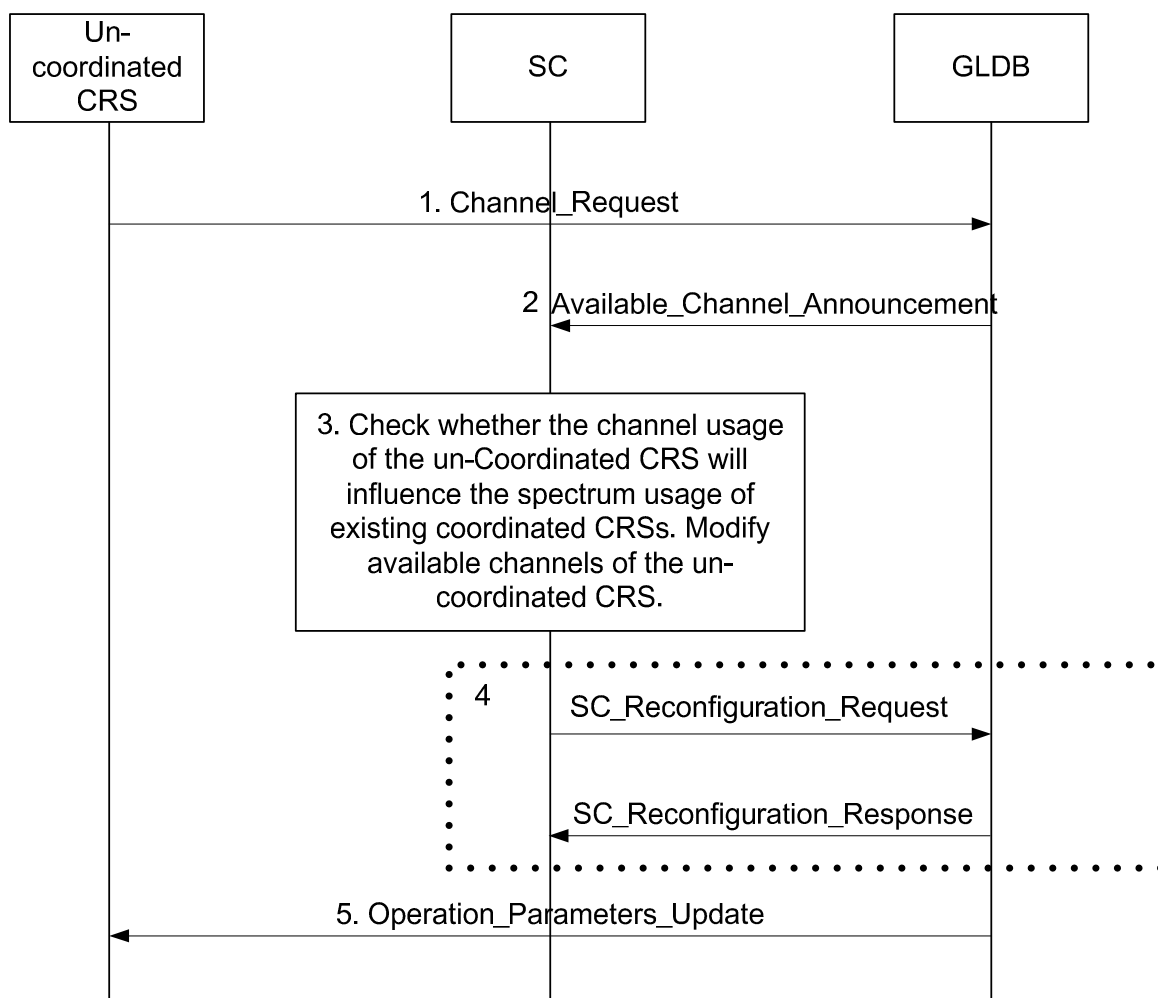

Figure 6.30: Management of uncoordinated CRSs considering priority usage of coordinated CRSs

The procedure is shown in figure 6.30 and shall be as follows:

- 1) An un-coordinated CRS requests available channels from the GLDB.
- 2) The GLDB performs the announcing available channel list update procedure when the GLDB determines the available channels according to the protection to the incumbents.
- 3) The SC, having the spectrum usage of existing coordinated CRS, checks whether the un-coordinated CRS will influence the spectrum usage of the existing coordinated CRS if it uses the available channels as given by the GLDB.

- 4) The SC performs the reconfiguration request from SC to GLDB for the un-coordinated CRS.
- 5) The GLDB sends the Operation_Parameters_Update message to the un-coordinated CRS.

6.1.7.8 Priority Usage Request Considering Uncoordinated Channel Usage

6.1.7.8.1 Overview

A priority usage coordinated CRS, upon requesting available channels from the GLDB, can provide requirements on its channel quality. In some scenarios, providing channels to the priority usage CRSs requires changes to the current usage of the uncoordinated CRSs. Such changes of the uncoordinated CRS channel usage will occur at the next expiry of the validity time of the respective uncoordinated CRSs.

There are two implementation options for this operation sequence, dependant on how the protection criteria of the priority usage CRS is maintained in the system. These two options are described in clauses 6.1.7.8.2 and 6.1.7.8.3.

6.1.7.8.2 Implementation Option A

In the first implementation option, the SC reserves channels with the GLDB in preparation for the expiry of the validity time of the channels used by the uncoordinated systems. Upon the expiry of the validity time, the priority usage CRSs can start using these channels. The GLDB, in storing the protection criteria of the priority usage CRSs, will then be able to reflect the updated channel availability to the uncoordinated CRSs based on these protection criteria.

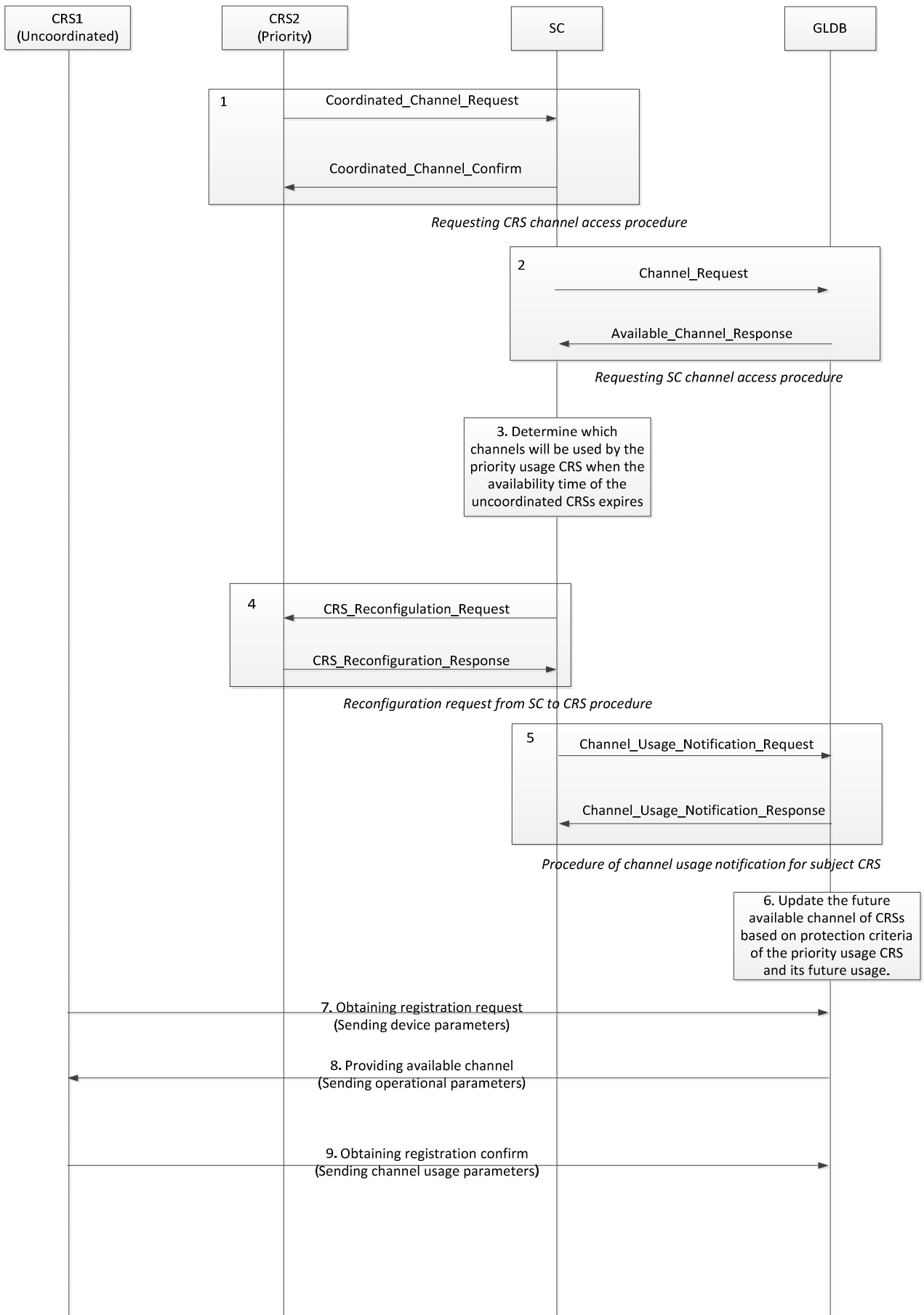

Figure 6.31: Implementation Option A

The procedure is shown in figure 6.31 and shall be as follows:

- 1) A priority usage coordinated CRS (CRS2) performs the requesting CRS channel access procedure to obtain operational parameters from the SC.
- 2) The SC performs the requesting SC channel access procedure to request operational parameters for CRS2 by providing the protection criteria of CRS2. In this scenario, there may not currently be available channels to satisfy the channel quality requirements of CRS2, however, channels will become available following the expiry of the availability time of channels being utilized by uncoordinated CRS (CRS1). The GLDB therefore informs the SC in this step of a list of potential usable channels and the time in which such channels will become available.
- 3) The SC selects a set of operational parameters for CRS2 at the time at which the currently utilized channels will become available.
- 4) The SC performs the reconfiguration request from SC to CRS procedure to send the operational parameters of CRS2. These operational parameters will indicate the time instance in which CRS2 can start operation on the channels, given that the validity time of channels currently used by the uncoordinated CRS that conflicts with CRS2 has expired. CRS2 will therefore only start using the channels provided in this step at the indicated time.
- 5) The SC performs the procedure of channel usage notification for subject CRS to send the channel usage parameters of CRS2 to the GLDB.
- 6) The GLDB stores the protection criteria of CRS2 and its future channel usage. Based on this future channel usage, the GLDB also updates the availability of TVWS channels to account for the CRS2 protection criteria at the future time instance when CRS2 will start using the channels.
- 7) Before the validity time of available channel expires, the uncoordinated CRS (CRS1) contacts the GLDB to confirm channel availability for continuous channel usage by sending its device parameters to the GLDB.
- 8) The GLDB sends operational parameters to inform CRS1 to update its operational parameters. These operational parameters will take into account the new usage of channels by CRS2 that has started (or will start upon expiry of the validity time).
- 9) CRS1 sends its channel usage parameters to the GLDB.

6.1.7.8.3 Implementation Option B

This implementation option relies on the use of two additional procedures which are required only for this implementation option:

- 1) the Priority Usage Checking procedure; and
- 2) providing Uncoordinated CRS information procedure.

Priority usage checking procedure

A GLDB shall perform the priority usage checking procedure when the GLDB has received device parameters from an uncoordinated CRS for its operation.

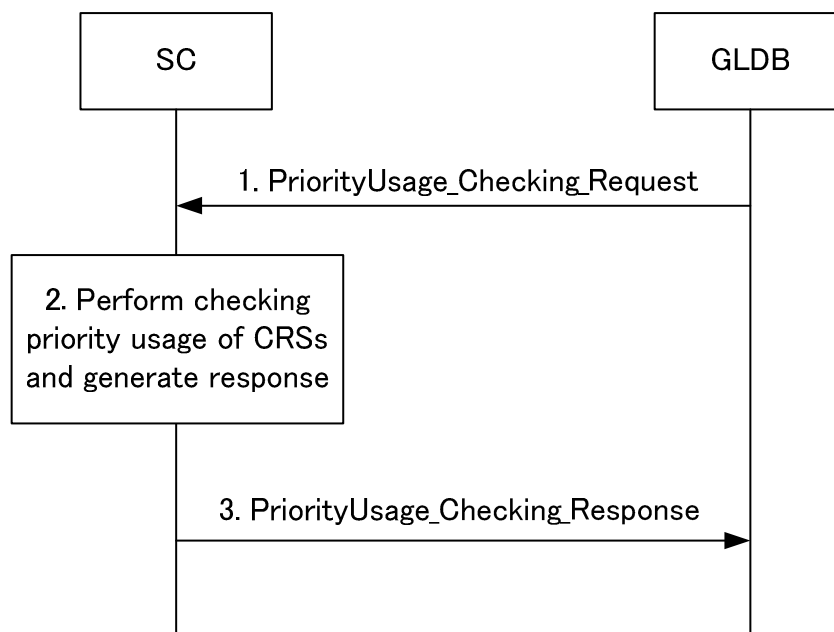

Figure 6.32: Priority Usage Checking Procedure

The procedure is shown in figure 6.32 and shall be as follows:

- 1) When the GLDB has received device parameters from an uncoordinated CRS, the GLDB generates one or several `PriorityUsage_Checking_Request` messages. The number of the generated `PriorityUsage_Checking_Request` messages is equal to the number of the SCs. After the `PriorityUsage_Checking_Request` message has been generated, the GLDB sends the `PriorityUsage_Checking_Request` messages to the SCs.
- 2) After the SC has received the `PriorityUsage_Checking_Request` message from the GLDB, the SC processes the `PriorityUsage_Checking_Request` message, generates a `PriorityUsage_Checking_Response` message and sends the `PriorityUsage_Checking_Response` message to the SC.
- 3) After the GLDB has received the `PriorityUsage_Checking_Response` message from the SC, the GLDB processes the `PriorityUsage_Checking_Response` message.

Providing uncoordinated CRS information procedure

A GLDB shall perform the providing uncoordinated CRS information procedure when the GLDB has received channel usage parameters from an uncoordinated CRS.

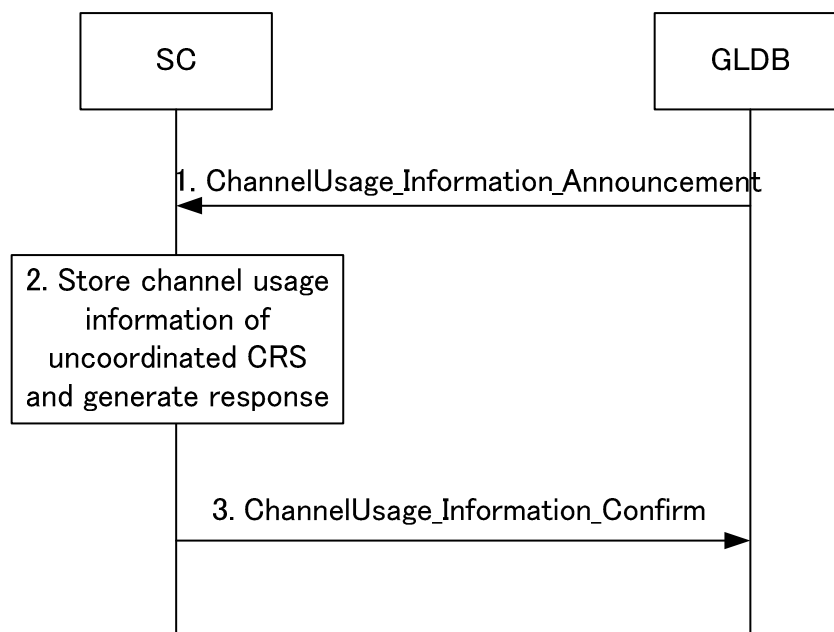

Figure 6.33: Providing uncoordinated CRS information procedure

The procedure is shown in figure 6.33 and shall be as follows:

- 1) When the GLDB has received channel usage parameters from an uncoordinated CRS, the GLDB generates one or several ChannelUsage_Information_Announcement message. The number of the generated ChannelUsage_Information_Announcement messages is equal to the number of the SCs. After the ChannelUsage_Information_Announcement message has been generated, the GLDB sends the ChannelUsage_Information_Announcement messages to the SCs.
- 2) After the SC has received the ChannelUsage_Information_Announcement message from the GLDB, the SC processes the ChannelUsage_Information_Announcement message, generates a ChannelUsage_Information_Confirm message and sends the ChannelUsage_Information_Confirm message to the SC.
- 3) After the GLDB has received the ChannelUsage_Information_Confirm message from the SC, the GLDB processes the ChannelUsage_Information_Confirm message.

In this second implementation option for the priority usage request considering uncoordinated usage, the SC, knowing the spectrum usage of existing un-coordinated CRSs, shall be able to determine updates of the spectrum usage of un-coordinated CRSs to satisfy the requirements of the priority usage coordinated CRSs. The update instructions are sent to the GLDB. The GLDB updates the available channels of the uncoordinated CRSs when these CRSs request confirmation of their current spectrum usage at the expiration of the validity time of the current available channels.

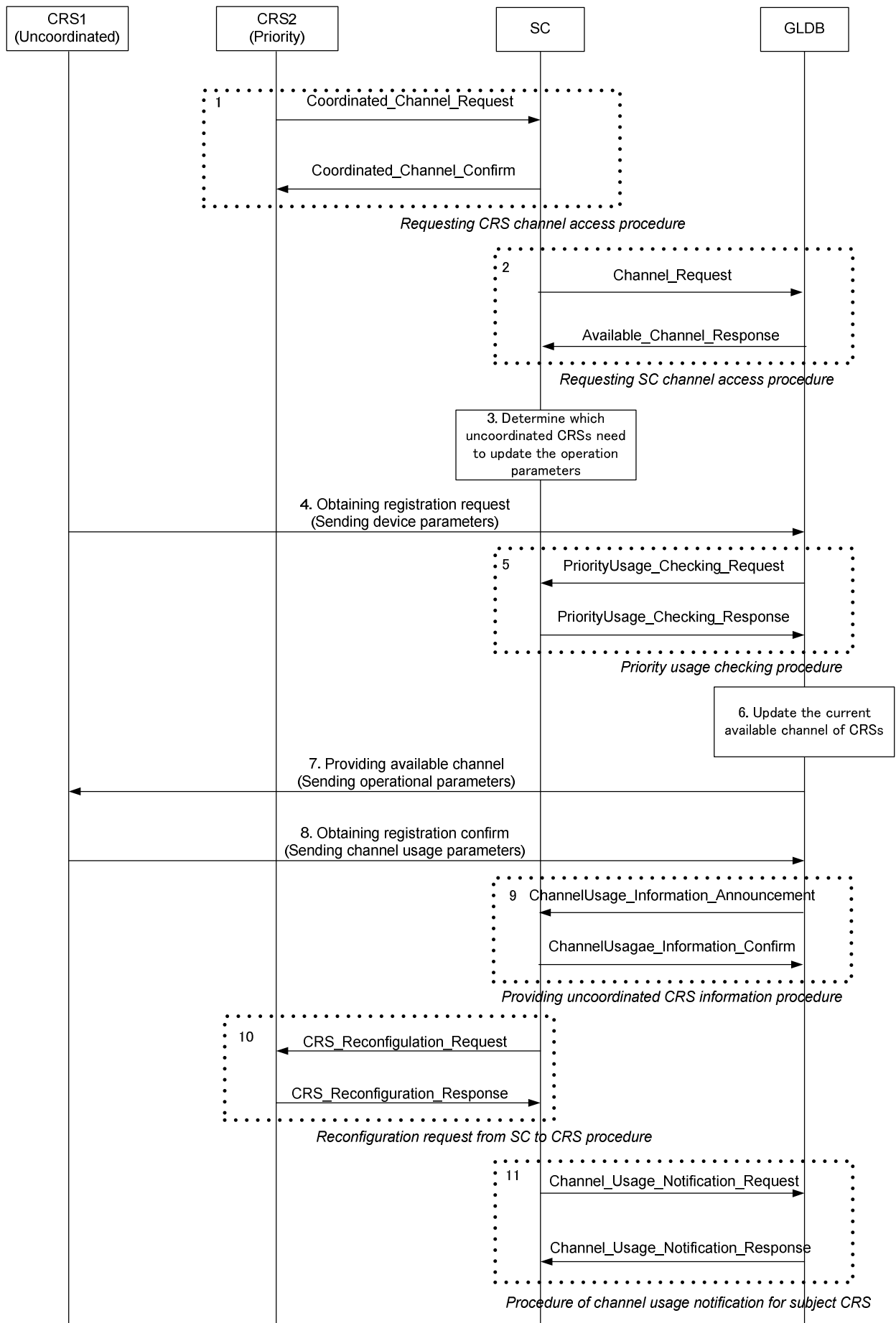

Figure 6.34: Implementation Option B

The procedure is shown in figure 6.34 and shall be as follows:

- 1) A priority usage coordinated CRS (CRS2) performs the CRS registration procedure to obtain operational parameters from the SC.
- 2) The SC performs the requesting SC channel access procedure to request operational parameters for CRS2.
- 3) The SC, having the spectrum usage of existing uncoordinated CRSs, checks whether the un-coordinated CRS will influence the spectrum usage of the priority usage coordinated CRS if it uses the available channels and operational parameters as given by the GLDB. In the case where the SC cannot satisfy the request from CRS2 without a need to change the usage of one or more uncoordinated CRS, the SC waits for the expiry of the validity time of CRS1 before servicing CRS2.
- 4) Before the validity time of channels used by the uncoordinated CRS (CRS1) expires, CRS1 contacts the GLDB to determine whether it can continue to use the channels.
- 5) The GLDB calculates the operational parameters of CRS1 with the requirements of incumbent protection and performs the priority usage checking procedure to send information of CRS1 in the PriorityUsage_Checking_Request to the SC. The SC sends the PriorityUsage_Checking_Response to the GLDB indicating whether the channel usage of existing uncoordinated CRSs is to be modified.
- 6) If the requesting CRS is the one for which the SC has requested a change on the spectrum usage the GLDB updates the available channels for CRS1.
- 7) The GLDB sends operational parameters to CRS1.
- 8) CRS1 sends its channel usage parameters to the GLDB.
- 9) After receiving the channel usage parameters of CRS1, the GLDB performs the providing uncoordinated CRS information procedure to send the channel usage parameters of CRS1 to the SC.
- 10) The SC performs the reconfiguration request from SC to CRS procedure to send the operational parameters of CRS2.
- 11) The SC performs the procedure of channel usage notification for subject CRS to send the channel usage parameters of CRS2 to the GLDB.

6.1.7.9 Uncoordinated CRS Request Considering Priority Usage Coordinated CRS

6.1.7.9.1 Overview

This procedure is performed when an uncoordinated CRS requests channels from the GLDB over reference point A, when there is a potential for causing interference with a priority usage CRS operating in the same area. It is assumed that the signalling between the uncoordinated CRS and the GLDB is consistent with clause 6.2 (Procedures for Uncoordinated Access of White Spaces), and only the operations of the GLDB and SC are considered to be specific to the coordinated case.

There are two implementation options, dependant on how the protection criteria of the priority usage CRS is maintained in the system.

6.1.7.9.2 Implementation Option A

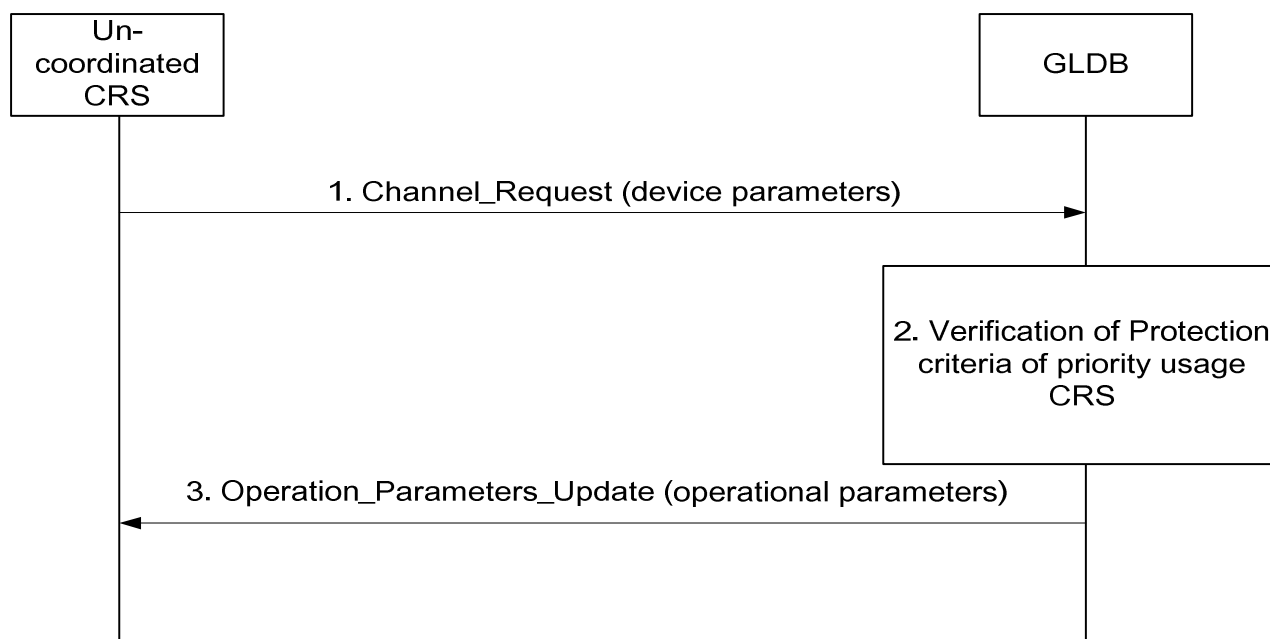

Figure 6.35: Implementation Option A

The procedure is shown in figure 6.35 and shall be as follows:

- 1) An un-coordinated CRS requests available channels from the GLDB.
- 2) The GLDB verifies the protection criteria of any priority usage CRS currently utilizing the white spaces. This protection criteria was obtained and stored by the GLDB when each respective priority usage CRS requested channels from the SC.
- 3) The GLDB sends the Operational_Parameters_Update message to the un-coordinated CRS, which ensure both protection of the incumbent and protection of priority usage systems from the uncoordinated CRSs (which communicate directly with the GLDB).

6.1.7.9.3 Implementation Option B

This implementation option relies on the use of the following procedures described above:

- the Priority Usage Checking procedure;
- providing Uncoordinated CRS information procedure.

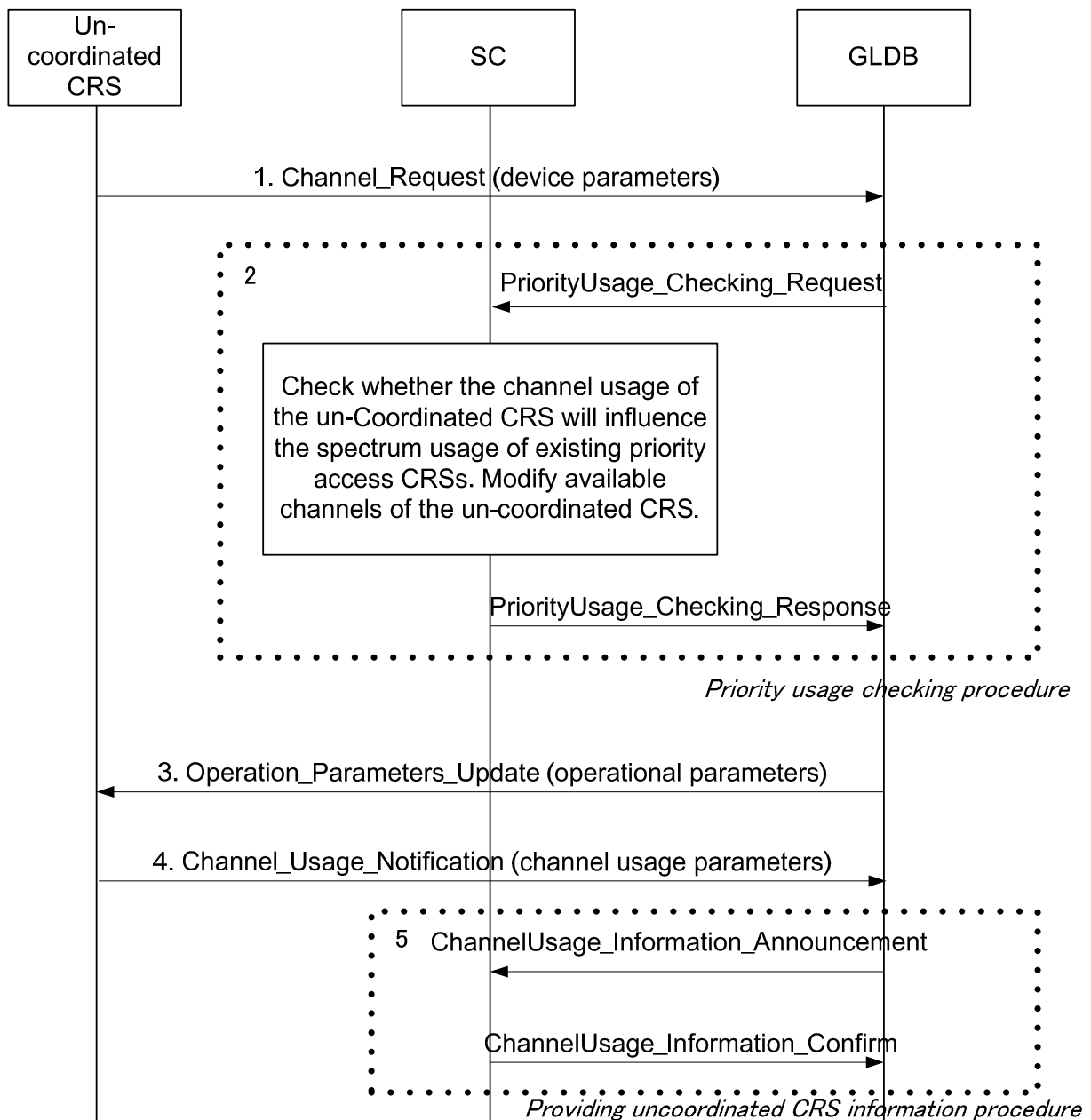

Figure 6.36: Implementation Option B

The procedure is shown in figure 6.36 and shall be as follows:

- 1) An un-coordinated CRS requests available channels from the GLDB.
- 2) The GLDB performs the priority usage checking procedure when the GLDB determines the available channels according to the protection of the incumbents. The SC, having the spectrum usage of existing priority access CRSs, determines whether the un-coordinated CRS will influence the spectrum usage of the existing priority access CRSs if they use the available channels as given by the GLDB. The SC sends the resulting determination for the GLDB to modify the uncoordinated CRS operational parameters sent in the next step accordingly.
- 3) The GLDB sends the operational parameters in the Operation_Parameters_Update message to the uncoordinated CRS.
- 4) The uncoordinated CRS sends its channel usage parameters in the Channel_Usage_Notification message to the GLDB.

- 5) The GLDB performs the providing uncoordinated CRS information procedure to send the operational parameters of the uncoordinated CRS to the SC.

6.1.7.10 Device parameter reconfiguration request from SC to CRS procedure

The SC may be able to reconfigure certain device parameters of a CRS through a device parameter reconfiguration request procedure. When the SC has made a coordination decision which would require device parameter reconfiguration of the CRS, it may perform the sending of device parameter reconfiguration request from the SC to the CRS served by this SC. The device parameters that may be reconfigurable include antenna elevation angle, antenna direction angle, and spectral emission mask, etc.

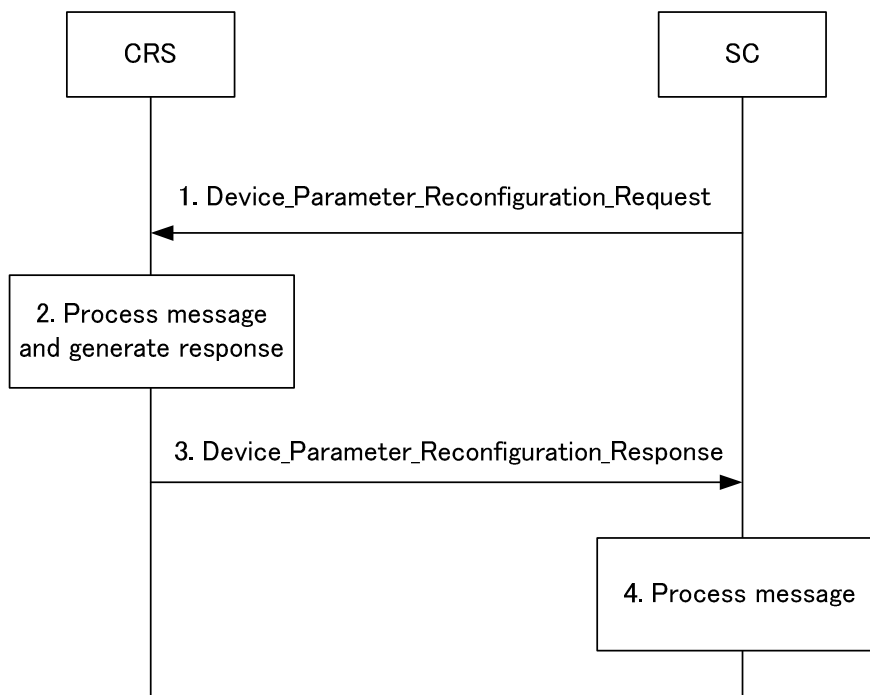

Figure 6.37: Device parameter reconfiguration Request from SC to CRS Procedure

The procedure is shown in figure 6.37 and shall be as follows:

- 1) The SC makes a decision to change the reconfigurable device parameters of a CRS. For example, this can be triggered by the decision of the SC when the SC finds that the expected QoS of the CRS cannot be achieved by using the currently available channels due to the use of the same channels by other CRSs. In case the SC needs to ask a CRS to change its reconfigurable device parameters and gain new available channels. After making this coordination decision, the SC generates a `Device_Parameter_Reconfiguration_Request` message and sends the message to the CRS to request a change of the reconfigurable device parameters of the CRS.
- 2) After the CRS has received the `Device_Parameter_Reconfiguration_Request` message from the SC, the CRS performs CRS device parameter reconfiguration using the reconfiguration information in the `Device_Parameter_Reconfiguration_Request` message.
- 3) The CRS generates a `Device_Parameter_Reconfiguration_Response` message and sends the message to the SC.
- 4) After the SC has received the `Device_Parameter_Reconfiguration_Response` message from the CRS, the SC processes the message.

6.1.7.11 General sequence of device parameter reconfiguration request from SC to CRS for facilitating coexistence among CRSs

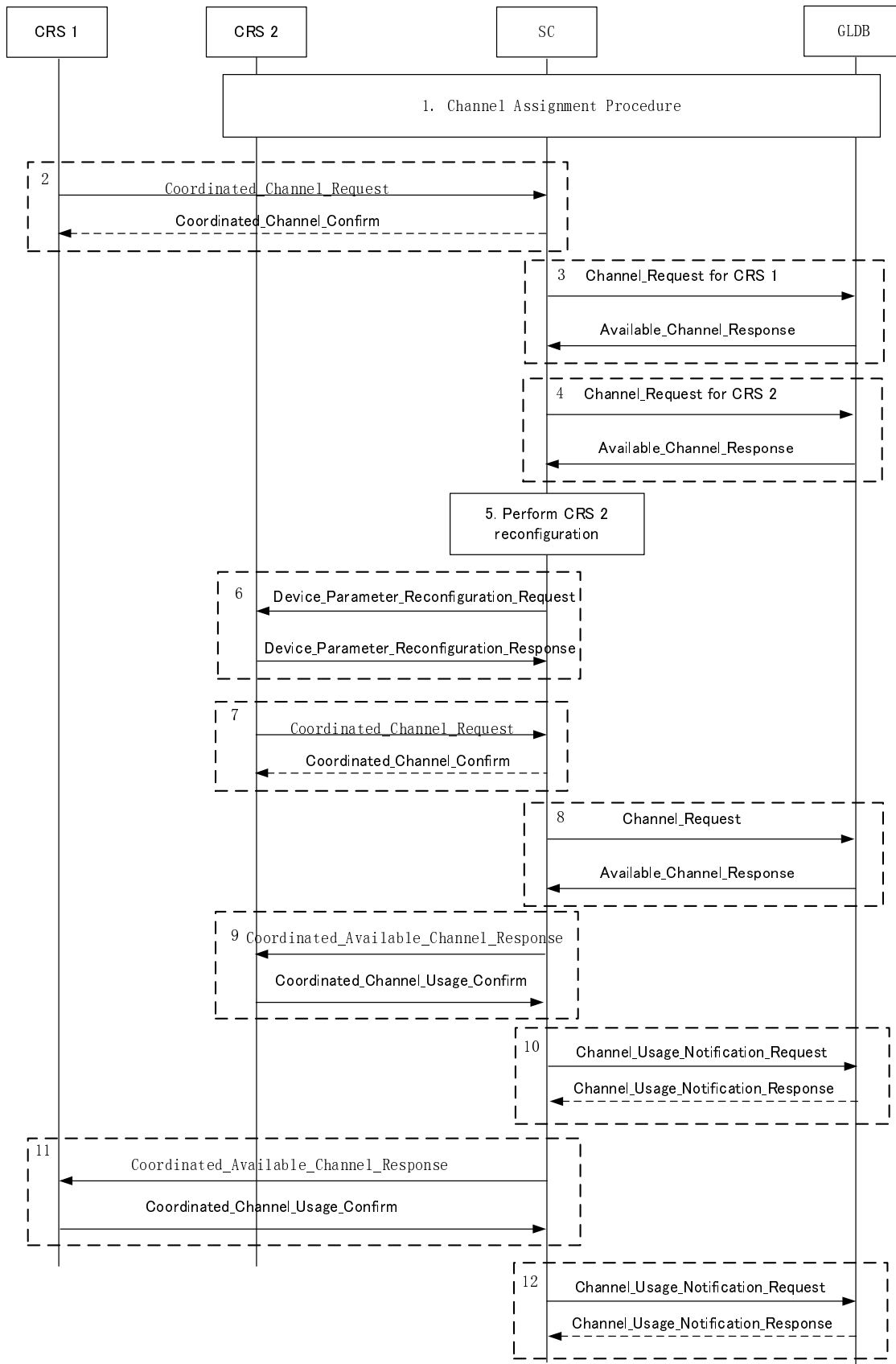

Figure 6.38: General sequence of device parameter reconfiguration request from SC to CRS for facilitating coexistence among CRSs

The procedure is shown in figure 6.38 and shall be as follows:

- 1) CRS2, the SC, and the GLDB perform a basic channel assignment procedure and CRS2 is assigned with some channel resources.
- 2) While CRS2 is using these channel resources, CRS1 performs the requesting CRS channel access procedure to obtain operational parameters from the SC. The SC may optionally confirm the reception of the message.
- 3) The SC makes a channel request to the GLDB using the device parameters of the CRS1. The GLDB provides the possible operational parameters (available channels, corresponding power, etc.) for the CRS1 to the SC.
- 4) The SC makes a channel request to the GLDB using the device parameters of the CRS2. The GLDB provides the possible operational parameters (available channels, corresponding power, etc.) for the CRS2 to the SC.
- 5) According to the coexistence principles among CRSs, SC makes decisions about the changes to the device parameters of CRS2.
- 6) The SC and CRS2 perform the basic "device parameter reconfiguration request from SC to CRS procedure" to change the device parameters of CRS2 according to the decision of the SC.
- 7) CRS2 performs the "Requesting CRS channel access procedure" to request channel access using the new device parameters.
- 8) The SC makes a channel request to the GLDB using the new device parameters of the CRS2. The GLDB provides the possible operational parameters (available channels, corresponding power, etc.) for the CRS2 to the SC.
- 9) The SC provides the available channels to CRS2 and CRS2 confirms the channel usage and operational parameters to the SC.
- 10) The SC confirms the selected channel usage parameters of CRS2 to the GLDB.
- 11) The SC provides the available channels to CRS1. CRS1 confirms the used channels and operational parameters to the SC.
- 12) The SC confirms the selected channel usage parameters of the CRS1 to the GLDB.

6.1.8 Inter-SC procedures

6.1.8.1 Reconfiguration request from master SC to CRS registered to slave SC procedure

A SC shall perform the procedure for reconfiguration request from master SC to slave SC when the master SC has made a coordination decision that requires reconfiguration of a CRS registered to the slave SC.

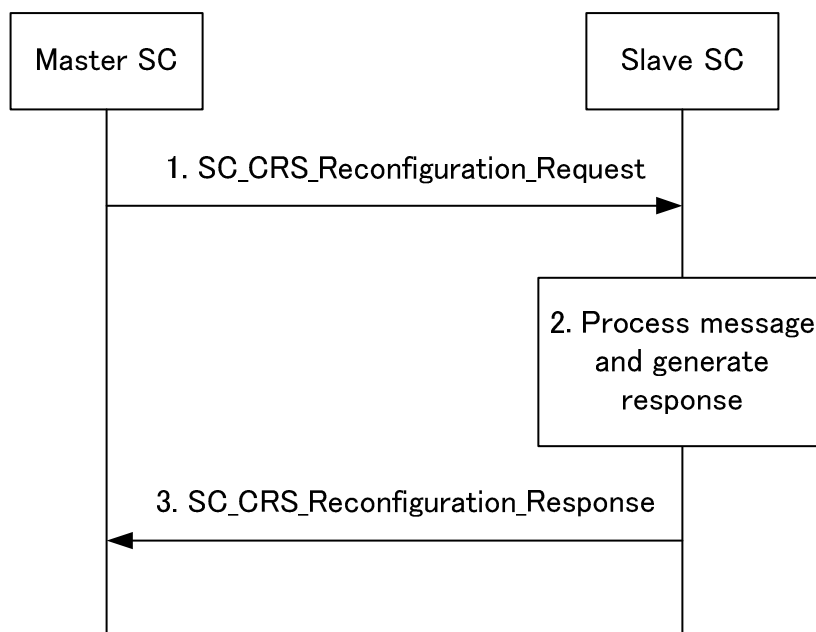

Figure 6.39: Reconfiguration Request from Master SC to CRS Registered to Slave SC Procedure

The procedure is shown in figure 6.39 and shall be as follows:

- 1) After making a coordination decision that requires reconfiguration of a CRS registered to the slave SC the master SC generates a SC_CRS_Reconfiguration_Request messages and sends the SC_CRS_Reconfiguration_Request message to the slave SC.
- 2) After the slave SC has received the SC_CRS_Reconfiguration_Request message from the master SC, the slave SC performs CRS reconfiguration using the reconfiguration information in the SC_CRS_Reconfiguration_Request message, generates a SC_CRS_Reconfiguration_Response message and sends the SC_CRS_Reconfiguration_Response message to the master SC.
- 3) After the master SC has received the SC_CRS_Reconfiguration_Response message from the slave SC, the master SC processes the SC_CRS_Reconfiguration_Response message.

6.1.8.2 Master/slave SC configuration procedure

A SC shall perform the master/slave SC configuration procedure when the master SC needs to change its role from master SC to slave SC in centralized decision making.

The method for initially selecting the master SC is defined by the specific implementation of the system. When there are many SCs in the system, the system shall select one master SC from all SCs before starting the system.

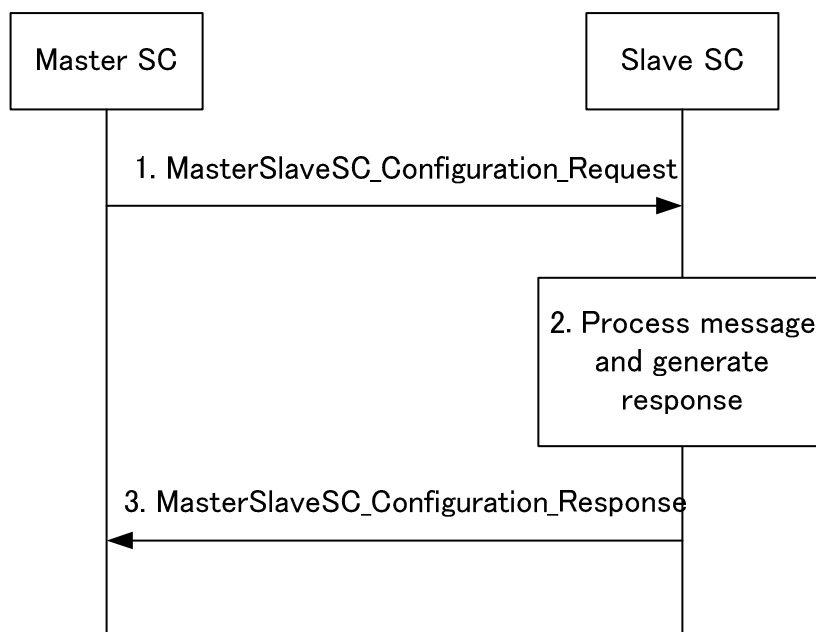

Figure 6.40: Master/Slave SC Configuration Procedure

The procedure is shown in figure 6.40 and shall be as follows:

- 1) When the master SC wants to change its role from master SC to slave SC in centralized decision making, the master SC generates a `MasterSlaveSC_Configuration_Request` messages and sends the `MasterSlaveSC_Configuration_Request` to the selected slave SC.
- 2) After the selected slave SC has received the `MasterSlaveSC_Configuration_Request` message from the master SC, the slave SC processes the `MasterSlaveSC_Configuration_Request` message, generates a `MasterSlaveSC_Configuration_Response` message and sends the `MasterSlaveSC_Configuration_Response` message to the master SC.
- 3) After the master SC has received the `MasterSlaveSC_Configuration_Response` message from the selected slave SC, the master SC processes the `MasterSlaveSC_Configuration_Response` message. In the case the slave SC accepts the reconfiguration, the slave SC now becomes the new master.

6.1.8.3 Obtaining coordination set information from other SCs procedure

A SC shall perform the procedure when the SC needs to obtain coordination set information from other SCs.

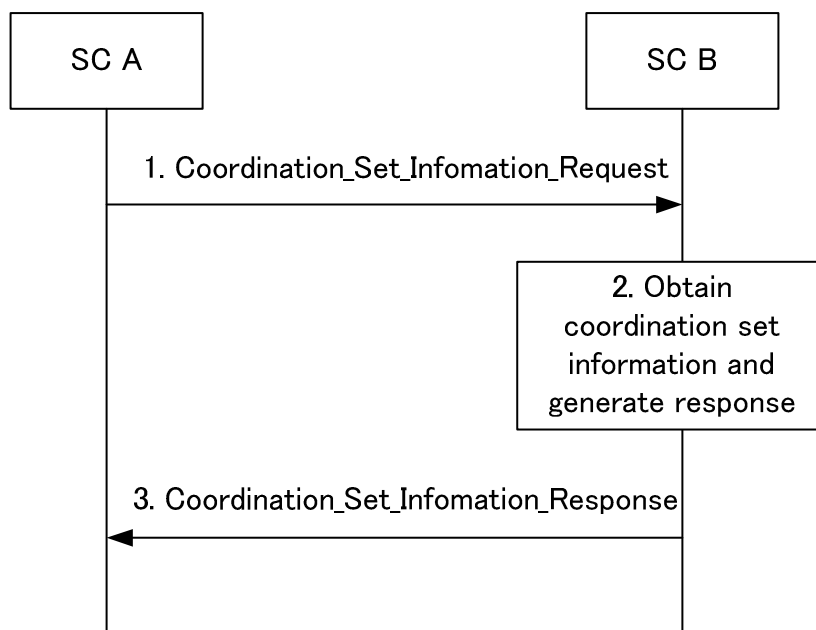

Figure 6.41: Obtaining coordination set information from other SCs procedure

The procedure is shown in figure 6.41 and shall be as follows:

- 1) When SC A needs to obtain the coordination set information from SC B, SC A generates a `Coordination_Set_Information_Request` message and sends the `Coordination_Set_Information_Request` message to SC B.
- 2) After SC B has received the `Coordination_Set_Information_Request` message, SC B obtains the coordination set information, generates a `Coordination_Set_Information_Response` message.
- 3) SC B sends the `Coordination_Set_Information_Response` message to SC A after SC A has received the `Coordination_Set_Information_Response` message from SC B.

6.1.8.4 Procedures for interfering SCs discovery

6.1.8.4.1 Overview

In coordinated usage of TVWS, the SC ensures coexistence of different CRSs to avoid harmful interference between CRSs under the same SC. However, depending on system implementation, it is possible that CRSs under different SCs could interfere with each depending on the areas managed by each SC. Such SCs are referred to as "interfering SCs" in this clause and this kind of interference should be avoided by discovering such interfering SCs.

6.1.8.4.2 GLDB-aided potential interfering SCs discovery procedure

In the SC authentication/registration procedure, the SC provides information such as the planned location and channel usage of the CRSs which it supports. This information can be used by the GLDB to determine the potential interfering SCs for a given SC. Every SC could acquire knowledge of the potential interfering SCs that are served by the same GLDB. Using the following procedure, the SC acquires a list of potential interfering SCs that are served by the same GLDB so that an SC can contact the SCs in this list to determine if they are interfering SCs.

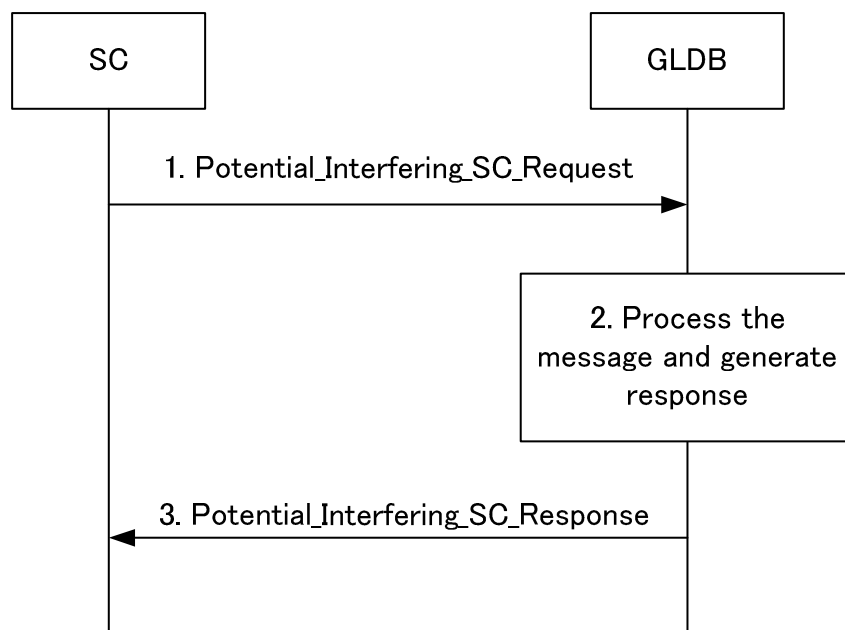

Figure 6.42: GLDB-Aided Potential Interfering SC Discovery Procedure

The procedure is shown in figure 6.42 and shall be as follows:

- 1) When the SC wants to discover potential interfering SCs, it may generate a Potential_Interfering_SC_Request message and send the Potential_Interfering_SC_Request message to the GLDB which serves this SC.
- 2) After the GLDB has received the Potential_Interfering_SC_Request message from the SC, the GLDB processes the Potential_Interfering_SC_Request message, and generate a Potential_Interfering_SC_Response message.
- 3) The GLDB sends the Potential_Interfering_SC_Response message to the SC. After the SC has received the Potential_Interfering_SC_Response message from the GLDB, the SC processes the Potential_Interfering_SC_Response message.

6.1.8.4.3 Interfering SCs discovery procedure

Before providing operational parameters to a CRS, the SC shall check whether the use of such operational parameters by the CRS causes interference to the CRS managed by other SCs. Such a check with proposed operational parameters should be done with every SC from the potential interfering SC list.

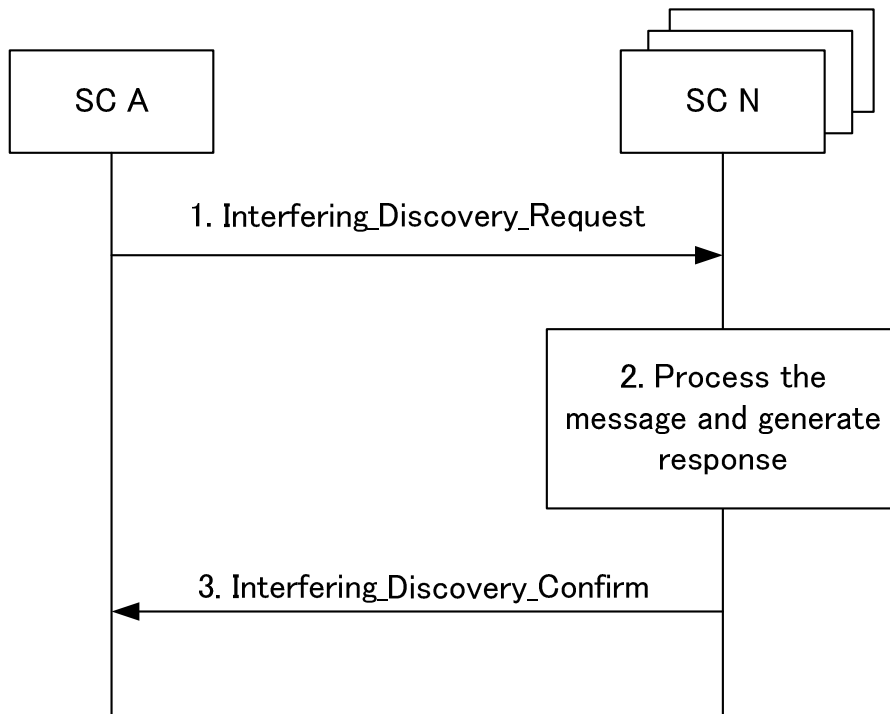

Figure 6.43: Interfering SC Discovery Procedure

The procedure is shown in figure 6.43 and shall be as follows:

- 1) When the SC wants to discover interfering SCs related to current spectrum assignment, it may generate an `Interfering_Discovery_Request` message and send it to all potential interfering SCs. The `Interfering_Discovery_Request` message includes information of the proposed CRS configuration, e.g. the location, device parameters, and proposed spectrum and operation parameters of the CRS.
- 2) After SCs have received the `Interfering_Discovery_Request` message, the SCs process the `Interfering_Discovery_Request` message, and generate an `Interfering_Discovery_Confirm` message.
- 3) The SCs send the `Interfering_Discovery_Confirm` message to the initiating SC. After the initiating SC has received the `Interfering_Discovery_Confirm` message from the SCs, the initiating SC processes the `Interfering_Discovery_Confirm` message.

6.1.8.5 Negotiation between SCs procedure

The SC needs to negotiate with SCs in its coordination set about the channel usage/configuration of CRSs under its management.

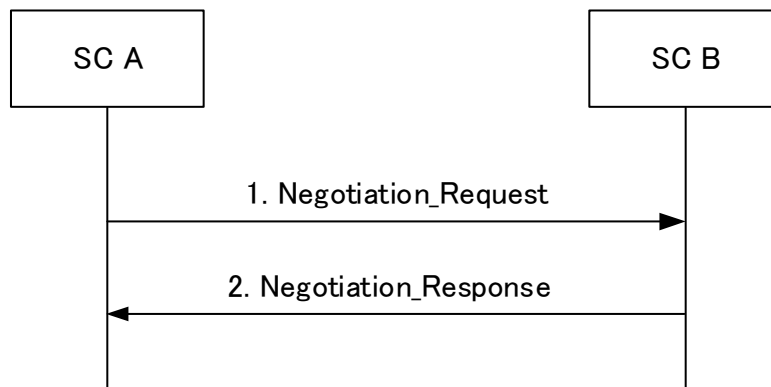

Figure 6.44: Negotiation Between SCs

The procedure is shown in figure 6.44 and shall be as follows:

- 1) SC A proposes channel usage/configuration for the CRSs under its management and generates a Negotiation_Request message to send to the SC for the negotiation with SC B.
- 2) When SC B received the Negotiation message from SC A, it makes a decision on its own CRS channel usage/configuration based on the proposed channel usage/configuration from SC A and generates a Negotiation_Response message to SC A.

The negotiation procedure could be performed several times depending on implementation (e.g. with the limit on the maximum negotiation time) until agreement or a stopping condition is reached.

6.1.8.6 Operational Sequences for negotiation-based configuration of SCs

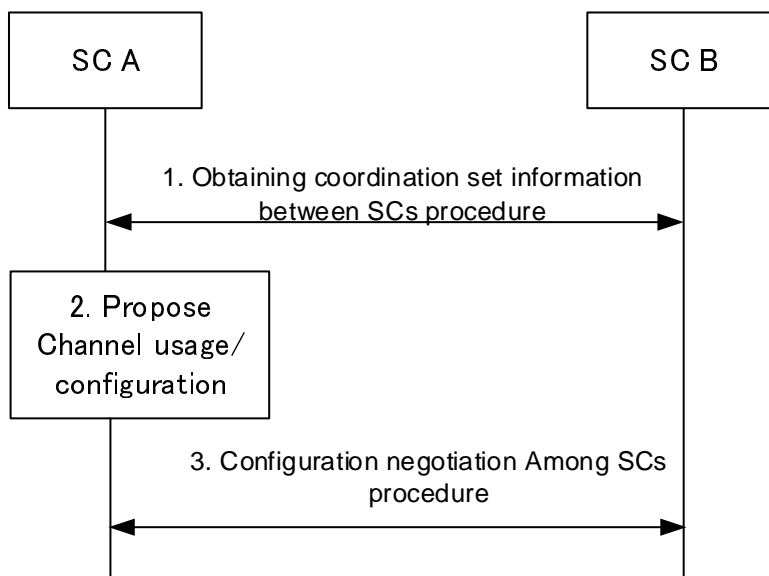

Figure 6.45: Operation Sequence for Negotiation-based Configuration

The procedure related to the full operational sequence for negotiation-based configuration of SCs is shown in figure 6.45 and shall be as follows:

- 1) SC A obtains the coordination set information from related SCs, for example, SC B. This is achieved via the "Obtaining coordination set information between SCs procedure".
- 2) After receiving the coordination set information, SC A proposes a specific channel usage/configuration for the CRSs under its management. This may affect SC B in its coordination set. This step is dependent on the principles or algorithms in the implementation.
- 3) SC A negotiates with SC B about its proposed channel usage/configuration. This is achieved via the "negotiation among SCs procedure".

6.2 Procedures for Uncoordinated Access of White Spaces

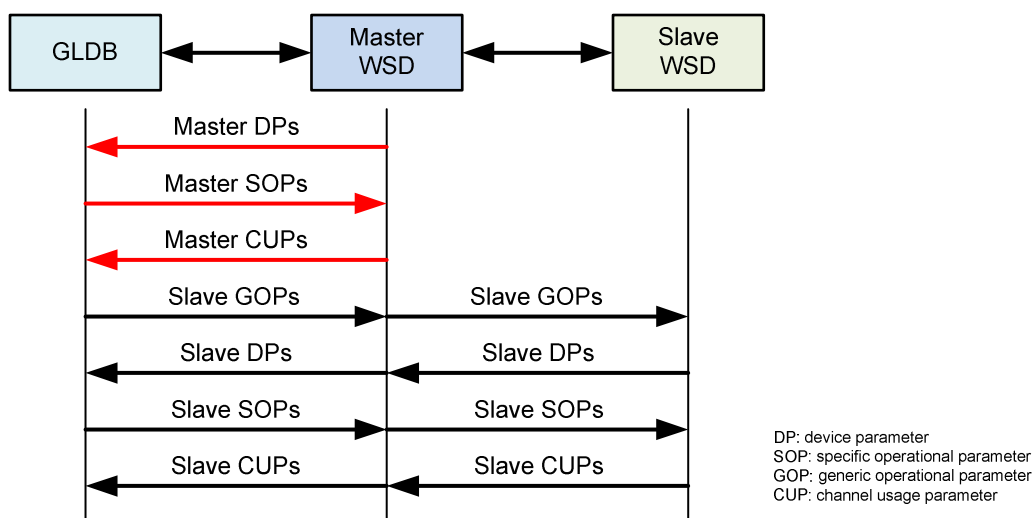

Figure 6.46: Operation procedure for uncoordinated access of white spaces

The Operation sequence between entities is shown in figure 6.46. The sequence between GLDB, master WSD and slave WSD shall be as follows:

- 1) A master WSD sends device parameter to the GLDB.
- 2) The GLDB generates its specific operational parameter and provide them to the master WSD.
- 3) The master WSD selects its specific operational parameters from GLDB and sends channel usage parameter to GLDB.
- 4) The GLDB sends slave generic operational parameters for all slave WSDs in the master WSD.
- 5) A slave WSD sends device parameters to the GLDB via the master device.
- 6) The GLDB may generate its specific operational parameters and provide them to the slave WSD via the master device.
- 7) The slave WSD selects operational parameter from its specific operational parameter and may send channel usage parameters to GLDB.

NOTE: Generic operational parameters are listed in ETSI EN 301 598 [i.5].

7 Potential Implementation Architectures

7.1 High level flow chart of entities

7.1.1 CRS operation

7.1.1.1 General description

A CRS shall support the following procedures.

- Initialization
- CRS subscription
- CRS subscription update
- CRS subscription change

- CRS registration
- CRS registration update
- Requesting CRS channel access
- Providing available channel list
- Reconfiguration request from SC to CRS
- Device parameter reconfiguration request from SC to CRS
- Providing coordination report
- CRS's operational parameters update request procedure from SC for incumbent protection
- Requesting measurement
- Providing periodic measurement
- Providing single measurement

A high level flow chart of the CRS operation is provided in figure 7.1.

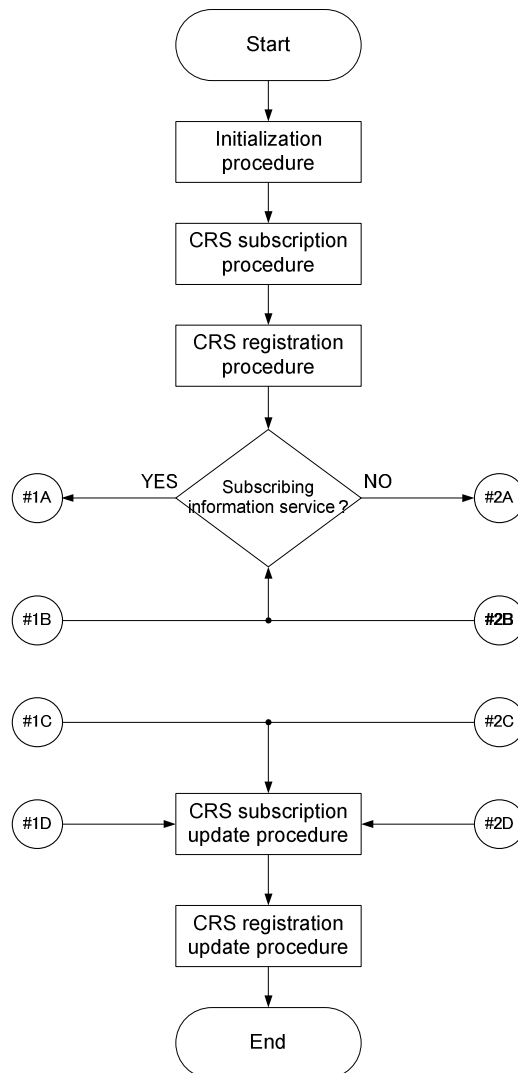

Figure 7.1: High Level Flow Chart of CRS Operation

After receiving a request to start operation, a CRS performs an initial set of procedures which are composed of initialization, CRS subscription and registration procedures. After that, the CRS switches to its operation mode in accordance with subscription service type which is either information service or management service.

In case of subscribing to the information service, the overall operation is shown in figure 7.2. The CRS is provided a coordination report by its serving SC until the coordination service subscription is stopped or changed to the management service subscription. The red lines shows normal operation loop when CRS operates in information service subscription.

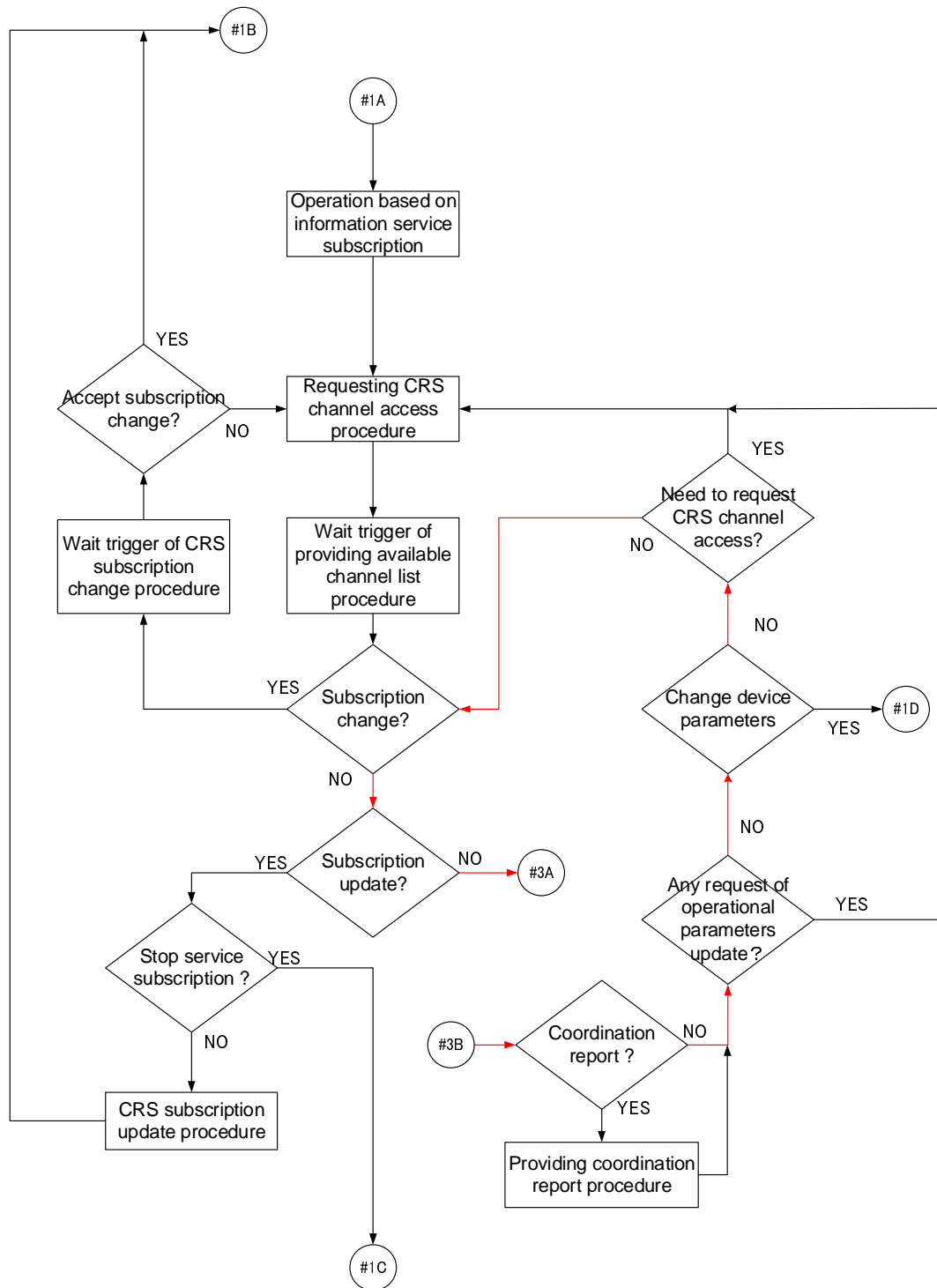

Figure 7.2: Information Service Operation

In case of subscribing to the management service, the overall operation is shown in figure 7.3. The CRS is provided reconfiguration request by its connected SC until stopping coordination service subscription or changing it to the information service subscription. The red line shows normal operation loop when CRS operates in management service subscription.

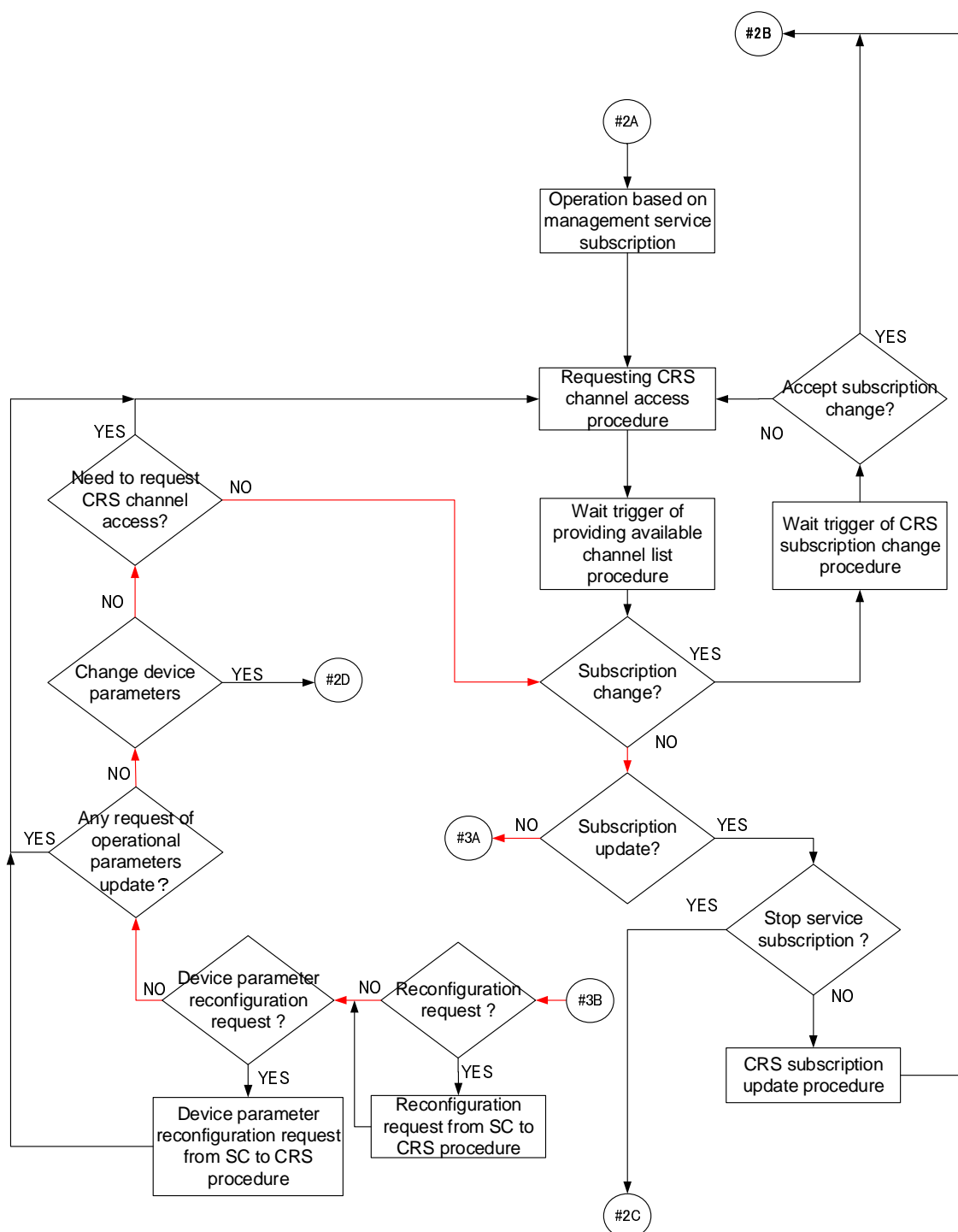

Figure 7.3: Management Service Operation

In both cases of information service and management service, if there is a request initiated by the GLDB to force the CRS to update its operational parameters, the CRS needs to request the channel access again. In both cases of information service and management service, when the CRS tries to stop its coordination service subscription to its connected SC it will use the CRS subscription update procedure and the CRS registration update procedure to unsubscribe and de-register respectively.

In both cases of information service and management service, when the CRS tries to change its coordination service subscription to its connected SC, the CRS should request the change to different type of service subscription via a CRS subscription update procedure.

Subsequently, when the SC requests a change of the type of coordination service subscription to the CRS, the CRS should respond whether or not such request is acceptable via a CRS subscription change procedure.

In both cases of information service and management service, when the CRS receives measurement request from SC, the CRS should perform the measurement procedures shown in figure 7.4.

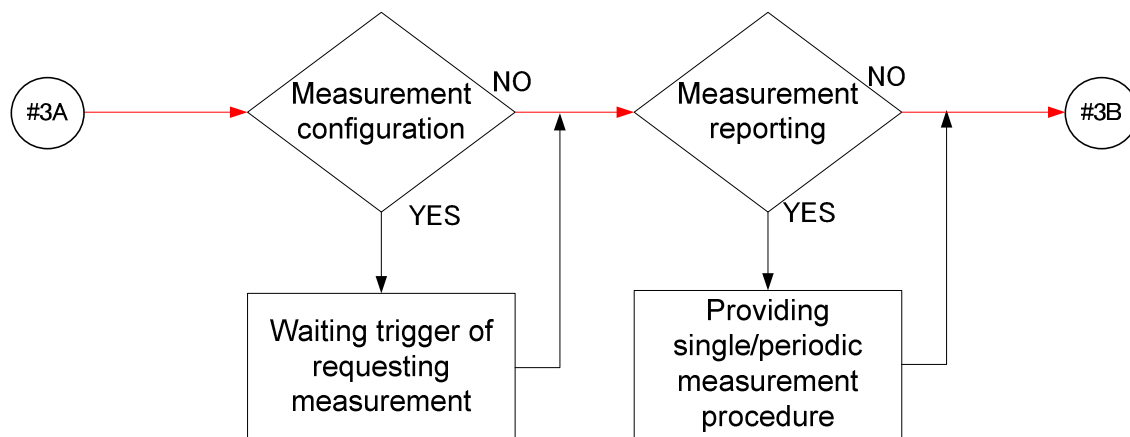

Figure 7.4: Measurements Operation

7.1.2 SC operation

7.1.2.1 General description

A SC shall support the following procedures.

- Initialization
- CRS subscription
- CRS subscription update
- CRS subscription change
- CRS registration
- CRS registration update
- SC authentication and registration
- SC de-authentication and de-registration
- Requesting SC channel access
- Providing available channel list
- Channel usage notification
- Reconfiguration request from SC to CRS
- Device parameter reconfiguration request from SC to CRS
- Priority usage checking
- Providing uncoordinated CRS information
- Providing coordination report

- CRS's operational parameters update request procedure from SC for incumbent protection
- Reconfiguration request from master SC to CRS registered to slave SC
- Master/Slave SC configuration
- Obtaining coordination set information from other SCs
- Requesting measurement
- Providing periodic measurement
- Providing single measurement

A high level flow chart of the SC operation is provided in figure 7.5.

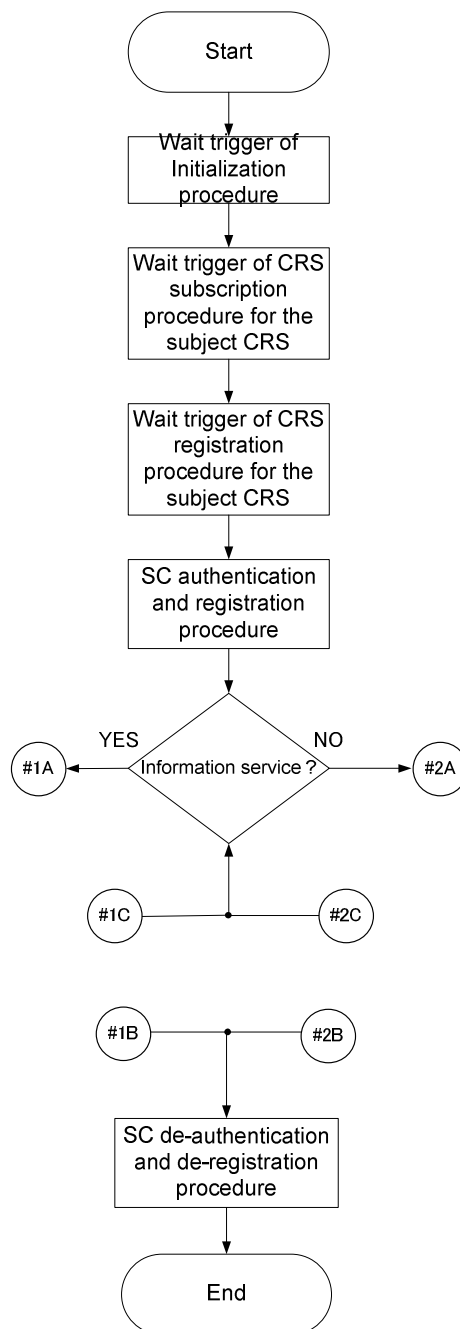

Figure 7.5: High Level Flow Chart of SC Operation

After receiving requests for initialization, CRS subscription procedure and its registration procedure from a CRS, a SC performs the SC authentication and registration procedure to GLDB and start operations using either management service operation or information service operation. In case of information service operation, the overall operation is shown in figure 7.6. Until receiving either a stop request of coordination service subscription for the subject CRS or having a need to start a coordination subscription change procedure, the SC continues to provide a coordination report to the CRS for its information service operation. In the case of any channel access request from a CRS, the SC performs the requesting SC channel access procedure, the providing available channel list procedure and the channel usage notification procedure. Red line shows normal operation loop when SC operates in information service subscription.

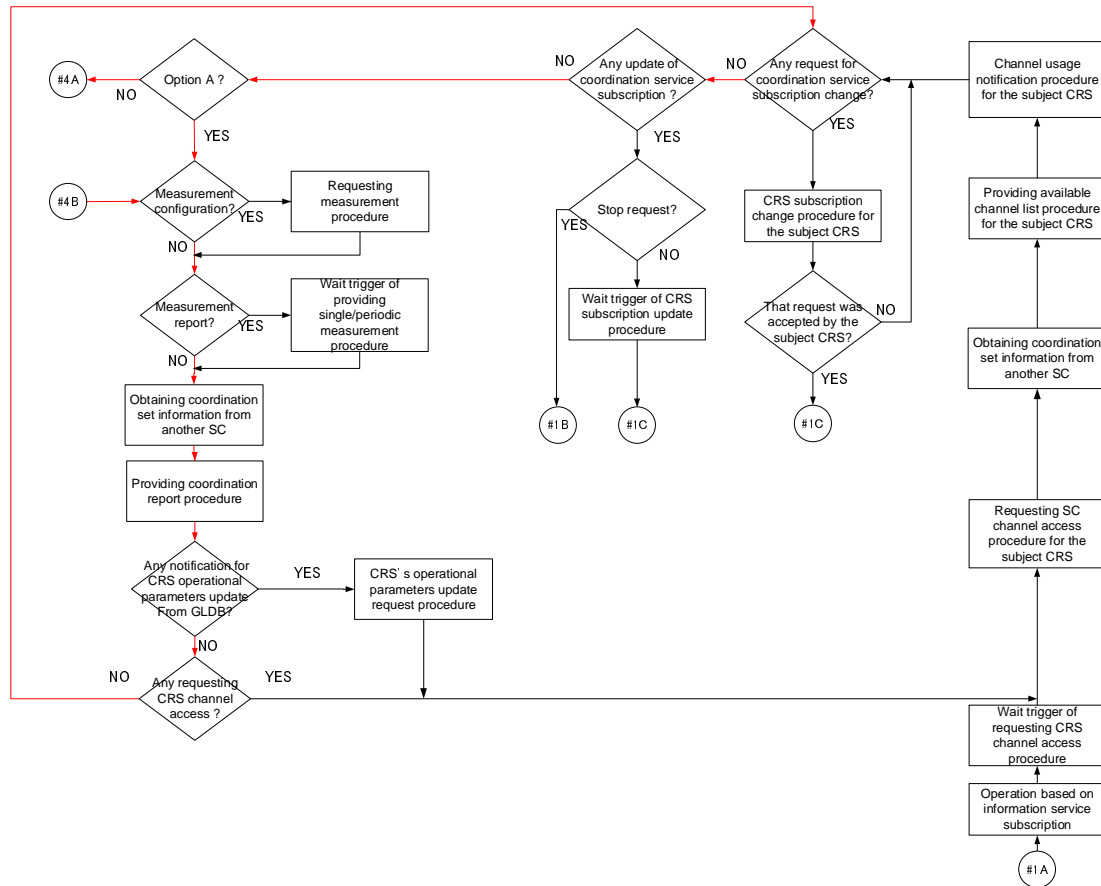

Figure 7.6: Information Service Operation

In case of management service operation, the overall operation is shown in figure 7.7. Until receiving either a stop request of coordination service subscription for the subject CRS or having a need to start a coordination subscription change procedure, the SC continues a CRS reconfiguration procedure for its management service operation. If any update needs to be made to any registered CRS information, the SC performs the reconfiguration request from SC to CRS procedure and the channel usage notification procedure for the subject CRS. If the SC receives a request of master/slave configuration procedure from the other SC(s) and accepts that request, the SC starts a sending reconfiguration request from master SC to CRS registered to slave SC procedure when the SC wants to reconfigure the operational parameters of the subject CRS being connected to its slave SC. Red line shows normal operation loop when SC operates in management service subscription. Once the SC receives the request initiated by the GLDB to force the CRS to update its operational parameters, the SC passes the request for CRS to request the channel access again.

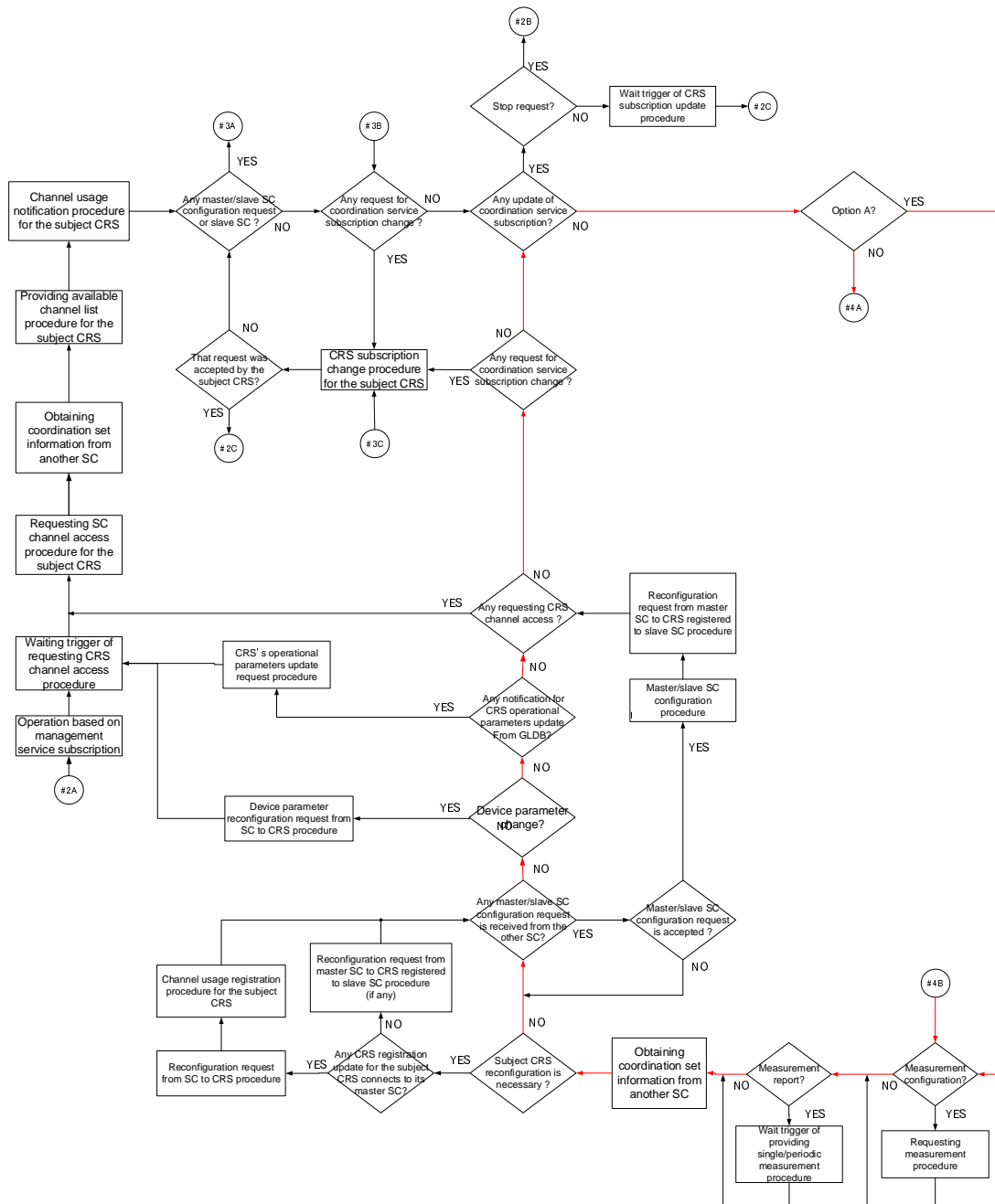

Figure 7.7: Management Service Operation

In case of management service operation as slave SC, the overall operation is shown in figure 7.8. Until receiving either a stop request of coordination service subscription or having a need to start a coordination subscription change procedure, the SC waits for a reconfiguration request from its master SC procedure and continues to conduct a CRS reconfiguration procedure for its management service operation as slave SC. If any update on its registered CRS information, the SC should perform the reconfiguration request from SC to CRS procedure and the channel usage notification procedure. If SC receives the request initiated by the GLDB to force the CRS to update its operational parameters, the SC passes the request to CRS for it to request the channel access again.

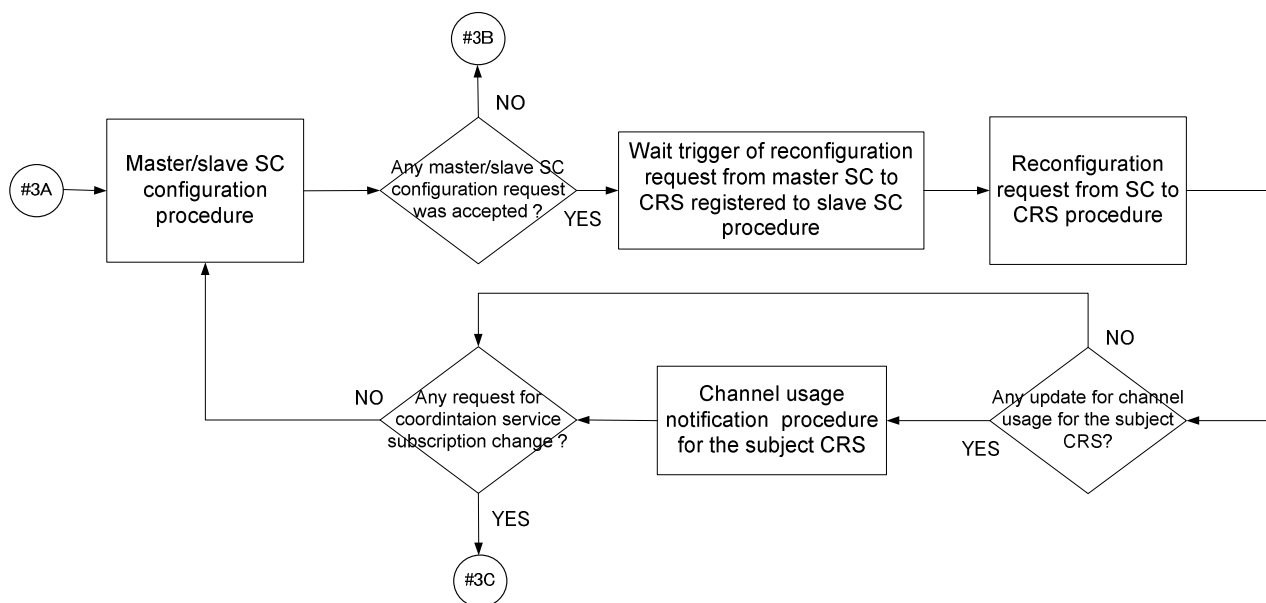

Figure 7.8: Management Service Operation as Slave SC

There are two implementation options for considering the channel usage of uncoordinated CRS operation, depending on how the protection criteria of the priority usage CRS is maintained in the system. Detail operation sequences are shown in clause 6.1.5.

Figure 7.9 shows the flow for both information service and management service for implementation option B. In implementation option A, there are no additional actions which need to be performed by the SC. In implementation option B, the SC continues to perform the priority usage checking procedure and the providing uncoordinated CRS information procedure when the SC receives requests from GLDB. If any uncoordinated CRS information from GLDB is received, the SC stores its information.

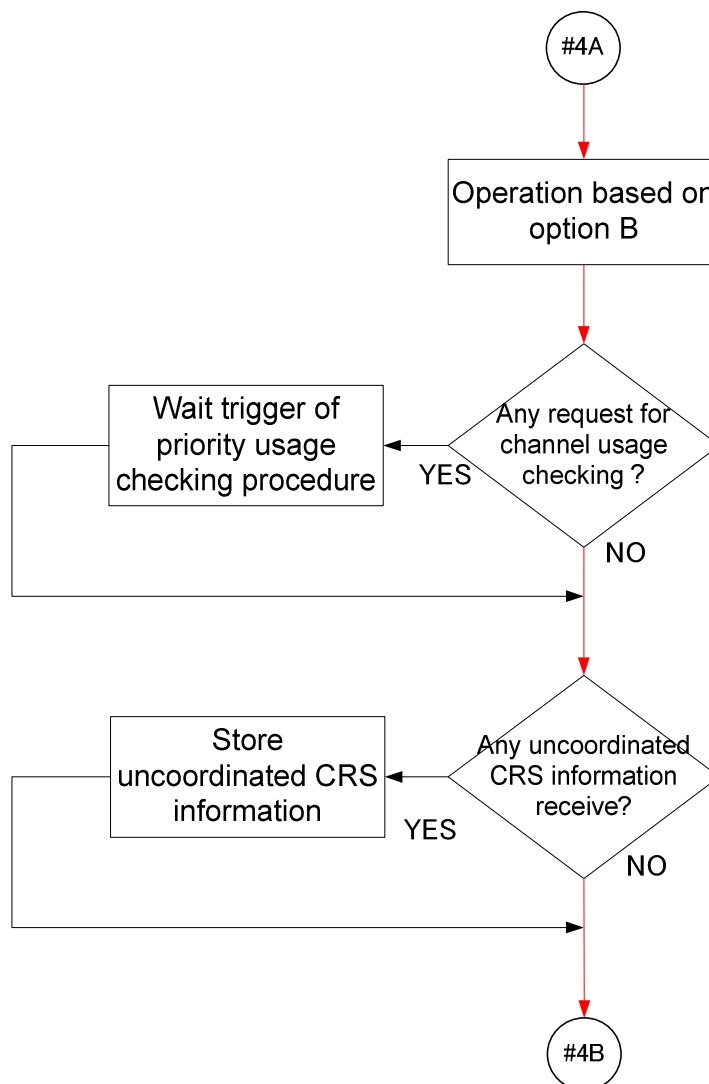

Figure 7.9: Operation Flow for Implementation Option B of clause 6.1.5

7.1.3 GLDB operation

7.1.3.1 General description

A GLDB shall support the following procedures.

- SC authentication and registration
- SC de-registration and de-registration
- Channel usage notification
- Priority usage checking
- Providing uncoordinated CRS information
- Procedure for GLDB to SC Notification for CRS operational parameters update

A high level flow chart of the GLDB operation is provided in figure 7.10.

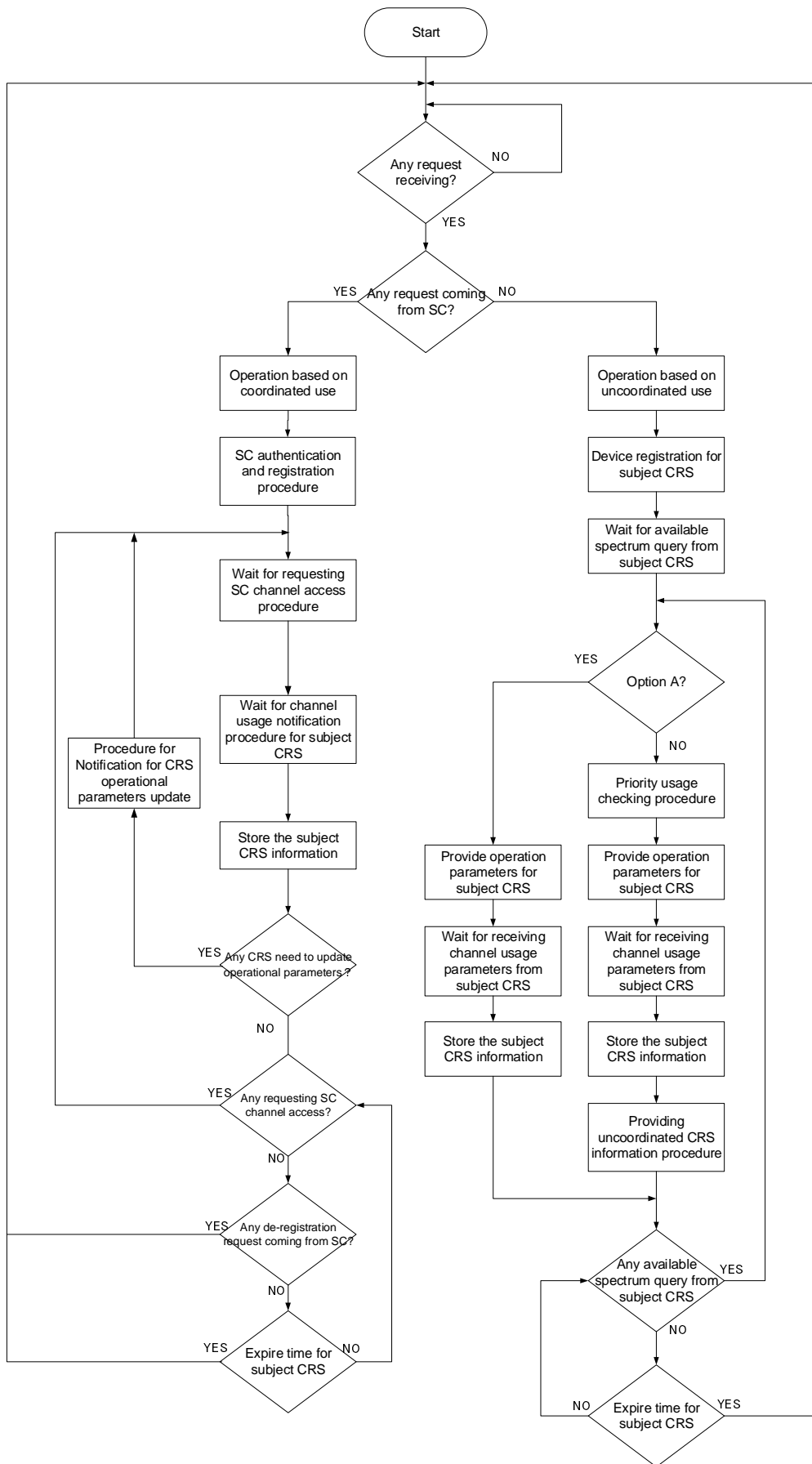

Figure 7.10: High Level Operation of GLDB

A GLDB can receive a request from either the SC or the CRS.

If the GLDB receives a request from the CRS, the request is related to the uncoordinated use of TV White Space.

In implementation option A, the GLDB calculates the related operational parameters and provides them to the CRS after the GLDB has received the available spectrum query from the CRS.

In implementation option B, the GLDB contacts the SC in order to check priority usage after the GLDB has received the available spectrum query from the subject uncoordinated CRS. After the GLDB has received the information of priority usage, it calculates the related operational parameters and provides them to the CRS. After the GLDB has received the channel usage parameters from the uncoordinated CRS, the GLDB stores them and provides the information to the SC.

If the GLDB receives a request from the SC, the request is related to the coordinated use of TV White Space.

After receiving the channel access request from the SC, the GLDB calculates the operational parameters for the CRS and provides them to the SC. This continues until the GLDB receives a de-registration request from SC or the operation time of the CRS expires. After the GLDB has received the CRS channel usage parameters, it stores them. If the CRS needs to update its operational parameters, the GLDB notify the CRS via the SC.

Annex A (informative): High Level Spectrum Management Algorithms for White Spaces

A.1 Coexistence decision algorithms

A.1.1 Algorithm based on co-channel sharing via CRS network geometry classification

A.1.1.1 Introduction

It is very important for spectrum coordination to support a common channel selection mechanism and algorithm as it enables the system to optimize the efficiency of the frequency utilization as much as possible.

There may be two cases when channel selection is made to satisfy the needs of two or more CRSs. One case is where the CRSs use different channels, and assumes there are sufficient number of channels to allow this. The other case is where co-channel sharing is used, and occurs when there are insufficient channels to assign different channels to each CRS. This clause considers only the case of co-channel sharing because the system cannot assign different channels to the CRSs.

Clause A.1.1.2 introduces one of the algorithm implementation examples for channel selection in the case of co-channel sharing. This algorithm assumes the support of the following coexistence techniques:

- Co-channel sharing using wireless network coexistence technologies (e.g. using coexistence beacon mechanism in IEEE 802.22 [i.3]) based on network geometry classification co-channel sharing using backhaul connection; and
- Co-channel sharing between CSMA and non-CSMA systems using coexistence gaps ETSI TR 103 067 [i.1].

Coexistence may take place between similar or dissimilar CRSs. Similar CRSs are CRSs that use the same RAT or different RATs with the same/common wireless network coexistence technologies. Dissimilar CRSs are CRSs that use different RATs without the same/common wireless network coexistence technologies.

A.1.1.2 Network geometry classification

Network geometry is classified in the following types:

- Type #1

Type #1 represents the case where two different CRS network coverage areas have some overlap as shown in Figure A.1.1, and each master WSD is within each other's communication range. Co-channel sharing under this network geometry type will require the coexistence protocol used by the RAT(s) to operate properly. For example, the coexistence beacon mechanism of IEEE 802.22 [i.3] will effectively work in this situation. On the other hand, if the network scheduling information exchange between the master WSDs is supported in IEEE 802.11 [i.4] based WSD(s) (so that the timing of the master WSDs is aligned), co-channel sharing will also be possible in this situation.

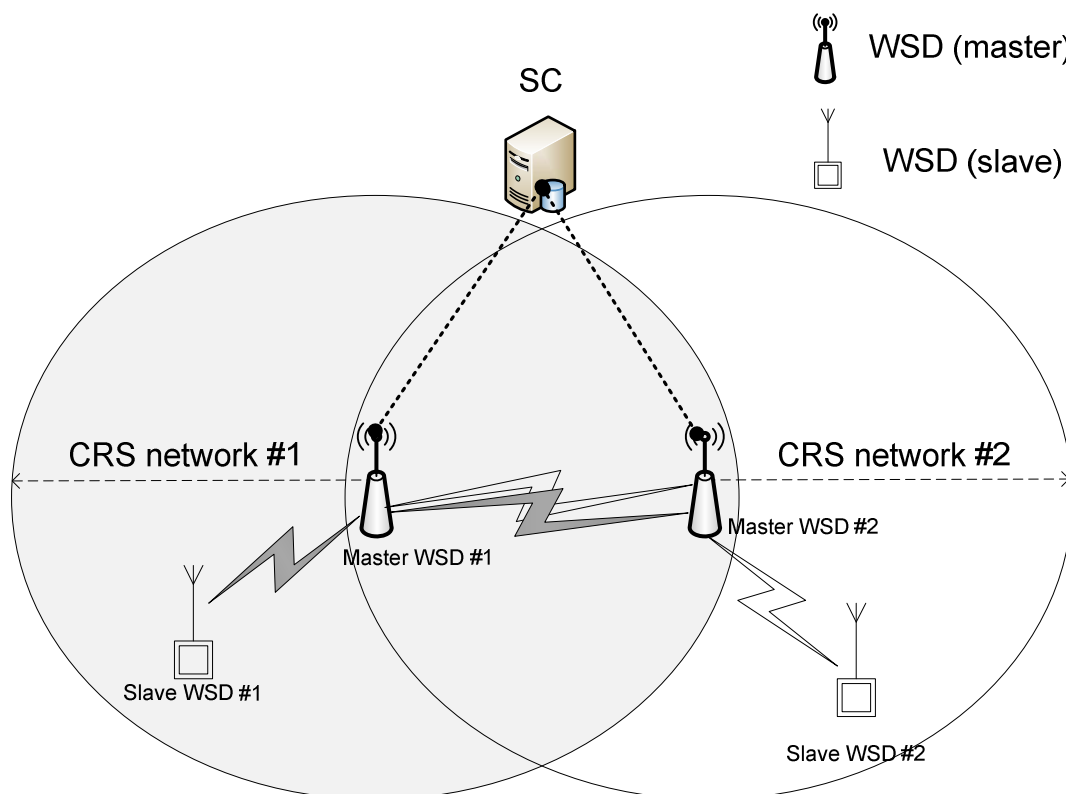

Figure A.1.1: Type#1 network geometry

- Type #2

Type #2 represents the case where two different CRS network coverage areas have some overlap, but the master WSDs are not within each other's communication range. However, some slave WSDs from one CRS may be in the communication range of another CRS's master WSD. Co-channel sharing under this network geometry type will require the coexistence protocol used by the RAT(s) to operate properly. For example, the coexistence beacon mechanism of IEEE 802.22 [i.3] will effectively work in this situation. On the other hand, if the network scheduling information exchange between the master WSDs is supported in IEEE 802.11 [i.4] based WSD(s) (so that the timing of the master WSDs is aligned), co-channel sharing will also be possible in this situation.

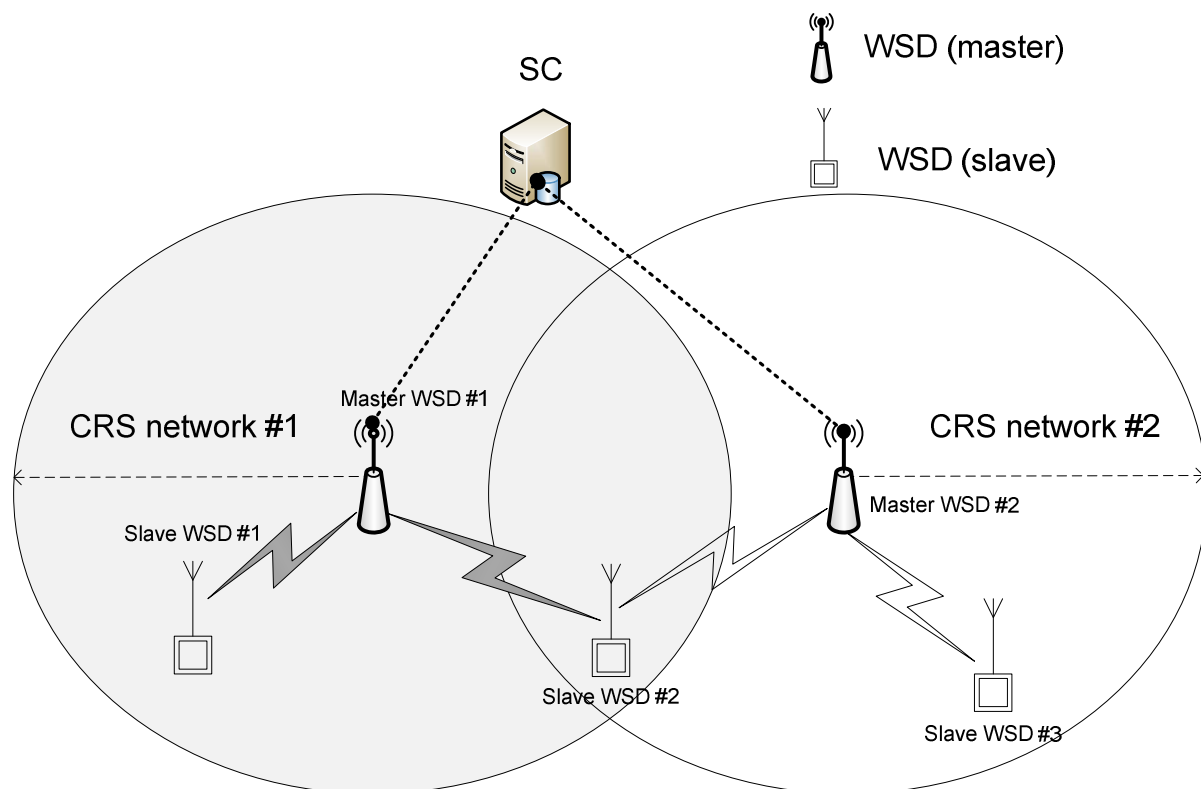

Figure A.1.2: Type #2 network geometry

- Type #3

Type #3 represents the case where two different CRS network coverage areas have no overlap as shown in figure A.1.3, and each master/slave node of the different CRSs are outside each other's communication range. If the acceptable interference level for each network is defined using its own network requirement such as the required SINR at the edge point of the expected network coverage and the value is larger than the value of the aggregated interference power from the other network, these networks will be able to share the channel with each other. On the other hand, if the acceptable interference level is smaller than the value of the aggregated interference power from the other network, these networks may be unable to share the channel with each other. In this case, if the resource sharing and synchronized operation are possible via backhaul connection or through coexistence gaps, these networks may be able to share the channel with each other in accordance with the required guaranteed QoS in conducting the coexistence management via the backhaul or through coexistence gaps. On the other hand, if the resource sharing and the synchronized operation are impossible via backhaul connection or coexistence gaps in this case, these networks will be unable to share the channel with each other.

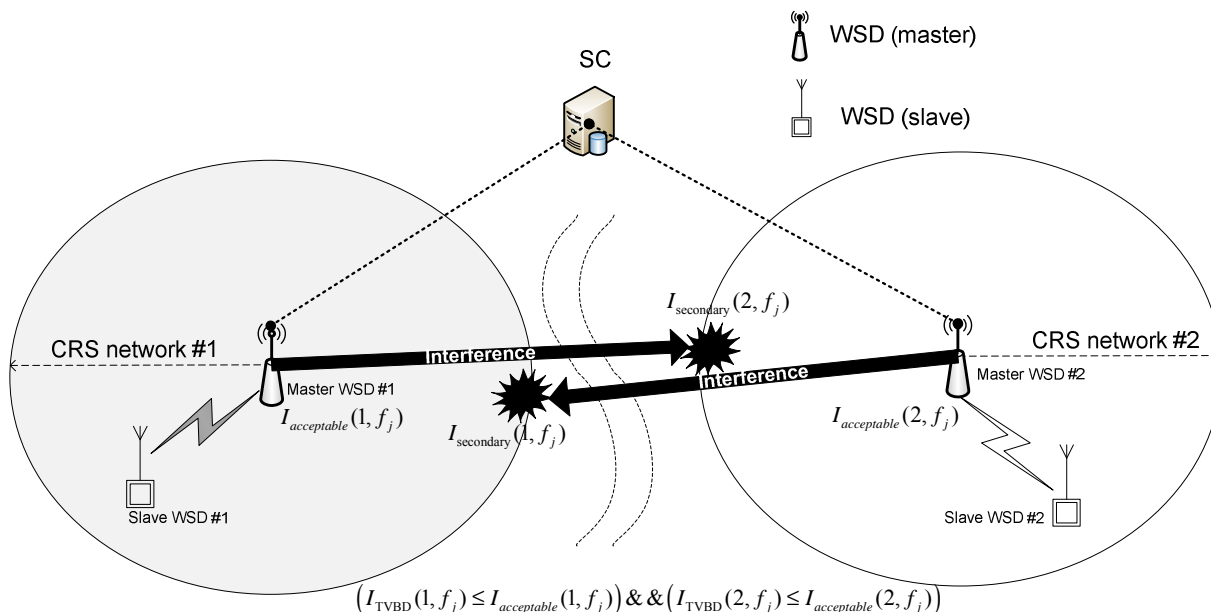

Figure A.1.3: Type#3 network geometry

- Type #4

Type #4 represents the case where two different CRS network coverage areas are overlaid, as shown in figure A.1.4. The term 'overlaid' means here that a smaller network coverage area of CRS network #2 is totally covered in a wider network area of CRS network #1. Co-channel sharing under this network geometry type will require the coexistence protocol used by the RAT(s) to operate properly. For example, the coexistence beacon mechanism of IEEE 802.22 [i.3] will effectively work in this situation. The master/slave WSD(s) in the overlapping area can receive the NAV (Network Allocation Vector) information from the other network(s), so this can also be used to allow co-channel sharing in this situation. However, if the interference power from CRS network #1 to CRS network #2 is too high for network #2 operation co-channel sharing may not be possible.

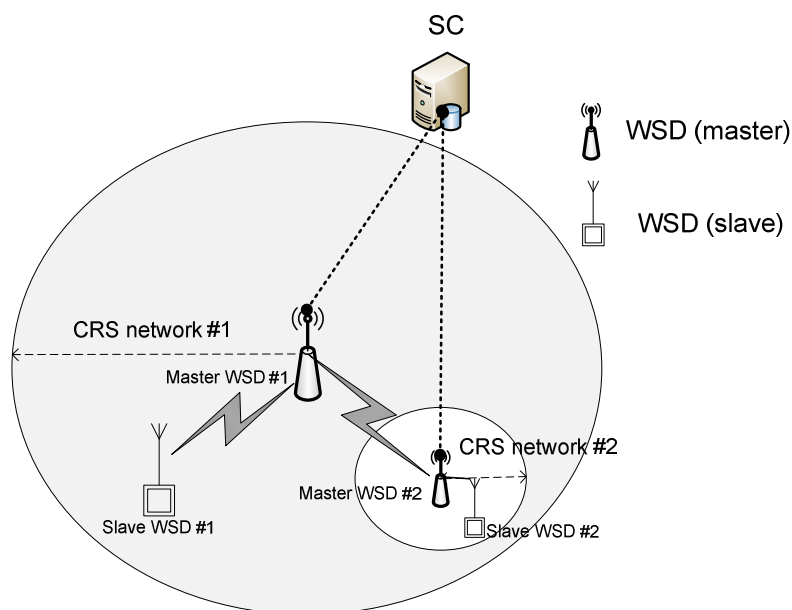

Figure A.1.4: Type#4 network geometry

A.1.1.3 Algorithm description

Figure A.1.5 shows the channel selection procedure.

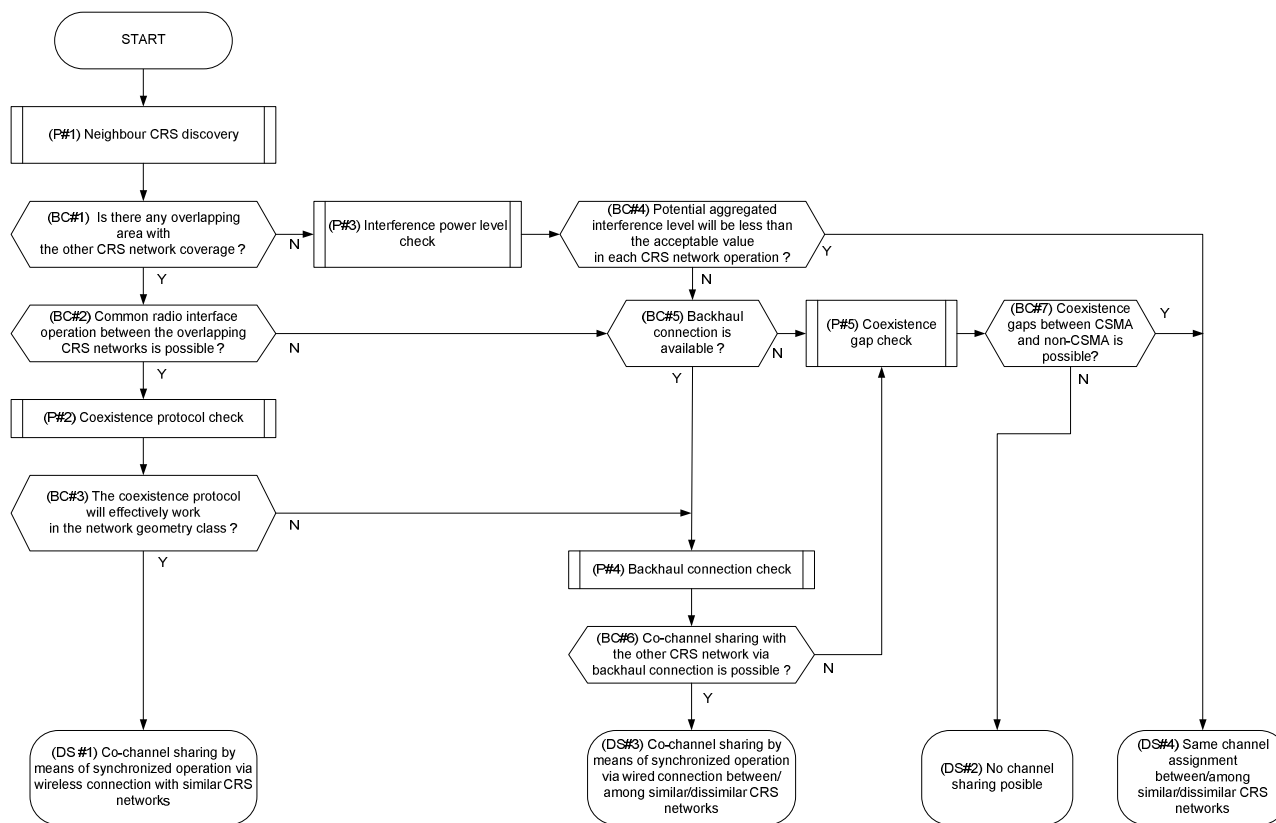

Figure A.1.5: Co-channel sharing procedure

The final decision statuses are as following:

- (DS#1): Co-channel sharing by means of synchronized operation via wireless connection with similar CRS network
- (DS#2): No channel sharing possible for the target CRS
- (DS#3): Co-channel sharing by means of synchronized operation via backhaul connection between/among similar/dissimilar CRS networks
- (DS#4): Same channel assignment between/among similar/dissimilar CRS networks with or without the use of coexistence gaps

The processes are as follows:

- (P#1): Neighbour CRS discovery

The SC can determine the neighbour CRS network geometry classification from CRS registration information. The network geometry classification is specifically utilized in the coexistence protocol check process (P#2).

- (P#2): Coexistence protocol check process

This process checks whether or not the coexistence protocol for the specified RATs can effectively work in the network geometry type. The result of this process is utilized in the final decision making process of whether or not co-channel sharing by means of synchronized operation via wireless connection with similar CRS network is possible.

- (P#3): Interference power level check process

This process will be conducted using the CRS tolerable interference power level information and the result of this process is utilized in the decision making on co-channel sharing with the other CRS network.

- (P#4): Backhaul connection check process

This process will be conducted using the guaranteed QoS information and is necessary for the decision making on co-channel sharing with the neighbour CRS network. There will be several criteria for checking the ability for using a backhaul connection, but the following aspect will be at least necessary: ascertain whether the required minimum bit rates and the required communication latency can be satisfied in conducting co-channel sharing via backhaul connection with the similar/dissimilar CRS network.

- (P#5): Coexistence Gap Check Process

This process checks whether the two CRSs that wish to coordinate consist of a CSMA system and a non-CSMA system, and that the non-CSMA system supports coexistence gaps, as defined in ETSI TR 103 067 [i.1].

The branch conditions are as follows:

- (BC#1): This branch condition will be conducted based on the result of the network geometry classification process. If the network geometry classification is type#1/type#2/type#4, go to BC#2. If not, go to P#3.
- (BC#2): This branch condition will be conducted based on the capability of the operable radio interface of the target CRS networks. If the same radio interface can utilize in all the target CRS networks, go to P#2. If not, go to P#4.
- (BC#3): This branch condition will be conducted based on the coexistence protocol check. If the co-channel sharing via wireless link is possible, go to DS#1. If not, go to P#4.
- (BC#4): This branch condition will be conducted based on the result of mutual interference power level check process. If the co-channel sharing does not cause the harmful interference for the other CRS network operation, go to DS#4. If not, go to P#4.
- (BC#5): This branch condition will be conducted based on the backhaul connection check. If the backhaul is available, go to P#4. If not, go to P#5.
- (BC#6): This branch condition will be conducted based on the result of backhaul connection check process. If the co-channel sharing is possible, go to DS#3. If not, go to P#5.
- (BC#7): This branch condition will be conducted based on the result of the Coexistence Gap Check Process. If coexistence of the two CRSs through the use of coexistence gaps is possible, go to DS#4. If not, go to DS#2.

A.1.2 Control of spectrum utilization based on the number of CRSs

A.1.2.1 Introduction

The spectrum coordinator (SC) which manages the CRSs such as small cells over an area, e.g. a residential area, can obtain the available spectrum and EIRP (operational parameters) for a different number of CRSs assuming their random locations within the management area. From this information, the SC can calculate the each CRS's individual capacity as well as the sum capacity of all CRSs taking into account the interference among these CRSs. Knowing that each CRS may use one out of the available channels and implement self-neighbouring interference avoidance mechanism (e.g. avoiding co-channel operation with the neighbouring CRSs), the SC can predict both individual and sum capacities of CRSs for a given number of CRSs, EIRP of each CRSs and the number of their assigned channels. Given the expected QoS from the CRS, the SC can determine the minimum number of assigned channels and EIRP to CRSs while achieving a satisfactory QoS of individual CRS and sum capacities of CRSs.

A.1.2.2 Flowchart of the algorithm

The flowchart of the algorithm is shown in figure A.1.6. The SC uses the procedure in clause 6.1.4.2 *Requesting SC channel access procedure* to obtain operational parameters for all possible locations and different number CRSs within the a management area of CRSs. Secondly, from the procedure in clause 6.1.4.1 *Requesting CRS channel access procedure*, the SC receives the operational parameters request from one or multiple CRSs. Using the procedure in clause 6.1.4.2 *Requesting SC channel access procedure* the SC confirms the operational parameters as it has previously obtained. Before sending the operational parameters to the requesting CRS, the SC checks the current spectrum utilization of operating CRSs. Note that there could be CRSs finished spectrum utilization. Based on the number of CRSs, the SC can decide the minimum number of assigned channels and EIRP for the CRSs in order to achieve expected individual QoS and a satisfactory sum capacity. Then, using the response message in clause 6.1.4.1 *Requesting CRS channel access procedure* the SC inform the requesting CRS its operational parameters and using the procedure in clause 6.1.7.1 *Reconfiguration request from SC to CRS procedure*, the SC sends the updated operational parameters to the CRSs.

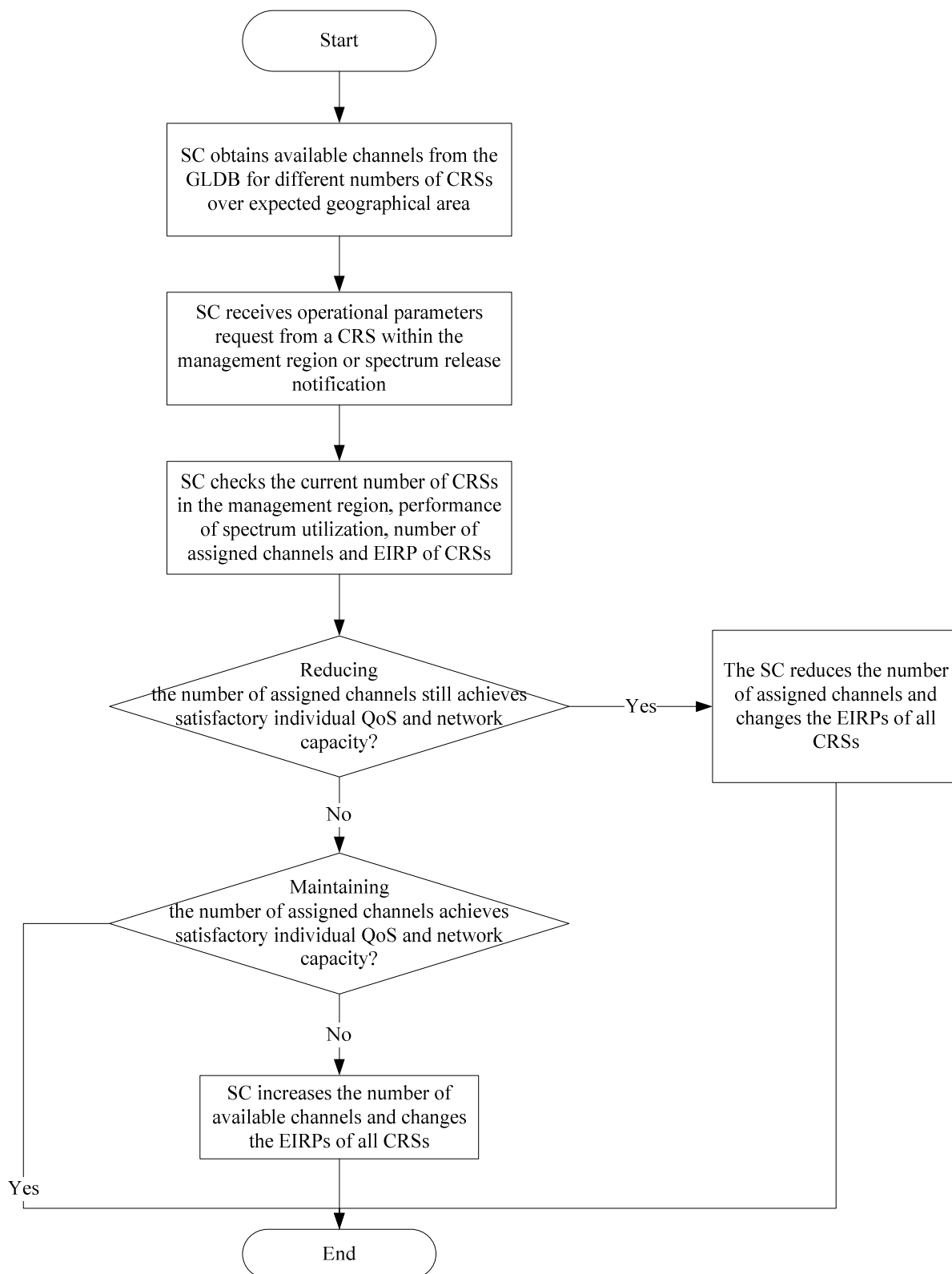

Figure A.1.6: Flowchart of Algorithm

A.1.3 Control of coordinated CRSs for reduced transmit power fluctuation

A.1.3.1 Introduction

The maximum transmit power of a CRS is determined for a particular location under the constraint of incumbent protection. When the location of a CRS changes, the maximum transmit power changes as well. If a CRS always transmits according to this location-specific transmit power limit, the power of its signal varies when the CRS's location changes. Such changes lead to frequent reconfiguration of the CRS's transmission and big fluctuation of the interference power to its neighbouring CRSs. This change occurs not only when the CRS's location changes but also when neighbouring CRSs' locations change as the maximum transmit power limit is dependent on the aggregate interference from all CRSs to the incumbent.

Knowing the expected geographical range of movement during operation, the SC can obtain a set of all available spectrum, e.g. EIRPs for a CRS's all potential location the EIRP can be obtained. Let the value of x %-EIRP be defined as that in which x % of the EIRPs for a set of locations in the range of movement are smaller than this value. For example, if the CRS uses the 10 %-EIRP value there is a 90 % of time that the actual EIRP calculated for the particular location of CRS is larger than the x %-EIRP when the CRS is moving within the reported geographical area. This means that by 90 % of time, the CRS can keep a constant EIRP and does not need to perform reconfiguration. Clause A.1.3.2 gives the procedure of SC operation of managing the CRS to use this x %-EIRP as an example.

A.1.3.2 Flowchart of the algorithm

The flowchart of the algorithm is shown in figure A.1.7. First, using the procedure in clause 6.1.4.1 *Requesting CRS channel access procedure*, the SC receives the channel request information from one or multiple CRSs. The messages contain the locations of CRSs as well as the expected geographical area of movement during operation. The SC uses the procedure in clause 6.1.4.2 *Requesting SC channel access procedure* to obtain available channels for all possible locations within the expected geographical area of CRSs. Subsequently, the SC examines the distribution of the maximum EIRPs for all possible location and determines an x %-EIRP value. The SC then compares the actual EIRP for the current locations of the CRSs with the x %-EIRP value. If the x %-EIRP value is lower than the actual EIRP, the SC informs the CRS to use the x %-EIRP instead of the actual EIRP by the response message in clause 6.1.4.1 *Requesting CRS channel access procedure*. If the actual EIRP is lower than the x %-EIRP value, the SC informs the CRSs to use the actual EIRP values. Note that the same CRS will request channel again when its location changes and it is still within the previously reported expected area of operation, the SC does not need to calculate a new x %-EIRP value.

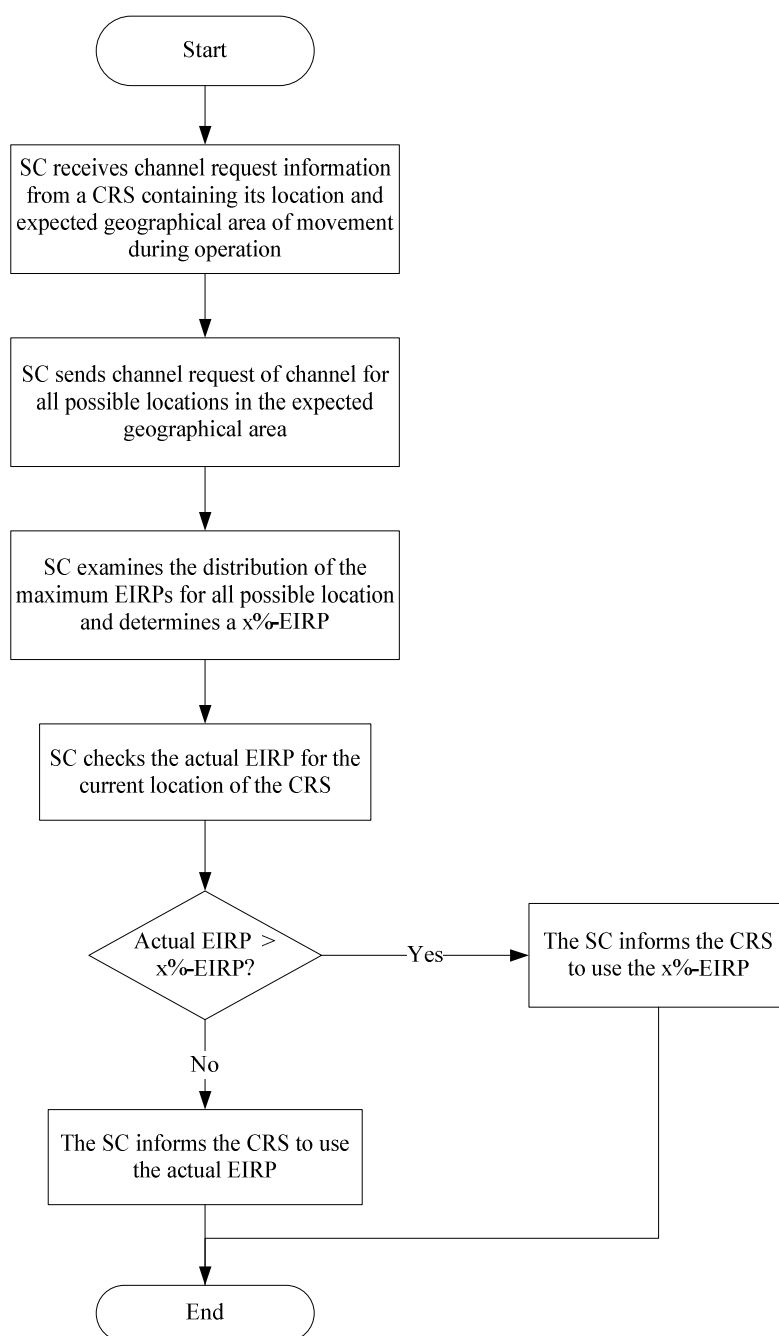

Figure A.1.7: Flowchart of the algorithm

A.1.4 Spectrum rearrangement among CRSs

A.1.4.1 Introduction

The available spectrum of a CRS is determined taking into account the spectrum usage pattern of existing CRSs under the constraint of incumbent protection. That is, the incumbent and the existing CRSs jointly provide strong constraints to the investigated CRSs in obtaining spectrum resources. With the wireless network operating, the released spectrum resource of some CRSs may not be used by any other CRSs, due to current spectrum usage limit. Consequently, the system bears dramatically increasing consumption if reassignment and reconfiguration of spectrum resources for all CRSs occurs. This raises the need to design efficient resource reassignment scheme.

This algorithm presents a practical solution for reshuffling the spectrum resource among as less CRSs as possible to increase the spectrum utilization efficiency while reducing the system reconfiguration complexity. Note that the process may also implement constraints on the QoS of individual CRSs. Start by constructing an elegant mathematical modelling, termed spectrum transition graph, to integrate all the spectrum usage information of CRSs and thus generate the correlation among them. With this starting point, the connection is established between spectrum rearrangement problem and graph theory. Therefore, graph theory can be utilized to solve the spectrum reassignment according to different system optimization targets flexibly, especially when we explore hyper-dense CRSs network. As an example, clause A.1.4.2 gives the procedure of SC operation of reshuffling spectrum among the CRS by selecting directed path within the relative spectrum transition graph.

A.1.4.2 Flowchart of the algorithm

The flowchart of the algorithm is shown in figure A.1.8.

Firstly, the spectrum rearrangement algorithm could be launched by SC in any of the following conditions. Case 1 the spectrum released by some CRS cannot be allocated to the CRS which requires resource without bringing harmful interference to the incumbent or other CRSs. Case 2 there exists CRS, which cannot be allocated any spectrum in long time duration without harmful interference to existing spectrum usage state of other systems.

Secondly, the SC obtains available spectrum list and used spectrum list of each CRS. The available spectrum list includes all available spectrums for any CRS and is determined according to the CRS's location by the GLDB. The used spectrum list includes all spectrums which are currently occupied by the corresponding CRS.

Thirdly, the SC generates spectrum transition graph to integrate all the obtained information. One example spectrum transition graph G is shown in figure A.1.9. Where, each vertex v represents a CRS; any two CRSs v_i and v_j are connected by a directed arc, namely $v_i \rightarrow v_j$, if and only if the spectrum within the used spectrum list of the tail vertex CRS v_i belongs to available spectrum list of the head vertex CRS v_j but has not been involved in the used spectrum list of v_j ; the corresponding spectrum, represented as CH_{v_i} , is the first element of the weight for the arc; the second element of the weight, represented as ΔTH_{v_i} , describes difference of the throughput when the CH_{v_i} is respectively used by v_i and v_j with their maximum EIRPs.

Then, SC determines rearrangement strategy by selecting directed path from source vertex CRS to terminal vertex CRS within the pre-generated spectrum transition graph. Where, source vertex CRS v_s represents the CRS which releases spectrum, and the terminal vertex CRS v_t represents the CRS which requires resource but cannot use the released spectrum directly. The directed path is constrained by the target performance requirements. For example, if the number of reconfigured CRSs is minimized, then the directed path with shortest length starting from v_s and ending at v_t should be selected. The length of a directed path is the number of arc along the path. Another example, if the expected system throughput is maximized, then the directed path with maximized sum of ΔTH_{v_i} value along the directed path should be selected.

At last, the system is reconfigured by reallocating the spectrum on the arc from tail vertex to head vertex along the directed path using the procedure in clause 6.1.7.1 Reconfiguration request from SC to CRS procedure.

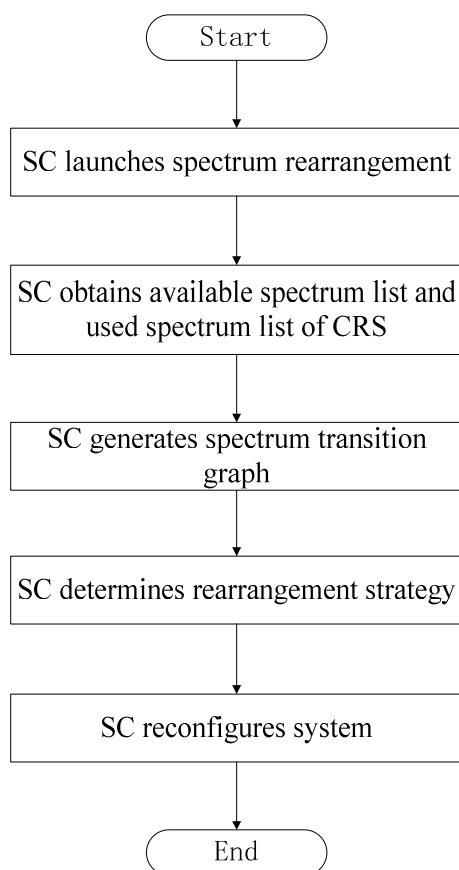

Figure A.1.8: Flowchart of the algorithm

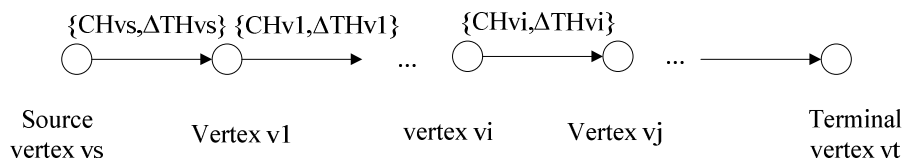

Figure A.1.9: Example transition graph

A.1.5 Resource allocation based on channel ranking

A.1.5.1 Introduction

The available spectrum of a CRS is determined taking into account the spectrum usage pattern of existing CRSs under the constraint of incumbent protection. Although all available channels can satisfy a given CRS's requirement, selection of specific channels can have an overall benefit. This raises the need to design sophisticated resource allocation scheme.

This algorithm presents a fine-grained resource allocation solution that ranks available spectrum for a certain CRS according to prospective impact of their usage to the incumbent. The metric of interest in the algorithm is the interference incurred to the incumbent when the channel is used by the CRS with a pre-assumed power level. In particular, the lower interference is caused to the incumbent, the higher value is given to a resource allocation of an available channel for the CRS. Clause A.1.5.2 gives the procedure of utilizing the ranking results to select the channel to be used by the CRS, and resolve contention when multiple CRSs request a channel for priority use and the number of available channels is not sufficient.

A.1.5.2 Flowchart of the algorithm

The SC receives the GLDB available channels list after a CRS sends its location to the GLDB via the SC. Then, the SC ranks the available channels according to amount of interference that would be caused by the allocation of that particular channel. After the SC provides the ranked channel list to a CRS the CRS is able to select channel for use according to the following algorithm, whose flowchart is shown in figure A.1.10.

The channel selection algorithm comprises four steps. Step 1, the SC sorts the available channels in increasing order to interference caused to the incumbent and send this channel list to the CRS. Step 2, each CRS selects the first channel in the ordered sequence. Step 3 each CRS estimates if the selected channel with its maximum EIRPs can satisfy the bandwidth request or not. If the selection can satisfy the request, end the algorithm; otherwise go to step 4. CRS selects the next available channel in the sequence and go back to step 3 to perform the estimation again. The algorithm iterates until the request has been satisfied or all the available channels have been considered.

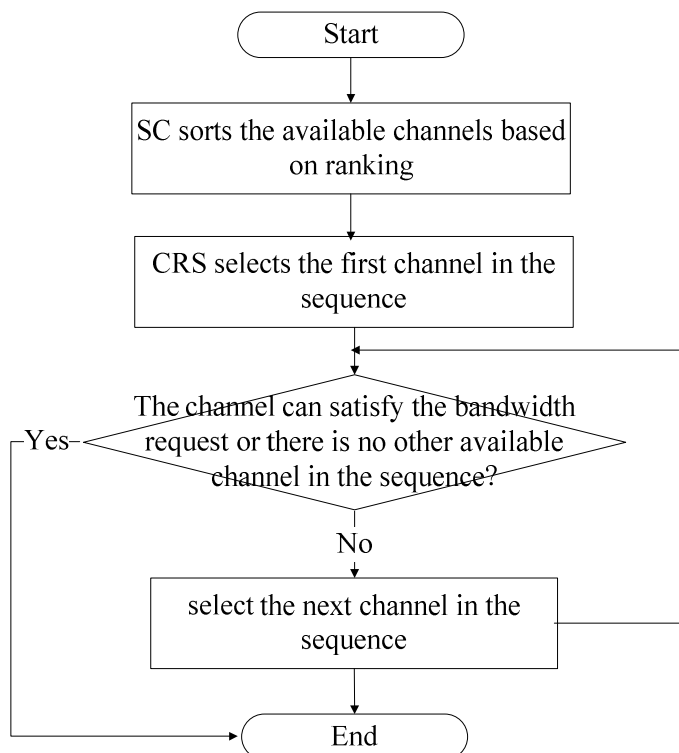

Figure A.1.10: Flowchart of the algorithm

If the CRS subscribes to the information service, the above procedure itself is implemented at the SC. If the CRS subscribes to management services, the above procedure can be used together with the following procedure which is also implemented at SC. Each CRS selects a channel from the ranked list and report back to SC the selection result.

Subsequently, to guarantee QoS requirements of certain CRSs, the SC will estimate if contention occurs based on their feedback information of channel selection results sent by the CRS. When the number of available channels is not sufficient, the SC can resolve contention when multiple CRSs request a channel for priority use according to the following backoff-based power allocation mechanism, whose flowchart is shown in figure A.1.11. Finally, the SC will use the reconfiguration procedure in clause 6.1.7 to instruct the CRSs to change their channel usage.

The backoff-based power allocation mechanism comprises four steps. Step 1 allocates the maximum EIRPs as initial power levels for every contending CRSs. Step 2 estimates SINR performance for each of the CRS. If all expected SINR with the allocated power level are acceptable, that is to say higher than the predetermined thresholds, then end the algorithm with the power allocation results; otherwise go to step 3 to check if power levels can be decreased. If no power level is able to be decreased, then end the algorithm with result that the contending CRSs cannot coexistence on the requested channel; otherwise go to step 4 to decrease the power levels for CRSs according to the aforementioned spectrum resource utilization efficiency. The higher the value is, the less power level is decreased. The decreasing step size can be adjusted according to different coexistence mechanisms among the contending CRSs flexibly. Then, go back to step 2 and to perform the estimation again.

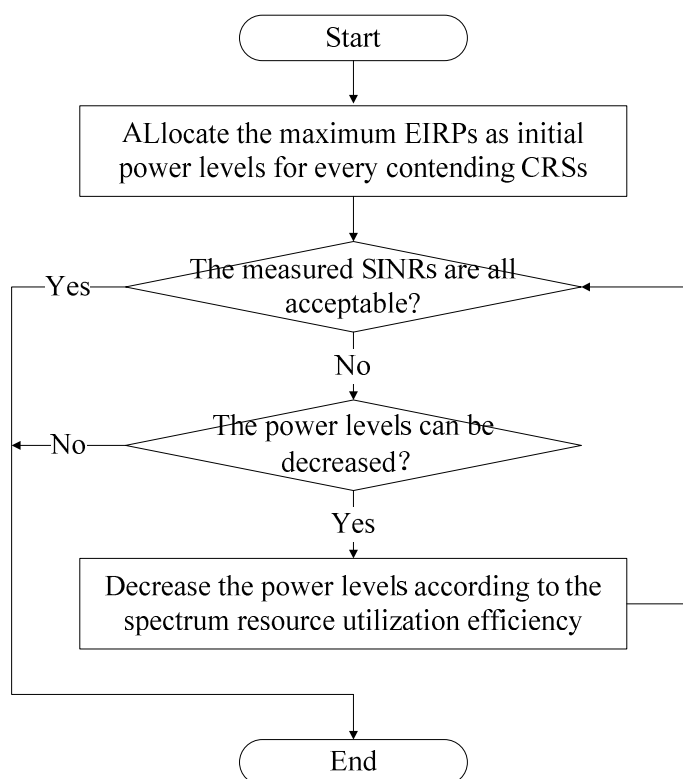

Figure A.1.11: backoff-based power allocation mechanism

A.2 Priority access management algorithms

A.2.1 Control of non-priority access CRSs for CRS with priority access

A.2.1.1 Introduction

Priority access allows a CRS operate in a channel for a specific reservation period and in a specific area based on particular minimum protection requirements of the CRS. CRSs assigned such channels with therefore have priorities over other CRSs. The priority access of a particular channel means reducing spectrum usage (such as transmit power) of those CRSs without priority access on the same channel in order to guaranty the protection requirements, for example but not limited to SINR, of a CRS with priority access. Reducing spectrum usage of non-priority-access CRSs brings two effects to the CRS with priority access on that channel. The first effect is a direct reduction of interference from the CRS without priority access to the CRS with priority access. The second is a reduction of the interference from the CRSs without priority access to the incumbent. This allows an increase of the maximum EIRP of the CRS with priority access while keeping protection to incumbent. These two effects are dependent on the pathloss between the CRS with priority access and the CRS without priority access, between the CRS with priority access and the incumbent, as well as between the incumbent and the CRS without priority access. Since these CRSs without priority access in different channels may at different locations, considering the above pathloss information in the channel selection for priority access can be useful. The algorithm below described gives a method to select a channel to achieve the best performance of the CRS with priority access.

A.2.1.2 Flowchart of the algorithm

The flowchart of the algorithm is shown in figure A.2.1. The algorithm can be used based on the procedures in clauses 6.1.7.7 General Priority-Based Channel Reconfiguration Sequence and 6.1.7.9 Priority Usage Request Considering Uncoordinated Channel Usage. Upon receiving the spectrum usage request as well as the expected performance, for example, signal-to-interference-plus-noise ratio (SINR) of the CRS with priority access, the SC will obtain the operational parameters and the incumbent location for protection of this specific CRS from the GLDB. Here, the certain SINR is used to describe the requirement of the CRS with priority access. The SC has information of the existing CRSs. For example, the coordinated CRS without priority access information is stored in SC. With the Providing uncoordinated CRS information procedure in clause 6.7.1.9, the SC has the information of the uncoordinated CRS such as the location as well as the spectrum usage. Based on the information and the channel gains between different locations of incumbent, the CRS with priority access and those CRS without priority access, the SC can determine how to modify spectrum usage of the existing CRSs without priority access that gives the maximum improvement of the SINR can be achieved by the CRS with priority access due to the direct reduction of the interference from the CRS without priority access and the increase of transmit power of the CRS with priority access itself. For example, in the procedure given in clause 6.1.7.9, some of the uncoordinated CRSs' operational parameters such as maximum EIRP could be changed. This is achieved when those CRSs reconfirm their spectrum validity. The GLDB can inform them that the spectrum is not available anymore. Once the modification on the spectrum usage of the uncoordinated CRSs is done, the interference to the CRS with priority access is reduced. Further, the reduction of interference from the uncoordinated CRS to the incumbent allows increase of the spectrum usage such as the maximum EIRP at the coordinated CRS. This increases the SINR of the coordinated CRS. After such modification on the operational parameters of CRSs without priority access is executed, the updated operational parameters can be obtained when the CRS with priority access contacts the GLDB to obtain new operational parameters.

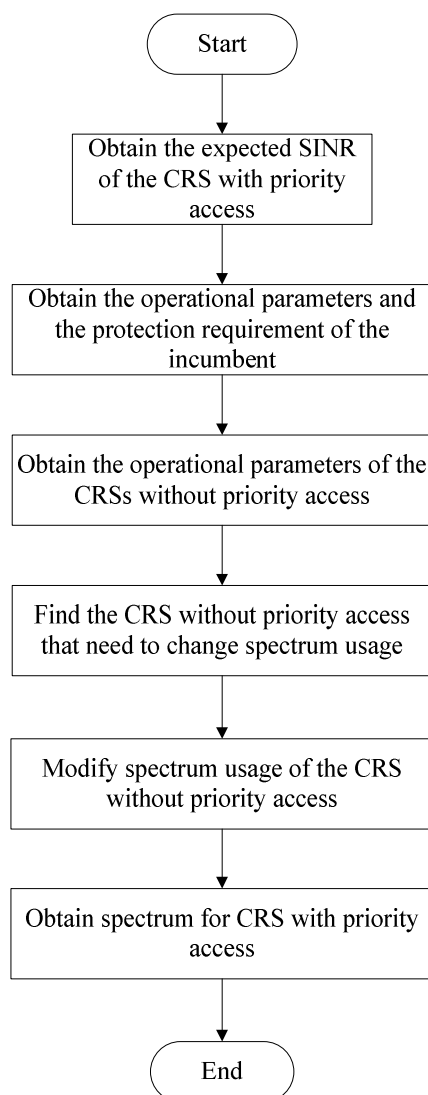

Figure A.2.1: Flowchart of the algorithm

Annex B (informative): Possible Physical implementation examples of logical functions in coordinated usage of white spaces

B.1 Possible Physical implementation examples

B.1.1 Third party database management

There will be several possible deployment scenarios for the geo-location function (calculation engine) of location specific output power level. For example, the geo-location function may be a part of the GLDB controlled by an NRA, or a geo-location function separated from the GLDB managed by NRA as shown in figure B.1.1. In the case where it is a separate geo-location function, a third party should take the responsibility to protect the incumbent service receivers from an aggregated interference problem, and the operation should be kept under surveillance by the NRA. This would enable the processing load of the GLDB managed by NRA to be offloaded to the third party database. Such third party database may provide other functions, such as spectrum coordination to the WSDs operating in the same area. In this case, the physical interface between the WSD/WSD network and the third party database will support the reference point A and B. Reference point D would be located between the spectrum coordination function and the geo-location function within the third party database. The physical interface between the regulatory database and the third party database can use existing SAPs and the NRA will define if common physical interface is needed.

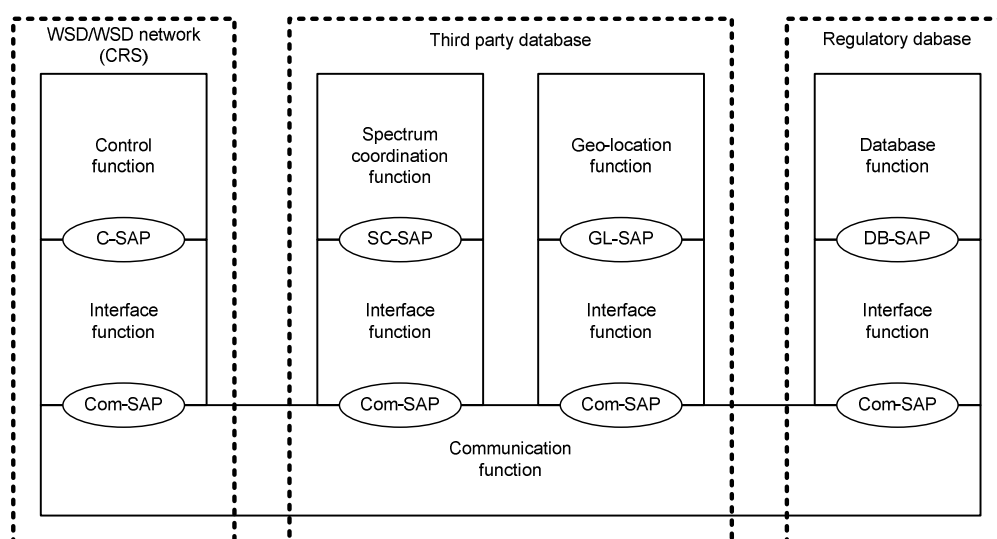

Figure B.1.1: Third party database management

B.1.2 GLDB with spectrum coordination function

There will be several possible deployment scenarios for the spectrum coordination function. Figure B.1.2 shows the case when the GLDB has also the spectrum coordination function. It may be possible for the spectrum coordination function to be implemented in the GLDB controlled by the NRA as the regulatory database. In this case, there is one physical interface in the system. The physical interface between the WSD/WSD network and the regulatory database will support the reference points A and B.

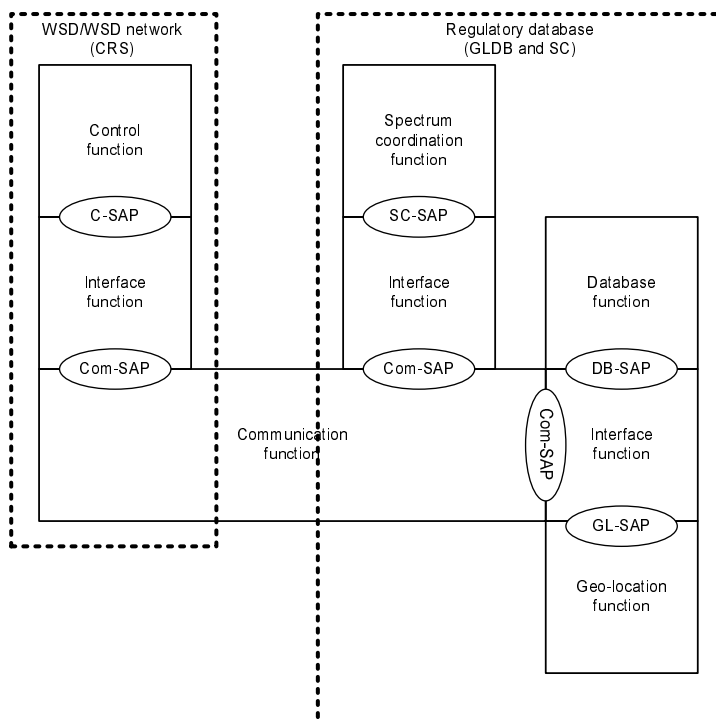

Figure B.1.2: GLDB with spectrum coordination function

B.1.3 CRS with spectrum coordination function

In the example shown in figure B.1.3 it is the CRS 'hosting' with spectrum coordination function. It may be possible for the spectrum coordination function to be implemented in the CRS. In this case, there is one physical interface in the system. The physical interface between the WSD/WSD network and the regulatory database will support the reference points A and D.

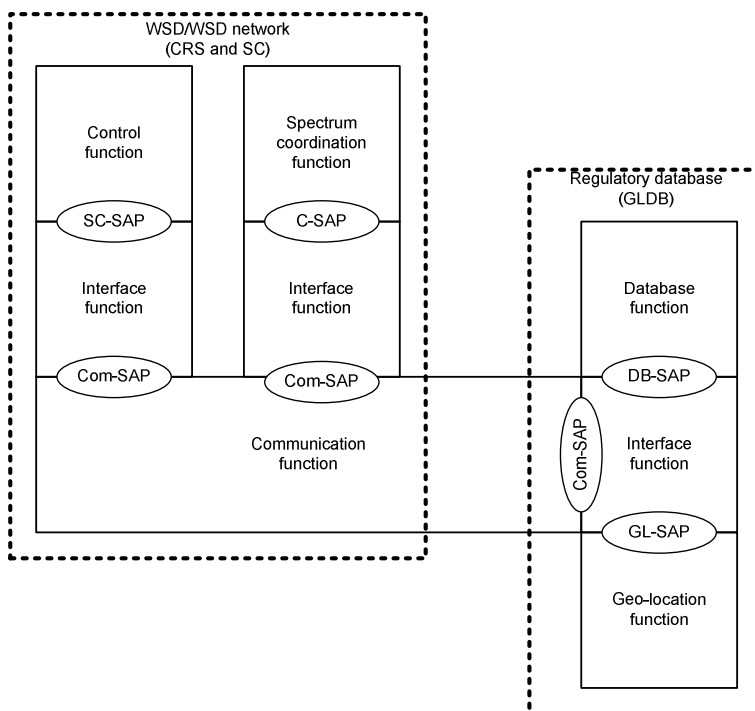

Figure B.1.3: CRS with spectrum coordination function

B.1.4 Spectrum coordination for Multi-operators

Figure B.1.4 shows the case of the spectrum coordination for multi-operators when there is more than one spectrum coordination function in the system. The spectrum coordination function in the regulatory database may coordinate available spectrum resources for operators (i.e. inter-operator management). The spectrum coordination function in the operator may coordinate coexistence among different radio access technologies in the operator. In this case, the physical interface between the operator and the regulatory database will support the reference points C and D.

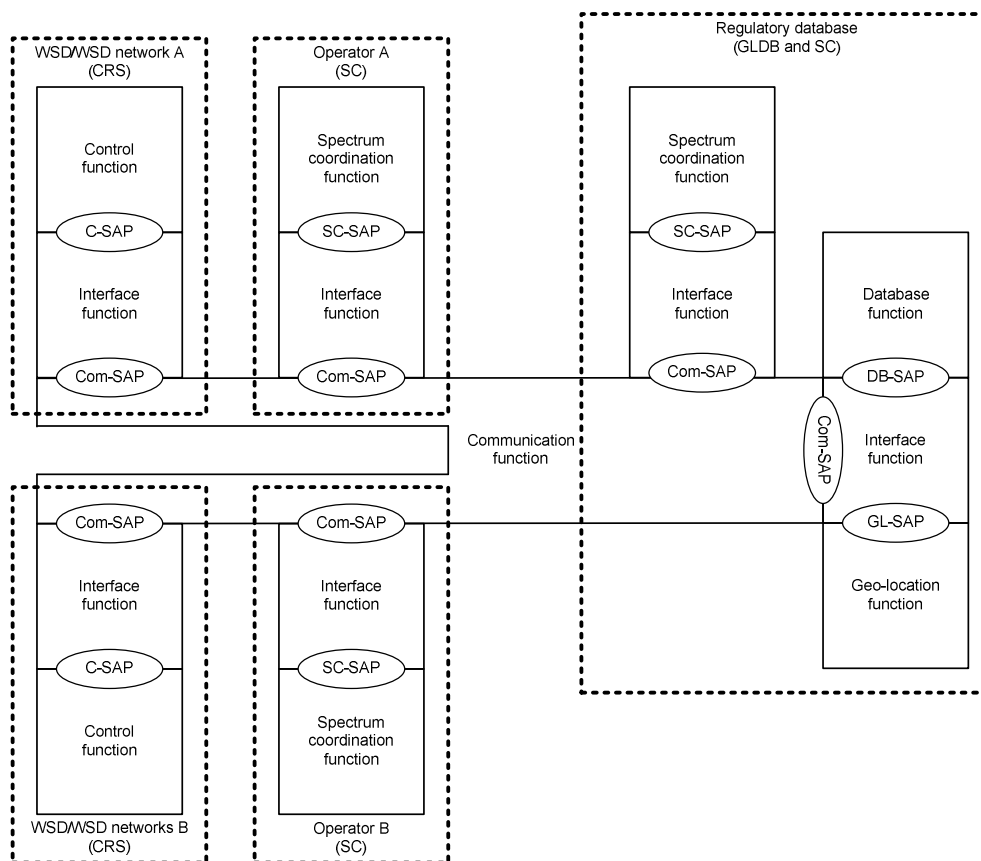

Figure B.1.4: Spectrum coordination for Multi-operators

History

Document history		
V1.1.1	January 2015	Publication as ETSI TS 103 145
V1.1.5	July 2015	EN Approval Procedure AP 20151106: 2015-07-09 to 2015-11-06