

EN 301 025 V1.1.1 (1998-08)

European Standard (Telecommunications series)

**Electromagnetic compatibility
and Radio spectrum Matters (ERM);
Technical characteristics and methods of measurement for
VHF radiotelephone equipment for general communications
and associated equipment for Class "D"
Digital Selective Calling (DSC)**



Reference

DEN/ERM-RP01-019 (9ho00ico.PDF)

Keywords

Maritime, radio, traffic

ETSI

Postal address

F-06921 Sophia Antipolis Cedex - FRANCE

Office address

650 Route des Lucioles - Sophia Antipolis
Valbonne - FRANCE
Tel.: +33 4 92 94 42 00 Fax: +33 4 93 65 47 16
Siret N° 348 623 562 00017 - NAF 742 C
Association à but non lucratif enregistrée à la
Sous-Préfecture de Grasse (06) N° 7803/88

Internet

secretariat@etsi.fr
<http://www.etsi.fr>
<http://www.etsi.org>

Copyright Notification

No part may be reproduced except as authorized by written permission.
The copyright and the foregoing restriction extend to reproduction in all media.

© European Telecommunications Standards Institute 1998.
All rights reserved.

Contents

Intellectual Property Rights.....	9
Foreword.....	9
1 Scope.....	10
2 References.....	10
3 Definitions and abbreviations.....	11
3.1 Definitions.....	11
3.2 Abbreviations.....	11
4 General and operational requirements.....	11
4.1 General.....	11
4.2 Composition.....	11
4.3 Construction.....	12
4.4 Controls and indicators.....	12
4.5 Facilities for coding and decoding of DSC.....	13
4.5.1 Call functions.....	13
4.5.2 MANUAL calls.....	13
4.5.3 Distress calls.....	13
4.5.4 ALL SHIPS calls.....	14
4.5.5 Incoming calls.....	14
4.6 DSC display.....	14
4.7 Handset and loudspeaker.....	14
4.8 Safety precautions.....	14
4.9 Labelling.....	15
4.10 Warm up.....	15
5 Technical requirements.....	15
5.1 Switching time.....	15
5.2 Class of emission and modulation characteristics.....	15
5.3 Facilities for DSC transmission and reception.....	15
5.3.1 General.....	15
5.3.2 Decoding.....	16
5.3.3 Free channel transmission.....	16
5.3.4 Automatic acknowledgement.....	16
5.3.5 Automatic re-transmission of distress calls.....	16
5.4 Ships identity - MMSI and Group MMSI.....	16
5.5 Entry of position information.....	16
5.6 Alarm circuits.....	17
5.6.1 Distress and urgency.....	17
5.6.2 Other categories.....	17
5.6.3 Acoustic alarms.....	17
5.6.4 Cancellation of alarms.....	17
5.7 Facilities for automatic identification.....	17
5.8 Multiple watch facilities.....	17
5.8.1 General.....	17
5.8.2 Scanning provisions.....	17
5.8.3 Scanning characteristics.....	18
6 General conditions of measurement.....	18
6.1 Arrangements for test signals applied to the receiver input.....	18
6.2 Squelch.....	18
6.3 Normal test modulation.....	18
6.4 Artificial antenna.....	19
6.5 Arrangements for test signals applied to the transmitter input.....	19
6.6 Test channels.....	19

6.7	Generation and examination of the digital selective call signal	19
6.8	Standard test signals for DSC	19
6.9	Determination of the symbol error ratio in the output of the receiving part.....	19
6.10	Measurement uncertainty and interpretation of the measured results	20
6.10.1	Measurement uncertainty	20
6.10.2	Interpretation of the measurement results.....	20
6.11	Test conditions, power sources, and ambient temperatures	20
6.11.1	Normal and extreme test conditions	20
6.11.2	Test power source	20
6.12	Normal test conditions	21
6.12.1	Normal temperature and humidity.....	21
6.12.2	Normal power sources.....	21
6.12.2.1	Battery power source	21
6.12.2.2	Other power sources	21
6.13	Extreme test conditions.....	21
6.13.1	Extreme temperatures.....	21
6.13.2	Extreme values of test power sources.....	21
6.13.2.1	Battery power source	21
6.13.2.2	Other power sources	21
6.14	Procedure for tests at extreme temperatures	21
7	Environmental tests	22
7.1	Introduction.....	22
7.2	Procedure	22
7.3	Performance check.....	22
7.4	Vibration test	22
7.4.1	Definition	22
7.4.2	Method of measurement	22
7.4.3	Requirement	23
7.5	Temperature tests	23
7.5.1	Definition	23
7.5.2	Dry heat.....	23
7.5.2.1	Definition.....	23
7.5.2.2	Method of measurement	23
7.5.2.3	Requirement.....	23
7.5.3	Damp heat	23
7.5.3.1	Definition.....	23
7.5.3.2	Method of measurement	23
7.5.3.3	Requirement.....	24
7.5.4	Low temperature	24
7.5.4.1	Definition.....	24
7.5.4.2	Method of measurement	24
7.5.4.3	Requirement.....	24
8	Transmitter	24
8.1	Frequency error.....	24
8.1.1	Definition	24
8.1.2	Method of measurement.....	24
8.1.3	Limits	25
8.2	Carrier power	25
8.2.1	Definition	25
8.2.2	Method of measurement.....	25
8.2.3	Limits	25
8.2.3.1	Normal test conditions.....	25
8.2.3.2	Extreme test conditions.....	25
8.3	Frequency deviation.....	25
8.3.1	Definition	25
8.3.2	Maximum permissible frequency deviation.....	25
8.3.2.1	Method of measurement	25
8.3.2.2	Limits.....	26
8.3.3	Reduction of frequency deviation at modulation frequencies above 3 kHz	26

8.3.3.1	Method of measurement	26
8.3.3.2	Limits	26
8.4	Sensitivity of the modulator, including microphone	26
8.4.1	Definition	26
8.4.2	Method of measurement	27
8.4.3	Limits	27
8.5	Audio frequency response	27
8.5.1	Definition	27
8.5.2	Method of measurement	27
8.5.3	Limit	27
8.6	Audio frequency harmonic distortion of the emission	28
8.6.1	Definition	28
8.6.2	Method of measurement	28
8.6.2.1	Normal test conditions	29
8.6.2.2	Extreme test conditions	29
8.6.3	Limits	29
8.7	Adjacent channel power	29
8.7.1	Definition	29
8.7.2	Method of measurement	29
8.7.3	Limits	29
8.8	Conducted spurious emissions conveyed to the antenna	30
8.8.1	Definition	30
8.8.2	Method of measurement	30
8.8.3	Limit	30
8.9	Cabinet radiation and conducted spurious emissions other than those conveyed to the antenna	30
8.9.1	Definitions	30
8.9.2	Method of measurement	30
8.9.3	Limits	31
8.10	Transient frequency behaviour of the transmitter	31
8.10.1	Definitions	31
8.10.2	Method of measurement	32
8.10.3	Limits	34
8.11	Residual modulation of the transmitter	34
8.11.1	Definition	34
8.11.2	Method of measurement	34
8.11.3	Limit	34
8.12	Frequency error (demodulated DSC signal)	34
8.12.1	Definition	34
8.12.2	Method of measurement	35
8.12.3	Limits	35
8.13	Modulation index for DSC	35
8.13.1	Definition	35
8.13.2	Method of measurement	35
8.13.3	Limits	35
8.14	Modulation rate for DSC	35
8.14.1	Definition	35
8.14.2	Method of measurement	35
8.14.3	Limits	35
8.15	Testing of generated call sequences	36
8.15.1	Definition	36
8.15.2	Method of measurement	36
8.15.3	Requirement	36
9	Radiotelephone receiver	36
9.1	Harmonic distortion and rated audio-frequency output power	36
9.1.1	Definition	36
9.1.2	Methods of measurement	36
9.1.3	Limits	37
9.2	Audio frequency response	37
9.2.1	Definition	37
9.2.2	Method of measurement	37

9.2.3	Limits	37
9.3	Maximum usable sensitivity.....	38
9.3.1	Definition	38
9.3.2	Method of measurement.....	38
9.3.3	Limits	39
9.4	Co-channel rejection	39
9.4.1	Definition	39
9.4.2	Method of measurement.....	39
9.4.3	Limit.....	39
9.5	Adjacent channel selectivity	39
9.5.1	Definition	39
9.5.2	Method of measurement.....	39
9.5.3	Limits	40
9.6	Spurious response rejection	40
9.6.1	Definition	40
9.6.2	Method of measurement.....	40
9.6.3	Limit.....	40
9.7	Intermodulation response.....	40
9.7.1	Definition	40
9.7.2	Method of measurement.....	41
9.7.3	Limit.....	41
9.8	Blocking or desensitization.....	41
9.8.1	Definition	41
9.8.2	Method of measurement.....	41
9.8.3	Limit.....	41
9.9	Spurious emissions.....	41
9.9.1	Definition	41
9.9.2	Method of measuring the power level	42
9.9.3	Limit.....	42
9.10	Radiated spurious emissions	42
9.10.1	Definition	42
9.10.2	Method of measurements	42
9.10.3	Limit.....	43
9.11	Receiver residual noise level.....	43
9.11.1	Definition	43
9.11.2	Method of measurement.....	43
9.11.3	Limit.....	43
9.12	Squelch operation	43
9.12.1	Definition	43
9.12.2	Method of measurement.....	43
9.12.3	Limits	44
9.13	Squelch hysteresis	44
9.13.1	Definition	44
9.13.2	Method of measurement.....	44
9.13.3	Limit.....	44
9.14	Multiple watch characteristic	44
9.14.1	Definition	44
9.14.2	Method of measurement.....	45
9.14.3	Limits	45
10	Receiver for DSC decoder	45
10.1	Maximum usable sensitivity.....	45
10.1.1	Definition	45
10.1.2	Method of measurement.....	45
10.1.3	Limits	45
10.2	Co-channel rejection	46
10.2.1	Definition	46
10.2.2	Method of measurement.....	46
10.2.3	Limits	46
10.3	Adjacent channel selectivity	46
10.3.1	Definition	46

10.3.2	Method of measurement	46
10.3.3	Limits	46
10.4	Spurious response and blocking immunity.....	47
10.4.1	Definition	47
10.4.2	Method of measurement	47
10.4.3	Limits	47
10.5	Intermodulation response.....	47
10.5.1	Definition	47
10.5.2	Method of measurement	47
10.5.3	Limits	47
10.6	Dynamic range	48
10.6.1	Definition	48
10.6.2	Method of measurement.....	48
10.6.3	Limit.....	48
10.7	Spurious emissions.....	48
10.7.1	Definition	48
10.7.2	Method of measuring the power level	48
10.7.3	Limit.....	48
10.8	Radiated spurious emissions	48
10.8.1	Definition	48
10.8.2	Method of measurements	48
10.8.3	Limit.....	49
10.9	Verification of correct decoding of various types of DSC calls.....	49
10.9.1	Definition	49
10.9.2	Method of measurement.....	49
10.9.3	Requirement	50
Annex A (normative):	DSC Calls.....	51
Annex B (normative):	Measuring receiver for adjacent channel power measurement.....	52
B.1	Power measuring receiver specification	52
B.1.1	IF filter.....	52
B.1.2	Attenuation indicator	53
B.1.3	R.M.S. value indicator	53
B.1.4	Oscillator and amplifier	53
Annex C (normative):	Radiated measurements.....	54
C.1	Test sites and general arrangements for measurements involving the use of radiated fields	54
C.1.1	Outdoor test site	54
C.1.2	Test antenna	54
C.1.3	Substitution antenna.....	55
C.1.4	Optional additional indoor site.....	55
C.2	Guidance on the use of radiation test sites.....	56
C.2.1	Measuring distance	56
C.2.2	Test antenna	56
C.2.3	Substitution antenna.....	56
C.2.4	Artificial antenna	57
C.2.5	Auxiliary cables	57
C.2.6	Acoustic measuring arrangement	57
C.3	Further optional alternative indoor test site using an anechoic chamber.....	57
C.3.1	Example of the construction of a shielded anechoic chamber.....	58
C.3.2	Influence of parasitic reflections in anechoic chambers.....	58
C.3.3	Calibration of the shielded anechoic chamber	59

Annex D (informative):	Description of the equipment	61
Annex E (normative):	Subclauses of the present document relevant for compliance with the essential requirements of relevant EC Council Directives	62
History		63

Intellectual Property Rights

IPRs essential or potentially essential to the present document may have been declared to ETSI. The information pertaining to these essential IPRs, if any, is publicly available for **ETSI members and non-members**, and can be found in SR 000 314: "*Intellectual Property Rights (IPRs); Essential, or potentially Essential, IPRs notified to ETSI in respect of ETSI standards*", which is available **free of charge** from the ETSI Secretariat. Latest updates are available on the ETSI Web server (<http://www.etsi.fr/ipr> or <http://www.etsi.org/ipr>).

Pursuant to the ETSI IPR Policy, no investigation, including IPR searches, has been carried out by ETSI. No guarantee can be given as to the existence of other IPRs not referenced in SR 000 314 (or the updates on the ETSI Web server) which are, or may be, or may become, essential to the present document.

Foreword

This European Standard (Telecommunications series) has been produced by ETSI Technical Committee Electromagnetic compatibility and Radio spectrum Matters (ERM).

National transposition dates	
Date of adoption of this EN:	7 August 1998
Date of latest announcement of this EN (doa):	30 November 1998
Date of latest publication of new National Standard or endorsement of this EN (dop/e):	31 May 1999
Date of withdrawal of any conflicting National Standard (dow):	31 May 1999

1 Scope

The present document covers the minimum requirements for general communication for shipborne fixed installations using a VHF radiotelephone with associated equipment for DSC - class D.

These requirements include the relevant provisions of the ITU Radio Regulations [1], ITU-R Recommendations M.493-9 [5] where class D is defined, M.825-1 [8] and incorporate the relevant guidelines of the IMO as detailed in MSC/Circ. 803 [9].

The present document also specifies technical characteristics, methods of measurement and required test results.

2 References

The following documents contain provisions which, through reference in this text, constitute provisions of the present document.

- References are either specific (identified by date of publication, edition number, version number, etc.) or non-specific.
- For a specific reference, subsequent revisions do not apply.
- For a non-specific reference, subsequent revisions do apply.
- A non-specific reference to an ETS shall also be taken to refer to later versions published as an EN with the same number.

- [1] ITU Radio Regulations, Appendix 18 (1994): "Table of transmitting frequencies in the band 156 - 174 MHz for stations in the Maritime Mobile Service".
- [2] ITU-T Recommendation E.161 (1993): "Arrangement of digits, letters and symbols on telephones and other devices that can be used for gaining access to a telephone network".
- [3] ITU-T Recommendation P.53 (1994): "Psophometer for use on telephone-type circuits".
- [4] IEC 1162-1 (1995): "Maritime navigation and radiocommunication equipment and systems - Digital interfaces - Part 1: Single talker and multiple listeners".
- [5] ITU-R Recommendation M.493-9 (1997): "Digital selective-calling system for use in the maritime mobile service".
- [6] ETR 028: "Radio Equipment and Systems (RES); Uncertainties in the measurement of mobile radio equipment characteristics".
- [7] ITU-R Recommendation SM 332-4: "Selectivity of receivers".
- [8] ITU-R Recommendation M.825-1 (1995): "Characteristics of a transponder system using digital selective calling techniques for use with vessel traffic services and ship-to-ship identification".
- [9] MSC/Circ.803: "Participation of non-SOLAS ships in the Global Maritime Distress and Safety System (GMDSS)".

3 Definitions and abbreviations

3.1 Definitions

For the purposes of the present document, the following definitions apply:

Class D: class D equipment is intended to provide minimum facilities for VHF DSC distress, urgency and safety as well as routine calling and reception, not necessarily in full accordance with IMO GMDSS carriage requirements for VHF installations (ITU-R Recommendation M.493-9) [5].

carrier frequency: the frequency to which the transmitter or receiver is tuned.

frequency deviation: the difference between the instantaneous frequency of the modulated RF signal and the carrier frequency.

G3E: phase-modulation (Frequency modulation with a pre-emphasis of 6 dB/octave) for speech.

G2B: phase-modulation with digital information, with a sub-carrier for DSC operation.

modulation index: the ratio between the frequency deviation and the frequency of the modulation signal.

3.2 Abbreviations

For the purposes of the present document, the following abbreviations apply.

DSC	Digital Selective Calling
e.m.f.	electromotive force
EUT	Equipment Under Test
FM	Frequency Modulation
IF	Intermediate Frequency
IMO	International Maritime Organization
MMSI	Maritime Mobile Service Identity
ppm	parts per million
RF	Radio Frequency
r.m.s.	root mean square
SINAD	Signal + Noise + Distortion to Noise + Distortion
VHF	Very High Frequency

4 General and operational requirements

4.1 General

The manufacturer shall declare that compliance to the requirements of clause 4 is achieved and shall provide relevant documentation.

4.2 Composition

The equipment shall, as a minimum, include:

- a VHF radiotelephone;
- a VHF radiotelephone receiver;

- a dedicated channel 70 watchkeeping receiver for DSC decoder;
- a DSC encoder; and
- a DSC decoder.

4.3 Construction

The mechanical and electrical construction and finish of the equipment shall conform in all respects to good engineering practice, and the equipment shall be suitable for use on board vessels.

All controls shall be of sufficient size to enable the usual control functions to be easily performed and the number of controls should be the minimum necessary for simple and satisfactory operation.

Adequately detailed operating instructions shall be provided with the equipment.

The equipment shall be capable of operating on single frequency and two-frequency channels with manual control (simplex).

The equipment shall be able to operate on all channels defined in appendix 18 to the Radio Regulations [1].

Operation on channels 75 and 76 shall be prevented by appropriate means. Additional VHF channels outside those defined by appendix 18 to the Radio Regulations [1] may also be provided, but means shall be provided to block any or all of these additional channels, as may be required by the licence before installation on board vessels. It shall not be possible for the user to unblock any blocked channels.

The equipment shall be so designed that use of channel 70 for purposes other than DSC is prevented.

It shall not be possible to transmit while any frequency synthesizer used within the transmitter is out of lock.

It shall not be possible to transmit during channel switching operations.

4.4 Controls and indicators

The user shall not have access to any control which, if wrongly set, might impair the technical characteristics of the equipment.

If the equipment can be operated from more than one position, the control unit provided at the position from where the vessel is normally navigated shall have priority and the individual control units shall be provided with an indicator showing whether the equipment is in operation.

The following controls or functions shall be provided:

- DISTRESS BUTTON (subclause 4.5.3): The default shall be an undesignated distress message;
- CALL (subclause 4.5.1): The default (initial display) shall be an individual call;
- CANCEL: to revert to the initial display. The cancel function shall take place automatically after a maximum of five minutes of inactivity;
- ENTER/Accept/OK: for accepting a menu item;
- NUMERIC KEY PAD: for instance for entering MMSI for calling and manual position information. This shall conform to ITU-T Recommendation E.161 [2];
- ALPHA - NUMERIC DISPLAY (subclause 4.5);
- on/off switch for the entire installation with a visual indication that the installation is in operation;
- a manual non-locking push-to-talk switch to operate the transmitter with a visual indication that the transmitter is activated;

- a switch for reducing transmitter output power to no more than 1 W with a visual indication that low power is selected;
- an audio-frequency power volume control;
- a squelch control;
- a control for dimming to extinction the equipment illumination with the exception of a visual indicator (subclause 4.5.3);
- controls for multiple watch facilities, if provided (subclause 5.8).

The equipment shall have means to select manually a channel and shall indicate the designator, as shown in appendix 18 to the Radio Regulations [1], of the channel at which the installation is set. The channel designator shall be legible irrespective of the external lighting conditions.

Channel 16 shall be distinctively marked. Selection of channel 16, shall be preferably by readily accessible means (e.g. a distinctively marked key). The initial selection of channel 16 shall automatically select the maximum transmitter power.

4.5 Facilities for coding and decoding of DSC

4.5.1 Call functions

The facilities for coding and composition of calls shall be so arranged that it is possible for the operator quickly and precisely to enter a call. The types of DSC calls provided in this equipment are specified in annex A.

The CALL functions (subclause 4.4) shall permit selection of the following functions:

- INDIVIDUAL: for making a call to a specific MMSI;
- ALL SHIPS URGENCY/SAFETY: for making all ships calls;
- RECEIVED CALLS: for retrieving stored incoming DSC calls;
- OTHER: for equipment housekeeping functions.

If INDIVIDUAL is selected, either a MANUAL call (subclause 4.5.2) or a DIRECTORY call shall be selected. The DIRECTORY list shall have a facility for at least 10 entries. Their MMSIs shall be programmable.

4.5.2 MANUAL calls

The MANUAL call facility shall permit the entry of a MMSI. If the called station is a coast station (i.e. MMSI commencing 00) no further information shall be requested from the operator. If the called station is a ship station the equipment shall request input of a channel number. The equipment shall assist the operator by suggesting a suitable inter-ship channel.

4.5.3 Distress calls

It shall only be possible to transmit distress DSC calls by means of a single dedicated button which is used for no other purpose. This button shall not be any key of ITU-T Recommendation E.161 [2] digital input panel or an ISO keyboard provided on the equipment. This button shall be clearly identified and protected against inadvertent operation with a spring loaded cover.

The distress alert initiation shall require at least two independent actions. A visual indication and an acoustic alarm (subclause 5.6.3) shall be provided to show that a distress alert has been initiated. There shall be a time delay of at least 3 s between initial operation of the button and the alert being activated.

It shall be possible to select the nature of distress prior to initiating the transmission of a distress call. The default nature of distress shall be the undesignated distress.

Initiation of a distress call shall automatically have priority over any other operation of the equipment. The equipment shall automatically select channel 70 and the maximum transmitter power.

Manual means shall be provided to discontinue transmission of a distress call.

The distress call shall automatically be transmitted five times in succession with no intervals between the individual calls so that bit synchronization between the transmitter and receiver of the call can be maintained. Each call shall include the appropriate dot pattern.

After the transmission of the distress call sequence the equipment shall automatically tune to channel 16 and select the maximum transmitter power.

4.5.4 ALL SHIPS calls

It shall only be possible to transmit ALL SHIPS URGENCY and ALL SHIPS SAFETY calls by means of deliberate actions, such as two levels of menu instructions.

4.5.5 Incoming calls

The DSC equipment shall be provided with suitable facilities for converting incoming calls with relevant address content to visual form in plain language. The contents of at least the last 10 received DSC calls shall be stored until read manually from the RECEIVED CALL menu.

The radiotelephone shall be capable of automatically switching to any channel identified in an incoming call. In the case of incoming distress and urgency calls the radiotelephone shall switch to channel 16 and shall automatically select the maximum transmitter power.

4.6 DSC display

The equipment shall be provided with facilities which show the functions currently available, prompts the operator if an incorrect operation is attempted, displays error messages and displays incoming and logged calls. When the equipment is not in use for normal communications purposes, it should display the last entered position (subclause 5.5).

The equipment shall be provided with facilities for visual indication, and possible manual correction of the user programmable information content of the call before the call is sent.

There shall be an indication that unread incoming messages are present in memory. Indications shall be provided that a distress alert is in automatic retransmit mode.

4.7 Handset and loudspeaker

The equipment shall be fitted with a telephone handset or microphone, and an integral loudspeaker and/or a socket for an external loudspeaker. Where there are connections to external loudspeakers, these shall also relay acoustic alarms.

During transmission in simplex operation the receiver output shall be muted.

4.8 Safety precautions

Measures shall be taken to protect the equipment against the effects of excessive current or excessive voltage.

Measures shall be taken to prevent any damage that might arise from an accidental reversal of polarity of the electrical power source.

Means shall be provided for earthing exposed metallic parts of the equipment.

The components and wiring in which the d.c. or d.c. voltage (other than radio-frequency voltage), produce, singly or in combination, peak voltages in excess of 50 V, shall be protected against any accidental access and shall be automatically isolated from all electrical power sources if the protective covers are removed. Alternatively, the equipment shall be constructed in such a way as to prevent access to components operating at such voltages unless an appropriate tool is used

such as a nut-spanner or screwdriver. Conspicuous warning labels shall be affixed both inside the equipment and on the protective covers.

No damage to the equipment shall occur when the antenna terminals are placed on open circuit or short circuit for a period of at least 5 minutes in each case.

In order to provide protection against damage due to the build up of static voltages at the antenna terminals, there shall be a d.c. path from the antenna terminals to chassis not exceeding 100 k Ω .

The information in any volatile memory device shall be protected from interruptions in the power supply up to 60 s duration. The information in programmable memory devices and the vessel's identity and information inherent to the DSC process shall be stored in non-volatile memory devices.

4.9 Labelling

All controls, instruments, indicators and terminals shall be clearly labelled.

Details of the power supply from which the equipment is intended to operate shall be clearly indicated on the equipment together with the serial number of the equipment.

All units of the equipment shall be clearly marked on the exterior with the identification of the manufacturer and type designation of the equipment. This marking shall be clearly visible in the normal operating position.

The compass safe distance shall be stated on the equipment or in the user document.

4.10 Warm up

After being switched on, the equipment shall be operational within 5 s.

5 Technical requirements

5.1 Switching time

The channel switching arrangement shall be such that the time necessary to manually change over from using one of the channels to using any other channel does not exceed 5 s.

The time necessary to change over from transmission to reception or vice versa, shall not exceed 0,3 s.

5.2 Class of emission and modulation characteristics

The equipment shall use phase modulation, G3E (frequency modulation with pre-emphasis of 6 dB/octave) for speech, and G2B for DSC signalling.

The equipment shall be designed to operate with a channel separation of 25 kHz.

5.3 Facilities for DSC transmission and reception

5.3.1 General

The equipment shall comprise the necessary facilities for coding and transmission of DSC on channel 70 and for decoding and conversion of the information content of received DSC to visual form in plain language.

The equipment may be either:

- a) an independent unit for connection to an associated radiotelephone; or
- b) mechanically and electrically integrated in such radio equipment.

However in both cases the DSC equipment shall be capable of automatic channel switching in the radio equipment.

The watchkeeping receiver part of the DSC equipment shall be designed for continuous operation on channel 70 but the receiver need not operate when the transmitter is in use.

5.3.2 Decoding

The DSC equipment shall be so designed that in the decoding process use shall be made of parity bits for error detection, time diversity repetitions and error check characters in the received call as specified in ITU-R Recommendation M.493-9 [5].

5.3.3 Free channel transmission

The DSC equipment shall be provided with facilities which, except for distress calls, automatically delay the transmission of DSC until the calling channel 70 is free.

5.3.4 Automatic acknowledgement

The equipment shall not be provided with facilities for automatic transmission of acknowledgements.

5.3.5 Automatic re-transmission of distress calls

Where no DSC distress acknowledgement is received, the equipment shall automatically re-transmit the distress call attempt on channel 70 after a random delay of between 3 ½ and 4 ½ minutes from the beginning of the previous call.

After the transmission of each distress call attempt the equipment shall automatically re-tune to channel 16 and select the maximum transmitter power.

This sequence shall be continued until a DSC distress acknowledgement has been received, or until the automatic transmission of the distress call is discontinued manually.

Means shall be provided for transmitting the distress call attempt again by manual intervention at any time.

5.4 Ships identity - MMSI and Group MMSI

The equipment shall be capable of storing permanently the ship's 9-digit Maritime Mobile Service Identity (MMSI) number which shall be inserted automatically in the call. The 10th digit shall be added automatically set to zero. It shall not be possible to change the identity number using any combination of operator controls. It shall not be possible to transmit a DSC call until the ship's MMSI has been stored.

Facilities shall be provided to permit the operator to program and store a Group MMSI number to enable the equipment to recognize calls addressed to both the ship's MMSI and the Group MMSI. These facilities shall limit the number of operator programmable digits to 8 and the leading zero shall be automatically inserted by the equipment.

5.5 Entry of position information

Means shall be provided for manual entry of the geographical position information and of the time when this position information was valid. In addition, facilities for automatic entry and encoding of the geographical position and time information shall be provided. Such facilities shall conform with IEC 1162-1 [4].

No connection of, or failure within, any external circuits shall disable the DSC equipment. In the event of failure of the data stream (IEC 1162-1 [4]) an error message shall be shown and the operator prompted for a manual input of position every four hours.

If the position information has not been updated for 23,5 hours the position shall default to the repeated digit "9" as specified in ITU-R Recommendation M.493-9 [5].

5.6 Alarm circuits

5.6.1 Distress and urgency

The equipment shall be provided with a specific acoustic alarm and a visual indication, activated automatically when a call with format specifier distress or category distress or urgency has been received. It shall not be possible to disable these alarm circuits.

5.6.2 Other categories

The equipment shall be provided with an acoustic alarm and a visual indication, activated automatically on receipt of calls of categories other than distress and urgency. It shall not be possible to disable the acoustic alarm circuit.

5.6.3 Acoustic alarms

The acoustic power of an alarm shall be at least 80 dB(A) at a distance of 1 m from the equipment.

5.6.4 Cancellation of alarms

A means of manual cancellation of alarms shall be provided. In the event that an alarm is not cancelled manually, then automatic cancellation shall take place after 2 minutes.

5.7 Facilities for automatic identification

If facilities for automatic identification to ITU-R Recommendation M.825-1 [8] are provided, then the equipment shall not permit the operator to originate this type of call. The equipment shall only be capable of responding to requests for identification.

5.8 Multiple watch facilities

5.8.1 General

The VHF radiotelephone equipment may be provided with multiple watch facilities on traffic channels but operation using DSC shall always take precedence. It shall not be possible to adopt scanning techniques on channel 70.

5.8.2 Scanning provisions

Equipment having multiple watch facilities shall comply with the following:

- the equipment shall include a provision for the automatic scanning of a priority channel and one additional channel. Facilities for the automatic sequential change of the additional channel may be provided, which are not accessible to the user. Means shall be provided to block/unblock these facilities;
- the priority channel is that channel which will be sampled even if there is a signal on the additional channel and on which the receiver will lock during the time a signal is detected;
- the additional channel is that channel which will be monitored during the periods the equipment is not sampling or receiving signals on the priority channel;
- provision shall be included to switch the scanning facility on and off by means of a manually operated control. In addition it shall be ensured that the receiver remains on the same channel as the transmitter for the entire duration of any communication, e.g. the scanning facility may be switched off automatically when the handset is off its hook;

- selection of the additional channel and selection, if provided, of the priority channel shall be possible at the operating position of the receiver or transceiver. If selection of the priority channel is not provided, the priority channel shall be channel 16;
- when the scanning facility is in operation, the channel number of both channels on which the equipment is operating shall be indicated;
- in a transceiver, transmission shall not be possible when the scanning facility is operating. When the scanning facility is switched off, both transmitter and receiver shall be tuned automatically to the selected additional channel;
- a transceiver shall be provided with a single manual control (e.g. push-button) in order to switch the equipment quickly for operation on the priority channel;
- at the operating position of a transceiver the selected additional channel shall be clearly indicated as being the operational channel of the equipment.

5.8.3 Scanning characteristics

When the scanning facility is switched on, the priority channel shall be sampled with a sampling period of not more than 2 s. If a signal is detected on the priority channel the receiver shall remain on this channel for the duration of that signal.

If a signal is detected on the additional channel the sampling of the priority channel shall continue, thus interrupting the reception on the channel for periods as short as possible and not greater than 150 ms.

The design of the receiver shall provide for its proper functioning during the period the priority channel is sampled since the receiving conditions on the priority channel may differ from those on the additional channel.

In the absence of a signal on the priority channel, and, during reception of a signal on the additional channel, the duration of each listening period on this channel shall be at least 850 ms.

Means shall be provided to indicate the channel on which a signal is being received.

6 General conditions of measurement

6.1 Arrangements for test signals applied to the receiver input

Test signal sources shall be connected to the receiver input in such a way that the impedance presented to the receiver input is 50 Ω , irrespective of whether one or more test signals are applied to the receiver simultaneously.

The levels of the test signals shall be expressed in terms of the electromotive force (e.m.f.) at the terminals to be connected to the receiver.

The nominal frequency of the receiver is the carrier frequency of the selected channel.

6.2 Squelch

Unless otherwise specified, the receiver squelch facility shall be made inoperative for the duration of the conformance tests.

6.3 Normal test modulation

For normal test modulation, the modulation frequency shall be 1 kHz and the frequency deviation shall be ± 3 kHz.

For DSC conformance testing and maintenance purposes, the equipment shall have facilities not accessible to the operator to generate a continuous B or Y signal and dot pattern.

Additionally for conformance testing, the VHF equipment shall have facilities not accessible to the operator for generating an unmodulated carrier.

6.4 Artificial antenna

When tests are carried out with an artificial antenna, this shall be a non-reactive, non-radiating 50 Ω load.

6.5 Arrangements for test signals applied to the transmitter input

For the purposes of the present document, the audio frequency modulating signal applied to the transmitter shall be produced by a signal generator applied to the connection terminals replacing the microphone transducer.

6.6 Test channels

Conformance tests shall be made on channel 16 for voice and channel 70 for DSC tests, unless otherwise stated.

6.7 Generation and examination of the digital selective call signal

During the conformance tests the DSC signals generated by the equipment shall be examined by means of calibrated apparatus for decoding and printing out the information content of the signals.

The decoding part of the equipment may be provided with a printer or an output terminal for connecting an external printer.

The equipment delivered for the purposes of testing shall be provided with a printer or an output terminal for connecting a printer or computer for registration of the decoded call sequences. Details concerning such output signals to an external printer or computer shall be agreed between the manufacturer and the testing laboratory.

The facilities of the equipment for reception and/or decoding of DSC shall be examined by feeding DSC signals from a calibrated DSC generator.

6.8 Standard test signals for DSC

The standard test signal for a VHF DSC decoder shall be a phase-modulated signal at VHF channel 70 with modulation index = 2. The modulating signal shall have a nominal frequency of 1 700 Hz and a frequency shift of \pm 400 Hz with a modulation rate of 1 200 baud.

Standard test signals shall consist of a series of identical call sequences, each of which contain a known number of information symbols (format specifier, address, category, identification etc. of ITU-R Recommendation M.493-9 [5]).

Standard test signals shall be of sufficient length for the measurements to be performed or it shall be possible to repeat them without interruption to make the measurements.

6.9 Determination of the symbol error ratio in the output of the receiving part

The information content of the decoded call sequence displayed at the readout device of the receiving part shall be divided into blocks, each of which corresponds to one information symbol in the applied test signal (subclause 6.8). The total number of incorrect information symbols relative to the total number of information symbols shall be registered. In the present document, bit error ratio measurements are taken to be equivalent to symbol error ratio measurements.

6.10 Measurement uncertainty and interpretation of the measured results

6.10.1 Measurement uncertainty

Table 1: Maximum values of absolute measurement uncertainties

Radio Frequency (RF)	$\pm 1 \times 10^{-7}$
RF power/level	$\pm 0,75$ dB
Maximum frequency deviation: - within 300 Hz to 6 kHz of audio frequency - within 6 kHz to 25 kHz of audio frequency	± 5 % ± 3 dB
Deviation limitation	± 5 %
Adjacent channel power	± 5 dB
Conducted spurious emission of transmitter	± 4 dB
Audio output power	$\pm 0,5$ dB
Amplitude characteristics of receiver limiter	$\pm 1,5$ dB
Sensitivity at 20 dB SINAD	± 3 dB
Conducted emission of receiver	± 3 dB
Two-signal measurement	± 4 dB
Three-signal measurement	± 3 dB
Transmitter transient time	± 20 %
Transmitter transient frequency	± 250 Hz

For the test methods according to the present document, the uncertainty figures are valid to a confidence level of 95 % calculated according to the methods described in ETR 028 [6].

6.10.2 Interpretation of the measurement results

The interpretation of the results recorded in a test report for the measurements described in the present document shall be as follows:

- the measured value related to the corresponding limit shall be used to decide whether an equipment meets the requirements of the present document;
- the measurement uncertainty value for the measurement of each parameter shall be included in the test report;
- the recorded value of the measurement uncertainty shall be, for each measurement, equal to or lower than the figures in table 1.

6.11 Test conditions, power sources, and ambient temperatures

6.11.1 Normal and extreme test conditions

Conformance tests shall be made under normal test conditions and also, where stated, under extreme test conditions (subclauses 6.13.1 and 6.13.2 applied simultaneously).

6.11.2 Test power source

During conformance testing, the equipment shall be supplied from a test power source capable of producing normal and extreme test voltages as specified in subclauses 6.12.2 and 6.13.2.

The internal impedance of the test power source shall be low enough for its effect on the test results to be negligible. For the purpose of testing, the power source voltage shall be measured at the input terminals of the equipment.

During testing, the power source voltages shall be maintained within a tolerance of ± 3 % relative to the voltage level at the beginning of each test.

6.12 Normal test conditions

6.12.1 Normal temperature and humidity

The normal temperature and humidity conditions for tests shall be a combination of temperature and humidity within the following ranges:

temperature: +15°C to +35°C;

relative humidity: 20 % to 75 %.

Where the relative humidity is less than 20 %, it shall be stated in the test report.

6.12.2 Normal power sources

6.12.2.1 Battery power source

Where the equipment is designed to operate from a battery, the normal test voltage shall be the nominal voltage of the battery (12 V, 24 V, etc.).

6.12.2.2 Other power sources

For operation from other power sources the normal test voltage shall be that declared by the manufacturer.

6.13 Extreme test conditions

Unless otherwise stated the extreme test conditions means that the EUT shall be tested at the upper temperature and at the upper limit of the supply voltage applied simultaneously, and at the lower temperature and the lower limit of the supply voltage applied simultaneously.

6.13.1 Extreme temperatures

For tests at extreme temperatures, measurements shall be made in accordance with subclause 6.14, at a lower temperature of -15°C and an upper temperature of +55°C.

6.13.2 Extreme values of test power sources

6.13.2.1 Battery power source

Where the equipment is designed to operate from a battery, the extreme test voltages shall be 1,3 and 0,9 times the nominal voltage of the battery (12 V, 24 V etc.).

6.13.2.2 Other power sources

For operation from other sources the extreme test voltages shall be agreed between the testing authority and the equipment manufacturer.

6.14 Procedure for tests at extreme temperatures

The equipment shall be switched off during the temperature stabilizing periods.

Before conducting tests at the upper temperature, the equipment shall be placed in the test chamber and left until thermal equilibrium is reached. The equipment shall then be switched on for half an hour in the high power transmit condition. The equipment shall meet the requirements of the present document after this period.

For tests at the lower temperature, the equipment shall be left in the test chamber until thermal equilibrium is reached and shall then be switched to the standby or receive position for one minute, after which the equipment shall meet the requirements of the present document.

7 Environmental tests

7.1 Introduction

Environmental tests shall be carried out before tests are performed on the same equipment with respect to the other requirements of the present document.

7.2 Procedure

Unless otherwise stated, the EUT shall be connected to an electrical power source during the periods for which it is specified that electrical tests shall be carried out. These tests shall be performed using the normal test voltage (subclause 6.12.2).

7.3 Performance check

Where the term "performance check" is used, this shall be taken to mean a visual inspection of the equipment, a test of the transmitter output power and frequency error, and the receiver sensitivity to show that the equipment is functioning and that there is no visible damage or deterioration.

a) For the transmitter:

The transmitter shall be connected to the artificial antenna (subclause 6.4) and tuned to channel 16. The measurements shall be made in the absence of modulation with the power switch set at maximum. The output power shall be between 6 W and 25 W, and the frequency error shall be less than $\pm 1,5$ kHz.

b) For the receiver:

A standard DSC test signal (subclause 6.8) shall be applied to the receiver input. The symbol error ratio in the decoder output shall be determined as described in subclause 6.9 and the input level shall be reduced until the symbol error ratio is 10^{-2} . The level of the input signal (maximum usable sensitivity) shall be less than +6 dB μ V.

7.4 Vibration test

7.4.1 Definition

This test determines the ability of equipment to withstand vibration without resulting in mechanical weakness or degradation in performance.

7.4.2 Method of measurement

The EUT, complete with any shock and vibration absorbers with which it is provided, shall be clamped to the vibration table by its normal means of support and in its normal attitude. Provision may be made to reduce or nullify any adverse effect on equipment performance which could be caused by the presence of an electromagnetic field due to the vibration unit.

The equipment shall be subjected to sinusoidal vertical vibration at all frequencies between:

- 5 Hz and 13,2 Hz with an excursion of ± 1 mm ± 10 % (7 m/s² maximum acceleration at 13,2 Hz);
- 13,2 Hz and 100 Hz with a constant maximum acceleration of 7 m/s².

The frequency sweep rate shall be slow enough to allow the detection of resonances in any part of the equipment.

A resonance search shall be carried out throughout the test. If any resonance of the equipment had $Q \geq 5$ measured relative to the base of the vibration table, the equipment shall be subjected to a further vibration endurance test at each resonant frequency at the vibration level specified in the test with a duration of 2 hours. If resonances occur only with $Q < 5$, the further endurance test shall be carried out at one single observed resonant frequency. If no resonance occurs, the endurance test shall be carried out at a frequency of 30 Hz.

The performance check shall be carried out at the end of each 2 hour endurance test period.

The procedure shall be repeated with vibration in each of two mutually perpendicular directions in the horizontal plane.

After conducting the vibration tests, the equipment shall be inspected for any mechanical deterioration.

7.4.3 Requirement

The equipment shall meet the requirements of the performance check. There shall be no harmful deterioration of the equipment visible.

7.5 Temperature tests

7.5.1 Definition

The immunity against the effects of temperature is the ability of the equipment to maintain the specified mechanical and electrical performance after the following tests have been carried out. The maximum rate of raising or reducing the temperature of the chamber in which the equipment is being tested shall be 1°C/minutes.

7.5.2 Dry heat

7.5.2.1 Definition

This test determines the ability of equipment to be operated at high ambient temperatures and operate through temperature changes.

7.5.2.2 Method of measurement

The EUT shall be placed in a chamber at normal room temperature and relative humidity. The EUT and, if appropriate, any climatic control devices with which it is provided shall then be switched on. The temperature shall then be raised to and maintained at +55°C ($\pm 3^\circ\text{C}$). At the end of the period of 10 hours to 16 hours at +55°C ($\pm 3^\circ\text{C}$), the EUT shall be subjected to a performance check. The temperature of the chamber shall be maintained at +55°C ($\pm 3^\circ\text{C}$) during the whole of the performance check period. At the end of the test, the EUT shall be returned to normal environmental conditions or to those at the start of the next test.

7.5.2.3 Requirement

The equipment shall meet the requirements of the performance check.

7.5.3 Damp heat

7.5.3.1 Definition

This test determines the ability of equipment to be operated under conditions of high humidity.

7.5.3.2 Method of measurement

The EUT shall be placed in a chamber at normal room temperature and relative humidity. The temperature shall then be raised to +40°C ($\pm 2^\circ\text{C}$), and the relative humidity raised to 93 % ($\pm 3\%$) over a period of 3 hours $\pm 0,5$ hours. These

conditions shall be maintained for a period of 10 hours to 16 hours. Any climatic control devices provided in the EUT may be switched on at the conclusion of this period.

The EUT shall be switched on 30 minutes later, or after such period as agreed with the manufacturer, and shall be kept operational for at least 2 hours during which period the EUT shall be subjected to the performance check. The temperature and relative humidity of the chamber shall be maintained as specified during the whole test period.

At the end of the test period and with the EUT still in the chamber, the chamber shall be brought to room temperature in not less than 1 hours. At the end of the test the EUT shall be returned to normal environmental conditions or to those required at the start of the next test.

7.5.3.3 Requirement

The equipment shall meet the requirements of the performance check.

7.5.4 Low temperature

7.5.4.1 Definition

This test determines the ability of equipment to be operated at low temperatures. It also allows equipment to demonstrate an ability to start up at low ambient temperatures.

7.5.4.2 Method of measurement

The EUT shall be placed in a chamber at normal room temperature and relative humidity. The temperature shall then be reduced to, and be maintained at, $-15^{\circ}\text{C} (\pm 3^{\circ}\text{C})$ for a period of 10 hours to 16 hours. Any climatic control devices provided in the EUT may be switched on at the conclusion of this period. The EUT shall be switched on 30 minutes later, or after such period as agreed by the manufacturer, and shall be kept operational for at least 2 hours during which period the EUT shall be subjected to a performance check. The temperature of the chamber shall be maintained at $-15^{\circ}\text{C} (\pm 3^{\circ}\text{C})$ during the whole of the test period. At the end of the test the EUT shall be returned to normal environmental conditions or to those required at the start of the next test.

7.5.4.3 Requirement

The equipment shall meet the requirements of the performance check.

8 Transmitter

All tests on the transmitter shall be carried out with the output power switch set at its maximum except where otherwise stated.

8.1 Frequency error

8.1.1 Definition

The frequency error is the difference between the measured carrier frequency and its nominal value.

8.1.2 Method of measurement

The carrier frequency shall be measured in the absence of modulation, with the transmitter connected to an artificial antenna (subclause 6.4) and tuned to channel 16.

Measurements shall be made under normal test conditions (subclause 6.12) and under extreme test conditions (subclauses 6.13.1 and 6.13.2 applied simultaneously).

This test shall be carried out with the output power switch being set at both maximum and minimum.

8.1.3 Limits

The frequency error shall be within $\pm 1,5$ kHz.

8.2 Carrier power

8.2.1 Definition

The carrier power is the mean power delivered to the artificial antenna during one radio frequency cycle in the absence of modulation.

The rated output power is the carrier power declared by the manufacturer.

8.2.2 Method of measurement

The transmitter shall be connected to an artificial antenna (subclause 6.4) and the power delivered to this artificial antenna shall be measured. The measurements shall be made on channel 16, the highest frequency channel and the lowest frequency channel under normal test conditions (subclause 6.12) and channel 16 under extreme test conditions (subclauses 6.13.1 and 6.13.2 applied simultaneously).

8.2.3 Limits

8.2.3.1 Normal test conditions

With the output power switch set at maximum, the carrier power shall remain between 6 W and 25 W and be within $\pm 1,5$ dB of the rated output power under normal test conditions. The output power shall never however exceed 25 W.

With the output power switch set at minimum the carrier power shall remain between 0,1 W and 1 W.

8.2.3.2 Extreme test conditions

With the output power switch set at maximum, the carrier power shall remain between 6 W and 25 W and be within +2 dB, -3 dB of the rated output power under extreme conditions. The output power shall never however exceed 25 W.

With the output power switch set at minimum the carrier power shall remain between 0,1 W and 1 W.

8.3 Frequency deviation

8.3.1 Definition

For the purposes of the present document, the frequency deviation is the difference between the instantaneous frequency of the modulated radio frequency signal and the carrier frequency.

8.3.2 Maximum permissible frequency deviation

8.3.2.1 Method of measurement

The frequency deviation shall be measured at the output with the transmitter connected to an artificial antenna (subclause 6.4) and tuned to channel 16, by means of a deviation meter capable of measuring the maximum deviation, including that due to any harmonics and intermodulation products which may be generated in the transmitter.

The modulation frequency shall be varied between 100 Hz and 3 kHz. The level of this test signal shall be 20 dB above the level which produces normal test modulation (subclause 6.3). This test shall be carried out with the output power switch set at both maximum and minimum.

8.3.2.2 Limits

The maximum frequency deviation shall be ± 5 kHz.

8.3.3 Reduction of frequency deviation at modulation frequencies above 3 kHz

8.3.3.1 Method of measurement

The transmitter shall operate under normal test conditions (subclause 6.12) connected to a load as specified in subclause 6.4. The transmitter shall be modulated by the normal test modulation (subclause 6.3) and tuned to channel 16. With the input level of the modulation signal being kept constant, the modulation frequency shall be varied between 3 kHz and 25 kHz and the frequency deviation shall be measured.

8.3.3.2 Limits

For modulation frequencies between 3 kHz and 6 kHz the frequency deviation shall not exceed the frequency deviation with a modulation frequency of 3 kHz. For a modulation frequency of 6 kHz, the frequency deviation shall not exceed $\pm 1,5$ kHz, as shown in figure 1.

For modulation frequencies between 6 kHz and 25 kHz, the frequency deviation shall not exceed that given by a linear response of frequency deviation (in dB) against modulation frequency, starting at the point where the modulation frequency is 6 kHz and the frequency deviation is $\pm 1,5$ kHz and inclined at 14 dB per octave, with the frequency deviation diminishing as the modulation frequency increases, as shown in figure 1.

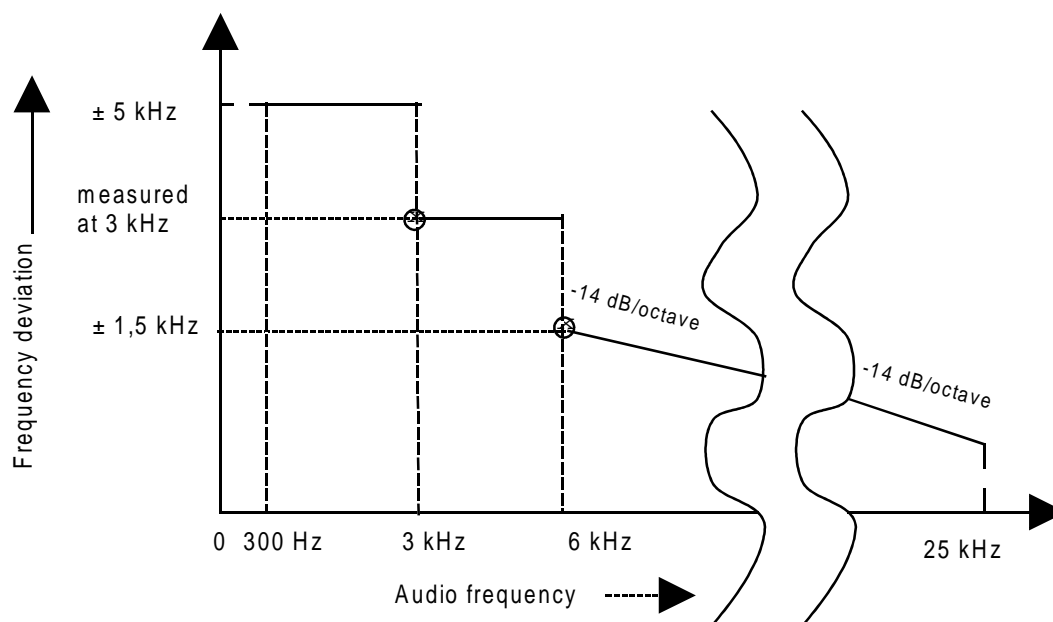

Figure 1: Frequency deviation

8.4 Sensitivity of the modulator, including microphone

8.4.1 Definition

This characteristic expresses the capability of the transmitter to produce sufficient modulation when an audio frequency signal corresponding to the normal mean speech level is applied to the microphone.

8.4.2 Method of measurement

An acoustic signal with a frequency of 1 kHz and sound level of 94 dB(A) shall be applied to the microphone. The resulting deviation shall be measured.

8.4.3 Limits

The resulting frequency deviation shall be between $\pm 1,5$ kHz and ± 3 kHz.

8.5 Audio frequency response

8.5.1 Definition

The audio frequency response is the frequency deviation of the transmitter as a function of the modulating frequency.

8.5.2 Method of measurement

A modulating signal at a frequency of 1 kHz shall be applied to the transmitter and the deviation shall be measured at the output. The audio input level shall be adjusted so that the frequency deviation is ± 1 kHz. This is the reference point in figure 2 (1 kHz corresponds to 0 dB).

The modulation frequency shall then be varied between 300 Hz and 3 kHz, with the level of the audio frequency signal being kept constant and equal to the value specified above.

8.5.3 Limit

The audio frequency response shall be within +1 dB and -3 dB of a 6 dB/octave line passing through the reference point (see figure 2).

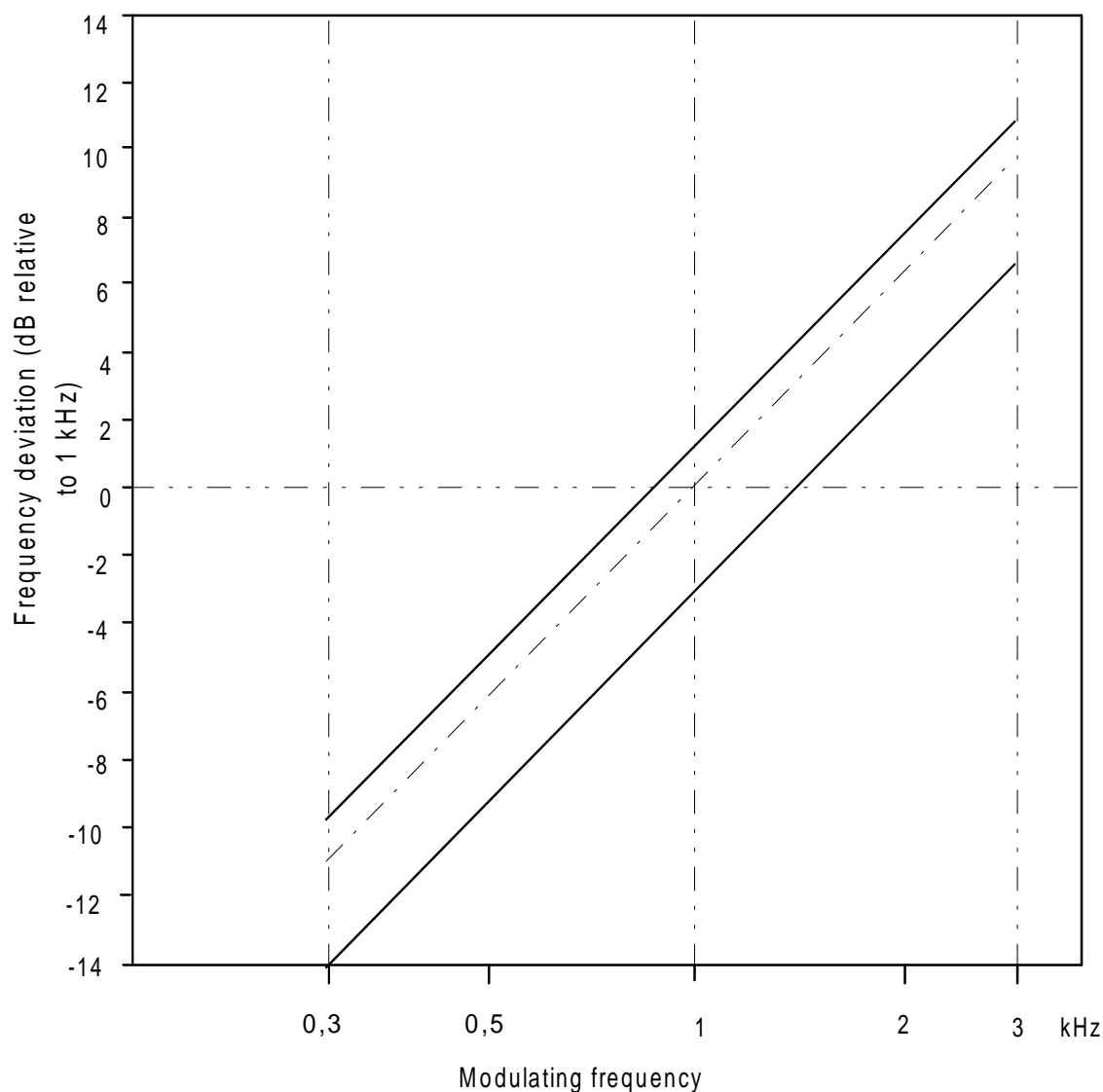

Figure 2: Audio frequency response

8.6 Audio frequency harmonic distortion of the emission

8.6.1 Definition

The harmonic distortion of the emission modulated by any audio frequency signal is defined as the ratio, expressed as a percentage, of the root mean square (r.m.s.) voltage of all the harmonic components of the fundamental frequency to the total r.m.s. voltage of the signal after linear demodulation.

8.6.2 Method of measurement

The RF signal produced by the transmitter shall be applied via an appropriate coupling device to a linear demodulator with a de-emphasis network of 6 dB per octave. This test shall be carried out with the output power switch at both maximum and minimum.

8.6.2.1 Normal test conditions

Under normal test conditions (subclause 6.12) the RF signal shall be modulated successively at frequencies of 300 Hz, 500 Hz and 1 kHz with a constant modulation index of 3.

The distortion of the audio frequency signal shall be measured at all the frequencies specified above.

8.6.2.2 Extreme test conditions

Under extreme test conditions (subclauses 6.13.1 and 6.13.2 applied simultaneously), the measurements shall be carried out at 1 kHz with a frequency deviation of ± 3 kHz.

8.6.3 Limits

The harmonic distortion shall not exceed 10 %.

8.7 Adjacent channel power

8.7.1 Definition

The adjacent channel power is that part of the total power output of a transmitter under defined conditions of modulation which falls within a specified passband centred on the nominal frequency of either of the adjacent channels. This power is the sum of the mean power produced by the modulation hum and noise of the transmitter.

8.7.2 Method of measurement

The adjacent channel power can be measured with a power measuring receiver which conforms to annex B (referred to in subclause 8.7.2 and annex B as the "receiver") ITU-R Recommendation SM 332-4 [7]:

- a) the transmitter shall be operated with the output power switch at maximum under normal test conditions. The output of the transmitter shall be linked to the input of the "receiver" by a connecting device such that the impedance presented to the transmitter is 50Ω and the level at the "receiver" input is appropriate;
- b) with the transmitter unmodulated, the tuning of the "receiver" shall be adjusted so that a maximum response is obtained. This is the 0 dB response point. The "receiver" attenuator setting and the reading of the meter shall be recorded;
- c) the tuning of the "receiver" shall be adjusted away from the carrier so that the "receiver" -6 dB response nearest to the transmitter carrier frequency is located at a displacement from the nominal carrier frequency of 17 kHz;
- d) the transmitter shall be modulated with 1,25 kHz at a level which is 20 dB higher than that required to produce ± 3 kHz deviation;
- e) the "receiver" variable attenuator shall be adjusted to obtain the same meter reading as in step b) or a known relation to it;
- f) the ratio of adjacent channel power to carrier power is the difference between the attenuator settings in steps b) and e), corrected for any differences in the reading of the meter;
- g) the measurement shall be repeated with the "receiver" tuned to the other side of the carrier.

The measurement may be made with the transmitter modulated with normal test modulation, in which case this fact shall be recorded with the test results.

8.7.3 Limits

The adjacent channel power shall not exceed a value of 70 dB below the carrier power of the transmitter without any need to be below $0,2 \mu\text{W}$.

8.8 Conducted spurious emissions conveyed to the antenna

8.8.1 Definition

Conducted spurious emissions are emissions on a frequency or frequencies which are outside the necessary bandwidth and the level of which may be reduced without affecting the corresponding transmission of information. Spurious emissions include harmonic emissions, parasitic emissions, intermodulation products and frequency conversion products, but exclude out of band emissions.

8.8.2 Method of measurement

Conducted spurious emissions shall be measured with the unmodulated transmitter connected to the artificial antenna (subclause 6.4).

The measurements shall be made over a range from 9 kHz to 2 GHz, excluding the channel on which the transmitter is operating and its adjacent channels.

The measurements for each spurious emission shall be made using a tuned radio measuring instrument or a spectrum analyser.

8.8.3 Limit

The power of any conducted spurious emission on any discrete frequency shall not exceed 0,25 μ W.

8.9 Cabinet radiation and conducted spurious emissions other than those conveyed to the antenna

8.9.1 Definitions

Cabinet radiation consists of emissions at frequency, radiated by the equipment cabinet and structures.

Conducted spurious emissions other than those conveyed to the antenna are emissions at frequencies, other than those of the carrier and the sideband components resulting from the wanted modulation process, which are produced by conduction in the wiring and accessories used with the equipment.

8.9.2 Method of measurement

On a test site, selected from annex C, the equipment shall be placed at the specified height on a non-conducting support and in position closest to normal use as declared by the manufacturer.

The transmitter antenna connector shall be connected to an artificial antenna, subclause 6.4.

The test antenna shall be orientated for vertical polarization and the length of the test antenna shall be chosen to correspond to the instantaneous frequency of the measuring receiver.

The output of the test antenna shall be connected to a measuring receiver.

The transmitter shall be switched on without modulation, and measuring receiver shall be tuned over the frequency range 30 MHz to 2 GHz, except for the channel on which the transmitter is intended to operate and its adjacent channels.

At each frequency at which a spurious component is detected:

- a) the test antenna shall be raised and lowered through the specified range of heights until a maximum signal level is detected on the measuring receiver;
- b) the transmitter shall be rotated through 360° in the horizontal plane, until the maximum signal level is detected by the measuring receiver;

- c) the maximum signal level detected by the measuring receiver shall be noted;
- d) the transmitter shall be replaced by a substitution antenna as defined in annex C;
- e) the substitution antenna shall be orientated for vertical polarization and the length of the substitution antenna shall be adjusted to correspond to the frequency of the spurious component detected;
- f) the substitution antenna shall be connected to a calibrated signal generator;
- g) the frequency of the calibrated signal generator shall be set to the frequency of the spurious component detected;
- h) the input attenuator setting of the measuring receiver shall be adjusted in order to increase the sensitivity of the measuring receiver, if necessary;
- i) the test antenna shall be raised and lowered through the specified range of heights to ensure that the maximum signal is received;
- j) the input signal to the substitution antenna shall be adjusted to the level that produces a level detected by the measuring receiver that is equal to the level noted while the spurious component was measured, corrected for the change of input attenuator setting of the measuring receiver;
- k) the input level to the substitution antenna shall be recorded as power level, corrected for the change of input attenuator setting of the measuring receiver;
- l) the measurement shall be repeated with the test antenna and the substitution antenna orientated for horizontal polarization;
- m) the measure of the effective radiated power of the spurious components is larger of the two power levels recorded for spurious component at the input to the substitution antenna, corrected for the gain of the antenna if necessary;
- n) the measurements shall be repeated with the transmitter on stand-by.

8.9.3 Limits

When the transmitter is in stand-by the cabinet radiation and spurious emissions shall not exceed 2 nW;

When the transmitter is in operation the cabinet radiation and spurious emissions shall not exceed 0,25 μ W.

8.10 Transient frequency behaviour of the transmitter

8.10.1 Definitions

The transient frequency behaviour of the transmitter is the variation in time of the transmitter frequency difference from the nominal frequency of the transmitter when the RF output power is switched on and off.

- t_{on} : according to the method of measurement described in subclause 8.10.2 the switch-on instant t_{on} of a transmitter is defined by the condition when the output power, measured at the antenna terminal, exceeds 0,1 % of the nominal power;
- t_1 : period of time starting at t_{on} and finishing according to table 2;
- t_2 : period of time starting at the end of t_1 and finishing according to table 2;
- t_{off} : switch-off instant defined by the condition when the nominal power falls below 0,1 % of the nominal power;
- t_3 : period of time that finishing at t_{off} and starting according to table 2.

Table 2: Time periods

t_1 (ms)	5,0
t_2 (ms)	20,0
t_3 (ms)	5,0

8.10.2 Method of measurement

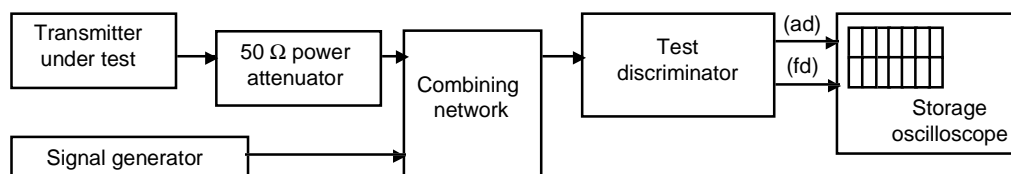

Figure 3: Measurement arrangement

Two signals shall be connected to the test discriminator via a combining network (subclause 6.1).

The transmitter shall be connected to a 50 Ω power attenuator.

A test signal generator shall be connected to the second input of the combining network.

The test signal shall be adjusted to the nominal frequency of the transmitter.

The test signal shall be modulated by a frequency of 1 kHz with a deviation of ± 25 kHz.

The test signal level shall be adjusted to correspond to 0,1% of the power of the transmitter under test measured at the input of the test discriminator. This level shall be maintained throughout the measurement.

The amplitude difference (ad) and the frequency difference (fd) output of the test discriminator shall be connected to a storage oscilloscope.

The storage oscilloscope shall be set to display the channel corresponding to the (fd) input up to ± 25 kHz.

The storage oscilloscope shall be set to a sweep rate of 10 ms/division and set so that the triggering occurs at one division from the left edge of the display.

The display shall show the 1 kHz test signal continuously.

The storage oscilloscope shall then be set to trigger on the channel corresponding to the amplitude difference (ad) input at a low input level, rising.

The transmitter shall then be switched on, without modulation, to produce the trigger pulse and a picture on the display.

The result of the change in the ratio of power between the test signal and the transmitter output will, due to the capture ratio of the test discriminator, produce two separate sides on the picture, one showing the 1 kHz test signal, the other the frequency difference of the transmitter versus time.

The moment when the 1 kHz test signal is completely suppressed is considered to provide t_{on} .

The periods of time t_1 and t_2 as defined in table 2 shall be used to define the appropriate template.

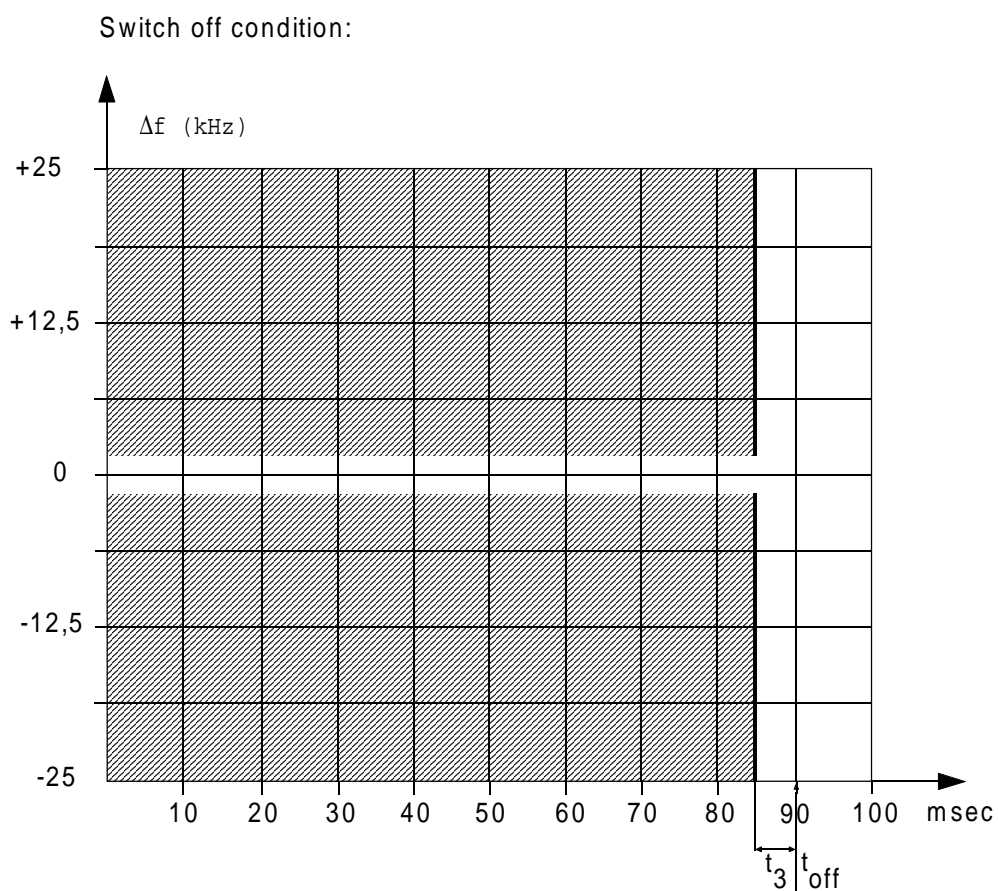
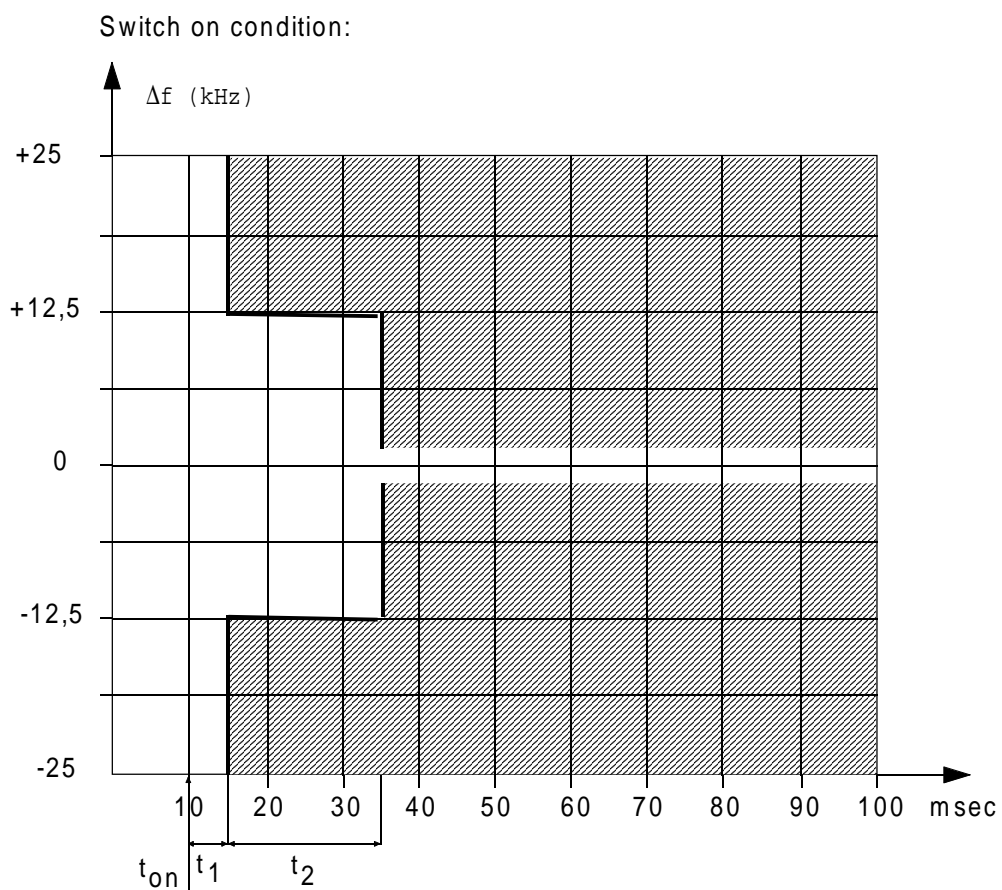

Figure 4: Storage oscilloscope view t_1 , t_2 and t_3

The result shall be recorded as frequency difference versus time.

The transmitter shall remain switched on.

The storage oscilloscope shall be set to trigger on the channel corresponding to the amplitude difference (ad) input at a high input level, decaying and set so that the triggering occurs at 1 division from the right edge of the display.

The transmitter shall then be switched off.

The moment when the 1 kHz test signal starts to rise is considered to provide t_{off} .

The period of time t_3 as defined in table 2 shall be used to define the appropriate template.

The result shall be recorded as frequency difference versus time.

8.10.3 Limits

During the periods of time t_1 and t_3 the frequency difference shall not exceed ± 25 kHz.

The frequency difference after the end of t_2 shall be within the limit of the frequency error given in subclause 8.1.

During the period of time t_2 the frequency difference shall not exceed $\pm 12,5$ kHz.

Before the start of t_3 the frequency difference shall be within the limit of the frequency error given in subclause 8.1.

8.11 Residual modulation of the transmitter

8.11.1 Definition

The residual modulation of the transmitter is the ratio, in dB, of the demodulated RF signal in the absence of wanted modulation, to the demodulated RF signal produced when the normal test modulation is applied.

8.11.2 Method of measurement

The normal test modulation defined in subclause 6.3 shall be applied to the transmitter. The high frequency signal produced by the transmitter shall be applied, via an appropriate coupling device, to a linear demodulator with a de-emphasis network of 6 dB per octave. The time constant of this de-emphasis network shall be at least 750 μs .

Precautions shall be taken to avoid the effects of emphasizing the low audio frequencies produced by internal noise.

The signal shall be measured at the demodulator output using an r.m.s. voltmeter.

The modulation shall then be switched off and the level of the residual audio frequency signal at the output shall be measured again.

8.11.3 Limit

The residual modulation shall not exceed -40 dB.

8.12 Frequency error (demodulated DSC signal)

8.12.1 Definition

The frequency error for the B- and the Y-state is the difference between the measured frequency from the demodulator and the nominal values.

8.12.2 Method of measurement

The transmitter shall be connected to the artificial antenna as specified in subclause 6.4 and a suitable FM demodulator. The transmitter shall be set to channel 70.

The transmitter shall be set to transmit a continuous B- or Y- state.

The measurement shall be performed by measuring the demodulated output, for both the continuous B- and Y-state.

The measurements shall be carried out under normal test conditions (subclause 6.12) and extreme test conditions (subclauses 6.13.1 and 6.13.2 applied simultaneously).

8.12.3 Limits

The measured frequency from the demodulator at any time for the B-state shall be within $2\ 100\ \text{Hz} \pm 10\ \text{Hz}$ and for the Y-state within $1\ 300\ \text{Hz} \pm 10\ \text{Hz}$.

8.13 Modulation index for DSC

8.13.1 Definition

This test measures the modulation index in the B and Y states.

8.13.2 Method of measurement

The transmitter shall be set to transmit continuous B and then Y signals. The frequency deviations shall be measured.

8.13.3 Limits

The modulation index shall be $2,0 \pm 10\ \%$.

8.14 Modulation rate for DSC

8.14.1 Definition

The modulation rate is the bit stream speed measured in bits per second.

8.14.2 Method of measurement

The transmitter shall be set to transmit continuous dot pattern.

The RF output terminal of the transmitter, via a suitable attenuator, shall be connected to a linear FM demodulator. The output of the demodulator shall be limited in bandwidth by a low pass filter with a cut-off frequency of 1 kHz and a slope of 12 dB/octave.

The frequency of the output shall be measured.

8.14.3 Limits

The frequency shall be $600\ \text{Hz} \pm 30\ \text{ppm}$ corresponding to a modulation rate of 1 200 baud.

8.15 Testing of generated call sequences

8.15.1 Definition

Generated call sequences are calls which comply with the requirements of ITU-R Recommendation M.493-9 [5].

8.15.2 Method of measurement

The output of the transmitter shall be suitably connected to a calibrated apparatus for decoding and printing out the information content of the call sequences generated by the equipment.

The transmitter shall be set to transmit DSC calls as specified in annex A.

8.15.3 Requirement

The requirements of ITU-R Recommendation M.493-9 [5] regarding message composition and content shall be met.

The generated calls shall be analysed with the calibrated apparatus for correct configuration of the signal format, including time diversity.

It shall be verified that, after transmission of a DSC call, the transmitter re-tunes to the original channel. However in the case of a distress call the transmitter shall tune to channel 16 and automatically select the maximum power.

The telecommands used and the channels tested for switching shall be stated in the test report.

9 Radiotelephone receiver

9.1 Harmonic distortion and rated audio-frequency output power

9.1.1 Definition

The harmonic distortion at the receiver output is defined as the ratio, expressed as a percentage, of the total r.m.s. voltage of all the harmonic components of the modulation audio frequency to the total r.m.s. voltage of the signal delivered by the receiver.

The rated audio frequency output power is the value stated by the manufacturer to be the maximum power available at the output, for which all the requirements of the present document are met.

9.1.2 Methods of measurement

Test signals at levels of +60 dB μ V (e.m.f.) and +100 dB μ V (e.m.f.), at a carrier frequency equal to the nominal frequency of the receiver and modulated by the normal test modulation (subclause 6.3) shall be applied in succession to the receiver input under the conditions specified in subclause 6.1.

For each measurement, the receiver's audio-frequency volume control shall be set so as to obtain, in a resistive load which simulates the receiver's operating load, the rated audio frequency output power (subclause 9.1.1). The value of this load shall be stated by the manufacturer.

Under normal test conditions (subclause 6.12) the test signal shall be modulated successively at 300 Hz, 500 Hz and 1 kHz with a constant modulation index of 3 (ratio between the frequency deviation and the modulation frequency). The harmonic distortion and audio frequency output power shall be measured at all the frequencies specified above.

9.1.3 Limits

The rated audio-frequency output power shall be at least:

- 2 W in a loudspeaker;
- 1 mW in the handset earphone.

The harmonic distortion shall not exceed 10 %.

9.2 Audio frequency response

9.2.1 Definition

The audio frequency response is defined as the variation in the receiver's audio frequency output level as a function of the modulation frequency of the radio frequency signal with constant deviation applied to its input.

9.2.2 Method of measurement

A test signal of +60 dB μ V (e.m.f.), at a carrier frequency equal to the nominal frequency of the receiver and modulated with normal test modulation (subclause 6.3) shall be applied to the receiver antenna port under the conditions specified in subclause 6.1.

The receiver's audio-frequency power control shall be set so as to produce a power level equal to 50 % of the rated output power (subclause 9.1). This setting shall remain unchanged during the test.

The frequency deviation shall then be reduced to \pm 1kHz and the audio output is the reference point in figure 5 (1 kHz corresponds to 0 dB).

The frequency deviation shall remain constant while the modulation frequency is varied between 300 Hz and 3 kHz and the output level shall then be measured.

The measurement shall be repeated with a test signal at frequencies 1,5 kHz above and below the nominal frequency of the receiver.

9.2.3 Limits

The audio frequency response shall not deviate by more than +1 dB or -3 dB from a characteristic giving the output level as a function of the audio frequency, decreasing by 6 dB per octave and passing through the measured point at 1 kHz (see figure 5).

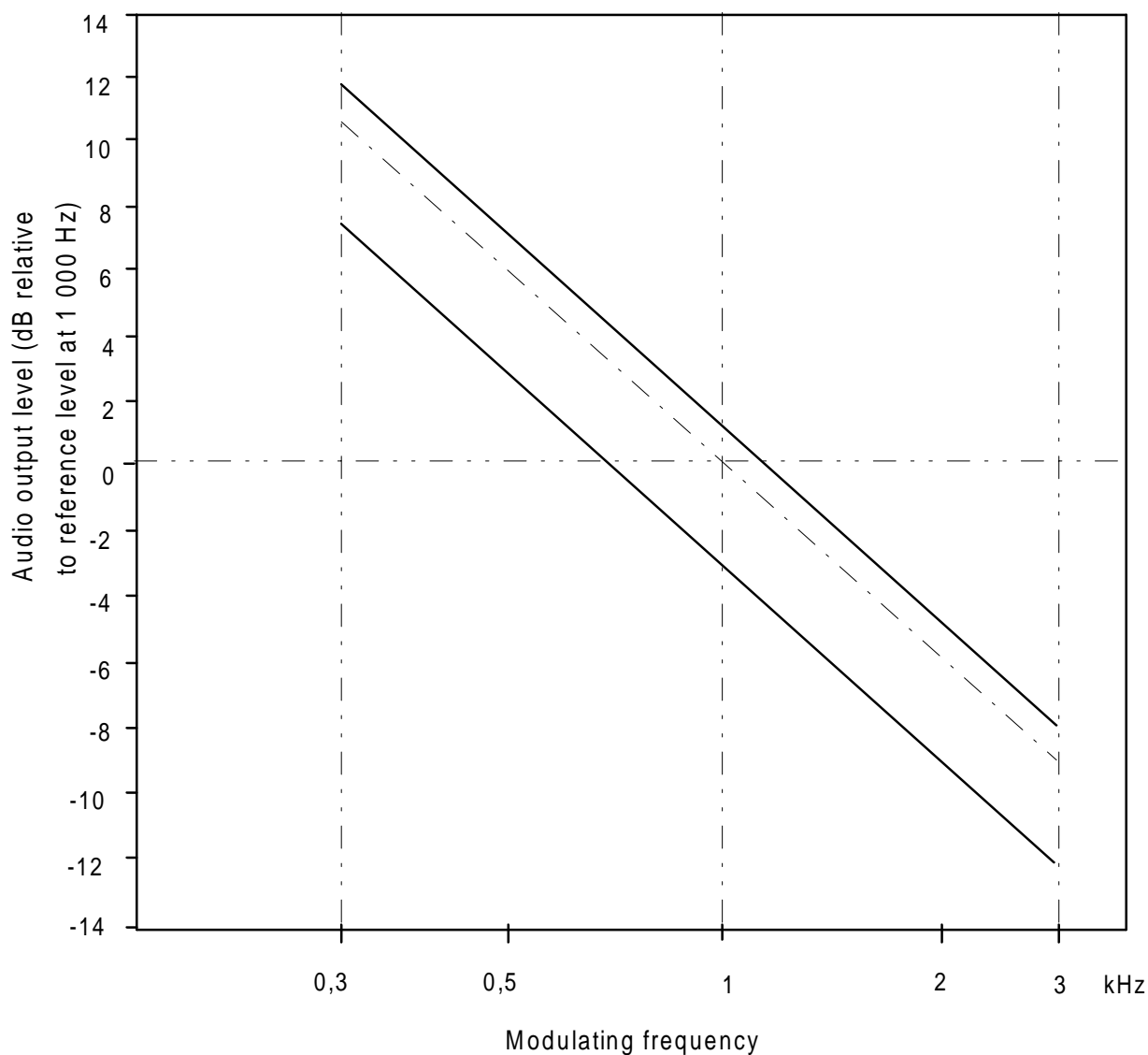

Figure 5: Audio frequency response

9.3 Maximum usable sensitivity

9.3.1 Definition

The maximum usable sensitivity of the receiver is the minimum level of the signal (e.m.f.) at the nominal frequency of the receiver which, when applied to the receiver input with normal test modulation (subclause 6.3), will produce:

- in all cases, an audio frequency output power equal to 50 % of the rated output power (subclause 9.1); and
- a Signal + Noise + Distortion to Noise + Distortion (SINAD) ratio of 20 dB, measured at the receiver output through a psophometric telephone filtering network such as described in ITU-T Recommendation P.53 [3].

9.3.2 Method of measurement

A test signal at a carrier frequency equal to the nominal frequency of the receiver, modulated by the normal test modulation (subclause 6.3) shall be applied to the receiver input. An audio frequency load and a measuring instrument for measuring SINAD ratio (through a psophometric network as specified in subclause 9.3.1) shall be connected to the receiver output terminals.

The level of the test signal shall be adjusted until a SINAD ratio of 20 dB is obtained, using the psophometric network and with the receiver's audio-frequency power control adjusted to produce 50 % of the rated output power. Under these conditions, the level of the test signal at the input is the value of the maximum usable sensitivity.

The measurements shall be made under normal test conditions (subclause 6.12) and under extreme test conditions (subclauses 6.13.1 and 6.13.2 applied simultaneously).

A receiver output power variation of ± 3 dB relative to 50 % of the rated output power may be allowed for sensitivity measurements under extreme test conditions.

9.3.3 Limits

The maximum usable sensitivity shall not exceed +6 dB μ V (e.m.f.) under normal test conditions and +12 dB μ V (e.m.f.) under extreme test conditions.

9.4 Co-channel rejection

9.4.1 Definition

The co-channel rejection is a measure of the capability of the receiver to receive a wanted modulated signal without exceeding a given degradation due to the presence of an unwanted modulated signal, both signals being at the nominal frequency of the receiver.

9.4.2 Method of measurement

The two input signals shall be connected to the receiver via a combining network (subclause 6.1). The wanted signal shall have normal test modulation (subclause 6.3). The unwanted signal shall be modulated by 400 Hz with a deviation of ± 3 kHz. Both input signals shall be at the nominal frequency of the receiver under test and the measurement repeated for displacements of the unwanted signal of ± 3 kHz.

The wanted input signal shall be set to the value corresponding to the measured maximum usable sensitivity (subclause 9.3). The amplitude of the unwanted input signal shall then be adjusted until the SINAD ratio (psophometrically weighted) at the output of the receiver is reduced to 14 dB.

The co-channel rejection ratio shall be expressed as the ratio in dB of the level of the unwanted signal to the level of the wanted signal at the receiver input for which the specified reduction in SINAD ratio occurs.

9.4.3 Limit

The co-channel rejection ratio shall be between -10 dB and 0 dB.

9.5 Adjacent channel selectivity

9.5.1 Definition

The adjacent channel selectivity is a measure of the capability of the receiver to receive a wanted modulated signal without exceeding a given degradation due to the presence of an unwanted modulated signal which differs in frequency from the wanted signal by 25 kHz.

9.5.2 Method of measurement

The two input signals shall be applied to the receiver input via a combining network (subclause 6.1). The wanted signal shall be at the nominal frequency of the receiver and shall have normal test modulation (subclause 6.3). The unwanted signal shall be modulated by 400 Hz with a deviation of ± 3 kHz, and shall be at the frequency of the channel immediately above that of the wanted signal.

The wanted input signal level shall be set to the value corresponding to the maximum usable sensitivity. The amplitude of the unwanted input signal shall then be adjusted until the SINAD ratio at the receiver output, psophometrically weighted, is reduced to 14 dB. The measurement shall be repeated with an unwanted signal at the frequency of the channel below that of the wanted signal.

The adjacent channel selectivity shall be expressed as the lower value of the ratios in dB for the upper and lower adjacent channels of the level of the unwanted signal to the level of the wanted signal.

The measurements shall then be repeated under extreme test conditions (subclauses 6.13.1 and 6.13.2 applied simultaneously) with the wanted signal set to the value corresponding to the maximum usable sensitivity under these conditions.

9.5.3 Limits

The adjacent channel selectivity shall be not less than 70 dB under normal test conditions and not less than 60 dB under extreme test conditions.

9.6 Spurious response rejection

9.6.1 Definition

The spurious response rejection is a measure of the capability of the receiver to discriminate between the wanted modulated signal at the nominal frequency and an unwanted signal at any other frequency at which a response is obtained.

9.6.2 Method of measurement

Two input signals shall be applied to the receiver input via a combining network (subclause 6.1). The wanted signal shall be at the nominal frequency of the receiver and shall have normal test modulation (subclause 6.3).

The unwanted signal shall be modulated by 400 Hz with a deviation of ± 3 kHz.

The wanted input signal level shall be set to the value corresponding to the maximum usable sensitivity. The amplitude of the unwanted input signal shall be adjusted to an e.m.f. of +86 dB μ V. The frequency shall then be swept over the frequency range from 100 kHz to 2 000 MHz.

At any frequency at which a response is obtained, the input level shall be adjusted until the SINAD ratio psophometrically weighted, is reduced to 14 dB.

The spurious response rejection ratio shall be expressed as the ratio in dB between the unwanted signal and the wanted signal at the receiver input when the specified reduction in the SINAD ratio is obtained.

9.6.3 Limit

At any frequency separated from the nominal frequency of the receiver by more than 25 kHz, the spurious response rejection ratio shall be not less than 70 dB.

9.7 Intermodulation response

9.7.1 Definition

The intermodulation response is a measure of the capability of a receiver to receive a wanted modulated signal without exceeding a given degradation due to the presence of two or more unwanted signals with a specific frequency relationship to the wanted signal frequency.

9.7.2 Method of measurement

Three signal generators, A, B and C shall be connected to the receiver via a combining network (subclause 6.1). The wanted signal, represented by signal generator A shall be at the nominal frequency of the receiver and shall have normal test modulation (subclause 6.3). The unwanted signal from signal generator B shall be unmodulated and adjusted to the frequency 50 kHz above (or below) the nominal frequency of the receiver. The second unwanted signal from signal generator C shall be modulated by 400 Hz with a deviation of ± 3 kHz, and adjusted to a frequency 100 kHz above (or below) the nominal frequency of the receiver.

The wanted input signal shall be set to a value corresponding to the maximum usable sensitivity. The amplitude of the two unwanted signals shall be maintained equal and shall be adjusted until the SINAD ratio at the receiver output, psophometrically weighted, is reduced to 14 dB. The frequency of signal generator B shall be adjusted slightly to produce the maximum degradation of the SINAD ratio. The level of the two unwanted test signals shall be readjusted to restore the SINAD ratio of 14 dB. The intermodulation response ratio shall be expressed as the ratio in dB between the two unwanted signals and the wanted signal at the receiver input, when the specified reduction in the SINAD ratio is obtained.

9.7.3 Limit

The intermodulation response ratio shall be greater than 68 dB.

9.8 Blocking or desensitization

9.8.1 Definition

Blocking is a change (generally a reduction) in the wanted output power of the receiver or a reduction of the SINAD ratio due to an unwanted signal on another frequency.

9.8.2 Method of measurement

Two input signals shall be applied to the receiver via a combining network (subclause 6.1). The modulated wanted signal shall be at the nominal frequency of the receiver and shall have normal test modulation (subclause 6.3). Initially the unwanted signal shall be switched off and the wanted signal set to the value corresponding to the maximum usable sensitivity.

The output power of the wanted signal shall be adjusted, where possible, to 50 % of the rated output power and in the case of stepped volume controls, to the first step that provides an output power of at least 50 % of the rated output power. The unwanted signal shall be unmodulated and the frequency shall be swept between +1 MHz and +10 MHz, and also between -1 MHz and -10 MHz, relative to the nominal frequency of the receiver. The input level of the unwanted signal, at all frequencies in the specified ranges, shall be so adjusted that the unwanted signal causes:

- a) a reduction of 3 dB in the output level of the wanted signal; or
- b) a reduction to 14 dB of the SINAD ratio at the receiver output using a psophometric telephone filtering network such as described in ITU-T Recommendation P.53 [3] whichever occurs first. This level shall be noted.

9.8.3 Limit

The blocking level for any frequency within the specified ranges, shall be not less than 90 dB μ V (e.m.f.), except at frequencies on which spurious responses are found (subclause 9.6).

9.9 Spurious emissions

9.9.1 Definition

Spurious emissions from the receiver are components at any frequency, present at the receiver input port.

The level of spurious emissions shall be measured as the power level at the antenna.

9.9.2 Method of measuring the power level

Spurious emissions shall be measured as the power level of any discrete signal at the input terminals of the receiver. The receiver input terminals are connected to a spectrum analyser or selective voltmeter having an input impedance of 50 Ω and the receiver is switched on.

If the detecting device is not calibrated in terms of power input, the level of any detected components shall be determined by a substitution method using a signal generator.

The measurements shall extend over the frequency range of 9 kHz to 2 GHz.

9.9.3 Limit

The power of any spurious emission shall not exceed 2 nW at any frequency in the range between 9 kHz and 2 GHz.

9.10 Radiated spurious emissions

9.10.1 Definition

Radiated spurious emissions from the receiver are components at any frequency radiated by the equipment cabinet and the structure.

9.10.2 Method of measurements

On a test site, selected from annex C, the equipment shall be placed at the specified height on a non-conducting support and in position closest to normal use as declared by the manufacturer.

The test antenna shall be orientated for vertical polarization and the length of the test antenna shall be chosen to correspond to the instantaneous frequency of the measuring receiver.

The output of the test antenna shall be connected to a measuring receiver.

The receiver shall be switched on without modulation, and measuring receiver shall be tuned over the frequency range 30 MHz to 2 GHz.

At each frequency at which a spurious component is detected:

- a) the test antenna shall be raised and lowered through the specified range of heights until a maximum signal level is detected on the measuring receiver;
- b) the receiver shall be rotated through 360° in the horizontal plane, until the maximum signal level is detected by the measuring receiver;
- c) the maximum signal level detected by the measuring receiver shall be noted;
- d) the receiver shall be replaced by a substitution antenna as defined in annex C;
- e) the substitution antenna shall be orientated for vertical polarization and the length of the substitution antenna shall be adjusted to correspond to the frequency of the spurious component detected;
- f) the substitution antenna shall be connected to a calibrated signal generator;
- g) the frequency of the calibrated signal generator shall be set to the frequency of the spurious component detected;
- h) the input attenuator setting of the measuring receiver shall be adjusted in order to increase the sensitivity of the measuring receiver, if necessary;
- i) the test antenna shall be raised and lowered through the specified range of heights to ensure that the maximum signal is received;

- j) the input signal to the substitution antenna shall be adjusted to the level that produces a level detected by the measuring receiver that is equal to the level noted while the spurious component was measured, corrected for the change of input attenuator setting of the measuring receiver;
- k) the input level to the substitution antenna shall be recorded as power level, corrected for the change of input attenuator setting of the measuring receiver;
- l) the measurement shall be repeated with the test antenna and the substitution antenna orientated for horizontal polarization;
- m) the measure of the effective radiated power of the spurious components is larger of the two power levels recorded for spurious component at the input to the substitution antenna, corrected for the gain of the antenna if necessary.

9.10.3 Limit

The power of any spurious radiation shall not exceed 2 nW at any frequency in the range between 30 MHz and 2 GHz.

9.11 Receiver residual noise level

9.11.1 Definition

The receiver residual noise level is defined as the ratio, in dB, of the audio-frequency power of the noise and hum resulting from spurious effects of the power supply system or from other causes, to the audio-frequency power produced by a high-frequency signal of average level, modulated by the normal test modulation and applied to the receiver input.

9.11.2 Method of measurement

A test signal with a level of +30 dB μ V (e.m.f.) at a carrier frequency equal to the nominal frequency of the receiver, and modulated by the normal test modulation specified in subclause 6.3, shall be applied to the receiver input. An audio frequency load shall be connected to the output terminals of the receiver. The audio frequency power control shall be set so as to produce the rated output power level conforming to subclause 9.1.

The output signal shall be measured by an r.m.s. voltmeter having a -6 dB bandwidth of at least 20 kHz. The modulation shall then be switched off and the audio-frequency output level measured again.

9.11.3 Limit

The receiver residual noise level shall not exceed -40 dB.

9.12 Squelch operation

9.12.1 Definition

The purpose of the squelch facility is to mute the receiver audio output signal when the level of the signal at the receiver input is less than a given value.

9.12.2 Method of measurement

- a) With the squelch facility switched off, a test signal of +30 dB μ V (e.m.f.), at a carrier frequency equal to the nominal frequency of the receiver and modulated by the normal test modulation specified in subclause 6.3, shall be applied to the input terminals of the receiver. An audio frequency load and a psophometric filtering network shall be connected to the output terminals of the receiver. The receiver's audio-frequency power control shall be set so as to produce the rated output power defined in subclause 9.1.

The output signal shall be measured with the aid of an r.m.s. voltmeter.

The input signal shall then be suppressed, the squelch facility switched on and the audio frequency output level measured again.

- b) With the squelch facility switched off again, a test signal modulated by the normal test modulation shall be applied to the receiver input at a level of +6 dB μ V (e.m.f.) and the receiver shall be set to produce 50 % of the rated output power. The level of the input signal shall then be reduced and the squelch facility shall be switched on. The input signal shall then be increased until the above-mentioned output power is reached. The SINAD ratio and the input level shall then be measured.
- c) (Applicable only to equipment with continuously adjustable squelch control.) With the squelch facility switched off, a test signal with normal test modulation shall be applied to the receiver input at a level of +6 dB μ V (e.m.f.), and the receiver shall be adjusted to give 50 % of the rated audio output power. The level of the input signal shall then be reduced and the squelch facility shall be switched on at its maximum position and the level of the input signal increased until the output power again is 50 % of the rated audio output power.

9.12.3 Limits

Under the conditions specified in a) subclause 9.12.2, the audio frequency output power shall not exceed -40 dB relative to the rated output power.

Under the conditions specified in b) subclause 9.12.2, the input level shall not exceed +6 dB μ V (e.m.f.) and the SINAD ratio shall be at least 20 dB.

Under the conditions specified in c) subclause 9.12.2, the input signal shall not exceed +6 dB μ V (e.m.f.) when the control is set at maximum.

9.13 Squelch hysteresis

9.13.1 Definition

Squelch hysteresis is the difference in dB between the receiver input signal levels at which the squelch opens and closes.

9.13.2 Method of measurement

If there is any squelch control on the exterior of the equipment it shall be placed in its maximum muted position. With the squelch facility switched on, an unmodulated input signal at a carrier frequency equal to the nominal frequency of the receiver shall be applied to the input of the receiver at a level sufficiently low to avoid opening the squelch. The input signal shall be increased at the level just opening the squelch. This input level shall be recorded. With the squelch still open, the level of the input signal shall be slowly decreased until the squelch mutes the receiver audio output again.

9.13.3 Limit

The squelch hysteresis shall be between 3 dB and 6 dB.

9.14 Multiple watch characteristic

9.14.1 Definition

The scanning period is the time between the start of two successive samples of the priority channel in the absence of a signal on that channel.

The dwell time on the priority channel is the time between the start and finish of any sample of the priority channel in the absence of a signal on that channel.

The dwell time on the additional channel is the time between the start and finish of any sample of the additional channel.

9.14.2 Method of measurement

The equipment shall be adjusted to scan the priority channel and one additional channel.

The squelch shall be operational and so adjusted that the receiver just mutes on both the channels.

A test signal at the carrier frequency equal to the nominal frequency of the additional channel of the receiver, modulated by the normal test modulation (subclause 6.3) shall be connected to the receiver via a combining network (subclause 6.1). A second test signal with a frequency equal to the nominal frequency of the priority channel having no modulation shall be connected to the receiver via the other input of the combining network. The level of the two test signals shall be +12 dB μ V (e.m.f.) at the receiver input.

A storage oscilloscope shall be connected to the audio output. Initially the output of the test signal on the priority channel shall be switched off. The scanning process is started and the output observed on the oscilloscope. The gap between and the duration of the audio bursts shall be measured. Now the test signal on the priority channel shall be switched on and the scanning shall stop on the priority channel after the last burst and within the dwell time on the priority channel. The measurement shall be carried out where the additional channel is a simplex channel and repeated where it is a duplex channel.

The measurements shall be made under normal and under extreme test conditions.

9.14.3 Limits

The scanning period shall not exceed 2 s.

The dwell time on the priority channel shall not exceed 150 ms.

The dwell time on the additional channel shall be between 850 ms and 2 s as indicated by the time of the gap between two output bursts.

10 Receiver for DSC decoder

10.1 Maximum usable sensitivity

10.1.1 Definition

The maximum usable sensitivity of the receiver is the minimum level of the signal (e.m.f.) at the nominal frequency of the receiver which when applied to the receiver input with a test modulation will produce a bit error ratio of 10^{-2} .

10.1.2 Method of measurement

DSC standard test signal (subclause 6.8) containing DSC calls shall be applied to the receiver input. The input level shall be 0 dB μ V under normal test conditions (subclause 6.12) and +6 dB μ V under extreme test conditions (subclauses 6.13.1 and 6.13.2 applied simultaneously).

The measurement shall be repeated under normal test conditions at the nominal carrier frequency $\pm 1,5$ kHz.

The bit error ratio in the decoder output shall be determined as described in subclause 6.9.

10.1.3 Limits

The bit error ratio shall be equal to or less than 10^{-2} .

10.2 Co-channel rejection

10.2.1 Definition

The co-channel rejection is a measure of the capability of the receiver to receive a wanted modulated signal without exceeding a given degradation due to the presence of an unwanted modulated signal, both signals being at the nominal frequency of the receiver.

10.2.2 Method of measurement

The two input signals shall be connected to the receiver input terminal via a combining network (subclause 6.1). The wanted signal shall be the DSC standard test signal (subclause 6.8) containing DSC calls. The level of the wanted signal shall be +3 dB μ V. The unwanted signal shall be modulated by 400 Hz with a deviation of ± 3 kHz. Both input signals shall be at the nominal frequency of the receiver under test and the measurement shall be repeated for displacements of the unwanted signal of up to ± 3 kHz.

The input level of the unwanted signal shall be -5 dB μ V.

The bit error ratio in the decoder output shall be determined as described in subclause 6.9.

10.2.3 Limits

The bit error ratio shall be equal to or less than 10^{-2} .

10.3 Adjacent channel selectivity

10.3.1 Definition

The adjacent channel selectivity is a measure of the capability of the receiver to receive a wanted modulated signal without exceeding a given degradation due to the presence of an unwanted modulated signal which differs in frequency from the wanted signal by 25 kHz.

10.3.2 Method of measurement

The two input signals shall be connected to the receiver input terminal via a combining network (subclause 6.1).

The wanted signal shall be the DSC standard test signal (subclause 6.8) containing DSC calls. The level of the wanted signal shall be +3 dB μ V under normal test conditions and +9 dB μ V under extreme test conditions.

The unwanted signal shall be modulated to 400 Hz with a deviation of ± 3 kHz. The unwanted signal shall be tuned to the centre frequency of the upper adjacent channel. The input level of the unwanted signal shall be 73 dB μ V under normal test conditions and 63 dB μ V under extreme test conditions.

The bit error ratio in the decoder output shall be determined as described in subclause 6.9.

The measurement shall be repeated with the unwanted signal tuned to the centre frequency of the lower adjacent channel.

The measurement shall be carried out under normal test conditions (subclause 6.12) and under extreme test conditions (subclauses 6.13.1 and 6.13.2 applied simultaneously).

10.3.3 Limits

The bit error ratio shall be equal to or less than 10^{-2} .

10.4 Spurious response and blocking immunity

10.4.1 Definition

The spurious response and blocking immunity is a measure of the capability of the receiver to receive a wanted modulated signal without exceeding a given degradation due to the presence of an unwanted modulated signal with frequencies outside the pass band of the receiver.

10.4.2 Method of measurement

The two input signals shall be connected to the receiver input terminal via a combining network (subclause 6.1).

The wanted signal shall be the DSC standard test signal (subclause 6.8) containing DSC calls. The level of the wanted signal shall be +3 dB μ V.

For the spurious response test the unwanted signal shall be unmodulated. The frequency shall be varied over the range 9 kHz to 2 GHz with the exception of the channel of the wanted signal and its adjacent channels. The unwanted signal level shall be 73 dB μ V. Where spurious response occurs, the bit error ratio shall be determined.

For the blocking test the unwanted signal shall be unmodulated. The frequency shall be varied between -10 MHz and -1 MHz and also between +1 MHz and +10 MHz relative to the nominal frequency of the wanted signal. The unwanted signal shall be at a level of 93 dB μ V. Where blocking occurs, the bit error ratio shall be determined.

The bit error ratio in the decoder output shall be determined as described in subclause 6.9.

10.4.3 Limits

The bit error ratio shall be equal to or less than 10^{-2} .

10.5 Intermodulation response

10.5.1 Definition

The intermodulation response is a measure of the capability of the receiver to receive a wanted modulated signal without exceeding a given degradation due to the presence of two or more unwanted signals with a specific frequency relationship to the wanted signal frequency.

10.5.2 Method of measurement

The three input signals shall be connected to the receiver input terminal via a combining network (subclause 6.1).

The wanted signal represented by signal generator A shall be at the nominal frequency of the receiver and shall be the DSC standard test signal (subclause 6.8) containing DSC calls. The level of the wanted signal shall be +3 dB μ V.

The unwanted signals shall be applied, both at the same level. The unwanted signal from signal generator B shall be unmodulated and adjusted to a frequency 50 kHz above (or below) the nominal frequency of the receiver. The second unwanted signal from signal generator C shall be modulated by 400 Hz with a deviation of ± 3 kHz and adjusted to a frequency 100 kHz above (or below) the nominal frequency of the receiver.

The input level of the unwanted signals shall be 68 dB μ V.

The bit error ratio in the decoder output shall be determined as described in subclause 6.9.

10.5.3 Limits

The bit error ratio shall be equal to or less than 10^{-2} .

10.6 Dynamic range

10.6.1 Definition

The dynamic range of the equipment is the range from the minimum to the maximum level of a radio frequency input signal at which the bit error ratio in the output of the decoder does not exceed a specified value.

10.6.2 Method of measurement

A test signal in accordance with the DSC standard test signal (subclause 6.8) containing consecutive DSC calls, shall be applied to the receiver input. The level of the test signal shall alternate between 100 dB μ V and 0 dB μ V.

The bit error ratio in the decoder output shall be determined as described in subclause 6.9.

10.6.3 Limit

The bit error ratio shall be equal to or less than 10^{-2} .

10.7 Spurious emissions

10.7.1 Definition

Spurious emissions from the receiver are components at any frequency, present at the receiver input port.

The level of spurious emissions shall be measured as the power level at the antenna.

10.7.2 Method of measuring the power level

Spurious emissions shall be measured as the power level of any discrete signal at the input terminals of the receiver. The receiver input terminals are connected to a spectrum analyser or selective voltmeter having an input impedance of 50 Ω and the receiver is switched on.

If the detecting device is not calibrated in terms of power input, the level of any detected components shall be determined by a substitution method using a signal generator.

The measurements shall extend over the frequency range of 9 kHz to 2 GHz.

10.7.3 Limit

The power of any spurious emission shall not exceed 2 nW at any frequency in the range between 9 kHz and 2 GHz.

10.8 Radiated spurious emissions

10.8.1 Definition

Radiated spurious emissions from the receiver are components at any frequency radiated by the equipment cabinet and the structure.

10.8.2 Method of measurements

On a test site, selected from annex C, the equipment shall be placed at the specified height on a non-conducting support and in position closest to normal use as declared by the manufacturer.

The test antenna shall be orientated for vertical polarization and the length of the test antenna shall be chosen to correspond to the instantaneous frequency of the measuring receiver.

The output of the test antenna shall be connected to a measuring receiver.

The receiver shall be switched on without modulation, and measuring receiver shall be tuned over the frequency range 30 MHz to 2 GHz.

At each frequency at which a spurious component is detected:

- a) the test antenna shall be raised and lowered through the specified range of heights until a maximum signal level is detected on the measuring receiver;
- b) the receiver shall be rotated through 360° in the horizontal plane, until the maximum signal level is detected by the measuring receiver;
- c) the maximum signal level detected by the measuring receiver shall be noted;
- d) the receiver shall be replaced by a substitution antenna as defined in annex C;
- e) the substitution antenna shall be orientated for vertical polarization and the length of the substitution antenna shall be adjusted to correspond to the frequency of the spurious component detected;
- f) the substitution antenna shall be connected to a calibrated signal generator;
- g) the frequency of the calibrated signal generator shall be set to the frequency of the spurious component detected;
- h) the input attenuator setting of the measuring receiver shall be adjusted in order to increase the sensitivity of the measuring receiver, if necessary;
- i) the test antenna shall be raised and lowered through the specified range of heights to ensure that the maximum signal is received;
- j) the input signal to the substitution antenna shall be adjusted to the level that produces a level detected by the measuring receiver that is equal to the level noted while the spurious component was measured, corrected for the change of input attenuator setting of the measuring receiver;
- k) the input level to the substitution antenna shall be recorded as power level, corrected for the change of input attenuator setting of the measuring receiver;
- l) the measurement shall be repeated with the test antenna and the substitution antenna orientated for horizontal polarization;
- m) the measure of the effective radiated power of the spurious components is larger of the two power levels recorded for spurious component at the input to the substitution antenna, corrected for the gain of the antenna if necessary.

10.8.3 Limit

The power of any spurious radiation shall not exceed 2 nW at any frequency in the range between 30 MHz and 2 GHz.

10.9 Verification of correct decoding of various types of DSC calls

10.9.1 Definition

DSC call sequences are calls that comply with ITU-R Recommendation M.493-9 [5].

10.9.2 Method of measurement

The input terminal of the receiver shall be suitably connected to a calibrated apparatus for generation of digital selective call signals.

DSC calls as specified in annex A shall be applied to the receiver.

10.9.3 Requirement

The requirements of ITU-R Recommendation M.493-9 [5] regarding message composition and content shall be met.

The decoded call sequences at the output of the receiver shall be examined for correct technical format, including error-check characters.

When receiver measurements are made by use of a printer or a computer, a check shall be made to ensure accordance between printer output and display indication.

It shall be verified that the equipment is capable of switching to a channel identified in the DSC call.

The telecommands used and channels tested for switching shall be stated in the test report.

Annex A (normative): DSC Calls

Table A.1: DSC calls

Format Specifier	Category	1st Telecommand (Symbol No.)	Receive	Transmit
Distress		F3E/G3E simplex (100)	X	X
All ships	Distress	Distress Ack (110)	X	
All ships	Distress	Distress Relay (112)	X	
All ships	Urgency	F3E/G3E simplex (100)	X	X
All ships	Safety	F3E/G3E simplex (100)	X	X
Individual	Urgency	F3E/G3E simplex (100)	X	
Individual	Safety	F3E/G3E simplex (100)	X	
Individual	Routine	F3E/G3E simplex (100)	X	X
Group	Routine	F3E/G3E simplex (100)	X	X
2nd Telecommand Transmit and Receive (126) No information				

Annex B (normative): Measuring receiver for adjacent channel power measurement

B.1 Power measuring receiver specification

The power measuring receiver consists of a mixer, an IF filter, an oscillator, an amplifier, a variable attenuator and an r.m.s. value indicator. Instead of the variable attenuator with the r.m.s. value indicator it is also possible to use an r.m.s. voltmeter calibrated in dB. The technical characteristics of the power measuring receiver are given below (see also ITU-R Recommendation SM 332-4 [7]).

B.1.1 IF filter

The IF filter shall be within the limits of the following selectivity characteristics.

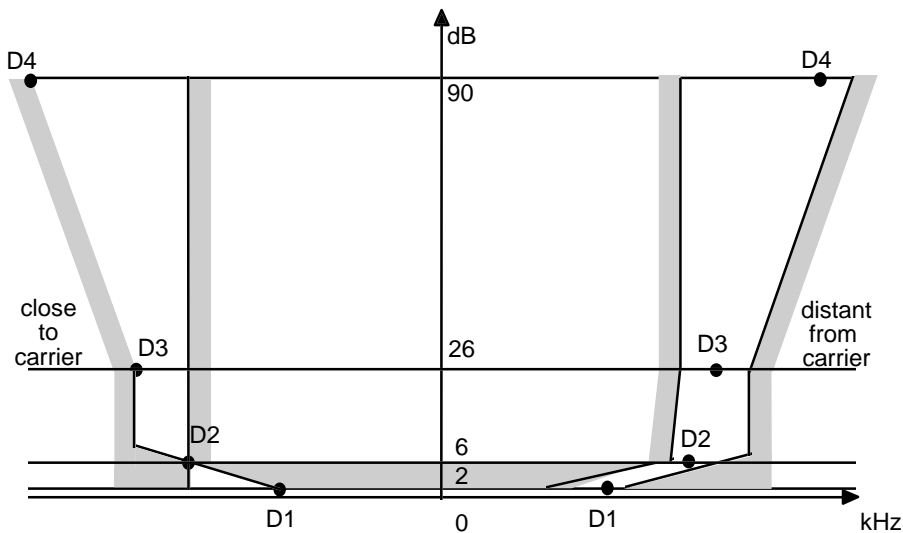

Figure B.1: IF filter characteristics

The selectivity characteristics shall keep the frequency separations shown in table B.1 from the nominal centre frequency of the adjacent channel:

Table B.1: Selectivity characteristic

Frequency separation of filter curve from nominal centre frequency of adjacent channel (kHz)			
D1	D2	D3	D4
5,0	8,0	9,25	13,25

The attenuation points shall not exceed the tolerances shown in tables B.2 and B.3

Table B.2: Attenuation points close to carrier

Tolerance range (kHz)			
D1	D2	D3	D4
+3,1	± 0,1	-1,35	-5,35

Table B.3: Attenuation points distant from the carrier

Tolerance range (kHz)			
D1	D2	D3	D4
± 3,5	± 3,5	± 3,5	+3,5 -7,5

The minimum attenuation of the filter outside the 90 dB attenuation points shall be equal to or greater than 90 dB.

B.1.2 Attenuation indicator

The attenuation indicator shall have a minimum range of 80 dB and a reading accuracy of 1 dB. With a view to future regulations an attenuation of 90 dB or more is recommended.

B.1.3 R.M.S. value indicator

The instrument shall accurately indicate non-sinusoidal signals in ratio of up to 10:1 between peak value and r.m.s. value.

B.1.4 Oscillator and amplifier

The oscillator and the amplifier shall be designed in such a way that the measurement of the adjacent channel power of a low-noise unmodulated transmitter, whose self-noise has a negligible influence on the measurement result, yields a measured value of less than -90 dB.

Annex C (normative): Radiated measurements

C.1 Test sites and general arrangements for measurements involving the use of radiated fields

C.1.1 Outdoor test site

The outdoor test site shall be on a reasonably level surface or ground. At one point on the site, a ground plane of at least 5 m diameter shall be provided. In the middle of this ground plane, a non-conducting support, capable of rotation through 360° in the horizontal plane, shall be used to support the test sample at 1.5 m above the ground plane. The test site shall be large enough to allow the erection of a measuring or transmitting antenna at a distance of $\lambda/2$ or 3 m whichever is the greater. The distance actually used shall be recorded with the results of the tests carried out on the site.

Sufficient precautions shall be taken to ensure that reflections from extraneous objects adjacent to the site and ground reflections do not degrade the measurements results.

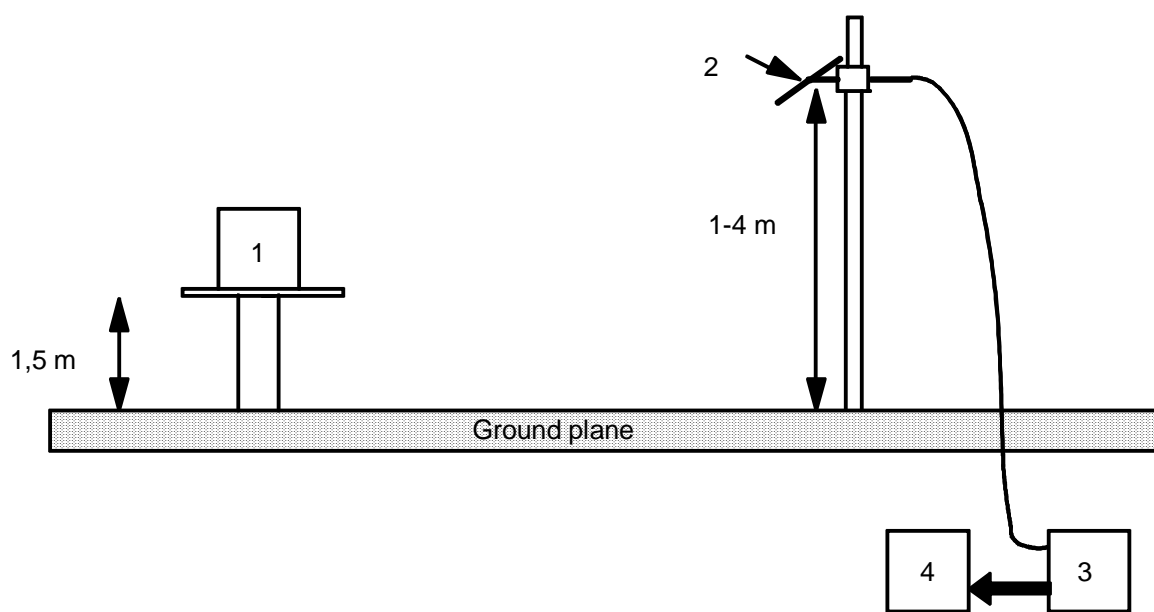

Figure C.1

Key:

- 1 Equipment under test
- 2 Test antenna
- 3 High pass filter (necessary for strong fundamental Tx radiation)
- 4 Spectrum analyser or measuring receiver

C.1.2 Test antenna

The test antenna is used to detect the radiation from both the test sample and the substitution antenna, when the site is used for radiation measurements; where necessary, it is used as a transmitting antenna, when the site is used for the measurement of receiver characteristics.

This antenna is mounted on a support such as to allow the antenna to be used in either horizontal or vertical polarization and for the height of its centre above ground to be varied over the range 1 to 4 m. Preferably a test antenna with

pronounced directivity should be used. The size of the test antenna along the measurement axis shall not exceed 20 % of the measuring distance.

For receiver and transmitter radiation measurements, the test antenna is connected to a measuring receiver, capable of being tuned to any frequency under investigation and of measuring accurately the relative levels of signals at its input. For receiver radiated sensitivity measurements the test antenna is connected to a signal generator.

C.1.3 Substitution antenna

When measuring in the frequency range up to 1 GHz the substitution antenna shall be a $\lambda/2$ dipole, resonant at the frequency under consideration, or a shortened dipole, calibrated to the $\lambda/2$ dipole. When measuring in the frequency range above 4 GHz a horn radiator shall be used. For measurements between 1 and 4 GHz either a $\lambda/2$ dipole or a horn radiator may be used. The centre of this antenna shall coincide with the reference point of the test sample it has replaced. This reference point shall be the volume centre of the sample when its antenna is mounted inside the cabinet, or the point where an external antenna is connected to the cabinet.

The distance between the lower extremity of the dipole and the ground shall be at least 0.3 m.

The substitution antenna shall be connected to a calibrated signal generator when the site is used for spurious radiation measurements and transmitter effective radiated power measurements. The substitution antenna shall be connected to a calibrated measuring receiver when the site is used for the measurement of receiver sensitivity.

The signal generator and the receiver shall be operating at the frequencies under investigation and shall be connected to the antenna through suitable matching and balancing networks.

NOTE: The gain of a horn antenna is generally expressed relative to an isotropic radiator.

C.1.4 Optional additional indoor site

When the frequency of the signals being measured is greater than 80 MHz, use may be made of an indoor site. If this alternative site is used, this shall be recorded in the test report.

The measurement site may be a laboratory room with a minimum area of 6 m by 7 m and at least 2.7 m in height.

Apart from the measuring apparatus and the operator, the room shall be as free as possible from reflecting objects other than the walls, floor and ceiling.

The potential reflections from the wall behind the equipment under test are reduced by placing a barrier of absorbent material in front of it. The corner reflector around the test antenna is used to reduce the effect of reflections from the opposite wall and from the floor and ceiling in the case of horizontally polarized measurements. Similarly, the corner reflector reduces the effects of reflections from the side walls for vertically polarized measurements. For the lower part of the frequency range (below approximately 175 MHz) no corner reflector or absorbent barrier is needed. For practical reasons, the $\lambda/2$ antenna in figure C.2 may be replaced by an antenna of constant length, provided that this length is between $\lambda/4$ and λ at the frequency of measurement and the sensitivity of the measuring system is sufficient. In the same way the distance of $\lambda/2$ to the apex may be varied.

The test antenna, measuring receiver, substitution antenna and calibrated signal generator are used in a way similar to that of the general method.

To ensure that errors are not caused by the propagation path approaching the point at which phase cancellation between direct and the remaining reflected signals occurs, the substitution antenna shall be moved through a distance of ± 0.1 m in the direction of the test antenna as well as in the two directions perpendicular to this first direction.

If these changes of distance cause a signal change of greater than 2 dB, the test sample should be re-sited until a change of less than 2 dB is obtained.

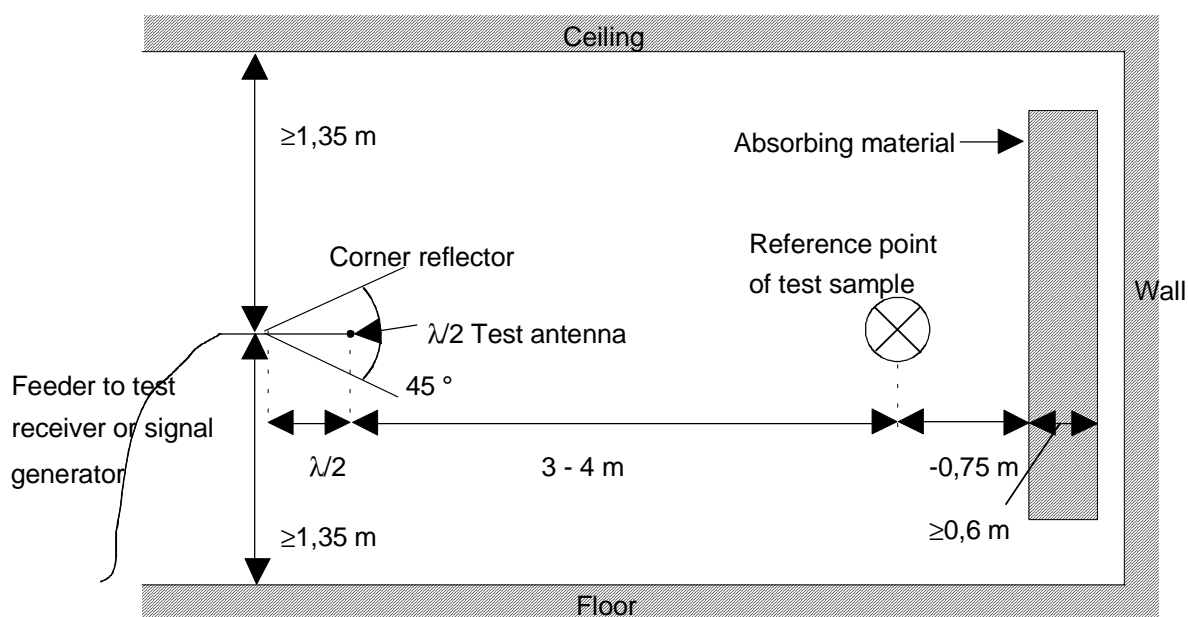

Figure C.2: Indoor site arrangement (shown for horizontal polarization)

C.2 Guidance on the use of radiation test sites

For measurements involving the use of radiated fields, use may be made of a test site in conformity with the requirements of clause C.1 of this annex. When using such a test site, the following conditions should be observed to ensure consistency of measuring results.

C.2.1 Measuring distance

Evidence indicates that the measuring distance is not critical and does not significantly affect the measuring results, provided that the distance is not less than $\lambda/2$ at the frequency of measurement, and the precautions described in this annex are observed. Measuring distances of 3, 5, 10 and 30 m are in common use in European test laboratories.

C.2.2 Test antenna

Different types of test antenna may be used, since performing substitution measurements reduces the effect of the errors on the measuring results.

Height variation of the test antenna over a range of 1 to 4 m is essential in order to find the point at which the radiation is a maximum.

Height variation of the test antenna may not be necessary at the lower frequencies below about 100 MHz.

C.2.3 Substitution antenna

Variations in the measuring results may occur with the use of different types of substitution antenna at the lower frequencies below about 80 MHz.

Where a shortened dipole antenna is used at these frequencies, details of the type of antenna used should be included with the results of the tests carried out on the site. Correction factors shall be taken into account when shortened dipole antennas are used

C.2.4 Artificial antenna

The dimensions of the artificial antenna used during radiated measurements should be small in relation to the sample under test.

Where possible, a direct connection should be used between the artificial antenna and the test sample.

In cases where it is necessary to use a connecting cable, precautions should be taken to reduce the radiation from this cable by, for example, the use of ferrite cores or double screened cables.

C.2.5 Auxiliary cables

The position of auxiliary cables (power supply and microphone cables etc.) which are not adequately decoupled may cause variations in the measuring results. In order to get reproducible results, cables and wires of auxiliaries should be arranged vertically downwards (through a hole in the non conducting support).

C.2.6 Acoustic measuring arrangement

When carrying out measurements of the maximum usable sensitivity (radiated) of the receiver, the audio output shall be monitored by acoustically coupling the audio signal from the receiver loudspeaker/transducer to the test microphone. On the radiation test site all conducting materials shall be placed below the ground surface and the acoustic signal is conveyed from the receiver to the test microphone in a non-conducting acoustic pipe.

The acoustic pipe shall have an appropriate length. The acoustic pipe shall have an inner diameter of 6 mm and a wall thickness of 1,5 mm. A plastic funnel of a diameter corresponding to the receiver loudspeaker/transducer shall be attached to the receiver surface centred in front of the receiver loudspeaker/transducer. The plastic funnel shall be very soft at the attachment point to the receiver in order to avoid mechanical resonance. The narrow end of the plastic funnel shall be connected to the one end of the acoustic pipe and the test microphone to the other.

C.3 Further optional alternative indoor test site using an anechoic chamber

For radiation measurements when the frequency of the signals being measured is greater than 30 MHz, use may be made of an indoor site being a well-shielded anechoic chamber simulating free space environment. If such a chamber is used, this shall be recorded in the test report.

The test antenna, measuring receiver, substitution antenna and calibrated signal generator are used in a way similar to that of the general method, clause C.1. In the range between 30 MHz and 100 MHz some additional calibration may be necessary.

An example of a typical measurement site may be an electrically shielded anechoic chamber being 10 m long, 5 m broad and 5 m high.

Walls and ceiling should be coated with RF absorbers of 1 m height.

The base should be covered with absorbing material 1 m thick, and a wooden floor, able to carry test equipment and operators.

A measuring distance of 3 to 5 m in the long middle axis of the chamber can be used for measurements up to 12,75 GHz.

The construction of the anechoic chamber is described in the following subclauses.

C.3.1 Example of the construction of a shielded anechoic chamber

Free-field measurements can be simulated in a shielded measuring chamber where the walls are coated with RF absorbers.

Figure C.3 shows the requirements for shielding loss and wall return loss of such a room.

As dimensions and characteristics of usual absorber materials are critical below 100 MHz (height of absorbers < 1 m, reflection attenuation < 20 dB) such a room is preferably suitable for measurements above 100 MHz.

Figure C.4 shows the construction of a shielded measuring chamber having a base area of 5 m by 10 m and a height of 5 m.

Ceilings and walls are coated with pyramidal formed absorbers approximately 1 m high. The base is covered with absorbers which are able to carry and which forms a sort of floor.

The available internal dimensions of the room are 3 m × 8 m × 3 m, so that a measuring distance of maximum 5 m length in the middle axis of this room is available.

At 100 MHz the measuring distance can be extended up to a maximum of 2 lambda.

The floor absorbers reject floor reflections so that the antenna height need not be changed and floor reflection influences need not be considered.

All measuring results can therefore be checked with simple calculations and the measuring tolerances have the smallest possible values due to the simple measuring configuration.

For special measurements it can be necessary to re-introduce floor reflections. Taking away the floor absorbers would mean a removal of approximately 24 m³ absorber material. Therefore the floor absorbers are covered with metal plates of metallic nets instead.

C.3.2 Influence of parasitic reflections in anechoic chambers

For free-space propagation in the far field condition the correlation $E=E_0(R_0/R)$ is valid for the dependence of the field strength E on the distance R , whereby E_0 is the reference field strength in the reference distance R_0 .

It is useful to use just this correlation for comparison measurements, as all constants are eliminated with the ratio and neither cable attenuation nor antenna mismatch or antenna dimensions are of importance.

Deviations from the ideal curve can be seen easily if the logarithm of the above equation is used, because the ideal correlation of field strength and distance can then be shown as a straight line and the deviations occurring in practice are clearly visible. This indirect method shows the disturbances due to reflections more readily and is far less problematical than the direct measurement of reflection attenuation.

With an anechoic chamber of the dimensions suggested in clause C.3 at low frequencies up to 100 MHz there are no far field conditions, and therefore reflections are stronger so that careful calibration is necessary.

In the medium frequency range from 100 MHz to 1 GHz the dependence of the field strength on the distance meets the expectations very well.

In the frequency range of 1 to 12,75 GHz, because more reflections will occur, the dependence of the field strength on the distance will not correlate so closely.

C.3.3 Calibration of the shielded anechoic chamber

Careful calibration of the chamber shall be performed over the range 30 MHz to 12,75 GHz.

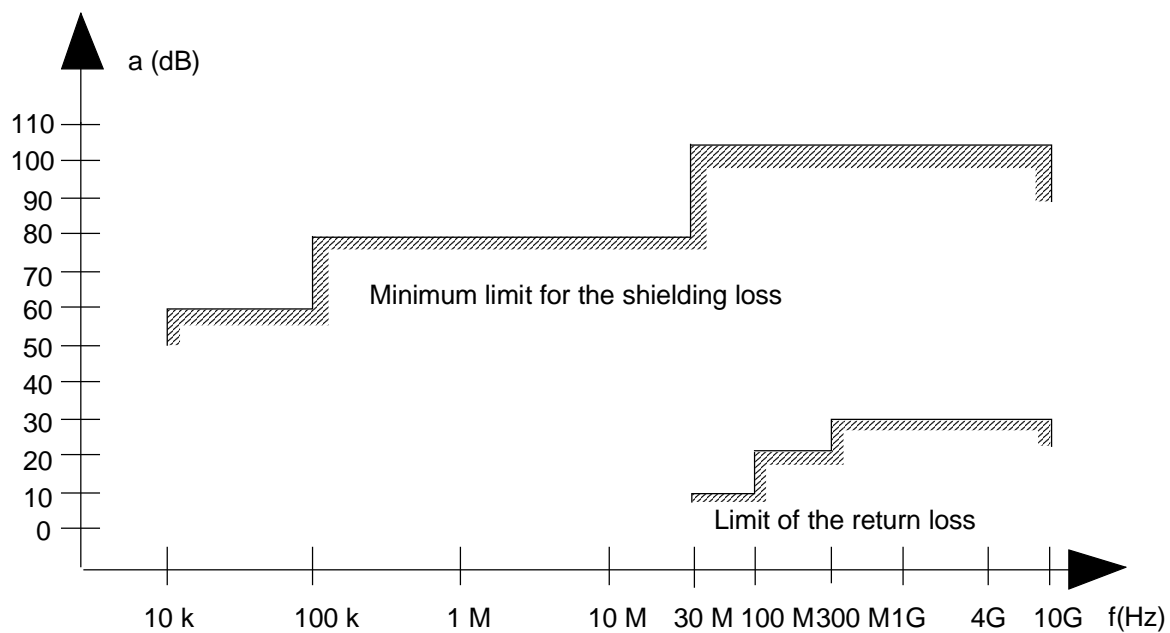
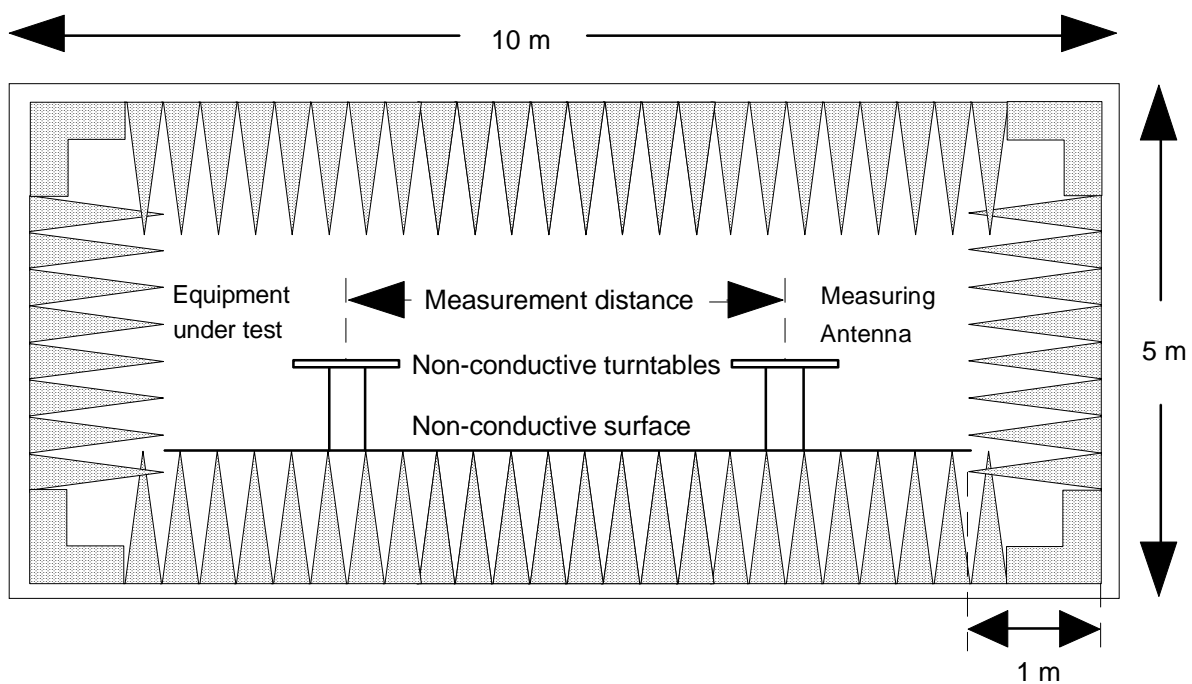

Figure C.3: Specifications for shielding and reflections



Ground plan

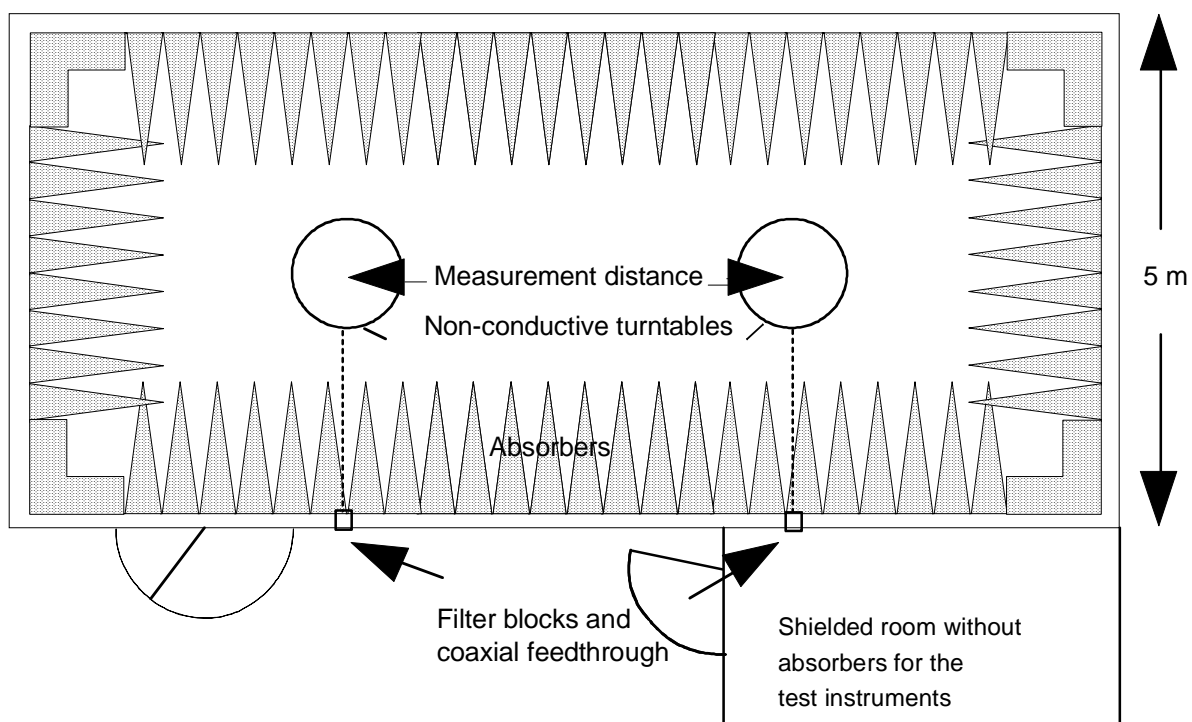

Figure C.4: Example of construction of an anechoic shielded chamber

Annex D (informative): Description of the equipment

The emphasis in the present document is on simplicity of operation. The VHF equipment uses DSC controllers based on Class D which will probably be integrated in the VHF radio equipment but in any event will have the capability to select the radio channels automatically. An input for position information in IEC 1162-1 [4] format is a requirement and the use of automatic position updating is to be encouraged.

Distress calls may only be made by means of a protected dedicated button. Furthermore channel 16 is required to be selected automatically after transmission of a distress or urgency call or receipt of a distress, distress relay, or urgency call.

Routine calls require only the input of the called MMSI and a channel number in the case of a ship to ship call. For incoming calls the radio is required to select automatically the channel number given in the message. Means are provided for the user to enter a temporary group MMSI to permit calling amongst a group of related vessels.

The intended aim of designers of equipment to the present document is that it should take no longer than 10 minutes for an operator to learn to use the equipment. This is achieved by the provision of clear simple menus with the most frequently used functions at the top of the menu tree.

As an aid to safety, it is a requirement, in order to prevent the transmission of DSC calls from an unidentifiable ship, that DSC operation is inhibited on a new equipment until the vessel's own MMSI has been entered.

Equipment designed to the present document is fitted with a 50 Ω external antenna socket or connector for use on board vessels and operates in the bands between 156 MHz and 174 MHz allocated to the maritime mobile service as detailed in appendix 18 to the Radio Regulations [1].

Annex E (normative): Subclauses of the present document relevant for compliance with the essential requirements of relevant EC Council Directives

Table E.1: Subclauses of the present document relevant for compliance with the essential requirements of relevant EC Council Directives

Clause/subclause number and title		Corresponding article of Council Directive 89/336/EEC	Qualifying remarks
8.8	Conducted spurious emissions conveyed to the antenna	4 (a)	For transmitters
8.9	Cabinet radiation and conducted spurious emissions other than those conveyed to the antenna	4 (a)	For transmitters
9.6	Spurious response rejection	4 (b)	For receivers
9.8	Blocking or desensitization	4 (b)	For receivers
9.9	Spurious emissions	4 (a)	For receivers
9.10	Radiated spurious emissions	4 (a)	For receivers
10.4	Spurious response and blocking immunity	4 (b)	For receivers
10.7	Spurious emissions	4 (a)	For receivers
10.8	Radiated spurious emissions	4 (a)	For receivers

History

Document history				
V1.1.1	May 1997	Public Enquiry	PE 9742:	1997-05-23 to 1997-10-17
V1.1.1	May 1998	Vote	V 9830:	1998-05-18 to 1998-07-31
V1.1.1	August 1998	Publication		