

Final draft **ETSI EN 300 765-1** V1.3.0 (2000-12)

European Standard (Telecommunications series)

**Digital Enhanced Cordless Telecommunications (DECT);
Radio in the Local Loop (RLL) Access Profile (RAP);
Part 1: Basic telephony services**



Reference

REN/DECT-A0173-1

Keywords

DECT, FWA, RLL, WLL

ETSI

650 Route des Lucioles
F-06921 Sophia Antipolis Cedex - FRANCE

Tel.: +33 4 92 94 42 00 Fax: +33 4 93 65 47 16

Siret N° 348 623 562 00017 - NAF 742 C
Association à but non lucratif enregistrée à la
Sous-Préfecture de Grasse (06) N° 7803/88

Important notice

Individual copies of the present document can be downloaded from:

<http://www.etsi.org>

The present document may be made available in more than one electronic version or in print. In any case of existing or perceived difference in contents between such versions, the reference version is the Portable Document Format (PDF). In case of dispute, the reference shall be the printing on ETSI printers of the PDF version kept on a specific network drive within ETSI Secretariat.

Users of the present document should be aware that the document may be subject to revision or change of status. Information on the current status of this and other ETSI documents is available at <http://www.etsi.org/tb/status/>

If you find errors in the present document, send your comment to:
editor@etsi.fr

Copyright Notification

No part may be reproduced except as authorized by written permission.
The copyright and the foregoing restriction extend to reproduction in all media.

© European Telecommunications Standards Institute 2000.
All rights reserved.

Contents

Intellectual Property Rights	6
Foreword	6
1 Scope.....	7
2 References	7
3 Definitions, symbols and abbreviations	8
3.1 Definitions	8
3.2 Symbols	10
3.3 Abbreviations.....	10
4 Introduction	11
4.1 Reference model.....	11
4.2 Services & facilities.....	12
5 Feature definitions	12
5.1 Network (NWK) features (only differences from GAP).....	12
5.2 Application features (only differences from GAP).....	13
6 Service definitions	13
6.1 Data Link Control (DLC) service definitions.....	13
6.1.1 Reference to GAP	13
6.1.2 LU7 service	13
6.2 Medium Access Control (MAC) service definitions	14
6.2.1 Reference to GAP	14
6.2.2 MAC service definitions (additional to GAP)	14
7 Interoperability requirements	14
7.1 General	14
7.2 NWK features	15
7.3 DLC services.....	16
7.4 MAC services	16
7.5 Physical Layer (PHL) services	17
7.6 Application features	17
7.7 NWK feature to procedure mapping.....	17
7.8 DLC service to procedure mapping.....	21
7.9 MAC service to procedure mapping.....	22
7.10 Application feature to procedure mapping.....	23
7.11 General requirements.....	23
8 Procedure description	23
9 NWK layer procedures	23
9.1 Reference to GAP.....	23
9.1.1 Release procedure for "On-hook (conditional release)"	23
9.1.2 CLIP, inband.....	25
9.1.3 On-hook/off-hook explicit acknowledgement	26
9.2 Maintenance calls.....	27
9.2.1 Incoming maintenance call.....	27
9.2.2 Outgoing maintenance call	27
9.2.3 Outgoing call during maintenance call.....	27
9.2.4 Incoming call during maintenance call.....	27
9.3 Sending OA&M information	28
9.3.1 Physical resources fault.....	28
9.3.2 Remote test.....	28
9.3.3 Alarms.....	29
9.3.4 On-air modification of user parameters.....	29
9.3.4.1 Modification of existing users parameters	29
9.3.4.2 Additional subscriptions to the same fixed part.....	30

9.3.4.3	Derivation of AC for additional subscriptions.....	30
9.3.5	Start quality measurement	31
9.3.6	Stop quality measurement	31
9.3.7	Remote configuration.....	31
9.3.8	Claim Actions.....	32
9.3.8.1	Claim Actions FT side Initiated.....	32
9.3.8.2	Claim Actions CTA Initiated	33
9.3.9	Remote resynchronization	34
9.3.10	Advanced file transfer	34
9.4	RLL-CC.....	35
9.4.1	Metering pulses.....	35
9.4.2	Switch from voice to data service FT initiated	36
9.4.3	Switch from voice to data service CTA initiated	36
9.4.4	Coin collection.....	36
9.4.5	Ground start.....	37
9.4.6	Line polarity reversal	37
9.4.7	Switch from 32 kbit/s to 64 kbit/s bearer service (FT initiated).....	37
9.4.8	Switching from 32 kbit/s to 64 kbit/s bearer service CTA initiated	39
9.4.9	Line parked.....	41
9.4.10	Switching from 64 kbit/s to 32 kbit/s bearer service FT initiated	41
9.4.11	Switching from 64 kbit/s to 32 kbit/s bearer service CTA initiated	43
9.5	Analogue leased line establishment.....	44
10	DLC layer procedures	45
10.1	General	45
10.2	Reference to GAP.....	45
10.3	LU7 64 kbit/s data bearer service.....	45
11	MAC layer procedures	45
11.1	Reference to GAP.....	45
11.2	Advance timing.....	45
11.3	LU7 64 kbit/s data bearer service.....	46
11.4	Downlink broadcast, Extended Fixed Part Capabilities.....	46
11.5	Blind slot information.....	46
11.6	Improved channel selection rules	47
12	Physical layer requirements	47
12.1	General	47
12.2	Reference to GAP.....	47
12.3	LU7 64 kbit/s data bearer service.....	47
13	Requirements regarding the speech transmission.....	47
13.1	General	47
13.2	Echo control requirements for CTAs intended for 2-wire connections.....	47
13.3	Disabling the echo control functions	48
13.3.1	General.....	48
13.3.2	Modem services	48
14	Requirements regarding fax and data transmission	48
14.1	General	48
14.2	Requirements	48
14.2.1	Implementation of the LU7 PCM services.	48
15	Management procedures	49
16	Interworking with WRS applications.....	49
16.1	General	49
16.2	Requirements	49
16.3	WRS maintenance calls.....	49
16.3.1	Incoming WRS maintenance call.....	49
16.3.2	Outgoing WRS maintenance call.....	49
16.3.3	Maintenance during WRS MM operation	49
17	Application procedures	50
17.1	General	50

17.2	Reference to GAP.....	50
17.3	Manual entry of the PARK and AC to CTA's.....	50
17.3.1	Entering the PARK.....	50
17.3.2	Entering the AC.....	51
Annex A (informative):	PP locking procedure for on air subscription.....	52
Annex B (informative):	Tones, progress indicator and U-plane connection.....	53
Annex C (informative):	Void.....	54
Annex D (normative):	Codings for "OA&M" and "RAP-CC" messages.....	55
D.1	General Structure for RAP <<IWU-to-IWU>> Information Element.....	55
D.2	RAP IWU-TO-IWU Contents Proprietary.....	56
D.2.1	RAP-OA&M Service type coding.....	56
D.3	RAP IWU-TO-IWU Contents Standardized.....	57
D.3.1	RAP-CC Service type coding.....	57
D.3.2	RAP-OA&M Service type coding.....	58
Annex E (informative):	Description of remote tests and quality measurement.....	60
Annex F (informative):	LU8 service.....	61
F.1	Physical layer service.....	61
F.2	MAC layer service.....	61
F.3	DLC layer service.....	61
Annex G (normative):	Synchronization Requirements for Fixed Parts.....	62
Annex H (normative):	Management of the overlapping between decadic dialling and register recall recognition times.....	63
Annex I (informative):	Installation.....	64
I.1	Above roof-top DECT WLL systems and GSM 1 800 macro cell systems.....	64
	History.....	65

Intellectual Property Rights

IPRs essential or potentially essential to the present document may have been declared to ETSI. The information pertaining to these essential IPRs, if any, is publicly available for **ETSI members and non-members**, and can be found in ETSI SR 000 314: "*Intellectual Property Rights (IPRs); Essential, or potentially Essential, IPRs notified to ETSI in respect of ETSI standards*", which is available from the ETSI Secretariat. Latest updates are available on the ETSI Web server (<http://www.etsi.org/ipr>).

Pursuant to the ETSI IPR Policy, no investigation, including IPR searches, has been carried out by ETSI. No guarantee can be given as to the existence of other IPRs not referenced in ETSI SR 000 314 (or the updates on the ETSI Web server) which are, or may be, or may become, essential to the present document.

Foreword

This European Standard (Telecommunications series) has been produced by ETSI Project Digital Enhanced Cordless Telecommunications (DECT), and is now submitted for the ETSI standards One-step Approval Procedure.

The present document is part 1 of a multi-part deliverable covering the Radio in the Local Loop (RLL) Access Profile (RAP), as identified below:

Part 1: "Basic telephony services";

Part 2: "Advanced telephony services".

Every EN prepared by ETSI is a voluntary standard. The present document may contain text concerning conformance testing of the equipment to which it relates. This text should be considered as guidance only and does not make the present document mandatory.

The present document is based on EN 300 175, parts 1 [1] to 8 [8] and EN 300 444 [10]. The present document has been developed in accordance to the rules of documenting a profile specification as described in ISO/IEC 9646-6 [12].

Proposed national transposition dates	
Date of latest announcement of this EN (doa):	3 months after ETSI publication
Date of latest publication of new National Standard or endorsement of this EN (dop/e):	6 months after doa
Date of withdrawal of any conflicting National Standard (dow):	6 months after doa

1 Scope

The present document specifies that set of technical requirements for Digital Enhanced Cordless Telecommunications (DECT) Fixed Part (FP) and DECT Cordless Terminal Adapter (CTA) necessary for the support of the Radio in the Local Loop (RLL) Access Profile (RAP).

The objective of the present document is to ensure the air interface interoperability of DECT RAP CTAs and DECT RAP FPs and Wireless Relay Stations (WRS) if applied.

In addition, the present document defines the features, services, procedures etc. for the CTA and the FT, which are provision mandatory either in the CTA or in the FT, as well as some elements that are provision optional but still process mandatory.

Another objective is to use as much as possible from the existing GAP profile, but to exclude the not applicable GAP-features. Therefore most of the RAP features refer to GAP features EN 300 444 [10] and the necessary additional features (for example Operation, Administration, and Maintenance (OA&M)) are listed and explained in the present document.

The present document, contains the so-called "Plain Old Telephone Service (POTS)" services including leased lines and 64 kbit/s bearer service.

2 References

The following documents contain provisions which, through reference in this text, constitute provisions of the present document.

- References are either specific (identified by date of publication and/or edition number or version number) or non-specific.
- For a specific reference, subsequent revisions do not apply.
- For a non-specific reference, the latest version applies.

- [1] ETSI EN 300 175-1: "Digital Enhanced Cordless Telecommunications (DECT); Common Interface (CI); Part 1: Overview".
- [2] ETSI EN 300 175-2: "Digital Enhanced Cordless Telecommunications (DECT); Common Interface (CI); Part 2: Physical Layer (PHL)".
- [3] ETSI EN 300 175-3: "Digital Enhanced Cordless Telecommunications (DECT); Common Interface (CI); Part 3: Medium Access Control (MAC) Layer".
- [4] ETSI EN 300 175-4: "Digital Enhanced Cordless Telecommunications (DECT); Common Interface (CI); Part 4: Data Link Control (DLC) Layer".
- [5] ETSI EN 300 175-5: "Digital Enhanced Cordless Telecommunications (DECT); Common Interface (CI); Part 5: Network (NWK) Layer".
- [6] ETSI EN 300 175-6: "Digital Enhanced Cordless Telecommunications (DECT); Common Interface (CI); Part 6: Identities and Addressing".
- [7] ETSI EN 300 175-7: "Digital Enhanced Cordless Telecommunications (DECT); Common Interface (CI); Part 7: Security Features".
- [8] ETSI EN 300 175-8: "Digital Enhanced Cordless Telecommunications (DECT); Common Interface (CI); Part 8: Speech Coding and Transmission".
- [9] ETSI EN 300 176 (all parts): "Digital Enhanced Cordless Telecommunications (DECT); Approval Test Specification".

- [10] ETSI EN 300 444: "Digital Enhanced Cordless Telecommunications (DECT); Generic Access Profile (GAP)".
- [11] ETSI EN 300 700: "Digital Enhanced Cordless Telecommunications (DECT); Wireless Relay Station (WRS)".
- [12] ISO/IEC 9646-6: "Information technology - Open Systems Interconnection - Conformance testing methodology and framework - Part 6: Protocol profile test specification".
- [13] ISO/IEC 9646-7: "Information technology - Open Systems Interconnection - Conformance testing methodology and framework - Part 7: Implementation Conformance Statements".
- [14] ETSI ETR 246: "Digital Enhanced Cordless Telecommunications (DECT); Application of DECT Wireless Relay Stations (WRS)".
- [15] ETSI ETR 308: "Digital Enhanced Cordless Telecommunications (DECT); Services, facilities and configurations for DECT in the local loop".
- [16] ITU-T Recommendation V.25: "Automatic answering equipment and general procedures for automatic calling equipment on the general switched telephone network including procedures for disabling of echo control devices for both manually and automatically established calls".
- [17] ITU-T Recommendation G.164: "Echo suppressors".
- [18] ITU-T Recommendation G.165: "Echo cancellers".
- [19] CEPT Recommendation T/R 22-02: "Frequency band to be designated for the European digital cordless telecommunication system (DECT)".

3 Definitions, symbols and abbreviations

3.1 Definitions

For the purposes of the present document, the following terms and definitions apply:

authentication: process whereby a DECT subscriber is positively verified to be a legitimate user of a particular FP

NOTE 1: Authentication is generally performed at call set-up, but may also be done at any other time (e.g. during a call).

bearer service: type of telecommunication service that provides a defined capability for the transmission of signals between user-network interfaces

NOTE 2: The DECT user-network interface corresponds to the top of the network layer (layer 3).

C-plane: the control plane of the DECT protocol stacks, which contains all of the internal DECT protocol control, but may also include some external user information

NOTE 3: The C-plane stack always contains protocol entities up to and including the network layer.

call: all of the NWK layer processes involved in one network layer peer-to-peer association

NOTE 4: Call may sometimes be used to refer to processes of all layers, since lower layer processes are implicitly required.

Cordless Terminal Adapter (CTA): physical grouping that contains a DECT portable termination and a line interface

DECT network: network that uses the DECT air interface to interconnect a local network to one or more portable applications. The logical boundaries of the DECT network are defined to be at the top of the DECT network layer

NOTE 5: A DECT network is a logical grouping that contains one or more fixed radio terminations plus their associated portable radio termination. The boundaries of the DECT network are not physical boundaries.

Fixed Part (DECT Fixed Part) (FP): physical grouping that contains all of the elements in the DECT network between the local network and the DECT air interface

NOTE 6: A DECT FP contains the logical elements of at least one FT, plus additional implementation specific elements.

Fixed Radio Termination (FT): logical group of functions that contains all of the DECT processes and procedures on the fixed side of the DECT air interface

NOTE 7: A FT only includes elements that are defined in the DECT CI standard. This includes radio transmission elements together with a selection of layer 2 and layer 3 elements.

NOTE 8: A FT can also be the FT side of a WRS.

handover: process of switching a call in progress from one physical channel to another physical channel

NOTE 9: There are two physical forms of handover, intra-cell handover and inter-cell handover.

incoming call: call received at a CTA

inter-cell handover: switching of a call in progress from one cell to another cell

internal handover: handover processes that are completely internal to one FT. Internal handover reconnects the call at the lower layers, while maintaining the call at the NWK layer.

NOTE 10: The lower layer reconnection can either be at the DLC layer (connection handover) or at the MAC layer (bearer handover).

interoperability: capability of FPs and CTAs, that enable a CTA to obtain access to teleservices in more than one location area and/or from more than one operator (more than one service provider)

intra-cell handover: switching of a call in progress from one physical channel of one cell to another physical channel of the same cell

Local Exchange: local switch connecting the end-user to the public network

Local Network (LNW): telecommunication network capable of offering local telecommunication services

NOTE 11: The term does not include legal or regulatory aspects, nor does it indicate if the network is a public network or a private network.

location area: the domain in which a PP may receive (and/or make) calls as a result of a single location registration

location registration: the process whereby the position of a DECT PT is determined to the level of one location area, and this position is updated in one or more databases

NOTE 12: These databases are not included within a DECT FT.

MAC Connection (CONNECTION): association between one source MAC Multi-Bearer Control (MBC) entity and one destination MAC MBC entity. This provides a set of related MAC services (a set of logical channels), and it can involve one or more underlying MAC bearers

outgoing call: call originating from a PP

Portable Application (PA): logical grouping that contains all the elements that lie beyond the DECT network boundary on the portable side

NOTE 13: The functions contained in the PA may be physically distributed, but any such distribution is invisible to the DECT network.

Portable Part (DECT Portable Part) (PP): physical grouping that contains all elements between the user and the DECT air interface. PP is a generic term that may describe one or several physical pieces

NOTE 14: A DECT PP is logically divided into one PT plus one or more PAs.

Portable Radio Termination (PT): logical group of functions that contains all of the DECT processes and procedures on the portable side of the DECT air interface

NOTE 15:A PT only includes elements that are defined in the DECT CI standard. This includes radio transmission elements (layer 1) together with a selection of layer 2 and layer 3 elements.

NOTE 16:A PT can also be the PT side of a WRS or the PT side of a CTA.

Radio Fixed Part (RFP): one physical sub-group of a FP that contains all the radio end points (one or more) that are connected to a single system of antennas

registration: an ambiguous term, that should always be qualified. See either location registration or subscription registration

subscription registration: the infrequent process whereby a subscriber obtains access rights to one or more FPs

NOTE 17:Subscription registration is usually required before a user can make or receive calls.

Wireless Relay Station (WRS): physical grouping that combines elements of both PTs and FTs to relay information on a physical channel from one DECT termination to a physical channel to another DECT termination

NOTE 18:The DECT termination can be a PT or an FT or another WRS.

3.2 Symbols

For the purposes of the present document, the following symbols apply if not explicitly otherwise stated:

M	for mandatory to support (provision mandatory, process mandatory)
O	for optional to support (provision optional, process mandatory)
I	for out-of-scope (provision optional, process optional) not subject for testing
C	for conditional to support (process mandatory)
N/A	for not-applicable (in the given context the specification makes it impossible to use this capability)

Provision mandatory, process mandatory means that the indicated feature, service or procedure shall be implemented as described in the present document, and may be subject to testing.

Provision optional, process mandatory means that the indicated feature, service or procedure may be implemented, and if implemented, the feature, service or procedure shall be implemented as described in the present document, and may be subject to testing.

NOTE: The used notation is based on the notation proposed in ISO/IEC 9646-7 [13].

3.3 Abbreviations

For the purposes of the present document, the following abbreviations apply:

AC	Authentication Code
ARI	Access Rights Identity
CC	Call Control
CI	Common Interface
CLIP	Calling Line ID Presentation
CPE	Customer Premises Equipment
CTA	Cordless Terminal Adapter
DCK	Derived Cipher Key
DECT	Digital Enhanced Cordless Telecommunications
DLC	Data Link Control, Layer 2b of the DECT protocol stack
DTMF	Dual Tone Multi-Frequency
FP	Fixed Part, (see definitions)
FT	Fixed radio Termination
GPS	Global Position System
GSM	Global System for Mobile communications
IE	Information Element
IEC	International Electrotechnical Commission

I_N	higher layer information channel (unprotected)
I_p	higher layer information channel (protected)
IPUI	International Portable User Identity
ISDN	Integrated Services Digital Network
ISO	International Organization for Standardization
LLME	Lower Layer Management Entity
LNW	Local Network
MAC	Medium Access Control, Layer 2a of the DECT protocol stack
MM	Mobility Management, a NWK layer functional grouping
NWK	Network, Layer 3 of the DECT protocol stack
OA&M	Operation, Administration, and Maintenance
P	Public (environment)
PARK	Portable Access Rights Key
PHL	PHysical Layer
PLI	Park Length Indicator
POT	Plain Old Telephone
POTS	Plain Old Telephone Service
PP	Portable Part
PT	Portable radio Termination. See definition
RFP	Radio Fixed Part (see definitions)
RFPI	Radio Fixed Part Identity
RS	Reed Solomon code
SARI	Secondary Access Rights Identity
TE	Terminal Equipment
TI	Transaction Identifier
UAK	User Authentication Key
WRS	Wireless Relay Station

4 Introduction

4.1 Reference model

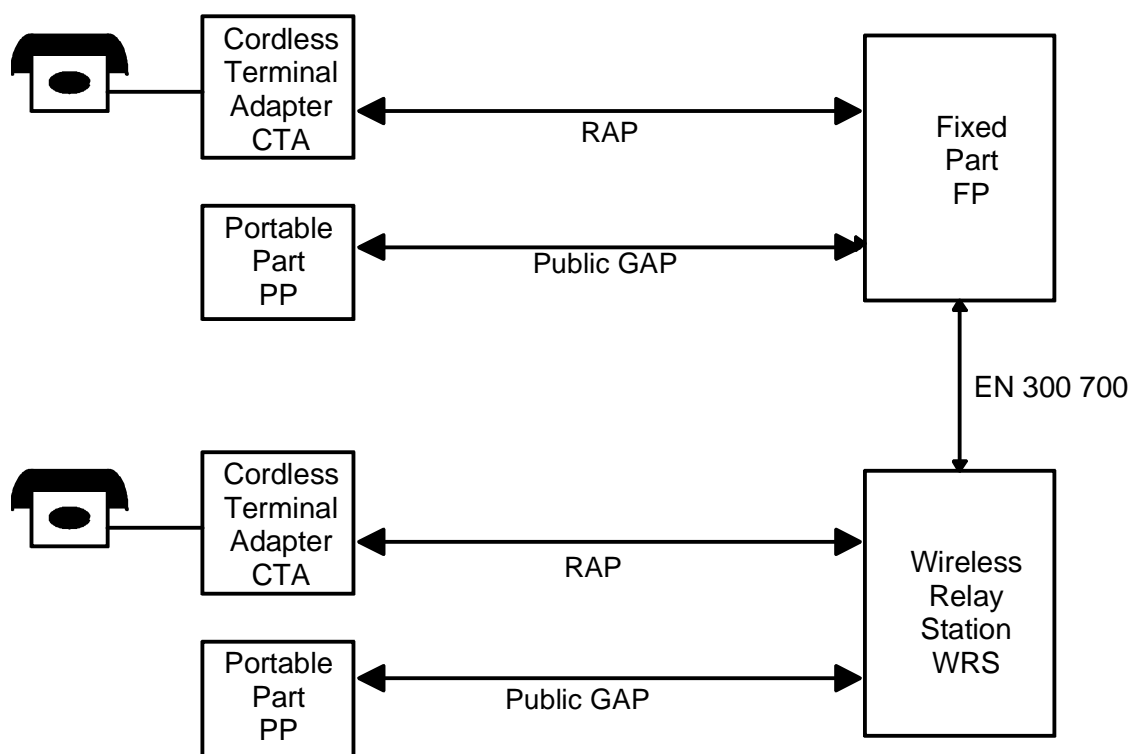

Figure 1: Reference model

4.2 Services & facilities

The present document provides a minimum service level, i.e. the so-called "POTS" services, and optional extensions including 64 kbit/s bearer service and leased lines. A Fixed Part that supports RAP may additionally support GAP and can in this way support both CTAs and GAP PPs as well as the respective RAP and GAP WRSs, and also CTAs with embedded GAP WRS functionality (see EN 300 700 [11]).

Another part of the RAP is expected to describe ISDN services, non-voiceband data services and support of digital leased lines.

5 Feature definitions

For the purposes of the present document the feature definitions in the following clauses apply.

The number given in square brackets after the name of a feature is the item number used in the tables of the present document.

5.1 Network (NWK) features (only differences from GAP)

On-Hook (CONDITIONAL Release) [N.100]: ability of the CTA to indicate the action of going on-hook (e.g. to terminate a call) to the DECT FP. On reception of the "on hook" indication, the DECT FP may terminate the call, and release the radio resource.

Calling Line Identity Presentation, inband (CLIP, inband) [N.101]: ability to provide the calling party number to the POTS CTA by transmitting DTMF or modem tones to the CTA within the speech channel before off hook during incoming call

incoming maintenance transaction [N.102]: ability of the CTA to receive, and the FP to send OA&M messages

outgoing maintenance transaction [N.103]: ability of the CTA to send, and the FP to receive OA&M messages

maintenance during call [N.104]: ability of the CTA and FT to exchange OA&M messages during an active call

metering pulses [N.105]: ability of the CTA to generate metering pulses on reception of a corresponding RAP-CC message

Analogue Leased Line [N.106]: ability to provide an analogue leased line

physical resources fault [N.107]: ability of the CTA to corresponding OA&M messages to indicate the location of faults in the Physical resources to the network management

Remote Test [N.108]: ability of the FP to request the CTA to run specific tests

alarms [N.109]: ability of the CTA to indicate to the FP that a significant system event occurs or is about to occur which may seriously affect the systems ability to function

on-air modification of user parameters [N.110]: ability of the CTA to accept FP initiated changes of subscription data

switch from voice to data service FT initiated [N.111]: ability of the FT of detecting the 2,1 kHz tone in the Audio-Channel and of switching an existing speech call in a data call sending a RAP-CC message to the CTA and the ability of the CTA to process this message

switch from voice to data service CTA initiated [N.112]: ability of the CTA of detecting the 2,1 kHz tone in the Audio-Channel and of switching an existing speech call in a data call sending a RAP-CC message to the FT and the ability of the FT to process this message

coin collection [N.113]: ability to transmit the result of coin collection via RAP-CC message

ground start [N.114]: ability to transmit the ground start signal via a RAP-CC message

remote configuration [N.115]: ability to configure the parameters of the CTA via OA&M messages

64 kbit/s bearer service using DLC LU7 service [N.116]: ability to offer the DLC LU7 service suitable for a 64 kbit/s bearer service and transparent ISDN services using double slots at the physical layer

line parked [N.117]: ability of the FP to indicate to the CTA that the Local Exchange has parked the line

line polarity reversal [N.118]: ability to transmit the line polarity reversal signal via a RAP-CC message.

incoming WRS maintenance transaction [N.119]: ability of the WRS to receive OA&M messages from the FP

outgoing WRS maintenance transaction [N.120]: ability of the WRS to send OA&M messages to the FP

advanced file transfer [N.121]: ability to transfer file to the CTA

maintenance during WRS MM operation [N.122]: ability of the WRS to exchange OA&M messages with the FP during an ongoing MM operation

5.2 Application features (only differences from GAP)

manual entry of the PARK and AC to a CTA [A.100]: ability of the CTA to accept a manual entry of the PARK for ensuring attachment to the right FP in a physical area covered by many providers and a manual entry of the AC via the keypad of a connected CPE

6 Service definitions

For the purposes of the present document the following service definitions apply.

6.1 Data Link Control (DLC) service definitions

6.1.1 Reference to GAP

See EN 300 444 [10], clause 5.1.

6.1.2 LU7 service

The LU7 service is used to protect the transmission signal by an RS (255,249) code which may be used to correct up to 3 errors within a double slot connection. The generator polynomial to encode and decode the information has 6th degree. The same type as proposed in EN 300 175-4 [4], clause 11.9 shall be used:

$$g(X) = \prod_{i=0}^5 (X + \alpha^i)$$

where α is a root of the binary primitive polynomial

$$p(X) = X^8 + X^4 + X^3 + X^2 + 1$$

a data byte

$$(d_7, d_6, d_5, d_4, d_3, d_2, d_1, d_0)$$

is identified with the element

$$d_7\alpha^7 + d_6\alpha^6 + d_5\alpha^5 + d_4\alpha^4 + d_3\alpha^3 + d_2\alpha^2 + d_1\alpha^1 + d_0\alpha^0$$

in GF(256), the finite field with 256 elements.

6.2 Medium Access Control (MAC) service definitions

6.2.1 Reference to GAP

See EN 300 444 [10], clause 5.2.

6.2.2 MAC service definitions (additional to GAP)

LU7 MAC service [M.100]: see EN 300 175-4 [4], clause E.3

Advance Timing [M.101]: information sent from FT to PT which the PT can use to adjust its timing reference for subsequent transmissions, in order to control the link quality

continuous broadcast, Extended Fixed Part Capabilities [M.102]: information broadcast from FT to CTAs to indicate the support of the RAP 1 Profile

improved channel selection rules [M.103]: algorithm used to improve the channel selection procedure in mixed environment

7 Interoperability requirements

7.1 General

The tables listed in this clause define all the protocol elements i.e. features, services, and procedures which are mandatory, optional, and conditional under the provision of another protocol element, or out of the scope of the present document, or in some context not-applicable according to the definition of the status column as defined in clause 3.3 for the RAP FP and CTA. All optional elements shall be process mandatory according to the procedures described in the present document.

Protocol elements defined as mandatory, optional or conditional in this clause shall further be defined in clauses 8, 9, 10, 11, 12, 13, 14, 15, 16, 17 and annex D in detail either explicitly and/or as references to the DECT base standard EN 300 175, parts 2 [2] to 8 [8], EN 300 444 [10] and EN 300 176 [9].

NOTE: Annexes A, B and C are informative and may be used as additional information, but do not mandate requirements.

The requirements of EN 300 176 [9] shall be met by all equipment conforming to the present document.

Wherever reference is made to RAP is intended to the present document.

7.2 NWK features

Table 1: NWK features status

Feature supported					
Item no.	Name of feature	GAP Ref. EN 300 444 [10]	RAP Ref.	Status	
				CTA	FT
N.1	Outgoing call	4.1		M	M
N.2	Off Hook	4.1		M	M
N.3	On Hook (full release) (note 4)	4.1		M	M
N.4	Dialled digits (basic)	4.1		M	M
N.5	Register recall (note 1 and 2)	4.1		M	O
N.8	Incoming call	4.1		M	M
N.9	Authentication of the PP	4.1		M	M
N.11	Location registration	4.1		M	M
N.12	On air key allocation (note 3)	4.1		M	O
N.13	Identification of PP	4.1		M	O
N.15	Alerting	4.1		M	M
N.17	Encryption activation FT initiated	4.1		M	M
N.18	Subscription registration procedure on-air	4.1		M	M
N.19	Link control	4.1		M	M
N.20	Terminate access rights FT initiated (note 3)	4.1		M	O
N.21	Partial release	4.1		M	M
N.26	Authentication of FT	4.1		O	O
N.27	Encryption activation PT initiated	4.1		O	O
N.28	Encryption deactivation FT initiated	4.1		O	O
N.29	Encryption deactivation PT initiated	4.1		O	O
N.30	Calling Line ID Presentation (CLIP)	4.1		O	O
N.100	On Hook (conditional release) (note 4)		5.1	M	M
N.101	Calling Line ID Presentation, inband (CLIP, inband)		5.1	O	O
N.102	Incoming maintenance transaction		5.1	M	M
N.103	Outgoing maintenance transaction		5.1	M	M
N.104	Maintenance during call		5.1	M	M
N.105	Metering Pulses		5.1	M	M
N.106	Analogue Leased Lines		5.1	O	O
N.107	Physical resources fault		5.1	M	M
N.108	Remote test		5.1	M	M
N.109	Alarms		5.1	O	O
N.110	On-air modification of user parameters		5.1	O	O
N.111	Switch from voice to data service FT initiated		5.1	M	M
N.112	Switch from voice to data service CTA initiated		5.1	O	O
N.113	Coin collection		5.1	O	O
N.114	Ground start		5.1	O	O
N.115	Remote configuration		5.1	O	O
N.116	64 kbit/s bearer service using DLC LU7 service		5.1	O	O
N.117	Line parked		5.1	O	O
N.118	Line polarity reversal		5.1	O	O
N.119	Incoming WRS maintenance transaction		5.1	N/A	O
N.120	Outgoing WRS maintenance transaction		5.1	N/A	O
N.121	Advanced file transfer		5.1	O	O
N.122	Maintenance during WRS MM operation		5.1	N/A	O
NOTE 1: This feature uses keypad code 15 hex.					
NOTE 2: The FT is not mandated to receive and understand the register recall DECT character. However, if a FT supports it there may be no corresponding action that the FT can take with the local network as a result of this function.					
NOTE 3: This feature is required to be supported in the PT to guarantee the same level of security among all the handsets that operates in a system. The invocation of the feature is however optional to the operator.					
NOTE 4: N.100 On-hook (conditional release) is relevant for T-10 and F-10 CC-states while N.3 On-hook (full release) applies to any other CC-state.					

7.3 DLC services

Table 2: DLC services status

Service supported					
Item no.	Name of service	GAP Ref. EN 300 444 [10]	RAP Ref.	Status	
				CTA	FT
D.1	LAPC class A service and Lc	5.1		M	M
D.2	Cs channel fragmentation and recombination	5.1		M	M
D.3	Broadcast Lb service	5.1		M	M
D.4	Intra-cell voluntary connection handover	5.1		M	C1
D.5	Inter-cell voluntary connection handover (note)	5.1		M	O
D.6	Encryption activation	5.1		M	M
D.7	LU1 TRUP Class 0/min_delay	5.1		M	M
D.8	FU1	5.1		M	M
D.9	Encryption deactivation	5.1		C202	C202
D.100	LU7 service		6.1.2	C203	C203
C201:	IF service M.9 THEN O ELSE M;				
C202:	IF feature N.29 OR N.28 THEN M ELSE I;				
C203:	IF feature N.116 THEN M ELSE I.				
NOTE:	The PT is required to be able to support handover between RFPs. The invocation of the feature is however optional to the operator.				

7.4 MAC services

Table 3: MAC services status

Service supported					
Item no.	Name of service	GAP Ref. EN 300 444 [10]	RAP Ref.	Status	
				CTA	FT
M.1	General	5.2		M	M
M.2	Continuous broadcast	5.2		M	M
M.3	Paging broadcast	5.2		M	M
M.4	Basic connections	5.2		M	M
M.5	Cs higher layer signalling	5.2		M	M
M.6	Quality control	5.2		M	M
M.7	Encryption activation	5.2		M	M
M.8	Extended frequency allocation (note)	5.2		M	O
M.9	Bearer Handover, intra-cell	5.2		M	C1
M.10	Bearer Handover, inter-cell	5.2		M	O
M.11	Connection Handover, intra-cell	5.2		M	C2
M.12	Connection Handover, inter-cell	5.2		M	O
M.13	SARI support	5.2		M	O
M.14	Encryption deactivation	5.2		C303	C303
M.100	LU7 service		6.2.2	C304	C304
M.101	Advance Timing		6.2.2	O	O
M.102	Continuous broadcast, Extended Fixed Part Capabilities		6.2.2	M	M
M.103	Improved channel selection		6.2.2	O	N/A
C301:	IF service M.12 THEN O ELSE M;				
C302:	IF service M.9 THEN O ELSE M;				
C303:	IF feature N.29 OR N.28 THEN M ELSE I;				
C304:	IF feature N.116 THEN M ELSE I.				
NOTE:	Handsets not supporting these extra frequencies need only adapt scanning to allow continued use of the standard DECT frequencies				

7.5 Physical Layer (PHL) services

See clause 6.5 of EN 300 444 [10].

If the LU7 64 kbit/s data bearer service is supported [N.116], the double slot physical packet P80 shall be used, EN 300 175-2 [2].

7.6 Application features

Table 4: Application features status

Feature supported					
Item no.	Name of feature	GAP Ref. EN 300 444 [10]	RAP Ref	Status	
				CTA	FT
A.1	AC_bitstring_mapping	4.2		M	M
A.2	Multiple subscription registration	4.2		O	N/A
A.100	Manual entry of the PARK and AC to CTA's		5.2	O	N/A

7.7 NWK feature to procedure mapping

Table 5: NWK feature to procedure mapping

Feature/Procedure mapping					
Feature	Procedure	GAP Ref. EN 300 444 [10]	RAP-Ref	Status	
				CTA	FT
N.1 Outgoing call		4.1		M	M
	Outgoing call request	8.2		M	M
	Overlap sending	8.3		M	O
	Outgoing call proceeding	8.4		M	O
	Outgoing call confirmation	8.5		M	O
	Outgoing call connection	8.6		M	M
	Sending keypad information	8.10		M	M
N.2 Off Hook		4.1		M	M
	Outgoing call request	8.2		M	M
	Incoming call connection	8.15		M	M
N.3 Off Hook (full release)		4.1		M	M
	Normal call release	8.2		M	M
	Abnormal call release	8.15		M	M
N.4 Dialed digits (basic)		4.1		M	M
	Sending keypad information	8.10		M	M
N.5 Register recall (Hook flash)		4.1		M	O
	Sending keypad information	8.10		M	M
N.8 Incoming call		4.1		M	M
	Incoming call request	8.12		M	M
	Incoming call confirmation	8.13		M	M
	PT alerting	8.14		M	M
	Incoming call connection	8.15		M	M
N.9 Authentication of the PP		4.1		M	M
	Authentication of PT	8.24		M	M
N.11 Location registration		4.1		M	M
	Location registration	8.28		M	M
	Location update	8.29		M	O
N.12 On air key allocation		4.1		M	O
	Key allocation	8.32		M	M
N.13 Identification of PP		4.1		M	O
	Identification of PT	8.22		M	M

Feature/Procedure mapping					
Feature	Procedure	GAP Ref. EN 300 444 [10]	RAP-Ref	Status	
				CTA	FT
N.15 Alerting		4.1		M	M
	PT alerting	8.14		M	M
N.17 Encryption activation FT initiated		4.1		M	M
	Cipher-switching initiated by FT	8.33		M	M
	Storing the DCK	8.27		M	M
N.18 Subscription registration user procedure on-air		4.1		M	M
	Obtaining access rights	8.30		M	M
N.19 Link control		4.1		M	M
	Indirect FT initiated link establishment	8.35		M	M
	Direct PT initiated link establishment	8.36		M	M
	Link release "normal"	8.37		M	M
	Link release "abnormal"	8.38		M	M
	Link release "maintain"	8.39		M	M
N.20 Terminate access rights FT initiated		4.1		M	O
	FT terminating access rights	8.31		M	M
	Authentication of FT	8.23		O	M
N.21 Partial release		4.1		M	M
	Partial release	8.9		M	M
N.26 Authentication of FT		4.1		O	O
	Authentication of FT	8.23		M	M
N.27 Encryption activation PT initiated		4.1		O	O
	Cipher-switching initiated by PT	8.34		M	M
	Storing the DCK	8.27		M	M
N.28 Encryption deactivation FT initiated		4.1		O	O
	Cipher-switching initiated by FT	8.33		M	M
N.29 Encryption deactivation PT initiated		4.1		O	O
	Cipher-switching initiated by PT	8.34		M	M
N.30 Calling Line ID Presentation (CLIP)		4.1		O	O
	Incoming call request	8.12		M	M
N.100 On Hook (conditional release)			5.1	M	M
	Sending on hook information		9.1.1	M	M
	On-hook/off-hook explicit acknowledgement		9.1.3	O	O
N.101 Calling Line ID Presentation (CLIP), inband			5.1	O	O
	Incoming call request	8.12		M	M
	U-plane connection by CC_ALERTING		9.1.2	M	M
	U-plane connection after initial ring		9.1.2	M	M
	U-plane connection after pulsed line reversal		9.1.2	M	M
N.102 Incoming maintenance transaction			5.1	M	M
	Incoming maintenance call		9.2.1	M	M
	Sending OA&M information		9.3	M	M
	Outgoing call during maintenance call		9.2.3	M	M
	Incoming call during maintenance call		9.2.4	M	M
	Claim Actions FT initiated		9.3.8.1	M	O
N.103 Outgoing maintenance transaction			5.1	M	M
	Outgoing maintenance call		9.2.2	M	M
	Sending OA&M information		9.3	M	M
	Outgoing call during maintenance call		9.2.3	M	M

Feature/Procedure mapping					
Feature	Procedure	GAP Ref. EN 300 444 [10]	Status		
			RAP-Ref	RAP	
				CTA	FT
	Incoming call during maintenance call		9.2.4	M	M
	Claim action CTA initiated		9.3.8.2	O	O
N.104 Maintenance during call			5.1	M	M
	Sending OA&M information		9.3	M	M
N.105 Metering Pulses			5.1	M	M
	Metering pulses		9.4.1	M	M
N.106 Analogue Leased Lines			5.1	O	O
	Analogue leased line establishment		9.5	M	M
N.107 Physical resources fault			5.1	M	M
	Antenna fault		9.3.1	O	O
	RF unit plus logic fault		9.3.1	O	O
	Line interface unit fault		9.3.1	O	O
	Power supply unit fault		9.3.1	O	O
	Backup battery fault		9.3.1	O	O
	Network terminating fault		9.3.1	O	O
	General unit fault		9.3.1	M	M
N.108 Remote test			5.1	M	M
	Detect network terminating unit test		9.3.2	O	O
	Detect presence of telephone test		9.3.2	O	O
	Check for leakage to earth test		9.3.2	O	O
	Detect hazardous voltage test		9.3.2	O	O
	Detect mains power at CTA test		9.3.2	O	O
	Link quality test		9.3.2	O	O
	RSSI test		9.3.2	O	O
	Ring/ Ring trip test		9.3.2	O	O
	Dialled digit test		9.3.2	O	O
	Deliver number failed remote call attempts made by CTA		9.3.2	M	M
	A-CRC test		9.3.2	O	O
	Frame error test		9.3.2	O	O
	Result on test Detect network terminating unit		9.3.2	O	O
	Result on test Detect presence of telephone		9.3.2	O	O
	Result on test Check for leakage to earth		9.3.2	O	O
	Result on test Detect hazardous voltage		9.3.2	O	O
	Result on test Detect mains power at CTA		9.3.2	O	O
	Result on test Link quality		9.3.2	O	O
	Result on test RSSI		9.3.2	O	O
	Result on test Ring/Ring trip		9.3.2	O	O
	Result on test Dialled digit		9.3.2	O	O
	Delivery of number of failed remote call attempts made by CTA		9.3.2	M	M
	Result on test A-CRC		9.3.2	O	O
	Result on test Frame error		9.3.2	O	O
N.109 Alarms			5.1	O	O
	Mains failure alarm		9.3.3	O	O
	Power supply failure alarm		9.3.3	O	O
	Low battery voltage alarm		9.3.3	O	O
	Opening of CTA enclosure alarm		9.3.3	O	O
N.110 On-air modification of user parameters			5.1	O	O
	On-air modification of user parameters		9.3.4	M	M
	Remote resynchronization		9.3.9	M	M
N.111 Switch from voice to data service FT initiated			5.1	M	M
	Switch from voice to data service FT initiated		9.4.2	M	M

Feature/Procedure mapping					
Feature	Procedure	GAP Ref. EN 300 444 [10]	RAP-Ref	Status	
				CTA	FT
N.112 Switch from voice to data service CTA initiated			5.1	O	O
	Switch from voice to data service CTA initiated		9.4.3	M	M
N.113 Coin collection			5.1	O	O
	Coin collection		9.4.3	M	M
N.114 Ground start			5.1	O	O
	Ground start		9.4.4	M	M
	Sending keypad information	8.10		M	M
N.115 Remote configuration			5.1	O	O
	Remote configuration		9.3.7	M	M
N.116 64 kbit/s bearer service using DLC LU7 service			5.1	O	O
	Switch from 32 kbit/s to 64 kbit/s bearer service FT initiated		9.4.7	M	M
	Switch from 32 kbit/s to 64 kbit/s bearer service CTA initiated		9.4.8	O	O
	Switch from 64 kbit/s to 32 kbit/s bearer service FT initiated		9.4.10	O	O
	Switch from 64 kbit/s to 32 kbit/s bearer service CTA initiated		9.4.11	O	O
N.117 Line parked			5.1	O	O
	Line parking		9.4.7	M	M
N.118 Line polarity reversal			5.1	O	O
	Line polarity reversal		9.4.5	M	M
N.119 Incoming WRS maintenance transaction			5.1	N/A	O
	Incoming WRS maintenance call		16.3.1	N/A	M
	Sending OA&M information		9.3	N/A	M
N.120 Outgoing WRS maintenance transaction			5.1	N/A	O
	Outgoing WRS maintenance call		16.3.2	N/A	M
	Sending OA&M information		9.3	N/A	M
N.121 Advanced file transfer			5.1	O	O
	Advanced file transfer		9.3.10	M	M
N.122 Maintenance during WRS MM operation			5.1	N/A	O
	Maintenance during WRS MM operation		16.3.3	N/A	M

7.8 DLC service to procedure mapping

Table 6: DLC service to procedure mapping

Service/Procedure mapping					
Service	Procedure	GAP Ref. EN 300 444 [10]	RAP Ref.	Status	
				CTA	FT
D.1 LAPC class A service and Lc		5.1		M	M
	Class A link establishment	9.1		M	M
	Class A acknowledged information transfer	9.2		M	M
	Class A link release	9.3		M	M
	Class A link re-establishment	9.4		M	M
D.2 Cs channel fragmentation and recombination		5.1		M	M
	Cs channel fragmentation and recombination	9.5		M	M
D.3 Broadcast Lb service		5.1		M	M
	Normal broadcast	9.6		M	M
D.4 Intra-cell voluntary connection handover		5.1		M	C1
	Class A basic connection handover	9.7		M	M
D.5 Intercell voluntary connection handover		5.1		M	O
	Class A basic connection handover	9.7		M	M
D.6 Encryption activation		5.1		M	M
	Encryption switching	9.8		M	M
D.7 LU1 TRUP Class 0/min_delay		5.1		M	M
	U-plane Class 0/min delay	9.9		M	M
D.8 FU1		5.1		M	M
	FU1 frame operation	9.10		M	M
D.9 Encryption deactivation		5.1		C602	C602
	Encryption switching	9.8		M	M
D.100 LU7 Service			6.1.2	C603	C603
	LU7 DLC procedure		10.3	M	M
C601: IF service M.9 THEN O ELSE M; C602: IF feature N.29 OR N.N.28 THEN M ELSE I; C603: IF feature N.116 THEN M ELSE I.					

7.9 MAC service to procedure mapping

Table 7: MAC service to procedure mapping

Service/Procedure mapping					
Service	Procedure	GAP Ref. EN 300 444 [10]	RAP Ref	Status	
				CTA	FT
M.1 General		5.2		M	M
	General	10.1		M	M
M.2 Continuous broadcast		5.2		M	M
	Downlink broadcast	10.2		M	M
M.3 Paging broadcast		5.2		M	M
	Paging broadcast	10.3		M	M
M.4 Basic connections		5.2		M	M
	Set-up of basic connection, basic bearer set-up (A-field)	10.4		M	M
	Connection/bearer release	10.5		M	M
M.5 Cs higher layer signalling		5.2		M	M
	Cs channel data	10.8		M	M
	Q2 bit setting	10.9		M	M
M.6 Quality control		5.2		M	M
	RFPI handshake	10.10		M	M
	Antenna diversity	10.11		M	O
	Sliding collision detection	10.12		O	M
M.7 Encryption activation		5.2		M	M
	Encryption process - initialization and synchronization	10.13		M	M
	Encryption mode control	10.14		M	M
M.8 Extended frequency allocation		5.2		M	O
	Extended frequency allocation	10.16		M	M
		5.2		M	C701
M.9 Bearer handover, intra-cell		5.2		M	C701
	Bearer handover request	10.6		M	M
M.10 Bearer handover, inter-cell		5.2		M	O
	Bearer handover request	10.6		M	M
M.11 Connection handover, intra-cell		5.2		M	C702
	Connection handover request	10.7		M	M
M.12 Connection handover, inter-cell		5.2		M	O
	Connection handover request	10.7		M	M
M.13 SARI support		5.2		M	O
	Downlink broadcast	10.2		M	M
M.14 Encryption deactivation		5.2		C703	C703
	Encryption mode control	10.14		M	M
M.100 LU7 service			6.2.2	C704	C704
	LU7 MAC procedure		11.3	M	M
M.101 Advance Timing			6.2.2	O	O
	Advance Timing		11.2	M	M
M.102 Continuous broadcast, Extended Fixed Part Capabilities			6.2.2	M	M
	Downlink broadcast, Extended Fixed Part Capabilities		11.4	M	M
M.103 Improved channel selection			6.2.2	O	N/A
	Improved channel selection rules		11.6	M	N/A
C701: IF service M.11 THEN O ELSE M;					
C702: IF service M.9 THEN O ELSE M;					
C703: IF feature N.29 OR N.28 THEN M ELSE I;					
C704: IF feature N.116 THEN M ELSE I.					

7.10 Application feature to procedure mapping

Table 8: Application feature to procedure mapping

Feature/Procedure mapping					
Feature	Procedure	GAP Ref. EN 300 444 [10]	RAP Ref	Status	
				CTA	FT
A.1 AC to bitstring mapping		4.2		M	M
	AC to bitstring mapping	14.2		M	M
A.2 Multiple subscription registration		4.2		O	N/A
	Subscription control	14.1		M	N/A
A.100 Manual entry of the PARK and AC for CTA			4.2	O	N/A
	Manual entry of the PARK and AC for CTA		17.3	M	N/A

7.11 General requirements

See clauses 6.9.1 to 6.9.7 of EN 300 444 [10] GAP.

8 Procedure description

See clause 7 of EN 300 444 [10] GAP.

9 NWK layer procedures

This clause specifies the NWK layer procedures, messages and information elements required in the RAP.

This profile does not prevent any PT or FT transmitting or receiving and processing any other NWK layer message or information element not specified in the profile. A PT or FT receiving an unsupported NWK layer message or information element which it does not recognize shall ignore it, as specified in clause 17 of EN 300 175-5 [5].

9.1 Reference to GAP

The following clauses of EN 300 444 [10] GAP are part of the description of the NWK-Layer Procedures for the RAP Profile (see also clause 7.7, table 3): clauses 8.1 to 8.15, 8.17, 8.22 to 8.24 and 8.27 to 8.39.

9.1.1 Release procedure for "On-hook (conditional release)"

The procedure shall be performed as defined in clause 9.5.1 of EN 300 175-5 [5]. The following text together with the associated clauses define the mandatory requirements with regard to the present document.

The CTA shall be capable of sending "on hook" information which shall be included in the <<IWU-TO-IWU>> information element using Protocol Discriminator "RAP" which can be sent with every CC-message or MM-message which is allowed to carry the <<IWU-TO-IWU>> information element on the established call. The CTA is mandated to be able to perform this procedure in state T-10, and the FT is mandated to be able to perform this procedure in state F-10. In all other states the CTA uses the normal release procedures as defined in GAP, clause 8.7.

The normal reaction of the FT will be to pass the "on-hook" information to the LE which will decide if the call shall be released or not initiate.

After the first transmission of "on-hook" the CTA shall start timer P<RAP.01>. If timer P<RAP.01> expires before a {CC-RELEASE} or {CC-RELEASE-COM} message (or optionally "on-hook-ack" information, refer to clause 9.1.3) is received, then the CTA shall send "on-hook" and shall restart timer P<RAP.01>.

The CTA shall retransmit the "on-hook" information until it receives {CC-RELEASE} or {CC-RELEASE-COM} (or optionally "on-hook-ack" information, refer to clause 9.1.3) from the FT, or until the TE hook state changes into off-hook. However the CTA should release the call using the abnormal release procedure defined in GAP, clause 8.8, in the case that the call is not released by the FT after at least N500 retransmissions of the on-hook information.

<RAP.01> On-hook retransmission timer

FT value: Not used;

PT value: 5 seconds;

Start: "On-hook" information is sent.

Stop: {CC-RELEASE} or {CC-RELEASE-COM} message is received (or optionally "on-hook-ack" is received, refer to clause 9.1.3), or "off-hook" information is sent.

N500: Minimum number of "on-hook" retransmissions before abnormal release of the call.

N500 Recommended value: 63.

If the CPE goes Off Hook after the conditional release was sent by the CTA and if the call is still established (the FT has not released it yet) the CTA shall send to the FT the "Off Hook" which shall be included in the <<IWU-TO-IWU>> information element using Protocol Discriminator "RAP" which can be sent with every CC-message or MM-message which is allowed to carry the <<IWU-TO-IWU>> information element on the established call.

The FT and CTA may use explicit acknowledgement for the "off-hook" information according to clause 9.1.3.

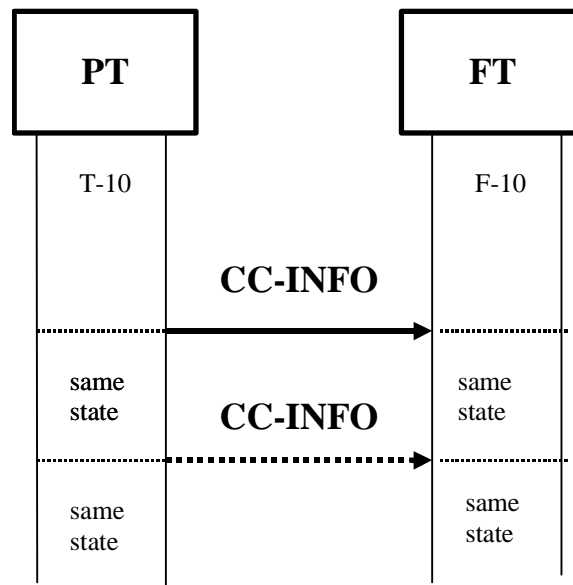

Figure 2: Sending on-hook/off hook information

If the TE at the CTA goes on-hook after line parking (while a call is not established), the CTA shall establish a normal call and release it immediately (either using the conditional release procedure or the full release procedure depending on the CC-state). Thus if the CTA receives a {CC-CONNECT} message after sending {CC-SET-UP} message, it shall use the conditional release procedure, and if the CTA receives a {CC-SET-UP-ACK} message after sending {CC-SET-UP} message, it shall use the full release procedure.

NOTE: The FT is recommended not to send "off-hook" to the LE upon receipt of {CC-SET-UP} message, if the relevant link between FT and LE is already active.

Table 9: Values used within the {CC-INFO} message

Information element	Field within the information element	Standard values within the field/IE	Normative action/comment
<<IWU-to-IWU>>			
	<Protocol Discriminator>	15 H	RAP indication
	<IWU-to-IWU information>	See annex D	On hook

Table 10: Values used within the {CC-INFO} message

Information element	Field within the information element	Standard values within the field/IE	Normative action/comment
<<IWU-to-IWU>>			
	<Protocol Discriminator>	15 H	RAP indication
	<IWU-to-IWU information>	See annex D	Off Hook

9.1.2 CLIP, inband

If the GAP feature "CLIP" is applied for CTAs, too, to transmit CLIP information, it requires conversion between DECT messages and inband signalling in the CTA, and possibly the opposite conversion in the FP. In contrast to that, the RAP feature "CLIP, inband [N.101]" allows to transmit inband CLIP signals (DTMF or modem tones in the speech channel) transparently from the LE via the FP and the CTA to the Terminal Equipment (TE) during an incoming call set-up before off-hook. However some notification from the CTA to the LE via the FP about the availability of the speech channel may be required for synchronization and timing. So the procedure N.101 is best suited under the following conditions:

- if the LE provides the CLIP inband tones; and
- if the LE can be notified by the FP about the availability of the speech channel.

Depending on the type of CLIP procedure applied by the LE and supported by the TE, the inband CLIP signals to be sent to the TE may or may not be preceded by either of the following:

- an initial ring;
- a pulsed line polarity reversal.

In any case the LE should be informed about the execution of these pulsed signals, and of the availability of the speech channel. Therefore the NWK feature "CLIP, inband [N.101]" requires the following procedures:

- Incoming call request;
- U-plane connection within the CTA (receive side) by CC_ALERTING;
- U-plane connection within the CTA (receive side) and pulse notification after initial ring;
- U-plane connection within the CTA (receive side) and pulse notification after pulsed line polarity reversal.

Hence a CTA supporting N.101 shall connect the speech channel to the TE for an incoming call under the following conditions:

- in case of an incoming SET-UP for a normal call without ringing information: By sending CC_ALERTING;
- in case of an incoming SET-UP with initial ring information: At the end of the initial ring. The end of initial ring shall be notified to the FP;
- in case of an incoming SET-UP with a request for pulsed line polarity reversal: At the end of that line reversal pulse. The CTA shall notify the FP of the end of that pulse.

In addition any CTA shall connect the U-plane as soon as it receives a message (e.g. a SET-UP message) containing the "Progress Indicator" element with cause 8, as described in EN 300 175-5 [5], clauses 9.3.2 and 9.3.2.4: the CTA is required to request the LLME to connect its receive U-plane as soon as it receives a message containing the <<PROGRESS-INDICATOR>> element indicating cause no. 8 ("in-band information or appropriate pattern is now available in band").

If this <<PROGRESS-INDICATOR>> element is not used, and none of the CLIP procedures described above applies, then the CTA may delay the connection of the U-plane for incoming calls until receiving the {CC-CONNECT-ACK} message.

9.1.3 On-hook/off-hook explicit acknowledgement

The CTA is mandated to be able to perform this procedure in state T-10, and the FT is mandated to be able to perform this procedure in state F-10.

The CTA shall be capable of sending "on hook" information which shall be included in the <<IWU-TO-IWU>> information element using Protocol Discriminator "RAP" which can be sent with every CC-message or MM-message which is allowed to carry the <<IWU-TO-IWU>> information element on the established call.

Upon receipt of "on-hook" information the FT shall be capable of sending "on-hook-ack" information which shall be included in the <<IWU-TO-IWU>> information element using Protocol Discriminator "RAP" which can be sent with every CC-message or MM-message which is allowed to carry the <<IWU-TO-IWU>> information element on the established call.

After the first transmission of "on-hook" the CTA shall start timer P<RAP.01> (refer to clause 9.1.1 for <RAP.01> definition). If timer P<RAP.01> expires before a {CC-RELEASE} or {CC-RELEASE-COM} message or "on-hook-ack" information is received, then the CTA shall send "on-hook" and shall restart timer P<RAP.01>.

The CTA shall retransmit the "on-hook" information until it receives {CC-RELEASE} or {CC-RELEASE-COM} or "on-hook-ack" information from the FT. However the CTA should release the call using the abnormal release procedure defined in GAP, clause 8.8, if the "on-hook-ack" information is not received or the call is not released by the FT after at least N500 retransmissions of the on-hook information (refer to clause 9.1.1 for N500 definition).

The CTA shall be capable of sending "off hook" information which shall be included in the <<IWU-TO-IWU>> information element using Protocol Discriminator "RAP" which can be sent with every CC-message or MM-message which is allowed to carry the <<IWU-TO-IWU>> information element on the established call.

Upon receipt of "off-hook" information the FT shall be capable of sending "off-hook-ack" information which shall be included in the <<IWU-TO-IWU>> information element using Protocol Discriminator "RAP" which can be sent with every CC-message or MM-message which is allowed to carry the <<IWU-TO-IWU>> information element on the established call.

After the first transmission of "off-hook" the CTA shall start timer P<RAP.02>. If timer P<RAP.02> expires before the "off-hook-ack" information is received, and the TE hook state is still off-hook, then the CTA shall send "off-hook" and shall restart timer P<RAP.02>.

The CTA shall retransmit the "off-hook" information N501 times.

<RAP.02>: Off-hook retransmission timer

FT value: Not used;

PT value: 2 seconds;

Start: "Off-hook" information is sent.

Stop: "Off-hook-ack" information is received, or "on-hook" information is sent, or N501 retransmissions have been executed.

N501: Maximum number of "off-hook" retransmissions.

N501 recommended value: at least 15.

Table 11: Values used within the {CC-INFO} message

Information element	Field within the information element	Standard values within the field/IE	Normative action/comment
<<IWU-to-IWU>>			
	<Protocol Discriminator>	15 H	RAP indication
	<IWU-to-IWU information>	See annex D	On-hook-ack

Table 12: Values used within the {CC-INFO} message

Information element	Field within the information element	Standard values within the field/IE	Normative action/comment
<<IWU-to-IWU>>			
	<Protocol Discriminator>	15 H	RAP indication
	<IWU-to-IWU information>	See annex D	Off-Hook-ack

9.2 Maintenance calls

For the following maintenance calls the special call class "OA&M call" is required in the IE <<Basic service>> of the {CC_SET-UP} message.

9.2.1 Incoming maintenance call

The incoming call procedures as defined in GAP shall be used. The FT is not required to send the <<SIGNAL>> info element during the incoming maintenance call procedure.

9.2.2 Outgoing maintenance call

The outgoing call procedures as defined in GAP shall be used. The CTA is not required to send the <<KEYPAD>> info element during the outgoing maintenance call procedure.

9.2.3 Outgoing call during maintenance call

The CTA shall release the maintenance call with partial release and shall initiate afterwards the outgoing call.

NOTE: The operator may wish to prohibit new services such as outgoing calls at the CTA by using the Claim actions as specified in clause 9.3.8.

9.2.4 Incoming call during maintenance call

The FT shall release the maintenance call with partial release and shall initiate afterwards the incoming call.

9.3 Sending OA&M information

The FT and the CTA shall be capable of exchanging "OA&M" information which shall be included in the <<IWU-TO-IWU>> information element using Protocol Discriminator "RAP" which can be sent with every CC-message or MM-message which is allowed to carry the <<IWU-TO-IWU>> information element on an established call. In the case no call is established, the CTA can set-up an outgoing maintenance call, and the FT can set-up an incoming maintenance call to transmit the OA&M messages.

Table 13: Values used within the {CC-INFO} message

Information element	Field within the information element	Standard values within the field/IE	Normative action/comment
<<IWU-to-IWU>>			
	<Protocol Discriminator>	15 H	RAP indication
	<IWU-to-IWU information>	See annex D	Codings for OA&M information

9.3.1 Physical resources fault

If the CTA wants to inform the FT about a physical resources fault it shall send "physical resources fault" which shall be included in the <<IWU-TO-IWU>> information element using Protocol Discriminator "RAP".

Table 14: Values used within the {CC-INFO} message

Information element	Field within the information element	Standard values within the field/IE	Normative action/comment
<<IWU-to-IWU>>			
	<Protocol Discriminator>	15 H	RAP indication
	<IWU-to-IWU information>	See annex D	Physical resources fault

9.3.2 Remote test

If the FT wants the CTA to perform remote controlled tests it shall send "remote test activation" which shall be included in the <<IWU-TO-IWU>> information element using Protocol Discriminator "RAP".

Table 15: Values used within the {CC-INFO} message

Information element	Field within the information element	Standard values within the field/IE	Normative action/comment
<<IWU-to-IWU>>			
	<Protocol Discriminator>	15H	RAP indication
	<IWU-to-IWU information>	See annex D	Remote test activation

Depending on the test to be performed the CTA may answer to the remote CTA test activation with a remote test information which shall be included in the <<IWU-TO-IWU>> information element using Protocol Discriminator "RAP".

Table 16: Values used within the {CC-INFO} message

Information element	Field within the information element	Standard values within the field/IE	Normative action/comment
<<IWU-to-IWU>>			
	<Protocol Discriminator>	15 H	RAP indication
	<IWU-to-IWU information>	See annex D	Remote test information

9.3.3 Alarms

If the CTA wants to inform the FT about alarms it shall send "alarms" which shall be included in the <<IWU-TO-IWU>> information element using Protocol Discriminator "RAP".

Table 17: Values used within the {CC-INFO} message

Information element	Field within the information element	Standard values within the field/IE	Normative action/comment
<<IWU-to-IWU>>			
	<Protocol Discriminator>	15 H	RAP indication
	<IWU-to-IWU information>	See annex D	Alarms

9.3.4 On-air modification of user parameters

9.3.4.1 Modification of existing users parameters

The procedure shall be performed as defined in clause 13.5 of EN 300 175-5 [5].

The following text together with the associated clauses define the mandatory requirement with regard to the present document.

The procedure consists of two consecutive MM transactions: one "access rights modify" suggest and subsequently an "obtaining access rights" with its own independent transaction identifier.

An "access rights modify suggest" results in a modification (of the subscription data) of the active IPUI and PARK pair.

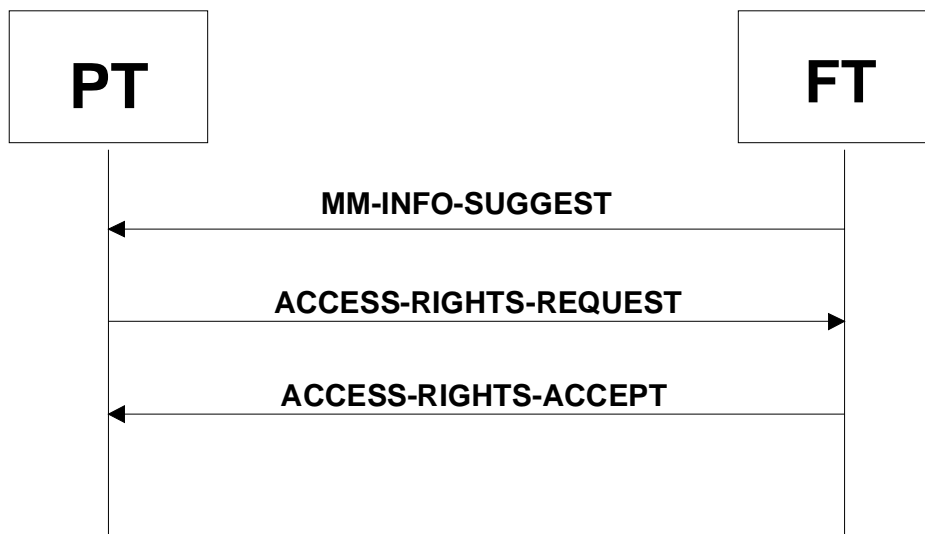

Figure 3: On air modification of user parameters

Table 18: Values used within the {MM-INFO-SUGGEST} message

Information element	Field within the information element	Standard values within the field/IE	Normative action/comment
<<Info-type>>			
	<ext>	0/1	1 if last octet, 0 if not
	<Parameter type>	1	Access rights modify suggest

The PT shall initiate the on-air subscription procedure after the receipt of the {MM-INFO-SUGGEST} message, containing the access rights modify suggest. A PT may reject the access rights modify suggest using the {MM-INFO-REJECT}.

The values used within the {ACCESS-RIGHTS-REQUEST} and {ACCESS-RIGHTS-ACCEPT} messages shall be compatible with clause 8.30 of EN 300 444 [10].

If the FT does assign a new PARK to the PT in {ACCESS-RIGHTS-ACCEPT} message, it is necessary that the FT invokes the remote resynchronization procedure as described in clause 9.3.9, to force the PT to lock to a system whose ARI matches the new PARK.

9.3.4.2 Additional subscriptions to the same fixed part

If the FT wants a new port of a multiport CTA to be subscribed to itself it can send "subscription suggest" which shall be included in the <<IWU-TO-IWU>> information element using Protocol Discriminator "RAP".

Table 19: Values used within the {CC-INFO} message

Information element	Field within the information element	Standard values within the field/IE	Normative action/comment
<<IWU-to-IWU>>			
	<Protocol Discriminator>	15 H	RAP indication
	<IWU-to-IWU information>	See annex D	Subscription suggest (port nr)

On reception of this message the CTA shall perform the obtaining access rights procedure at the requested port given with the Subscription suggest. This obtaining access rights procedure shall be carried out only to the system that invoked the subscription suggest message. The FT shall set bit a44 of the higher layer capabilities-bits to "access_rights_supported" when sending the subscription suggest message. The CTA will assume this bit to be set when starting the obtain access rights procedure and will not check if it is set.

When there is no UAK present, the AC required for this additional subscription is the one assigned to the request port. When both, AC and UAK are available, the FP shall suggest the procedure for new subscription. In the case that no AC is available for this port, it shall be derived using the procedure as described in clause 9.3.4.3.

9.3.4.3 Derivation of AC for additional subscriptions

The CTA shall derive the needed AC for the requested port in the following way: the AC for the requested port is derived from the 4 most significant Bytes of the UAK of the port at which the request for an additional subscription was received. The most significant Bit of this UAK will also be the most significant bit of the new AC.

To avoid ambiguity problems in calculating the AC from the UAK, the following rule shall be used: When, as stated in clause 4.5.2 of EN 300 175-7 [7], both AC and UAK are input into the B1-process in the form described below, then the new AC shall be derived from the UAK as shown in "rule 1" of figure 4.

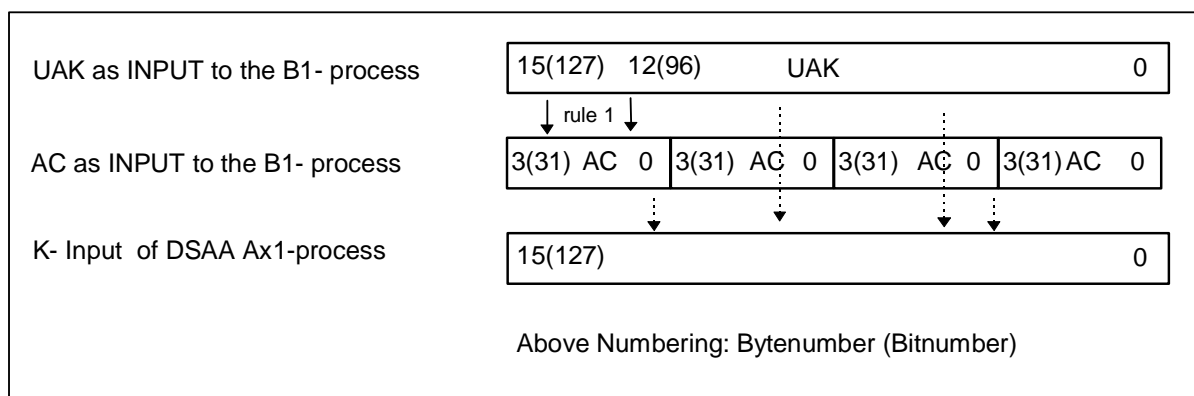

Figure 4: AC and UAK in B1 process

9.3.5 Start quality measurement

If the FT wants the CTA to perform quality measurements it shall send "start quality measurement" which shall be included in the <<IWU-TO-IWU>> information element using Protocol Discriminator "RAP".

Table 20: Values used within the {CC-INFO} message

Information element	Field within the information element	Standard values within the field/IE	Normative action/comment
<<IWU-to-IWU>>			
	<Protocol Discriminator>	15 H	RAP indication
	<IWU-to-IWU information>	See annex D	Start quality measurement (parameters)

Depending on the parameters given with the start quality measurement message the CTA may start sending "quality measurement value" which shall be included in the <<IWU-TO-IWU>> information element using Protocol Discriminator "RAP".

Table 21: Values used within the {CC-INFO} message

Information element	Field within the information element	Standard values within the field/IE	Normative action/comment
<<IWU-to-IWU>>			
	<Protocol Discriminator>	15 H	RAP indication
	<IWU-to-IWU information>	See annex D	Quality measurement value

9.3.6 Stop quality measurement

If the FT wants the CTA to stop quality measurements it shall send "stop quality measurement" which shall be included in the <<IWU-TO-IWU>> information element using Protocol Discriminator "RAP".

Table 22: Values used within the {CC-INFO} message

Information element	Field within the information element	Standard values within the field/IE	Normative action/comment
<<IWU-to-IWU>>			
	<Protocol Discriminator>	15 H	RAP indication
	<IWU-to-IWU information>	See annex D	Stop quality measurement

9.3.7 Remote configuration

If the FT wants to do a remote configuration parameter downloading in the CTA it shall send "remote configuration (request)" which shall be included in the <<IWU-TO-IWU>> information element using Protocol Discriminator "RAP" which can be sent with every CC-message or MM-message which is allowed to carry the <<IWU-TO-IWU>> information element on an established call. In the case no call is established, the FT can set-up an incoming maintenance call.

Table 23: Values used within the {CC-INFO} message

Information element	Field within the information element	Standard values within the field/IE	Normative action/comment
<<IWU-to-IWU>>			
	<Protocol Discriminator>	15 H	RAP indication
	<IWU-to-IWU information>	See annex D	Remote configuration (request)

To indicate to the FT its MODEL (MANIC + MODIC) code the CTA shall answer to the remote configuration (request) with a remote configuration (confirm) which shall be included in the <<IWU-TO-IWU>> information element using Protocol Discriminator "RAP" which can be sent with every CC-message or MM-message which is allowed to carry the <<IWU-TO-IWU>> information element on an established call. In the case no call is established, the CTA can set-up an outgoing maintenance call.

Table 24: Values used within the {CC-INFO} message

Information element	Field within the information element	Standard values within the field/IE	Normative action/comment
<<IWU-to-IWU>>			
	<Protocol Discriminator>	15 H	RAP indication
	<IWU-to-IWU information>	See annex D	Remote configuration (confirm) with MANIC and MODIC codes

Then the FT shall transmit the parameters for the remote configuration sending the "remote configuration information" command which shall be included in the <<IWU-TO-IWU>> information element using Protocol Discriminator "RAP" which can be sent with every CC-message or MM-message which is allowed to carry the <<IWU-TO-IWU>> information element on an established call. In the case no call is established, the FT can set-up an incoming maintenance call.

The <<IWU-TO-IWU>> information element shall include the remote configurations parameters as it is indicated in annex D.

9.3.8 Claim Actions

Claim Actions initiated either in FT side or in CTA side implies impose restrictions on the CTAs and FT normal operation. With the claiming imposed restrictions the CTA and FT are not allowed to initiate any new procedure as part of features **1**, **N.2**, **N.5**, **N.8** and **N.11**.

The CTA shall always accept the Claim Actions FT Initiated (excluding the case of failure in FT authentication).

The FT shall have the responsibility to accept or to reject the Claim Actions CTA Initiated. The non-appearance of a response shall be interpreted, in CTA side, as FT reject.

When Claim Actions initiated in CTA or FT side the ongoing procedures are allowed to continue in CTA. The FT shall have the responsibility, when Claim Actions initiated in FT side, after the completion of the Claim Actions to release or to allow the ongoing procedures to continue.

The Claim Actions in CTA side are initiated for deferrable maintenance purposes and shall not apply for failure conditions that allow for affecting the ongoing procedures.

The Claim Actions in FT side are initiated either for deferrable maintenance purposes or as a serious fault result that allows for affecting the ongoing procedures.

9.3.8.1 Claim Actions FT side Initiated

If the FT wants to claim, it shall send "claim enable" which shall be included in the <<IWU-TO-IWU>> IE using Protocol Discriminator "RAP" in a {CC-INFO}-message.

Upon receipt of the "Claim Enable", the CTA shall respond to the FT by sending "Claim Active" which shall be included in the <<IWU-TO-IWU>> IE using protocol discriminator "RAP" in a {CC-INFO} message.

The response "Claim Active" works as Acknowledgement for value "Claim Enable".

Upon completion of the Claim Action the FT shall block all new procedure invocations. In addition the FT shall have the responsibility either to terminate the ongoing procedures initiating abnormal call release or to allow the ongoing procedures to continue.

Upon receipt of the "Claim Enable", the CTA shall block all new procedure invocations (part of the features listed above), but without termination of any ongoing procedures.

NOTE 1: The user of a CPE attached to a claimed CTA may be informed of the claimed situation by e.g. a congestion tone.

NOTE 2: The CTA is recommended to authenticate the FT upon receipt of "Claim Enable", before it responds with "Claim Active". In case of authentication failure the receipt of "Claim Enable" is ignored.

If the FT wants to disable a claim, it shall send "claim disable" which shall be included in the <<IWU-TO-IWU>> IE using Protocol Discriminator "RAP" in a {CC-INFO}-message.

Upon receipt of the "Claim Disable", the CTA shall respond to the FT by sending "Claim Inactive" which shall be included in the <<IWU-TO-IWU>> IE using protocol discriminator "RAP" in a {CC-INFO} message.

The response "Claim Inactive" works as Acknowledgement for value "Claim Disable".

Upon completion of the Claim Action the FT shall have no restrictions on the invocation of new procedures.

Upon receipt of the "Claim Disable" the CTA shall have no restrictions on the invocation of new procedures.

The {CC-INFO} message shall be send during an established call. If no call is established the FT can set-up an incoming maintenance call to transmit this OA&M message.

Table 25: Values used within the {CC-INFO} message

Information element	Field within the information element	Standard values within the field/IE	Normative action/comment
<<IWU-to-IWU>>			
	<Protocol Discriminator>	15 H	RAP indication
	<IWU-to-IWU information>	See annex D	Claim enable/Claim disable

Table 26: Values used within the {CC-INFO} message

Information element	Field within the information element	Standard values within the field/IE	Normative action/comment
<<IWU-to-IWU>>			
	<Protocol Discriminator>	15 H	RAP indication
	<IWU-to-IWU information>	See annex D	Claim active/Claim inactive

9.3.8.2 Claim Actions CTA Initiated

If the CTA wants to enable a claim, it shall send "claim enable" which shall be included in the <<IWU-TO-IWU>> IE using protocol discriminator "RAP" in a {CC-INFO} message.

The FT may accept or reject the Claim Action; if the "claim enable" is accepted the FT shall respond to CTA with "Claim Active" which shall be included in the <<IWU-TO-IWU>> IE using protocol discriminator "RAP" in a {CC-INFO} message otherwise the FT shall respond to CTA with "Claim Inactive" which shall be included in the <<IWU-TO-IWU>> IE using protocol discriminator "RAP" in a {CC-INFO} message. The non-appearance of a response shall be interpreted as FT reject.

For the value "Claim Enable" the response "Claim Active" means FT accept while the response "Claim Inactive" means FT reject.

If the CTA wants to disable a claim, it shall send "claim disable" which shall be included in the <<IWU-TO-IWU>> IE using protocol discriminator "RAP" in a {CC-INFO} message.

The FT may accept or reject the Claim Action; if the "claim disable" is accepted the FT shall respond to CTA with "Claim Inactive" which shall be included in the <<IWU-TO-IWU>> IE using protocol discriminator "RAP" in a {CC-INFO} message otherwise the FT shall respond to CTA with "Claim Active" which shall be included in the <<IWU-TO-IWU>> IE using protocol discriminator "RAP" in a {CC-INFO} message. The non-appearance of a response shall be interpreted as FT reject.

For the value "Claim Disable" the response "Claim Inactive" means FT accept while the response "Claim Active" means FT reject.

Table 26A: Set of Claim Actions CTA Initiated

CTA	FT		Comment
	Accept	Reject	
Claim Enable	Claim Active	Claim Inactive Or none	When FT accept, new procedures are not allowed but without termination of ongoing procedures.
Claim Disable	Claim Inactive	Claim Active Or none	When FT accept, new procedures are allowed.

The {CC-INFO} messages shall be sent during an established call. If no call is established the CTA can set up an outgoing maintenance call to transmit this OA&M message.

Reference to tables 23 and 24 regarding the values used within the {CC-INFO} messages.

When the "Claim Enable" is accepted, the FT and CTA shall have to block all new procedure invocations (procedure part of the features listed above), but without termination of any ongoing procedures.

When the "Claim Disable" is accepted, the FT and CTA shall have no restrictions on the invocation of new procedures.

9.3.9 Remote resynchronization

If the FT wants the CTA to perform resynchronization it shall send "resynchronization request" which shall be included in the <<IWU-TO-IWU>> information element using Protocol Discriminator "RAP".

Table 27: Values used within the {CC-INFO} message

Information element	Field within the information element	Standard values within the field/IE	Normative action/comment
<<IWU-to-IWU>>			
	<Protocol Discriminator>	15 H	RAP indication
	<IWU-to-IWU information>	See annex D	Resynchronization request

The remote resynchronization is used to inform a locked CTA about new static system information or new arrangements of carriers etc.

NOTE: The operator may wish to terminate any ongoing services, and prohibit new services at the CTA by using the Claim actions as specified in clause 9.3.8, before issuing the resynchronization request.

9.3.10 Advanced file transfer

If the FT wants to perform an advanced file transfer in the CTA it shall send "advanced file transfer (request)" which shall be included in the <<IWU-TO-IWU>> information element using Protocol Discriminator "RAP" which can be sent with every CC-message or MM-message which is allowed to carry the <<IWU-TO-IWU>> information element on an established call. If the case no call is established, the FT can set-up an incoming maintenance call.

Table 28: Values used within the {CC-INFO} message

Information element	Field within the information element	Standard values within the field/IE	Normative action/comment
<<IWU-to-IWU>>			
	<Protocol Discriminator>	15 H	RAP indication
	<IWU-to-IWU information>	See annex D	Advanced file transfer (request)

To indicate to the FT its MODEL (MANIC + MODIC) code the CTA shall answer to the advanced file transfer (request) with an advanced file transfer (confirm) which shall be included in the <<IWU-TO-IWU>> information element using Protocol Discriminator "RAP" which can be sent with every CC-message or MM-message which is allowed to carry the <<IWU-TO-IWU>> information element on an established call. If the case no call is established, the CTA can set-up an outgoing maintenance call.

Table 29: Values used within the {CC-INFO} message

Information element	Field within the information element	Standard values within the field/IE	Normative action/comment
<<IWU-to-IWU>>			
	<Protocol Discriminator>	15 H	RAP indication
	<IWU-to-IWU information>	See annex D	Advanced file transfer (confirm) with MANIC and MODIC codes

NOTE: The procedure that has to be used for file transfer phase which will follow this first phase, is not defined in the present document. The main application of this procedure is software download: for good performance the B-field could be used.

9.4 RLL-CC

The FT and the CTA shall be capable of exchanging "RAP-CC" information which shall be included in the <<IWU-TO-IWU>> information element using Protocol Discriminator "RAP" which can be sent with every CC-message which is allowed to carry the <<IWU-TO-IWU>> information element on an established call.

9.4.1 Metering pulses

If the FT wants the CTA to generate metering pulses towards the CPE, it shall send "metering pulse indication". This "metering pulse indication" contains the number of metering pulses to be generated. The "metering pulse indication" shall be included in the <<IWU-TO-IWU>> information element using Protocol Discriminator "RAP".

Table 30: Values used within the {CC-INFO} message

Information element	Field within the information element	Standard values within the field/IE	Normative action/comment
<<IWU-to-IWU>>			
	<Protocol Discriminator>	15 H	RAP indication
	<IWU-to-IWU information>	See annex D	Metering pulse indication

Upon receipt of the "metering pulse indication", the CTA shall generate the indicated amount of metering pulses towards the CPE. After the last metering pulse has been generated, the CTA shall send "pulse notification" towards the FT, to acknowledge the proper execution of the request. The "pulse notification" shall be included in the <<IWU-TO-IWU>> information element using Protocol Discriminator "RAP".

Table 31: Values used within the {CC-INFO} message

Information element	Field within the information element	Standard values within the field/IE	Normative action/comment
<<IWU-to-IWU>>			
	<Protocol Discriminator>	15 H	RAP indication
	<IWU-to-IWU information>	See annex D	Pulse notification

9.4.2 Switch from voice to data service FT initiated

The FT shall detect the 2,1 kHz modem tone during an established call in the Audio Channel.

If the modem tone is detected and the feature **N.116** is supported the procedure described in clause 9.4.7 shall apply otherwise the FT shall send "modem tone detection" to the CTA. This command shall be included in the <<IWU-TO-IWU>> information element using Protocol Discriminator "RAP" which can be sent with every CC-message or MM-message which is allowed to carry the <<IWU-TO-IWU>> information element on the established call.

The FT shall disable all the echo control functions without matter if the tone contains phase reversal or not (see clause 13.3.2).

The CTA shall be capable to receive and process the "modem tone detection" and receiving it the CTA shall disable all the existing echo control functions without matter if the tone contains phase reversal or not (see clause 13.3.2).

Table 32: Values used within the {CC-INFO} message

Information element	Field within the information element	Standard values within the field/IE	Normative action/comment
<<IWU-to-IWU>>			
	<Protocol Discriminator>	15 H	RAP indication
	<IWU-to-IWU information>	See annex D	Modem tone detection

9.4.3 Switch from voice to data service CTA initiated

The CTA shall detect the 2.1 kHz modem tone during an established call in the Audio Channel.

If the modem tone is detected and the feature **N.116** is supported the procedure described in clause 9.4.8 shall apply otherwise the CTA shall send "modem tone detection" to the FT. This command shall be included in the <<IWU-TO-IWU>> information element using Protocol Discriminator "RAP" which can be sent with every CC-message or MM-message which is allowed to carry the <<IWU-TO-IWU>> information element on the established call.

The CTA shall disable all the existing echo control functions without matter if the tone contains phase reversal or not (see clause 13.3.2).

The FT shall be capable to receive and process the "modem tone detection" and receiving it the FT shall disable all the echo control functions without matter if the tone contains phase reversal or not (see clause 13.3.2).

Table 33: Values used within the {CC-INFO} message

Information element	Field within the information element	Standard values within the field/IE	Normative action/comment
<<IWU-to-IWU>>			
	<Protocol Discriminator>	15 H	RAP indication
	<IWU-to-IWU information>	See annex D	Modem tone detection

9.4.4 Coin collection

If the CTA wants to notify the result of coin collection to the FT during an established call it shall send "coin collection" which shall be included in the <<IWU-TO-IWU>> information element using Protocol Discriminator "RAP".

Table 34: Values used within the {CC-INFO} message

Information element	Field within the information element	Standard values within the field/IE	Normative action/comment
<<IWU-to-IWU>>			
	<Protocol Discriminator>	15 H	RAP indication
	<IWU-to-IWU information>	See annex D	Coin collection

9.4.5 Ground start

If the CTA wants to indicate ground start to the FT it shall send keypad information following the procedure defined in clause 8.10 of the GAP using the keypad information for register recall (15 H).

9.4.6 Line polarity reversal

If the FT wants the CTA to generate a line polarity reversal during an established call it shall send "line polarity reversal" which shall be included in the <<IWU-TO-IWU>> information element using Protocol Discriminator "RAP".

Table 35: Values used within the {CC-INFO} message

Information element	Field within the information element	Standard values within the field/IE	Normative action/comment
<<IWU-to-IWU>>			
	<Protocol Discriminator>	15 H	RAP indication
	<IWU-to-IWU information>	See annex D	Line polarity reversal

9.4.7 Switch from 32 kbit/s to 64 kbit/s bearer service (FT initiated)

This service is required to switch, during a call (i.e. ACTIVE state), from a 32 kbit/s LU1 bearer service, basic connection LCNx, full slot, I_N minimum delay, to a 64 kbit/s LU7 bearer service, advanced connection LCNx, double slot, I_N normal delay.

The FT shall detect the 2,1 kHz modem tone during as established call in the Audio Channel and after detecting it, the FT shall start the switching LU1 to LU7 procedure which is managed by the NWK, DLC and MAC layers with the coordination of the LLME entity.

Procedure description:

The FT after detecting the 2,1 kHz modem tone shall send the "switch to 64 kbit/s bearer service request" which shall be included in the <<IWU-TO-IWU>> information element using Protocol Discriminator "RAP" which can be sent with every CC-message or MM-message which is allowed to carry the <<IWU-TO-IWU>> information element on the established call.

The FT shall disable all the echo control functions without matter if the tone contains phase reversal or not (see clause 13.3.2).

The CTA after receiving the "switch to 64 kbit/s bearer service" request, informs the LLME of the request. If the request is accepted the LLME starts the switching procedure at the DLC and MAC layer. If the request is accepted the CTA shall disable all the existing echo control functions without matter if the tone contains phase reversal or not (see clause 13.3.2) and shall start the DLC and MAC layer switching procedure.

If the request is rejected the CTA shall send "switch to 64 kbit/s bearer service reject" which shall be included in the <<IWU-TO-IWU>> information element using Protocol Discriminator "RAP" which can be sent with every CC-message or MM-message which is allowed to carry the <<IWU-TO-IWU>> information element on the established call.

The DLC and MAC layer procedure is started at the CTA side: at first the connection type is changed from basic to advanced, without changing the slot format, using the connection type modification procedure and then the slot type is changed from full to double performing a bearer handover or a connection handover: the handover procedure is always started by the CTA.

If the intra-cell bearer handover procedure is supported at both side it shall be used otherwise the intra-cell connection handover procedure shall be used.

The MAC layer in the CTA receives a MAC_MOD-req primitive for switching the connection characteristics from:

- a basic connection, identified by an MCEI, to an advanced connection, identified by the pair: MCEI and ECN;
- full slot to double slot;
- I_N minimum delay to I_N normal delay.

This initiates a switching process.

The CTA starts to transmit in the next even numbered frame the attributes_T_request (basic connection control set). This is repeated in five successive even numbered frames or until the CTA receives the attributes_T_confirm (basic connection control set).

The CTA shall acknowledge the receipt of the attributes_T_confirm message by the transmission of an other message in the next TDMA frame and after that shall start the handover procedure.

If the attributes_T_confirm is not received than the CTA shall release the connection and the DLC layer is informed using the MAC_DIS-ind primitive.

The FT after receiving the attributes_T_request message from the CTA, shall start the T218 timer within which the switching procedure (attributes scenario and handover scenario) shall be completed and shall transmit the attributes_T_confirm message. Every time the attributes_T_request is received from the CTA (repeated) the attributes_T_confirm shall be retransmitted to the CTA.

If the timer expires the FT shall release the connection and the DLC layer is informed using the MAC_DIS-ind primitive.

If the handover procedure fails, the connection is released and the DLC is informed using the MAC_DIS-ind primitive.

The MAC at both sides, after the handover procedure has been performed successfully, sends to the DLC the MAC_MOD primitive, confirm or indication indicating that the old connection identified by the MCEI has changed its service profile as requested and is now identified by the pair old MCEI and new ECN and that the procedure has been successfully completed. The DLC can now perform the switching of the U-plane channel. The DLC at both sides indicates to the LLME that the procedure has been correctly done: the LLME reports this indication to the NWK layer.

Message flow:

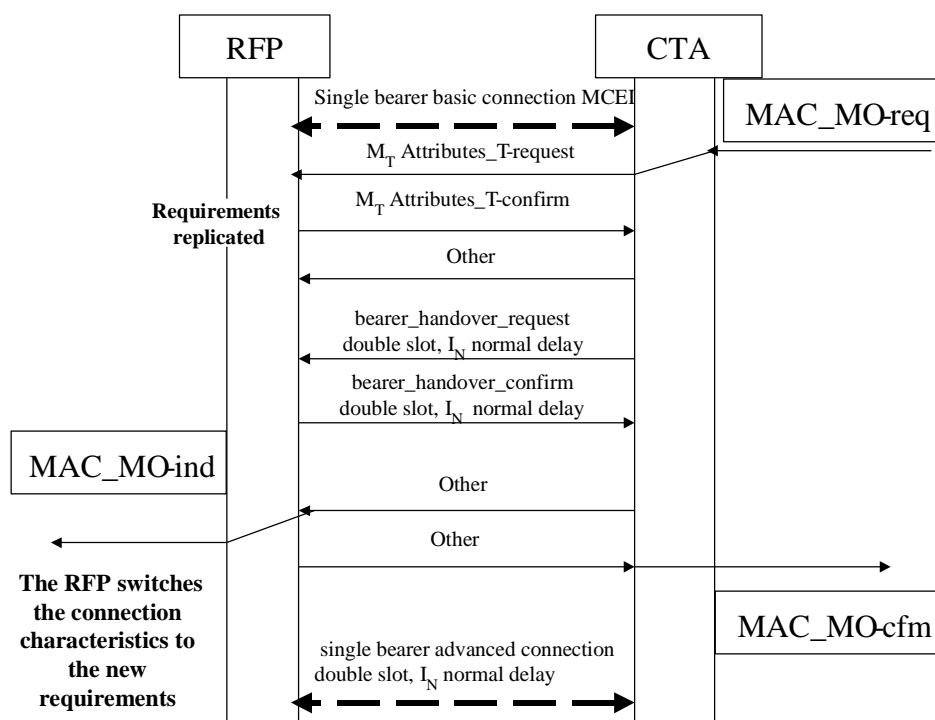

Figure 5: 32 kbit/s to 64 kbit/s switch, FT initiated

Table 36: Values used within the {CC-INFO} message

Information element	Field within the information element	Standard values within the field/IE	Normative action/comment
<<IWU-to-IWU>>			
	<Protocol Discriminator>	15 H	RAP indication
	<IWU-to-IWU information>	See annex D	switch to 64 kbit/s bearer service request/reject

Switching collision: a switching collision occurs when both sides detect the modem tone and starts the switching sending the "switch to 64 kbit/s bearer service request". In this case the switching FT initiated takes priority. If the FT, after having sent the "switch to 64 kbit/s bearer service request" receives from the CTA the "switch to 64 kbit/s bearer service request" it shall ignore it. If the CTA, after having sent the "switch to 64 kbit/s bearer service request" receives from the FT the "switch to 64 kbit/s bearer service request" it shall process it and discharge its one.

9.4.8 Switching from 32 kbit/s to 64 kbit/s bearer service CTA initiated

This service is required to switch, during a call (i.e. ACTIVE state), from a 32 kbit/s LU1 bearer service, basic connection LCNx, full slot, I_N minimum delay, to a 64 kbit/s LU7 bearer service, advanced connection LCNx, double slot, I_N normal delay.

The CTA shall detect the 2,1 kHz modem tone during as established call in the Audio Channel and after detecting it, the CTA shall start the switching LU1 to LU7 procedure which is managed by the NWK, DLC and MAC layers with the co-ordination of the LLME entity.

Procedure description:

The CTA after detecting the 2,1 kHz modem tone shall send the "switch to 64 kbit/s bearer service request" which shall be included in the <<IWU-TO-IWU>> information element using Protocol Discriminator "RAP" which can be sent with every CC-message or MM-message which is allowed to carry the <<IWU-TO-IWU>> information element on the established call.

The CTA shall disable all the existing echo control functions without matter if the tone contains phase reversal or not (see clause 13.3.2).

The FT after receiving the "switch to 64 kbit/s bearer service" request, informs the LLME of the request. If the request is accepted the LLME starts the switching procedure at the DLC and MAC layer. If the request is accepted the FT shall disable all the echo control functions without matter if the tone contains phase reversal or not (see clause 13.3.2) and shall start the DLC and MAC layer switching procedure.

If the request is rejected the FT shall send "switch to 64 kbit/s bearer service reject" which shall be included in the <<IWU-TO-IWU>> information element using Protocol Discriminator "RAP" which can be sent with every CC-message or MM-message which is allowed to carry the <<IWU-TO-IWU>> information element on the established call.

The DLC and MAC layer procedure is started at the FT side: at first the connection type is changed from basic to advanced, without changing the slot format, using the connection type modification procedure and then the slot type is changed from full to double performing a bearer handover or a connection handover: the handover procedure is always started by the CTA.

If the intra-cell bearer handover procedure is supported at both side it shall be used otherwise the connection handover procedure shall be used.

The MAC layer in the FT receives a MAC_MOD-req primitive for switching the connection characteristics from:

- a basic connection, identified by an MCEI, to an advanced connection, identified by the pair: MCEI and ECN;
- full slot to double slot;
- I_N minimum delay to I_N normal delay.

This initiates a switching process.

The FT starts to transmit in the next even numbered frame the attributes_T_request (basic connection control set). This is repeated in five successive even numbered frames or until the FT receives the attributes_T_confirm (basic connection control set).

The FT shall acknowledge the receipt of the attributes_T_confirm message by the transmission of an other message in the next TDMA frame and after that shall start the T218 timer and waits for the handover procedure started by the CTA: the handover procedure shall be completed within the T218 timer otherwise the FT shall release the connection and the DLC layer is informed using the MAC_DIS-ind primitive.

If the attributes_T_confirm is not received than the FT shall release the connection and the DLC layer is informed using the MAC_DIS-ind primitive.

The CTA after receiving the attributes_T_request message from the FT, shall send the attributes_T_confirm to the FT and shall wait until the next odd frame occurs: if in the next odd frame the attributes_T_request message is received from the FT (repetition) the CTA shall retransmit the attributes_T_confirm otherwise, if an other message is received, the CTA shall start the handover procedure.

If the handover procedure fails, the connection is released and the DLC is informed using the MAC_DIS-ind primitive.

The MAC at both sides, after the handover procedure has been performed successfully, sends to the DLC the MAC_MOD primitive, confirm or indication indicating that the old connection identified by the MCEI has changed its service profile as requested and is now identified by the pair old MCEI and new ECN and that the procedure has been successfully completed. The DLC can now perform the switching of the U-plane channel. The DLC at both sides indicates to the LLME that the procedure has been correctly done: the LLME reports this indication to the NWK layer.

Message flow:

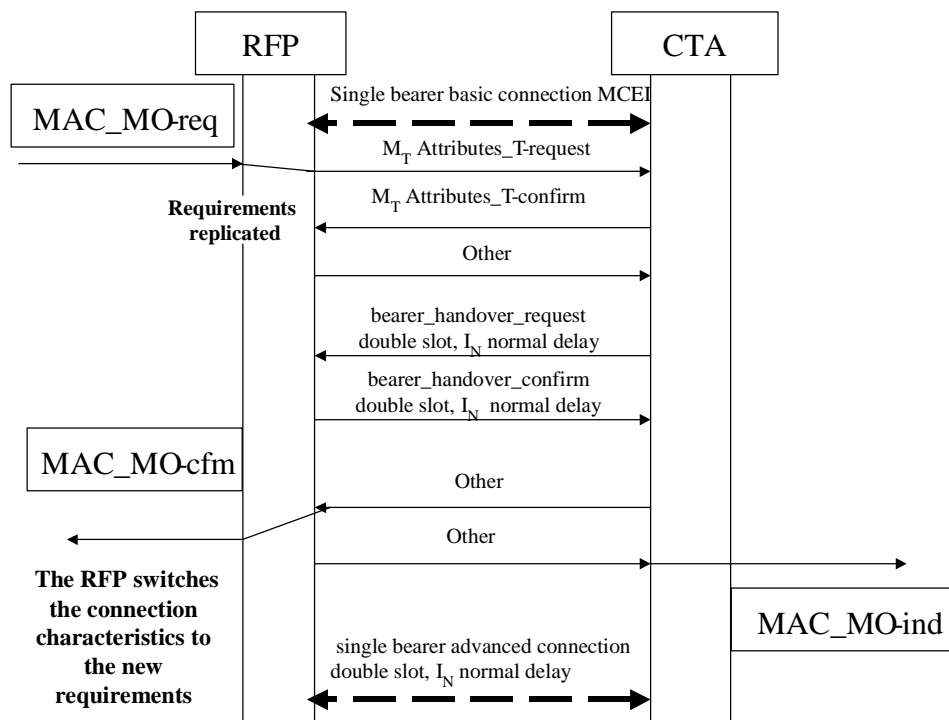

Figure 6: 32 kbit/s to 64 kbit/s switch, CTA initiated

Table 37: Values used within the {CC-INFO} message

Information element	Field within the information element	Standard values within the field/IE	Normative action/comment
<<IWU-to-IWU>>			
	<Protocol Discriminator>	15 H	RAP indication
	<IWU-to-IWU information>	See annex D	switch to 64 kbit/s bearer service request/reject

Switching collision: a switching collision occurs when both sides detect the modem tone and starts the switching sending the "switch to 64 kbit/s bearer service request". In this case the switching FT initiated takes priority. If the FT, after having sent the "switch to 64 kbit/s bearer service request" receives from the CTA the "switch to 64 kbit/s bearer service request" it shall ignore it. If the CTA, after having sent the "switch to 64 kbit/s bearer service request" receives from the FT the "switch to 64 kbit/s bearer service request" it shall process it and discharge its one.

9.4.9 Line parked

If the Local Exchange wants to park a line after a specified period without because there is no an end to end connection between from a Terminal Equipment on the CTA and to another subscriber, it uses the line parked feature.

The FT after receiving the line parked request from the Local Exchange, shall send "line parked" which shall be included in the <<IWU-TO-IWU>> information element using Protocol Discriminator "RAP" and release the call to the CTA using the normal link release procedures.

Table 38: Values used within the {CC-INFO} message

Information element	Field within the information element	Standard values within the field/IE	Normative action/comment
<<IWU-to-IWU>>			
	<Protocol Discriminator>	15 H	RAP indication
	<IWU-to-IWU information>	See annex D	Line parked

9.4.10 Switching from 64 kbit/s to 32 kbit/s bearer service FT initiated

This procedure is included here without defining the event which may trigger the procedure - it is left to the FP or CTA implementation which is the triggering event.

This service is required to switch, during a call (i.e. ACTIVE state), from a 64 kbit/s LU7 bearer service, advanced connection LCNx, double slot, I_N normal delay, to a 32 kbit/s LU1 bearer service, advanced connection LCNx, full slot, I_N minimum delay.

The FT after receiving the switching request, starts the switching LU7 to LU1 procedure which is managed by the NWK, DLC and MAC layers with the co-ordination of the LLME entity.

Procedure description:

The IWU in the FT, after detecting the switching LU7 to LU1 request, sends the MNCC_INFO-req primitive to the NWK layer starting the switching procedure.

The NWK in the FT shall send the "switch to 32 kbit/s bearer service request" which shall be included in the <<IWU-TO-IWU>> information element using Protocol Discriminator "RAP" which can be sent with every CC-message or MM-message which is allowed to carry the <<IWU-TO-IWU>> information element on the established call.

The NWK layer in the CTA after receiving the "switch to 32 kbit/s bearer service request" request, informs the LLME of the request. If the request is accepted the LLME starts the switching procedure at the DLC and MAC layer.

If the request is rejected the CTA shall send "switch to 32 kbit/s bearer service reject" which shall be included in the <<IWU-TO-IWU>> information element using Protocol Discriminator "RAP" which can be sent with every CC-message or MM-message which is allowed to carry the <<IWU-TO-IWU>> information element on the established call.

The DLC and MAC layer procedure is started at the CTA side.

The CTA starts to transmit in the next even numbered frame the attributes_T_request (advanced connection control set). This is repeated in five successive even numbered frames or until the CTA receives the attributes_T_confirm (advanced connection control set): the slot is still a double.

The CTA shall acknowledge the receipt of the `attributes_T_confirm` message by the transmission of an other message in the next TDMA frame. The MAC layer then switches from double to full slot releasing the second part of the double slot and sends to its DLC the `MAC_MOD-cfm` primitive with the "result" parameter sets to accept and the "slot type" parameter sets to full.

If the `attributes_T_confirm` is not received than the CTA shall release the connection and the DLC layer is informed using the `MAC_DIS-ind` primitive.

The FT after receiving the `attributes_T_request` message from the CTA, shall transmit the `attributes_T_confirm` message: the slot type is still double. Every time the `attributes_T_request` is received from the CTA (repeated) the `attributes_T_confirm` shall be retransmitted to the CTA.

The FT after receiving the other message switches to a full slot releasing the second part of the double slot and sends to the DLC the `MAC_MOD-ind` with the "result" parameter sets to accept and the "slot type" parameter sets to full.

At both DLC layers, the receipt of this primitive (`MAC_MOD-cfm` or `ind`) acts as a synchronization signal for the U-Plane switching procedure. Then, the DLC in both CTA and FT shall switch correctly the C-Plane link and U-plane service and release the old link. The DLC at both sides indicates to the LLME that the procedure has been correctly done: the LLME reports this indication to the NWK layer.

Message flow:

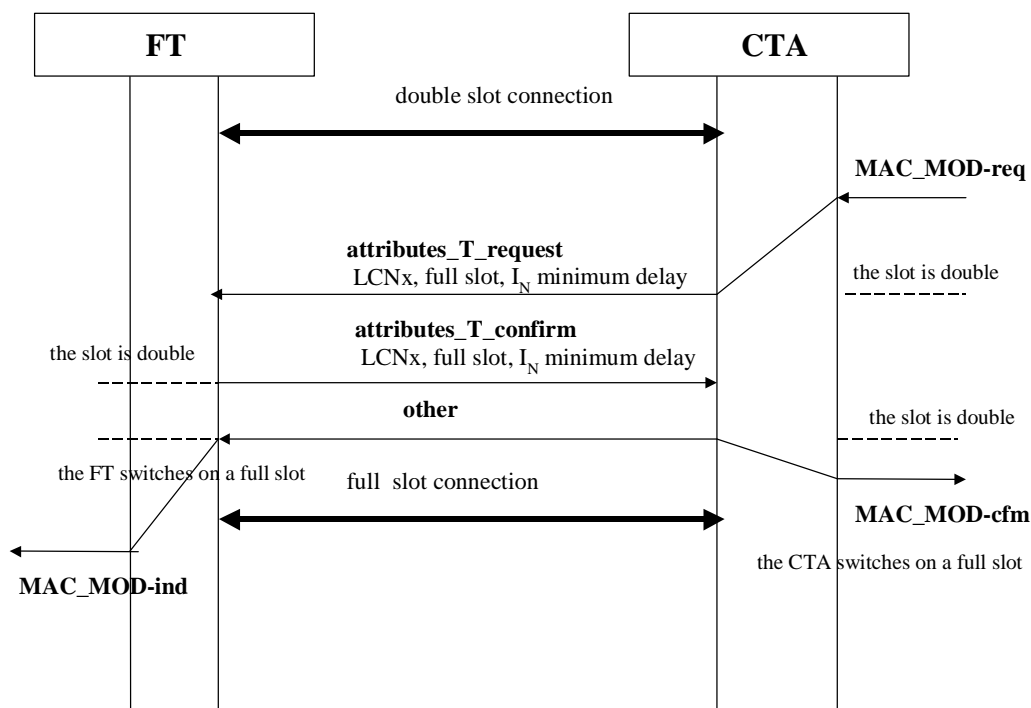

Figure 7: 64 kbit/s to 32 kbit/s switch, FT initiated

Table 39: Values used within the {CC-INFO} message

Information element	Field within the information element	Standard values within the field/IE	Normative action/comment
<<IWU-to-IWU>>			
	<Protocol Discriminator>	15 H	RAP indication
	<IWU-to-IWU information>	See annex D	switch to 32 kbit/s bearer service request/reject

Switching collision: a switching collision occurs when both sides detect the triggering event and starts the switching sending the "switch to 32 kbit/s bearer service request". In this case the switching FT initiated takes priority. If the FT, after having sent the "switch to 32 kbit/s bearer service request" receives from the CTA the "switch to 32 kbit/s bearer service request" it shall ignore it. If the CTA, after having sent the "switch to 32 kbit/s bearer service request" receives from the FT the "switch to 32 kbit/s bearer service request" it shall process it and discharge its one.

9.4.11 Switching from 64 kbit/s to 32 kbit/s bearer service CTA initiated

This procedure is included here without defining the event which may trigger the procedure - it is left to the FP or CTA implementation which is the triggering event.

This service is required to switch, during a call (i.e. ACTIVE state), from a 64 kbit/s LU7 bearer service, advanced connection LCNx, double slot, I_N normal delay, to a 32 kbit/s LU1 bearer service, advanced connection LCNx, full slot, I_N minimum delay.

The CTA after receiving the switching request, starts the switching LU7 to LU1 procedure which is managed by the NWK, DLC and MAC layers with the co-ordination of the LLME entity.

Procedure description:

The IWU in the CTA, after detecting the switching LU7 to LU1 request, sends the MNCC_INFO-req primitive to the NWK layer starting the switching procedure.

The NWK in the CTA shall send the "switch to 32 kbit/s bearer service request" which shall be included in the <<IWU-TO-IWU>> information element using Protocol Discriminator "RAP" which can be sent with every CC-message or MM-message which is allowed to carry the <<IWU-TO-IWU>> information element on the established call.

The NWK layer in the FT after receiving the "switch to 32 kbit/s bearer service request" request, informs the LLME of the request. If the request is accepted the LLME starts the switching procedure at the DLC and MAC layer.

If the request is rejected the FT shall send "switch to 32 kbit/s bearer service reject" which shall be included in the <<IWU-TO-IWU>> information element using Protocol Discriminator "RAP" which can be sent with every CC-message or MM-message which is allowed to carry the <<IWU-TO-IWU>> information element on the established call.

The DLC and MAC layer procedure is started at the FT side.

The FT starts to transmit in the next even numbered frame the attributes_T_request (advanced connection control set). This is repeated in five successive even numbered frames or until the FT receives the attributes_T_confirm (advanced connection control set): the slot is still a double.

The FT shall acknowledge the receipt of the attributes_T_confirm message by the transmission of an other message in the next TDMA frame. The MAC layer then switches from double to full slot releasing the second part of the double slot and sends to its DLC the MAC_MOD-cfm primitive with the "result" parameter sets to accept and the "slot type" parameter sets to full.

If the attributes_T_confirm is not received than the FT shall release the connection and the DLC layer is informed using the MAC_DIS-ind primitive.

The CTA after receiving the attributes_T_request message from the FT, shall transmit the attributes_T_confirm message: the slot type is still double. Every time the attributes_T_request is received from the FT (repeated) the attributes_T_confirm shall be retransmitted to the FT.

The CTA after receiving the other message switches to a full slot releasing the second part of the double slot and sends to the DLC the MAC_MOD-ind with the "result" parameter sets to accept and the "slot type" parameter sets to full.

At both DLC layers, the receipt of this primitive (MAC_MOD-cfm or ind) acts as a synchronization signal for the U-Plane switching procedure. Then, the DLC in both CTA and FT shall switch correctly the C-Plane link and U-plane service and release the old link. The DLC at both sides indicates to the LLME that the procedure has been correctly done: the LLME reports this indication to the NWK layer.

Message flow:

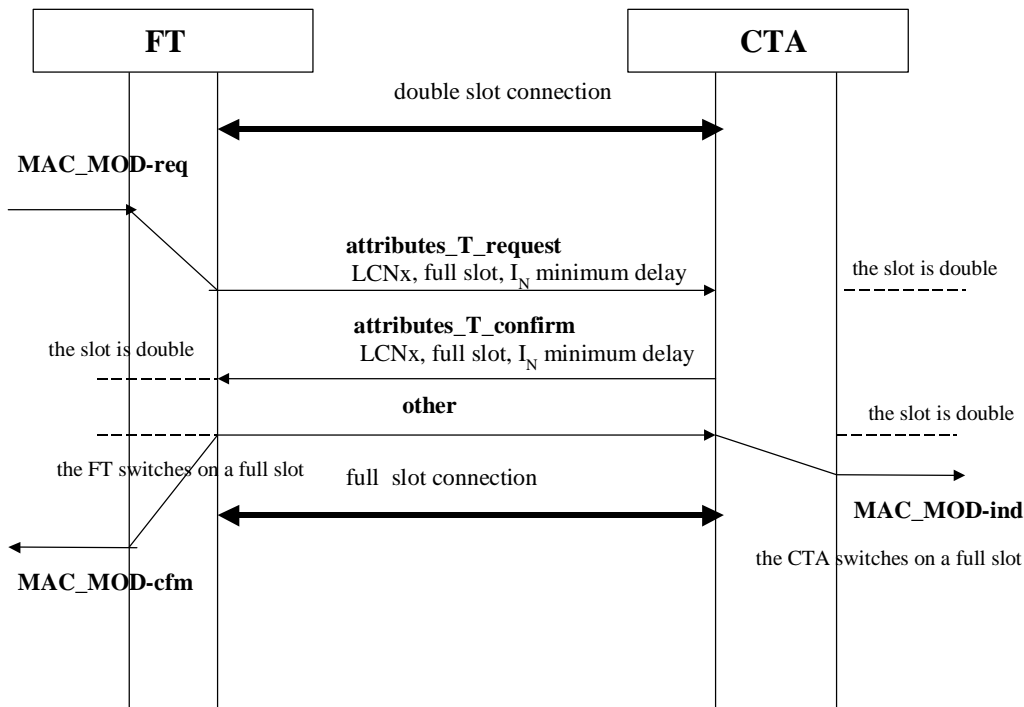

Figure 8: 64 kbit/s to 32 kbit/s switch, CTA initiated

Table 40: Values used within the {CC-INFO} message

Information element	Field within the information element	Standard values within the field/IE	Normative action/comment
<<IWU-to-IWU>>			
	<Protocol Discriminator>	15 H	RAP indication
	<IWU-to-IWU information>	See annex D	switch to 32 kbit/s bearer service request/reject

Switching collision: a switching collision occurs when both sides detect the triggering event and starts the switching sending the "switch to 32 kbit/s bearer service request". In this case the switching FT initiated takes priority. If the FT, after having sent the "switch to 32 kbit/s bearer service request" receives from the CTA the "switch to 32 kbit/s bearer service request" it shall ignore it. If the CTA, after having sent the "switch to 32 kbit/s bearer service request" receives from the FT the "switch to 32 kbit/s bearer service request" it shall process it and discharge its one.

9.5 Analogue leased line establishment

The analogue leased line service can be provided only for one of the following services:

- 1) 32 kbit/s speech service (echo devices on);
- 2) 32 kbit/s data service (echo devices off);
- 3) 64 kbit/s LU7 data service (echo devices off).

The operator shall select one of the previous services for each analogue leased line on subscription base and is not possible to switch between these services during the active state of the leased line.

An analogue leased line is established as a normal speech call using the outgoing call GAP features 1 (see clause 7.2): the call is maintained all the time providing the normal analogue leased line service. The connection established to provide the type 1 and 2 service leased line is a full slot 32 kbit/s with the LU1 DLC service.

The connection established to provide the type 3 service leased line is a double slot 64 kbit/s with the LU7 DLC service.

For the leased line services type 2 and 3 the echo control devices shall be disabled at both sides FT and CTA.

NOTE 1: It could also be possible to provide a leased line service of type 4: LU8 64 kbit/s speech service. The description of the LU8 service is provided in the informative annex F.

NOTE 2: If only linear echo control processing is provided it may be possible to use the 32 kbit/s speech (leased line type 1) and 64 kbit/s LU8 speech (leased line type 4) speech leased line services also for data services.

NOTE 3: Operators might wish to provide a more spectrum efficient and lower cost virtual leased line service where the user activates the radio bearer only when the leased line is used.

10 DLC layer procedures

10.1 General

10.2 Reference to GAP

The complete clause 9 of EN 300 444 [10] GAP is part of the description of the DLC-Layer Procedures for the RAP Profile.

10.3 LU7 64 kbit/s data bearer service

When the LU7 data bearer service is supported, the complete clause E.4 of the EN 300 175-4 [4] is part of the description of the DLC-Layer Procedures for the RAP Profile.

11 MAC layer procedures

11.1 Reference to GAP

The complete clause 10 of EN 300 444 [10] GAP is part of the description of the MAC-Layer Procedures for the RAP Profile.

11.2 Advance timing

If the FT wants to align the PT transmission to the FT frame timing of a link by requesting the PT to compensate for the propagation delay in the active bearers with an FT, it shall send the MAC quality control message "advance timing request" (A field or B field; refer to EN 300 175-3 [3], clause 7.2.5.5).

The FT should send an advance timing message request as soon as it has a reliable measurement of the PT transmit timing.

It is recommended that the FT sends the advance timing request message only if the FT detects a PT timing difference from the nominal one greater than $(2 + 2 \cdot 868) \mu\text{s}$ (EN 300 175-3 [3]), i.e. if the FT receives the PT transmission outside the nominal FT receive window. It is recommended that the FT chooses the number of compensate bits in the advanced timing request message such that FT will finally receive the PT transmission in the FT receive window.

To guarantee a stable control loop, the FT shall not be allowed to use timing measurements older than 10 frames, at the transmission of the advance timing request message. Within a 10 frame time interval, the advance timing request message can be retransmitted; until an acknowledged reception of the frame (Q-bit setting) has been received. In this time interval the PT is required to interpret only one of the received advance timing request messages. After receiving an acknowledged reception of the frame (Q-bit setting) upon transmission of the advanced timing request message, the FT shall not send any advance timing request message during the next 10 s. If the FT receives an advance timing reject message from a PT, it shall not send any more advance timing request messages to that specific PT.

NOTE 1: Retransmissions of the advance timing request message are allowed if the PT indicates a bad reception of the message (through Q bit setting).

NOTE 2: The 10s timer is required to save signalling capacity and to allow PTs to alter the length of successive frames by up to 2 bits if they are not able to adjust the length of a single frame by the amount indicated in the advanced timing request message, (EN 300 175-2 [2], clause 4.2.7).

At the reception of the advance timing message, the PT can correct consequently its reference timer or send back to the FT an advance timing reject message, if the requested action is not supported. If advance timing is supported, the PT should update the transmit timing on the first occasion after the reception of the advance timing request message.

NOTE 3: In case the advance timing messages and procedure are not contemplated, the PT is expected to do nothing.

The advance timing increment and decrement parameters in the advance timing request message shall be interpreted as follows:

- a positive value shall result in an earlier transmission of the PT and a negative value shall result in a later transmission of the PT.

11.3 LU7 64 kbit/s data bearer service

When the LU7 data bearer service is supported, the complete clause 11.9 of the EN 300 175-4 [4] applies. The LU7 data bearer service shall be controlled by using B-field MAC messages.

11.4 Downlink broadcast, Extended Fixed Part Capabilities

The FT shall be capable to send and the PT shall be capable to receive and process the QT message as defined in clause 7.2.3.5 of EN 300 175-3 [3].

Table 41: Values used within Extended FP capabilities

MAC message	Field within the message	Standard values within the MAC message	Normative action/comment
<<Extended FP capabilities>>			
	<a36>	1	RAP 1 Profile

11.5 Blind slot information

It is mandatory for RFP's that have blind slots, due to non-duplex bearer operation on that slot (i.e. those RFP's that have technological limitations such as a slow synthesizer), to periodically announce these blind slots (at least every 10 s). In the event the RFP announces blind slot information, such information may also include all blind slots due to an active bearer as well.

Not available (blind) slot means that the FP recommends the CTA not to attempt a set-up on this slot.

If the CTA receives blind slot information, it is mandatory for that CTA to use it in the process of channel selection. The CTA does not have to wait for the blind slot information before making the channel selection.

11.6 Improved channel selection rules

In addition of using the blind slot information before making the channel selection as defined in clause 6.4.3, it is recommended for the CTA to follow the algorithm defined below for single slot channel selection.

Without violating the basic DECT channel selection rules, for single slot channel selection the PP should give priority to the following types of channels:

Available channel candidates on even slot positions with an active channel on the adjacent slot position to the right;

Available channel candidates on odd slot positions with an active channel on the adjacent slot position to the left.

NOTE 1: This algorithm results in packing of single slots into double slot locations (double slots are only allowed to start on even slot positions).

NOTE 2: The DECT channel rules shall not be violated. This implies that the rules described above can only be applied to the channels that are within the same RSSI band.

12 Physical layer requirements

12.1 General

12.2 Reference to GAP

The complete clause 11 of EN 300 444 [10] GAP is part of the description of the PHL-Layer Procedures for the RAP Profile.

12.3 LU7 64 kbit/s data bearer service

When the LU7 data bearer service is supported, the complete clause E.2 of EN 300 175-4 [4] is part of the description of the Physical-Layer Procedures for the RAP Profile.

13 Requirements regarding the speech transmission

13.1 General

The applicable requirements specified in EN 300 175-8 [8] and EN 300 176 [9] shall be applied for the FP. The encoding requirements of EN 300 175-8 [8] clause 5.1 shall apply for the CTA. Furthermore, the CTA shall conform to applicable requirements of national regulations. If a national requirement conflicts with the requirements of the present document, the requirements of the present document shall have precedence.

13.2 Echo control requirements for CTAs intended for 2-wire connections

The echo from the 4- to 2-wire hybrid of the CTA towards the network shall be controlled by inserting an echo loss into the CTA. The weighted echo loss, LE, shall be >34 dB referred to the uniform PCM reference point of the CTA. This requirement shall be met for the whole range of 2-wire cable equivalents and termination impedances Z (see EN 300 176 [9], clause 7.30.2.2.1, NOTE 2) specified by the national authority. The required echo loss shall be met for any echo with a maximum delay of at least 0 ms to 4 ms.

A 2-wire connection to a CTA may be direct and/or indirect, for example via a PABX. Echoes from indirect 2-wire connections shall also meet the 34 dB LE requirement. This may require a control range beyond 4 ms. The manufacturer shall declare the control range of the echo control device.

NOTE 1: General information on requirements for local loop applications are found in annex B of EN 300 175-8 [8].

NOTE 2: The means how to achieve the echo loss is not specified. It is recommended to use a simple echo canceller (see EN 300 175-8 [8], clause A.2.2) in the implementation of the echo control function of the CTA.

13.3 Disabling the echo control functions

13.3.1 General

A CTA may be tested for LE >46 dB. Compare with the two options on terminal coupling loss for PPs (EN 300 175-8 [8] clause 7.4.1). If the >46 dB requirement is met, it is allowed to disable the artificial echo loss or echo control device (EN 300 175-8 [8] clause 7.4.1.2) in the FP. This information can be included in the subscription procedure.

13.3.2 Modem services

The echo control functions shall be disabled at both the CTA and the FP upon detection of a 2,1 kHz modem answering tone. ITU-T Recommendations V.25 [16], G.164 [17] and G.165 [18] define the requirements for modem answering tone including timing requirements. The tone can be without or with phase reversals, indicating if only echo suppressors or also echo cancellers shall be disabled. In this application all echo control functions shall be disabled no matter if the tone contains phase reversals or not.

14 Requirements regarding fax and data transmission

14.1 General

Generally the RLL transport will be transparent to modem and fax services up to a certain rate. The maximum rate is limited to 9,6 kbit/s for the standard 32 kbit/s ADPCM full slot duplex channel. The optional feature **N.116**, 64 kbit/s PCM bearer service using the double slot LU7 service, supports rates up to 28,8 kbit/s.

NOTE: It has been experienced that some equipment using the 32 kb/s ADPCM channel, agree during the negotiation phase on a transfer rate, that is higher than the rate that gives the highest throughput. A manual setting of a limit for the maximum rate would help.

14.2 Requirements

14.2.1 Implementation of the LU7 PCM services.

If feature **N.116**, table 1, is supported, the LU7 service shall be implemented in the CTA, FP and WRS, as defined in EN 300 175-4 [4], annex E.

NOTE: For the WRS, only Physical and MAC layer requirements as defined in EN 300 175-4 [4], annex E are applicable.

15 Management procedures

The complete clause 13 of EN 300 444 [10] GAP is part of the description of the management procedures for the RAP Profile.

16 Interworking with WRS applications

16.1 General

FP support of Wireless Relay Stations is optional. ETR 308 [15] describes different applications of WRS. The WRS is an important component to provide cost effective infra structures. If both RAP and GAP are supported by the FP and the WRS, the WRS may provide GAP mobility options including combined CTA and GAP residential service with intercom functions. WRS applications and features are also described in ETR 246 [14].

16.2 Requirements

WRS shall support RAP and GAP. This implies that the WRS shall conform to applicable GAP requirements. In addition WRSs shall support the implementation of RAP features as indicated in annex G. The relevant codings are indicated in annex D. For the related procedures, see clause 16.3.

NOTE: The procedures differ from those for the CTA in order not to mandate a NWK CC and DLC inside the WRS.

16.3 WRS maintenance calls

16.3.1 Incoming WRS maintenance call

For incoming maintenance calls the FT shall use <<IWU-TO-IWU>> as defined in annex D, included in the {MM-INFO-SUGGEST} message, using the procedures as defined in EN 300 175-5 [5], clause 13.7.

NOTE: A special value for the <<INFO-TYPE>> shall be used, indicating "OA&M call".

16.3.2 Outgoing WRS maintenance call

For outgoing maintenance calls the WRS shall use <<IWU-TO-IWU>> as defined in annex D, included in the {MM-INFO-REQUEST} message, using the procedures as defined in EN 300 175-5 [5], clause 13.7. The FT shall respond according to these procedures with a {MM-INFO-ACCEPT}, which may include a <<IWU-TO-IWU>> as defined in annex D.

NOTE: A special value for the <<INFO-TYPE>> shall be used, indicating "OA&M call".

16.3.3 Maintenance during WRS MM operation

If the FT or the WRS need to transfer OA&M information, and there is an MM procedure ongoing, the FT or WRS may add the <<IWU-TO-IWU>> information element containing the OA&M information as defined in annex D, to the MM-messages part of the ongoing MM procedure, if it is allowed by the coding of the relevant MM-message, as given in EN 300 175-5 [5]. Otherwise, the FT or WRS shall wait until the ongoing MM procedure is completed, and initiate an incoming or outgoing maintenance call.

17 Application procedures

17.1 General

17.2 Reference to GAP

The following clauses of EN 300 444 [10] GAP is part of the description of the Application Procedures for the RAP Profile: 14.1 and 14.2.

17.3 Manual entry of the PARK and AC to CTA's

A procedure similar to that of GAP, EN 300 444 [10], clauses 14.3 and 14.2 is proposed.

These number shall be entered via a pulse dialling telephone set if the CTA is not equipped with an optional DTMF receiver; otherwise any dialling mode is possible.

At first power on, the CTA is in the state "ready for subscription" (see also EN 300 444 [10], annex A, figure A.1: PP "subscription mode" for MAC layer). The codes are input via the POTS telephone. The restriction exists that via POTS only decimal digits in the range 0 to 9 can be entered - thus excluding '*' or '#' since these are not mandatory for pulse dialling phone sets.

17.3.1 Entering the PARK

The following sequence is proposed:

!!LLPP...PC#

where:

- !! is an activation sequence which shall be '11'.
- LL two-digit decimal number being the length of the PARK (i.e. the PARK Length Indicator, PLI) in bits (within 00..36)
- PPP..P up to 12 octal digits - this is the PARK itself.
- C checksum based on LL and PP..P as specified in GAP, ch. 14.3. It is the sum of each digit multiplied by its position in the string, modulo 11. If the result of the modulo operation should be "10", this is replaced by 0 (since "*" as in EN 300 444 [10], 14.3 is not available).
- # stop sign - it shall be '9'.

EXAMPLE:

PARK = 101 110 010 001 1 (i.e. 13 bits, PARK length LL = 13)

This is padded by two '0' at the end to yield a number of bits which is a multiple of 3:

PARK* = 101 110 010 001 100 = 5 6 2 1 4 (Octal) = P P P P P

Hence L L P P P P P = 13 56214

$C = (1*1 + 2*3 + 3*5 + 4*6 + 5*2 + 6*1 + 7*4) \bmod 11 = (1+6+15+24+10+6+28) \bmod 11 = 90 \bmod 11 = 90 - 88 = 2$

Thus the input key sequence is:

!	!	L	L	P	P	P	P	P	C	#
1	1	1	3	5	6	2	1	4	2	9

17.3.2 Entering the AC

The AC shall always have a length of 32 bits. The user may enter between 0 and 8 digits. Each decimal digit is translated into one semi-octet in the range '0000' to '1001'.

The resulting string of semi-octets is padded with a number of leading all-one semi-octets ('1111') to achieve a total of 8 semi-octets.

EXAMPLE 1:

Entering the digits 0 1 3 results in an AC of:

"1111 1111 1111 1111 1111 0000 0001 0011"

Extension for CTA: AC-Checksum:

The CTA shall be able to detect "syntax errors" in the entered digit sequence. To this end, a checksum is calculated from the digits entered.

Let A...A be the digits representing the AC;

C = checksum of A...A;

then A...AC would have to be entered

EXAMPLE 2:

For A...A = 0 1 3 the checksum is $(1*0 + 2*1 + 3*3) \text{ mod } 11 = 11 \text{ mod } 11 = C = 0$

Hence A...AC = 0 1 3 0

The entire input sequence for PARK and AC is given by: !!LLPPPPPC#A...AC

EXAMPLE 3:

<OFF-HOOK> 11 13 56214 2 9 013 0 <ON-HOOK> has to be entered for the above examples.

After entering the digits, the Subscription Registration procedure is started by the ON-HOOK event.

If the procedure is successful, subsequent call processing is possible.

If the subscription registration procedure fails, the CTA adopts the initial state where another subscription registration procedure is possible based on newly entered AC and PARK data.

Annex A (informative): PP locking procedure for on air subscription

See annex A of EN 300 444 [10] GAP.

Annex B (informative): Tones, progress indicator and U-plane connection

See annex B of EN 300 444 [10] GAP.

Annex C (informative):
Void

Annex D (normative): Codings for "OA&M" and "RAP-CC" messages

The FT and the CTA shall be capable of exchanging RAP-OA&M and RAP-CC information which shall be included in the <<IWU-TO-IWU>> information element using Protocol Discriminator "RAP" which can be sent with every CC-message or MM-message which is allowed to carry the <<IWU-TO-IWU>> information element on an established call. If the case no call is established, the CTA can set-up an outgoing maintenance call, and the FT can set-up an incoming maintenance call to transmit the OA&M message.

Table D.1

Information element	Field within the information element	Standard values within the field/IE	Normative action/comment
<<IWU-to-IWU>>			
	<Protocol Discriminator>	15 H	RAP indication
	<IWU-to-IWU information>		Codings for RAP-OA&M and RAP-CC

D.1 General Structure for RAP <<IWU-to-IWU>> Information Element

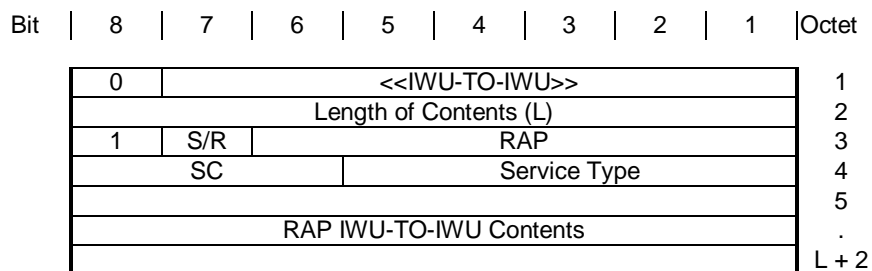

Service Category (SC)

Bits	8	7	6	Meaning
	0	0	1	RAP-CC
	0	1	0	RAP-OA&M
	All other values reserved			

Service Type:

If SC indicates RAP-CC

Bits	5	4	3	2	1	Meaning
	0	0	0	0	0	Reserved
	0	0	0	0	1	On hook
	0	0	0	1	0	Off hook
	0	0	0	1	1	Coin collection
	0	0	1	0	0	Line polarity reversal
	0	0	1	0	1	Switch to 64 kbit/s bearer service
	0	0	1	1	0	Switch to 32 kbit/s bearer service
	0	0	1	1	1	Line parked
	0	1	0	0	0	Modern tone detection
	0	1	0	0	1	Metering pulse indication
	0	1	0	1	0	Pulse notification
	0	1	0	1	1	On-hook ack
	0	1	1	0	0	Off-hook ack
	Reserved					

if SC indicates RAP/OA&M

Bits	5	4	3	2	1	Meaning
	0	0	0	0	0	Claim enable
	0	0	0	0	1	Claim disable
	0	0	0	1	0	Claim active
	0	0	0	1	1	Physical resource fault
	0	0	1	0	0	Remote test activation/information
	0	0	1	0	1	Alarm
	0	0	1	1	0	Resynchronization request
	0	0	1	1	1	Remote configuration
	0	1	0	0	0	Remote configuration information
	0	1	0	0	1	Advanced file transfer
	0	1	0	1	0	Subscription suggest
	0	1	0	1	1	Claim Inactive
	1	1	1	1	1	Escape
						Reserved

D.2 RAP IWU-TO-IWU Contents Proprietary

D.2.1 RAP-OA&M Service type coding

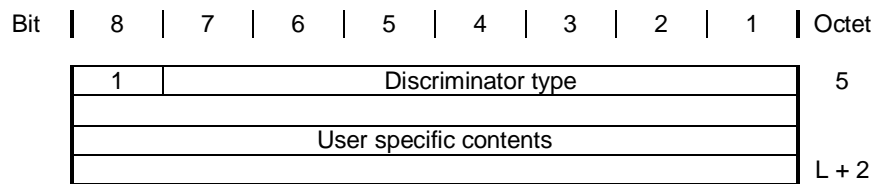

Discriminator type (octet 5):

Bits	7	6	5	4	3	2	1	Meaning
	0	0	0	0	0	0	0	Unspecified
	0	0	0	0	0	0	1	EMC

All other values reserved

User specific contents field (octets 6 to L + 2) for Discriminator type "EMC"

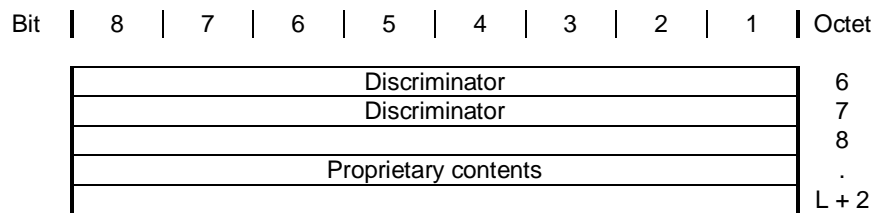

The discriminator consists of 2 octets (octets 6 and 7) and contains the EMC.

This proprietary structure of the RAP IWU-TO-IWU contents can be used only for RAP-OA&M Service Type commands except for the ones listed below:

- Claim enable;
- Claim disable;
- Claim active;

- Claim inactive;
- Resynchronization request.

For these commands and for all the RAP-CC Service Type commands, only the standardized structure (see clause D.3) can be used.

D.3 RAP IWU-TO-IWU Contents Standardized

D.3.1 RAP-CC Service type coding

Coin collection

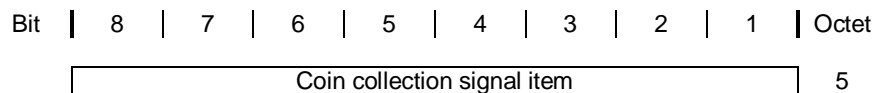

Bits	8	7	6	5	4	3	2	1	Meaning
	0	X	X	X	X	X	X	1/0	Coin absent/present
	0	X	X	X	X	X	1/0	X	High denomination coin/Low denomination coin
	All other values								Reserved
									X: do not care

Switch to 64 kbit/s bearer service

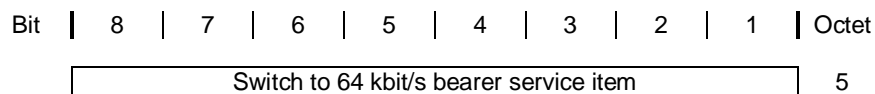

Bits	8	7	6	5	4	3	2	1	Meaning
	0	X	X	X	X	X	X	1/0	Switch to 64 kbit/s bearer service request/reject
	All other values								Reserved
									X: do not care

Switch to 32 kbit/s bearer service

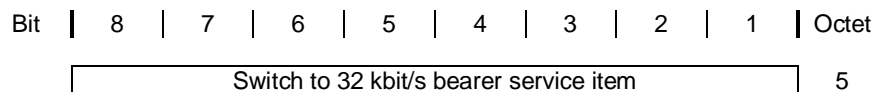

Bits	8	7	6	5	4	3	2	1	Meaning
	0	X	X	X	X	X	X	1/0	Switch to 32 kbit/s bearer service request/reject
	All other values								Reserved
									X: do not care

Metering pulse indication

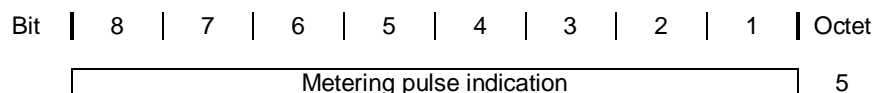

Bits	8	7	6	5	4	3	2	1	Meaning	
	0								nr of pulses	indicating 0 - 127 metering pulses
	All other values								Reserved	

D.3.2 RAP-OA&M Service type coding

Physical resource fault

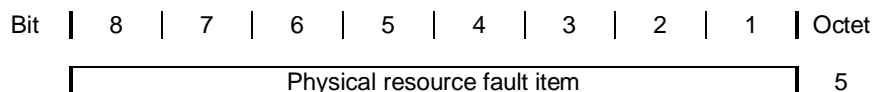

Bits	8	7	6	5	4	3	2	1	Meaning
	0	X	X	X	X	X	X	1/0	Antenna fault present/absent
	0	X	X	X	X	X	1/0	X	RF unit plus logic fault present/absent
	0	X	X	X	X	1/0	X	X	Line interface unit fault present/absent
	0	X	X	X	1/0	X	X	X	Power supply unit fault present/absent
	0	X	X	1/0	X	X	X	X	Backup battery fault present/absent
	0	X	1/0	X	X	X	X	X	Network terminating unit fault present/absent
	0	1/0	X	X	X	X	X	X	General unit fault present/absent

X: do not care

Remote test activation

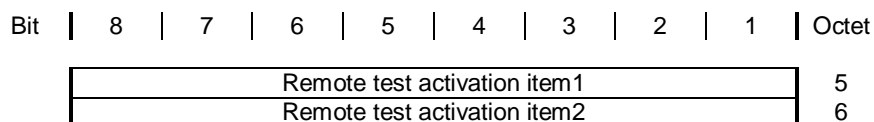

Remote test activation item1:

Bits	8	7	6	5	4	3	2	1	Meaning
	0	X	X	X	X	X	X	1/0	Detect network terminating unit test activated/deactivated
	0	X	X	X	X	X	1/0	X	Detect presence of telephone test activated/deactivated
	0	X	X	X	X	1/0	X	X	Check for leakage to earth test activated/deactivated
	0	X	X	X	1/0	X	X	X	Detect hazardous voltage test activated/deactivated
	0	X	X	1/0	X	X	X	X	Detect mains power at CTA test activated/deactivated
	0	X	1/0	X	X	X	X	X	Check for dial tone from exchange at CTA test activated/deactivated
	0	1/0	X	X	X	X	X	X	Link Quality test activated/deactivated

X: do not care

Remote test activation item2:

Bits	8	7	6	5	4	3	2	1	Meaning
	X	X	X	X	X	X	X	1/0	Ring/Ring trip test activated/deactivated
	X	X	X	X	X	X	1/0	X	Dialled digit test activated/deactivated
	X	X	X	X	X	1/0	X	X	Deliver number of failed remote call attempts made by CTA
	X	X	X	X	1/0	X	X	X	RSSI test activated/deactivated
	X	X	X	X	1/0	X	X	X	A-CRC test
	X	X	X	1/0	X	X	X	X	Frame error test
	X	X	1/0	X	X	X	X	X	Reserved
	X	1/0	X	X	X	X	X	X	Reserved

X: do not care

Remote test information

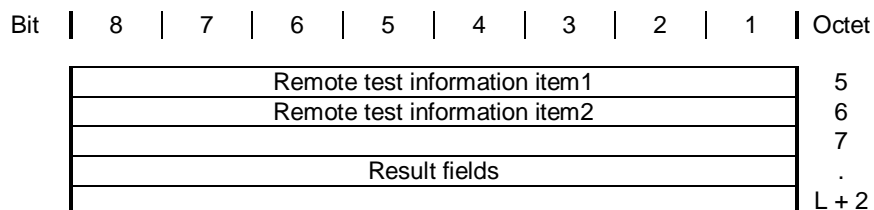

Remote test information item1:

Bits	8	7	6	5	4	3	2	1	Meaning
	0	0	0	0	0	0	0	1	Results on test Detect network terminating unit
	0	0	0	0	0	0	1	0	Results on test Detect presence of telephone
	0	0	0	0	0	1	0	0	Results on test Check for leakage to earth
	0	0	0	0	1	0	0	0	Results on test Detect hazardous voltage
	0	0	0	1	0	0	0	0	Results on test Detect mains power at CTA
	0	0	1	0	0	0	0	0	Results on test Check for dial tone from exchange at CTA
	0	1	0	0	0	0	0	0	Results on test Link Quality

Remote test information item2:

Bits	8	7	6	5	4	3	2	1	Meaning
	0	0	0	0	0	0	0	1	Results on test Ring/Ring trip test activated/deactivated
	0	0	0	0	0	0	1	0	Results on test Dialed digit test activated/deactivated
	0	0	0	0	0	1	0	0	Delivery of number of failed remote call attempts made by CTA
	0	0	0	0	1	0	0	0	Results on test RSSI test
	0	0	0	1	0	0	0	0	Results on A-CRC test
	0	0	1	0	0	0	0	0	Results on Frame error test
	0	1	0	0	0	0	0	0	Reserved

Alarm

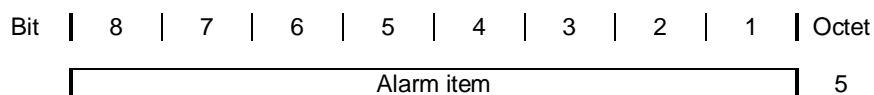

Bits	8	7	6	5	4	3	2	1	Meaning
	0	X	X	X	X	X	X	1/0	Mains failure alarm present/absent
	0	X	X	X	X	X	1/0	X	Power supply failure alarm present/absent
	0	X	X	X	X	1/0	X	X	Low battery voltage alarm present/absent
	0	X	X	X	1/0	X	X	X	Opening of CTA enclosure alarm present/absent
	0	X	X	1/0	X	X	X	X	Reserved
	0	X	1/0	X	X	X	X	X	Reserved
	0	1/0	X	X	X	X	X	X	Reserved

X: do not care

Subscription suggest

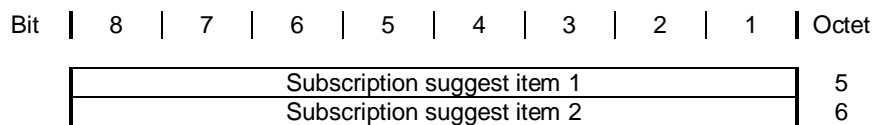

Subscription suggest item 1

Bits	8	7	6	5	4	3	2	1	Meaning
	0	X	X	X	X	X	X	X	Desired port number (0 - 7FH)

Subscription suggest item 2

Bits	8	7	6	5	4	3	2	1	Meaning
	0	0	0	0	0	0	0	0	Derive AC from UAK/AC
	0	0	0	0	0	0	0	1	Used stored AC

Annex E (informative): Description of remote tests and quality measurement

The procedures and results of the remote tests and quality measurements other than those specified elsewhere in the present document are manufacturer specific, and not described as part of the present document.

Annex F (informative): LU8 service

This annex defines the LU8 64 kbit/s speech and data service specified for the DECT radio interface.

F.1 Physical layer service

The used physical packet is the double slot (Packet P80).

F.2 MAC layer service

The duplex unprotected normal delay MAC service with the B-field multiplex U80a shall be used. A symmetric single bearer MAC connection shall be used.

F.3 DLC layer service

The Forward Error Control (FEC) defined in EN 300 175-4 [4] shall be used.

The frame format FU8 used in the LU8 service is defined in figure F.1.

2 bytes	80 bytes	10 bytes	2 bytes	6 bytes
spare bits	user data	spare bits	spare bits	RS Parity Symbol (FEC)

Figure F.1: FU8 frame structure

This framing format is directly derived from the FU7 framing format removing the ARQ bytes and maintaining the FEC bytes.

The RS (255, 249) code provided by the FEC, may be used to correct up to 3 errors within a double slot connection and uses the generator polynom defined in clause 6.1.2.

NOTE: If the error correction algorithm can not correct the errors in a double slot, the LU8 service should transmit the received user data to the IWU with a FEC error indication.

Annex G (normative): Synchronization Requirements for Fixed Parts

Public systems shall provide intrasystem cluster synchronization and shall have either GPS synchronization and a Synchronization Output Port or a complete Synchronization Port (both input and output). This will allow absolute time synchronization via GPS or wired mutual synchronization, if an operator requires local synchronization between Fixed Parts.

Table G.1

Synchronization requirements			
Item no.	Name of feature	Ref (EN 300 175-2 [2]).	Status FT (Public)
S.1	GPS multiframe time synchronization	clause B.3	O
S.2	DECT SYNC output port, Class 1	clause B.2	M
S.3	DECT SYNC input port, Class 1	clause B.2	C101

C101: IF S1 THEN O ELSE M

Annex H (normative): Management of the overlapping between decadic dialling and register recall recognition times

When the range of times for detecting a decadic digit "1" and the range of times for detecting the register recall situation present an overlapping area, the overlapping area shall correspond to digit #1.

Annex I (informative): Installation

This annex provides some guides for installation of above roof-top DECT WLL systems when high power above roof-top cellular radio base station may be expected to get a transmit band in the vicinity of the DECT frequency allocation. The EIRP of such cellular base stations can be up to 54 dBm to 57 dBm.

In Europe, the relevant potential interfere is GSM 1 800, which has its transmit band allocated somewhere within 1 805 MHz to 1 880 MHz [19]. Also in Europe the Council Directive of 3 June 1991 (91/287/EEC) requires a protection of all carriers of DECT band: "In accordance with the CEPT recommendation T/R 22-02 [19], DECT shall have priority over other services in the same band, and be protected in the designated band" (91/287/EEC, page 2, clause 2)".

I.1 Above roof-top DECT WLL systems and GSM 1 800 macro cell systems

Above roof-top DECT WLL base stations and above roof-top GSM 1 800 base stations (BTSs) should be geographically separated as much as possible. Wherever possible, the GSM BTS sites should be at the intersection of DECT WLL cells.

The DECT operator should plan to use a wanted signal level high enough ensure reasonably low interference potential from an above roof-top GSM macro cell system. In reality the interference protection of actual RFPs and CTAs for WLL exceeds the minimum blocking requirement with some amount. This reduces the demand on high wanted signal level (smaller cells).

There may be cases where separation distances between GSM 1 800 base station and DECT equipment down to 100 m have to be accepted. If the DECT WLL RFPs and CTAs have about 10 dBi antenna gain, this corresponds typically to about 20 dB improved interference protection requirement compared to the requirements of DECT blocking specification (-33 dBm interfering signal at -80dBm wanted signal level). This improvement may be achieved with a combination of:

- the amount with which actual DECT equipment that exceeds the minimum blocking requirement;
- an adequate installation margin added to the minimum operational wanted signal level for DECT;
- co-ordinated (DECT and GSM operator) site engineering and system planning, e.g. position of base stations, local change/removal of carriers, external filtering and antenna configuration.

If the GSM operator intend to have indoor BTSs and/or below roof-top BTSs, the carriers closest to the DECT band should be planned to be used for these systems and not for the above roof-top macro cell BTSs.

History

Document history		
Edition 1	August 1997	Publication as ETS 300 765-1
V1.2.1	September 2000	Publication
V1.3.0	December 2000	One-step Approval Procedure OAP 20010406: 2000-12-06 to 2001-04-06