

Draft **EN 300 761** V1.1.1 (1997-08)

European Standard (Telecommunications series)

**Electromagnetic compatibility
and Radio spectrum Matters (ERM);
Automatic Vehicle Identification (AVI) for railways**



European Telecommunications Standards Institute

Reference

DEN/ERM-RP080402 (71o00ico.PDF)
formerly DEN/RES-080402

Keywords

Radio, UIC

ETSI Secretariat

Postal address

F-06921 Sophia Antipolis Cedex - FRANCE

Office address

650 Route des Lucioles - Sophia Antipolis
Valbonne - FRANCE
Tel.: +33 4 92 94 42 00 Fax: +33 4 93 65 47 16
Siret N° 348 623 562 00017 - NAF 742 C
Association à but non lucratif enregistrée à la
Sous-Préfecture de Grasse (06) N° 7803/88

X.400

c= fr; a=atlas; p=etsi; s=secretariat

Internet

secretariat@etsi.fr
<http://www.etsi.fr>

Copyright Notification

No part may be reproduced except as authorized by written permission.
The copyright and the foregoing restriction extend to reproduction in all media.

Contents

Intellectual Property Rights.....	7
Foreword	7
Introduction	8
1 Scope.....	9
2 Normative references	9
3 Definitions, symbols and abbreviations	10
3.1 Definitions	10
3.2 Symbols	10
3.3 Abbreviations.....	10
4 General	11
4.1 Presentation of equipment for testing purposes	11
4.1.1 Choice of model for testing	11
4.1.2 Choice of operating frequencies.....	11
4.1.3 Testing of equipment without a permanent external RF port	12
4.1.4 Equipment with a permanent internal RF port.....	12
4.1.5 Equipment with a temporary RF port	12
4.2 Mechanical and electrical design	12
4.2.1 General.....	12
4.2.2 Controls.....	12
4.2.3 Test mode facility	12
4.3 Auxiliary test equipment.....	12
4.4 Interpretation of the measurement results	12
5 Test conditions, power sources and ambient temperatures.....	13
5.1 Normal and extreme test conditions.....	13
5.2 External test power source	13
5.3 Normal test conditions	13
5.3.1 Normal temperature and humidity.....	13
5.3.2 Normal test power source.....	13
5.3.2.1 Mains voltage	13
5.3.2.2 Regulated lead-acid battery power sources.....	14
5.3.2.3 Other power sources	14
5.4 Extreme test conditions.....	14
5.4.1 Extreme temperatures.....	14
5.4.1.1 Procedure for tests at extreme temperatures	14
5.4.1.1.1 Procedure for equipment designed for continuous transmit operation	14
5.4.1.1.2 Procedure for equipment designed for intermittent transmit operation	14
5.4.1.2 Extreme temperature ranges	15
5.4.2 Extreme test source voltages	15
5.4.2.1 Mains voltage	15
5.4.2.2 Lead-acid battery, regulated power sources.....	15
5.4.2.3 Power sources using other types of batteries	15
5.4.2.4 Other power sources	15
6 General conditions	16
6.1 Test signals and test modulation	16
6.1.1 Normal test signals (wanted and unwanted signals)	16
6.1.1.1 Signals for bit stream measurements.....	16
6.1.1.2 Signal for messages	16
6.2 Modes of operation of the transmitter.....	17
6.3 Encoder for receiver measurements	17
6.4 Facilities for access.....	17
6.4.1 Analogue access	17
6.4.2 Access points for data stream measurement	17

6.4.3	Coupling arrangements.....	18
6.4.3.1	Arrangements for measurements with continuous bit streams	18
6.4.3.2	Arrangement for measurements with messages	18
6.4.4	Message received indicator	18
6.5	Test sites and general arrangements for radiated measurements	18
6.6	Artificial antenna	19
6.7	Test fixture.....	19
6.7.1	Calibration.....	19
6.7.2	Mode of use.....	20
6.8	Testing of host equipment and plug-in radio devices.....	20
6.8.1	Method 1: combined equipment.....	20
6.8.2	Method 2: use of a test fixture and three hosts	20
7	Methods of measurement and limits for interrogator transmitter parameters.....	21
7.1	Equivalent isotropically radiated power (e.i.r.p).....	21
7.1.1	Definition	21
7.1.2	Method of measurement.....	21
7.1.3	Limit.....	21
7.2	Frequency error.....	22
7.2.1	Definition	22
7.2.2	Method of measurement.....	22
7.2.3	Limit.....	22
7.3	Transmitter spectrum mask	22
7.3.1	Definition	22
7.3.2	Method of measurement.....	22
7.3.3	Limit.....	23
7.4	Modulation index.....	23
7.4.1	Definition	23
7.4.2	Method of measurement.....	23
7.4.3	Limit.....	24
7.5	Eye pattern	24
7.5.1	Definition	24
7.5.2	Method of measurement.....	24
7.5.3	Limit.....	25
7.6	Radiated spurious emissions	25
7.6.1	Definition	25
7.6.2	Measuring receiver.....	25
7.6.3	Method of measurement conducted spurious emission	26
7.6.4	Method of measurement cabinet spurious radiation	26
7.6.5	Method of measurement radiated spurious emission.....	27
7.6.6	Limits	28
8	Methods of measurement and limits for interrogator receiver parameters	28
8.1	Maximum usable sensitivity.....	28
8.1.1	Definition	28
8.1.2	Method of measurements under normal and extreme test conditions	28
8.1.2.1	Test arrangement for equipment with integral antenna.....	29
8.1.2.2	Test arrangement for equipment with antenna connector	30
8.1.2.3	Test procedure for continuous bit streams.....	31
8.1.2.4	Test procedure for messages.....	31
8.1.3	Limits	31
8.2	Error behaviour at high wanted input signals.....	31
8.2.1	Definition	31
8.2.2	Method of measurement.....	31
8.2.3	Limit.....	32
8.3	Degradation measurements	32
8.3.1	Definition	32
8.3.2	General conditions	32
8.3.3	Co-channel rejection	33
8.3.3.1	Definition.....	33
8.3.3.2	Method of measurement	33

8.3.3.3	Limit	34
8.3.4	Adjacent channel selectivity	34
8.3.4.1	Definition	34
8.3.4.2	Method of measurement	34
8.3.4.3	Limit	34
8.3.5	Spurious response rejection and desensitization	35
8.3.5.1	Definition	35
8.3.5.2	Method of measurement	35
8.3.5.3	Limits	36
8.3.6	Intermodulation response rejection	36
8.3.6.1	Definition	36
8.3.6.2	Method of measurement	36
8.3.6.3	Limits	37
8.4	Spurious emissions	37
8.4.1	Definition	37
8.4.2	Method of measurement - conducted spurious emissions	37
8.4.3	Method of measurement - cabinet radiation	38
8.4.4	Method of measurement - radiated spurious components	39
8.4.5	Limit	39
9	Method of measurements and limits for transponders	39
9.1	Transponder sensitivity	39
9.1.1	Definition	39
9.1.2	Method of measurement	39
9.1.3	Limit	40
9.2	Transponder wake-up protection	40
9.2.1	Definition	40
9.2.2	Method of measurement	41
9.2.3	Limit	42
9.3	Transponder conversion gain	42
9.3.1	Definition	42
9.3.2	Method of measurement	42
9.3.3	Limits	43
9.4	Transponder spurious radiation	43
9.4.1	Definition	43
9.4.2	Method of measurement	43
9.4.3	Limits	43
10	Measurement uncertainty	44
Annex A (normative): Radiated measurements		45
A.1	Test sites and general arrangements for measurements involving the use of radiated fields	45
A.1.1	Outdoor test site	45
A.1.2	Standard position	45
A.1.3	Test antenna	46
A.1.4	Optional additional indoor site	46
A.2	Guidance on the use of radiation test sites	46
A.2.1	Measuring distance	46
A.2.2	Test antenna	47
A.2.3	Substitution antenna	47
A.2.4	Auxiliary cables	47
A.3	Further optional alternative indoor test site using a fully anechoic RF chamber	48
A.3.1	Example of the construction of a shielded anechoic chamber	48
A.3.2	Influence of parasitic reflections in anechoic chambers	48
A.3.3	Calibration of the shielded RF anechoic chamber	49

Annex B (normative):	General description of measurement methods	51
B.1	Conducted measurements.....	51
B.2	Radiated measurements.....	51
Annex C (normative):	Receiver methods of measurements using messages	53
C.1	General	53
C.2	Test signals.....	53
C.3	Method of measurement for receiver sensitivity.....	53
C.4	Method of measurements for receiver degradation.....	54
Annex D (normative):	Subclauses of the present document relevant for compliance with the essential requirements EC Council Directives.....	55
Annex E (informative):	Bibliography.....	56
History		57

Intellectual Property Rights

IPRs essential or potentially essential to the present document may have been declared to ETSI. The information pertaining to these essential IPRs, if any, is publicly available for **ETSI members and non-members**, and can be found in ETR 314: "*Intellectual Property Rights (IPRs); Essential, or potentially Essential, IPRs notified to ETSI in respect of ETSI standards*", which is available **free of charge** from the ETSI Secretariat. Latest updates are available on the ETSI Web server (<http://www.etsi.fr/ipr>).

Pursuant to the ETSI Interim IPR Policy, no investigation, including IPR searches, has been carried out by ETSI. No guarantee can be given as to the existence of other IPRs not referenced in ETR 314 (or the updates on <http://www.etsi.fr/ipr>) which are, or may be, or may become, essential to the present document.

Foreword

This draft European Standard (Telecommunications series) has been produced by ETSI Technical Committee Electromagnetic compatibility and Radio spectrum Matters (ERM), and is now submitted for the ETSI standards One-step Approval Procedure (OAP).

The present document has been produced by ETSI in response to a mandate from the European Commission issued under Council Directive 83/189/EEC (as amended) laying down a procedure for the provision of information in the field of technical standards and regulations.

The present document, together with ETS 300 683, is intended to become a Harmonized Standard, the reference of which will be published in the Official Journal of the European Communities referencing the Council Directive on the approximation of the laws of the Member States relating to electromagnetic compatibility ("the EMC Directive") (89/336/EEC as amended).

Technical specifications relevant to the EMC Directive are given in annex D.

Every EN prepared by ETSI is a voluntary standard. The present document contains text concerning type approval of the equipment to which it relates. This text should be considered as guidance and does not make the present document mandatory.

Proposed national transposition dates	
Date of latest announcement of this EN (doa):	3 months after ETSI publication
Date of latest publication of new National Standard or endorsement of this EN (dop/e):	6 months after doa
Date of withdrawal of any conflicting National Standard (dow):	6 months after doa

Introduction

The present document was drafted on the assumption that type test measurements, performed in an accredited test laboratory, will be accepted by the various national regulatory authorities in order to grant type approval, provided the national regulatory requirements are met. This is in compliance with CEPT/ERC Recommendation 70-03 [1] and CEPT/ERC Recommendation 01-06 [5].

The present document specifies the requirements for a dedicated 2,45 GHz short range microwave link intended for a European wide data communication system for Railway applications, Automatic Vehicle Identification (AVI).

The in-track base station (interrogator) transmit and receive modulations are a combination of Amplitude Shift Keying (ASK) and Frequency Shift Keying (FSK) respectively.

The present document supports the necessary transmitter and receiver data rates between 192 kbit/s and 384 kbit/s according to the type of transaction.

The system comprises five channels with dynamic channel allocation, within an 8 MHz bandwidth.

The maximum radiated equivalent isotropically radiated power (e.i.r.p) at each carrier frequency is 500 mW (+27 dBm).

In order to permit the greatest freedom of design of equipment, whilst protecting other radio services from interference, a balance is required between the permitted range of frequencies on which the equipment may be used, and its frequency stability and modulation characteristics. The present document specifies the operational frequencies and system bandwidths; these parameters are covered by CEPT/ERC Recommendation 70-03, annex 4 [1].

Clauses 1 and 3 give a general description of the types of equipment covered by the present document and the definitions and abbreviations used. Clause 4 gives general requirement in order that type tests may be carried out and any markings on the equipment to be provided by the manufacturer.

Clauses 5 and 6 specify the test conditions.

Clauses 7 and 8 specify the limits of the parameters which are required to be tested. These limits have been chosen to minimize harmful interference to and from other equipment and services. These clauses also specify how the equipment is to be tested and the conditions which are applied.

Clause 9 specifies the limits of the parameters which are required to be tested for transponders. Details on the test methods for the transponders are also specified.

Clause 10 specifies the maximum measurement uncertainty values.

Annex A provides normative specifications concerning test sites for radiated measurements.

Annex B provides normative descriptions of measurement methods for radiated measurements.

Annex C provides normative descriptions of alternative measurement methods for receivers.

Annex D provides normative technical parameters relevant to the EMC Directive

1 Scope

The present document applies to 2,45 GHz Short Range Devices (SRDs) for use in Railway AVI which fulfil the Union Internationale des Chemins de fer (UIC) specifications (annex E) and are interoperable with the current UIC system except for the interrogator (Track Units (TU)) bandwidth. The Interrogator bandwidth is limited to 8 MHz shared within five channels:

- with a Radio Frequency (RF) output connection and specified antenna or with an integral antenna;
- for data transmission only;
- operating on radio frequencies in the 2,446 GHz to 2,454 GHz Industrial, Scientific and Medical (ISM) band, with power levels up to 500 mW e.i.r.p as defined in the CEPT/ERC Recommendation T/R 70-03 [1].

It covers the minimum characteristics considered necessary in order to make the best use of the available frequencies. It does not necessarily include all the characteristics which may be required by a user, nor does it necessarily represent the optimum performance achievable.

The present document is based upon CEPT Recommendations T/R 70-03 [1]. It is a product standard covering various Railway applications where the data transmission of the system will be active only during the presence of the train.

The present document covers fixed installed interrogators (TUs) and transponders (mobile stations). For certain measurements the transponders are measured together with the whole interrogating system.

The present document includes specifications for methods of measurement for equipment fitted with antenna sockets and/or integral antennae.

Additional standards or specifications may be required for equipment such as that intended for connection to the Public Switched Telephone Network (PSTN) or other systems.

2 Normative references

References may be made to:

- a) specific versions of publications (identified by date of publication, edition number, version number, etc.), in which case, subsequent revisions to the referenced document do not apply; or
- b) all versions up to and including the identified version (identified by "up to and including" before the version identity); or
- c) all versions subsequent to and including the identified version (identified by "onwards" following the version identity); or
- d) publications without mention of a specific version, in which case the latest version applies.

A non-specific reference to an ETS shall also be taken to refer to later versions published as an EN with the same number.

- | | |
|-----|---|
| [1] | draft CEPT/ERC Recommendation 70-03 (1997): "Relating to the use of Short Range Devices (SRD)". |
| [2] | IEC 721-3-4 (1995): "Classification of environmental conditions - Part 3: Classification of groups of environmental parameters and their severities - Section 4: Stationary use at non-weatherprotected locations". |
| [3] | CISPR 16-1: "Specification for radio disturbance and immunity measuring apparatus and methods - Part 1: Radio disturbance and immunity measuring apparatus". |
| [4] | EN 55022: "Limits and methods of measurements of radio disturbance characteristics of information technology equipment". |

- [5] CEPT/ERC Recommendation 01-06: "Procedures for type testing and approval for radio equipment intended for non-public systems".
- [6] ETR 028: "Radio Equipment and Systems (RES); Uncertainties in the measurement of mobile radio equipment characteristics".
- [7] ITU-T Recommendation O.153 (1992): "Basic parameters for the measurement of error performance at bit rates below the primary rate".

3 Definitions, symbols and abbreviations

3.1 Definitions

For the purposes of the present document, the following definitions apply:

assigned frequency band: The frequency band within which the device is authorized to operate.

integral antenna: An antenna, with or without a connector, designed as an indispensable part of the equipment.

interrogator: Equipment intended for use in a fixed location (Fixed Station (FS)).

operating frequency range: The range of operating frequencies over which the equipment can be adjusted through switching, tuning or reprogramming.

portable equipment: Equipment intended to be carried, attached or implanted.

radiated measurements: Measurements which involve the absolute measurement of a radiated field.

transponder: A device normally fixed in a vehicle which responds to an interrogating signal.

3.2 Symbols

For the purposes of the present document, the following symbols apply:

λ	Wavelength
dB _i	Gain relative to an isotropic antenna
dB _m	dB relative to 1 mW
E	Field strength
E ₀	Reference field strength, (see annex B)
f ₀	frequency of operation
R	Distance, (see annex B)
R ₀	Reference distance, (see annex B)
Rx	Receiver
Tx	Transmitter

3.3 Abbreviations

For the purposes of the present document, the following abbreviations apply:

AB	Allocated Band
AVI	Automatic Vehicle Identification
CG	Conversion Gain
e.i.r.p	equivalent isotropically radiated power
IF	Intermediate Frequency
ISM	Industrial, Scientific and Medical
LLC	Layer Level Control
MAC	Medium Access Control
OEM	Original Equipment Manufacturer

ppm	parts per million (10^{-6})
RF	Radio Frequency
TU	Track Unit
UIC	Union Internationale des Chemins de fer (International Union of Railways)
VSWR	Voltage Standing Wave Ratio
ASK	Amplitude Shift Keying
FSK	Frequency Shift Keying
SRD	Short Range Device
PSTN	Public Switched Telephone Network
FS	Fixed Station
ITE	Information Technology Equipment

4 General

4.1 Presentation of equipment for testing purposes

Each equipment submitted for testing shall fulfil the requirements of the present document on all frequencies over which it is intended to operate.

The performance of the equipment submitted for testing shall be representative of the performance of the corresponding production model. In order to avoid any ambiguity in that assessment, the present document contains instructions for the presentation of equipment for testing purposes (this subclause), conditions of testing (see clause 5) and measurement methods (see clauses 7, 8 and 9).

The applicant shall complete the appropriate application form when submitting equipment for testing. Additionally, technical documentation and operating manuals shall also be supplied.

Stand alone equipment shall be offered by the applicant complete with any ancillary equipment needed for testing. The applicant shall declare the frequency range(s), the range of operation conditions and power requirements, as applicable, in order to establish the appropriate test conditions.

Test fixtures may be supplied by the applicant (see subclause 6.7).

Original Equipment Manufacturer's (OEM) plug-in cards or units may be offered for testing together with a suitable test fixture. Alternatively, complete AVI equipment may be supplied by the manufacturer to facilitate the tests (see subclause 6.8.2).

To simplify and harmonize the testing procedures between the different test laboratories, measurements shall be performed, according to the present document, on samples of equipment defined in subclauses 4.2.1 and 4.2.2. These subclauses are intended to give confidence that the requirements set out in the present document have been met without the necessity of performing measurements on all channel frequencies.

4.1.1 Choice of model for testing

The applicant shall provide one or more production models of the equipment, as appropriate, for testing.

4.1.2 Choice of operating frequencies

Where equipment can be adjusted to operate at different operating frequencies other than the five standard channels, a minimum of two operating frequencies shall be chosen such that the lower and higher limits of the applicant's declared operating ranges of the equipment are covered. For equipment with RF output connection and specified antenna, the applicant shall declare the gain of the antenna assembly i.e. the transfer function between the conducted RF power and e.i.r.p shall be declared.

4.1.3 Testing of equipment without a permanent external RF port

To facilitate relative measurements, use may be made of a test fixture as described in subclause 6.7, or the equipment may be supplied with a permanent internal or temporary internal or external RF port, providing the characteristics being measured are not expected to be affected.

4.1.4 Equipment with a permanent internal RF port

The way to access a permanent internal RF port shall be stated by the applicant with aid of a diagram. The fact that use has been made of a permanent internal RF port shall be recorded in the test report.

4.1.5 Equipment with a temporary RF port

The applicant shall submit two sets of equipment to the test laboratory, one fitted with a temporary 50 Ω RF connector with the antenna disconnected and the other with the antenna connected. Each equipment shall be used for the appropriate tests. The measurements, wherever possible, should be made by use of a direct connection to the equipment under test (antenna connector or temporary 50 Ω connector) as stated in the present document, in order to ensure that the measurement uncertainties are minimized.

The way the temporary RF port is implemented shall be stated by the applicant with the aid of a diagram. The fact that use has been made of the temporary RF port to facilitate measurements shall be stated in the test report.

4.2 Mechanical and electrical design

4.2.1 General

The equipment submitted by the applicant, or his representative, shall be designed, constructed and manufactured in accordance with good engineering practice, and with the aim of minimizing harmful interference to other equipment and services.

Transmitters and receivers may be individual or combination units.

4.2.2 Controls

Those controls which if maladjusted might increase the interference possibilities to and from the equipment shall only be accessible by partial or complete disassembly of the device and requiring the use of tools.

4.2.3 Test mode facility

If the unit is equipped with a data squelch or battery saving circuit or similar facility that prevents tests being made, it shall be possible to override this circuit for the duration of some tests.

4.3 Auxiliary test equipment

All necessary test signal sources and setting up information shall accompany the equipment when it is submitted for testing.

4.4 Interpretation of the measurement results

The interpretation of the results recorded on the test report form for the measurements described in the present document shall be as follows:

- the measured value related to the corresponding limit shall be used to decide whether an equipment meets the requirements of the present document;
- the measurement uncertainty value for the measurement of each parameter shall be included in the test report;

- the recorded value of the measurement uncertainty shall be, for each measurement, equal to or lower than the figures of measurement uncertainty given in clause 10.

5 Test conditions, power sources and ambient temperatures

5.1 Normal and extreme test conditions

Testing shall be made under normal test conditions, and also, where stated, under extreme test conditions.

The test conditions and procedures shall be as specified in subclauses 5.2 to 5.4.

5.2 External test power source

During type tests the power source of the equipment shall be replaced by an external test power source, capable of producing normal and extreme test voltages as specified in subclauses 5.3.2 and 5.4.2. The internal impedance of the external test power source shall be low enough for its effect on the test results to be negligible.

For battery operated equipment the battery shall be removed and the external test power source shall be suitably de-coupled and applied as close to the equipment battery terminals as practicable. For radiated measurements any external power leads should be so arranged so as not to affect the measurements. If necessary, the external test power source may be replaced with the supplied or recommended internal batteries at the required voltage or a battery simulator. This shall be stated on the test report. For radiated measurements on portable equipment with an integral antenna, fully charged internal batteries should be used. The batteries used should be as supplied or recommended by the applicant.

If the equipment is powered from an external source, the test voltage shall be measured at the point of connection of the power cable to the equipment.

During tests the external test power source voltages shall be within a tolerance of ± 1 % relative to the voltage at the beginning of each test. The value of this tolerance can be critical for certain measurements. Using a smaller tolerance provides a better uncertainty value for these measurements. If internal batteries are used, at the end of each test the loaded voltage shall be within a tolerance of ± 5 % relative to the loaded voltage at the beginning of each test.

5.3 Normal test conditions

5.3.1 Normal temperature and humidity

The normal temperature and humidity conditions for tests shall be any convenient combination of temperature and humidity within the following ranges:

- temperature $+15^{\circ}\text{C}$ to $+35^{\circ}\text{C}$;
- relative humidity 20 % to 75 %.

When it is impracticable to carry out tests under these conditions, a note to this effect, stating the ambient temperature and relative humidity during the tests, shall be added to the test report.

5.3.2 Normal test power source

5.3.2.1 Mains voltage

For the purpose of the present document, the nominal voltage shall be the declared voltage, or any of the declared voltages, for which the equipment was designed.

The frequency of the test power source corresponding to the ac mains shall be between 49 Hz and 51 Hz.

5.3.2.2 Regulated lead-acid battery power sources

When the radio equipment is intended for operation from the usual types of lead-acid battery regulated power source, the normal test voltage shall be multiplied by 1,1 of the nominal voltage of the battery ($6\text{ V} \times 1,1$, $12\text{ V} \times 1,1$ etc.).

5.3.2.3 Other power sources

For operation from other power sources or types of battery (primary or secondary), the normal test voltage shall be that declared by the applicant and shall be stated in the test report.

5.4 Extreme test conditions

5.4.1 Extreme temperatures

5.4.1.1 Procedure for tests at extreme temperatures

Before measurements are made the equipment shall have reached thermal balance in the test chamber.

The equipment shall be switched off during the temperature stabilizing period.

In the case of equipment containing temperature stabilization circuits designed to operate continuously, the temperature stabilization circuits shall be switched on for 15 minutes after thermal balance has been obtained, and the equipment shall then meet the specified requirements.

If the thermal balance is not checked by measurements, a temperature stabilizing period of at least one hour, or such period as may be decided by the accredited test laboratory, shall be allowed. The sequence of measurements shall be chosen and the humidity content in the test chamber shall be controlled so that condensation does not occur.

5.4.1.1.1 Procedure for equipment designed for continuous transmit operation

If the applicant states that the equipment is designed for continuous operation, the test procedure shall be as follows:

- before tests at the upper extreme temperature the equipment shall be placed in the test chamber and left until thermal balance is attained. The equipment shall then be switched on in the normal operating condition for a period of half an hour after which the equipment shall meet the specified requirements;
- for tests at the lower extreme temperature the equipment shall be left in the test chamber until thermal balance is attained, then switched on in the normal operating condition for a period of one minute after which the equipment shall meet the specified requirements.

5.4.1.1.2 Procedure for equipment designed for intermittent transmit operation

If the applicant states that the equipment is designed for intermittent transmit operation, the test procedure shall be as follows:

- before tests at the upper extreme temperature the equipment shall be placed in the test chamber and left until thermal balance is attained. The equipment shall then either:
 - if the applicants declared "on" period exceeds one minute then equipment shall transmit in the on condition for a period not exceeding one minute, followed by a period in the off or standby mode for four minutes;
 - otherwise, equipment shall transmit on and off according to the applicants declared maximum duty cycle for a period of five minutes;

after which the equipment shall meet the specified requirements in any of the operational modes ;

- for tests at the lower extreme temperature the equipment shall be left in the test chamber until thermal balance is attained, then switched to the standby or receive condition for one minute after which the equipment shall meet the specified requirements in any of the operational modes immediately.

5.4.1.2 Extreme temperature ranges

For tests at extreme temperature, measurements shall be made in accordance with the procedures specified in subclause 5.4.1.1, at the upper and lower temperatures of one of the following ranges in accordance with the manufacturer's declared temperature category (IEC 721-3-4 [2]).

Table 1: Extreme temperature ranges

Temperature category	Interrogator	Transponder
Category I (General):	-30°C to +70°C	-40°C to +50°C
Category II:	-40°C to +70°C	-40°C to +70°C

The test report form shall state which temperature category has been used.

5.4.2 Extreme test source voltages

5.4.2.1 Mains voltage

The extreme test voltages for equipment to be connected to an ac mains source shall be the nominal mains voltage +10 % \mp -15 %. The mains source frequency shall be between 49 Hz and 51 Hz.

5.4.2.2 Lead-acid battery, regulated power sources

When the radio equipment is intended for operation from the usual type of regulated lead-acid battery power sources the extreme test voltages shall be 1,3 and 0,9 multiplied by the nominal voltage of the battery (6 V, 12 V, etc.).

For float charge applications using "gel-cell" type batteries the extreme test voltages shall be 1,15 and 0,85 multiplied by the nominal voltage of the declared battery voltage.

5.4.2.3 Power sources using other types of batteries

The lower extreme test voltages for equipment with power sources using batteries shall be as follows:

- for equipment with a battery indicator, the end point voltage as indicated;
- for equipment without a battery indicator the following end point voltage shall be used:
 - for the Leclanché or the lithium type of battery:
0,85 multiplied by the nominal voltage of the battery;
 - for the nickel-cadmium type of battery:
0,9 multiplied the nominal voltage of the battery;
 - for other types of battery the lower extreme test voltage for the discharged condition shall be declared by the equipment applicant.

No upper extreme test voltages apply.

5.4.2.4 Other power sources

For equipment using other power sources, or capable of being operated from a variety of power sources, the extreme test voltages shall be those agreed between the equipment applicant and the accredited test laboratory and shall be recorded in the test report.

6 General conditions

6.1 Test signals and test modulation

Where appropriate, a test signal shall be used with the following characteristics:

- representative of normal operation as declared;
- causes greatest occupied bandwidth as declared.

The test modulation is a signal which modulates a carrier and is dependent upon the type of equipment under test and also the measurement to be performed.

For equipment using intermittent transmissions the test signal shall be such that:

- the generated RF signal is the same for each transmission;
- transmissions occur regularly in time;
- sequences of transmissions can be accurately repeated.

Details of test signals and test modulation shall be included in the test report.

Normal operating modulation shall be used where there is no provision for external test modulation.

During normal operation the interrogator transmitter uses both modulated and unmodulated carrier. Consequently, both a modulated and unmodulated carrier is used during the transmitter tests.

6.1.1 Normal test signals (wanted and unwanted signals)

The wanted signals for methods of measurement with bit streams and messages are defined in subclauses 6.1.1.1 and 6.1.1.2 respectively.

At the manufacturer's choice, the test signals can either be applied externally or implemented into the equipment as a test mode. The method used shall be stated in the test report.

Technical characteristics of modulation and coding are given in UIC Specifications (annex E).

6.1.1.1 Signals for bit stream measurements

When the equipment is intended to be tested with continuous bit streams the normal test signal shall be as follows:

- signal D-M0, consisting of an infinite series of 0-bits;
- signal D-M1, consisting of an infinite series of 1-bits;
- signal D-M2, consisting of a pseudo-random bit sequence of at least 511 bits according to ITU-T Recommendation O.153 [7];
- signal D-M2', this is the same type as D-M2, but the pseudo random bit sequence is independent of D-M2 perhaps identical with D-M2 but started at a different point of time with an incoherent clock.

Applying an infinite series of 0 bits or 1 bits does not normally produce the typical bandwidth. Signal D-M2 is designed to produce a good approximation of the typical bandwidth.

6.1.1.2 Signal for messages

The equipment may be tested by using messages when it is not possible to test with bit streams according to subclause 6.1.1.1. In this case the normal test signal shall be sequences of correctly coded bits or messages. Such messages can also be used for activation of transponders functions or performance test of an installed system.

The normal test signals and modulations (D-M3, D-M4 and D-M4') are specified in clause C.2.

For further details concerning receiver degradation measurements, see annex C.

6.2 Modes of operation of the transmitter

For the purpose of the measurements according to the present document, there shall be a facility to operate the transmitter unmodulated. The method of obtaining an unmodulated carrier or special types of modulation patterns may also be decided by agreement between the applicant and the testing laboratory. The method shall be described in the test report. It may involve suitable temporary internal modifications of the equipment under test. Alternatively, a test signal can be implemented as described in subclause 6.1.1.

6.3 Encoder for receiver measurements

Whenever needed and in order to facilitate measurements on the receiver, an encoder for the data system shall accompany the model submitted, together with details of the normal modulation process. The encoder will be used to modulate a signal generator for use as a test signal source.

In the case of equipment unable to operate with continuous bit streams, the encoder shall be capable of operation in a repetitive mode.

Complete details of all codes and code format(s) used shall be given.

6.4 Facilities for access

6.4.1 Analogue access

In order to simplify the measurements in subclause 8.3.5.2 (receiver spurious response rejection), temporary access to a point where the amplitude of the analogue signal of the RF path can be measured should be provided, e.g. Intermediate Frequency (IF) output or demodulated IF point may be provided for the equipment to be tested. This access can be used to determine or verify the frequency where a spurious response is expected.

6.4.2 Access points for data stream measurement

It is recognized that it is not always possible to measure an air interface data stream. The manufacturer shall define the points at which the equipment shall be tested in order to make the measurements on data streams or messages according to subclauses 6.1.1.1 and 6.1.1.2.

Figure 1 is presented for clarification only.

The tests shall be performed by use of points (A, a or B, b or C, c or D, d).

The points shall be recorded in the test report.

NOTE: The closer the access point is located to the air interface (see figure 1) a fewer number of product variants may have to be type tested because the measurement is less application dependent.

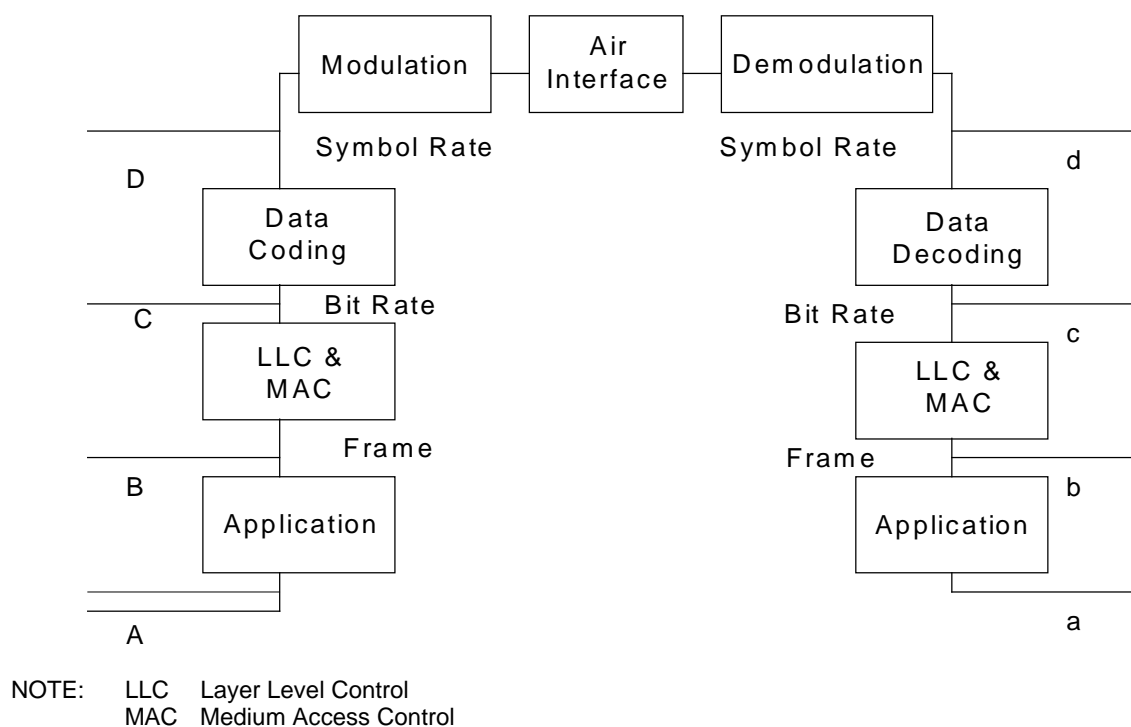

Figure 1: Measuring points for data stream measurements

6.4.3 Coupling arrangements

Arrangements shall be made by the manufacturer to couple the unit to be tested to the test equipment by a method which does not affect the radiated field (e.g. acoustic, ultrasonic or optic) according to the subclauses 6.4.3.1 and 6.4.3.2.

6.4.3.1 Arrangements for measurements with continuous bit streams

For the measurements of the receiver on a test site, arrangements to couple the unit to be tested to the bit error ratio measuring device shall be available.

Furthermore, the manufacturer may also provide another facility to give access to the analogue information (see subclause 6.4).

6.4.3.2 Arrangement for measurements with messages

For the measurements of the receiver on a test site, arrangements to couple the unit to be tested to the bit error ratio observation device (or to an operator) shall be available.

Furthermore, the manufacturer may also provide another facility to give access to the analogue information (see subclause 6.4).

6.4.4 Message received indicator

Any suitable means of indicating that the receiver has successfully received a correctly coded message may be provided.

6.5 Test sites and general arrangements for radiated measurements

For guidance on radiation test sites see annex A. Detailed descriptions of the radiated measurement arrangements are included in this annex.

6.6 Artificial antenna

Where applicable, tests shall be carried out using an artificial antenna which shall be a substantially non-reactive non-radiating load of $50\ \Omega$, connected to the antenna connector. The Voltage Standing Wave Ratio (VSWR) at the $50\ \Omega$ connector shall not be greater than 1,5:1 over the frequency range of the measurement.

6.7 Test fixture

The test fixture is a radio frequency coupling device associated with an integral antenna equipment for coupling the integral antenna to a $50\ \Omega$ radio frequency terminal at the working frequencies of the equipment under test. This allows certain measurements to be performed using the conducted measurement methods. Only relative measurements may be performed and only those at or near frequencies for which the test fixture has been calibrated.

In addition, the test fixture shall provide:

- a connection to an external power supply;
- an data interface either by direct connection or by an acoustic or photo coupler.

The test fixture normally shall be provided by the manufacturer.

The performance characteristics of the test fixture shall be approved by the testing authority and shall conform to the following basic parameters:

- the coupling loss shall not be greater than 30 dB;
- a coupling loss variation over the frequency range used in the measurement which does not exceed 2 dB;
- circuitry associated with the RF coupling shall contain no active or non linear devices;
- the VSWR at the $50\ \Omega$ socket shall not be greater than 1,5 over the frequency range of the measurements;
- the coupling loss shall be independent of the position of the test fixture and be unaffected by the proximity of surrounding objects or people. The coupling loss shall be reproducible when the equipment under test is removed and replaced;
- the coupling loss shall remain substantially constant when the environmental conditions are varied.

The characteristics and calibration shall be included in the test report.

6.7.1 Calibration

The calibration of the test fixture establishes a relationship between the output of the signal generator and the field strength applied to the equipment inside the test fixture.

The calibration is valid only at a given frequency and for a given polarization of the reference field.

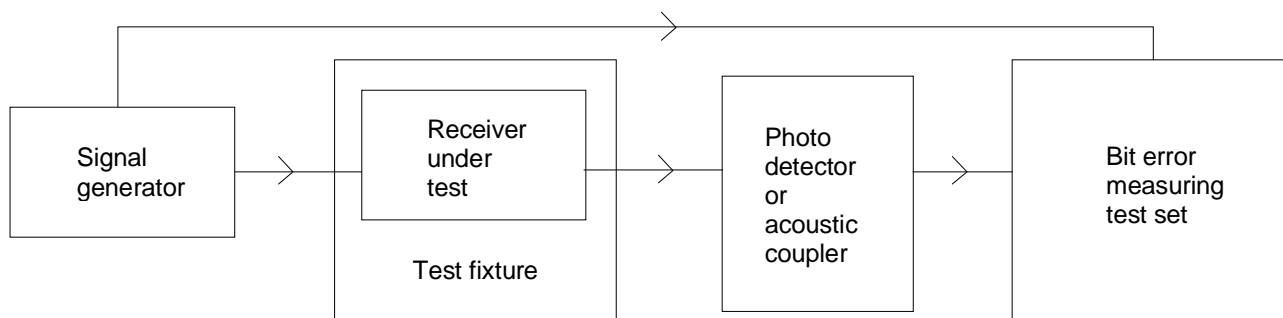

Figure 2: Measuring arrangement for calibration

- a) using the method described in subclause 8.1, the sensitivity expressed as field strength shall be measured, and the value of this field strength expressed in dBm and the polarization used shall be noted;
- b) the receiver shall be placed in the test fixture which is connected to the signal generator. The signal generator shall be set to the level producing normal sensitivity;
- c) the calibration of the test fixture is the tested linear relationship between the field strength expressed in dBm and the signal generator level in dBm.

6.7.2 Mode of use

The test fixture may be used to facilitate some of the measurements in clauses 7, 8 and 9 on equipment with an integral antenna.

It is used in the measurements of radiated carrier power and measured usable sensitivity expressed as a field strength in clauses 7, 8 and 9 to enable a measurement to be made under extreme test conditions.

To apply the specified wanted signal levels expressed in field strength, they shall be converted into the signal generator level (dBm) using the calibration of the test fixture. This value shall be applied to the signal generator.

6.8 Testing of host equipment and plug-in radio devices

For equipment for which connection to or integration with host equipment is necessary to offer functionality, two alternative approaches are permitted. The manufacturer shall declare which shall be used.

6.8.1 Method 1: combined equipment

A combination of a radio equipment part and a specific type of host equipment may be used for testing according to the present document.

Where more than one such combination is intended, each combination shall be tested separately.

Testing shall not be repeated for combinations of radio parts and host equipment where the latter are substantially similar in terms of mechanical and electrical characteristics as those offered for testing.

6.8.2 Method 2: use of a test fixture and three hosts

Where the radio equipment part is intended for use with a variety of host systems, the manufacturer shall supply a suitable test fixture. The test fixture shall be designed such that alteration of the radio equipment's intrinsic emissions is minimized. Where connection between the radio equipment part and the host is by means of cables, optical fibres or similar means between control and/or power ports, the connection to the host shall be considered a suitable test fixture.

The test fixture shall allow the radio equipment part to be powered and stimulated in a way similar to the way it would be powered and stimulated when connected to or installed into host equipment. Measurements shall be made to all requirements of the present document.

In addition to tests on the test fixture, the radio equipment part shall be tested when connected to or inserted into three different hosts, e.g. Information Technology Equipment (ITE). These hosts shall be provided by the manufacturer.

For tests with the radio equipment part connected to, or inserted in, host equipment, the combination shall be tested against the requirements of the present document except for cabinet radiation from the enclosure which shall be measured according to the requirements that apply to the host equipment. In the case where the host equipment is ITE, the requirements of EN 55022 [4] apply. The applicable class under EN 55022 [4], as identified in the user manual, shall be declared by the manufacturer and recorded in the test report.

7 Methods of measurement and limits for interrogator transmitter parameters

To meet the requirements for all applications the transmitter shall be measured at the power level and antenna gain declared by the applicant. If the applicant intends to use different gain antennas to cover all applications the measurements shall be made at a power level corresponding to the lowest gain antenna and repeated concerning measurements of radiated spurious emissions at the power setting for the highest gain antenna (see subclause 7.6). The declared power levels and antenna gains shall be stated in the application form and test report.

If the equipment to be tested is designed with an antenna connector, then this connector may be used, via a calibrated coupler or attenuator, if required to provide the correct termination impedance, to facilitate the measurements.

If a temporary 50 Ω RF connector is used, this shall be stated in the test report (see subclause 4.2.1).

7.1 Equivalent isotropically radiated power (e.i.r.p)

7.1.1 Definition

The e.i.r.p is defined as the peak power of the transmitter and shall be calculated according to the procedure given in the following subclause. The equivalent isotropically radiated power is then calculated from the declared antenna gain. See clause 5 for the test conditions.

7.1.2 Method of measurement

Using an applicable measurement procedure as described in annex B, the power output shall be measured and recorded in the test report.

For power measurements, a spectrum analyser or selective voltmeter shall be used and tuned to the transmitter carrier at which the highest output level is detected.

For measurements using a spectrum analyser, the resolution and video bandwidths shall be set to a maximum of:

- 100 kHz for signals with a RF bandwidth of less than or equal to 1 MHz;
- 1 MHz for signals with a RF bandwidth greater than 1 MHz.

The measurement shall be made both in the modulated and unmodulated transmitter mode, see subclause 6.2.

This measurement shall be performed at normal and at extreme conditions (see subclauses 5.3 and 5.4).

The method of measurement shall be documented in the test report.

The actual e.i.r.p is calculated according to the relevant method stated in annex B.

7.1.3 Limit

The transmitter maximum e.i.r.p under normal and extreme test conditions shall not exceed 500 mW (+ 27 dBm).

7.2 Frequency error

7.2.1 Definition

The frequency error of the equipment is the difference between the unmodulated carrier frequency and the nominal frequency selected for the test.

7.2.2 Method of measurement

The following method of measurement shall be used:

- a) with an antenna connector:
 - the transmitter shall be connected to an artificial antenna. A frequency meter shall be connected to the artificial antenna via appropriate attenuation and the carrier frequency shall be measured without modulation;
 - the measurement shall be repeated under extreme test conditions;
- b) with an integral antenna:
 - a test fixture with 50 Ω output connection shall be positioned for appropriate coupling to the radiated field. A frequency meter shall be connected to the test fixture via appropriate attenuation and the carrier frequency shall be measured without modulation. The test fixture shall be calibrated, documented and supplied by the manufacturer;
 - the measurement shall be repeated under extreme test conditions.

The method of measurement shall be stated in the test report.

7.2.3 Limit

The frequency error under normal and extreme conditions shall not exceed ± 20 parts per million (ppm).

7.3 Transmitter spectrum mask

7.3.1 Definition

The interrogator transmitter spectrum mask is defined as the radiated power density around the carrier frequency caused by the modulated transmitter. The spectrum mask depends on the actual bit rate and coding scheme used for the declared system application(s).

The specific bit rates and coding schemes offered by the equipment under test is defined by UIC Specifications (annex E) and is stated in the test report.

The distance between multiple interrogators is determined by the spectrum-mask attenuation.

7.3.2 Method of measurement

The method of measurement depends on whether the equipment has an antenna connector or an integral antenna:

- a) equipment with an antenna connector:
 - the transmitter shall be connected to an artificial antenna. A spectrum analyser shall be connected to the artificial antenna via appropriate attenuation and the transmitter spectrum shall be measured with and without modulation;
 - the measurement shall be repeated under extreme test conditions;

b) equipment with an integrated antenna:

- a test fixture with 50 Ω output connection shall be positioned for appropriate coupling to the radiated field. A spectrum analyser shall be connected to the test fixture via appropriate attenuation and the transmitter spectrum shall be measured with and without modulation. The test fixture shall be supplied, calibrated and documented by the manufacturer;
- the measurement shall be repeated under extreme test conditions.

The test shall be made with test modulation signal D-M4, see general conditions in subclause 6.1.1.2.

Measurements shall be made at the following frequencies: $f_0 \pm 1$ MHz, $f_0 \pm 1,5$ MHz within the assigned frequency band and repeated under extreme test conditions. The measurements shall be made by using a standard spectrum analyser and using the following procedure:

- the bandwidth of the spectrum analyser shall be set to 100 kHz;
- the video filter shall be switched on.

The measurements shall be recorded in the test report.

7.3.3 Limit

The limits for the radiated transmitter spectrum mask during normal and extreme test conditions shall not exceed the values given in table 2.

Table 2: Tx spectrum mask limits (e.i.r.p.)

	Unmodulated	Modulated
f_0	covered by subclause 7.1	
$f_0 + 1,0$ MHz	-50 dBm	-30 dBm
$f_0 - 1,0$ MHz	-50 dBm	-30 dBm
$f_0 + 1,5$ MHz	-50 dBm	-40 dBm
$f_0 - 1,5$ MHz	-50 dBm	-40 dBm
Other frequencies within the assigned frequency band	-50 dBm	-30 dBm
Outside the assigned frequency band.	covered by subclause 7.6	

7.4 Modulation index

7.4.1 Definition

The modulation index indicates the size of modulation in relation to the maximum theoretically possible.

7.4.2 Method of measurement

The following method of measurement shall be used:

- a) equipment with an antenna connector:
- the transmitter shall be connected to an artificial antenna. A matched 50 Ω diode detector with a dc-coupled oscilloscope shall be connected to the artificial antenna via appropriate attenuation and the diode detector voltage shall be measured with and without modulation;

b) equipment with an integrated antenna:

- a test fixture with 50 Ω output connection shall be positioned for appropriate coupling to the radiated field. A matched 50 Ω diode detector with a dc-coupled oscilloscope shall be connected to the test fixture via appropriate attenuation and the diode detector voltage shall be measured with and without modulation. The test fixture shall be documented by the manufacturer.

The transmitter shall be modulated with the test signal D-M2.

The modulation index shall be calculated as follows:

$$\text{Modulation index} = \frac{V_{\max} - V_{\min}}{V_{\max} + V_{\min}}$$

7.4.3 Limit

The modulation index during normal and extreme test conditions shall be greater than or equal to 0,9.

7.5 Eye pattern

7.5.1 Definition

The eye pattern defines the free decision of a digital signal pulse with respect to pulse width and amplitude.

7.5.2 Method of measurement

The following method of measurement shall be used:

a) equipment with an antenna connector:

- the transmitter shall be connected to an artificial antenna. A diode detector with a dc-coupled oscilloscope shall be connected to the artificial antenna via appropriate attenuation and the diode detector voltage shall be measured with modulation;

b) equipment with an integrated antenna:

- a test fixture with 50 Ω output connection shall be positioned for appropriate coupling to the radiated field. A diode detector with a dc coupled oscilloscope shall be connected to the test fixture via appropriate attenuation and the diode detector voltage shall be measured with modulation;
- the test fixture shall be documented by the manufacturer.

The test modulation signal shall be D-M2.

With reference to figure 3, the eye pattern is calculated as:

$$\text{Pulse amplitude} = \frac{2B}{A + B}$$

$$\text{Pulse width} = \frac{2B'}{A'+B'}$$

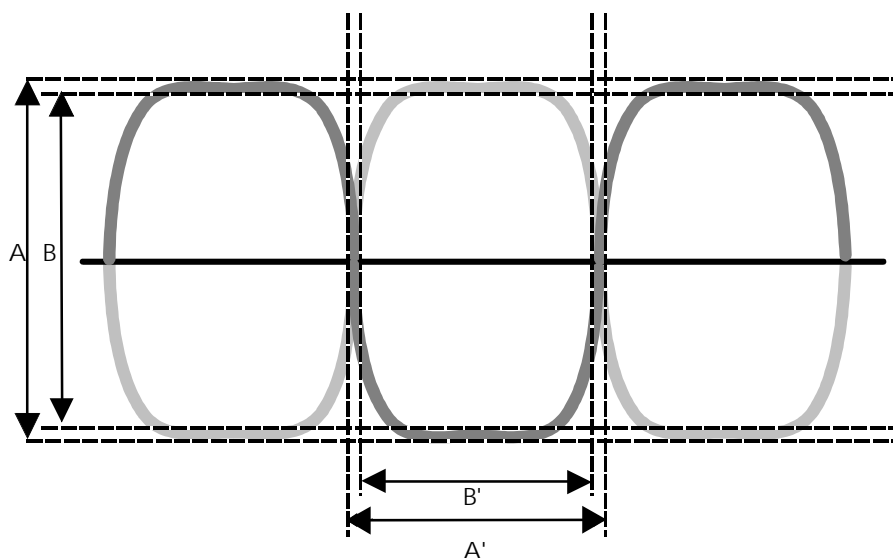

Figure 3: Eye pattern measurement

7.5.3 Limit

The values of pulse amplitude and pulse width calculated from the eye pattern during normal and extreme test conditions shall not be below the values given in table 3.

Table 3: Eye pattern limits

Pulse amplitude	90 %
Pulse width	90 %

7.6 Radiated spurious emissions

7.6.1 Definition

Spurious emissions are emissions at frequencies, other than those of the carrier and sidebands associated with normal modulation. The level of spurious emissions shall be measured as either:

- a)
 - their power level in a specified load (conducted emission); and
 - their effective radiated power when radiated by the cabinet and structure of the equipment (cabinet radiation);
- or
- b) their effective radiated power when radiated by the cabinet and the integral antenna, in the case of equipment fitted with such an antenna and no permanent RF connector.

7.6.2 Measuring receiver

The term "measuring receiver" refers to either a selective voltmeter or spectrum analyser. The bandwidth of the measuring receiver shall, where possible, be according to CISPR 16-1 [3]. In order to obtain the required sensitivity a narrower bandwidth may be necessary, this shall be stated in the test report form.

The bandwidth of the measuring receiver shall be less than the maximum given in table 4.

Table 4: Maximum receiver bandwidths

Frequency being measured	Maximum measuring receiver bandwidth
$f < 1\,000\text{ MHz}$	100 - 120 kHz
$f \geq 1\,000\text{ MHz}$	1 MHz

7.6.3 Method of measurement conducted spurious emission

This method of measurement applies to transmitters having a permanent antenna connector:

- a) The transmitter shall be connected to a measuring receiver through a test load, 50 Ω power attenuator, and if necessary, an appropriate filter to avoid overloading of the measuring receiver. The bandwidth of the measuring receiver shall be set to a suitable value to correctly measure a spurious emission at a level 6 dB below the limit value given in table 5, see subclause 7.6.6. This bandwidth shall be recorded in the test report.

For the measurement of spurious emissions below the second harmonic of the carrier frequency the filter used shall be a high 'Q' (notch) filter centred on the transmitter carrier frequency and attenuating this signal by at least 30 dB.

For the measurement of spurious emissions at and above the second harmonic of the carrier frequency the filter used shall be a high pass filter with a stop band rejection exceeding 40 dB. The cut-off frequency of the high pass filter shall be approximately 1,5 times the transmitter carrier frequency.

Precautions may be required to ensure that harmonics of the carrier are not generated by the test load or attenuated by the high pass filter;

- b) the transmitter shall be unmodulated and operating at the maximum limit of its specified power range. If modulation cannot be inhibited then the test shall be carried out with modulation (see subclauses 6.1 and 6.2), and this fact shall be recorded in the test report;
- c) the frequency of the measuring receiver shall be adjusted over the frequency range 25 MHz to 20 GHz. The frequency and level of every spurious emission found shall be noted. The emissions within the channel occupied by the transmitter carrier and for channelled systems, its adjacent channels, shall not be recorded;
- d) if the measuring receiver has not been calibrated in terms of power level at the transmitter output, the level of any detected components shall be determined by replacing the transmitter by the signal generator and adjusting it to reproduce the frequency and level of every spurious emission noted in step c). The absolute power level of each of the emissions shall be noted;
- e) the frequency and level of each spurious emission measured and the bandwidth of the measuring receiver shall be recorded in the test report;
- f) if a user accessible power adjustment is provided then the tests in steps c) to e) shall be repeated at the lowest power setting available;
- g) the measurement in steps c) to f) shall be repeated with the transmitter in the standby condition if this option is available.

7.6.4 Method of measurement cabinet spurious radiation

This method of measurement applies to transmitters having a permanent antenna connector. For equipment without a permanent antenna connector, see subclause 7.6.5.

- a) A test site selected from annex A which fulfils the requirements of the specified frequency range of this measurement shall be used. The test antenna shall be oriented initially for vertical polarization and connected to a measuring receiver. The bandwidth of the measuring receiver shall be set to a suitable value to correctly measure a spurious emission at a level 6 dB below the limit value given in table 5, see subclause 7.6.6. This bandwidth shall be recorded in the test report.

The transmitter under test shall be placed on the support in its standard position, connected to an artificial antenna (see subclause 6.6) and switched on without modulation. If modulation cannot be inhibited then the test shall be carried out with modulation (see subclauses 6.1 and 6.2) and this fact shall be recorded in the test report.

- b) The radiation of any spurious emission shall be detected by the test antenna and measuring receiver over the frequency range 25 MHz to 20 GHz, except for the channel on which the transmitter is intended to operate and, for channelled systems, its adjacent channels. The frequency of each spurious emission detected shall be noted. If the test site is disturbed by interference coming from outside the site, this qualitative search may be performed in a screened room, with a reduced distance between the transmitter and the test antenna.
- c) At each frequency at which a emission has been detected, the measuring receiver shall be tuned and the test antenna shall be raised or lowered through the specified height range until the maximum signal level is detected on the measuring receiver.
- d) The transmitter shall be rotated through 360° about a vertical axis, to maximize the received signal.
- e) The test antenna shall be raised or lowered again through the specified height range until a maximum is obtained. This level shall be noted.
- f) The substitution antenna (see subclause A.2.3) shall replace the transmitter antenna in the same position and in vertical polarization. It shall be connected to the signal generator.
- g) At each frequency at which an emission has been detected, the signal generator, substitution antenna, and measuring receiver shall be tuned. The test antenna shall be raised or lowered through the specified height range until the maximum signal level is detected on the measuring receiver. The level of the signal generator giving the same signal level on the measuring receiver as in item e) above shall be noted. After corrections due to the gain of the substitution antenna and the cable loss between the signal generator and the substitution antenna, this level is the radiated spurious emission at this frequency.
- h) The frequency and level of each spurious emission measured and the bandwidth of the measuring receiver shall be recorded in the test report.
- j) Steps c) to h) shall be repeated with the test antenna oriented in horizontal polarization.
- k) If a user accessible power adjustment is provided then the tests in steps c) to h) shall be repeated at the lowest power setting available.

Steps c) to j) shall be repeated with the transmitter in the standby condition if this option is available.

7.6.5 Method of measurement radiated spurious emission

This method of measurement applies to transmitters having an integral antenna:

- a) A test site selected from annex A which fulfils the requirements of the specified frequency range of this measurement shall be used. The test antenna shall be oriented initially for vertical polarization and connected to a measuring receiver, through a suitable filter to avoid overloading of the measuring receiver if required. The bandwidth of the measuring receiver shall be set to a suitable value to correctly measure a spurious emission at a level 6 dB below the limit value given in table 5, see subclause 7.6.6. This bandwidth shall be recorded in the test report.

For the measurement of spurious emissions below the second harmonic of the carrier frequency the optional filter used shall be a high 'Q' (notch) filter centred on the transmitter carrier frequency and attenuating this signal by at least 30 dB.

For the measurement of spurious emissions at and above the second harmonic of the carrier frequency the optional filter used shall be a high pass filter with a stop band rejection exceeding 40 dB. The cut-off frequency of the high pass filter shall be approximately 1,5 times the transmitter carrier frequency.

The transmitter under test shall be placed on the support in its standard position and shall be switched on without modulation. If modulation cannot be inhibited then the test shall be carried out with modulation (see subclauses 6.1 and 6.2), and this fact shall be recorded in the test report.

- b) The same method of measurement as steps b) and k) of subclause 7.6.4 shall be used.

7.6.6 Limits

The power of any spurious emission shall not exceed the values given in table 5.

Table 5: Limits of radiated spurious emissions

State	47 to 74 MHz 87,5 to 118 MHz 174 to 230 MHz 470 to 862 MHz	Other frequencies ≤ 1 000 MHz	Frequencies > 1 000 MHz outside the assigned frequency band
Operating	4 nW	250 nW	1 μW
Standby	2 nW	2 nW	20 nW

8 Methods of measurement and limits for interrogator receiver parameters

All Track Unit (TU) receiver tests shall be referred to the antenna input terminal of the receiver. Where possible, the receiver measurements shall be made simultaneously with the transmitter in the transmit mode, without modulation.

Where required, all tests at extreme temperatures shall be tested to the temperature category declared by the manufacturer, see subclause 5.4.1.2.

The method of measurement using continuous bit streams should be used for all TU receiver tests of the present document. The specified nominal bit error ratio is 1×10^{-2} but to facilitate fast receiver measurements, a bit error ratio range of $0,5 \times 10^{-2}$ to 2×10^{-2} is used.

Alternatively, receiver measurements may be made using correctly-coded messages. The specified successful message ratio is 80 % over 20 message trials. The test procedure using messages may be used in special cases, e.g. to test a complete installed system. The method of measurement using messages is described in annex C. All receiver measurement refers to the input terminal of the receiver.

8.1 Maximum usable sensitivity

8.1.1 Definition

The maximum usable data sensitivity is the power, expressed in dBm, produced by a carrier at the nominal frequency of the receiver, modulated with the normal test signal (subclauses 6.1.1.1 and 6.1.1.2) which will, without interference, produce after demodulation a data signal with a specified bit error ratio or a specified successful message ratio.

8.1.2 Method of measurements under normal and extreme test conditions

Arrangements shall be made by the manufacturer to couple the equipment to the bit error ratio measuring device by a method which does not affect the radiated field see also subclauses 8.1.2.1, 8.1.2.2 and 8.1.2.3. An alternative method of measurement using messages is defined in annex C. During the receiver tests the transmitter shall be properly terminated.

8.1.2.1 Test arrangement for equipment with integral antenna

The test arrangement is different for normal and extreme test conditions.

a) normal test conditions:

- the test arrangement shown in figure 4 shall be used;

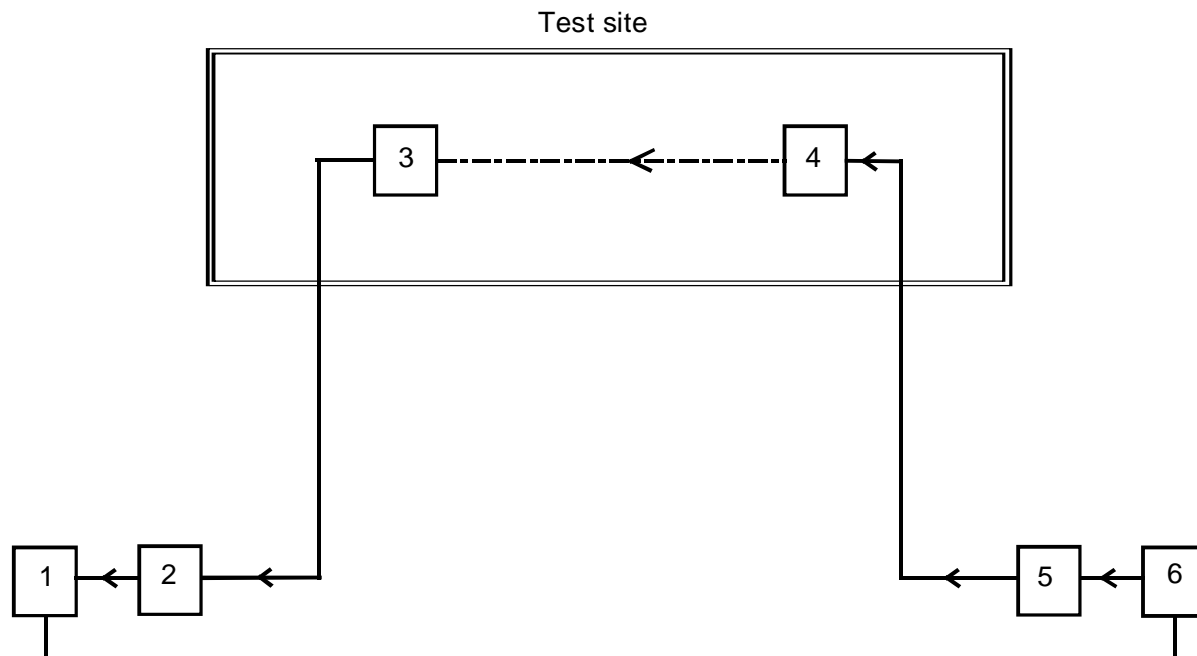

NOTE:

- 1 bit error ratio measuring test set;
- 2 photo detector/acoustic coupler;
- 3 receiver with integral antenna under test;
- 4 test antenna;
- 5 signal generator;
- 6 bit stream generator.

Figure 4: Receiver measurement arrangement for integral antenna (normal conditions)

A test site which fulfils the requirements for the specified frequency range of the measurement shall be used. The polarization of the test antenna shall match the requirement for the equipment antenna. The equipment under test shall be placed on the support in its standard position (see annex A).

b) extreme test conditions:

- the test arrangement shown in figure 5 shall be used.

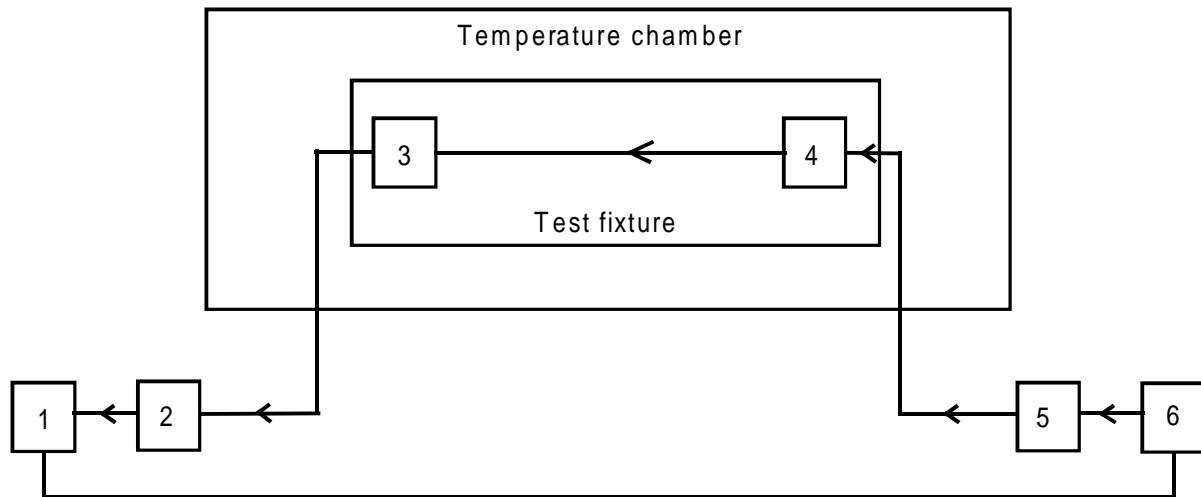

NOTE: 1 bit error ratio measuring test set;
 2 photo detector/acoustic coupler;
 3 receiver under test;
 4 test fixture RF coupler or antenna (see subclause 6.7);
 5 signal generator;
 6 bit stream generator.

Figure 5: Receiver measurement arrangement for integral antenna (extreme conditions)

The test antenna shall be terminated with a fixed attenuator to achieve proper termination of the signal generator. The distance between the test antenna and the equipment under test shall not be less than 80 cm. The polarization of the test antenna shall match the requirement for the equipment antenna. Only relative measurements are made during the extreme test conditions.

8.1.2.2 Test arrangement for equipment with antenna connector

The test arrangement shown in figure 6 shall be used during normal and extreme test conditions.

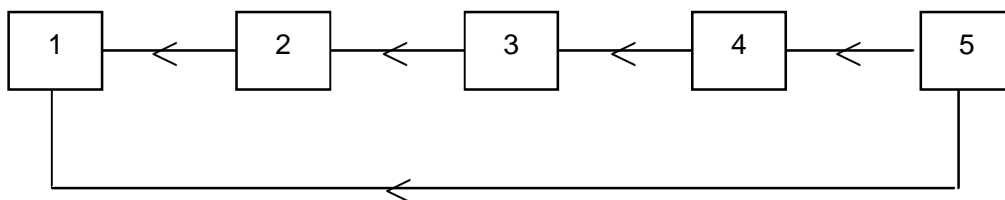

NOTE: 1 bit error ratio measuring test set;
 2 photo detector/acoustic coupler;
 3 receiver under test;
 4 signal generator;
 5 bit stream generator.

Figure 6: Receiver measurement arrangement for antenna connector

8.1.2.3 Test procedure for continuous bit streams

The following procedure shall apply:

- a) the signal generator shall be set to the nominal frequency of the Track Unit (TU) receiver and modulated with a normal test signal D-M2 (subclause 6.1.1.1);
- b) the level of the signal generator shall be adjusted until the bit error ratio is in the range $0,5 \times 10^{-2}$ to 2×10^{-2} . The signal generator level shall be recorded in the test report;
- c) steps a) and b) shall be repeated under extreme test conditions.

8.1.2.4 Test procedure for messages

For this measurement, the test laboratory may request the manufacturer to provide a test fixture. The fixture shall be capable of counting the number of transmitted messages, the number of received error messages and the number of correctly received messages. The necessary documentation and calibration shall be supplied with the test fixture. The test conditions for this procedure shall be agreed with the test laboratory.

The following procedure shall apply:

- a) the signal generator shall be set to the nominal frequency of the TU receiver and shall be modulated with a normal message test signal D-M3 (see subclause 6.1.1.2);
- b) the level of the signal generator shall be adjusted until the successful message ratio is 80 % for 20 messages. For further details, see annex C, clause C.3. The level of the signal generator shall be recorded in the test report;
- c) steps a) and b) shall be repeated under extreme test conditions.

8.1.3 Limits

Under normal test and extreme test conditions the maximum usable sensitivity shall not be greater than -84 dBm.

8.2 Error behaviour at high wanted input signals

8.2.1 Definition

This measures the receiver's capability to receive signals from the sensitivity level to a high signal level.

8.2.2 Method of measurement

The test arrangement shall be the same as that used for the measurement of maximum usable sensitivity (see subclauses 8.1.2.1, 8.1.2.2 and 8.1.2.3). The signal generator level is slowly increased and the bit error ratio or the successful message ratio is monitored until a point is reached where they are independent of the signal generator level.

The measuring procedure is dependent on the criteria chosen:

- a) for bit error measurements:
 - the signal generator shall be modulated with D-M2 test modulation;
 - the level of the signal generator shall be adjusted to +6 dB above the declared sensitivity point and the bit error ratio shall be measured and recorded in the test report;
 - the level of the signal generator shall be adjusted to -5 dBm and the bit error ratio shall be measured and recorded in the test report;
 - the measurements shall be repeated under extreme test conditions;

b) for measurements using messages:

- the signal generator shall be modulated with messages (D-M3 modulation);
- the level of the signal generator shall be adjusted to +6 dB above the declared sensitivity point and the successful message ratio shall be measured and recorded in the test report;
- the level of the signal generator shall be adjusted to -25 dBm;
- 4 000 messages shall be transmitted and the number of error messages shall be recorded. This test shall be repeated five times. The highest number of errors recorded from the five tests shall be the final figure recorded in the test report;
- the measurements shall be repeated under extreme conditions.

8.2.3 Limit

The limit under normal and extreme test conditions shall be either:

a) for bit error measurements:

- for signal generator level +6 dB above the declared sensitivity point the bit error ratio shall be less than 10^{-2} ;
- for signal generator level at -25 dBm for a bit error ratio shall be less than 10^{-6} ; or

b) for measurements using messages:

- for signal generator level +6 dB above the declared sensitivity point the successful message ratio shall be greater than 80 %;
- for signal generator level at -25 dBm there shall be less than two errors.

8.3 Degradation measurements

8.3.1 Definition

Degradation measurements are those measurements which are made on the receiver to establish the degradation of the performance of the receiver due to presence of unwanted interfering signals.

8.3.2 General conditions

The degradation measurements should be made at the antenna connector, or on a temporary antenna connector made for the test. For equipment with integral antenna where a permanent or temporary antenna can not be made available, the signal shall be coupled to the integral antenna via a test antenna as described in subclause 8.1.2.1.

All degradation measurements using bit streams shall be made with continuous bit stream modulation, D-M2, at the wanted channel. If the alternative method of measurement using message modulation is used, see annex C, measurements shall be made with message modulation, D-M4.

The necessary numbers of signal generators (2 or 3, as appropriate) shall be coupled via a combination network to provide simultaneous wanted and unwanted signals to the receiver:

- a) the level of each the signal generators shall be set to the sensitivity level of the receiver determined as described in subclause 8.1;
- b) the signal level of the wanted signal A shall be adjusted to a level +6 dB above the declared sensitivity;
- c) the level of the unwanted signal(s) B and C, unmodulated or modulated with appropriate modulation depending on the test, shall be increased until the normal criteria for bit error ratio or successful message ratio are achieved;
- d) the interfering generator level (point c)), or for some measurements the level difference between the interfering generator level and the declared sensitivity level (point a)), is the degradation rejection. This figure shall be recorded in the test report.

8.3.3 Co-channel rejection

8.3.3.1 Definition

The co-channel rejection is a measure of the capability of the receiver to receive a wanted modulated signal without exceeding a given degradation due to the presence of an unwanted signal, both being at the nominal frequency of the receiver.

8.3.3.2 Method of measurement

The test arrangement shown in figure 7 shall be used.

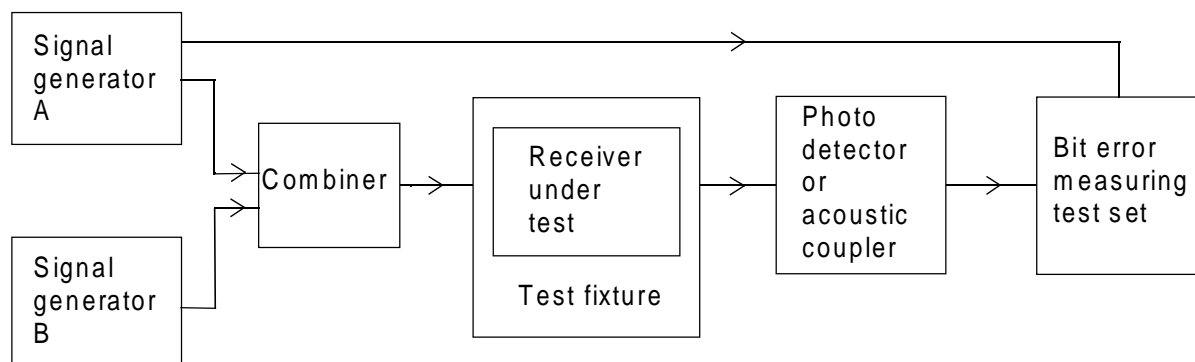

Figure 7: Measurement arrangement - co-channel rejection

- a) for equipment with permanent integral antenna the receiver antenna shall be coupled to the combiner via a test fixture as described in figure 4 (subclause 8.1.2.1) and subclause 6.7;
- b) for equipment with permanent or temporary antenna connector the combiner shall be connected directly to the equipment antenna connector.

With the general conditions as described in subclause 8.3.2:

- the frequency of signal generator A shall be tuned to the nominal frequency of the wanted signal;
- signal generator B shall be switched off;
- the level of the wanted signal, signal generator A, modulated with test modulation D-M2, shall be adjusted to a level +6 dB above the declared sensitivity of the receiver under test;
- signal generator B shall be switched on without modulation and tuned to the nominal frequency of the wanted signal. The level of signal generator B shall be increased until the receiver operates at a bit error ratio in the range $0,5 \times 10^{-2}$ to 2×10^{-2} ;
- the level difference between the signal generators A and B is the co-channel rejection.

8.3.3.3 Limit

The level for the co-channel rejection under normal test conditions shall be less than 12 dB.

8.3.4 Adjacent channel selectivity

8.3.4.1 Definition

The adjacent channel selectivity is a measure of the capability of the receiver to receive a wanted modulated signal without exceeding degradation due to the presence of an unwanted signal differing in frequency by an amount equal to the adjacent channel separation for which the equipment is intended.

8.3.4.2 Method of measurement

The test arrangement shown in figure 8 shall be used.

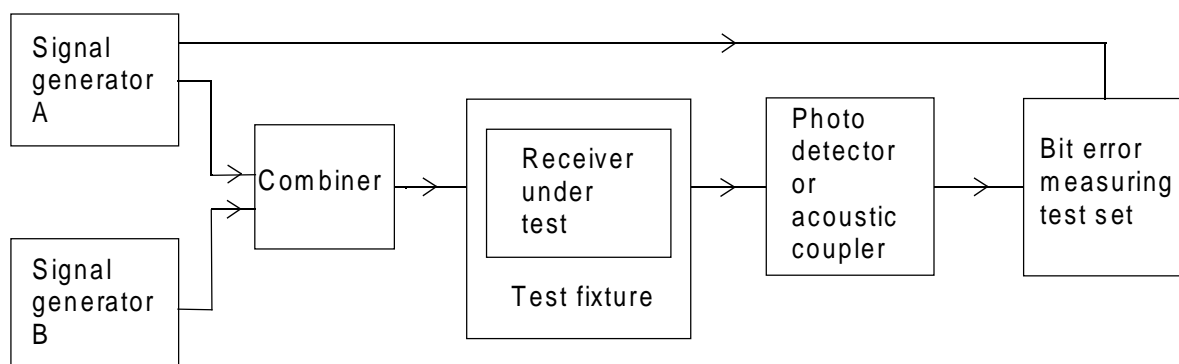

Figure 8: Measurement arrangement - adjacent channel selectivity

- for equipment with permanent integral antenna the receiver antenna shall be coupled to the combiner via a test fixture as described in subclause 8.1.2.1, figure 4 and subclause 6.7;
- for equipment with permanent or temporary antenna connector the combiner shall be connected directly to the equipment antenna connector.

With the general conditions as described in subclause 8.3.2:

- the frequency of signal generator A shall be tuned to the nominal frequency of the wanted signal;
- signal generator B shall be switched off;
- the level of the wanted signal, signal generator A, modulated with test modulation D-M2, shall be adjusted to a level +6 dB above the declared sensitivity of the receiver under test;
- the unwanted signal, signal generator B, modulated with test modulation D-M2', shall be switched on and tuned to one of the following test frequencies: $f_{TX} \pm 1,5 \text{ MHz}$;
- the level of signal generator B shall be increased until the receiver operates at a bit error ratio in the range of $0,5 \times 10^{-2}$ to 2×10^{-2} ;
- the output power of signal generator B is the adjacent channel selectivity and shall be recorded in the test report;
- the total procedure is repeated under extreme test conditions.

8.3.4.3 Limit

The adjacent channel selectivity at normal and extreme test conditions shall be greater than -30 dBm.

8.3.5 Spurious response rejection and desensitization

8.3.5.1 Definition

The spurious response rejection is a measure of the capability of the receiver to receive a wanted modulated signal without exceeding a given degradation due to the presence of an unwanted modulated signal at any other frequency outside ± 2 MHz from the transmit frequency at which a response is obtained. This definition also includes blocking/desensitization.

8.3.5.2 Method of measurement

The test arrangements shown in figure 9 shall be used.

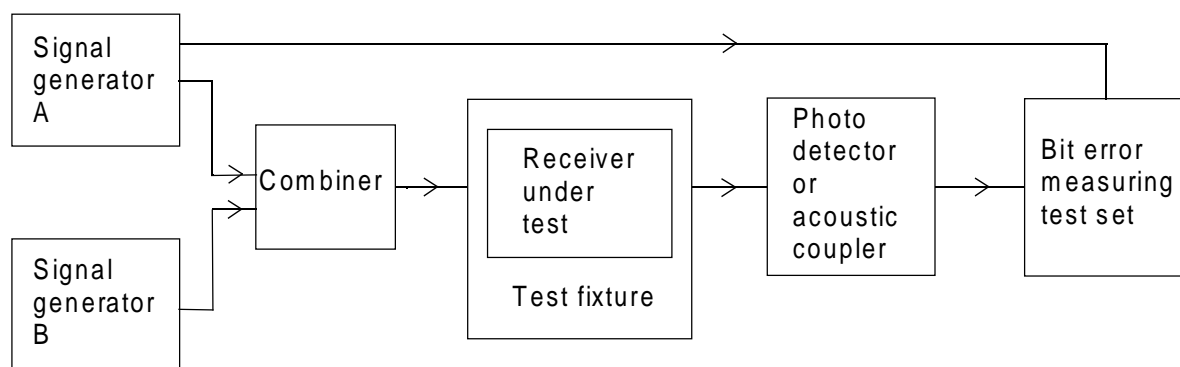

Figure 9: Measurement arrangement - spurious response rejection

- a) for equipment with permanent integral antenna the receiver antenna shall be coupled to the combiner via a test fixture as described in figure 4 (subclause 8.1.2.1) and subclause 6.7;
- b) for equipment with permanent or temporary antenna connector the combiner shall be connected directly to the equipment's antenna connector.

To facilitate the measurements an analogue access measuring point may be used, see subclause 6.4.

With the general conditions as described in subclause 8.3.2:

- signal generator A, shall be tuned to the nominal frequency of the receiver;
- the level of signal generator A, modulated with test modulation D-M2, shall be adjusted to a level +6 dB above at the declared sensitivity;
- signal generator B shall be switched on without modulation at a level of -10 dBm to -30 dBm, depending on frequencies indicated in subclause 8.3.5.3.
- the frequency of signal generator B shall be slowly tuned over the frequency range 25 MHz to 20 GHz, excluding the band 5 MHz either side of the nominal transmit carrier frequency. At each frequency where the wanted signal is degraded, the level of signal generator B shall be adjusted until the receiver operates at a bit error ratio in the range of $0,5 \times 10^{-2}$ to 2×10^{-2} . For each frequency where a degradation occurs, the corresponding level of signal generator B shall be recorded in the test report;
- the power level of signal generator B is the spurious response rejection.

Receiver spurious response rejection shall not be measured under extreme conditions.

8.3.5.3 Limits

The measured value for the receiver spurious response rejection and desensitization under normal test conditions shall not be less than the levels indicated in table 6:

Table 6: Limits for spurious response rejection and attenuation

Frequency of generator B	Level of generator B
25 MHz to $f_0 - 50$ MHz	-10 dBm
$f_0 - 50$ MHz to $f_0 - 5$ MHz	-30 dBm
$f_0 + 5$ MHz to $f_0 + 50$ MHz	-30 dBm
$f_0 + 50$ MHz to 20 GHz	-10 dBm

8.3.6 Intermodulation response rejection

8.3.6.1 Definition

The intermodulation response rejection is a measure of the capability of the receiver to receive a wanted modulated signal, without exceeding a given degradation due to the presence of two or more unwanted signals with a specific frequency relationship to the wanted signal frequency.

8.3.6.2 Method of measurement

The test arrangement shown in figure 10 shall be used:

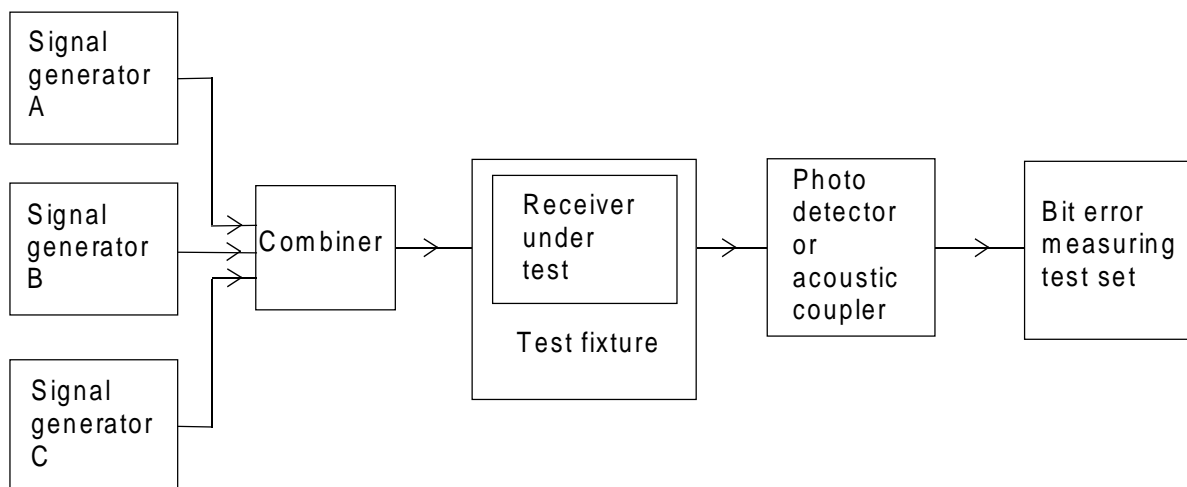

Figure 10: Measurement arrangement - intermodulation response rejection

- for equipment with permanent integral antenna the receiver antenna shall be coupled to the combiner via a test fixture as described in subclause 8.1.2.1, figure 4 and subclause 6.7;
- for equipment with permanent or temporary antenna connector the combiner shall be connected directly to the equipment antenna connector.

With the general conditions as described in subclause 8.3.2:

- signal generator A, shall be modulated with D-M2, and shall be tuned to the nominal frequency of the receiver. The output level shall be adjusted to +6 dB above the declared sensitivity of the receiver;
- the frequencies of the unwanted signal generators B and C shall be adjusted to +1,5 MHz and +3 MHz above the frequency of the nominal wanted signal respectively. Signal generator B shall be unmodulated and signal generator C shall be modulated with test modulation D-M2'. The output levels of signal generators B and C shall be kept equal and shall both be increased until the receiver is operating at a bit error ratio in the range $0,5 \times 10^{-2}$ to 2×10^{-2} ;
- the measurement shall be repeated with the unwanted signals at -1,5 MHz and -3 MHz relative to the wanted signal;
- the power level of signal generators B and C is the intermodulation response rejection;
- the measured levels shall be recorded in the test report.

Intermodulation response rejection shall not be measured under extreme conditions.

8.3.6.3 Limits

The measured value for intermodulation response rejection under normal test conditions shall be ≥ -30 dBm.

8.4 Spurious emissions

8.4.1 Definition

Spurious emissions from the receiver are components at any frequency, radiated by the equipment and antenna.

The level of spurious emissions shall be measured as either:

- a)
 - their power level in a specified load (conducted spurious emission); and
 - their effective radiated power when radiated by the cabinet and structure of the equipment (cabinet radiation);
- or
- b) their effective radiated power when radiated by the cabinet and the integral antenna.

Separate receiver radiated spurious measurements need not be made for co-located receiver and transmitters if the transmitter is operating at continuous duty.

8.4.2 Method of measurement - conducted spurious emissions

This method of measurement applies to receivers which have a permanent antenna connector.

A 50 Ω power attenuator may be used to protect the measuring receiver (see subclause 7.6.2) against damage when testing a receiver combined in one unit with a transmitter.

The measuring receiver used shall have sufficient dynamic range and sensitivity to achieve the required measurement accuracy at the specified limit. The resolution bandwidth shall be set to a suitable value to correctly measure a spurious emission at a level 6 dB below the limit value given in subclause 8.4.5.

This bandwidth shall be recorded in the test report.

The following procedure shall be followed:

- a) the input terminals of the receiver under test shall be connected to a measuring receiver having an input impedance of 50 Ω and the receiver under test shall be switched on;
- b) the frequency of the measuring receiver shall be adjusted over the frequency range 25 MHz to 20 GHz. The frequency and the absolute power level of each of the spurious emissions found shall be noted;
- c) if the detecting device is not calibrated in terms of power input, the level of any detected components shall be determined by replacing the receiver by a signal generator and adjusting the signal generator to reproduce the frequency and level of every spurious emission noted in step b). The absolute power level of each spurious emission shall be noted;
- d) the frequency and level of each spurious emission measured and the bandwidth of the measuring receiver shall be recorded in the test report.

8.4.3 Method of measurement - cabinet radiation

This method of measurement applies to receivers which have a permanent antenna connector:

- a) A test site selected from annex A which fulfils the requirements of the specified frequency range of this measurement shall be used. The test antenna shall be oriented initially for vertical polarization and connected to a measuring receiver. The bandwidth of the measuring receiver shall be set to a suitable value to correctly measure a spurious emission at a level 6 dB below the limit value given in subclause 8.4.5. This bandwidth shall be recorded in the test report.

The receiver under test shall be placed on the support in its standard position and connected to an artificial antenna, see subclause 6.6.

- b) The radiation of any spurious component shall be detected by the test antenna and measuring receiver over the frequency range 25 MHz to 20 GHz. The frequency of each spurious emission shall be noted. If the test site is disturbed by radiation coming from outside the site, this qualitative search may be performed in a screened room with a reduced distance between the transmitter and the test antenna;
- c) at each frequency at which an emission has been detected, the measuring receiver shall be tuned and the test antenna shall be raised or lowered through the specified height range until the maximum signal level is detected on the measuring receiver;
- d) the receiver shall be rotated up to 360° about a vertical axis, to maximize the received signal;
- e) the test antenna shall be raised or lowered again through the specified height range until a maximum is obtained. This level shall be noted;
- f) the receiver antenna shall be replaced with the substitution antenna (see annex A, subclause A.2.3) in the same position and in vertical polarization. The substitution antenna shall be connected to the signal generator;
- g) at each frequency at which an emission has been detected, the signal generator, substitution antenna and measuring receiver shall be tuned. The test antenna shall be raised or lowered through the specified height range until the maximum signal level is detected on the measuring receiver. The level of the signal generator giving the same signal level on the measuring receiver as in item e) shall be noted. This level, after correction due to the gain of the substitution antenna and the cable loss between the signal generator and the substitution antenna, is the level of the radiated spurious emission at this frequency;
- h) the frequency and level of each spurious emission measured and the bandwidth of the measuring receiver shall be recorded in the test report;
- j) measurements b) to h) shall be repeated with the test antenna oriented in horizontal polarization.

8.4.4 Method of measurement - radiated spurious components

This method of measurement applies to receivers which have an integral antenna.

- a) a test site selected from annex A which fulfils the requirements of the specified frequency range of this measurement shall be used. The test antenna shall be oriented initially for vertical polarization and connected to a measuring receiver. The bandwidth of the measuring receiver shall be set to a suitable value to correctly measure a spurious emission at a level 6 dB below the limit given in subclause 8.4.5. This bandwidth shall be recorded in the test report.

The receiver under test shall be placed on the support in its standard position.

- b) The same method of measurement as items b) to j) of subclause 8.4.3 shall apply.

8.4.5 Limit

The power of any spurious emission, outside the assigned frequency band, shall not exceed 2 nW in the range 25 MHz to 1 GHz and shall not exceed 20 nW on frequencies above 1 GHz.

9 Method of measurements and limits for transponders

9.1 Transponder sensitivity

9.1.1 Definition

The transponder sensitivity is the minimum level power density expressed in dBm that produces a wanted response from the transponder.

9.1.2 Method of measurement

The test arrangement shown in figure 11 shall be used:

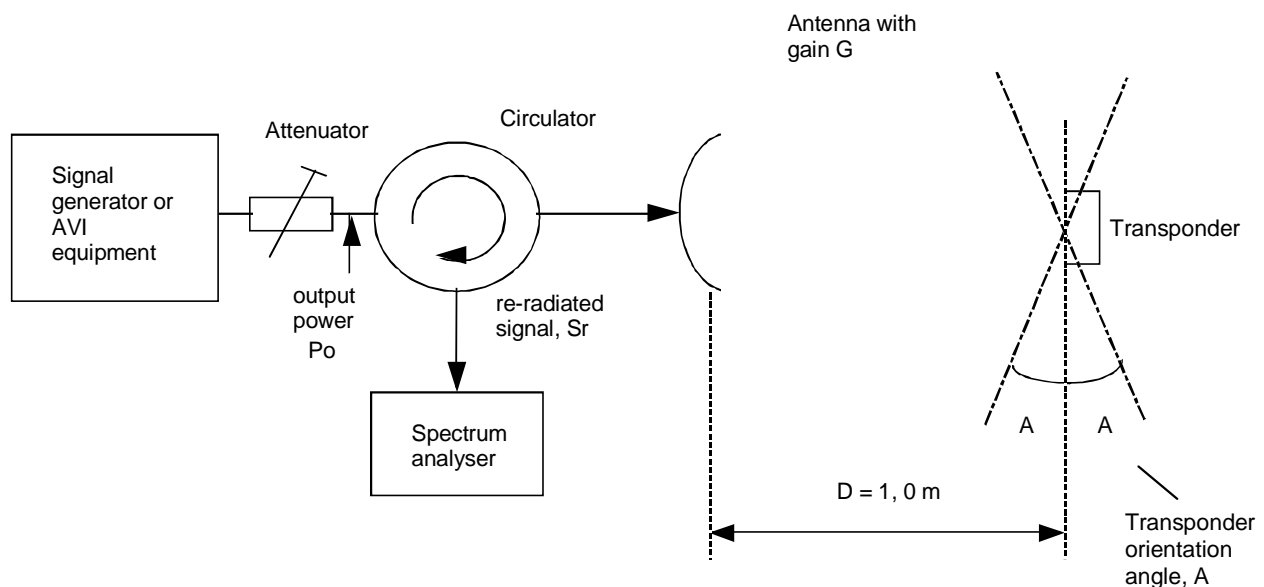

Figure 11: Measurement arrangement - transponder sensitivity

- a) the signal generator shall be unmodulated;
- b) during the measurements, the transponder orientation angle, α , shall be adjusted to:
 - $\pm 22,5^\circ$ angle to the normal to the width of the transponder; and
 - $\pm 60^\circ$ angle to the normal to the length of the transponder;
- c) the transponder response shall be monitored at the spectrum analyser;
- d) the output power P_O shall be reduced by increasing the attenuator in steps of 1 dB until the response of the transponder stops;
- e) the attenuation shall be increased by 1 dB within a time out period to be declared by the applicant;

NOTE 1: The transponder will start responding again.

- f) the output power P_O shall be measured with a spectrum analyser;
- g) the test shall be repeated with angle α adjusted to 0° (boresight).

The transponder sensitivity in dBm, P_{sens} , is calculated as:

$$P_{sens} = (\text{output power } P_O) + (\text{antenna gain } G) - (\text{circulator loss}) - (\text{propagation loss}).$$

The propagation loss is calculated as $20 \log(4\pi D) / \lambda$.

NOTE 2: At 2,45 GHz and a measuring distance $D = 1,0$ m the propagation loss is 40,3 dB.

9.1.3 Limit

The sensitivity of the transponder during normal and extreme test conditions shall be less the limits given in table 7.

Table 7: Transponder sensitivity limit

Transponder orientation	Normal test conditions	Extreme test conditions
$\leq \pm 22,5^\circ$	-35 dBm	-33 dBm
$\leq \pm 60^\circ$	-35 dBm	No requirement

9.2 Transponder wake-up protection

9.2.1 Definition

The transponder shall be designed to respond to appropriate signals only and shall wake up above a threshold RF field strength.

9.2.2 Method of measurement

The test arrangement in figure 12 shall be used for all transponder measurements:

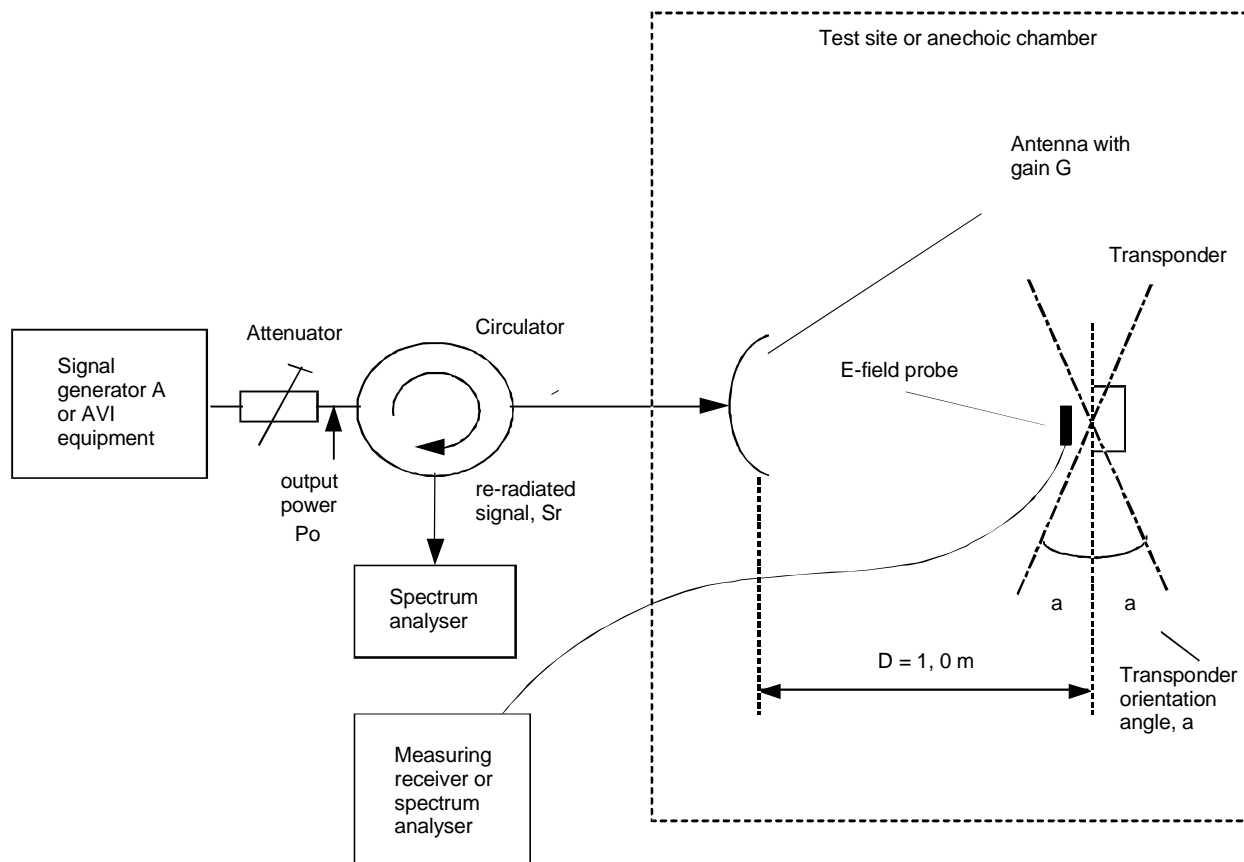

Figure 12: Test arrangement - transponder wake up

- for measurements at 2,45 GHz, the output power of signal generator A shall be adjusted to a level approximately 10 dB above the transponder sensitivity, see subclause 9.1;
- the orientation angle a shall be set to 0° ;
- the transponder response shall be monitored at the spectrum analyser;
- the above measurements shall be repeated in the presence of an unmodulated interference field at the spot frequencies in shown in table 8. Each interference signal shall be present more than 400 μ s.

Table 8: Interference test frequencies and levels

Frequency	100 MHz	250 MHz	900 MHz	1,8 GHz	5,8 GHz	7,5 GHz	12 GHz
Interference Field strength V/m	10	10	10	10	15	1,5	1,5

To set the interference frequency and field strength the following procedure shall be used:

- signal generator shall be adjusted to the specified frequency according to table 8;
- the output level of signal generator shall be adjusted to the required field strength according to table 8, by one of the following methods:
- either:
 - the transponder shall be replaced with a calibrated E-field probe;
 - the level of signal generator shall be adjusted until the specified E-field according to table 8 is measured on the E-field probe;
 - the E-field probe shall be replaced by the transponder and the interference measurement shall be performed;
- or:
 - the necessary interference power P_i shall be calculated by using the following formula:

$$P_i \text{ (dBm)} = 20\log E + 20\log d_2 - G_2 + 15,2$$

where:

- P_i is power in dBm into the interference antenna with gain;
- d_2 is the distance in metres between the reference antenna and the transponder;
- G_2 is the gain in dB of the interference antenna.

9.2.3 Limit

Under normal test conditions the transponder shall not respond to interference fields at spot frequencies defined in subclause 9.2.2.

9.3 Transponder conversion gain

9.3.1 Definition

The conversion gain is the difference between the transponder received and the re-radiated power.

9.3.2 Method of measurement

The test arrangement shall be as shown in subclause 9.1.2, figure 11. The procedure shall be as follows:

- a) before the measurements the transponder orientation angle α shall be adjusted to a 0° angle. The angle α shall be measured from the direction perpendicular to the intended direction of propagation;
- b) the output power level of the interrogator transmitter or the signal generator after the attenuator, P_o shall be adjusted to approximately 6 dB above the declared sensitivity level;
- c) the modulation of the interrogator transmitter or signal generator shall be switched off;
- d) the re-radiated signal, S_r of the upper sideband, is measured with the spectrum analyser adjusted to 1 MHz bandwidth;
- e) the output power P_o is measured with a spectrum analyser;

The Conversion Gain (CG) in dB at the upper side band is calculated as:

$$CG = (\text{re-radiated signal, } S_r) - 2 [(\text{antenna gain, } G) - (\text{propagation loss})] - P_o$$

The propagation loss shall be calculated according to subclause 9.1.2.

9.3.3 Limits

The conversion gain of the transponder during normal and extreme test conditions shall be higher than the values given in table 9.

Table 9: Transponder conversion gain

Transponder orientation	Normal test conditions	Extreme test conditions
In boresight	+5 dB	+2 dB

9.4 Transponder spurious radiation

9.4.1 Definition

The transponder spurious emissions are emissions at frequencies, other than those of the transponder and sidebands associated with normal modulation, radiated by the transponder.

The spurious radiations are specified as the radiated power of any discrete signal.

9.4.2 Method of measurement

The test arrangement is shown in subclause 9.1.2, figure 11. The procedure is as follows:

- the transponder orientation angle α shall be adjusted to 0° . The angle α is measured from the direction perpendicular to the intended direction of propagation;
- the output power level after the attenuator, P_o shall be adjusted to achieve a field strength of -14 dBm at the input of the transponder as measured with a 0 dBi antenna;
- the spurious emissions are measured according to annex B;
- the transponder spurious emissions are measured in the frequency range 25 MHz to 20 GHz. The measuring bandwidth shall adjusted to 100 kHz.

9.4.3 Limits

Under normal test conditions, the transponder spurious emissions shall be below the limit shown in table 10.

Table 10: Transponder spurious emission limits

State	25 MHz -1 GHz	Allocated Band (AB)	Other frequencies 1 GHz to 20 GHz except AB
Operating	-36 dBm	not applicable	-30 dBm
Stand-by	-57 dBm	-47 dBm	-47 dBm

10 Measurement uncertainty

The accumulated measurement uncertainties of the test system in use, for the parameters to be measured, should not exceed those given in table 11, to ensure that the measurements remain within an acceptable standard.

Table 11: Absolute measurement uncertainty

Parameter	Uncertainty
RF power (conducted)	±4 dB
RF frequency	±1 × 10 ⁻⁷
Radiated emission of transmitter, valid to 40 GHz	±6 dB
Adjacent channel power	±5 dB
Sensitivity	±5 dB
Two and three signal measurements	±4 dB
Two and three signal measurements using radiated fields	±6 dB
Radiated emission of receiver, valid to 20 GHz	±6 dB
Temperature	±1 C
Humidity	±5 %

For the test methods according to the present document the uncertainty figures are valid to a confidence level of 95 % calculated according to the methods described in ETR 028 [6].

Annex A (normative): Radiated measurements

A.1 Test sites and general arrangements for measurements involving the use of radiated fields

A.1.1 Outdoor test site

The outdoor test site shall be on a reasonably level surface or ground. At one point on the site, a ground plane of at least 5 m diameter shall be provided. In the middle of this ground plane, a non-conducting support, capable of rotation through 360° in the horizontal plane, shall be used to support the test sample in its standard position, at 1,5 m above the ground plane. The test site shall be large enough to allow the erection of a measuring or transmitting antenna at a distance of $\lambda/2$ or 3 m whichever is the greater. The distance actually used shall be recorded with the results of the tests carried out on the site.

Sufficient precautions shall be taken to ensure that reflections from extraneous objects adjacent to the site do not degrade the measurements results.

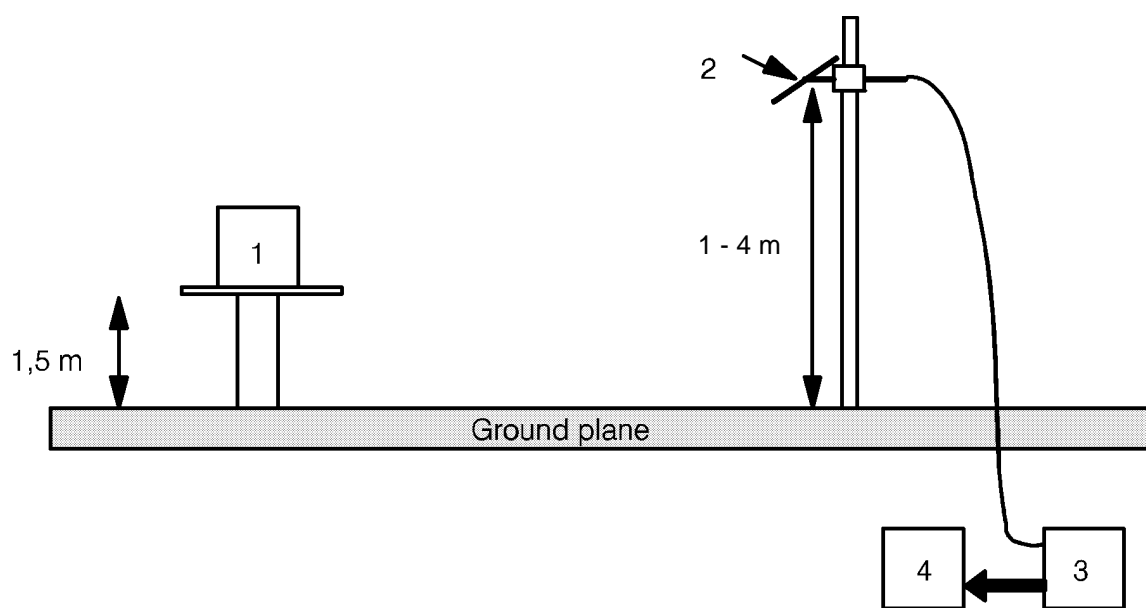

NOTE: 1 Equipment under test;
2 Test antenna;
3 High pass filter (may not be necessary);
4 Spectrum analyser or measuring receiver.

Figure A.1: Measuring arrangement

A.1.2 Standard position

The standard position in all test sites, shall be as follows:

- for equipment with integral antenna, it shall be placed in the position closest to normal use as declared by the manufacturer;
- for equipment with a rigid external antenna, the antenna shall be vertical;
- for equipment with non-rigid external antenna, the antenna shall be extended vertically upwards by a non-conducting support.

A.1.3 Test antenna

The test antenna is used to detect the radiation from the test sample, when the site is used for radiation measurements.

This antenna is mounted on a support such as to allow the antenna to be used in either horizontal or vertical polarization and for the height of its centre above ground to be varied over the range 1 to 4 m. Preferably a test antenna with pronounced directivity should be used. The size of the test antenna along the measurement axis shall not exceed 20 % of the measuring distance.

For receiver and transmitter radiation measurements, the test antenna is connected to a measuring receiver, capable of being tuned to any frequency under investigation and of measuring accurately the relative levels of signals at its input.

When measuring in the frequency range up to 1 GHz the test antenna shall be a $\lambda/2$ dipole, resonant at the operating frequency, or a shortened dipole, calibrated to the $\lambda/2$ dipole. When measuring in the frequency range above 4 GHz a horn radiator shall be used. For measurements between 1 and 4 GHz either a $\lambda/2$ dipole or a horn radiator may be used.

The distance between the lower extremity of the dipole and the ground shall not be less than 0,3 m.

NOTE: When measuring at 2,45 GHz, a horn antenna is recommended. The gain of a horn antenna is generally expressed relative to an isotropic radiator.

A.1.4 Optional additional indoor site

When the frequency of the signals being measured is greater than 80 MHz, use may be made of an indoor site. If this alternative site is used, this shall be recorded in the test report.

The measurement site may be a laboratory room with a minimum area of 6 m by 7 m and at least 2,7 m in height.

Apart from the measuring apparatus and the operator, the room shall be as free as possible from reflecting objects other than the walls, floor and ceiling.

The potential reflections from the wall behind the equipment under test are reduced by placing a barrier of absorbent material in front of it. The corner reflector around the test antenna is used to reduce the effect of reflections from the opposite wall and from the floor and ceiling in the case of horizontally polarized measurements. Similarly, the corner reflector reduces the effects of reflections from the side walls for vertically polarized measurements. For the lower part of the frequency range (below approximately 175 MHz) no corner reflector or absorbent barrier is needed. For practical reasons, the $\lambda/2$ antenna in figure A.2 may be replaced by an antenna of constant length, provided that this length is between $\lambda/4$ and λ at the frequency of measurement and the sensitivity of the measuring system is sufficient. In the same way the distance of $\lambda/2$ to the apex may be varied.

The test antenna and measuring receiver, are used in a way similar to that of the general method.

A.2 Guidance on the use of radiation test sites

For measurements involving the use of radiated fields, use may be made of a test site in conformity with the requirements of clause A.1. When using such a test site, the following conditions should be observed to ensure consistency of measuring results.

A.2.1 Measuring distance

Evidence indicates that the measuring distance is not critical and does not significantly affect the measuring results, provided that the distance is not less than $\lambda/2$ at the frequency of measurement, and the precautions described in this annex are observed. Measuring distances of 3, 5, 10 and 30 m are in common use in European test laboratories.

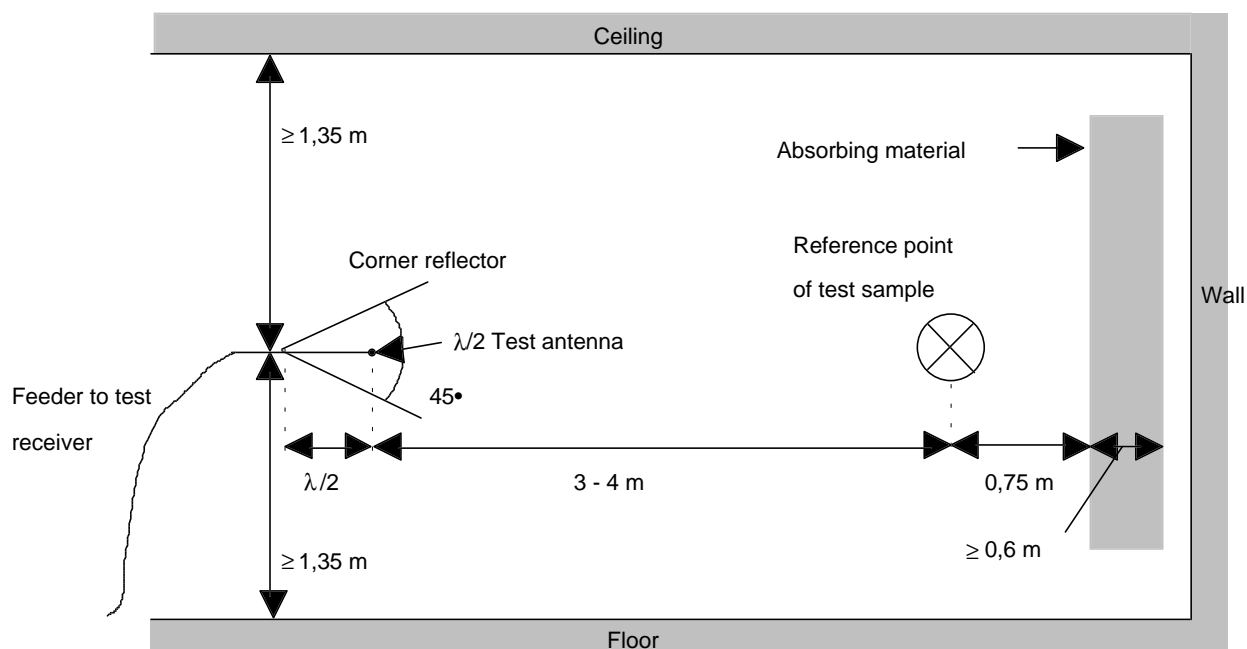

Figure A.2: Indoor site arrangement (shown for horizontal polarization)

A.2.2 Test antenna

Different types of test antenna may be used, since performing substitution measurements reduces the effect of the errors on the measuring results.

Height variation of the test antenna over a range of 1 m to 4 m is essential in order to find the point at which the radiation is a maximum.

Height variation of the test antenna may not be necessary at the lower frequencies below about 100 MHz.

A.2.3 Substitution antenna

The substitution antenna and signal generator is used to replace the equipment under test in substitution measurements. For measurements below 1 GHz the substitution antenna shall be half wavelength dipole resonant at the frequency under consideration, or a shortened dipole, calibrated to the half wavelength dipole. For measurements between 1 GHz and 4 GHz either a half wavelength dipole or a horn radiator may be used. For measurements above 4 GHz a horn radiator shall be used. The centre of this antenna shall coincide with the reference point of the test sample it has replaced. This reference point shall be the volume centre of the sample when its antenna is mounted inside the cabinet, or the point where an outside antenna is connected to the cabinet. The distance between the lower extremity of the dipole and the ground shall be at least 300 mm.

A.2.4 Auxiliary cables

The position of auxiliary cables (power supply, etc.) which are not adequately decoupled may cause variations in the measuring results. In order to get reproducible results, cables and wires of auxiliaries should be arranged vertically downwards (through a hole in the non conducting support).

A.3 Further optional alternative indoor test site using a fully anechoic RF chamber

For radiation measurements when the frequency of the signals being measured is greater than 30 MHz, use may be made of an indoor site being a well-shielded anechoic chamber simulating free space environment. If such a chamber is used, this shall be recorded in the test report.

The test antenna and measuring receiver, are used in a way similar to that of the general method, clause A.1. In the range between 30 MHz and 100 MHz some additional calibration may be necessary.

An example of a typical measurement site may be an electrically shielded anechoic chamber being 10 m long, 5 m broad and 5 m high. Walls and ceiling should be coated with RF absorbers of 1 m height. The base should be covered with absorbing material 1 m thick, and a wooden floor, able to carry test equipment and operators. A measuring distance of 3 m to 5 m in the long middle axis of the chamber can be used for measurements up to 12,75 GHz. For frequencies above 12,75 GHz the chamber may be used provided it has been calibrated for use at the frequency being measured. The construction of the anechoic chamber is described in the following clauses.

A.3.1 Example of the construction of a shielded anechoic chamber

Free-field measurements can be simulated in a shielded measuring chamber where the walls are coated with RF absorbers. Figure A.3 shows the requirements for shielding loss and wall return loss of such a room. As dimensions and characteristics of usual absorber materials are critical below 100 MHz (height of absorbers < 1 m, reflection attenuation < 20 dB) such a room is preferably suitable for measurements above 100 MHz. Figure A.4 shows the construction of a shielded measuring chamber having a base area of 5 m by 10 m and a height of 5 m.

Ceilings and walls are coated with pyramidal formed radio frequency absorbers approximately 1 m high or equivalent material with the same performance. The base is covered with absorbers which form a non-conducting sub-floor, or with special ground floor absorbers. The available internal dimensions of the room are 3 m × 8 m × 3 m, so that a measuring distance of maximum 5 m length in the middle axis of this room is available.

At 100 MHz the measuring distance can be extended up to a maximum of 2λ .

The floor absorbers reduce floor reflections so that the antenna height need not be changed and floor reflection influences need not be considered.

All measuring results can therefore be checked with simple calculations and the measurement uncertainties have the smallest possible values due to the simple measuring configuration.

A.3.2 Influence of parasitic reflections in anechoic chambers

For free-space propagation in the far field condition the correlation $E = E_0 \times (R_0/R)$ is valid for the dependence of the field strength E on the distance R , whereby E_0 is the reference field strength in the reference distance R_0 .

It is useful to use just this correlation for comparison measurements, as all constants are eliminated with the ratio and neither cable attenuation nor antenna mismatch or antenna dimensions are of importance.

Deviations from the ideal curve can be seen easily if the logarithm of the above equation is used, because the ideal correlation of field strength and distance can then be shown as a straight line and the deviations occurring in practice are clearly visible. This indirect method shows the disturbances due to reflections more readily and is far less problematical than the direct measurement of reflection attenuation.

With an anechoic chamber of the dimensions suggested in clause A.3 at low frequencies up to 100 MHz there are no far field conditions, and therefore reflections are stronger so that careful calibration is necessary. In the medium frequency range from 100 MHz to 1 GHz the dependence of the field strength on the distance meets the expectations very well. In the frequency range of 1 GHz to 40 GHz, because more reflections will occur, the dependence of the field strength on the distance will not correlate so closely.

A.3.3 Calibration of the shielded RF anechoic chamber

Calibration of the chamber shall be performed over the range 30 MHz to 40 GHz.

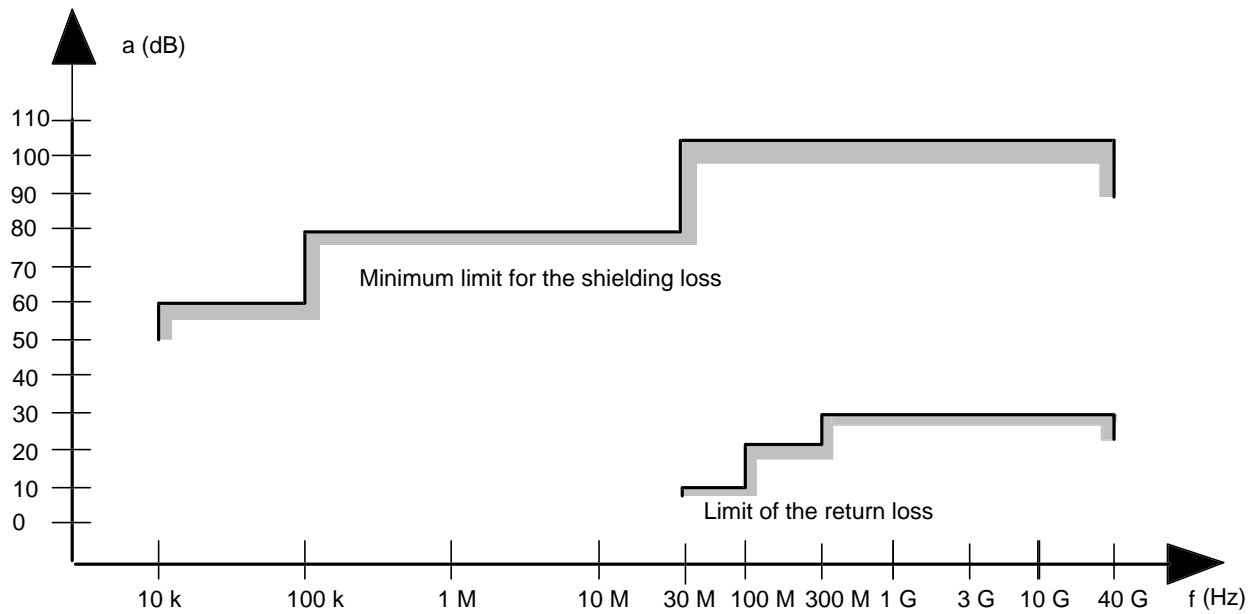

Figure A.3: Specification for shielding and reflections

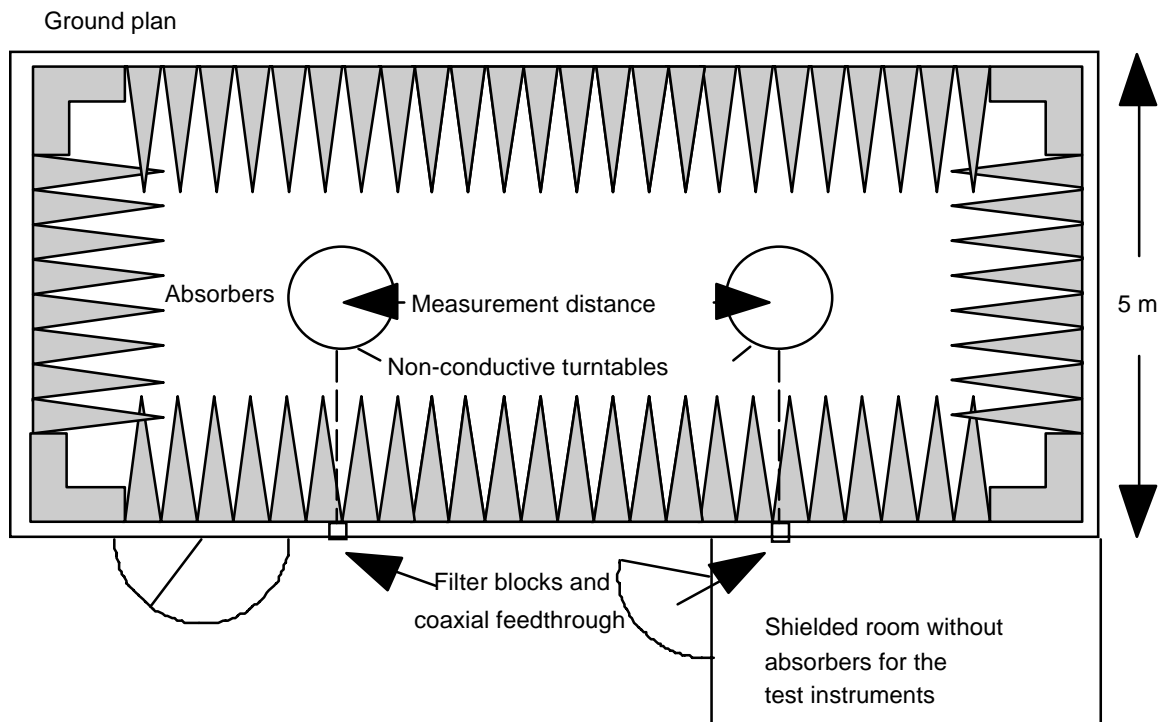
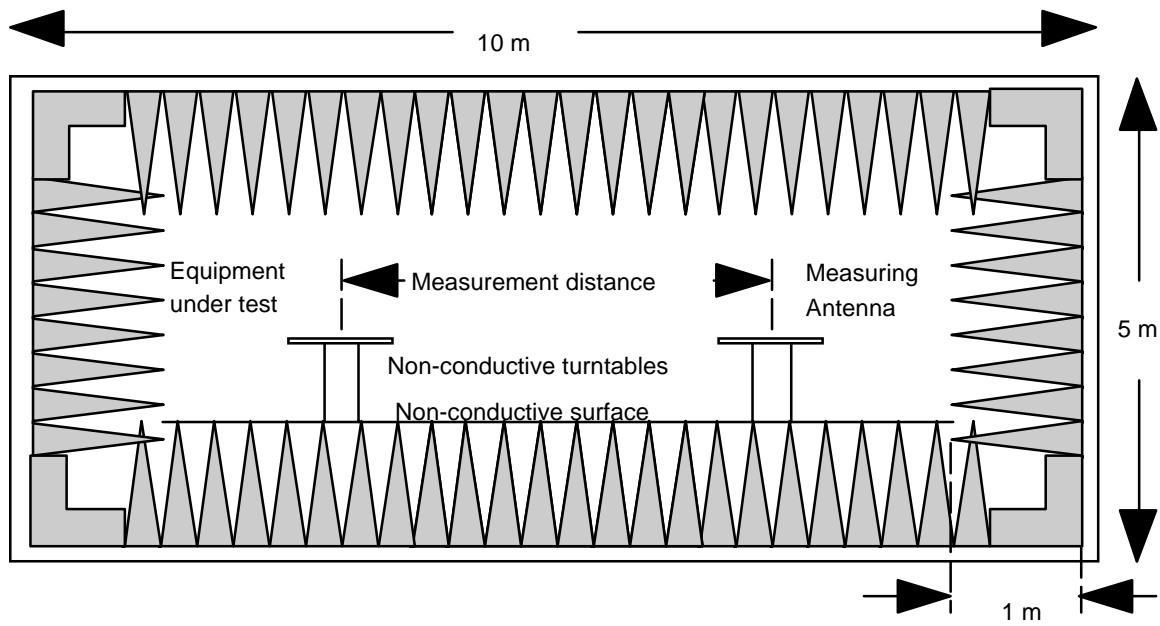

Figure A.4: Example of construction of an anechoic shielded chamber

Annex B (normative): General description of measurement methods

This annex gives the general methods of measurements for RF signals using the test sites and arrangements described in annex A. In addition, this annex gives a simple measurement method for radiated emissions based on a calculated rather than measured path loss.

B.1 Conducted measurements

In view of the low power levels of the equipment to be tested under the present document, conducted measurements may be applied to equipment provided with an antenna connector. Where the equipment to be tested does not provide a suitable termination, a coupler or attenuator that does provide the correct termination value shall be used.

The equivalent isotropically radiated power is then calculated from the measured value, the known antenna gain relative to an isotropic antenna and, if applicable, any losses due to cables and connectors in the measurement system.

B.2 Radiated measurements

Radiated measurements shall be performed with the aid of a test antenna and measurement receiver as described in annex A. The test antenna and measurement receiver, spectrum analyser or selective voltmeter, shall be calibrated according to the procedure defined in this annex. The equipment to be measured and the test antenna shall be oriented to obtain the maximum emitted power level. This position shall be recorded in the measurement report. The frequency range shall be measured in this position.

Radiated measurements should be performed in an anechoic chamber. For other test sites corrections may be needed (see annex A).

- a) a test site which fulfils the requirements of the specified frequency range of this measurement shall be used;
- b) the transmitter under test shall be placed on the support in its standard position (subclause A.1.2) and switched on;
- c) the test antenna shall be oriented initially for vertical polarization unless otherwise stated. The test antenna shall be raised or lowered, through the specified height range until the maximum signal level is detected on the measuring receiver.

The test antenna need not be raised or lowered if the measurement is carried out on a test site according to annex A, clause A.3.

- d) The transmitter shall be rotated through 360° about a vertical axis to maximize the received signal;
- e) the test antenna shall be raised or lowered again, if necessary, through the specified height range until a maximum is obtained. This level shall be recorded;
(This maximum may be a lower value than the value obtainable at heights outside the specified limits).
- f) this measurement shall be repeated for horizontal polarization;
- g) the substitution antenna shall replace the transmitter antenna in the same position and in vertical polarization. The frequency of the signal generator shall be adjusted to the transmitter (carrier) frequency;
- h) steps c) to f) shall be repeated;
- j) the input signal to the substitution antenna shall be adjusted in level until an equal or a known related level to that detected from the transmitter is obtained in the test receiver;

- k) this measurement shall be repeated with horizontal polarization;
- l) the radiated power is equal to the power supplied by the signal generator, increased by the known relationship if necessary and after corrections due to the gain of the substitution antenna and the cable loss between the signal generator and the substitution antenna.

Annex C (normative): Receiver methods of measurements using messages

C.1 General

The equipment may be tested by using messages when it is not possible to test with bit streams according to subclause 6.1.1.1. In this case the normal test signal shall be trains of correctly coded bits or messages modulation D-M4. Such messages can also be used for performance test of a total installed system.

C.2 Test signals

The normal test signals and modulations shall be obtained as follows:

- D-M3 corresponds to single messages, used for receiver measurements using the up-down method as described in clauses C.3 and C.4, triggered either manually or by an automatic testing system. This provides the "normal test signal" as required for receiver measurements (e.g. see subclauses 8.1.2.4 and 8.3);
- D-M4 consists of correctly coded signals, messages transmitted sequentially, one by one, without gaps between them;
- D-M4' consists of incorrectly coded signals, messages transmitted sequentially, one by one, without gaps between them.

D-M3 is used for receiver methods of measurement with messages where there is a need to transmit single messages a number of times (e.g. 20 times, see "normal test signal" of subclauses 8.3.3.2, 8.3.4.2, 8.3.5.2 and 8.3.6.2). The corresponding normal test modulation shall be agreed between the manufacturer and the test laboratory.

The test signal D-M4 is used for transmitter methods of measurement such as out of band power (subclause 7.3.2), radiated spurious emissions (subclauses 7.6.4 and 7.6.5) and interference test modulation during receiver degradation measurements (subclause 8.3). The test signals D-M4 and D-M4' shall be that, as agreed between the manufacturer and the test laboratory, which produces the greatest radio frequency occupied bandwidth.

The test signal D-M4' is used for test of transponder.

The encoder, which is associated with the transmitter, shall be capable of supplying the normal test modulation for D-M3, and the test signal D-M4. The details of D-M3, D-M4 and D-M4' shall be included in the test report.

C.3 Method of measurement for receiver sensitivity

The appropriate test arrangement as shown in subclause 8.1.2, figure 3, 4 or 5 shall be used with the exception that the bit stream generator and bit error ratio measuring devices are replaced by a message generator and a message detection indication device.

The following test procedure shall be used:

- a) the wanted signal, signal generator A, operating at the nominal frequency of the receiver shall be modulated with normal test signal D-M3 in accordance with the instructions of the manufacturer and shall be approved by the test laboratory;
- b) the level of the signal generator A shall be such that a successful message ratio is less than 10 %;
- c) the nominal modulation test signal shall be transmitted repeatedly whilst observing in each case whether or not a successful response is obtained. The level of signal generator A shall be increased by 2 dB for each occasion that a successful response is not obtained. The procedure shall be continued until three successful responses are obtained. The level of signal generator A shall be recorded;

- d) the level of signal generator A shall be reduced by 1 dB and the new value recorded. The normal modulation test signal shall be repeated 20 times. In each case, if a response is not obtained the signal generator level shall be increased by 1 dB and the new value recorded. If a successful response is obtained, the signal generator level shall not be changed until three consecutive successful responses have been obtained. In this case, the signal generator level shall be reduced by 1 dB and the new value recorded;

NOTE: No signal generator levels shall be recorded unless preceded by a change in level.

- e) the maximum usable sensitivity is the average of the values recorded in step c) and d);
f) the measurement shall be repeated under extreme test conditions.

The sensitivity shall be stated in the test report.

The limit for sensitivity is the same as for the continuous bit stream method of measurements, see subclause 8.1.3.

C.4 Method of measurements for receiver degradation

The appropriate test arrangement as shown in figure 7, 8, 9 or 10, subclause 8.3 shall be used with the following exception: the bit stream generator and bit error ratio measuring devices shall be replaced by a message generator and a message detection indication device.

The test procedure is the same as defined in subclause 8.3 except for the following:

- a) the modulation test signal for the wanted signal, signal generator A, shall be modulated with test signal D-M3;
b) the unwanted signal, signal generator B (and C, if appropriate), if modulated, shall be modulated with test signal D-M4;
c) the level of the unwanted signal, signal generator B (and C, if appropriate), shall be such that a successful message ratio is less than 10 %;
d) the nominal modulation test signal of the wanted signal, signal generator A, shall be transmitted repeatedly whilst observing in each case whether or not a successful response is obtained. The level of the unwanted signal, signal generator B (and C, if appropriate), shall be reduced by 2 dB for each occasion that a successful response is not obtained. The procedure shall be continued until three consecutive successful responses are obtained. The level of the signal generator B (and C, if appropriate) shall be recorded;
e) the level of unwanted signal, signal generator B (and C, if appropriate), shall be increased by 1 dB and the new value recorded. The normal test signal shall be repeated 20 times. In each case, if a response is not obtained, the signal generator level shall be reduced by 1 dB and the new value recorded. If a successful response is obtained, the signal generator level shall not be changed until three consecutive successful responses have been obtained. In this case, the signal generator level shall be increased by 1 dB and the new value recorded;

NOTE: No signal generator levels shall be recorded unless preceded by a change in level.

- f) the degradation level is the average value of the values recorded in step d) and e).

The degradation level shall be stated in the test report.

The limit value is identical with the limit for the continuous bit stream method of measurement, see subclauses 8.3.3.3, 8.3.4.3, 8.3.5.3 and 8.3.6.3.

Annex D (normative):

Subclauses of the present document relevant for compliance with the essential requirements EC Council Directives

Table D.1: Subclauses of the present document relevant for compliance with the essential requirements of EC Council Directives.

Clause/subclause number and title		Corresponding article of Council Directive 89/336/EEC	Qualifying remarks
7.6	Radiated spurious emissions	4(a)	Transmitters
8.3.5	Spurious response rejection and desensitization	4(b)	Receivers
8.4	Spurious emissions	4(a)	Receivers
9.4	Transponder spurious radiation	4(a)	Transponders

Annex E (informative): Bibliography

- UIC Specifications:
 - ERRI-A188/DT231 (1991): "Technical specification for Automatic Vehicle Identification (AVI)".
 - ERRI-A188/AHWG1/10.11.1994: "Automatic Vehicle Identification, UIC-Standard proposal".
 - ERRI A 188/1: "Automatic Vehicle Identification - Operating", February 1995.
 - UIC leaflet: "Automatic Vehicle Identification - AVI installation and Maintenance of the Transponders", February 1995.

History

Document history			
	November 1996	Public Enquiry	PE 118: 1996-11-18 to 1997-03-14
V1.1.1	August 1997	One-step Approval Procedure	OAP 9752: 1997-08-29 to 1997-12-26