

Draft **ETSI EN 300 698** V2.2.0 (2017-05)



**Radio telephone transmitters and receivers
for the maritime mobile service operating
in the VHF bands used on inland waterways;
Harmonised Standard covering the essential requirements
of articles 3.2 and 3.3(g) of Directive 2014/53/EU**

Reference

REN/ERM-TG26-534

Keywords

harmonised standard, maritime, radio, VHF

ETSI

650 Route des Lucioles
F-06921 Sophia Antipolis Cedex - FRANCE

Tel.: +33 4 92 94 42 00 Fax: +33 4 93 65 47 16

Siret N° 348 623 562 00017 - NAF 742 C
Association à but non lucratif enregistrée à la
Sous-Préfecture de Grasse (06) N° 7803/88

Important notice

The present document can be downloaded from:

<http://www.etsi.org/standards-search>

The present document may be made available in electronic versions and/or in print. The content of any electronic and/or print versions of the present document shall not be modified without the prior written authorization of ETSI. In case of any existing or perceived difference in contents between such versions and/or in print, the only prevailing document is the print of the Portable Document Format (PDF) version kept on a specific network drive within ETSI Secretariat.

Users of the present document should be aware that the document may be subject to revision or change of status.

Information on the current status of this and other ETSI documents is available at

<https://portal.etsi.org/TB/ETSI/DeliverableStatus.aspx>

If you find errors in the present document, please send your comment to one of the following services:

<https://portal.etsi.org/People/CommitteeSupportStaff.aspx>

Copyright Notification

No part may be reproduced or utilized in any form or by any means, electronic or mechanical, including photocopying and microfilm except as authorized by written permission of ETSI.

The content of the PDF version shall not be modified without the written authorization of ETSI.

The copyright and the foregoing restriction extend to reproduction in all media.

© European Telecommunications Standards Institute 2017.

All rights reserved.

DECT™, PLUGTESTS™, UMTS™ and the ETSI logo are Trade Marks of ETSI registered for the benefit of its Members.

3GPP™ and LTE™ are Trade Marks of ETSI registered for the benefit of its Members and of the 3GPP Organizational Partners.

oneM2M logo is protected for the benefit of its Members

GSM® and the GSM logo are Trade Marks registered and owned by the GSM Association.

Contents

Intellectual Property Rights	7
Foreword.....	7
Modal verbs terminology.....	7
1 Scope	8
2 References	8
2.1 Normative references	8
2.2 Informative references.....	8
3 Definitions, symbols and abbreviations	9
3.1 Definitions.....	9
3.2 Symbols.....	9
3.3 Abbreviations	9
4 General and operational requirements.....	9
4.0 Conformance	9
4.1 Construction	10
4.2 Controls and indicators.....	10
4.3 Handset and loudspeaker.....	11
4.4 Switching time.....	11
4.5 Safety precautions	11
4.6 Class of emission and modulation characteristics	12
4.7 Labelling.....	12
4.8 Warm up.....	12
5 Test conditions, power sources and ambient temperatures	12
5.1 Normal and extreme test conditions	12
5.2 Test power source.....	12
5.3 Normal test conditions.....	13
5.3.1 Normal temperature and humidity	13
5.3.2 Normal power sources	13
5.3.2.1 Mains voltage and frequency	13
5.3.2.2 Battery power source.....	13
5.3.2.3 Other power sources.....	13
5.4 Extreme test conditions	13
5.4.1 Extreme temperatures	13
5.4.2 Extreme values of test power sources	13
5.4.2.1 Mains voltage	13
5.4.2.2 Battery power source.....	13
5.4.2.3 Other power sources.....	13
5.5 Procedure for tests at extreme temperatures.....	14
6 General conditions of measurement	14
6.1 Arrangements for test signals applied to the receiver.....	14
6.2 Squelch.....	14
6.3 Normal test modulation	14
6.4 Artificial antenna.....	14
6.5 Arrangements for test signals applied to the transmitter	14
6.6 Tests on equipment with a duplex filter	15
6.7 Test channels	15
6.8 Transmission time limitation.....	15
6.9 Reference Bandwidths for emission measurements	15
7 Environmental tests	15
7.1 Introduction	15
7.2 Procedure.....	16
7.3 Performance check	16
7.4 Vibration.....	16

7.5	Damp heat cycle	17
8	Transmitter	17
8.0	General	17
8.1	Frequency error	17
8.1.1	Definition	17
8.1.2	Method of measurement	17
8.1.3	Limits	17
8.2	Carrier power	17
8.2.1	Definitions	17
8.2.2	Method of measurement	17
8.2.3	Limits	18
8.2.3.1	Normal test conditions	18
8.2.3.2	Extreme test conditions	18
8.3	Frequency deviation	18
8.3.1	Definition	18
8.3.2	The maximum frequency deviation at modulation frequencies below 3 kHz	18
8.3.2.1	Method of measurement	18
8.3.2.2	Limits	18
8.3.3	The maximum frequency deviation at modulation frequencies above 3 kHz	18
8.3.3.1	Method of measurement	18
8.3.3.2	Limits	19
8.4	Limitation characteristics of the modulator	19
8.4.1	Definition	19
8.4.2	Method of measurement	19
8.4.3	Limits	19
8.5	Sensitivity of the modulator, including microphone	20
8.5.1	Definition	20
8.5.2	Method of measurement	20
8.5.3	Limits	20
8.6	Audio frequency response	20
8.6.1	Definition	20
8.6.2	Method of measurement	20
8.6.3	Limit	20
8.7	Audio frequency harmonic distortion of the emission	21
8.7.1	Definition	21
8.7.2	Method of measurement	21
8.7.2.1	General	21
8.7.2.2	Normal test conditions	22
8.7.2.3	Extreme test conditions	22
8.7.3	Limit	22
8.8	Adjacent channel power	22
8.8.1	Definition	22
8.8.2	Method of measurement	22
8.8.3	Limits	22
8.9	Conducted spurious emissions conveyed to the antenna	23
8.9.1	Definition	23
8.9.2	Method of measurement	23
8.9.3	Limit	23
8.10	Residual modulation of the transmitter	23
8.10.1	Definition	23
8.10.2	Method of measurement	23
8.10.3	Limit	23
8.11	Transient frequency behaviour of the transmitter	23
8.11.1	Definitions	23
8.11.2	Method of measurement	24
8.11.3	Limits	25
8.12	Cabinet radiation and conducted spurious emissions other than those conveyed to the antenna	27
8.12.1	Definitions	27
8.12.2	Method of measurement	27
8.12.3	Limits	28

9	Receiver.....	28
9.1	Harmonic distortion and rated audio frequency output power	28
9.1.1	Definition.....	28
9.1.2	Method of measurement	28
9.1.3	Limits.....	29
9.2	Audio frequency response	29
9.2.1	Definition.....	29
9.2.2	Method of measurement	29
9.2.3	Limits.....	30
9.3	Maximum usable sensitivity.....	30
9.3.1	Definition.....	30
9.3.2	Method of measurement	31
9.3.3	Limits.....	31
9.4	Co-channel rejection.....	31
9.4.1	Definition.....	31
9.4.2	Method of measurement	31
9.4.3	Limit	31
9.5	Adjacent channel selectivity.....	31
9.5.1	Definition.....	31
9.5.2	Method of measurement	32
9.5.3	Limits.....	32
9.6	Spurious response rejection.....	32
9.6.1	Definition.....	32
9.6.2	Method of measurement	32
9.6.3	Limit	32
9.7	Intermodulation response	33
9.7.1	Definition.....	33
9.7.2	Method of measurement	33
9.7.3	Limit	33
9.8	Blocking or desensitization	33
9.8.1	Definition.....	33
9.8.2	Method of measurement	33
9.8.3	Limit	34
9.9	Conducted spurious emissions conveyed to the antenna.....	34
9.9.1	Definition.....	34
9.9.2	Method of measurement	34
9.9.3	Limit	34
9.10	Amplitude response of the receiver limiter	34
9.10.1	Definition.....	34
9.10.2	Method of measurement	34
9.10.3	Limit	34
9.11	Receiver noise and hum level.....	34
9.11.1	Definition.....	34
9.11.2	Method of measurement	35
9.11.3	Limit	35
9.12	Squelch operation.....	35
9.12.1	Definition.....	35
9.12.2	Method of measurement	35
9.12.3	Limits.....	35
9.13	Squelch hysteresis	36
9.13.1	Definition.....	36
9.13.2	Method of measurement	36
9.13.3	Limit	36
9.14	Radiated spurious emissions.....	36
9.14.1	Definition.....	36
9.14.2	Method of measurements.....	36
9.14.3	Limit	37
10	Duplex operation	37
10.0	Applicability.....	37
10.1	Receiver desensitization with simultaneous transmission and reception.....	37
10.1.1	Definition.....	37

10.1.2	Method of measurement	37
10.1.3	Limits.....	38
10.2	Receiver spurious response rejection	38
11	Testing for compliance with technical requirements.....	38
11.1	Environmental conditions for testing	38
11.2	Interpretation of the measurement results	38
Annex A (informative):	Relationship between the present document and the essential requirements of Directive 2014/53/EU	40
Annex B (normative):	Automatic Transmitter Identification System (ATIS)	42
B.1	System description	42
B.1.1	General	42
B.1.2	Technical requirements	42
B.1.3	Signal requirements	42
B.1.4	Format of an ATIS signal sequence	43
B.1.5	Dot pattern.....	44
B.1.6	Phasing	44
B.1.7	Format specifier.....	45
B.1.8	Identification	45
B.1.9	End of sequence	45
B.1.10	Error check character.....	45
B.1.11	Conversion of a call sign to MID	45
B.2	ATIS encoder	47
B.2.1	Internally generated signals	47
B.2.2	Frequency error (demodulated signal).....	47
B.2.2.1	Definition.....	47
B.2.2.2	Method of measurement	47
B.2.2.3	Limits.....	47
B.2.3	Modulation index	47
B.2.3.1	Definition.....	47
B.2.3.2	Method of measurement	47
B.2.3.3	Limits.....	47
B.2.4	Modulation rate	47
B.2.4.1	Definition.....	47
B.2.4.2	Method of measurement	48
B.2.4.3	Limits.....	48
B.2.5	Testing of the ATIS format	48
Annex C (informative):	Conversion of a radio call sign into an ATIS identification.....	49
Annex D (normative):	Measuring receiver for adjacent channel power measurement.....	50
D.1	Power measuring receiver specification.....	50
D.1.0	General	50
D.1.1	IF filter	50
D.1.2	Attenuation indicator.....	51
D.1.3	Rms value indicator.....	51
D.1.4	Oscillator and amplifier.....	51
Annex E (informative):	Change history	52
History		53

Intellectual Property Rights

IPRs essential or potentially essential to the present document may have been declared to ETSI. The information pertaining to these essential IPRs, if any, is publicly available for **ETSI members and non-members**, and can be found in ETSI SR 000 314: "*Intellectual Property Rights (IPRs); Essential, or potentially Essential, IPRs notified to ETSI in respect of ETSI standards*", which is available from the ETSI Secretariat. Latest updates are available on the ETSI Web server (<https://ipr.etsi.org>).

Pursuant to the ETSI IPR Policy, no investigation, including IPR searches, has been carried out by ETSI. No guarantee can be given as to the existence of other IPRs not referenced in ETSI SR 000 314 (or the updates on the ETSI Web server) which are, or may be, or may become, essential to the present document.

Foreword

This draft Harmonised European Standard (EN) has been produced by ETSI Technical Committee Electromagnetic compatibility and Radio spectrum Matters (ERM), and is now submitted for the combined Public Enquiry and Vote phase of the ETSI standards EN Approval Procedure.

The present document has been prepared under the Commission's standardisation request C(2015) 5376 final [i.4] to provide one voluntary means of conforming to the essential requirements of Directive 2014/53/EU on the harmonisation of the laws of the Member States relating to the making available on the market of radio equipment and repealing Directive 1999/5/EC [i.3].

Once the present document is cited in the Official Journal of the European Union under that Directive, compliance with the normative clauses of the present document given in tables A.1 and A.2 confers, within the limits of the scope of the present document, a presumption of conformity with the corresponding essential requirements of that Directive, and associated EFTA regulations.

Proposed national transposition dates	
Date of latest announcement of this EN (doa):	3 months after ETSI publication
Date of latest publication of new National Standard or endorsement of this EN (dop/e):	6 months after doa
Date of withdrawal of any conflicting National Standard (dow):	6 months after doa

Modal verbs terminology

In the present document "**shall**", "**shall not**", "**should**", "**should not**", "**may**", "**need not**", "**will**", "**will not**", "**can**" and "**cannot**" are to be interpreted as described in clause 3.2 of the [ETSI Drafting Rules](#) (Verbal forms for the expression of provisions).

"**must**" and "**must not**" are **NOT** allowed in ETSI deliverables except when used in direct citation.

1 Scope

The present document specifies technical characteristics and methods of measurements for VHF radio transmitters and receivers operating on board ships in frequency bands allocated to the maritime mobile service, used on inland waterways as defined by Regional Agreements or responsible Administrations.

The present document applies to VHF transmitters and receivers fitted with a 50 Ω external antenna socket or connector for use on board ships on inland waterways and operating in the bands between 156 MHz and 174 MHz allocated to the maritime mobile service by the ITU Radio Regulations [1], Appendix 18.

For countries where the Automatic Transmitter Identification System (ATIS) is mandatory, the requirements of annex B apply as well.

The present document covers the essential requirements of article 3.2 and art. 3.3(g) of Directive 2014/53/EU under the conditions identified in clause A.2.

2 References

2.1 Normative references

References are specific, identified by date of publication and/or edition number or version number. Only the cited version applies.

Referenced documents which are not found to be publicly available in the expected location might be found at <https://docbox.etsi.org/Reference/>.

NOTE: While any hyperlinks included in this clause were valid at the time of publication, ETSI cannot guarantee their long term validity.

The following referenced documents are necessary for the application of the present document.

- [1] ITU Radio Regulations (2016).
- [2] Recommendation ITU-T E.161 (2001): "Arrangement of digits, letters and symbols on telephones and other devices that can be used for gaining access to a telephone network".
- [3] ISO 25862:2009: "Ships and marine technology - Marine magnetic compasses, binnacles and azimuth reading devices".
- [4] Recommendation ITU-T O.41 (1994): "Psophometer for use on telephone-type circuits".

2.2 Informative references

References are either specific (identified by date of publication and/or edition number or version number) or non-specific. For specific references, only the cited version applies. For non-specific references, the latest version of the referenced document (including any amendments) applies.

NOTE: While any hyperlinks included in this clause were valid at the time of publication, ETSI cannot guarantee their long term validity.

The following referenced documents are not necessary for the application of the present document but they assist the user with regard to a particular subject area.

- [i.1] Recommendation ITU-R M.493-14 (2015): "Digital selective-calling system for use in the maritime mobile service".
- [i.2] ETSI TR 100 028-1: "Electromagnetic compatibility and Radio spectrum Matters (ERM); Uncertainties in the measurement of mobile radio equipment characteristics; Part 1".

- [i.3] Directive 2014/53/EU of the European Parliament and of the Council of 16 April 2014 on the harmonisation of the laws of the Member States relating to the making available on the market of radio equipment and repealing Directive 1999/5/EC.
- [i.4] Commission Implementing Decision C(2015) 5376 final of 4.8.2015 on a standardisation request to the European Committee for Electrotechnical Standardisation and to the European Telecommunications Standards Institute as regards radio equipment in support of Directive 2014/53/EU of the European Parliament and of the Council.
- [i.5] ETSI TR 100 028-2: "Electromagnetic compatibility and Radio spectrum Matters (ERM); Uncertainties in the measurement of mobile radio equipment characteristics; Part 2".
- [i.6] Recommendation ITU-R SM.332-4: "Selectivity of receivers".

3 Definitions, symbols and abbreviations

3.1 Definitions

For the purposes of the present document, the terms and definitions given in the ITU Radio Regulations [1] apply.

3.2 Symbols

For the purposes of the present document, the following symbols apply:

dBa Relative to 2×10^{-5} Pa

3.3 Abbreviations

For the purposes of the present document, the following abbreviations apply:

ad	amplitude difference
AIS	Automatic Identification System
ATIS	Automatic Transmitter Identification System
CSP	Channel Spacing
DSC	Digital Selective Calling
DX	first transmission
ECC	Error Correcting Code
emf	electromotive force
fd	frequency difference
MID	Maritime Identification Digit
RBW	Resolution Bandwidth
RF	Radio Frequency
rms	root mean square
RX	re-transmission
SINAD	Signal + Noise + Distortion/Noise + Distortion
VHF	Very High Frequency
VSWR	Voltage Standing Wave Ratio

4 General and operational requirements

4.0 Conformance

The manufacturer shall declare that compliance to the requirements of clause 4 is achieved and shall provide relevant documentation.

4.1 Construction

The mechanical and electrical construction and finish of the equipment shall conform in all respects to good engineering practice, and the equipment shall be suitable for use on board ships.

All controls shall be of sufficient size to enable the usual control functions to be easily performed and the number of controls should be the minimum necessary for simple and satisfactory operation.

For the purpose of conformance testing, relevant technical documentation shall be supplied with the equipment.

The VHF maritime mobile service uses both single-frequency and two-frequency channels. For two-frequency channels the Radio Regulations require a separation of 4,6 MHz between the transmitting frequency and the receiving frequency.

The equipment shall be capable of operating on single frequency and two-frequency channels with manual control (simplex). It may also be capable of operating on two-frequency channels without manual control (duplex).

No scanning or multiple watch facilities shall be implemented.

The equipment shall be able to operate on appropriate channels defined in the ITU Radio Regulations [1], Appendix 18.

Additional VHF channels outside those defined by the ITU Radio Regulations [1], Appendix 18 may also be provided, but means shall be provided to block any or all of these additional channels, as may be required by the licence before installation on board vessels. It shall not be possible for the user to unblock any blocked channels.

The equipment shall be so designed that use of channel 70 for purposes other than DSC is prevented, and that use of channels AIS1 and AIS2 for purposes other than AIS is prevented.

The possibility to apply automatic power reduction to any of these channels shall be available. It shall not be possible for the user to change the programmed settings of these channels.

The output power shall be automatically limited to a value between 0,5 W and 1 W on the following channels:

- 6, 8, 10, 11, 12, 13, 14, 15, 17, 71, 72, 74, 75, 76 and 77.

It shall not be possible to transmit while any frequency synthesizer used within the transmitter is out of lock.

It shall not be possible to transmit during channel switching operations.

Where equipment is capable of operating in modes other than just inland waterways then:

- when operating in "inland waterways" mode, all the requirements of the present document apply;
- when operating in other modes, the equipment shall comply with the requirements of the applicable standard for that mode of operation.

4.2 Controls and indicators

The equipment shall have a channel selector and shall indicate the designator, as shown in the ITU Radio Regulations [1], Appendix 18, of the channel at which the installation is set. The channel designator shall be legible irrespective of the external lighting conditions.

Channel 16 shall be distinctively marked. Selection of channel 16, shall be preferably by readily accessible means (e.g. a distinctively marked key). Selection of channel 16 by any means shall automatically set the transmitter output power to maximum. This power level may subsequently be reduced by manual user control if required.

Where an input panel on the equipment for entering the digits 0 - 9 is provided, this shall conform to Recommendation ITU-T E.161 [2].

The equipment shall have the following additional controls and indicators:

- an on/off switch for the entire installation with a visual indication that the installation is in operation;

- a manual non-locking push-to-talk switch to operate the transmitter with a visual indication that the transmitter is activated and facilities to limit the transmission time to a maximum of 5 min. A short audible alarm and a visual indication may be provided to show when the transmission will be automatically terminated within the next 10 s. It shall be possible to reoperate the push to talk switch and reactivate the transmitter after a 10 s period;
- a manual switch for reducing the transmitter output power to a value between 0,5 W and 1 W;
- an audio frequency power volume control not affecting the audio level of the handset;
- a squelch control;
- a control for reducing the brightness of the equipment illumination to zero;
- an output power detector giving a visual indication that the carrier is being produced.

The equipment shall also meet the following requirements:

- the user shall not have access to any control which, if wrongly set, might impair the technical characteristics of the equipment;
- if the accessible controls are located on a separate console and if there are two or more control consoles, one of the consoles shall have priority over the others. If there are two or more control consoles, the operation of one console shall be indicated on the other consoles.

4.3 Handset and loudspeaker

The equipment shall be fitted with an integral loudspeaker and/or a socket for an external loudspeaker and shall have the facility to be fitted with a telephone handset or a microphone.

During transmission in simplex operation the receiver output shall be muted.

During transmission in duplex operation, only the handset shall be operative. Measures shall be taken to ensure correct operation when duplex is used and precautions shall be taken to prevent harmful electrical or acoustic feedback which might produce oscillations.

4.4 Switching time

The channel switching arrangement shall be such that the time necessary to change over from using one of the channels to using any other channel does not exceed 5 s.

The time necessary to change over from transmission to reception or vice versa, shall not exceed 0,3 s.

4.5 Safety precautions

Measures shall be taken to protect the equipment against the effects of overcurrent or overvoltage.

Measures shall be taken to prevent damage to the equipment if the electrical power source produces transient voltage variations and to prevent any damage that might arise from an accidental reversal of polarity of the electrical power source.

Means shall be provided for earthing exposed metallic parts of the equipment.

All components and wiring in which the dc or ac voltage (other than radio-frequency voltage) produce, singly or in combination, peak voltages in excess of 50 V shall be protected against any accidental access and shall be automatically isolated from all electrical power sources if the protective covers are removed. Alternatively, the equipment shall be constructed in such a way as to prevent access to components operating at such voltages unless an appropriate tool is used such as a nut-spanner or screwdriver. Conspicuous warning labels shall be affixed both inside the equipment and on the protective covers.

No damage to the equipment shall occur when the antenna port is placed on open circuit or short circuit for a period of at least 5 minutes in each case.

In order to provide protection against damage due to the build-up of static voltages at the antenna port, there shall be a dc path from the antenna port to chassis not exceeding 100 k Ω .

The information in any volatile memory device shall be protected from interruptions in the power supply of up to 60 s duration.

4.6 Class of emission and modulation characteristics

The equipment shall use phase modulation, G3E (frequency modulation with a pre-emphasis of 6 dB/octave) for speech, and G2B for ATIS.

The equipment shall be designed to operate with a channel separation of 25 kHz.

The frequency deviation (G3E) corresponding to 100 % modulation shall be 5 kHz as nearly as practicable.

4.7 Labelling

All controls, instruments, indicators and ports shall be clearly labelled.

Details of the power supply from which the equipment is intended to operate shall be clearly indicated on the equipment.

The compass safe distance as defined in ISO 25862 [3] (Method B) shall be stated on the equipment or in the technical manual.

4.8 Warm up

After being switched on the equipment shall be operational within 1 minute.

5 Test conditions, power sources and ambient temperatures

5.1 Normal and extreme test conditions

Conformance tests shall be made under normal test conditions and also, where stated, under extreme test conditions (clauses 5.4.1 and 5.4.2 applied simultaneously).

5.2 Test power source

During conformance testing, the equipment shall be supplied from a test power source capable of producing normal and extreme test voltages as specified in clauses 5.3.2 and 5.4.2.

The internal impedance of the test power source shall be low enough for its effect on the test results to be negligible. For the purpose of testing the power source voltage shall be measured at the power input port of the equipment.

During testing, the power source voltages shall be maintained within a tolerance of ± 3 % relative to the voltage level at the beginning of each test.

5.3 Normal test conditions

5.3.1 Normal temperature and humidity

The normal temperature and humidity conditions for tests shall be a combination of temperature and humidity within the following ranges:

- temperature: +15 °C to +35 °C;
- relative humidity: 20 % to 75 %.

5.3.2 Normal power sources

5.3.2.1 Mains voltage and frequency

The normal test voltage for equipment to be connected to the ac mains shall be the nominal mains voltage. For the purpose of the present document, the nominal voltage shall be the declared voltage or any of the declared voltages for which the equipment is indicated as having been designed. The frequency of the test voltage shall be 50 Hz \pm 1 Hz.

5.3.2.2 Battery power source

Where the equipment is designed to operate from a battery, the normal test voltage shall be the nominal voltage of the battery.

5.3.2.3 Other power sources

For operation from other power sources the normal test voltage shall be that declared by the manufacturer.

5.4 Extreme test conditions

5.4.1 Extreme temperatures

For tests at extreme temperatures, measurements shall be made in accordance with clause 5.5, at a lower temperature of $-15\text{ °C} \pm 3\text{ °C}$ and an upper temperature of $+55\text{ °C} \pm 3\text{ °C}$.

5.4.2 Extreme values of test power sources

5.4.2.1 Mains voltage

The extreme test voltages for equipment to be connected to the ac mains shall be the nominal mains voltage $\pm 10\%$.

5.4.2.2 Battery power source

Where the equipment is designed to operate from a battery, the extreme test voltages shall be 1,3 and 0,9 times the nominal voltage of the battery (12 V, 24 V, etc.).

5.4.2.3 Other power sources

For operation from other power sources the extreme test voltages shall be agreed between the testing authority and the equipment manufacturer.

5.5 Procedure for tests at extreme temperatures

The equipment shall be placed in the test chamber at normal temperature. The maximum rate of raising or reducing the temperature of the chamber shall be 1 °C/minute. The equipment shall be switched off during the temperature stabilizing periods.

Before conducting tests at extreme temperatures, the equipment in the test chamber shall have reached thermal equilibrium and be subjected to the extreme temperature for a period of 10 hours to 16 hours.

For tests at the lower extreme temperature, the equipment shall then be switched on to standby or receive condition for one minute, after which the equipment shall meet the requirements of the present document.

For tests at the higher extreme temperature, the equipment shall then be switched on in the high power transmit condition for half an hour, after which the equipment shall meet the requirements of the present document.

The temperature of the chamber shall be maintained at the extreme temperatures for the whole duration of the performance test.

At the end of the test, with the equipment still in the chamber, the chamber shall be brought to normal temperature in not less than 1 hour. The equipment shall then be exposed to normal temperature and relative humidity for not less than 3 hours or until moisture has dispersed, whichever is the longer, before the next test is carried out. Alternatively, observing the same precautions, the equipment may be returned direct to the conditions required for the start of the next test.

6 General conditions of measurement

6.1 Arrangements for test signals applied to the receiver

Test signal sources shall be connected to the receiver antenna port in such a way that the impedance presented to the receiver antenna port is 50 Ω, irrespective of whether one or more test signals are applied to the receiver simultaneously.

The levels of the test signals shall be expressed in terms of the electromotive force (emf) at the terminals to be connected to the receiver.

The nominal frequency of the receiver is the carrier frequency of the selected channel.

6.2 Squelch

Unless otherwise specified, the receiver squelch facility shall be made inoperative for the duration of the conformance tests.

6.3 Normal test modulation

For normal test modulation, the modulation frequency shall be 1 kHz and the frequency deviation shall be 3 kHz.

6.4 Artificial antenna

When tests are carried out with an artificial antenna, this shall be a non-reactive, non-radiating 50 Ω load.

6.5 Arrangements for test signals applied to the transmitter

For the purpose of the present document, the audio frequency modulating signal applied to the transmitter shall be produced by a signal generator applied to the connection terminals replacing the microphone transducer.

6.6 Tests on equipment with a duplex filter

If the equipment has an integral duplex filter or a separate associated duplex filter, the characteristics of the present document shall be met, with the measurements carried out using the antenna port of the filter.

6.7 Test channels

Conformance tests shall be made on at least the highest frequency and the lowest frequency within the equipment's frequency band, and on channel 16.

6.8 Transmission time limitation

Unless otherwise specified, the transmitter push-to-talk timer shall be deactivated for test purposes.

6.9 Reference Bandwidths for emission measurements

The reference bandwidths used shall be as stated in tables 1 and 2.

Table 1: Reference bandwidths to be used for the measurement of spurious emission

Frequency range	RBW
9 kHz to 150 kHz	1 kHz
150 kHz to 30 MHz	10 kHz
30 MHz to 1 GHz	100 kHz
1 GHz to 12,75 GHz	1 MHz

Table 2: Reference bandwidths to be used close to the wanted emission for equipment operating below 1 GHz

Frequency offset from carrier	RBW
250 % of the CSP to 100 kHz	1 kHz
100 kHz to 500 kHz	10 kHz

7 Environmental tests

7.1 Introduction

The equipment shall be capable of continuous operation under the conditions of various sea states, vibration, humidity and change of temperature likely to be experienced in a ship in which it is installed.

7.2 Procedure

Environmental tests shall be carried out before any other tests of the same equipment in respect to the other requirements of the present document are performed.

Unless otherwise stated, the equipment shall be connected to an electrical power source during the periods for which it is specified that electrical tests shall be carried out. These tests shall be performed using normal test voltage.

7.3 Performance check

For the purpose of the present document, the term "performance check" shall be taken to mean a visual inspection that there is no visible damage or deterioration and the following measurements and limits:

- for the transmitter:
 - carrier frequency:
 - with the transmitter connected to an artificial antenna (see clause 6.4), the transmitter shall be tuned to channel 16 without modulation. The carrier frequency shall be within $\pm 1,5$ kHz of 156,8 MHz;
 - output power:
 - with the transmitter connected to an artificial antenna (see clause 6.4), the transmitter shall be tuned to channel 16. With the output powers switch set at maximum, the output power shall be between 6 W and 25 W;
- for the receiver:
 - maximum usable sensitivity:
 - the receiver shall be tuned to channel 16 and a test signal at the nominal frequency of the receiver modulated with normal test modulation (see clause 6.3) shall be applied. The level of the input signal shall be adjusted until the Signal + Noise + Distortion/Noise + Distortion (SINAD) at the output of the receiver is 20 dB and the output power is at least the rated output power (see clause 9.1). The level of the input signal shall be less than +12 dB μ V.

7.4 Vibration

The equipment complete with any shock and vibration absorbers with which it is provided, shall be clamped to the vibration table by its normal means of support and in its normal attitude. The equipment may be resiliently suspended to compensate for weight not capable of being withstood by the vibration table. Provision may be made to reduce or nullify any adverse effect on equipment performance which could be caused by the presence of any electromagnetic field due to the vibration unit.

The equipment shall be subjected to sinusoidal vertical vibration at all frequencies between:

- 2,5 Hz and up to 13,2 Hz with an excursion of ± 1 mm, ± 10 % (7 m/s² maximum acceleration at 13,2 Hz);
- above 13,2 Hz and up to 100 Hz with a constant maximum acceleration of 7 m/s².

The frequency sweep rate shall be slow enough to allow the detection of resonances in any part of the equipment.

A resonance search shall be carried out throughout the test. If any resonance of the equipment has a $Q > 5$ measured relative to the bed of the vibration table, the equipment shall be subjected to a vibration endurance test at each resonant frequency at the vibration level specified in the test with a duration of not less than 2 hours. If no such resonance occurs, the endurance test shall be carried out at a frequency of 30 Hz.

Performance checks shall be carried out throughout the test period.

The procedure shall be repeated with vibration in each of two mutually perpendicular directions in the horizontal plane.

7.5 Damp heat cycle

The equipment shall be placed in a chamber at normal room temperature and relative humidity. Then the temperature shall be raised to $+40\text{ °C} \pm 2\text{ °C}$ and the relative humidity raised to $93\% \pm 3\%$ over a period of 3 hours $\pm 0,5$ hours.

These conditions shall be maintained for a period of 10 hours to 16 hours.

After this period the equipment shall be switched on and shall be kept operational for at least 2 hours. In the last 30 minutes of this test the equipment shall be subjected to a performance check.

The temperature and relative humidity of the chamber shall be maintained as specified during the whole test period.

At the end of this test, with the equipment still in the chamber, the chamber shall be brought to room temperature in not less than 1 hour.

8 Transmitter

8.0 General

All tests on the transmitter shall be carried out with the output power switch set at its maximum except where otherwise stated.

8.1 Frequency error

8.1.1 Definition

The frequency error is the difference between the measured carrier frequency and its nominal value.

8.1.2 Method of measurement

The carrier frequency shall be measured in the absence of modulation, with the transmitter connected to an artificial antenna (see clause 6.4). Measurements shall be made under normal test conditions (see clause 5.3) and under extreme test conditions (clauses 5.4.1 and 5.4.2 applied simultaneously).

This test shall be carried out with the output power switch being set at both maximum and minimum.

8.1.3 Limits

The frequency error shall be within $\pm 1,5\text{ kHz}$.

8.2 Carrier power

8.2.1 Definitions

The carrier power is the mean power delivered to the artificial antenna during one radio frequency cycle in the absence of modulation.

The rated output power is the carrier power declared by the manufacturer.

8.2.2 Method of measurement

The transmitter shall be connected to an artificial antenna (see clause 6.4) and the power delivered to this artificial antenna shall be measured. The measurements shall be made under normal test conditions (see clause 5.3) and under extreme test conditions (clauses 5.4.1 and 5.4.2 applied simultaneously).

8.2.3 Limits

8.2.3.1 Normal test conditions

The carrier power measured under normal test conditions with the output power switch set at maximum, shall remain between 6 W and 25 W.

With the output power switch set at minimum, or when the power is reduced automatically, the carrier power shall remain between 0,5 W and 1 W.

8.2.3.2 Extreme test conditions

With the output power switch set at maximum, the carrier power shall remain between 6 W and 25 W and be within +2 dB, -3 dB of the rated output power under extreme conditions.

With the output power switch set at minimum, or when the power is reduced automatically, the carrier power shall remain between 0,5 W and 1 W.

8.3 Frequency deviation

8.3.1 Definition

The frequency deviation is the difference between the instantaneous frequency of the modulated radio frequency signal and the carrier frequency.

8.3.2 The maximum frequency deviation at modulation frequencies below 3 kHz

8.3.2.1 Method of measurement

The frequency deviation shall be measured at the output with the transmitter connected to an artificial antenna (see clause 6.4), by means of a deviation meter capable of measuring the maximum deviation, including that due to any harmonics and intermodulation products which may be generated in the transmitter.

The modulation frequency shall be varied between 100 Hz and 3 kHz. The level of this test signal shall be 20 dB above the level which produces normal test modulation (see clause 6.3). This test shall be carried out with the output power switch set at both maximum and minimum.

8.3.2.2 Limits

The maximum frequency deviation shall not exceed ± 5 kHz.

8.3.3 The maximum frequency deviation at modulation frequencies above 3 kHz

8.3.3.1 Method of measurement

The transmitter shall operate under normal test conditions (see clause 5.3) connected to an artificial antenna as specified in clause 6.4. The transmitter shall be modulated by the normal test modulation (see clause 6.3). With the input level of the modulation signal being kept constant, the modulation frequency shall be varied between 3 kHz and 25 kHz and the frequency deviation shall be measured.

8.3.3.2 Limits

For modulation frequencies between 3 kHz and 6 kHz the frequency deviation shall not exceed the frequency deviation with a modulation frequency of 3 kHz. For a modulation frequency of 6 kHz, the frequency deviation shall not exceed $\pm 1,5$ kHz, as shown in figure 1.

For modulation frequencies between 6 kHz and 25 kHz, the frequency deviation shall not exceed that given by a linear response of frequency deviation (in dB) against modulation frequency, starting at the point where the modulation frequency is 6 kHz and the frequency deviation is $\pm 1,5$ kHz and inclined at 14 dB per octave, with the frequency deviation diminishing as the modulation frequency increases, as shown in figure 1.

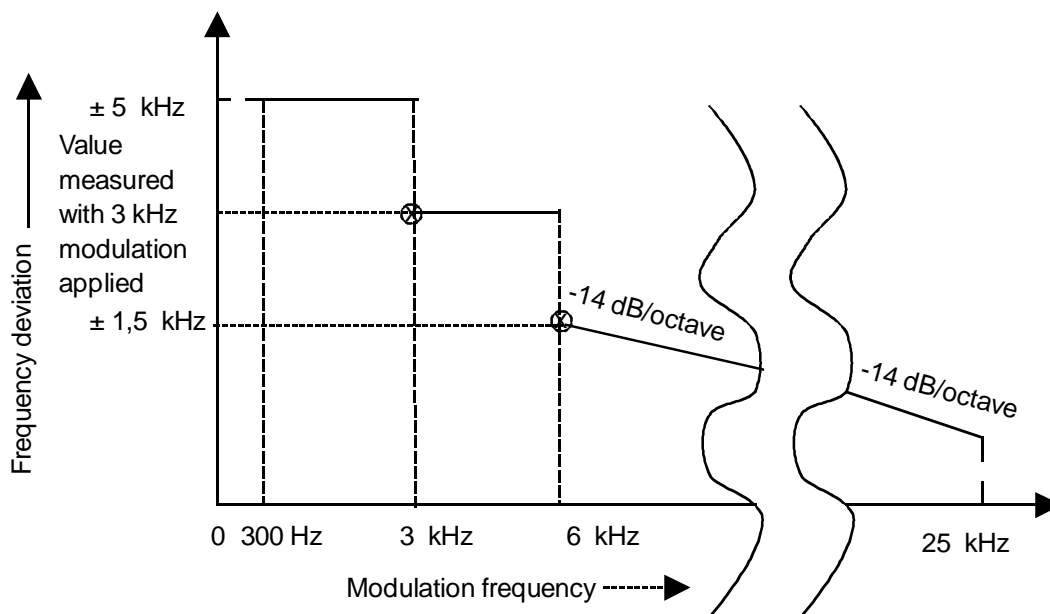

Figure 1: Frequency deviation limits

8.4 Limitation characteristics of the modulator

8.4.1 Definition

This characteristic expresses the capability of the transmitter of being modulated with a deviation approaching the maximum deviation specified in clause 8.3.2.

8.4.2 Method of measurement

A modulation signal at a frequency of 1 kHz shall be applied to the transmitter, and its level adjusted so that the frequency deviation is ± 1 kHz. The level of the modulation signal shall then be increased by 20 dB and the deviation shall again be measured. This test shall be conducted under normal test conditions (see clause 5.3) and under extreme test conditions (clauses 5.4.1 and 5.4.2 applied simultaneously).

This test shall be carried out with the output power switch being set at both maximum and minimum.

8.4.3 Limits

The frequency deviation shall be contained between $\pm 3,5$ kHz and ± 5 kHz (see figure 1).

8.5 Sensitivity of the modulator, including microphone

8.5.1 Definition

This characteristic expresses the capability of the transmitter to produce sufficient modulation when an audio frequency signal corresponding to the normal mean speech level is applied to the microphone.

8.5.2 Method of measurement

A 25 kHz channel shall be selected and the transmitter activated. An acoustic signal with a frequency of 1 kHz and sound level of 94 dBA shall be applied to the microphone. The resulting deviation shall be measured.

8.5.3 Limits

The resulting frequency deviation shall be between $\pm 1,5$ kHz and ± 3 kHz.

8.6 Audio frequency response

8.6.1 Definition

The audio frequency response is the frequency deviation of the transmitter as a function of the modulation frequency.

8.6.2 Method of measurement

A modulation signal at a frequency of 1 kHz shall be applied to the transmitter and the deviation shall be measured at the output. The audio input level shall be adjusted so that the frequency deviation is ± 1 kHz. This is the reference point in figure 2 (1 kHz corresponds to 0 dB).

The modulation frequency shall then be varied between 300 Hz and 3 kHz, with the level of the audio frequency signal being kept constant and equal to the value specified above.

8.6.3 Limit

The audio frequency response shall be within +1 dB and -3 dB of a 6 dB/octave line passing through the reference point (see figure 2).

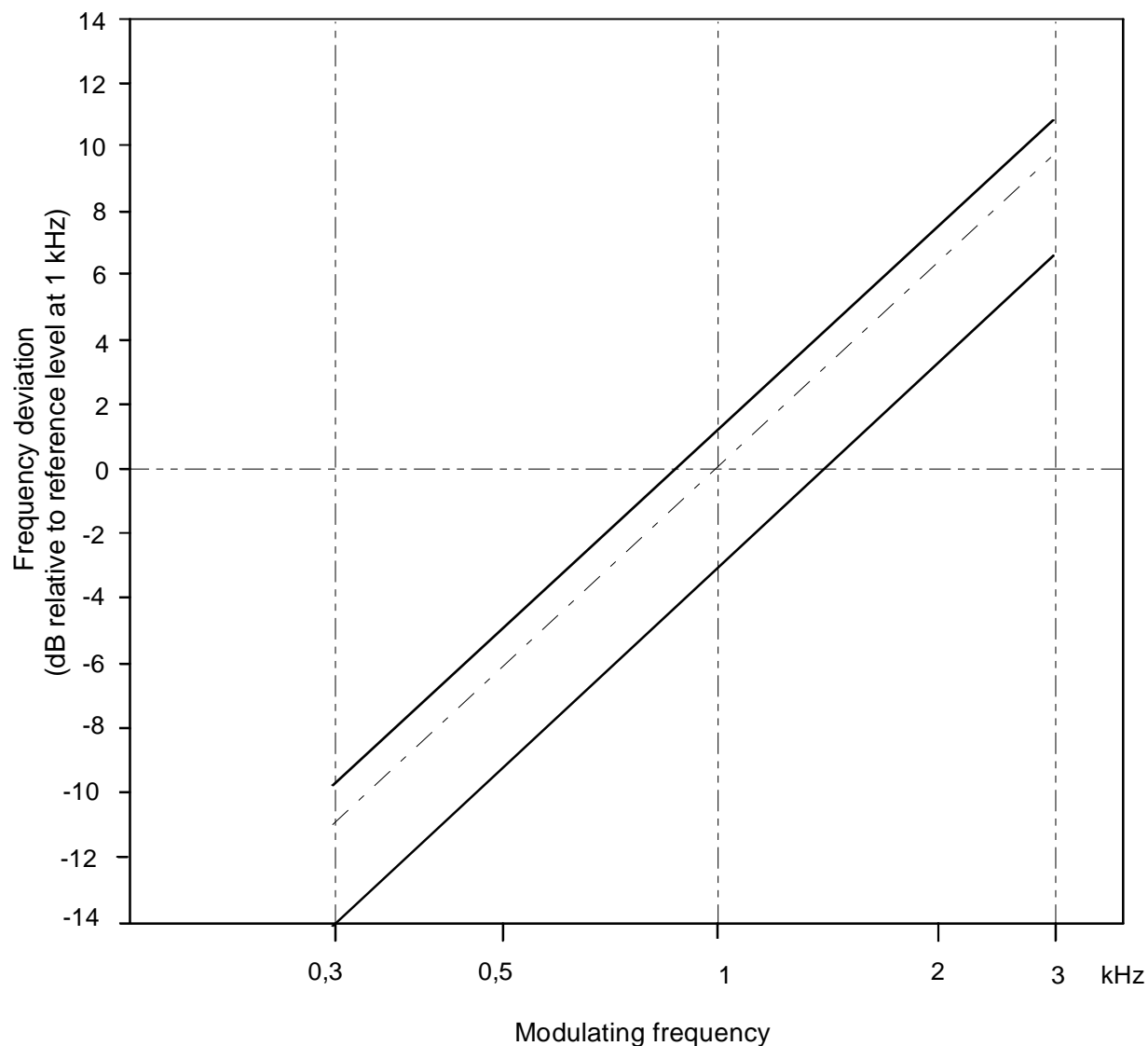

Figure 2: Audio frequency response

8.7 Audio frequency harmonic distortion of the emission

8.7.1 Definition

The harmonic distortion of the emission modulated by an audio frequency signal is defined as the ratio, expressed as a percentage, of the root mean square (rms) voltage of all the harmonic components of the fundamental frequency to the total rms voltage of the signal after linear demodulation.

8.7.2 Method of measurement

8.7.2.1 General

The RF signal produced by the transmitter shall be applied via an appropriate coupling device to a linear demodulator with a de-emphasis network of 6 dB per octave. This test shall be carried out with the output power switch set at maximum.

8.7.2.2 Normal test conditions

Under normal test conditions (see clause 5.3) the RF signal shall be modulated successively at frequencies of 300 Hz, 500 Hz and 1 kHz with a constant modulation index of 3.

The distortion of the audio frequency signal shall be measured at all the frequencies specified above.

8.7.2.3 Extreme test conditions

Under extreme test conditions (clauses 5.4.1 and 5.4.2 applied simultaneously), the measurements shall be carried out with the RF signal modulated at 1 kHz with a frequency deviation of ± 3 kHz.

8.7.3 Limit

The harmonic distortion shall not exceed 10 %.

8.8 Adjacent channel power

8.8.1 Definition

The adjacent channel power is that part of the total power output of a transmitter under defined conditions of modulation, which falls within a specified passband centred on the nominal frequency of either of the adjacent channels. This power is the sum of the mean power produced by the modulation, hum and noise of the transmitter.

8.8.2 Method of measurement

The adjacent channel power shall be measured with a power measuring receiver which conforms to annex D, further referred to as the "receiver":

- a) the transmitter shall be operated at the carrier power determined in clause 8.2 under normal test conditions. The antenna port of the transmitter shall be linked to the input of the "receiver" by a connecting device such that the impedance presented to the transmitter is 50Ω and the level at the "receiver" input is appropriate;
- b) with the transmitter unmodulated, the tuning of the "receiver" shall be adjusted so that a maximum response is obtained. This is the 0 dB response point. The "receiver" attenuator setting and the reading of the meter shall be recorded;

the measurement may be made with the transmitter modulated with normal test modulation, in which case this fact shall be recorded with the test results;
- c) the tuning of the "receiver" shall be adjusted away from the carrier so that the "receiver" -6 dB response nearest to the transmitter carrier frequency is located at a displacement from the nominal carrier frequency of 17 kHz;
- d) the transmitter shall be modulated with 1,25 kHz at a level which is 20 dB higher than that required to produce ± 3 kHz deviation;
- e) the "receiver" variable attenuator shall be adjusted to obtain the same meter reading as in step b) or a known relation to it;
- f) the ratio of adjacent channel power to carrier power is the difference between the attenuator settings in steps b) and e), corrected for any differences in the reading of the meter;
- g) the measurement shall be repeated with the "receiver" tuned to the other side of the carrier.

8.8.3 Limits

The adjacent channel power shall not exceed a value of 70 dB below the carrier power of the transmitter without any need to be below $0,2 \mu\text{W}$.

8.9 Conducted spurious emissions conveyed to the antenna

8.9.1 Definition

Conducted spurious emissions are emissions on a frequency or frequencies which are outside the necessary bandwidth and the level of which may be reduced without affecting the corresponding transmission of information. Spurious emissions include harmonic emissions, parasitic emissions, intermodulation products and frequency conversion products, but exclude out of band emissions.

8.9.2 Method of measurement

Conducted spurious emissions shall be measured with the unmodulated transmitter connected to the artificial antenna (see clause 6.4).

The measurements shall be made over a range from 9 kHz to 2 GHz, excluding the channel on which the transmitter is operating and its adjacent channels.

The measurements for each spurious emission shall be made using a tuned radio measuring instrument or a spectrum analyser.

8.9.3 Limit

The power of any spurious emission on any discrete frequency shall not exceed 0,25 μ W.

8.10 Residual modulation of the transmitter

8.10.1 Definition

The residual modulation of the transmitter is the ratio, in dB, of the demodulated RF signal in the absence of wanted modulation, to the demodulated RF signal produced when the normal test modulation is applied.

8.10.2 Method of measurement

The normal test modulation defined in clause 6.3 shall be applied to the transmitter. The RF signal produced by the transmitter shall be applied, via an appropriate coupling device, to a linear demodulator with a de-emphasis network of 6 dB per octave. The time constant of this de-emphasis network shall be at least 750 μ s.

Precautions shall be taken to avoid the effects of emphasizing the low audio frequencies produced by internal noise.

The signal shall be measured at the demodulator output using an rms voltmeter.

The modulation shall then be switched off and the level of the residual audio frequency signal at the output shall be measured again.

8.10.3 Limit

The residual modulation shall not exceed -40 dB.

8.11 Transient frequency behaviour of the transmitter

8.11.1 Definitions

The transient frequency behaviour of the transmitter is the variation in time of the transmitter frequency difference from the nominal frequency of the transmitter when the RF output power is switched on and off.

The following time period are defined:

- t_{on} : according to the method of measurement described in clause 8.11.2 the switch-on instant t_{on} of a transmitter is defined by the condition when the output power, measured at the antenna port, exceeds 0,1 % of the nominal power;
- t_1 : period of time starting at t_{on} and finishing according to table 3;
- t_2 : period of time starting at the end of t_1 and finishing according to table 3;
- t_{off} : switch-off instant defined by the condition when the nominal power falls below 0,1 % of the nominal power;
- t_3 : period of time that finishing at t_{off} and starting according to table 3.

Table 3: Tx switching timing

t_1 (ms)	5,0
t_2 (ms)	20,0
t_3 (ms)	5,0

8.11.2 Method of measurement

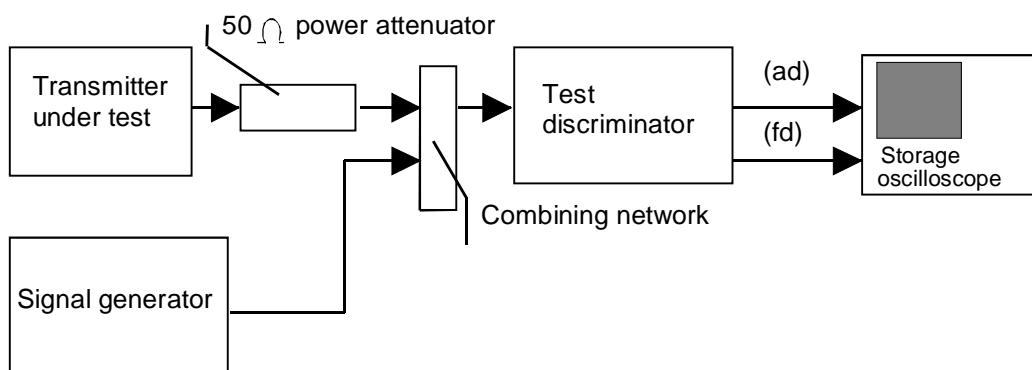

Figure 3: Measurement arrangement

The following method of measurement shall be used:

- two signals shall be connected to the test discriminator via a combining network (see clause 6.1) as shown in figure 3;
- the transmitter shall be connected to a 50 Ω power attenuator;
- the output of the power attenuator shall be connected to the test discriminator via one input of the combining network;
- a test signal generator shall be connected to the second input of the combining network;
- the test signal shall be adjusted to the nominal frequency of the transmitter;
- the test signal shall be modulated by a frequency of 1 kHz with a deviation of 25 kHz;
- the test signal level shall be adjusted to correspond to 0,1 % of the power of the transmitter under test measured at the input of the test discriminator. This level shall be maintained throughout the measurement;
- the amplitude difference (ad) and the frequency difference (fd) output of the test discriminator shall be connected to a storage oscilloscope;
- the storage oscilloscope shall be set to display the channel corresponding to the (fd) input up to ± 1 channel frequency difference, corresponding to the relevant channel separation, from the nominal frequency;

- the storage oscilloscope shall be set to a sweep rate of 10 ms/division and set so that the triggering occurs at 1 division from the left edge of the display;
- the display will show the 1 kHz test signal continuously;
- the storage oscilloscope shall then be set to trigger on the channel corresponding to the amplitude difference (ad) input at a low input level, rising;
- the transmitter shall then be switched on, without modulation, to produce the trigger pulse and a picture on the display;
- the result of the change in the ratio of power between the test signal and the transmitter output will, due to the capture ratio of the test discriminator, produce two separate sides on the picture, one showing the 1 kHz test signal, the other the frequency difference of the transmitter versus time;
- the moment when the 1 kHz test signal is completely suppressed is considered to provide t_{on} ;
- the periods of time t_1 and t_2 as defined in table 1 shall be used to define the appropriate template as shown in figure 4;
- the transmitter shall remain switched on;
- the storage oscilloscope shall be set to trigger on the channel corresponding to the amplitude difference (ad) input at a high input level, decaying and set so that the triggering occurs at 1 division from the right edge of the display;
- the transmitter shall then be switched off;
- the moment when the 1 kHz test signal starts to rise is considered to provide t_{off} ;
- the period of time t_3 as defined in the table shall be used to define the appropriate template as shown in figure 4.

8.11.3 Limits

The results shall be recorded as frequency difference versus time.

During the periods of time t_1 and t_3 the frequency difference shall not exceed ± 25 kHz.

The frequency difference, after the end of t_2 , shall be within the limit of the frequency error, see clause 8.1.

During the period of time t_2 the frequency difference shall not exceed $\pm 12,5$ kHz.

Before the start of t_3 the frequency difference shall be within the limit of the frequency error, (see clause 8.1).

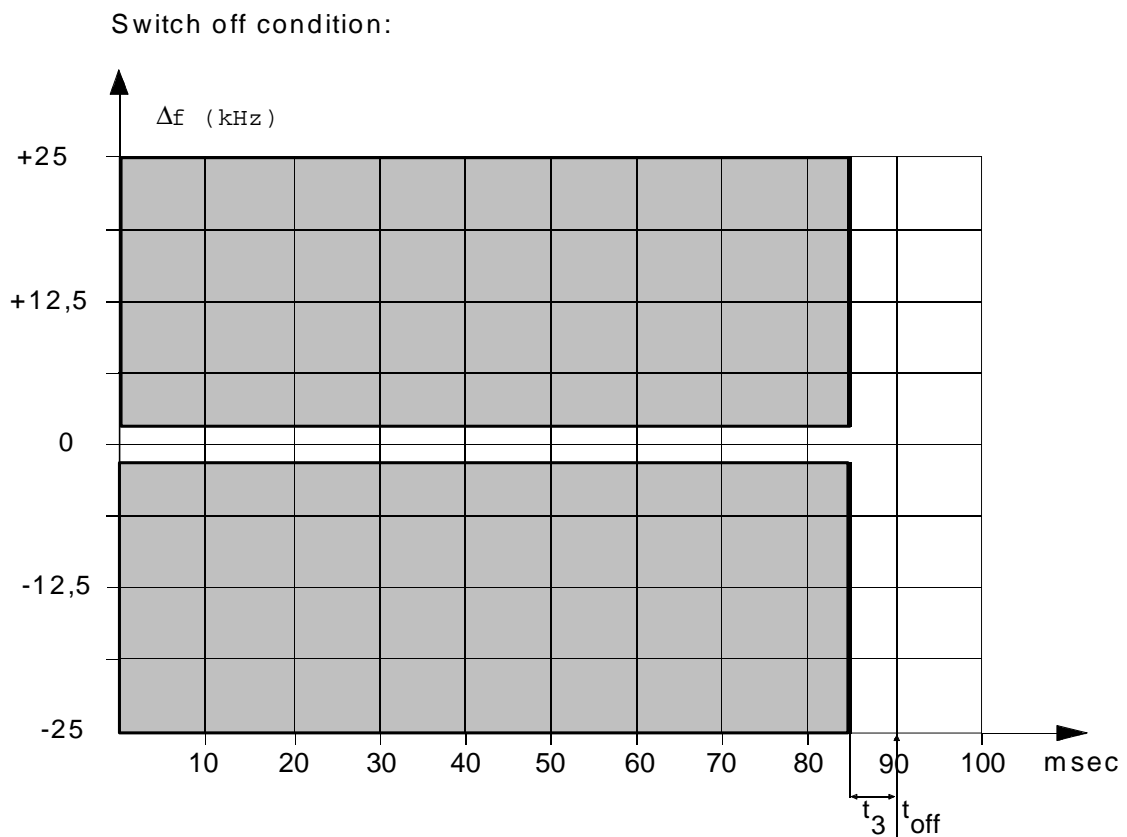
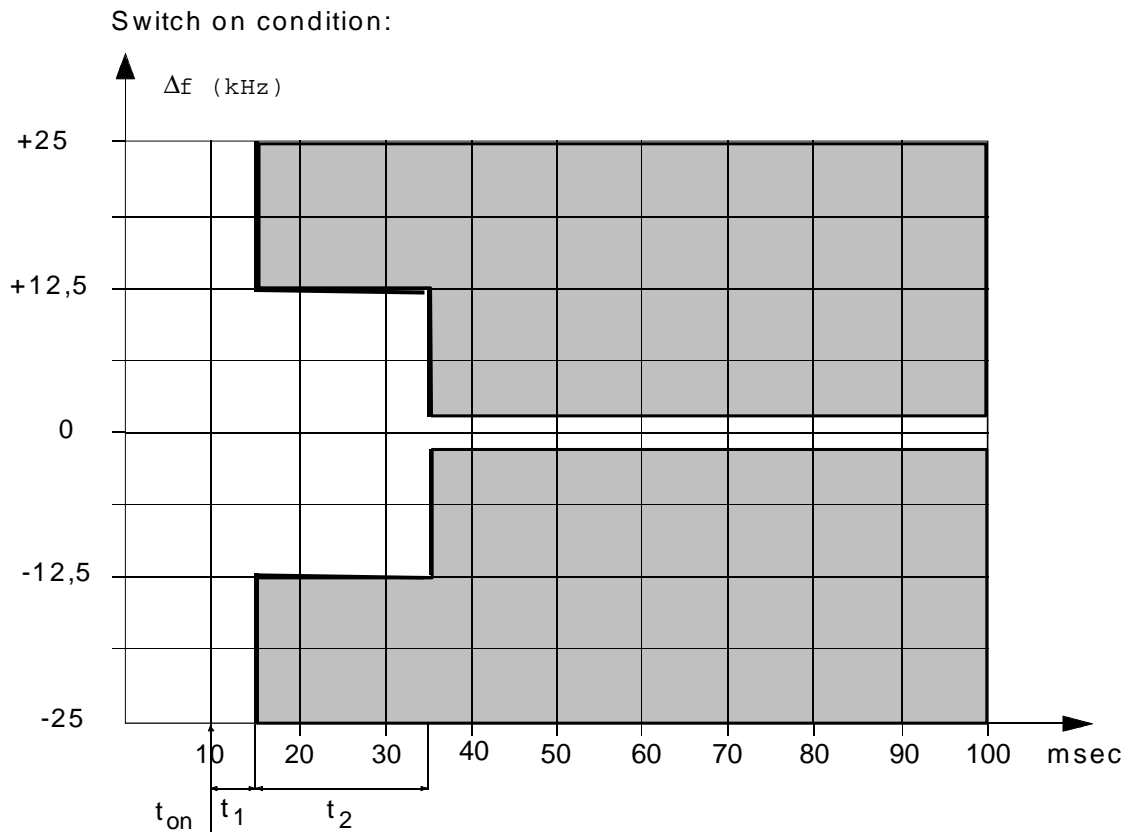

Figure 4: Switch on/off conditions

8.12 Cabinet radiation and conducted spurious emissions other than those conveyed to the antenna

8.12.1 Definitions

Cabinet radiation consists of emissions at frequencies, other than those of the carrier and the sideband components resulting from the wanted modulation process, which are radiated by the equipment cabinet and structures.

Conducted spurious emissions other than those conveyed to the antenna are emissions at frequencies, other than those of the carrier and the sideband components resulting from the wanted modulation process, which are produced by conduction in the wiring and accessories used with the equipment.

Integral antenna equipment shall be tested with the normal antenna fitted and the carrier frequency emission shall be filtered as described in the method of measurement.

8.12.2 Method of measurement

On a test site the equipment shall be placed at the specified height on a non-conducting support and in a position which is closest to normal use as declared by the manufacturer.

The transmitter antenna connector shall be connected to an artificial antenna, clause 6.4.

The test antenna shall be orientated for vertical polarization and the length of the test antenna shall be chosen to correspond to the instantaneous frequency of the measuring receiver, or a suitable broadband antenna may be used.

The output of the test antenna shall be connected to a measuring receiver.

For integral antenna equipment testing, a filter shall be inserted between the test antenna and the measuring receiver. For the measurement of spurious emissions below the second harmonic of the carrier frequency the filter used shall be a high Q (notch) filter centred on the transmitter carrier frequency and attenuating this signal by at least 30 dB. For the measurement of spurious emissions at and above the second harmonic of the carrier frequency the filter used shall be a high pass filter with a stop band rejection exceeding 40 dB and the cut off frequency of this high pass filter shall be approximately 1,5 times the transmitter carrier frequency.

The transmitter shall be switched on without modulation, and the measuring receiver shall be tuned over the frequency range 30 MHz to 2 GHz, except for the channel on which the transmitter is intended to operate and its adjacent channels.

At each frequency at which a spurious component is detected:

- a) The test antenna shall be raised and lowered through the specified range of heights until a maximum signal level is detected on the measuring receiver.
- b) The transmitter shall be rotated through 360° in the horizontal plane, until the maximum signal level is detected by the measuring receiver.
- c) The maximum signal level detected by the measuring receiver shall be noted.
- d) The transmitter shall be replaced by a substitution antenna.
- e) The substitution antenna shall be orientated for vertical polarization and the length of the substitution antenna shall be adjusted to correspond to the frequency of the spurious component detected.
- f) The substitution antenna shall be connected to a calibrated signal generator.
- g) The frequency of the calibrated signal generator shall be set to the frequency of the spurious component detected.
- h) The input attenuator setting of the measuring receiver shall be adjusted in order to increase the sensitivity of the measuring receiver, if necessary.
- i) The test antenna shall be raised and lowered through the specified range of heights to ensure that the maximum signal is received.

- j) The input signal to the substitution antenna shall be adjusted to the level that produces a level detected by the measuring receiver that is equal to the level noted while the spurious component was measured, corrected for the change of input attenuator setting of the measuring receiver.
- k) The input level to the substitution antenna shall be recorded as power level, corrected for the change of input attenuator setting of the measuring receiver.
- l) The measurement shall also be taken with the test antenna and the substitution antenna orientated for horizontal polarization.
- m) The effective radiated power of the spurious component is the larger of the two power levels recorded for that spurious component at the input to the substitution antenna, corrected to compensate for the gain of the antenna if necessary.
- n) The measurements shall be repeated with the transmitter in stand-by mode.

8.12.3 Limits

With the transmitter in stand-by mode the cabinet radiation and spurious emissions shall not exceed 2 nW.

With the transmitter in operation the cabinet radiation and spurious emissions shall not exceed 0,25 μ W.

9 Receiver

9.1 Harmonic distortion and rated audio frequency output power

9.1.1 Definition

The harmonic distortion at the receiver output port is defined as the ratio, expressed as a percentage, of the total rms voltage of all the harmonic components of the modulation audio frequency to the total rms voltage of the signal delivered by the receiver.

The rated audio frequency output power is the value stated by the manufacturer to be the maximum power available at the output port, for which all the requirements of the present document are met.

9.1.2 Method of measurement

Test signals at levels of +60 dB μ V and +100 dB μ V, at a carrier frequency equal to the nominal frequency of the receiver and modulated by the normal test modulation (see clause 6.3) shall be applied in succession to the receiver antenna port under the conditions specified in clause 6.1.

For each measurement, the receiver's audio frequency volume control shall be set so as to obtain, in a resistive load which simulates the receiver's operating load, the rated audio frequency output power (see clause 9.1.1). The value of this load shall be stated by the manufacturer.

Under normal test conditions (see clause 5.3) the test signals shall each be modulated successively at 300 Hz, 500 Hz and 1 kHz with a constant modulation index of 3 (ratio between the frequency deviation and the modulation frequency). The harmonic distortion and audio frequency output power shall be measured at all the frequencies specified above.

Under extreme test conditions (clauses 5.4.1 and 5.4.2 applied simultaneously), the tests shall be made at the receiver's nominal frequency and at the nominal frequency $\pm 1,5$ kHz. For these tests, the modulation shall be 1 kHz and the frequency deviation shall be 3 kHz.

9.1.3 Limits

The rated audio frequency output power shall be at least:

- 2 W in a loudspeaker;
- 1 mW in the handset earphone.

The harmonic distortion shall not exceed 10 %.

9.2 Audio frequency response

9.2.1 Definition

The audio frequency response is the variation in the receiver's audio frequency output level as a function of the modulating frequency of the RF signal with constant deviation applied to its input.

9.2.2 Method of measurement

A test signal of +60 dB μ V, at a carrier frequency equal to the nominal frequency of the receiver, shall be applied to the receiver antenna port under the conditions specified in clause 6.1.

The receiver's audio frequency power control shall be set so as to produce a power level equal to 50 % of the rated output power (see clause 9.1) when the normal test modulation is applied in accordance with clause 6.3. This setting shall remain unchanged during the test.

The frequency deviation shall then be reduced to 1 kHz and the audio output is the reference point in figure 5 (1 kHz corresponds to 0 dB).

The frequency deviation shall remain constant while the modulation frequency is varied between 300 Hz and 3 kHz and the output level shall then be measured.

The measurement shall be repeated with a test signal at frequencies 1,5 kHz above and below the nominal frequency of the receiver.

9.2.3 Limits

The audio frequency response shall not deviate by more than +1 dB or -3 dB from a characteristic giving the output level as a function of the audio frequency, decreasing by 6 dB per octave and passing through the measured point at 1 kHz (see figure 5).

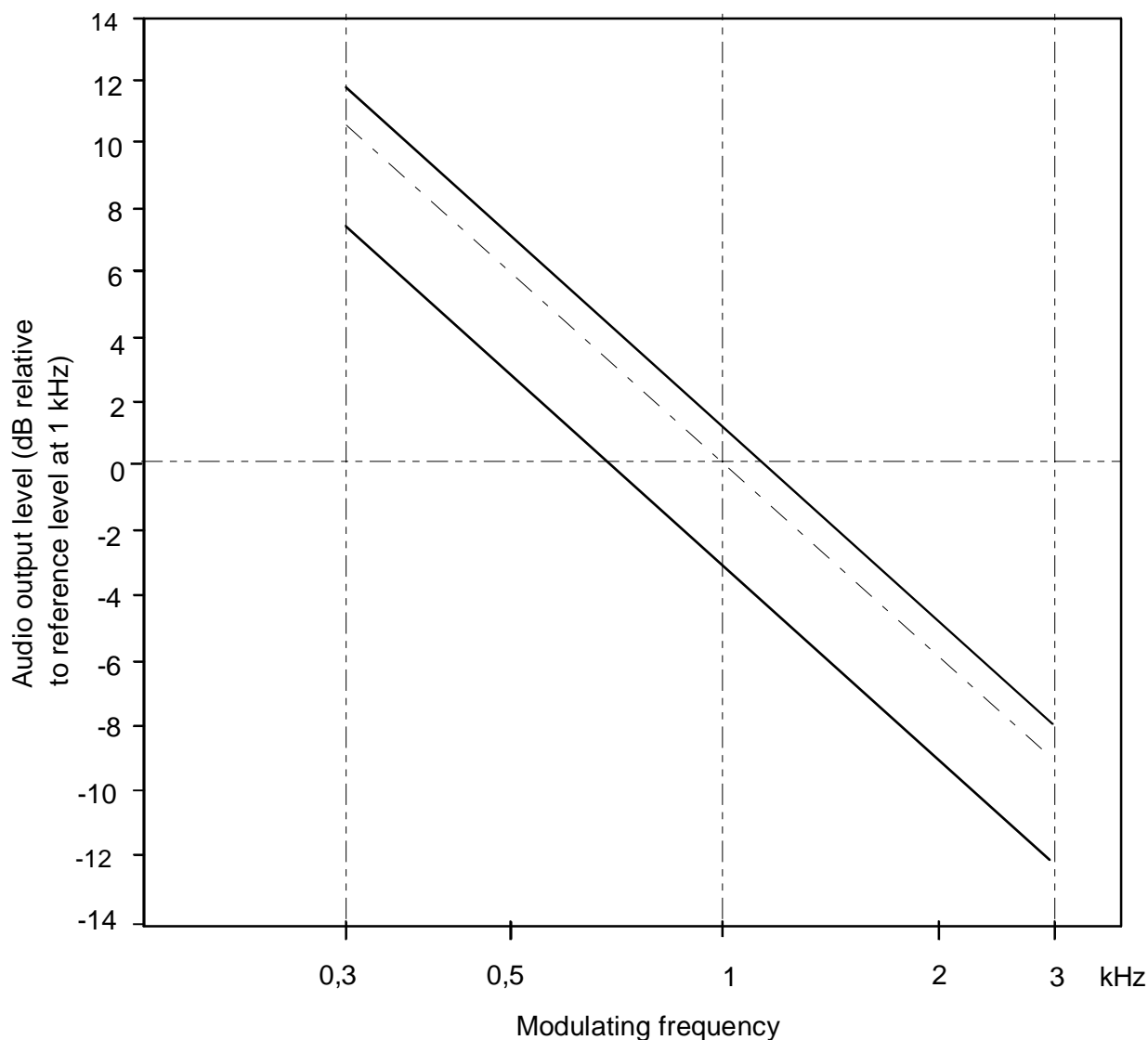

Figure 5: Audio frequency response

9.3 Maximum usable sensitivity

9.3.1 Definition

The maximum usable sensitivity of the receiver is the minimum level of the signal at the nominal frequency of the receiver which, when applied to the receiver antenna port with normal test modulation (see clause 6.3), will produce:

- in all cases, an audio frequency output power equal to 50 % of the rated output power (see clause 9.1); and
- a SINAD ratio of 20 dB, measured at the receiver output port through a psophometric telephone filtering network such as described in Recommendation ITU-T O.41 [4].

9.3.2 Method of measurement

A test signal at a carrier frequency equal to the nominal frequency of the receiver, modulated by the normal test modulation (see clause 6.3) shall be applied to the receiver antenna port. An audio frequency load and a measuring instrument for measuring the SINAD ratio (through a psophometric network as specified in clause 9.3.1) shall be connected to the receiver output port.

The level of the test signal shall be adjusted until a SINAD ratio of 20 dB is obtained, using the psophometric network and with the receiver's audio frequency power control adjusted to produce 50 % of the rated output power. Under these conditions, the level of the test signal at the antenna port is the value of the maximum usable sensitivity.

The measurements shall be made under normal test conditions (see clause 5.3) and under extreme test conditions (clauses 5.4.1 and 5.4.2 applied simultaneously).

A receiver output power variation of ± 3 dB relative to 50 % of the rated output power may be allowed for sensitivity measurements under extreme test conditions.

9.3.3 Limits

The maximum usable sensitivity shall not exceed +6 dB μ V under normal test conditions and +12 dB μ V under extreme test conditions.

9.4 Co-channel rejection

9.4.1 Definition

The co-channel rejection is a measure of the capability of the receiver to receive a wanted modulated signal without exceeding a given degradation due to the presence of an unwanted modulated signal, both signals being at the nominal frequency of the receiver.

9.4.2 Method of measurement

The two input signals shall be connected to the receiver antenna port via a combining network (see clause 6.1). The wanted signal shall have normal test modulation (see clause 6.3). The unwanted signal shall be modulated by 400 Hz with a deviation of 3 kHz. Both input signals shall be at the nominal frequency of the receiver under test and the measurement repeated for displacements of the unwanted signal of up to plus and minus 3 kHz.

The wanted input signal level shall be set to the value corresponding to the maximum usable sensitivity as measured in clause 9.3. The amplitude of the unwanted input signal shall then be adjusted until the SINAD ratio (psophometrically weighted) at the output port of the receiver is reduced to 14 dB.

The co-channel rejection ratio shall be expressed as the ratio in dB of the level of the unwanted signal to the level of the wanted signal at the receiver antenna port for which the specified reduction in SINAD ratio occurs.

9.4.3 Limit

The co-channel rejection ratio, at any frequency of the unwanted signal within the specified range, shall be between -10 dB and 0 dB.

9.5 Adjacent channel selectivity

9.5.1 Definition

The adjacent channel selectivity is a measure of the capability of the receiver to receive a wanted modulated signal without exceeding a given degradation due to the presence of an unwanted modulated signal which differs in frequency from the wanted signal by 25 kHz.

9.5.2 Method of measurement

The two input signals shall be applied to the receiver antenna port via a combining network (see clause 6.1). The wanted signal shall be at the nominal frequency of the receiver and shall have normal test modulation (see clause 6.3). The unwanted signal shall be modulated by 400 Hz with a deviation of 3 kHz, and shall be at the frequency of the channel immediately above that of the wanted signal.

The wanted input signal level shall be set to the value corresponding to the maximum usable sensitivity as measured in clause 9.3. The amplitude of the unwanted input signal shall then be adjusted until the SINAD ratio at the receiver output port, psophometrically weighted, is reduced to 14 dB. The measurement shall be repeated with an unwanted signal at the frequency of the channel below that of the wanted signal.

The adjacent channel selectivity shall be expressed as the lower value of the ratios in dB for the upper and lower adjacent channels of the level of the unwanted signal to the level of the wanted signal.

The measurements shall then be repeated under extreme test conditions (clauses 5.4.1 and 5.4.2 applied simultaneously) with the wanted signal set to the value corresponding to the maximum usable sensitivity under these conditions.

9.5.3 Limits

The adjacent channel selectivity shall be not less than 70 dB under normal test conditions and not less than 60 dB under extreme test conditions.

9.6 Spurious response rejection

9.6.1 Definition

The spurious response rejection is a measure of the capability of the receiver to discriminate between the wanted modulated signal at the nominal frequency and an unwanted signal at any other frequency at which a response is obtained.

9.6.2 Method of measurement

Two input signals shall be applied to the receiver antenna port via a combining network (see clause 6.1). The wanted signal shall be at the nominal frequency of the receiver and shall have normal test modulation (see clause 6.3).

The unwanted signal shall be modulated by 400 Hz with a deviation of 3 kHz.

The wanted input signal level shall be set to the value corresponding to the maximum usable sensitivity as measured in clause 9.3. The amplitude of the unwanted input signal shall be adjusted to +86 dB μ V. The frequency shall then be swept over the frequency range from 100 kHz to 2 000 MHz.

At any frequency at which a response is obtained, the input level shall be adjusted until the SINAD ratio psophometrically weighted, is reduced to 14 dB.

The spurious response rejection ratio shall be expressed as the ratio in dB between the unwanted signal and the wanted signal at the receiver antenna port when the specified reduction in the SINAD ratio is obtained.

9.6.3 Limit

At any frequency separated from the nominal frequency of the receiver by more than 25 kHz, the spurious response rejection ratio shall be not less than 70 dB.

9.7 Intermodulation response

9.7.1 Definition

The intermodulation response is a measure of the capability of a receiver to receive a wanted modulated signal without exceeding a given degradation due to the presence of two or more unwanted signals with a specific frequency relationship to the wanted signal frequency.

9.7.2 Method of measurement

Three signal generators, A, B and C shall be connected to the receiver antenna port via a combining network (see clause 6.1). The wanted signal, represented by signal generator A shall be at the nominal frequency of the receiver and shall have normal test modulation (see clause 6.3). The unwanted signal from signal generator B shall be unmodulated and adjusted to the frequency 50 kHz above (or below) the nominal frequency of the receiver. The second unwanted signal from signal generator C shall be modulated by 400 Hz with a deviation of 3 kHz, and adjusted to a frequency 100 kHz above (or below) the nominal frequency of the receiver.

The wanted input signal shall be set to a value corresponding to the maximum usable sensitivity as measured in clause 9.3. The amplitude of the two unwanted signals shall be maintained equal and shall be adjusted until the SINAD ratio at the receiver output port, psophometrically weighted, is reduced to 14 dB. The frequency of signal generator B shall be adjusted slightly to produce the maximum degradation of the SINAD ratio. The level of the two unwanted test signals shall be readjusted to restore the SINAD ratio of 14 dB. The intermodulation response ratio shall be expressed as the ratio in dB between the two unwanted signals and the wanted signal at the receiver antenna port, when the specified reduction in the SINAD ratio is obtained.

9.7.3 Limit

The intermodulation response ratio shall be greater than 68 dB.

9.8 Blocking or desensitization

9.8.1 Definition

Blocking is a change (generally a reduction) in the wanted output power of the receiver or a reduction of the SINAD ratio due to an unwanted signal on another frequency.

9.8.2 Method of measurement

Two input signals shall be applied to the receiver antenna port via a combining network (see clause 6.1). The modulated wanted signal shall be at the nominal frequency of the receiver and shall have normal test modulation (see clause 6.3). Initially the unwanted signal shall be switched off and the wanted signal set to the value corresponding to the maximum usable sensitivity.

The audio frequency power volume control shall be adjusted, where applicable, to 50 % of the rated output power and in the case of stepped volume controls, to the first step that provides an output power of at least 50 % of the rated output power. The unwanted signal shall be unmodulated and the frequency shall be swept between +1 MHz and +10 MHz, and also between -1 MHz and -10 MHz, relative to the nominal frequency of the receiver. The input level of the unwanted signal, at all frequencies in the specified ranges, shall be so adjusted that the unwanted signal causes:

- a) a reduction of 3 dB in the output level of the wanted signal; or
- b) a reduction to 14 dB of the SINAD ratio at the receiver output port using a psophometric telephone filtering network such as described in Recommendation ITU-T O.41 [4] whichever occurs first.

This level shall be noted.

9.8.3 Limit

The blocking level for any frequency within the specified ranges, shall be not less than 90 dB μ V, except at frequencies on which spurious responses are found (see clause 9.6).

9.9 Conducted spurious emissions conveyed to the antenna

9.9.1 Definition

Conducted spurious emissions are components at any frequency generated in the receiver and radiated by its antenna.

The level of spurious emissions shall be measured by their power level in a transmission line or antenna.

9.9.2 Method of measurement

Spurious radiations shall be measured as the power level of any discrete signal at the antenna port of the receiver. The receiver antenna port is connected to a spectrum analyser or selective voltmeter having an input impedance of 50 Ω and the receiver is switched on.

If the detecting device is not calibrated in terms of power input, the level of any detected components shall be determined by a substitution method using a signal generator.

The measurements shall extend over the frequency range of 9 kHz to 2 GHz.

9.9.3 Limit

The power of any spurious component between 9 kHz and 2 GHz shall not exceed 2 nW.

9.10 Amplitude response of the receiver limiter

9.10.1 Definition

The amplitude response of the receiver limiter is the relationship between the radio frequency input level of a specific modulated signal and the audio frequency level at the receiver output port.

9.10.2 Method of measurement

A test signal at the nominal frequency of the receiver and modulated by the normal test modulation (see clause 6.3) at a level of +6 dB μ V shall be applied to the receiver antenna port and the audio frequency output level shall be adjusted to a level of 6 dB lower than the rated output power (see clause 9.1). The level of the input signal shall be increased to +100 dB μ V and the audio frequency output level shall be measured again.

9.10.3 Limit

When the radio frequency input level is varied as specified, the variation between the maximum and minimum value of the audio frequency output level shall not exceed 3 dB.

9.11 Receiver noise and hum level

9.11.1 Definition

The receiver noise and hum level is defined as the ratio, in dB, of the audio frequency power of the noise and hum resulting from spurious effects of the power supply system or from other causes, to the audio frequency power produced by a high frequency signal of average level, modulated by the normal test modulation and applied to the receiver antenna port.

9.11.2 Method of measurement

A test signal with a level of +30 dB μ V at a carrier frequency equal to the nominal frequency of the receiver, and modulated by the normal test modulation specified in clause 6.3, shall be applied to the receiver antenna port. An audio frequency load shall be connected to the output port of the receiver. The audio frequency power control shall be set so as to produce the rated output power level conforming to clause 9.1.

The output signal shall be measured with an rms voltmeter. The modulation shall then be switched off and the audio frequency output level measured again.

9.11.3 Limit

The receiver noise and hum level shall not exceed -40 dB.

9.12 Squelch operation

9.12.1 Definition

The purpose of the squelch facility is to mute the receiver audio output signal when the level of the signal at the receiver antenna port is less than a given value.

9.12.2 Method of measurement

The following method of measurement shall be used:

- a) with the squelch facility switched off, a test signal of +30 dB μ V, at a carrier frequency equal to the nominal frequency of the receiver and modulated by the normal test modulation specified in clause 6.3, shall be applied to the antenna port of the receiver. An audio frequency load and a psophometric filtering network (see clause 9.3.1) shall be connected to the output port of the receiver. The receiver's audio frequency power control shall be set so as to produce the rated output power defined in clause 9.1:
 - the output signal shall be measured with an rms voltmeter;
 - the input signal shall then be suppressed, the squelch facility switched on and the audio frequency output level measured again.
- b) with the squelch facility switched off again, a test signal modulated by the normal test modulation shall be applied to the receiver antenna port at a level of +6 dB μ V and the receiver shall be set to produce 50 % of the rated output power. The level of the input signal shall then be reduced and the squelch facility shall be switched on. The input signal shall then be increased until the above-mentioned output power is reached. The SINAD ratio and the input level shall then be measured;
- c) (applicable only to equipment with continuously adjustable squelch control) with the squelch facility switched off, a test signal with normal test modulation shall be applied to the receiver antenna port at a level of +6 dB μ V, and the receiver shall be adjusted to give 50 % of the rated audio output power. The squelch facility shall then be switched on at its maximum position and the level of the input signal increased until the output power again is 50 % of the rated audio output power.

9.12.3 Limits

Under the conditions specified in a) clause 9.12.2, the audio frequency output power shall not exceed -40 dB relative to the rated output power.

Under the conditions specified in b) clause 9.12.2, the input level shall not exceed +6 dB μ V and the SINAD ratio shall be at least 20 dB.

Under the conditions specified in c) clause 9.12.2, the input signal shall not exceed +6 dB μ V when the control is set at maximum.

9.13 Squelch hysteresis

9.13.1 Definition

Squelch hysteresis is the difference in dB between the receiver input signal levels at which the squelch opens and closes.

9.13.2 Method of measurement

If there is any squelch control on the exterior of the equipment it shall be placed in its maximum muted position. With the squelch facility switched on, an unmodulated input signal at a carrier frequency equal to the nominal frequency of the receiver shall be applied to the antenna port of the receiver at a level sufficiently low to avoid opening the squelch. The input signal shall be increased to the level just opening the squelch. This input level shall be recorded. With the squelch still open, the level of the input signal shall be slowly decreased until the squelch mutes the receiver audio output again.

9.13.3 Limit

The squelch hysteresis shall be between 3 dB and 6 dB.

9.14 Radiated spurious emissions

9.14.1 Definition

Radiated spurious emissions from the receiver are components at any frequency radiated by the equipment cabinet and the structure.

Integral antenna equipment shall be tested with the normal antenna fitted.

9.14.2 Method of measurements

On a test site the equipment shall be placed at the specified height on a non-conducting support and in a position which is closest to normal use as declared by the manufacturer.

The test antenna shall be orientated for vertical polarization and the length of the test antenna shall be chosen to correspond to the instantaneous frequency of the measuring receiver, or a suitable broadband antenna may be used.

The output of the test antenna shall be connected to a measuring receiver.

The receiver shall be switched on without modulation, and measuring receiver shall be tuned over the frequency range 30 MHz to 2 GHz.

At each frequency at which a spurious component is detected:

- a) The test antenna shall be raised and lowered through the specified range of heights until a maximum signal level is detected on the measuring receiver.
- b) The receiver shall be rotated through 360° in the horizontal plane, until the maximum signal level is detected by the measuring receiver.
- c) The maximum signal level detected by the measuring receiver shall be noted.
- d) The receiver shall be replaced by a substitution antenna.
- e) The substitution antenna shall be orientated for vertical polarization and the length of the substitution antenna shall be adjusted to correspond to the frequency of the spurious component detected.
- f) The substitution antenna shall be connected to a calibrated signal generator.

- g) The frequency of the calibrated signal generator shall be set to the frequency of the spurious component detected.
- h) The input attenuator setting of the measuring receiver shall be adjusted in order to increase the sensitivity of the measuring receiver, if necessary.
- i) The test antenna shall be raised and lowered through the specified range of heights to ensure that the maximum signal is received.
- j) The input signal to the substitution antenna shall be adjusted to the level that produces a level detected by the measuring receiver that is equal to the level noted while the spurious component was measured, corrected for the change of input attenuator setting of the measuring receiver.
- k) The input level to the substitution antenna shall be recorded as power level, corrected for the change of input attenuator setting of the measuring receiver.
- l) The measurement shall also be taken with the test antenna and the substitution antenna orientated for horizontal polarization.
- m) The effective radiated power of the spurious component is the larger of the two power levels recorded for that spurious component at the input to the substitution antenna, corrected to compensate for the gain of the antenna if necessary.

9.14.3 Limit

The power of any spurious radiation shall not exceed 2 nW at any frequency in the range between 30 MHz and 2 GHz.

10 Duplex operation

10.0 Applicability

If the equipment is designed for duplex operation, when submitted for conformance testing it shall be fitted with a duplex filter and the following additional measurements shall be carried out to ensure satisfactory duplex operation.

10.1 Receiver desensitization with simultaneous transmission and reception

10.1.1 Definition

The desensitization is the degradation of the sensitivity of the receiver resulting from the transfer of power from the transmitter to the receiver due to coupling effects.

It is expressed as the difference in dB of the maximum usable sensitivity levels with simultaneous transmission and without.

10.1.2 Method of measurement

The antenna port of the equipment comprising the receiver, transmitter and duplex filter shall be connected through a coupling device to the artificial antenna specified in clause 6.4.

A signal generator with normal test modulation (see clause 6.3) shall be connected to the coupling device so that it does not affect the impedance matching.

The transmitter shall be brought into operation at the carrier output power as defined in clause 8.2, modulated by 400 Hz with a deviation of 3 kHz.

The receiver sensitivity shall then be measured in accordance with clause 9.3.

The output level of the signal generator shall be recorded as C in dB μ V.

The transmitter shall be switched off and the receiver sensitivity is again measured.

The output level of the signal generator shall be recorded as D in dB μ V.

The desensitization is the difference between the values of C and D.

10.1.3 Limits

The desensitization shall not exceed 3 dB. The maximum usable sensitivity under conditions of simultaneous transmission and reception shall not exceed the limits specified in clause 9.3.3.

10.2 Receiver spurious response rejection

The receiver spurious response rejection shall be measured as specified in clause 9.6 with the equipment arrangement described in clause 10.1.2, except that the transmitter shall be unmodulated. The transmitter shall be operated at the carrier output power as defined in clause 8.2.

The limit given in clause 9.6.3 applies.

11 Testing for compliance with technical requirements

11.1 Environmental conditions for testing

These shall be as described clause 5.

11.2 Interpretation of the measurement results

The interpretation of the results recorded in a test report for the measurements described in the present document shall be as follows:

- the measured value related to the corresponding limit will be used to decide whether equipment meets the requirements of the present document and the measurement shall be related to the tolerance and uncertainty as follows:

$$d_{mv}^2 = d_{pt}^2 + d_{mu}^2$$

Where d_{pt} is the permitted tolerance for the parameter under test

and; d_{mu} is the measurement uncertainty applicable for that parameter

d_{mv} is the permitted error in the measured value

- the value of the measurement uncertainty for the measurement of each parameter shall be included in the test report;
- the recorded value of the measurement uncertainty shall be, for each measurement, equal to or lower than the figures in table 4.

For the test methods, according to the present document, the measurement uncertainty figures shall be calculated and shall correspond to an expansion factor (coverage factor) $k = 1,96$ or $k = 2$ (which provide confidence levels of respectively 95 % and 95,45 % in the case where the distributions characterizing the actual measurement uncertainties are normal (Gaussian)). Principles for the calculation of measurement uncertainty are contained in ETSI TR 100 028 [i.2] and [i.5], in particular in annex D of the ETSI TR 100 028-2 [i.5].

Table 4 is based on such expansion factors.

Table 4: maximum measurement uncertainty

Parameter	Maximum uncertainty
RF frequency	$\pm 1 \times 10^{-7}$
RF power	$\pm 0,75$ dB
Maximum frequency deviation: - within 300 Hz to 6 kHz of modulation frequency - within 6 kHz to 25 kHz of modulation frequency	± 5 % ± 3 dB
Deviation limitation	± 5 %
Adjacent channel power	± 5 dB
Conducted spurious emission of transmitter	± 4 dB
Audio output power	$\pm 0,5$ dB
Amplitude characteristics of receiver limiter	$\pm 1,5$ dB
Sensitivity at 20 dB SINAD	± 3 dB
Conducted emission of receiver	± 3 dB
Two-signal measurement	± 4 dB
Three-signal measurement	± 3 dB
Radiated emission of transmitter	± 6 dB
Radiated emission of receiver	± 6 dB
Transmitter transient time	± 20 %
Transmitter transient frequency	± 250 Hz
Receiver desensitization (duplex operation)	$\pm 0,5$ dB

Annex A (informative): Relationship between the present document and the essential requirements of Directive 2014/53/EU

The present document has been prepared under the Commission's standardisation request C(2015) 5376 final [i.4] to provide one voluntary means of conforming to the essential requirements of Directive 2014/53/EU on the harmonisation of the laws of the Member States relating to the making available on the market of radio equipment and repealing Directive 1999/5/EC [i.3].

Once the present document is cited in the Official Journal of the European Union under that Directive, compliance with the normative clauses of the present document given in tables A.1 and A.2 confers, within the limits of the scope of the present document, a presumption of conformity with the corresponding essential requirements of that Directive, and associated EFTA regulations.

Table A.1: Relationship between the present document and the essential requirements of article 3.2 of Directive 2014/53/EU

Harmonised Standard ETSI EN 300 698				
Requirement			Requirement Conditionality	
No	Description	Reference: Clause No	U/C	Condition
1	Transmitter frequency error	8.1	U	
2	Transmitter carrier power	8.2	U	
3	Transmitter maximum permissible frequency deviation at modulation frequencies below 3 kHz	8.3.2	U	
4	Transmitter reduction of frequency deviation at modulation frequencies above 3 kHz	8.3.3	U	
5	Transmitter adjacent channel power	8.8	U	
6	Transmitter conducted spurious emissions conveyed to the antenna	8.9	U	
7	Transmitter cabinet radiation and conducted spurious emissions other than those conveyed to the antenna	8.12	U	
8	Transmitter transient frequency behaviour	8.11	U	
9	Receiver maximum usable sensitivity	9.3	U	
10	Receiver co-channel rejection	9.4	U	
11	Receiver adjacent channel selectivity	9.5	U	
12	Receiver spurious response rejection	9.6	U	
13	Receiver intermodulation response	9.7	U	
14	Receiver blocking or desensitization	9.8	U	
15	Receiver conducted spurious emissions	9.9	U	
16	Receiver radiated spurious emissions	9.14	U	
17	Duplex receiver desensitisation	10.1	C	Applies to full duplex equipment only
18	Duplex receiver spurious response	10.2	C	Applies to full duplex equipment only

Table A.2: Relationship between the present document and the essential requirements of article 3.3(g) of Directive 2014/53/EU

Harmonised Standard ETSI EN 300 698				
Requirement			Requirement Conditionality	
No	Description	Reference: Clause No	U/C	Condition
1	General and operational requirements	4.0	U	
2	Vibration	7.4	U	
3	Damp heat cycle	7.5	U	
4	Transmitter sensitivity of the modulator, including microphone	8.5	U	

Harmonised Standard ETSI EN 300 698				
Requirement			Requirement Conditionality	
No	Description	Reference: Clause No	U/C	Condition
5	Transmitter Audio frequency response	8.6	U	
6	Audio frequency harmonic distortion of the emission	8.7	U	
7	Transmitter residual modulation	8.10	U	
8	Receiver harmonic distortion and rated audio-frequency output power	9.1	U	
9	Receiver audio frequency response	9.2	U	
10	Receiver noise and hum level	9.11	U	
11	Receiver squelch operation	9.12	U	
12	Receiver squelch hysteresis	9.13	U	
13	ATIS signalling	B.1	C	See note
14	ATIS frequency error	B.2.2	C	See note
15	ATIS modulation index	B.2.3	C	See note
16	ATIS modulation rate	B.2.4	C	See note
17	ATIS format	B.2.5	C	See note
NOTE: When required by the Regional Arrangement Concerning the Radiotelephone Service on Inland Waterways (RAINWAT).				

Key to columns:

Requirement:

No A unique identifier for one row of the table which may be used to identify a requirement.

Description A textual reference to the requirement.

Clause Number Identification of clause(s) defining the requirement in the present document unless another document is referenced explicitly.

Requirement Conditionality:

U/C Indicates whether the requirement is unconditionally applicable (U) or is conditional upon the manufacturer's claimed functionality of the equipment (C).

Condition Explains the conditions when the requirement is or is not applicable for a requirement which is classified "conditional".

Presumption of conformity stays valid only as long as a reference to the present document is maintained in the list published in the Official Journal of the European Union. Users of the present document should consult frequently the latest list published in the Official Journal of the European Union.

Other Union legislation may be applicable to the product(s) falling within the scope of the present document.

Annex B (normative): Automatic Transmitter Identification System (ATIS)

B.1 System description

B.1.1 General

The Automatic Transmitter Identification System (ATIS) is a synchronous system using a ten-unit error-detecting code. The system is, for its relevant parts, based on Recommendation ITU-R M.493-14 [i.1].

The ATIS facility shall generate the identification signal automatically.

The ATIS signal shall be transmitted at the end of each transmission. The end of a transmission is considered to be every release of the "push-to-talk" switch of the equipment or when the transmission is terminated by the transmit time out timer. When the "push-to-talk" is released subsequent to this time out timer termination, no additional ATIS transmission shall be made.

The ATIS signal shall be transmitted on all channels available in the VHF radiotelephone installation.

If the VHF radiotelephone installation is equipped with a facility to transmit data, the transmission of an ATIS signal may be inhibited if the data protocol contains the identification of the transmitting station. During subsequent correspondence the ATIS signal shall be transmitted periodically.

B.1.2 Technical requirements

The ATIS facility shall in no way influence the functioning of other communication or navigational equipment.

During the transmission of the ATIS signal:

- the RF output power of the transmitter shall be retained at nominal value;
- any other audio modulation input shall be automatically inhibited.

It shall not be possible for the operator to change the programming of the ATIS facility.

The system is a synchronous system using a ten-unit error-detecting code as listed in table B.1 of the present document. The first seven bits of the ten-unit code of table B.1 are information bits. Bits 8, 9 and 10 indicate, in the form of a binary number, the number of B elements that occur in the seven information bits, a Y element being a binary number 1 and a B element being a binary number 0.

For example, a BYY sequence for bits 8, 9 and 10 indicates 3 ($0 \times 4 + 1 \times 2 + 1 \times 1$) B elements in the associated seven information bit sequence; and a YYB sequence indicates 6 ($1 \times 4 + 1 \times 2 + 0 \times 1$) B elements in the associated seven information bit sequence. The order of transmission for the information bits is the least significant bit first, but for the check bits it is the most significant bit first.

B.1.3 Signal requirements

The transmitted ATIS signal sequence shall be a phase modulated radio frequency signal (frequency modulation with a pre-emphasis of 6 dB/octave).

The modulating sub-carrier shall have a:

- frequency-shift between 1 300 Hz and 2 100 Hz;
- the sub-carrier frequency of 1 700 Hz;
- modulation rate of 1 200 baud;

- modulation index of 1,0.

The ten-unit error-detecting code expresses the symbols from 00 to 127, as shown in table B.1.

The symbols from 00 to 99 are used to code two decimal figures.

The higher frequency corresponds to the B-state and the lower frequency corresponds to the Y-state of the signal elements.

B.1.4 Format of an ATIS signal sequence

The format of the ATIS signal sequence according to table B.1 is:

Table B.1

Dot pattern (see note)	Phasing sequence	Format specifier	Self-identification	End of sequence	Error check character
NOTE: May be omitted.					

The composition of the ATIS format and signal sequence is given in tables B.2 and figure B.3.

Table B.2

Dot pattern (see note)	Phasing	A) Format specifier	B) Identification	C) End of sequence	D) Error check
20 bits	6 DX (125) 8 RX (111 to 104)	2 identical symbols (2 times)	5 symbols (2 times)	3 DX (127) 1 RX (127)	1 symbol (2 times)
NOTE: May be omitted.					

Time diversity is provided in the ATIS signal sequence as follows:

- besides the phasing signals, each signal is transmitted twice in a time-spread mode; the first transmission (DX) of a specific signal is followed by the transmission of four other signals before the re-transmission (RX) of that specific signal takes place, allowing for a time-diversity reception interval of $33\frac{1}{3}$ ms.

Dot pattern (see note)	
DX	
	RX 7
DX	
	RX 6
DX	
	RX 5
DX	
	RX 4
DX	
	RX 3
DX	
	RX 2
A	
	RX 1
A	
	RX 0
B	
	A
B	
	A
B	
	B
B	
	B
B	
	B
C	
	B
D	
	B
C	
	C
C	
	D

RX/DX = phasing sequence;
 A = Format specifier;
 B = Identification;
 C = End of sequence;
 D = Error check symbol;

NOTE: May be omitted.

Figure B.1: Transmission sequence

B.1.5 Dot pattern

To provide appropriate conditions for earlier bit synchronization, the phasing sequence may be preceded by a dot pattern (i.e. an alternating B-Y bit sequence) with a duration of 20 bits.

B.1.6 Phasing

The phasing sequence provides information to the receiver to permit correct bit phasing and unambiguous determination of the positions of the signals within an ATIS signal sequence.

Acquisition of symbol synchronization should be achieved by means of symbol recognition rather than, for example, by recognizing a change in the dot pattern, in order to reduce false synchronization caused by a bit error in the dot pattern.

The phasing sequence consists of specific signals in the DX and RX positions transmitted alternately.

The phasing signal in the DX position is symbol 125 of table B.1.

The phasing signals in the RX position specify the start of the information sequence (i.e. the format specifier) and consist of the signals for the symbols 111, 110, 109, 108, 107, 106, 105 and 104 of table B.1, consecutively.

B.1.7 Format specifier

The format specifier signal is transmitted twice in both the DX and RX positions (see figure B.1) and shall consist of symbol 121.

B.1.8 Identification

The call sign of the station shall be converted in accordance with clause B.1.11.

B.1.9 End of sequence

The "end of sequence" signal symbol 128 is transmitted 3 times in the DX position and once in the RX position (see figure B.1).

B.1.10 Error check character

The error check character is the final character transmitted and it serves to check the entire sequence for the presence of errors which are undetected by the ten-unit error-detecting code and the time diversity employed.

The seven information bits of the error-check signal shall be equal to the least significant bit of the modulo-2 sums of the corresponding bits of all information characters (i.e. even vertical parity). The format specifier and end of sequence characters are considered to be information characters. The phasing signals shall not be considered to be information characters. Only one format specifier signal and one end of sequence signal shall be used in constructing the error check character. The error check character shall also be sent in the DX and RX positions (see annex C).

B.1.11 Conversion of a call sign to MID

The following procedure shall be used for the conversion of call sign.

The 10-digit code constituting a ship station identity shall be formed as follows:

$$Z \text{ MID } X_1 X_2 X_3 X_4 X_5 X_6$$

Wherein:

Z represents the figure 9;

MID represents the Maritime Identification Digits for each country, see also ITU Radio Regulations [1], Appendix 42;

X_1 to X_6 represents the converted call sign figures.

The value of the digits X_1 to X_6 shall be derived as follows:

X_3 to X_6 shall contain the number of the call sign;

X_1 to X_2 shall contain a figure representing the second letter of the call sign, wherein 01 represents A, 02 represents B, etc.

The first letter of the call sign, indicating the country, is presented by the MID.

An example of the conversion is given in annex C.

Table B.3: Ten-unit error-detecting code

Symbol No.	Emitted signal and bit position 12345678910	Symbol No.	Emitted signal and bit position 12345678910	Symbol No	Emitted signal and bit position 12345678910
00	BBBBBBYYY	43	YYBYBYBY	86	BYYBYBYBY
01	YBBBBBYB	44	BBYYBYBY	87	YYYBYBYBY
02	BYBBBBYB	45	YBYBYBY	88	BBYYBYBY
03	YYBBBBYB	46	BYYBYBY	89	YBBYYBYBY
04	BBYBBBBY	47	YYYYBYBY	90	BYBYBYBY
05	YBYBBBBY	48	BBBBYYBY	91	YYBYBYBY
06	BYYBBBBY	49	YBBYYBY	92	BBYYYBYBY
07	YYYBBBBB	50	BYBBYYBY	93	YBYYYBYBY
08	BBBYBBYB	51	YYBBYYBY	94	BYYYBYBY
09	YBBYBBYB	52	BBYBYBY	95	YYYYBYBY
10	BYBYBBYB	53	YBYBYBY	96	BBBBYYBY
11	YYBYBBYB	54	BYYBYBY	97	YBBBYYBY
12	BBYYBBYB	55	YYYBYBY	98	BYBBYYBY
13	YBYYBBYB	56	BBBYYBY	99	YYBBYYBY
14	BYYYBBYB	57	YBBYYBY	100	BBYBBYYBY
15	YYYYBBBY	58	BYBYYBY	101	YBYBBYYBY
16	BBBYBBYB	59	YBYYBY	102	BYYBBYYBY
17	YBBYBBYB	60	BBYYYBY	103	YYYBBYYBY
18	BYBBYBBY	61	YBYYYBY	104	BBBYBYBY
19	YYBBYBBY	62	BYYYYBY	105	YBBYBYBY
20	BBYBYBBY	63	YYYYYBY	106	BYBYBYBY
21	YBYBYBBY	64	BBBBBYBY	107	YYBYBYBY
22	BYYBYBBY	65	YBBBBBY	108	BBYBYBY
23	YYYBYBBY	66	BYBBBBY	109	YBYBYBY
24	BBYBYBBY	67	YBBBBBY	110	BYYBYBY
25	YBYYBBYB	68	BBYBBYBY	111	YYYYBYBY
26	BYYYBBYB	69	YBYBBYBY	112	BBBBYYBY
27	YYBYBBBY	70	BYYBBYBY	113	YBBYYBY
28	BBYYBBYB	71	YYYBBYBY	114	BYBBYYBY
29	YBYYBBBY	72	BBBYBBYB	115	YYBBYYBY
30	BYYYBBBY	73	YBBYBBYB	116	BBYBYBY
31	YYYYBBBY	74	BYBYBBYB	117	YBYBYBY
32	BBBBBYBY	75	YBYBYBY	118	BYYBYBY
33	YBBBBYBY	76	BBYYBYBY	119	YYYBYBY
34	BYBBYBYB	77	YBYYBYBY	120	BBBYYBY
35	YYBBYBYB	78	BYYBYBY	121	YBBYYBY
36	BBYBYBYB	79	YYYYBYBY	122	BYBYBYBY
37	YBYBYBYB	80	BBBBBYBY	123	YYBYBYBY
38	BYYBYBYB	81	YBBBYBYB	124	BBYYBYBY
39	YYYBYBYB	82	BYBBYBYB	125	YBYYBYBY
40	BBBYBYBY	83	YBBYBYBY	126	BYYBYBY
41	YBBYBYBY	84	BBYBYBYB	127	YYYYBYBY
42	BYBYBYBY	85	YBYBYBYB		

B = 0 order of bit transmission: bit 1 first.
Y = 1.

B.2 ATIS encoder

B.2.1 Internally generated signals

For conformance testing and maintenance purposes the equipment shall have facilities, not accessible to the operator, to generate a continuous B or Y signal and a dot pattern. It shall be possible to generate at choice either a continuous B signal or a continuous Y signal.

B.2.2 Frequency error (demodulated signal)

B.2.2.1 Definition

The frequency error for the B and the Y state is the difference between the measured frequency from the demodulator and the nominal values.

B.2.2.2 Method of measurement

The transmitter shall be connected to the artificial antenna as specified in clause 6.4 and a suitable FM demodulator.

The equipment shall be set to transmit a continuous B or Y state.

The measurement shall be performed by measuring the demodulated output, for both the continuous B and Y state.

The measurements shall be carried out under normal (see clause 5.3) and extreme test conditions (clauses 5.4.1 and 5.4.2 applied simultaneously).

B.2.2.3 Limits

The measured frequency from the demodulator at any time for the B state shall be within $1\,300\text{ Hz} \pm 10\text{ Hz}$ and for the Y state within $2\,100\text{ Hz} \pm 10\text{ Hz}$.

B.2.3 Modulation index

B.2.3.1 Definition

The modulation index is the ratio between the frequency deviation and the frequency of the modulation signal.

The frequency deviation is the difference between the instantaneous frequency of the modulated RF signal and the carrier frequency.

B.2.3.2 Method of measurement

The equipment shall be set to transmit continuous B and then Y signals. The frequency deviations shall be measured.

B.2.3.3 Limits

The modulation index shall be $1,0 \pm 10\%$.

B.2.4 Modulation rate

B.2.4.1 Definition

The modulation rate is the bit stream speed measured in bits per second.

B.2.4.2 Method of measurement

The equipment shall be set to transmit a continuous dot pattern.

The RF output terminal of the equipment shall be connected to a linear FM demodulator. The output of the demodulator shall be limited in bandwidth by a low pass filter with a cut-off frequency of 1 kHz and a slope of 12 dB/octave.

The frequency of the output shall be measured.

B.2.4.3 Limits

The frequency shall be $600 \text{ Hz} \pm 60$ parts per million (ppm) corresponding to a modulation rate of 1 200 baud.

B.2.5 Testing of the ATIS format

The ATIS signal shall be analysed with the calibrated apparatus for correct configuration of the signal format (see clause B.1.4), including time diversity.

The decoded ATIS protocol shall conform to the programmed ATIS data in the equipment under test.

Annex C (informative): Conversion of a radio call sign into an ATIS identification

EXAMPLE 1: call sign = PC8075

The ship's identification (ID) is formed as follows:

Z MID XX 8 0 7 5

Where:

Z = always 9;
MID = for The Netherlands 244;
XX = C = 03.

ship's ID

9	<u>244</u>	<u>03</u>	8	0	7	5
{	Z	P	C			8 0 7 5}
92 44 03 80 75						

Example of an ATIS message:

```
DX 125 125 125 125 125 125 121 *121 92 44 03
RX 111 110 109 108 107 106 105 104 121 121 92
DX 80 75 127* ECC 127 127
RX 44 03 80 75 127 ECC
```

(* start/stop Error Correcting Code (ECC) calculation).

Calculation of the ECC:

- only DX information characters + one format and one end of sequence character are used to calculate the ECC.

EXAMPLE 2:

```
121 YBBYYYY
92 BBYYBY
44 BBYYBYB
03 YYBBBBB
80 BBBBYBY
75 YYBYBBY
127 YYYYYYY
----- + even vertical parity
BYYBY(BYB) = 110
```

Annex D (normative): Measuring receiver for adjacent channel power measurement

D.1 Power measuring receiver specification

D.1.0 General

The power measuring receiver consists of a mixer, an Intermediate Frequency (IF) filter, an oscillator, an amplifier, a variable attenuator and an rms value indicator. Instead of the variable attenuator with the rms value indicator it is also possible to use an rms voltmeter calibrated in dB. The technical characteristics of the power measuring receiver are given in figure D.1 (see also Recommendation ITU-R SM.332-4 [i.6]).

D.1.1 IF filter

The IF filter shall be within the limits of the following selectivity characteristics.

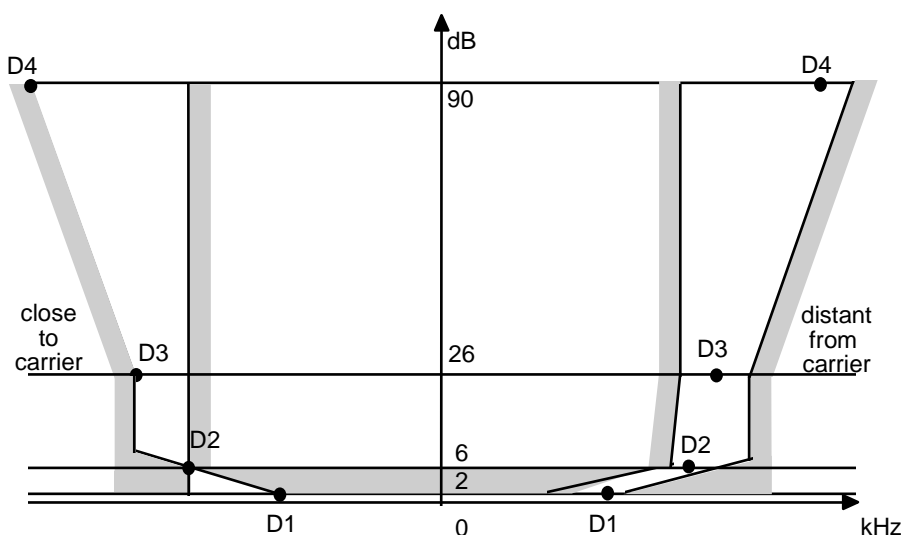

Figure D.1: IF filter characteristics

The selectivity characteristics shall keep the frequency separations shown in table D.1 from the nominal centre frequency of the adjacent channel.

Table D.1: Selectivity characteristic

Channel separation (kHz)	Frequency separation of filter curve from nominal centre frequency of adjacent channel (kHz)			
	D1	D2	D3	D4
12,5	3	4,25	5,5	9,5
25	5	8,0	9,25	13,25

The attenuation points shall not exceed following tolerances shown in table D.2.

Table D.2: Tolerance of attenuation points close to carrier

Channel separation (kHz)	Tolerance range (kHz)			
	D1	D2	D3	D4
12,5	+1,35	±0,1	-1,35	-5,35
25	+3,1	±0,1	-1,35	-5,35

Table D.3: Tolerance of attenuation points distant from the carrier

Channel separation (kHz)	Tolerance range (kHz)			
	D1	D2	D3	D4
12,5	±2,0	±2,0	±2,0	+2,0 -6,0
25	±3,5	±3,5	±3,5	+3,5 -7,5

The minimum attenuation of the filter outside the 90 dB attenuation points shall be equal to or greater than 90 dB.

D.1.2 Attenuation indicator

The attenuation indicator shall have a minimum range of 80 dB and a reading accuracy of 1 dB. With a view to future regulations an attenuation of 90 dB or more is recommended.

D.1.3 Rms value indicator

The instrument shall accurately indicate non-sinusoidal signals in ratio of up to 10:1 between peak value and rms value.

D.1.4 Oscillator and amplifier

The oscillator and the amplifier shall be designed in such a way that the measurement of the adjacent channel power of a low-noise unmodulated transmitter, whose self-noise has a negligible influence on the measurement result, yields a measured value of less than -90 dB.

Annex E (informative): Change history

Version	Information about changes
2.1.1	First version under the Radio Equipment Directive
2.2.0	Clarifications about tolerances and measurement uncertainties

History

Document history		
Edition 1	March 1997	Publication as ETSI ETS 300 698
V1.2.1/1.1.1	August 2000	Publication as ETSI EN 300 698 parts 1 and 2
V1.1.1	May 2001	Publication as ETSI EN 300 698 part 3
V1.3.1	December 2003	Publication as ETSI EN 300 698 part 1
V1.4.1/1.2.1	December 2009	Publication as ETSI EN 300 698 parts 1, 2 and 3
V2.1.1	August 2016	Publication
V2.2.0	May 2017	EN Approval Procedure AP 20170822: 2017-05-24 to 2017-08-22