

**Fixed Radio Systems;
Point-to-point equipment;
Sub-STM-1 digital radio systems operating
in the 13 GHz, 15 GHz and 18 GHz frequency bands
with about 28 MHz co-polar and 14 MHz
cross-polar channel spacing**

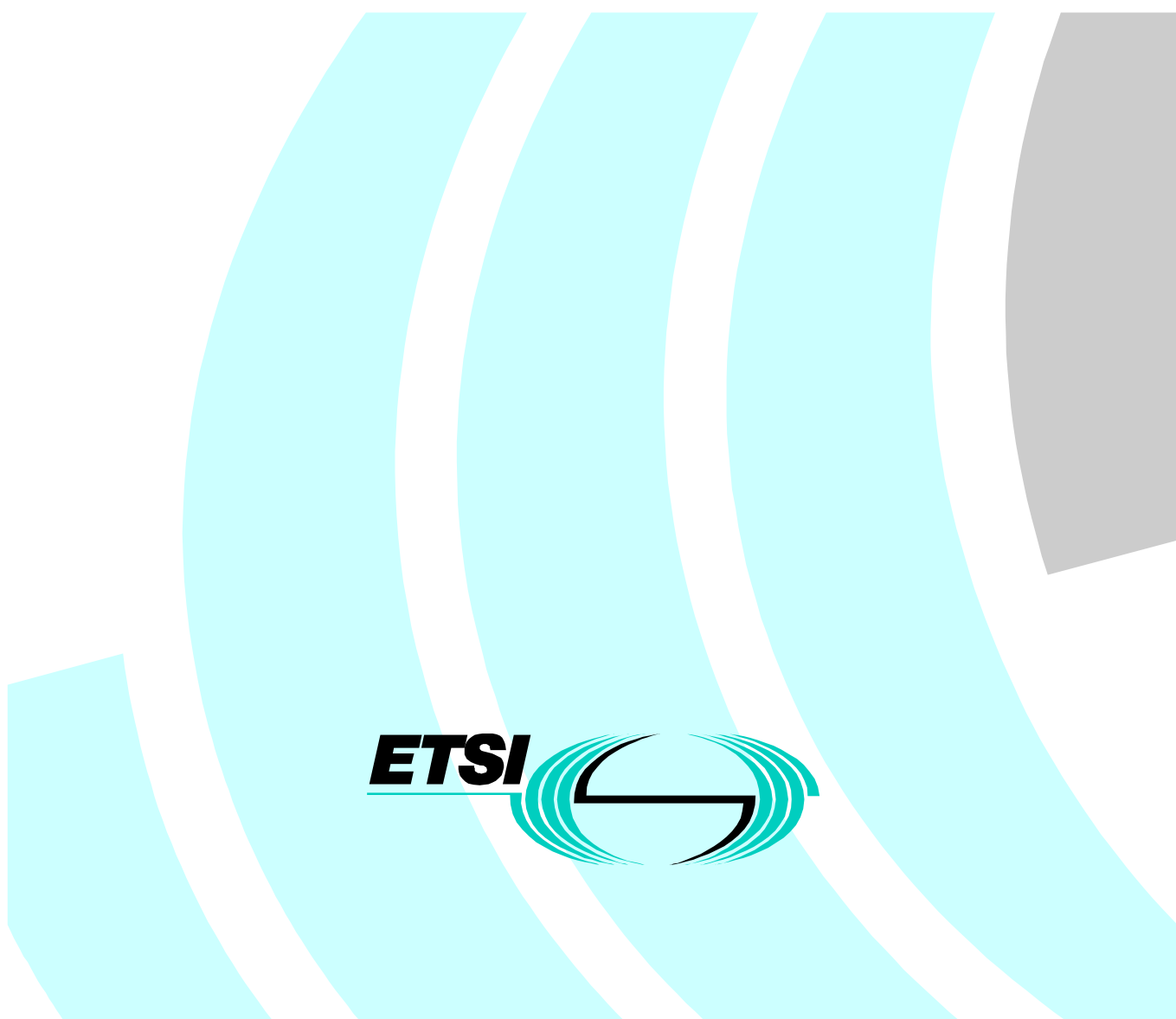

Reference

REN/TM-04111-04

KeywordsDRRS, radio, transmission, SDH, STM, PDH,
architecture**ETSI**

650 Route des Lucioles
F-06921 Sophia Antipolis Cedex - FRANCE

Tel.: +33 4 92 94 42 00 Fax: +33 4 93 65 47 16

Siret N° 348 623 562 00017 - NAF 742 C
Association à but non lucratif enregistrée à la
Sous-Préfecture de Grasse (06) N° 7803/88

Important notice

Individual copies of the present document can be downloaded from:

<http://www.etsi.org>

The present document may be made available in more than one electronic version or in print. In any case of existing or perceived difference in contents between such versions, the reference version is the Portable Document Format (PDF). In case of dispute, the reference shall be the printing on ETSI printers of the PDF version kept on a specific network drive within ETSI Secretariat.

Users of the present document should be aware that the document may be subject to revision or change of status. Information on the current status of this and other ETSI documents is available at <http://www.etsi.org/tb/status/>

If you find errors in the present document, send your comment to:
editor@etsi.fr

Copyright Notification

No part may be reproduced except as authorized by written permission.
The copyright and the foregoing restriction extend to reproduction in all media.

© European Telecommunications Standards Institute 2000.
All rights reserved.

Contents

Intellectual Property Rights	5
Foreword.....	5
1 Scope	6
2 References	7
3 Symbols and abbreviations.....	8
3.1 Symbols	8
3.2 Abbreviations	9
4 General characteristics	9
4.1 Frequency bands and channel arrangements	9
4.2 Types of installation.....	10
4.2.1 Environmental conditions.....	10
4.2.1.1 Equipment within weather protected locations (indoor locations)	10
4.2.1.2 Equipment for non-weather protected locations (outdoor locations)	10
4.3 Electromagnetic compatibility conditions.....	10
4.4 Mechanical requirements	10
4.5 Power supply.....	10
4.6 Telecommunications Management Network (TMN) interface	10
4.7 Block diagram	11
5 Baseband characteristics.....	11
5.1 Synchronous Digital Hierarchy (SDH)	11
5.2 Plesiochronous Digital Hierarchy (PDH).....	11
6 Transmitter characteristics	12
6.1 Output power	12
6.2 Automatic Transmit Power Control (ATPC)	12
6.3 RF spectrum mask.....	12
6.4 Discrete CW components exceeding the spectrum mask limit	14
6.4.1 Spectral lines at the symbol rate.....	14
6.4.2 Other spectral lines	14
6.5 Spurious emissions.....	15
6.5.1 Spurious emissions-external.....	15
6.5.2 Spurious emissions-internal.....	16
6.6 Radio frequency tolerance.....	16
7 Receiver characteristics.....	16
7.1 Receiver image rejection.....	16
7.2 Spurious emissions.....	16
7.2.1 Spurious emissions-external.....	16
7.2.2 Spurious emissions-internal.....	16
7.3 Input level range	17
8 System characteristics	17
8.1 Equipment background BER.....	17
8.2 BER as a function of receiver input level	17
8.3 Interference sensitivity	17
8.3.1 Co-channel interference sensitivity	18
8.3.1.1 Co-channel interference sensitivity	18
8.3.2 Adjacent channel sensitivity.....	19
8.3.2.1 Adjacent channel (at 28 or 27,5 MHz channel spacing respectively in the 13, 15 GHz or 18 GHz frequency band) interference sensitivity	19
8.3.2.2 Adjacent channel (at 14 MHz channel spacing in the 15 GHz frequency band) interference sensitivity	20
8.3.3 Continuous Wave (CW) spurious interference.....	21
8.4 Distortion sensitivity.....	21

Annex A (informative): Additional information	22
A.1 Branching/feeder/antenna requirement	22
A.1.1 Antenna/Equipment/Feeder flanges	22
A.1.2 Cross-Polar Discrimination (XPD).....	22
A.1.3 Intermodulation products	22
A.1.4 Interport isolation	22
A.1.5 Return loss	22
A.2 Automatic Transmit Power Control (ATPC)	23
A.3 Cross-Polar Interference Canceller (XPIC).....	23
Bibliography	24
History	25

Intellectual Property Rights

IPRs essential or potentially essential to the present document may have been declared to ETSI. The information pertaining to these essential IPRs, if any, is publicly available for **ETSI members and non-members**, and can be found in ETSI SR 000 314: "*Intellectual Property Rights (IPRs); Essential, or potentially Essential, IPRs notified to ETSI in respect of ETSI standards*", which is available from the ETSI Secretariat. Latest updates are available on the ETSI Web server (<http://www.etsi.org/ipr>).

Pursuant to the ETSI IPR Policy, no investigation, including IPR searches, has been carried out by ETSI. No guarantee can be given as to the existence of other IPRs not referenced in ETSI SR 000 314 (or the updates on the ETSI Web server) which are, or may be, or may become, essential to the present document.

Foreword

This European Standard (Telecommunications series) has been produced by ETSI Technical Committee Transmission and Multiplexing (TM), and is now submitted for the ETSI standards One-step Approval Procedure.

The present document contains the minimum technical requirements to ensure compatibility of products and conformance with radio regulations across the European states of interest to ETSI Member. Radio terminals from different manufacturers are not required to interwork at radio frequency (i.e. no common air interface).

The present document defines the requirements of radio terminal and radio relay equipment and associated interfaces. The requirements for multiplex, network management and antenna/feeder equipment may be addressed elsewhere.

The present document is a revision of EN 300 639 (V1.2.1), in which the clauses 3.2 and 6.4 have been modified to take in account the additional requirements for spectral lines present in the spectrum. The OAP only applies to these clauses.

The former title of the present document was: "Transmission and Multiplexing (TM); Sub-STM1 Digital Radio Relay Systems (DRRS) operating in the 13 GHz, 15 GHz and 18 GHz frequency bands with about 28 MHz co-polar and 14 MHz cross-polar channel spacing".

Proposed national transposition dates	
Date of latest announcement of this EN (doa):	3 months after ETSI publication
Date of latest publication of new National Standard or endorsement of this EN (dop/e):	6 months after doa
Date of withdrawal of any conflicting National Standard (dow):	6 months after doa

1 Scope

The present document specifies the minimum performance parameters for terrestrial fixed services radio communications equipment, as given below, for operation in the 13 GHz, 15 GHz and 18 GHz frequency bands (i.e. 12,75 GHz to 13,25 GHz, 14,50 GHz to 15,35 GHz and 17,70 GHz to 19,70 GHz).

The equipments covered by the present document are intended for operation with about 28 MHz basic channel spacing with frequency re-use either in 14 MHz interleaved mode or in co-channel mode (definitions are in ITU-R Recommendation F.746-4 [27]).

The present document covers equipment for the transmission of sub-Synchronous Transport Module level-1 (STM-1) digital signals with a Virtual Container-3 (VC-3) payload capacity. The standardization of sub-STM-1 radio systems for 13 GHz, 15 GHz and 18 GHz bands has been prepared to ensure the compatibility with the existing plesiochronous and the new synchronous systems concerning frequency plans and performance. The architecture and functional aspects should be in accordance with ITU-R Recommendation F.750-3 [7] and transmission characteristics and performance requirements in accordance with ITU-R Recommendation F.751-2 [8].

The present document does not cover aspects related to test procedures and test conditions which are currently under study in TM4.

The application of these Digital Radio Relay Systems (DRRS) is anticipated to be for point-to-point links in local, regional and national networks, mobile base station connections and customer access links. Consideration has to be given to special requirements of the local network (e.g. simple towers with less space for antenna, different network structures with high density nodes).

The systems considered in the present document are intended to operate on average hop lengths about 15 km for 18 GHz band, 20 km for 15 GHz band and 30 km for 13 GHz band.

Equipment should be designed in order to meet network performance and availability requirements defined by ITU-T Recommendations G.821 [18] and G.826 [19], following the criteria defined in ITU-R Recommendations F.634-4 [3], F.695 [31], F.696-2 [5], F.697-2 [6], F.1092-1 [29] and F.1189-1 [30], for high or medium or local grade or the international or the national portion of the digital connection.

The parameters to be specified fall into two categories:

- a) those that are required to provide compatibility between Radio Frequency (RF) channels occupied by different sources of equipment on the same route connected either:
 - to separate antennas; or
 - to separate polarization of the same antenna.
- b) parameters defining the transmission quality of the proposed system.

The standardization deals with Intermediate Frequency (IF), RF and baseband characteristics relevant to sub-STM-1 Synchronous Digital Hierarchy (SDH) transmission. Spurious emissions and ElectroMagnetic Compatibility (EMC) requirements are also included in the present document.

Safety aspects are outside the mandate of ETSI and they will not be considered in the present document.

2 References

The following documents contain provisions which, through reference in this text, constitute provisions of the present document.

- References are either specific (identified by date of publication, edition number, version number, etc.) or non-specific.
- For a specific reference, subsequent revisions do not apply.
- For a non-specific reference, the latest version applies.
- A non-specific reference to an ETS shall also be taken to refer to later versions published as an EN with the same number.

- [1] ITU-R Recommendation F.497-6: "Radio-frequency channel arrangements for radio-relay systems operating in the 13 GHz frequency band".
- [2] ITU-R Recommendation F.595-6: "Radio-frequency channel arrangements for radio-relay systems operating in the 18 GHz frequency band".
- [3] ITU-R Recommendation F.634-4: "Error performance objectives for real digital radio-relay links forming part of the high-grade portion of international digital connections at a bit rate below the primary rate within an integrated services digital network".
- [4] ITU-R Recommendation F.636-3: "Radio-frequency channel arrangements for radio-relay systems operating in the 15 GHz band".
- [5] ITU-R Recommendation F.696-2: "Error performance and availability objectives for hypothetical reference digital sections forming part or all of the medium-grade portion of an ISDN connection at a bit rate below the primary rate utilizing digital radio-relay systems".
- [6] ITU-R Recommendation F.697-2: "Error performance and availability objectives for the local-grade portion at each end of an ISDN connection at a bit rate below the primary rate utilizing digital radio-relay systems".
- [7] ITU-R Recommendation F.750-3: "Architectures and functional aspects of radio-relay systems for SDH-based networks".
- [8] ITU-R Recommendation F.751-2: "Transmission characteristics and performance requirements of radio-relay systems for SDH-based networks".
- [9] ITU-T Recommendation G.703: "Physical/electrical characteristics of hierarchical digital interfaces".
- [10] ITU-T Recommendation G.707: "Sub STM-O Network node interface for the synchronous digital hierarchy (SDH)".
- [11] ITU-T Recommendation G.708: "Network node interface for the synchronous digital hierarchy".
- [12] ITU-T Recommendation G.707: "Synchronous multiplexing structure".
- [13] ITU-T Recommendation G.773: "Protocol suites for Q interfaces for management of transmission systems".
- [14] ITU-T Recommendation G.781: "Synchronization layer functions".
- [15] ITU-T Recommendation G.783: "Types and general characteristics of synchronous digital hierarchy (SDH) equipment".
- [16] ITU-T Recommendation G.783: "Characteristics of synchronous digital hierarchy (SDH) equipment functional blocks".
- [17] ITU-T Recommendation G.784: "Synchronous digital hierarchy (SDH) management".

- [18] ITU-T Recommendation G.821: "Error performance of an international digital connection operating at a bit rate below the primary rate and forming part of an integrated services digital network".
- [19] ITU-T Recommendation G.826: "Error performance parameters and objectives for international, constant bit rate digital paths at or above the primary rate".
- [20] ITU-T Recommendation G.957: "Optical interfaces for equipments and systems relating to the synchronous digital hierarchy".
- [21] CEPT/ERC Recommendation 74-01: "Spurious Emissions".
- [22] ETSI EN 300 385: "Electromagnetic compatibility and Radio spectrum Matters (ERM); ElectroMagnetic Compatibility (EMC) standard for fixed radio links and ancillary equipment".
- [23] ETSI ETS 300 132: "Equipment Engineering (EE); Power supply interface at the input to telecommunications equipment".
- [24] ETSI ETS 300 174 (1992): "Network Aspects (NA); Digital coding of component television signals for contribution quality applications in the range 34-45 Mbit/s".
- [25] IEC 60835-2-4 (1993): "Methods of measurement for equipment used in digital microwave radio transmission systems-Part 2: Measurements on terrestrial radio-relay systems-Section 4: Transmitter/receiver including modulator/demodulator".
- [26] IEC 60835-2-8 (1993): "Methods of measurement for equipment used in digital microwave radio transmission systems-Part 2: Measurements on terrestrial radio-relay systems-Section 8: Adaptive equalizer".
- [27] ITU-R Recommendation F.746-4: "Radio-frequency channel arrangements for radio-relay systems".
- [28] ETSI ETS 300 119: "Equipment Engineering (EE); European telecommunication standard for equipment practice".
- [29] ITU-R Recommendation F.1092-1: "Error performance objectives for constant bit rate digital path at or above the primary rate carried by digital radio-relay systems which may form part of the international portion of a 27 500 km hypothetical reference path".
- [30] ITU-R Recommendation F.1189-1: "Error performance objectives for constant bit rate digital paths at or above the primary rate carried by digital radio-relay systems which may form part or all of the national portion of a 27 500 km hypothetical reference path".
- [31] ITU-R Recommendation F.695: "Availability objectives for real digital radio-relay links forming part of a high-grade circuit within an integrated services digital network".

3 Symbols and abbreviations

3.1 Symbols

For the purposes of the present document, the following symbols apply:

dB	decibel
dBm	decibel relative to 1 mW
GHz	Gigahertz
km	kilometre
Mbit/s	Megabit per second
MHz	Megahertz
ns	nanosecond
ppm	parts per million

3.2 Abbreviations

For the purposes of the present document, the following abbreviations apply:

ATPC	Automatic Transmit Power Control
BB	BaseBand
BER	Bit Error Rate
BWe	evaluation BandWidth (of spectrum analyser)
CMI	Coded Mark Inversion
<u>CSmin</u>	<u>minimum practical Channel Separation (for a given radio-frequency channel arrangement)</u>
CW	Continuous Wave
IF	Intermediate Frequency
IF/RF	Intermediate Frequency/Radio Frequency
LO	Local Oscillator
NNI	Network Node Interface
PDH	Plesiochronous Digital Hierarchy
PRBS	Pseudo-Random Binary Sequence
QAM	Quadrature Amplitude Modulation
RF	Radio Frequency
RSL	Receive Signal Level
R _x	Receiver
SDH	Synchronous Digital Hierarchy
SOH	Section OverHead
SRL	Spectrum Reference Level
STM-1	Synchronous Transport Module (level) -1
TM	Transmission and Multiplex
TMN	Telecommunications Management Network
T _x	Transmitter
VSWR	Voltage Standing Wave Ratio
XPD	Cross-Polar Discrimination

4 General characteristics

4.1 Frequency bands and channel arrangements

The frequency bands covered by the present document are the 12,75 GHz to 13,25 GHz, 14,5 GHz to 15,35 GHz and the 17,7 GHz to 19,7 GHz fixed service bands.

The channelling arrangement for the 13 GHz frequency band is the plan with 28 MHz adjacent channel spacing according to ITU-R Recommendation F.497-6 [1] and to the relevant CEPT Recommendation: where applicable frequency re-use in co-channel mode can be envisaged (according to hop length and climate zone).

The channelling arrangement for the 15 GHz frequency band is a basic plan with 28 MHz co-polar spacing with frequency re-use either in 14 MHz interleaved mode or, where applicable (according to hop length and climate zone), in co-channel mode. The separation of the innermost transmit and receive channel centre frequencies will be equal to $N \times 28$ MHz ($N = \text{integer}$) and greater than 84 MHz (see ITU-R Recommendation F.636-3 [4] and the relevant CEPT Recommendation).

The channelling arrangements for the 18 GHz frequency band is a plan with 27,5 MHz adjacent channel co-polar spacing according to the ITU-R Recommendation F.595-6 [2] and the relevant CEPT Recommendation.

Equipment shall be designed in order to meet network performance and availability requirements defined by ITU-T Recommendations G.821 [18] and G.826 [19], following the criteria defined in ITU-R Recommendations F.634-4 [3], F.695 [31], F.696-2 [5], F.697-2 [6], F.1092-1 [29] and ITU-R Recommendation F.1189-1 [30], for high or medium or local grade or the international or the national portion of the digital connection.

4.2 Types of installation

Both indoor and partially outdoor installations are considered.

4.2.1 Environmental conditions

The equipment shall be required to meet the environmental conditions set out in ETS 300 119 [28] which defines weather protected and non-weather protected locations, classes and test severity.

The manufacturer shall state which class the equipment is designed to withstand.

4.2.1.1 Equipment within weather protected locations (indoor locations)

Equipment intended for operation within temperature controlled locations or partially temperature controlled locations shall meet the requirements of ETS 300 119 [28] classes 3.1 and 3.2 respectively.

Optionally, the more stringent requirements of ETS 300 119 [28] classes 3.3 (non-temperature controlled locations), 3.4 (sites with heat trap) and 3.5 (sheltered locations) may be applied.

4.2.1.2 Equipment for non-weather protected locations (outdoor locations)

Equipment intended for operation within non-weather protected locations shall meet the requirements of ETS 300 119 [28], class 4.1 or 4.1E.

Class 4.1 applies to many European countries and class 4.1E applies to all European countries.

4.3 Electromagnetic compatibility conditions

Equipment shall operate under the conditions specified in EN 300 385 [22].

4.4 Mechanical requirements

The mechanical dimensions for indoor installations shall be in agreement with ETS 300 119 [28].

The outdoor unit shall be separable from the antenna.

In order to be easily handled by one man, the weight of any single separate unit shall not exceed 15 kg.

4.5 Power supply

The power supply interface shall be in accordance with the characteristics of one or more of the secondary voltages foreseen in ETS 300 132 [23].

NOTE: Some applications may require secondary voltages that are not covered by ETS 300 132 [23].

For DC systems, the positive pole of the voltage supply will be earthed at the source.

4.6 Telecommunications Management Network (TMN) interface

A TMN interface required by a user shall follow ETSI TM2 and TM3 standards and be in accordance with ITU-T Recommendations G.784 [17], G.773 [13] and ITU-R Recommendation F.750-3 [7].

4.7 Block diagram

The system block diagram is shown in figure 1. The intersection points are for reference only and not necessarily for measurement purposes nor do they indicate a specific design structure.

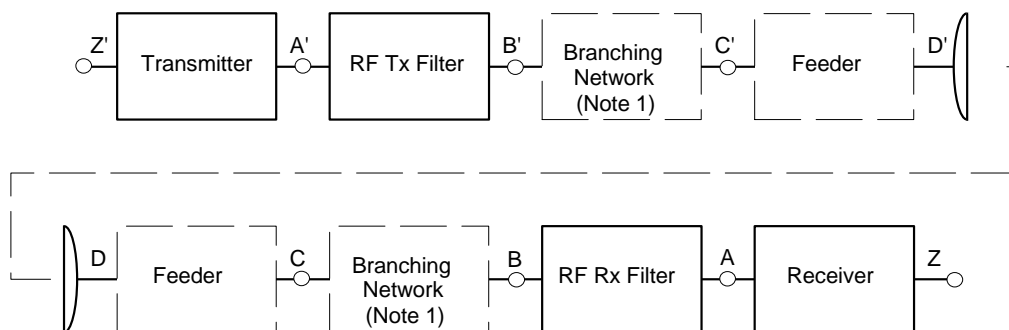

NOTE 1: Points B and C, B' and C' may coincide.

NOTE 2: The branching network does not include the RF filtering. In outdoor equipment, the branching network may be implemented by a common TX-RX duplexer.

Figure 1: Block diagram

5 Baseband characteristics

5.1 Synchronous Digital Hierarchy (SDH)

The SDH baseband interface shall be a Network Node Interface (NNI) at the STM-1 level in accordance with ITU-T Recommendations G.703 [9], ITU-T Recommendation G.707 [10], G.708 [11], G.709 [12], G.781 [14], G.782 [15], G.783 [16], G.784 [17] and G.957 [20] (with possible simplifications under study in ETSI TM3 and TM4) and ITU-R Recommendation F.750-3 [7].

Two versions of the STM-1 interface are possible:

- a Coded Mark Inversion (CMI) electrical interface (ITU-T Recommendation G.703 [9] and ITU-T Recommendation G.708 [11]);
- optical interface (ITU-T Recommendation G.957 [20]).

The use of reserved bytes contained in the Section Overhead (SOH), and their termination shall be in accordance with ITU-R Recommendation F.750-3 [7].

5.2 Plesiochronous Digital Hierarchy (PDH)

Optional PDH baseband interfaces may be required; they shall be in accordance with ITU-T Recommendation G.703 [9] for:

- 2 Mbit/s; and
- 34 Mbit/s.

For digital video applications (ETS 300 174 [24] covering VC2-5c concatenation) an interface at 45 Mbit/s in accordance with ITU-T Recommendation G.703 [9] (clause 5) may be required.

6 Transmitter characteristics

6.1 Output power

Transmitter output power (nominal and tolerance) at reference point B' (for equipment with a multi-channel branching system) or C' (for equipment with a simple duplexer), defined in figure 1, shall not exceed + 30 dBm.

Administrations and operators may require specific output power ranges.

For indoor installation, the tolerance value around the nominal value is ± 1 dB.

For the outdoor installation, the tolerance value is + 2/-1 dB.

A capability for output power level adjustment may be required for regulatory purposes, in which case a mean of adjustment, either by fixed or automatic attenuators, shall be provided.

In the case of STM-1 interface, the measurement of output power shall be carried out using an STM-1 test signal (to be defined).

In the case of PDH signals, the measurement of output power shall be carried out with the carrier modulated by a Pseudo-Random Binary Sequence (PRBS) of length $2^{23} - 1$ for the 34 Mbit/s interface and a length of $2^{15} - 1$ for the 2 Mbit/s interface.

6.2 Automatic Transmit Power Control (ATPC)

ATPC is an optional feature; information on ATPC is given in informative annex A (see clause A.2).

6.3 RF spectrum mask

The spectrum mask is shown in figure 2. The spectrum mask shall be verified directly by measurement (as the spectrum mask is a relative measurement it can be referenced either to point B' or C').

The mask shall be measured with a modulating baseband signal. In the case of a PDH interface, a PRBS of $2^{23} - 1$ for 34 Mbit/s interface and a length of $2^{15} - 1$ for 2 Mbit/s interface, shall be used. In the case of a SDH interface, a STM-1 test signal shall be defined.

The peak of the transmitter spectrum at the channel centre frequency, excluding any residual carrier, is set to the 0 dB Spectrum Reference Level (SRL). The mask is measured with a transmit output power equal to the nominal value and it shall be met in all ATPC conditions.

The mask does not include frequency tolerance.

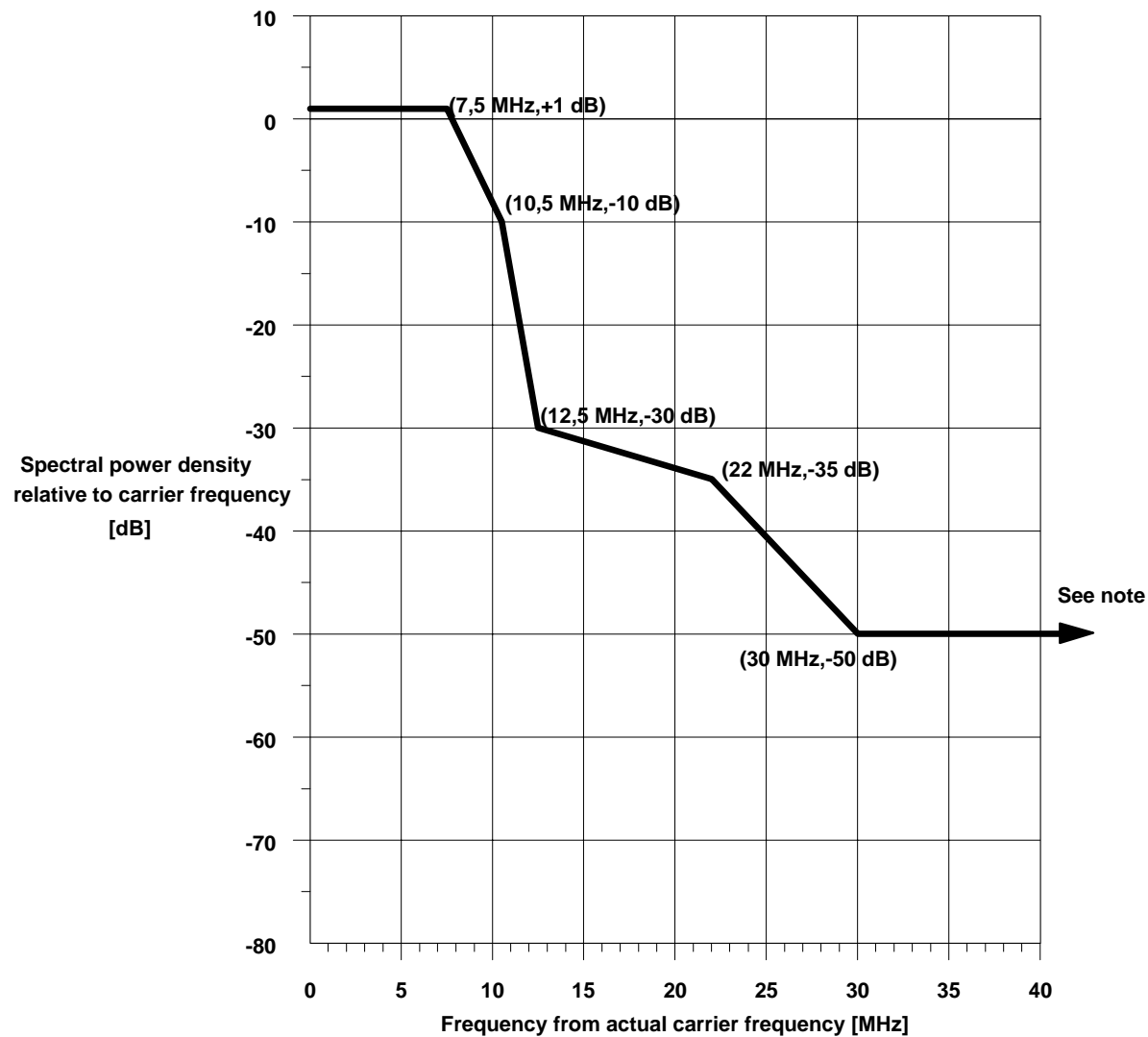

NOTE: The value of -50 dB shall be met up to 70 MHz for the 13 and 15 GHz bands and up to 68,75 MHz for 18 GHz band.

Figure 2: Spectral power density for 13 GHz, 15 GHz and 18 GHz

The spectrum analyser settings for measuring the RF spectrum mask detailed in figure 2 are shown in table 1.

Table 1: Spectrum analyser settings

Parameter	Setting
IF Bandwidth	100 kHz
Total sweep width	200 MHz
Total scan time	Automatic
Video filter bandwidth	0,3 kHz

6.4 Discrete CW components exceeding the spectrum mask limit ~~Spectral lines at the symbol rate~~

6.4.1 Spectral lines at the symbol rate

The RF spectrum mask shall not apply to the spectral lines at the symbol rate.

The power level of these spectral lines at a distance from the channel centre frequency equal to the symbol rate shall be less than -20 dBm at reference point B' (for equipment with multi-channel branching system) or C' (for equipment with simple duplexer), defined in figure 1.

6.4.2 Other spectral lines

In case some CW components exceed the spectrum mask, an additional allowance is given.

Those lines shall not:

- exceed the mask by a factor more than $\{10 \log (CS_{min}/IF_{bw}) - 10\}$ dB (note);
- be spaced each other in frequency by less than CS_{min} .

Where:

$$CS_{min} = 1\,750 \text{ kHz for } 13 \text{ GHz, } 15 \text{ GHz and } 18 \text{ GHz bands}$$

IFbw is the recommended resolution bandwidth, expressed in kHz, reported in table 1.

NOTE: In case the calculation of the allowance factor will result in a negative value, no additional allowance is then permitted.

Figure 3 shows a typical example of this requirement.

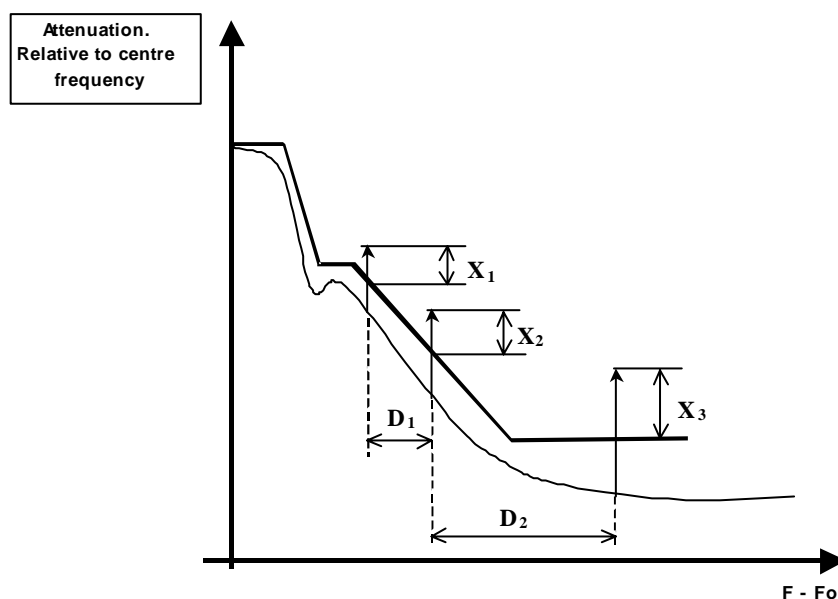

$$X_1, X_2, X_3 \text{ [dB]} \leq 10 \log(CS_{\min} / IF_{bw}) - 10$$

$$D_1, D_2 \geq CS_{\min}$$

Figure 3: CW lines exceeding the spectrum mask (typical example)

6.5 Spurious emissions

It is necessary to define spurious emissions for two reasons:

- to limit interference into other systems operating wholly externally to the system under consideration (external emissions), which limits are referred by CEPT/ERC Recommendation 74-01 [21];
- to limit local interference within the system channel plan where transmitters and receivers may be directly connected via the filter and branching systems (internal emissions).

This leads to two sets of spurious emission limits at reference point B' (for equipment with multi-channel branching system) or C' (for equipment with simple duplexer).

6.5.1 Spurious emissions-external

According to CEPT/ERC Recommendation 74-01 [21], the external spurious emissions are defined as emissions at frequencies which are removed from the nominal carrier frequency more than $\pm 250\%$ of the relevant channel separation.

Outside the band of $\pm 250\%$ of the relevant channel separation (CS), the Fixed Service radio systems spurious emission limits, defined by CEPT/ERC Recommendation 74-01 [21] together with the frequency range to consider for conformance measurement, shall apply at reference point C'.

6.5.2 Spurious emissions-internal

The levels of the spurious emissions are specified in table 2. The limits shall be met at reference point B' for equipment with multichannel branching system or C' for equipment with a simple duplexer.

Table 2: Spurious emission limits-internal

Spurious emission frequency relative to channel assigned frequency	Specification limit	Controlling factor
The level of all spurious signals (including LO, \pm IF, $\pm 2 \times$ IF)	≤ -90 dBm	If spurious signal frequency falls within receiver half band.
The level of all spurious signals (including LO, \pm IF, $\pm 2 \times$ IF)	≤ -70 dBm	If spurious signal frequency falls within receiver half band. For digital systems without branching networks (i.e. with duplexer) or on different polarization.

NOTE: LO = Local Oscillator.

6.6 Radio frequency tolerance

Maximum radio frequency tolerance shall not exceed ± 30 ppm. This limit includes both long-term ageing and short-term effects (e.g. environmental factors).

7 Receiver characteristics

7.1 Receiver image rejection

If applicable the receiver image rejection shall be ≥ 90 dB.

7.2 Spurious emissions

It is necessary to define spurious emissions for two reasons:

- a) to limit interference into other systems operating wholly externally to the system under consideration (external emissions), which limits are referred by CEPT/ERC Recommendation 74-01 [21];
- b) to limit local interference within the system channel plan where transmitters and receivers may be directly connected via the filter and branching systems (internal emissions).

This leads to two sets of spurious emission limits at reference point B' (for equipment with multi-channel branching system) or C' (for equipment with simple duplexer).

7.2.1 Spurious emissions-external

At the reference point C, the limit values of CEPT/ERC Recommendation 74-01 [21] shall apply.

7.2.2 Spurious emissions-internal

For spurious emissions at the local oscillator frequency limits of ≤ -110 dBm shall apply.

7.3 Input level range

The input level range for a Bit Error Rate (BER) of $\leq 10^{-3}$ shall extend from the upper limit of -17 dBm or more to the limit specified for BER = 10^{-3} in clause 8.2.

The input level range for a BER of $\leq 10^{-10}$ shall extend from the upper limit of -21 dBm or more to the limit specified for BER = 10^{-10} in clause 8.2.

These limits apply without interference and are referenced to reference point B (for equipment with multi-channel branching system) or C (for equipment with simple duplexer) of figure 1.

8 System characteristics

8.1 Equipment background BER

Equipment background BER is measured under simulated operating conditions over an artificial hop without interference with a signal level at point B which is between 15 dB and 40 dB above the lower limit for receiver input level which gives BER = 10^{-3} .

In a measurement period of 24 hours the number of bit errors shall be less than 10.

8.2 BER as a function of receiver input level

The reference point for the definition of the BER curve as a function of receiver input level is point B.

Receiver BER thresholds (dBm) referred to reference point B (for equipment with multi-channel branching system) or C (for equipment with simple duplexer) for BERs = 10^{-3} , 10^{-6} and 10^{-10} shall be equal to or lower than those stated in table 3.

Table 3: Receiver sensitivity

BER	Receiver sensitivity 13 GHz	Receiver sensitivity 15 GHz	Receiver sensitivity 18 GHz
10^{-3}	-77 dBm	-76 dBm	-76 dBm
10^{-6}	-74 dBm	-73 dBm	-73 dBm
10^{-10}	-71 dBm	-70 dBm	-70 dBm

8.3 Interference sensitivity

All receive signal levels and Signal Interference (S/I) measurements shall be referred to point B of the block diagram in figure 1.

8.3.1 Co-channel interference sensitivity

The limits of the co-channel interference sensitivity shall be as given in figure 4.

8.3.1.1 Co-channel interference sensitivity

For a receiver operating at 10^{-3} and 10^{-6} BER threshold given in table 3 in absence of interference signal, the introduction of a single like interferer at the co-channel frequency at a level given in table 4 shall not result in an increase of the threshold level greater than the limits reported in table 4.

The limits of co-channel interference shall be as given in table 4, giving maximum S/I values for 1 dB and 3 dB degradation of the 10^{-6} and 10^{-3} BER limits as given in figure 4.

Table 4: Co-channel interference sensitivity

BER	10^{-3}		10^{-6}	
Threshold degradation	1 dB	3 dB	1 dB	3 dB
S/I	26 dB	22 dB	30 dB	26,5 dB

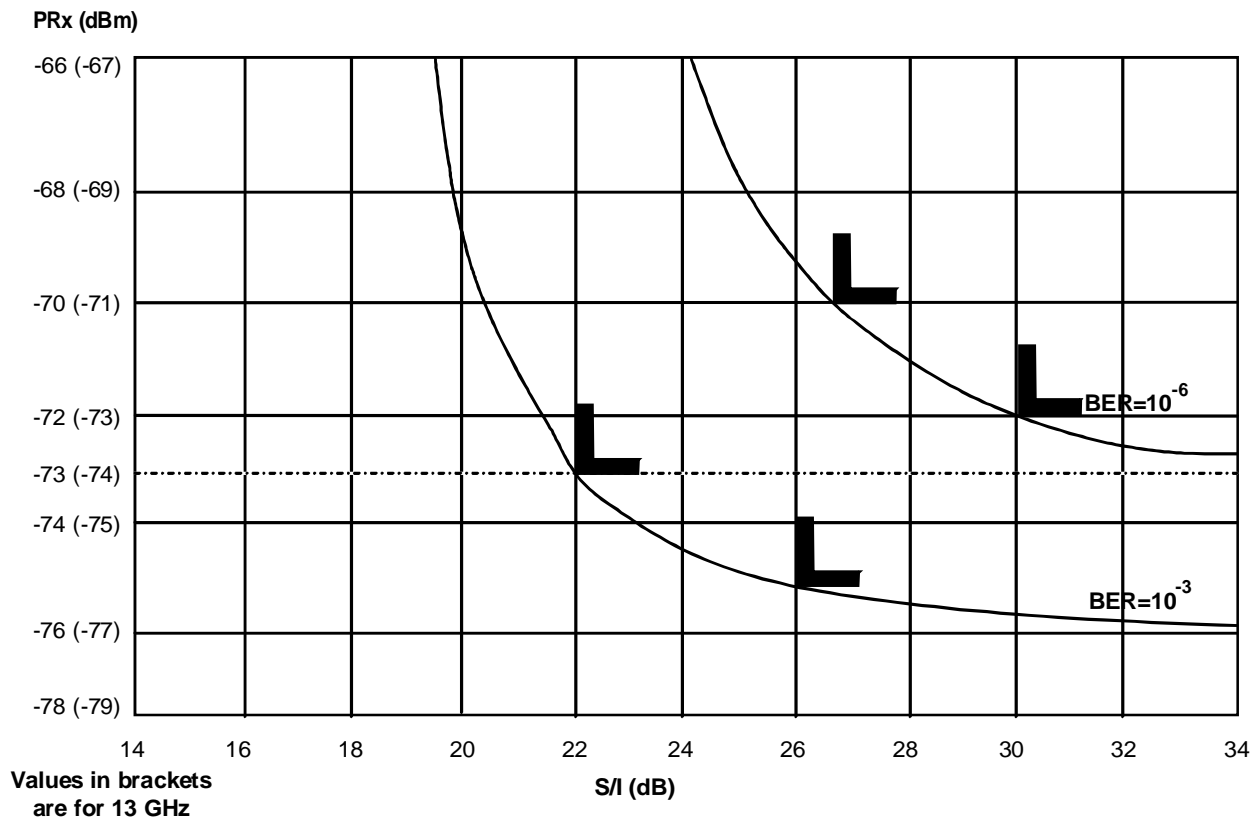

Figure 4: Co-channel digital interference mask for sub-STM-1, 13 GHz, 15 GHz and 18 GHz

8.3.2 Adjacent channel sensitivity

The limit of the adjacent channel (at 28 or 27,5 MHz channel spacing respectively in the 13 or 18 GHz frequency band and at 14 MHz channel spacing in the 15 GHz frequency band) sensitivity shall be as given in figures 5 and 6 respectively.

8.3.2.1 Adjacent channel (at 28 or 27,5 MHz channel spacing respectively in the 13, 15 GHz or 18 GHz frequency band) interference sensitivity

For a receiver operating at 10^{-3} and 10^{-6} BER threshold given in table 3 in absence of interference signal, the introduction of a single like interferer at the adjacent-channel frequency at a level given in table 5 shall not result in an increase of the threshold level greater than the limits reported in table 5.

The limits of adjacent channel interference shall be as given in table 5, giving maximum S/I values for 1 dB and 3 dB degradation of the 10^{-6} and 10^{-3} BER limits as given in figure 5.

Table 5: Adjacent-channel interference sensitivity

BER	10^{-3}		10^{-6}	
	1 dB	3 dB	1 dB	3 dB
Threshold degradation				
S/I	-14 dB	-18 dB	-10 dB	-13,5 dB

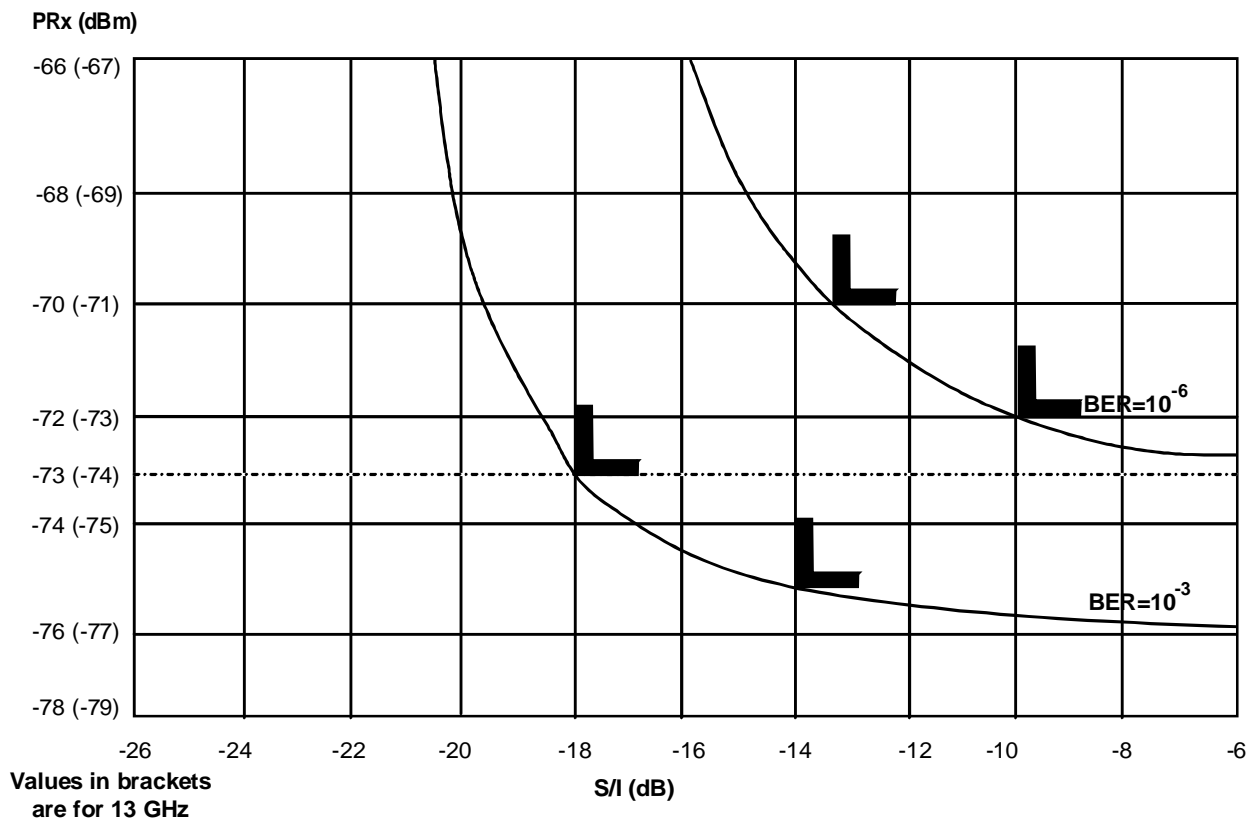

Figure 5: Adjacent channel digital interference mask for sub-STM-1,13 GHz, 15 GHz and 18 GHz (28/27,5 MHz channel spacing)

8.3.2.2 Adjacent channel (at 14 MHz channel spacing in the 15 GHz frequency band) interference sensitivity

For a receiver operating at 10^{-3} and 10^{-6} BER threshold given in table 3 in absence of interference signal, the introduction of a single like interferer at the adjacent-channel frequency at a level given in table 6 shall not result in an increase of the threshold level greater than the limits reported in table 6.

The limits of adjacent channel interference shall be as given in table 6 giving maximum S/I values for 1 dB and 3 dB degradation of the 10^{-6} and 10^{-3} BER limits as given in figure 6.

Table 6: Adjacent-channel interference sensitivity

BER	10^{-3}		10^{-6}	
Threshold degradation	1 dB	3 dB	1 dB	3 dB
S/I	14 dB	10 dB	18 dB	14,5 dB

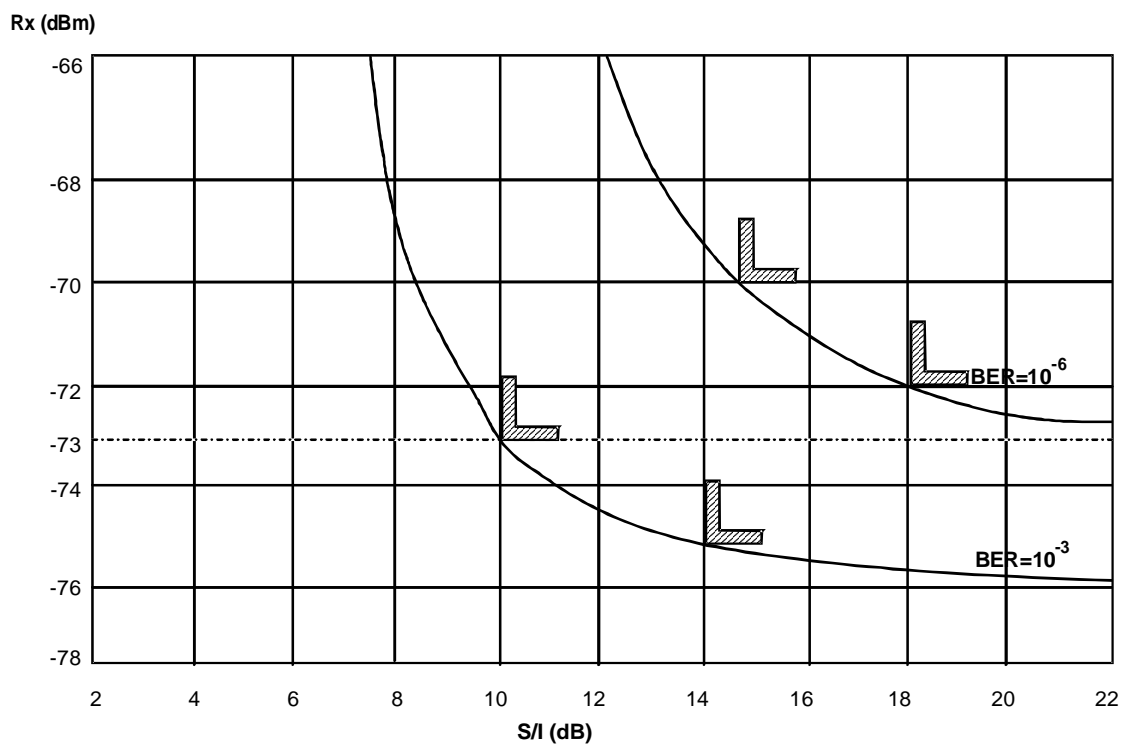

Figure 6: Adjacent channel digital interference mask for sub-STM-1 15 GHz (14 MHz channel spacing)

8.3.3 Continuous Wave (CW) spurious interference

For a receiver operating at the 10^{-6} BER threshold given in table 3, the introduction of a CW interferer at a level of + 30 dB, with respect to the "wanted" signal at any frequency in the range 1 GHz to 40 GHz (see note), excluding frequencies either side of the wanted frequency by up to twice the co-polar channel spacing, shall not result in a BER greater than 10^{-5} .

NOTE: When waveguide is used between reference point C and A, which length is higher than twice the free space wavelength of cut-off frequency (F_c), the lower limit of measurement will be increased to $0,7 F_c$ and to $0,9 F_c$ when the length is higher than four times the same wavelength.

This test is designed to identify specific frequencies at which the receiver may have a spurious response: e.g. image frequency, harmonics of the receive filter etc. The test is not intended to imply a relaxed specification at all out-of-band frequencies.

8.4 Distortion sensitivity

The relevant parameters for distortion sensitivity signatures are given below.

For two path propagation with a delay of 6,3 ns and a BER of 10^{-3} , the width of the signature shall not exceed 11 MHz relative to the assigned channel centre frequency, the depth shall not be less than 22 dB.

For two path propagation with a delay of 6,3 ns and a BER of 10^{-6} , the width of the signature shall not exceed 13 MHz relative to the assigned channel centre frequency, the depth shall not be less than 20 dB.

These limits are both valid for minimum and non-minimum phase cases. They shall also be verified by the loss-of-synchronization and re-acquisition of synchronization signatures (see IEC 835-2-4 [25] and IEC 835-2-8 [26]). Because rainfall in 18 GHz band is the main propagation factor limiting performance, therefore in this band the above limits are not mandatory.

Annex A (informative): Additional information

A.1 Branching/feeder/antenna requirement

The parameters and values given below are used as a basis for the system performance characteristics given in the present document and are provided for guidance.

A.1.1 Antenna/Equipment/Feeder flanges

When waveguides are required, standard IEC flanges should be used for the frequency bands in question.

A.1.2 Cross-Polar Discrimination (XPD)

The antenna XPD value within the 1 dB beamwidth is assumed to be not less than 30 dB.

A.1.3 Intermodulation products

For systems with multi-channel branching, each intermodulation product caused by different transmitters linked at point C' to a measurement test set with a return loss higher than 23 dB is assumed to be less than -110 dBm referenced to point B for transmitter output power levels up to 20 dBm per transmitter.

A.1.4 Interport isolation

Indicative value is assumed to be not less than 40 dB.

A.1.5 Return loss

Minimum return loss measured in the direction toward the antenna circulator at point C or C' is assumed to be 26 dB; this limit applies to 12,75 to 13,25 GHz, 14,5 to 15,35 GHz and 17,7 to 19,7 GHz depending on the utilized frequency band.

For partially outdoor equipment using a duplexer, the minimum return loss at point C' or C in the direction toward the duplexer is assumed to be 20 dB; this limit applies in a frequency band equal to ± 10 MHz referred to the nominal transmit and receive channels centre frequencies.

The minimum return loss of the feeder/antenna system connected to indoor systems is assumed to be not less than 26 dB. This limit applies to 12,75 to 13,25 GHz, 14,5 to 15,35 GHz and 17,7 to 19,7 GHz depending on the utilized frequency band.

For partially outdoor systems, the antenna return loss is assumed to be better than 20 dB. The measurement shall be referred to point C/C' towards the antenna.

A.2 Automatic Transmit Power Control (ATPC)

ATPC may be useful in some circumstances, e.g:

- to reduce digital-to-digital distant interference between hops which re-use the same frequency;
- to improve compatibility with digital systems at nodal stations;
- to increase system gain as a countermeasure against rainfall attenuation.

ATPC is an optional feature which is aimed at driving the transmit power amplifier output level from a proper minimum calculated to facilitate the radio network planning. Additionally, this figure is used in case of normal propagation up to a maximum value which fulfils all the specifications defined in the present document.

ATPC may also be used to increase the output power above the nominal level up to the maximum level specified by administrations and operators during fading conditions. This can be useful because in frequency ranges above 13 GHz the main limiting factors are given by non-selective fading events.

The ATPC range is defined as the power interval from the maximum (including tolerances) output power level to the lowest transmitter output power level (at point B') with ATPC.

The ATPC range should not exceed 15 dB. In any case the lowest transmitter output power level should not be less than + 5 dBm, this may result in a reduced ATPC range.

A.3 Cross-Polar Interference Canceller (XPIC)

In the case of a system using CCDP, hop lengths above which the use of XPIC is required should be examined for the different European climatic zones.

Bibliography

The following material, though not specifically referenced in the body of the present document (or not publicly available), gives supporting information.

- ITU-R Recommendation F.403-3: "Intermediate-frequency characteristics for the interconnection of analogue radio-relay systems".
- ITU-R Recommendation F.557-4: "Availability objective for radio-relay systems over a hypothetical reference circuit and a hypothetical reference digital path".
- ITU-R Recommendation F.1191-1: "Bandwidths and unwanted emissions of digital radio-relay systems".
- CENELEC EN 60950 (1991): "Safety of information technology equipment".

History

Document history		
Edition 1	October 1996	Published as ETS 300 639
V1.2.1	March 2000	Publication
V1.3.1	October 2000	One-step Approval Procedure OAP 20010216: 2000-10-18 to 2001-02-16