

# ETSI EN 300 430 V1.3.1 (2001-02)

---

*European Standard (Telecommunications series)*

**Fixed Radio Systems;  
Point-to-point equipment;  
Parameters for radio systems for the transmission of STM-1  
digital signals operating in the 18 GHz frequency band  
with channel spacing of 55 MHz and 27,5 MHz**

---



---

**Reference**

REN/TM-04111-13

---

**Keywords**architecture, DRRS, PDH, point-to-point, SDH,  
STM, transmission**ETSI**

---

650 Route des Lucioles  
F-06921 Sophia Antipolis Cedex - FRANCE

Tel.: +33 4 92 94 42 00 Fax: +33 4 93 65 47 16

Siret N° 348 623 562 00017 - NAF 742 C  
Association à but non lucratif enregistrée à la  
Sous-Préfecture de Grasse (06) N° 7803/88

---

**Important notice**

Individual copies of the present document can be downloaded from:

<http://www.etsi.org>

The present document may be made available in more than one electronic version or in print. In any case of existing or perceived difference in contents between such versions, the reference version is the Portable Document Format (PDF). In case of dispute, the reference shall be the printing on ETSI printers of the PDF version kept on a specific network drive within ETSI Secretariat.

Users of the present document should be aware that the document may be subject to revision or change of status. Information on the current status of this and other ETSI documents is available at <http://www.etsi.org/tb/status/>

If you find errors in the present document, send your comment to:  
editor@etsi.fr

---

**Copyright Notification**

No part may be reproduced except as authorized by written permission.  
The copyright and the foregoing restriction extend to reproduction in all media.

© European Telecommunications Standards Institute 2001.  
All rights reserved.

# Contents

Intellectual Property Rights .....	5
Foreword.....	5
1 Scope.....	6
2 References.....	7
3 Symbols and abbreviations.....	9
3.1 Symbols.....	9
3.2 Abbreviations.....	9
4 General characteristics .....	10
4.1 Frequency bands and channel arrangements.....	10
4.1.1 Channel arrangements.....	10
4.1.2 Channel spacing for systems operating on the same route .....	10
4.2 Compatibility requirements between systems .....	10
4.3 Performance and availability requirements.....	10
4.4 Environmental conditions .....	10
4.4.1 Equipment within weather protected locations (indoor locations).....	11
4.4.2 Equipment for non-weather protected locations (outdoor locations).....	11
4.5 Power supply.....	11
4.6 Electromagnetic compatibility .....	11
4.7 System block diagram .....	11
4.8 Telecommunications Management Network (TMN) interface.....	12
4.9 Branching/feeder/antenna characteristics.....	12
4.9.1 Antenna radiation patterns.....	12
4.9.2 Antenna cross-Polar Discrimination (XPD) .....	12
4.9.3 Antenna Inter-Port Isolation (IPI).....	12
4.9.4 Waveguide flanges (or other connectors).....	12
4.9.5 Return loss.....	12
5 System Parameters.....	12
5.1 Transmission capacity .....	12
5.2 Baseband parameters .....	12
5.2.1 Plesiochronous interfaces .....	13
5.2.2 SDH baseband interface.....	13
5.3 Transmitter characteristics .....	13
5.3.1 Transmitter power range .....	13
5.3.2 Transmit power and frequency control.....	13
5.3.2.1 Automatic Transmit Power Control (ATPC).....	13
5.3.2.2 Remote Transmit Power Control (RTPC).....	14
5.3.2.3 Remote Frequency Control (RFC).....	14
5.3.3 Transmitter output power tolerance .....	14
5.3.4 Transmit Local Oscillator (LO) frequency arrangements.....	14
5.3.5 RF spectrum mask.....	15
5.3.6 Discrete CW lines exceeding the spectrum mask limit .....	18
5.3.6.1 Spectral lines at the symbol rate.....	18
5.3.6.2 Other spectral lines .....	18
5.3.7 Spurious emissions.....	19
5.3.7.1 Spurious emissions-external.....	19
5.3.7.2 Spurious emissions-internal .....	20
5.3.8 Radio frequency tolerance.....	20
5.4 Receiver characteristics .....	20
5.4.1 Input level range .....	20
5.4.2 Receiver image rejection .....	20
5.4.3 Spurious emissions-external .....	21
5.4.4 Spurious emissions-internal.....	21
5.5 System performance without diversity .....	21

5.5.1	BER as a function of Receiver input Signal Level (RSL) .....	21
5.5.2	Equipment Residual BER.....	21
5.5.3	Interference sensitivity .....	22
5.5.3.1	Co-channel interference sensitivity.....	22
5.5.3.2	Adjacent channel Interference.....	22
5.5.3.3	CW Spurious Interference.....	23
5.5.4	Distortion sensitivity .....	23
5.6	System characteristics with diversity.....	23
<b>Annex A (informative): Additional information .....</b>		<b>24</b>
A.1	Radio frequency channel arrangement.....	24
A.2	Feeder/antenna return loss.....	24
A.3	Automatic Transmit Power Control (ATPC) .....	25
A.4	Spectrum masks.....	25
A.5	RBER.....	26
A.6	Co-channel and adjacent channel interference .....	27
<b>Annex B (normative): Essential requirements for the EC Council Directive 89/336 (EMC Directive).....</b>		<b>29</b>
<b>Annex C (normative): System type codes for regulatory procedures .....</b>		<b>30</b>
Bibliography.....		31
History .....		32

---

## Intellectual Property Rights

IPRs essential or potentially essential to the present document may have been declared to ETSI. The information pertaining to these essential IPRs, if any, is publicly available for **ETSI members and non-members**, and can be found in ETSI SR 000 314: "*Intellectual Property Rights (IPRs); Essential, or potentially Essential, IPRs notified to ETSI in respect of ETSI standards*", which is available from the ETSI Secretariat. Latest updates are available on the ETSI Web server (<http://www.etsi.org/ipr>).

Pursuant to the ETSI IPR Policy, no investigation, including IPR searches, has been carried out by ETSI. No guarantee can be given as to the existence of other IPRs not referenced in ETSI SR 000 314 (or the updates on the ETSI Web server) which are, or may be, or may become, essential to the present document.

---

## Foreword

This European Standard (Telecommunications series) has been produced by ETSI Technical Committee Transmission and Multiplexing (TM).

The present document contains the minimum technical requirements to ensure compatibility of products and conformance with radio regulations across ETSI member states. Radio terminals from different manufacturers are not required to interwork at radio frequency (i.e. no common air interface). However, terminals may be combined with other manufacturers' equipment on a Radio Frequency (RF) branching network for operation on different polarizations.

The present document defines the requirements of radio terminal and radio relay equipment and associated interfaces. The requirements for multiplex, network management and antenna/feeder equipment may be addressed elsewhere.

The clauses containing essential requirements for Council Directive 89/336/EEC [30] (EMC Directive) are reported in annex B.

The former title of the present document was: "Transmission and Multiplexing (TM); Digital Radio Relay Systems (DRRS); High capacity DRRS carrying PDH and 1x Synchronous Transport Module-level 1 (1 x STM-1) signals operating in the 18 GHz frequency band with channel spacing of 55 MHz and 27,5 MHz".

<b>National transposition dates</b>	
Date of adoption of this EN:	16 February 2001
Date of latest announcement of this EN (doa):	31 May 2001
Date of latest publication of new National Standard or endorsement of this EN (dop/e):	30 November 2001
Date of withdrawal of any conflicting National Standard (dow):	30 November 2001

# 1 Scope

The present document specifies parameters for high capacity STM-1 digital radio-relay systems designed to operate in the 17,7 GHz to 19,7 GHz band. The channel spacing between adjacent co-polar channels shall be 55 MHz or 27,5 MHz. Operation in the Adjacent Channel Co-Polarization (ACCP) mode for class 4 systems and class 5 systems as defined below with orthogonal polarizations or in the alternated cross-polar mode is foreseen. Additionally for class 4 systems, operation in the Co-Channel Dual Polarized (CCDP) mode with orthogonal polarization is also foreseen. The present document covers both single and multi-channel systems.

The present document specifies the minimum performance parameters for terrestrial fixed service radio communications equipment operating in the frequency range 17,7 GHz to 19,7 GHz and contains a revision from the previous version, in the area of:

- categorization of previously considered equipments into a new spectrum efficiency class 4;
- introduction of unique system type codes for regulatory reference to the various system types detailed in the present document, refer to new annex C and related categories of equipment classes of spectral efficiency;
- new spectrum efficiency class 5 for STM-1 capacity for 27,5 MHz Adjacent Channel Alternate-Polarization (ACAP as class 5a) and Adjacent Channel Co-Polarization (ACCP as class 5b), see examples of the spectrum usage in figures 1.1a and 1.1b:

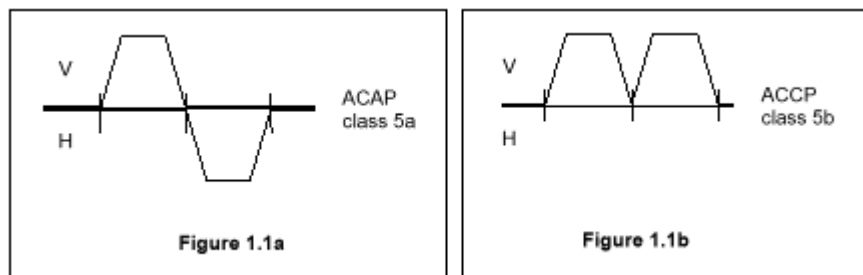

**Figure 1**

- technical specifications relevant to the EMC Directive, detailed in annex B.

The applications of these digital radio-relay systems are anticipated to be in the regional and access networks, at data rates of Synchronous Transport Module, level 1 (STM-1). The parameters to be specified fall into two categories:

- a) those that are required to provide compatibility between channels from different sources of equipment on the same route connected either to:
  - separate antennas; or
  - separate polarizations of the same antenna; or
  - one polarization of one antenna at a frequency separation of 110 MHz or more, enabling, in addition for class 4 equipment only, interworking of different manufacturers equipment at the same Radio Frequency (RF) branching;
  - this category also includes parameters providing compatibility with the existing radio-relay network.
- b) parameters defining the transmission quality of the proposed system.

The standardization deals with RF and baseband characteristics. Antenna/feeder system requirements are covered in EN 300 833 [33].

Two possible baseband interfaces for SDH systems have to be considered: one for STM-1 and another for 140 Mbit/s signals.

The present document does not contain aspects related to test procedures and test conditions, however they are to be found in EN 301 126-1 [19].

As the maximum transmission rate in a given bandwidth depends on systems spectral efficiency, different classes are defined:

- class 4: equipment spectral efficiency based on typically 16 or 32-states modulation scheme (e.g. 16-QAM, 32-QAM, or equivalent);
- class 5: equipment spectral efficiency based on typically 64 or 128-states modulation scheme (e.g. 64-QAM, 128-QAM, or equivalent).

The above classes are indicative only and do not imply any constraint to the actual modulation format, provided that all the requirements in the present document are met.

Safety aspects will not be considered in the present document. However compliance to EN 60950 [28] will be required to comply with Directive 1999/5/EC [29] (R&TTE).

Technical background for most of the parameters and requirements referred in the present document may be found in TR 101 036-1 [20].

---

## 2 References

The following documents contain provisions which, through reference in this text, constitute provisions of the present document.

- References are either specific (identified by date of publication, edition number, version number, etc.) or non-specific.
- For a specific reference, subsequent revisions do not apply.
- For a non-specific reference, the latest version applies.
- A non-specific reference to an ETS shall also be taken to refer to later versions published as an EN with the same number.

- [1] CEPT Recommendation 12-03: "Harmonized radio frequency channel arrangements for digital terrestrial fixed systems operating in the band 17,7 GHz to 19,7 GHz".
- [2] ITU-R Recommendation F.595-6: "Radio-frequency channel arrangements for radio-relay systems operating in the 18 GHz frequency band".
- [3] ITU-R Recommendation F.634-4: "Error performance objectives for real digital radio-relay links forming part of the high-grade portion of international digital connections at a bit rate below the primary rate within an integrated services digital network".
- [4] ITU-R Recommendation F.695: "Availability objectives for real digital radio-relay links forming part of a high-grade circuit within an integrated services digital network".
- [5] ITU-R Recommendation F.750-3: "Architectures and functional aspects of radio-relay systems for synchronous digital hierarchy SDH-based networks".
- [6] ITU-R Recommendation F.751-2: "Transmission characteristics and performance requirements of radio-relay systems for SDH-based networks".
- [7] ITU-R Recommendation F.1191-1: "Bandwidths and unwanted emissions of digital radio-relay systems".
- [8] ETSI ETS 300 019-1 (all parts): "Equipment Engineering (EE); Environmental conditions and environmental tests for telecommunications equipment; Part 1: Classification of environmental conditions".
- [9] ETSI ETS 300 019-2 (all parts): "Equipment Engineering (EE); Environmental conditions and environmental tests for telecommunications equipment; Part 2: Specification of environmental tests".

- [10] ETSI ETS 300 132-1: "Equipment Engineering (EE); Power supply interface at the input to telecommunications equipment; Part 1: Operated by alternating current (ac) derived from direct current (dc) sources".
- [11] ETSI ETS 300 132-2: "Equipment Engineering (EE); Power supply interface at the input to telecommunications equipment; Part 2: Operated by direct current (dc)".
- [12] ITU-T Recommendation G.703: "Physical/electrical characteristics of hierarchical digital interfaces".
- [13] ITU-T Recommendation G.773: "Protocol suites for Q-interfaces for management of transmission systems".
- [14] ITU-T Recommendation G.784: "Synchronous digital hierarchy (SDH) management".
- [15] ITU-T Recommendation G.821: "Error performance of an international digital connection operating at a bit rate below the primary rate and forming part of an integrated services digital network".
- [16] ITU-T Recommendation G.826: "Error performance parameters and objectives for international, constant bit rate digital paths at or above the primary rate".
- [17] ITU-T Recommendation G.957: "Optical interfaces for equipments and systems relating to the synchronous digital hierarchy".
- [18] ETSI EN 300 385: "Electromagnetic compatibility and Radio spectrum Matters (ERM); ElectroMagnetic Compatibility (EMC) standard for fixed radio links and ancillary equipment".
- [19] ETSI EN 301 126-1: "Fixed Radio Systems; Conformance testing; Part 1: Point-to-point equipment - Definitions, general requirements and test procedures".
- [20] ETSI TR 101 036-1: "Fixed Radio Systems; Point-to-point equipment; Generic wordings for standards on digital radio systems characteristics; Part 1: General aspects and point-to-point equipment parameters".
- [21] ETSI ETS 300 635: "Transmission and Multiplexing (TM); Synchronous Digital Hierarchy (SDH); Radio specific functional blocks for transmission of M x STM-N".
- [22] ETSI EN 300 645: "Telecommunications Management Network (TMN); Synchronous Digital Hierarchy (SDH) radio relay equipment; Information model for use on Q interfaces".
- [23] CEPT/ERC Recommendation 74-01: "Spurious Emissions".
- [24] ITU-T Recommendation O.151 (1992): "Error performance measuring equipment operating at the primary rate and above".
- [25] ITU-T Recommendation O.181 (1996): "Equipment to assess error performance on STM-N interfaces".
- [26] ETSI TR 101 035: "Transmission and Multiplexing (TM); Synchronous Digital Hierarchy (SDH) aspects regarding Digital Radio Relay Systems (DRRS)".
- [27] IEC 60154-2: "Flanges for waveguides; Part 2: Relevant specifications for flanges for ordinary rectangular waveguides".
- [28] EN 60950: "Safety of information technology equipment including electrical business equipment".
- [29] Directive 1999/5/EC of the European Parliament and of the Council of 9 March 1999 on radio equipment and telecommunications terminal equipment and the mutual recognition of their conformity.
- [30] Council Directive 89/336/EEC of 3 May 1989 on the approximation of the laws of the Member States relating to electromagnetic compatibility.



- [31] ETSI ETS 300 785: "Transmission and Multiplexing (TM); Synchronous Digital Hierarchy (SDH); Radio specific functional blocks for transmission of M x sub-STM-1".
- [32] CEPT/ERC Report T/R 13-02: "Preferred channel arrangements for fixed services in the range 22,0 GHz to 29,5 GHz".
- [33] ETSI EN 300 833: "Fixed Radio Systems; Point-to-point Antennas; Antennas for point-to-point fixed radio systems operating in the frequency band 3 GHz to 60 GHz".

---

## 3 Symbols and abbreviations

### 3.1 Symbols

For the purposes of the present document, the following symbols apply:

dB	decibel
dBm	decibel relative to 1 milliWatt
GHz	GigaHertz
kHz	kiloHertz
Mbit/s	Megabits per second
MHz	MegaHertz
ppm	parts per million

### 3.2 Abbreviations

For the purposes of the present document, the following abbreviations apply:

ac	alternating current
ACAP	Adjacent Channel Alternate Polarization
ACCP	Adjacent Channel Co-Polarization
ATPC	Automatic Transmit Power Control
BB	Base Band
BBER	Background Block Error Rate
BER	Bit Error Rate
C/I	Carrier to Interference ratio
CMI	Coded Mark Inversion
CSmin	minimum practical Channel Separation (for a given radio-frequency channel arrangement)
CW	Continuous Wave
DRRS	Digital Radio Relay Systems
EMC	ElectroMagnetic Compatibility
ERC	European Radiocommunications Committee
ESR	Errored Seconds Ratio
IF	Intermediate Frequency
IPI	Inter-Port Isolation
LO	Local Oscillator
NFD	Net Filter Discrimination
PDH	Plesiochronous Digital Hierarchy
PRBS	Pseudo Random Binary Sequence
QAM	Quadrature Amplitude Modulation
RBER	Residual BER
RF	Radio Frequency
RFC	Remote Frequency Control
RSL	Receive Signal Level
RTPC	Remote Transmit Power Control
SDH	Synchronous Digital Hierarchy
SOH	Section OverHead
STM-N	Synchronous Transport Module, level N
TMN	Telecommunications Management Network
XPD	cross-Polar Discrimination

## 4 General characteristics

### 4.1 Frequency bands and channel arrangements

#### 4.1.1 Channel arrangements

The systems are required to operate in the 17,7 GHz to 19,7 GHz frequency band, with a channel spacing of 55 MHz or 27,5 MHz. The equipment shall be capable of operating to the channel plans specified in CEPT Recommendation 12-03 [1] or ITU-R Recommendation F.595-6 [2].

For reader convenience, the basic parameters of the CEPT Recommendation are shown in annex A.

#### 4.1.2 Channel spacing for systems operating on the same route

System bit rates and their relevant channel spacing in the present document are reported in table 1 (for the precise payload bit rates, see XPD 5.1).

NOTE: According to systems characteristics the equipment can be connected either to separate antennas or on a separate polarization to the same antenna.

**Table 1: Digital systems channel spacings for various bit rates**

Channel Spacing [MHz]	Payload Bit Rate [Mbit/s]⇒	140 and 155
		Class 4 equipments
	Class 5 equipments	55/27,5

For regulatory purposes in national procedures for licensing radio equipment according to the present document, the above system types shall be identified by the "system type codes" reported in annex C.

### 4.2 Compatibility requirements between systems

The compatibility requirements between systems are as follows:

- a) there shall be no requirement to operate transmitting equipment from one manufacturer with receiving equipment from another;
- b) there may be a requirement to multiplex different manufacturers equipment on the same polarization of the same antenna;
- c) there may be a requirement to multiplex different manufacturers equipment on different polarization of the same antenna.

This will not apply to systems with integral antenna.

### 4.3 Performance and availability requirements

Systems considered in the present document shall be able to respect ITU-R high-grade performance objectives, i.e. ITU-R Recommendations 634-4 [3] and 695 [4], ITU-T Recommendation G.821 [15] and the performance objectives derived from ITU-T Recommendation G.826 [16].

### 4.4 Environmental conditions

The equipment shall be required to meet the environmental conditions set out in ETS 300 019-1 [8] and ETS 300 019-2 [9] which defines weather protected and non-weather protected locations, classes and test severity.

The manufacturer shall state which class the equipment is designed to withstand.

#### 4.4.1 Equipment within weather protected locations (indoor locations)

Equipment intended for operation within temperature controlled locations or partially temperature controlled locations shall meet the requirements of ETS 300 019-1 [8] and ETS 300 019-2 [9] classes 3.1 and 3.2 respectively.

Optionally, the more stringent requirements of ETS 300 019-1 [8] and ETS 300 019-2 [9] classes 3.3 (non-temperature controlled locations), 3.4 (sites with heat trap) and 3.5 (sheltered locations) may be applied.

#### 4.4.2 Equipment for non-weather protected locations (outdoor locations)

Equipment intended for operation within non-weather-protected locations shall meet the requirements of ETS 300 019-1 [8] and ETS 300 019-2 [9], class 4.1 or 4.1E.

Class 4.1 applies to many European countries and class 4.1E applies to all European countries.

### 4.5 Power supply

The power supply interface shall be in accordance with the characteristics of one or more of the secondary voltages foreseen in ETS 300 132-1 [10] and ETS 300 132-2 [11].

NOTE: Some applications may require secondary voltages that are not covered by ETS 300 132-1 [10] and ETS 300 132-2 [11].

For DC systems, the positive pole of the voltage supply will be earthed at the source.

### 4.6 Electromagnetic compatibility

Equipment shall operate under the conditions specified in EN 300 385 [18].

### 4.7 System block diagram

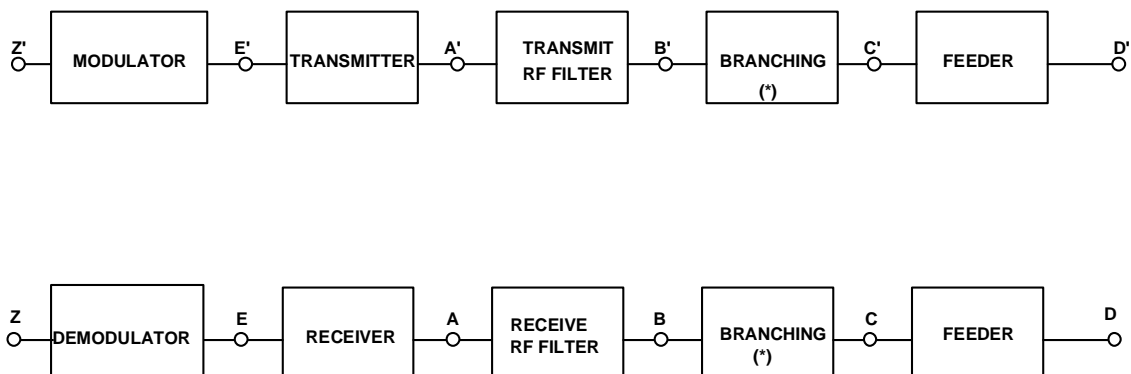

(\*) NO FILTERING INCLUDED

NOTE 1: For the purpose of defining the measurement points, the branching network does not include a hybrid.

NOTE 2: The points shown above are reference points only; points C and C', D and D' in general coincide.

NOTE 3: Points B and C, B' and C' may coincide when simple duplexer is used.

NOTE 4: In outdoor equipment, the branching network may be implemented by a common Tx-Rx duplexer.

**Figure 2: System block diagram**

## 4.8 Telecommunications Management Network (TMN) interface

For SDH equipment ITU-T Recommendations G.784 [14] and G.773 [13] and ITU-R Recommendations F.750-3 [5] and F.751-2 [6] give the general requirements for TMN interface and functionality. ETS 300 635 [21], ETS 300 785 [31] and EN 300 645 [22] give the radio specific functional block description and the related radio fragment information model respectively.

NOTE: The standardization of TMN interface functionalities is under study in ETSI TMN and will be applicable to the radio relay systems considered in the present document.

## 4.9 Branching/feeder/antenna characteristics

### 4.9.1 Antenna radiation patterns

See EN 300 833 [33].

### 4.9.2 Antenna cross-Polar Discrimination (XPD)

See EN 300 833 [33].

### 4.9.3 Antenna Inter-Port Isolation (IPI)

See EN 300 833 [33].

### 4.9.4 Waveguide flanges (or other connectors)

When flanges are required at reference point C, C', the following IEC 60154-2 [27] types shall be used:

- waveguide type R220 with a waveguide flange type PDR220/PBR220/UDR220/UBR220; or
- waveguide type R180 with flanges PDR180/PBR180/UDR180/UBR180.

### 4.9.5 Return loss

For feeder/antenna return loss requirement see annex A.

---

## 5 System Parameters

### 5.1 Transmission capacity

Payload bit rates considered in the present document are:

- 139,264 Mbit/s; and
- 155,520 Mbit/s (STM-1).

In the following clauses, these capacities will be simply referred as 140 Mbit/s, and 155 Mbit/s (STM-1) respectively.

### 5.2 Baseband parameters

All the following specified baseband parameters refer to point Z and Z' of figure 2. Parameters for service channels and wayside traffic channels are outside the scope of the present document.

### 5.2.1 Plesiochronous interfaces

Plesiochronous interfaces at 140 Mbit/s shall comply with ITU-T Recommendation G.703 [12].

### 5.2.2 SDH baseband interface

The SDH baseband interface shall be in accordance with ITU-T Recommendations G.703 [12], G.784 [14] and G.957 [17] and ITU-R Recommendation F.750-3 [5].

Two STM-1 interfaces shall be possible:

- CMI electrical (ITU-T Recommendation G.703 [12]);
- Optical (ITU-T Recommendation G.957 [17]).

The use of reserved bytes contained in the Section OverHead (SOH), and their termination shall be in accordance with ITU-R Recommendation F.750-3 [5].

NOTE: Further details on the possible use of the SOH bytes reserved for future international standardization are given in TR 101 035 [26].

## 5.3 Transmitter characteristics

The specified transmitter characteristics shall be met with the appropriate baseband signals applied at reference point Z' of figure 2. For PDH interface this shall be a Pseudo Random Binary Sequence (PRBS) according to ITU-T Recommendation O.151 [24] while for SDH interface ITU-T Recommendation O.181 [25] test signal applies.

### 5.3.1 Transmitter power range

Transmitter maximum mean output power at reference point C' of the system block diagram (figure 2) shall not exceed +30 dBm (including tolerance and, if applicable, ATPC/RTPC influence).

Regulatory administrations may define nominal sub-ranges below this maximum limit.

NOTE 1: The manufacturer will state, in the conformance test, if ATPC is optional or fixed feature.

NOTE 2: The technological evolution may result in equipment falling outside of the range(s) foreseen in XPD 5.3.1. In this case the equipments of different output power sub-ranges are not considered to require individual type approval, however their use is subject to individual national agreements.

A capability for output power level adjustment may be required for regulatory purposes, in which case the range of adjustment, either by fixed or automatic attenuators, should be in steps of 5 dB or less.

### 5.3.2 Transmit power and frequency control

#### 5.3.2.1 Automatic Transmit Power Control (ATPC)

ATPC is an optional feature. Equipment with ATPC will be subject to manufacturer declaration of ATPC ranges and related tolerances. The manufacturer shall declare if the equipment is designed with ATPC as a fixed permanent feature. Testing shall be carried out with output power level corresponding to:

- ATPC set manually to a fixed value for system performance (XPDs 5.5 and 5.6);
- ATPC set at maximum available power for transmit performance (XPD 5.3).

It shall be verified that the emitted RF spectrum is within the absolute RF spectrum mask evaluated for the maximum available output power of the equipment, including the attenuation introduced by RTPC, if any.

NOTE: Where the use of ATPC is considered compulsory for regulatory purposes the transmitter output power should meet the spectrum mask limits throughout the ATPC range.

### 5.3.2.2 Remote Transmit Power Control (RTPC)

RTPC is an optional feature. Equipment with RTPC will be subject to manufacturer declaration of RTPC ranges and related tolerances. Testing shall be carried out with output power level corresponding to:

- RTPC set to the maximum nominal power for transmit performance (XPD 5.3) and for system performance (XPD 5.5 and 5.6);
- the RF spectrum mask shall be verified in three points (low, medium, and high) of the RTPC power excursion and with ATPC set to maximum available power (if any). When these spectrum measurements are made difficulties may be experienced. Actual measurement methods shall be addressed in further investigations and will be defined in the conformance-testing standard (i.e.: EN 301 126-1 [19]).

RTPC range should be restricted, taking into account the wideband noise generated by the transmitter chain, to ensure the spectrum mask requirements are met throughout the transmitter output power range.

NOTE: Where the use of ATPC is considered compulsory for regulatory purposes the transmitter output power should meet the spectrum mask limits throughout the ATPC range.

### 5.3.2.3 Remote Frequency Control (RFC)

RFC is an optional feature. Equipment with RFC will be subject to manufacturer declaration of RFC ranges and related change frequency procedure. Testing shall be carried out including:

- RFC setting procedure at least for three frequencies (lower, centre and higher of the covered range);
- RFC setting procedure shall not produce emissions outside the previous and final frequency spectrum mask.

## 5.3.3 Transmitter output power tolerance

The nominal output power shall be declared by the supplier.

The tolerance of the nominal output power shall be within:

- for systems operating within non-weather-protected locations and within classes 3.3, 3.4 and 3.5 weather protected locations:
  - nominal output power  $+2/-1$  dB: Refer to ETS 300 019-1 [8] and ETS 300 019-2 [9].
- for systems operating within other classes of weather protected locations:
  - nominal output power  $\pm 1$  dB: Refer to ETS 300 019-1 [8] and ETS 300 019-2 [9].

## 5.3.4 Transmit Local Oscillator (LO) frequency arrangements

There shall be no requirement on transmit LO frequency arrangement.

### 5.3.5 RF spectrum mask

XPD 4.2 provides compatibility requirements for class 4 systems. The compatibility requirements provide options for single-channel and multi-channel RF branching systems. When considering the compatibility requirements in XPD 4.2 (b and c), the RF Spectrum Mask shall take into consideration the effects of system interoperability when selecting normal channels or the innermost channel (see below). The spectrum masks are defined in figure 2a for the following applications per XPD 4.2:

- limits of mask "4E" are for systems which are not intended to comply with any compatibility requirements under XPD 4.2;
- limits of masks "4A" to "4C" are for innermost and normal channels, respectively, of systems which are intended to comply with compatibility requirement under clause 4.2 (b) and used for single-channel RF branching systems;
- limits of masks "4B" and "4D" are for innermost and normal channels, respectively, of systems which are intended to comply with compatibility requirement clause 4.2 (c) and used for multi-channel RF branching systems.

Whereas innermost channels refer to the go and return channel adjacent to the centre guard-band per annex A, clause A.1, and normal channels refer to all channels except the go and return channel adjacent to the centre guard-band.

The masks "4A" to "4D", given in figure 3a, fix lower limits of 88 dB and 105 dB in order to control local interference between transmitters and receivers of different manufacturers connected to the same antenna.

Since it is not possible to measure attenuation values up to 105 dB directly, values above 50 dB in figure 3a (values are not considered essential for regulatory and conformance test purposes) should be subject to a supplier declaration.

NOTE: These values may be evaluated by adding a measured filter characteristic to the spectrum at A' of figure 2.

For class 5a systems, the spectrum mask is defined in figure 3b.

For class 5b systems, the spectrum mask is defined in figure 3c.

Masks shall be measured with a modulating baseband test signal given by ITU-T Recommendation O.151 [24] in the case of PDH signals or by ITU-T Recommendation O.181 [25] for SDH.

In some particular circumstances as mentioned in the Informative annex A, clause A.4, tighter requirements may be required.

The masks do not include frequency tolerance.

The spectrum analyser settings for measuring the RF spectrum mask detailed are shown in table 2.

**Table 2: Spectrum analyser settings**

Parameter	Channel Separation	
	27,5 MHz	55 MHz
	Setting	Setting
IF bandwidth	100 kHz	300 kHz
Total sweep width	160 MHz	500 MHz
Total scan time	Auto	Auto
Video filter bandwidth	0,3 kHz	0,3 kHz

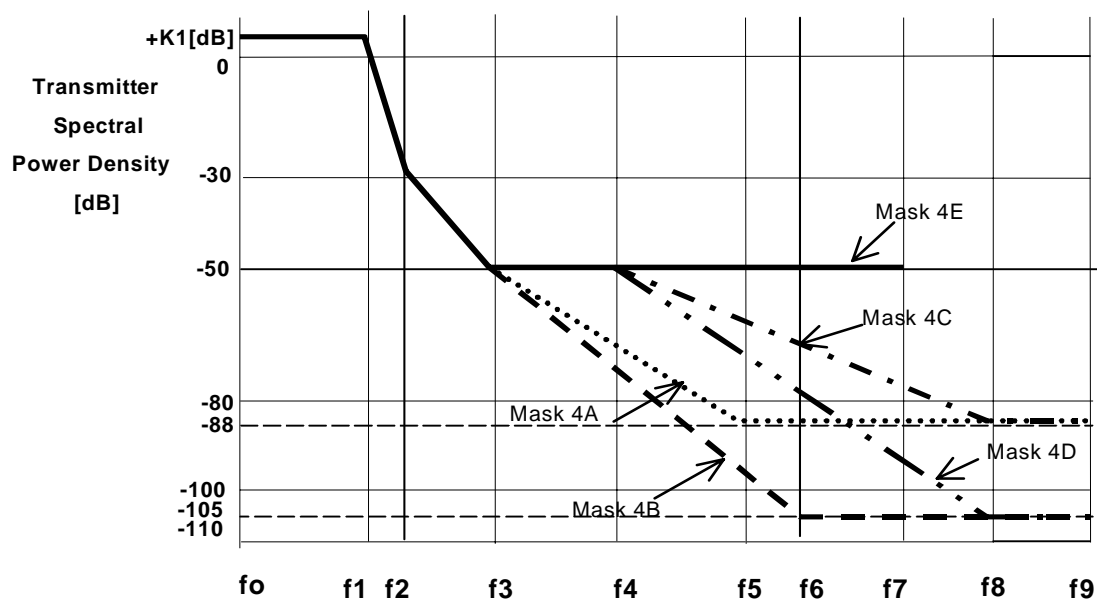

NOTE: Frequency expressed from actual transmitter centre frequency [MHz].  
 4A: Innermost channel, compatibility requirement XPD 4.2 (c).  
 4B: Innermost channel, compatibility requirement XPD 4.2 (b).  
 4C: Normal channel, compatibility requirement XPD 4.2 (c).  
 4D: Normal channel, compatibility requirement XPD 4.2 (b).  
 4E: No compatibility requirement in XPD 4.2.

Figure 3a: Limits of spectral power density for class 4 systems

Table 3a: Spectrum mask frequency limits for Class 4 systems

Mask Ref.	Bit-rate [Mbit/s]	Channel spacing [MHz]	K1 [dB]	f 1 [MHz]	f 2 [MHz]	f 3 [MHz]	f 4 [MHz]	f 5 [MHz]	f 6 [MHz]	f 7 [MHz]	f 8 [MHz]	f 9 [MHz]
4A	155	55	+1	22,5	33	70	n.a.	105	n.a.	n.a.	n.a.	180
4B	155	55	+1	22,5	33	70	n.a.	n.a.	115	n.a.	n.a.	180
4C	155	55	+1	22,5	33	70	85	n.a.	n.a.	n.a.	160	180
4D	155	55	+1	22,5	33	70	85	n.a.	n.a.	n.a.	160	180
4E	155	55	+1	22,5	33	70	n.a.	n.a.	n.a.	137,5	n.a.	n.a.



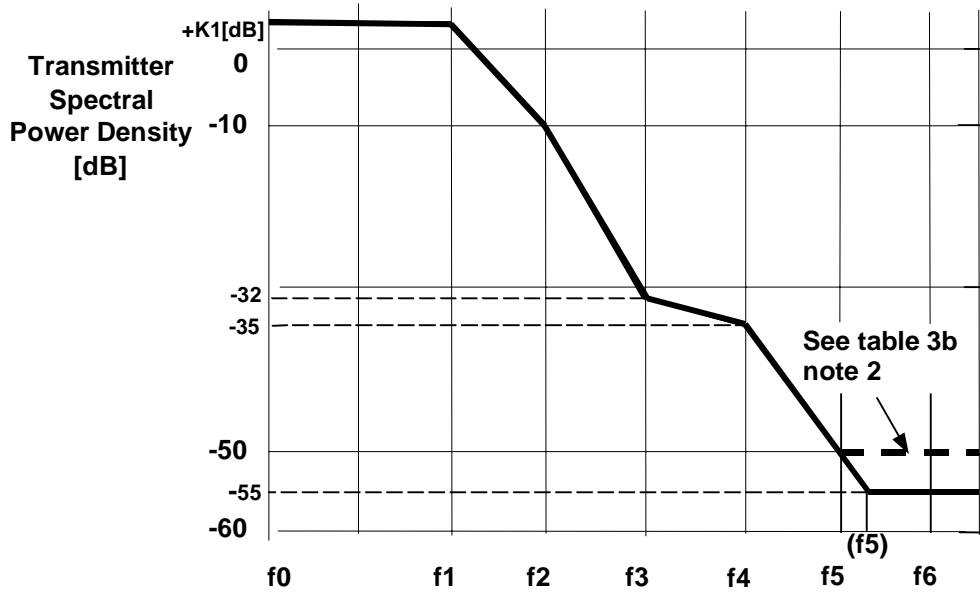

NOTE: Frequency expressed from actual transmitter centre frequency [MHz].

Figure 3b: Limits of spectral power density for Class 5a systems

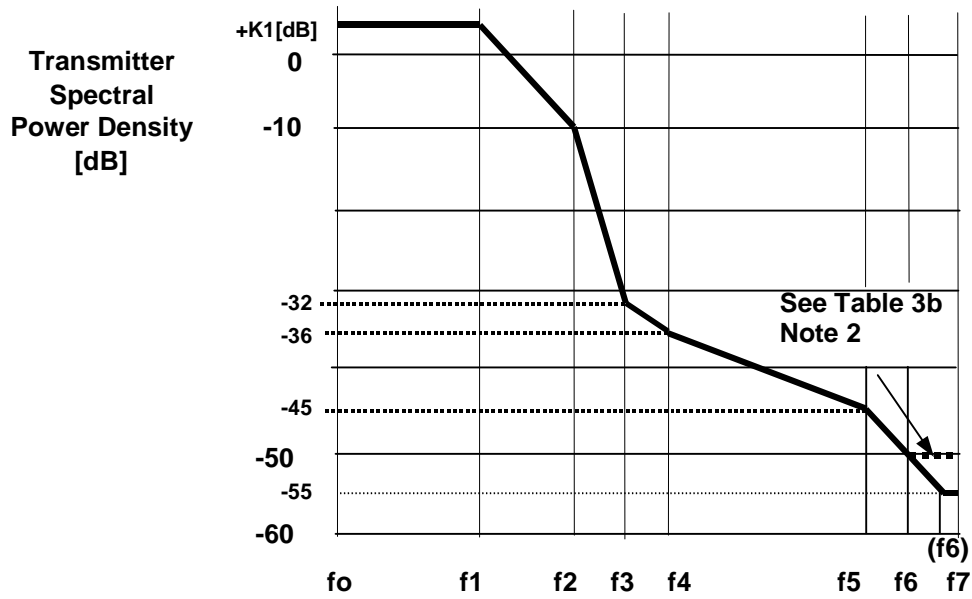

NOTE: Frequency expressed from actual transmitter centre frequency [MHz].

Figure 3c: Limits of spectral power density for class 5b systems

**Table 3b: Spectrum mask frequency limits for Class 5a & 5b systems (figure 3b and c)**

Spectrum Efficiency Class	Bit-rate [Mbit/s]	Channel spacing [MHz]	K1 [dB]	f 1 [MHz]	f 2 [MHz]	f 3 [MHz]	f 4 [MHz]	f 5 [MHz]	f 6 [MHz]	f 7 [MHz]
5a	155	27,5	+2	12,5	15	17	20	50	68,75	n.a.
5b	155	27,5	+2	12	14,5	15,5	17	25	30	68,75

NOTE: The mask floor at 55 dB is required for guaranteeing RBER performance in the presence of multiple adjacent channels regardless of the FEC algorithm implemented, however for regulatory purposes attenuation greater than 50 dB is not required. The corresponding f1-f7 values for a mask floor of 50 dB is as in table 3c.

**Table 3c: Spectrum mask frequency limits for mask floor of 50 dB**

Spectrum efficiency class	Bit-rate [Mbit/s]	Channel spacing [MHz]	Figure	K1 [dB]	f 1 [MHz]	f 2 [MHz]	f 3 [MHz]	f 4 [MHz]	f 5 [MHz]	f 6 [MHz]	f 7 [MHz]
5a	155	27,5	3c	+2	12,5	15	17	20	42,5	68,75	n.a.
5b	155	27,5	3d	+2	12	14,5	15,5	17	25	27,5	68,75

Due to limitations of some spectrum analysers, difficulties may be experienced when testing high capacity/wideband systems. In this event, the following options are to be considered; measurement using high performance spectrum analyser, use of notch filters and two step measurement technique. Where difficulties are experienced, the plots of one test conducted at ambient and environmental extremes may be produced as evidence to conformance to the spectrum mask.

### 5.3.6 Discrete CW lines exceeding the spectrum mask limit

#### 5.3.6.1 Spectral lines at the symbol rate

The power level (reference point B') of spectral lines at a distance from the channel centre frequency equal to the symbol rate shall be more than 37 dB below the average power level of the carrier for class 4 and 5a systems and 43 dB for class 5b systems.

#### 5.3.6.2 Other spectral lines

In case some CW components exceed the spectrum mask, an additional allowance is given.

Those lines shall not:

- exceed the mask by a factor more than  $\{10 \log (CS_{min}/IF_{bw}) - 10\}$  dB
- be spaced each other in frequency by less than  $CS_{min}$

Where:

$$CS_{min} = 1\,750 \text{ kHz for the 18 GHz band}$$

$IF_{bw}$  is the recommended resolution IF bandwidth, expressed in kHz, reported in table 2.

Figure 4 shows a typical example of this requirement.

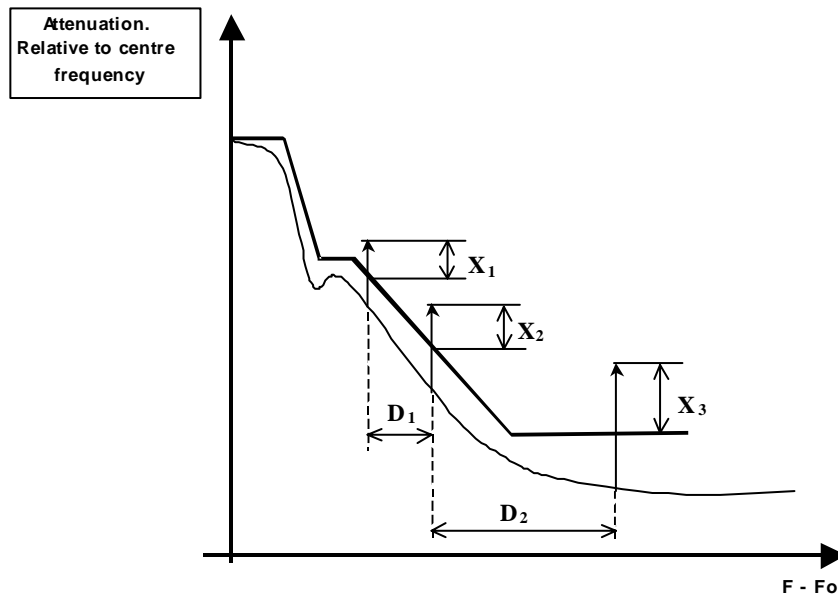

$$X_1, X_2, X_3 \text{ [dB]} \leq 10 \log( CS_{\min} / IF_{bw} ) - 10$$

$$D_1, D_2 \geq CS_{\min}$$

**Figure 4: CW lines exceeding the spectrum mask (typical example)**

### 5.3.7 Spurious emissions

It is necessary to define spurious emissions from transmitters for two reasons:

- to limit interference into systems operating wholly externally to the system channel plan (external emissions);
- to limit local interference within the system where transmitters and receivers are directly connected via the filter and branching systems (internal emissions).

This leads to two sets of spurious emission limits where the specific limits given for "internal" interference are required to be no greater than the "external" level limits at reference point B' for indoor systems and C' for outdoor systems (where a common Tx/Rx duplexer is used).

#### 5.3.7.1 Spurious emissions-external

According to ITU-R Recommendation F.1191-1 [7], and CEPT/ERC Recommendation 74-01 [23], the external spurious emissions are defined as emissions at frequencies which are outside the nominal carrier frequency  $\pm 250\%$  of the relevant channel separation.

The limits of these emissions shall conform to CEPT/ERC Recommendation 74-01 [23].

### 5.3.7.2 Spurious emissions-internal

The levels of the spurious emissions from the transmitter, referenced to point B' of figure 2 are specified in table 4.

The required level will be the total average level of the emission under consideration.

**Table 4: Internal levels for the transmitter spurious emissions**

Spurious emission frequency relative to channel assigned frequency	Specification limit	Controlling factor for requirement application
The level of all spurious signals both discrete CW and noise-like evaluated as total signal level	≤ -90 dBm	If spurious signal's frequency falls within receiver half band, for digital systems with compatibility requirements as in XPD 4.2 (b)
	≤ -70 dBm	If spurious signal's frequency falls within receiver half band, for digital systems with compatibility requirements as in XPD 4.2 (c)

Requirements for internal spurious emissions are not necessary for systems that are not intended to comply with any compatibility requirements under XPD 4.2.

### 5.3.8 Radio frequency tolerance

Maximum radio frequency tolerance shall not exceed ± 15 ppm. This limit includes both short-term factors (environmental effects) and long-term ageing effects.

## 5.4 Receiver characteristics

### 5.4.1 Input level range

The lower limit for the receiver input level shall be given by the threshold level for Bit Error Ratio (BER) =  $10^{-3}$ . The upper limit for the receiver input level, where a BER of  $10^{-3}$  is not exceeded shall be, for class 4 equipment with shared branching (compatibility requirement XPD 4.2 (b or c)), -17 dBm and, for class 4 without shared branching (compatibility requirement 4.2 (a)) and class 5 equipment, -20 dBm.

A BER of  $10^{-8}$  may only be exceeded, for class 4 equipment, with shared branching (compatibility requirement XPD 4.2 (b or c)) for levels greater than -19 dBm and, for class 4 without shared branching (compatibility requirement 4.2 (a)) and class 5 equipment, for levels greater than -24 dBm.

For equipment designed to operate only with ATPC as a fixed permanent feature, the above maximum input levels are reduced by an amount up to the ATPC range.

### 5.4.2 Receiver image rejection

The receiver image(s) rejection shall be as listed in table 5.

**Table 5: Receiver image rejection**

Controlling factor	Image rejection
a) if image frequency falls within receiver half band as defined in XPD 4.2 (c). b) if branching on different polarizations is used as defined in XPD 4.2 (c).	≥ 90 dB
c) in a single channel system as defined in XPD 4.2(a).	Not Applicable
d) if branching on same polarization is used and if image frequency falls within receiver half band as defined in XPD 4.2 (b).	≥ 110 dB

### 5.4.3 Spurious emissions-external

The limits of these emissions shall conform to CEPT/ERC Recommendation 74-01 [23].

### 5.4.4 Spurious emissions-internal

The required levels in this paragraph are referenced to reference point B of figure 2 will be the total average level of the emission under consideration.

The limits of the spurious emissions from the receiver which frequency falls within the same receiver half band are:

- for digital systems with compatibility requirements as in XPD 4.2 (b) a limit of  $\leq -90$  dBm shall apply;
- for digital systems with compatibility requirements as in XPD 4.2 (c) a limit of  $\leq -70$  dBm shall apply.

Requirements for internal spurious emissions are not necessary for systems that are not intended to comply with any compatibility requirements under XPD 4.2.

## 5.5 System performance without diversity

All parameters are referred to reference point C (*for systems with simple duplexer*) or B (*for systems with multi-channel branching system*) of the system block diagram (see figure 2). Losses in RF couplers used for protected systems are not taken into account in the limits specified below.

All measurements shall be carried out with the test signals defined in XPD 5.3.

### 5.5.1 BER as a function of Receiver input Signal Level (RSL)

Receiver BER thresholds (dBm) referred to reference point C (*for systems with simple duplexer*) or B (*for systems with multi-channel branching system*) of the system block diagram (see figure 2) for a BER of  $10^{-3}$ ,  $10^{-6}$  and  $10^{-8}$  shall be equal to or lower than those stated in table 6.

**Table 6: BER performance thresholds**

RSL @ BER →			RSL @ $10^{-3}$ [dBm]	RSL @ $10^{-6}$ [dBm]	RSL @ $10^{-8}$ [dBm]
Spectrum Efficiency Class ↓	Bit-rate [Mbit/s] ↓	Channel spacing [MHz] ↓			
4	155	55	-73	-69	-67
5a	155	27,5	-65	-62	-60
5b	155	27,5	-67	-64	-62

### 5.5.2 Equipment Residual BER

The RBER level under simulated operating conditions without interference shall be guaranteed with a signal level at reference point C which is between 10 dB and 35 dB above the level which gives BER =  $10^{-6}$  (as specified in XPD 5.5.1).

The network operator (see also informative annex A.4) may require equipment to meet a RBER limit with the first adjacent channel interferer. In this case the RBER level under simulated operating conditions with interference shall be guaranteed with a signal level at reference point C which is between 15 dB and 35 dB above the level which gives BER =  $10^{-6}$  (as specified in XPD 5.5.1). The interferer level shall be set to represent a Carrier to Interference ratio (C/I) of +7 dB for class 5a systems (this figure includes a 10 dB offset to account for the minimum cross polar discrimination of these systems), and -3 dB for all other systems.

The RBER shall be less than  $10^{-12}$ .

This requirement is intended for the payload bit rates defined in XPD 5.1.

EN 301 126-1 [19] recognizes that this requirement is subject to a supplier declaration only. However, in annex A clause A.4 some background information relating to the actual test methods and test confidence is given.

### 5.5.3 Interference sensitivity

All receive signal levels and Carrier to Interference ratio (*C/I*) measurements are referred to reference point C (*for systems with simple duplexer*) or B (*for systems with multi-channel branching system*) of the RF system block diagram (see figure 2).

#### 5.5.3.1 Co-channel interference sensitivity

The limits of co-channel Interference shall be as in table 7, giving maximum *C/I* values for 1 dB and 3 dB degradation of the  $10^{-6}$  BER limits specified in XPD 5.5.1.

For frequency co-ordination purpose intermediate values may be found in figure A.2.

**Table 7: Co-channel interference sensitivity**

co-channel interference			C/I at BER = @ $10^{-6}$ RSL degradation	
degradation →			1 dB	3 dB
Spectrum Efficiency Class ↓	Bit rate [Mbit/s] ↓	Channel spacing [MHz] ↓		
4	155	55	29	25
5a & 5b	155	27,5	37	33

#### 5.5.3.2 Adjacent channel Interference

The limits of adjacent channel interference shall be as given in table 8 for like modulated signals spaced of 1 channel spacing, giving maximum *C/I* values for 1 dB and 3 dB degradation of the  $10^{-6}$  BER limits specified in XPD 5.5.1.

For frequency co-ordination purpose intermediate values may be found in figure A.3.

**Table 8: First adjacent channel interference sensitivity**

First adjacent channel interference			C/I at BER = @ $10^{-6}$ RSL degradation	
degradation →			1 dB	3 dB
Spectrum Efficiency Class ↓	Bit rate [Mbit/s] ↓	Channel spacing [MHz] ↓		
4	155	55	-5	-9
5a	155	27,5	+3	-1
5b	155	27,5	-3	-7

### 5.5.3.3 CW Spurious Interference

For a receiver operating at the  $10^{-6}$  BER threshold given in table 6, the introduction of a CW interferer at a level of +30 dB with respect to the wanted signal and at any frequency in the range 30 MHz to the second harmonic of the upper frequency of the band, excluding frequencies either side of the wanted centre frequency of the RF channel by up to 250 % the channel spacing, shall not result in a BER greater than  $10^{-5}$ .

NOTE: When waveguide is used between reference point A and C, which length is higher than twice the free space wavelength of the cut-off frequency ( $F_c$ ), the lower limit of measurement will be increased to  $0,7 F_c$  and to  $0,9 F_c$  when the length is higher than 4 times the same wavelength.

This test is designed to identify specific frequencies at which the receiver may have a spurious response, e.g. image frequency, harmonics of the receive filter, etc. The actual test range should be adjusted accordingly. The test is not intended to imply a relaxed specification at all out of band frequencies elsewhere specified in the present document.

### 5.5.4 Distortion sensitivity

Rainfall is the main propagation factor in the 18 GHz band limiting performance. Equalizers to compensate propagation distortion may be considered necessary. The specifications for distortion sensitivity are given below in the form of signatures.

#### **Class 4 signatures:**

- for two path propagation with a delay of 6,3 ns and a BER of  $10^{-3}$  the width of the signature shall not exceed  $\pm 25$  MHz relative to the assigned channel centre frequency, the depth shall not be less than 10 dB;
- for two path propagation with a delay of 6,3 ns and a BER of  $10^{-6}$  the width of the signature shall not exceed  $\pm 27$  MHz relative to the assigned channel centre frequency, the depth shall not be less than 8 dB.

#### **Class 5 signatures:**

- for two path propagation with a delay of 6,3 ns and a BER of  $10^{-3}$  the width of the signature shall not exceed  $\pm 18$  MHz relative to the assigned channel centre frequency, the depth shall not be less than 15 dB;
- for two path propagation with a delay of 6,3 ns and a BER of  $10^{-6}$  the width of the signature shall not exceed  $\pm 22$  MHz relative to the assigned channel centre frequency, the depth shall not be less than 12 dB.

These limits are both valid for minimum and non-minimum phase cases. They shall also be verified by the loss-of-synchronization and re-acquisition signatures.

## 5.6 System characteristics with diversity

Space diversity receive is not relevant for the systems subject to the present document.

## Annex A (informative): Additional information

### A.1 Radio frequency channel arrangement

The relevant radio frequency channel arrangement provided by ITU-R Recommendation F.595-6 [2]; or CEPT Recommendation 13-02 [32] however, for reader's convenience, figure A.1 gives its general overview:

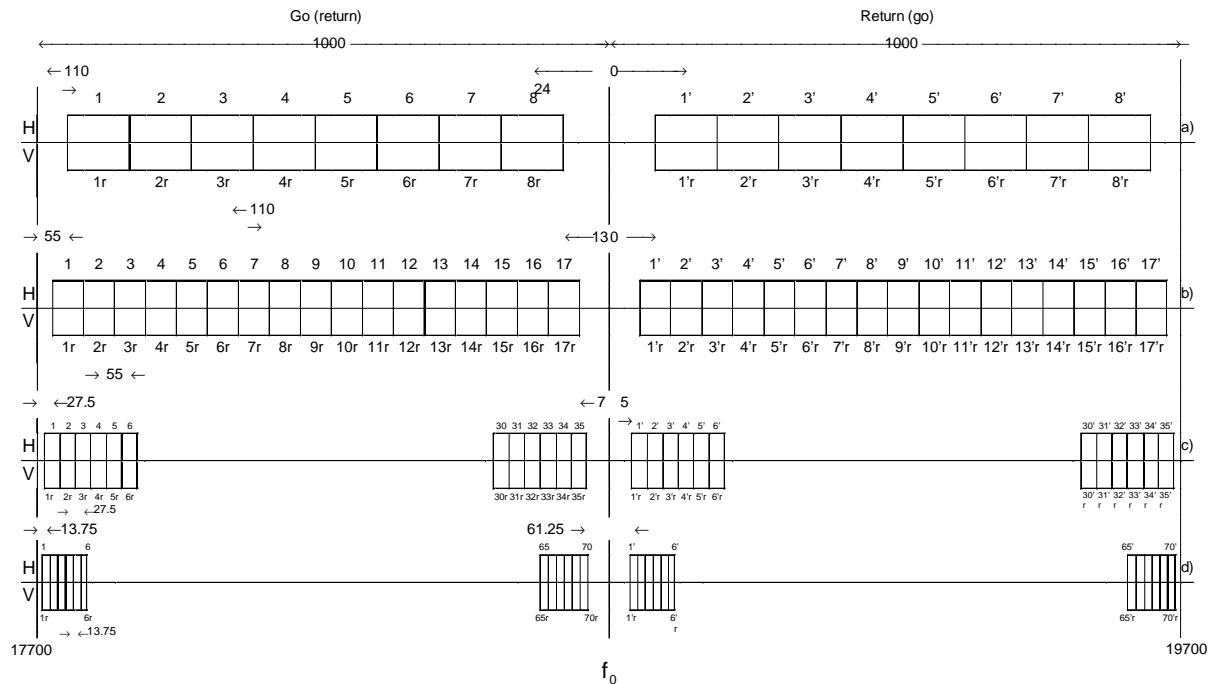

**Figure A.1: Radio frequency channel arrangement for digital radio-relay systems operating in the 17,7 GHz to 19,7 GHz band (Co-channel arrangement) (All frequencies are in MHz)**

### A.2 Feeder/antenna return loss

The minimum return loss of the feeder/antenna system connected to indoor systems should be considered not less than 20 dB. The measurement shall be referred to reference point C/C' towards the antenna.

When separated antenna and radio equipment are concerned the antenna/feeder system return loss should be considered not less than 23 dB for class 4 systems and 26 dB for class 5 systems. The measurement should be referred to reference point D/D' of figure 2 towards the antenna.



---

## A.3 Automatic Transmit Power Control (ATPC)

ATPC may be useful in some circumstances, e.g.:

- to reduce interference between neighbouring systems or adjacent channels of the same system;
- to improve compatibility with analogue and digital systems at nodal stations;
- to improve residual BER or RBER performance;
- to reduce upfading problems;
- to reduce transmitter power consumption;
- to reduce digital-to-digital and digital to analogue distant interference between hops which re-use the same frequency;
- to increase system gain as a countermeasure against rainfall attenuation.

ATPC as an optional feature is aimed at driving the transmit power amplifier output level from a proper minimum which facilitates the radio network planning requirements and which is used under normal propagation conditions up to a maximum value which fulfils all the specifications defined in the present document.

ATPC may also be used to increase the output power above the nominal level up to the maximum level specified by the manufacturer, with the agreement of administrations and operators, during fading conditions. This can be useful because in frequency ranges above 13 GHz the main limiting factors are given by non-selective fading events.

For planning considerations in a nodal environment a system equipped with ATPC can be considered to operate with its minimum transmitter power.

When ATPC is a fixed feature, the ATPC range is defined as the power interval from the maximum (including tolerances) output power level to the lowest transmitter output power level (at reference point B') with ATPC; when it is optional two ranges may be defined, a "down-range" from the nominal level to the minimum (including tolerances) and an "up-range" from the nominal level to the maximum (including tolerances).

---

## A.4 Spectrum masks

The spectrum masks given in figures 3a, 3b and 3c are consistent with NFD figures between adjacent channels of about 34 dB for class 4 systems and respectively. 43 dB for class 5 systems. For hop lengths of more than about 10 km, NFD of more than 34 dB to 43 dB respectively, or the use of the alternate polarization may be required on the same route and using adjacent channels and separate antennas.

The Net Filter Discrimination (NFD) can be taken as the difference between the co-channel interference (stated in the XPD 5.5.3.1 table 7; Co-channel external interference sensitivity), and the measured value of the adjacent interference sensitivity) and the measured value of the adjacent channel interference sensitivity  $C/I$  referred to the same bit error ratio and the same modulation scheme each. This procedure is stated in the generic document TR 101 036-1 [20].

## A.5 RBER

In particular applications, where there is a high density of radio links in a specific area, e.g. nodal site, closely located radios may use adjacent channels. Therefore to guarantee the grade of service the equipment will need to meet RBER criteria in the presence of an adjacent channel interferer.

The RBER is standardized in order to match the ESR (or the BBER) performance required by ITU-R transmission performance recommendations.

To have sufficient confidence in the measurement, where the BER is relatively low compared to the actual payload, the test time is very long. The actual background to this measurement and the BER figures are detailed in TR 101 036-1 [20].

When error correction is a fitted feature it may be possible to reduce the measurement time by estimating the RBER using the relevant formula declared by the supplier.

Another option is to ensure that no errors occur during the minimum recording time shown in table A.1.

**Table A.1: Zero errors recording times**

<b>Bit-rate under test [Mbit/s]</b>	<b>Minimum recording time [minutes]</b>	<b>Errors</b>
2	82	0
8	21	0
34	50	0
51	34	0
140/155	108	0

## A.6 Co-channel and adjacent channel interference

The performances for co-channel and adjacent channel spaced by one channel spacing  $C/I$  are reported in XPDs 5.5.3.1 and 5.5.3.2 respectively, for 1 dB and 3 dB degradation only; figures A.2 and A.3 give the reference behaviour for other values of degradation.

Receiver Input Level at Reference Point C  
relative to BER  $10^{-6}$  threshold

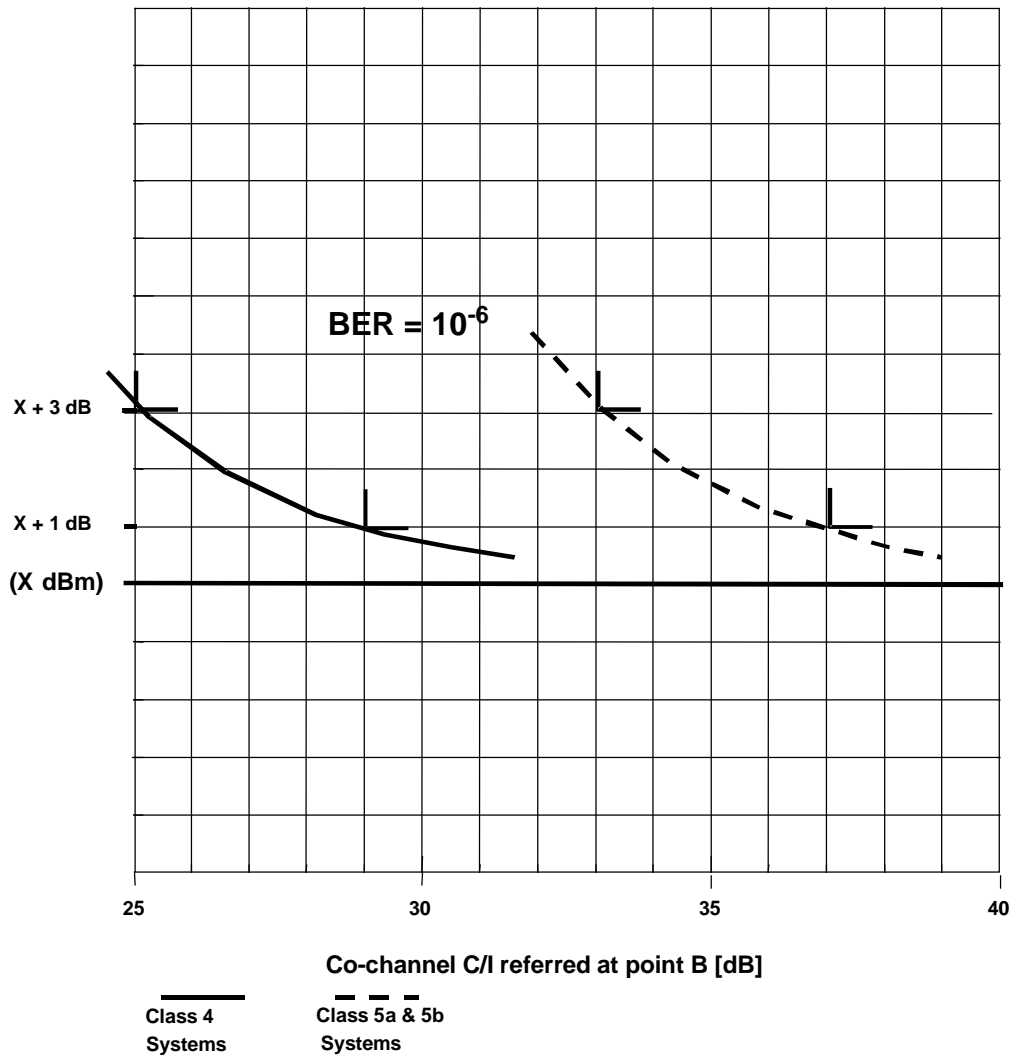

NOTE:  $X \text{ dBm} = 10^{-6}$  BER threshold provided by XPD 5.5.1.

Figure A.2: Co-channel interference threshold degradation

Receiver Input Level at Reference Point C  
relative to BER<sup>-6</sup> threshold

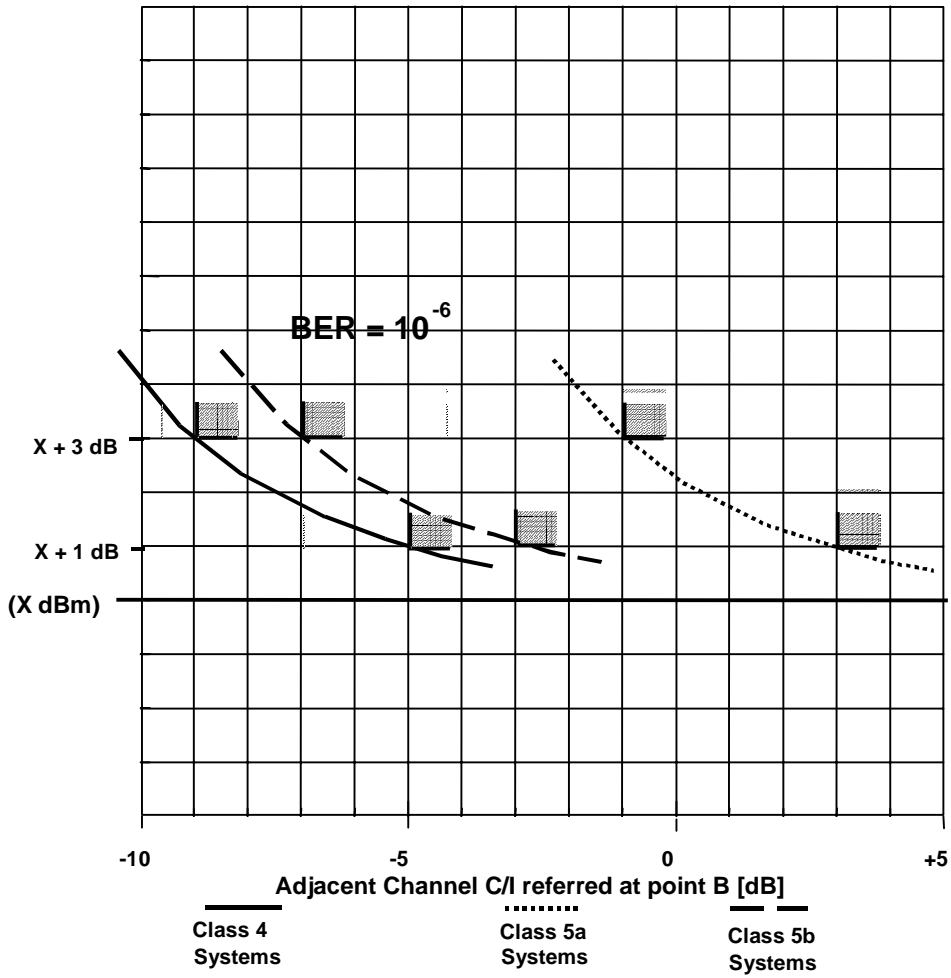

NOTE: X dBm = 10<sup>-6</sup> BER threshold provided by XPD 5.5.1.

Figure A.3: First adjacent channel interference threshold degradation

---

## Annex B (normative): Essential requirements for the EC Council Directive 89/336 (EMC Directive)

The clauses of the present document, reported in table B.1, are relevant for the EC directive 89/336.

**Table B.1: XPDs of the present document relevant for compliance with the essential requirements of the EC Council Directive 89/336**

Clause/ XPD number, or annex reference	Title	Corresponding article of Council Directive 89/336/EEC [30]	Qualifying remarks
	Spurious emission tests		
5.3.7.1	Transmitter Spurious emissions	4(a)	
5.4.3	Receiver Spurious emissions	4(a)	
	Receiver Immunity tests		
5.5.3.3	CW spurious interference	4(b)	

---

## Annex C (normative): System type codes for regulatory procedures

System types reported in the present document shall be identified with the codes reported in table C.1.

**Table C.1: System type codes for radio equipment reported in the present document, relevant to regulatory procedures for national licensing**

<b>Spectrum efficiency class</b> ↓	<b>Channel spacing [MHz]</b> ↓	<b>Bit-rate [Mbit/s]</b> ↓	<b>System Type codes</b> ↓
4	55	140 or 155	01
5a	27,5	140 or 155	02
5b	27,5	140 or 155	03

---

## Bibliography

- ETSI ETS 300 119 (all parts): "Equipment Engineering (EE); European telecommunication standard for equipment practice".
- ITU-T Recommendation G.781: "Synchronization layer functions".
- ITU-T Recommendation G.782: "Types and general characteristics of synchronous digital hierarchy (SDH) equipment".
- ITU-T Recommendation G.783: "Characteristics of synchronous digital hierarchy (SDH) equipment functional blocks".

---

## History

<b>Document history</b>		
V1.1.2	February 1999	Publication
V1.2.1	October 2000	Publication
V1.3.1	September 2000	One-step Approval Procedure      OAP 20010216: 2000-10-18 to 2001-02-16
V1.3.1	February 2001	Publication