

Final draft **ETSI EN 300 392-5** V2.2.0 (2010-03)

European Standard (Telecommunications series)

**Terrestrial Trunked Radio (TETRA);
Voice plus Data (V+D) and Direct Mode Operation (DMO);
Part 5: Peripheral Equipment Interface (PEI)**



Reference

REN/TETRA-04176

Keywords

data, interface, TETRA, V+D, voice

ETSI

650 Route des Lucioles
F-06921 Sophia Antipolis Cedex - FRANCE

Tel.: +33 4 92 94 42 00 Fax: +33 4 93 65 47 16

Siret N° 348 623 562 00017 - NAF 742 C
Association à but non lucratif enregistrée à la
Sous-Préfecture de Grasse (06) N° 7803/88

Important notice

Individual copies of the present document can be downloaded from:

<http://www.etsi.org>

The present document may be made available in more than one electronic version or in print. In any case of existing or perceived difference in contents between such versions, the reference version is the Portable Document Format (PDF). In case of dispute, the reference shall be the printing on ETSI printers of the PDF version kept on a specific network drive within ETSI Secretariat.

Users of the present document should be aware that the document may be subject to revision or change of status. Information on the current status of this and other ETSI documents is available at

<http://portal.etsi.org/tb/status/status.asp>

If you find errors in the present document, please send your comment to one of the following services:

http://portal.etsi.org/chaicor/ETSI_support.asp

Copyright Notification

No part may be reproduced except as authorized by written permission.
The copyright and the foregoing restriction extend to reproduction in all media.

© European Telecommunications Standards Institute 2010.
All rights reserved.

DECT™, **PLUGTESTS™**, **UMTS™**, **TIPHON™**, the TIPHON logo and the ETSI logo are Trade Marks of ETSI registered for the benefit of its Members.

3GPP™ is a Trade Mark of ETSI registered for the benefit of its Members and of the 3GPP Organizational Partners.

LTE™ is a Trade Mark of ETSI currently being registered

for the benefit of its Members and of the 3GPP Organizational Partners.

GSM® and the GSM logo are Trade Marks registered and owned by the GSM Association.

Contents

Intellectual Property Rights	19
Foreword.....	19
Introduction	20
1 Scope	21
2 References	21
2.1 Normative references	21
2.2 Informative references.....	23
3 Symbols and abbreviations.....	23
3.1 Symbols.....	23
3.2 Abbreviations	24
4 Overview of TETRA PEI	26
4.1 Introduction	26
4.2 Protocol architecture.....	27
4.3 Context model	27
4.4 Void.....	30
4.5 SDS Message stacks.....	30
4.5.1 Status message texts.....	30
4.5.2 SDS 1 message texts	30
4.5.3 Status and SDS types 1, 2 and 3	30
4.5.4 SDS type 4	31
4.6 Phone books	31
4.7 Reserved status values considerations.....	31
4.8 SDS-TL considerations	31
4.9 AT commands	32
4.9.1 General on AT commands	32
4.9.2 AT command state	34
4.9.3 AT circuit mode data state	34
4.9.4 TNP1 and packet data state.....	35
4.9.5 Transitions between states	35
4.9.5.1 Transition from AT command state to AT circuit mode data state	35
4.9.5.2 Transition from AT circuit mode data state to AT command state	35
4.9.5.3 Transition from AT command state to TNP1 or packet data state	36
4.9.5.4 Transition from TNP1 and packet data state to AT command state.....	36
4.10 TNP1 and IP network layer	36
4.10.1 General operation.....	36
4.10.2 IP addressing.....	36
4.10.3 Local mode	37
4.10.4 Wide mode.....	37
4.11 TNP1 operation	37
4.12 Link start up at the MT.....	38
5 Physical layer	38
5.1 General on physical layer	38
5.2 Physical layer for V.24/V.28	39
5.2.1 Electrical characteristics for V.24/V.28.....	39
5.2.2 Physical connection	39
5.2.3 Character format	40
5.2.4 Data transmission rate for V.24/V.28	40
5.3 Wire-line high rate connectivity technologies	40
5.3.1 General.....	40
5.3.2 Universal Serial Bus	41
5.3.3 USB On-The-Go.....	42
5.4 Wireless high rate connectivity	42
5.4.1 General.....	42

5.4.2	Wireless Security	42
5.4.3	Certified Wireless USB	43
5.4.4	Bluetooth	43
6	AT command set	43
6.1	General on AT command set	43
6.2	Limitations	44
6.3	SDS user data	44
6.4	AT command syntax	45
6.4.1	General on AT command syntax	45
6.4.2	Command line	45
6.4.2.1	Prefix	45
6.4.2.2	Body	45
6.4.2.3	Termination Character	45
6.4.2.4	Concatenating extended commands	45
6.4.3	Command Types	45
6.4.4	Parameters	46
6.4.5	Examples	46
6.4.6	Information responses and result codes	46
6.4.6.1	General on information responses and result codes	46
6.4.6.2	Information Responses	47
6.4.6.3	Result Code	47
6.4.6.4	Examples	47
6.4.7	Handling of unknown parameters	48
6.5	Existing V.250 commands for call control	48
6.5.1	Commands	48
6.5.2	Result Codes	49
6.5.3	Dialled string and user identity	49
6.6	Existing V.250 commands for PEI control	50
6.7	Existing V.250 commands for generic MT control	50
6.8	Existing Hayes AT commands for PEI control	51
6.9	Existing GSM commands for MT control	51
6.10	Modified PCCA wireless extended commands	52
6.11	Modified Cellular commands for MT control	52
6.11.1	General on cellular commands for MT control	52
6.11.2	MT Capabilities +GCAP	52
6.11.2.1	General on +GCAP	52
6.11.2.2	Description	52
6.11.2.3	GCAP Read and Unsolicited Result Code Text	52
6.11.3	Network registration +CREG	53
6.11.3.1	General on +CREG	53
6.11.3.2	CREG Set Syntax	53
6.11.3.3	Description	53
6.11.3.4	CREG Read and Unsolicited Result Code Text	53
6.11.4	Get MT TETRA identities +CNUM	53
6.11.4.1	General on +CNUM	53
6.11.4.2	Description	53
6.11.4.3	CNUM Read Result Code Text	53
6.11.5	Get MT TETRA Identities (alternative commands)	54
6.11.5.1	Get MT TETRA Fixed identity number(s): ITSI, and Gateway address(es) +CNUMF	54
6.11.5.1.1	General on +CNUMF	54
6.11.5.1.2	Description	54
6.11.5.1.3	CNUMF Read Result Code Text	54
6.11.5.2	Get MT static group identities +CNUMS	54
6.11.5.2.1	General on +CNUMS	54
6.11.5.2.2	Description	54
6.11.5.2.3	CNUMS Set Syntax	55
6.11.5.2.4	CNUMS Read and Unsolicited Result Code Text	55
6.11.5.3	Get MT dynamic group identities +CNUMD	55
6.11.5.3.1	General on +CNUMD	55
6.11.5.3.2	Description	55
6.11.5.3.3	CNUMD Set Syntax	55

6.11.5.3.4	CNUMD Read and Unsolicited Result Code Text	55
6.12	Modified GSM SDS message stack commands	56
6.12.1	General on Modified GSM SDS message stack commands	56
6.12.2	Delete message +CMGD	56
6.12.2.1	General on +CMGD	56
6.12.2.2	CMGD Set Syntax	56
6.12.2.3	Description	56
6.12.3	List messages +CMGL	56
6.12.3.1	General on +CMGL	56
6.12.3.2	CMGL Set Syntax	56
6.12.3.3	Description	57
6.12.3.4	CMGL Set Result Code Text	57
6.12.4	Read message +CMGR	57
6.12.4.1	General on +CMGR	57
6.12.4.2	CMGR Set Syntax	57
6.12.4.3	Description	57
6.12.4.4	CMGR Set and unsolicited Result Codes	57
6.12.5	Write message +CMGW	58
6.12.5.1	General on +CMGW	58
6.12.5.2	CMGW Set Syntax	58
6.12.5.3	Description	58
6.12.5.4	CMGW Set Result Codes	58
6.12.6	Message send from store +CMSS	59
6.12.6.1	General on +CMSS	59
6.12.6.2	CMSS Set Syntax	59
6.12.6.3	Description	59
6.12.6.4	CMSS Set Result Codes	59
6.12.7	New message indication +CMTI	59
6.12.7.1	General on +CMTI	59
6.12.7.2	Description	59
6.12.7.3	CMTI Unsolicited Result Code Text	60
6.13	Modified GSM SDS direct commands	60
6.13.1	General on GSM SDS direct commands	60
6.13.2	Send message +CMGS	60
6.13.2.1	General on +CMGS	60
6.13.2.2	CMGS Set Syntax	60
6.13.2.3	Description	60
6.13.2.4	CMGS Set and Unsolicited Result Code Text	60
6.13.3	TETRA SDS Receive +CTSDSR	61
6.13.3.1	General on +CTSDSR	61
6.13.3.2	Description	61
6.13.3.3	CTSDSR unsolicited Result Codes	61
6.14	TETRA MT control commands	61
6.14.1	General on TETRA MT control commands	61
6.14.2	TETRA Broadcast +CTBCT	61
6.14.2.1	General on +CTBCT	61
6.14.2.2	Description	61
6.14.2.3	CTBCT Result Code text	61
6.14.3	TETRA Status Text Read +CTSTR	62
6.14.3.1	General on +CTSTR	62
6.14.3.2	CTSTR Set Syntax	62
6.14.3.3	Description	62
6.14.3.4	CTSTR Read Result Code text	62
6.14.4	TETRA Service Profile +CTSP	62
6.14.4.1	General on +CTSP	62
6.14.4.2	CTSP Set Syntax	62
6.14.4.3	Description	62
6.14.4.4	CTSP Read Result Code text	64
6.14.5	TETRA service definition for Circuit Mode services +CTSDC	64
6.14.5.1	General on +CTSDC	64
6.14.5.2	CTSDC Set Syntax	64
6.14.5.3	Description	65

6.14.5.4	CTSDC Read Result Code text	65
6.14.6	TETRA service definition for SDS Service +CTSDS	65
6.14.6.1	General on +CTSDS	65
6.14.6.2	CTSDS Set Syntax	65
6.14.6.3	Description	65
6.14.6.4	CTSDS Read Result Code text.....	66
6.14.7	TETRA operating mode +CTOM.....	66
6.14.7.1	General on +CTOM	66
6.14.7.2	CTOM Set Syntax	66
6.14.7.3	Description	66
6.14.7.4	CTOM Read and Unsolicited Result Code text	66
6.14.8	TETRA DM communication type +CTDCT	67
6.14.8.1	General on +CTDCT.....	67
6.14.8.2	CTDCT Set Syntax	67
6.14.8.3	Description	67
6.14.8.4	CTDCT Read and Unsolicited Result Code text.....	67
6.14.9	TETRA Transient communication type +CTTCT	67
6.14.9.1	General on +CTTCT	67
6.14.9.2	CTTCT Set Syntax.....	67
6.14.9.3	Description	67
6.14.9.4	CTTCT Unsolicited Result Code Text.....	67
6.14.10	TETRA DMO visible gateways/repeaters +CTDGR.....	68
6.14.10.1	General on +CTDGR	68
6.14.10.2	CTDGR Set Syntax	68
6.14.10.3	Description	68
6.14.10.4	CTDGR Read and Unsolicited Result Code text	68
6.14.11	TETRA DM Carrier Selection +CTDCS	68
6.14.11.1	General on +CTDCS	68
6.14.11.2	CTDCS Set Syntax.....	68
6.14.11.3	Description	68
6.14.11.4	CTDCS Read and Unsolicited Result Code text	69
6.14.12	MT Reboot ATR.....	69
6.14.12.1	General on MT Reboot ATR.....	69
6.14.12.2	Description	69
6.14.12.3	ATR execution syntax.....	69
6.15	New TETRA call handling commands.....	69
6.15.1	General on new TETRA call handling commands	69
6.15.2	TETRA Call Connect +CTCC	69
6.15.2.1	General on +CTCC	69
6.15.2.2	Description	70
6.15.2.3	CTCC Unsolicited Result Code Text	70
6.15.3	TETRA Call Release +CTCR.....	70
6.15.3.1	General on +CTCR	70
6.15.3.2	Description	70
6.15.3.3	CTCR Unsolicited Result Code Text	70
6.15.4	TETRA Incoming Call Notification +CTICN	70
6.15.4.1	General on +CTICN.....	70
6.15.4.2	Description	70
6.15.4.3	CTICN Unsolicited Result Code Text.....	71
6.15.5	TETRA outgoing Call progress notification +CTOCP	71
6.15.5.1	General on +CTOCP	71
6.15.5.2	Description	71
6.15.5.3	CTOCP Unsolicited Result Code Text.....	71
6.15.6	TETRA Group Set up +CTGS.....	71
6.15.6.1	General on +CTGS.....	71
6.15.6.2	CTGS Set Syntax	72
6.15.6.3	Description	72
6.15.6.4	CTGS Read and unsolicited Result Code text.....	72
6.15.7	TETRA SDS Receive +CTSDSR	72
6.15.8	Transmit Demand +CTXD	72
6.15.8.1	General on +CTXD	72
6.15.8.2	CTXD Set Syntax.....	72

6.15.8.3	Description	72
6.15.9	Up Transmit Ceased +CUTXC	73
6.15.9.1	General +CUTXC	73
6.15.9.2	CUTXC Set Syntax	73
6.15.9.3	Description	73
6.15.10	Transmission Grant +CTXG	73
6.15.10.1	General on +CTXG	73
6.15.10.2	Description	73
6.15.10.3	CTXG Unsolicited Result Code Text	73
6.15.11	Down Transmission Ceased +CDTXC	73
6.15.11.1	General on +CDTXC	73
6.15.11.2	Description	73
6.15.11.3	CDTXC Unsolicited Result Code Text	74
6.15.12	Transmission Continue +CTXN	74
6.15.12.1	General on +CTXN	74
6.15.12.2	Description	74
6.15.12.3	CTXN Unsolicited Result Code Text	74
6.15.13	Transmission Interrupt +CTXI	74
6.15.13.1	General on +CTXI	74
6.15.13.2	Description	74
6.15.13.3	CTXI Unsolicited Result Code Text	74
6.15.14	Transmission Wait +CTXW	74
6.15.14.1	General on +CTXW	74
6.15.14.2	Description	74
6.15.14.3	CTXW Unsolicited Result Code Text	74
6.15.15	Key Status +CTKST	75
6.15.15.1	General on +CTKST	75
6.15.15.2	CTKST Set Syntax	75
6.15.15.3	Description	75
6.16	MT errors	75
6.16.1	General on MT errors	75
6.16.2	Report MT error +CMEE	75
6.16.2.1	General on +CMEE	75
6.16.2.2	CMEE Set Syntax	76
6.16.2.3	Description	76
6.16.2.4	CMEE Set Result Code Text	76
6.16.3	MT error result code +CME ERROR	76
6.16.3.1	General on +CME ERROR	76
6.16.3.2	Description	76
6.16.3.3	CME ERROR Unsolicited Result Code Text	76
6.16.4	MT result code +CME PARAMETER	76
6.16.4.1	General on +CME PARAMETER	76
6.16.4.2	Description	76
6.16.4.3	CME PARAMETER Unsolicited Result Code Text	76
6.17	Parameter description and values	77
6.17.1	General on parameters	77
6.17.2	Access Priority	77
6.17.3	AI Service	77
6.17.4	AI mode	78
6.17.5	Alpha	78
6.17.5a	Ancillary ID	78
6.17.6	Area	78
6.17.7	BS service	79
6.17.8	Call status	79
6.17.9	Called party identity	80
6.17.10	Calling party identity	80
6.17.11	Called party identity type	80
6.17.12	Calling party identity type	80
6.17.13	CC instance	80
6.17.14	Class of MS	81
6.17.15	CLIR control	83
6.17.16	Comms type	84

6.17.17	CT unsolic.....	84
6.17.18	Disconnect cause	84
6.17.19	DM carrier	85
6.17.20	DM communication type	85
6.17.21	End to End encryption	86
6.17.22	Extended error report.....	86
6.17.23	Extended error report codes	86
6.17.24	Gateway/repeater address	87
6.17.25	Group type	87
6.17.26	GR unsolic	88
6.17.27	Hook	88
6.17.28	Ident unsolic.....	88
6.17.29	Importance factor.....	88
6.17.29a	Key name	88
6.17.29b	Key status	89
6.17.30	LA.....	89
6.17.31	Length.....	89
6.17.32	Link identifier	89
6.17.33	Lower range Limit	89
6.17.34	Message index	90
6.17.35	Message reference.....	90
6.17.36	MNI	90
6.17.37	Number of groups	90
6.17.38	Num type	90
6.17.39	Parameter number	90
6.17.40	PID.....	90
6.17.41	Presence information	91
6.17.42	Priority	91
6.17.43	Priority level	92
6.17.44	Proprietary	92
6.17.45	Proprietary element owner.....	92
6.17.46	Reg stat	92
6.17.47	Reg unsolic	92
6.17.48	RqTx	92
6.17.49	SDS instance.....	93
6.17.50	SDS-TL addressing.....	93
6.17.51	SDS Status	93
6.17.52	Security information	93
6.17.53	Service profile.....	93
6.17.54	Service layer1	94
6.17.55	Service layer2	94
6.17.56	Serviced GSSI.....	95
6.17.57	Simplex.....	95
6.17.58	Slots/Codec	95
6.17.59	Stack full.....	95
6.17.60	Stack present.....	95
6.17.61	TPI (Transmitting Party Identity)	96
6.17.62	TPI (Transmitting Party Identity) type.....	96
6.17.63	Transient communication type.....	96
6.17.64	TxCont	96
6.17.65	TxDemandPriority	96
6.17.66	TxGrant.....	96
6.17.67	TxRqPrmsn	97
6.17.68	Upper range limit.....	97
6.17.69	User data	97
6.18	Outgoing call set up methodology.....	97
6.18.1	General on outgoing call set up methodology.....	97
6.18.2	Voice calls	97
6.18.3	Circuit mode data calls	98
6.18.4	Sending of SDS messages.....	99
6.18.4.1	General on sending of SDS messages	99
6.18.4.2	Send via Stack.....	99

6.18.4.3	Direct Send.....	99
6.19	Incoming call set up methodology	99
6.19.1	General on incoming call set up methodology.....	99
6.19.2	Voice calls	99
6.19.3	Circuit mode data calls	100
6.19.4	Reception of SDS messages.....	100
6.19.4.1	Received via Stack	100
6.19.4.2	Direct Received.....	100
6.20	Voice and circuit mode data call maintenance commands	100
6.21	Call clear down commands	101
6.21.1	General on call clear down commands	101
6.21.2	TE Initiated clear	101
6.21.3	Network and MT Initiated clear.....	101
6.22	MEX layer support.....	101
6.22.1	MEX Capability +CTMCAP	101
6.22.1.1	General on +CTMCAP	101
6.22.1.2	CTMCAP Read Syntax	101
6.22.1.3	CTMCAP Response Syntax	101
6.22.2	MEX Connect +CTMCON.....	102
6.22.2.1	General on +CTMCON.....	102
6.22.2.2	CTMCON Set Syntax	102
6.22.2.3	CTMCON Result Code Syntax	102
6.22.3	MEX End +CTMEND	102
6.22.3.1	General on +CTMEND	102
6.22.3.2	CTMEND Set Syntax.....	102
6.22.3.3	CTMEND Response and Unsolicited Result Code Syntax	102
6.22.4	MEX Handle +CTMHDL MEX Handle.....	102
6.22.4.1	General on +CTMHDL	102
6.22.4.2	CTMHDL Set Syntax.....	102
6.22.4.3	CTMHDL Response Syntax.....	102
6.22.5	MEX Modify +CTMMOD	103
6.22.5.1	General on +CTMMOD.....	103
6.22.5.2	CTMMOD Set Syntax.....	103
6.22.5.3	CTMMOD Result Code Syntax	103
6.22.5.4	CTMMOD Unsolicited Report Syntax.....	103
6.22.6	MEX QOS Class +CTMQC	103
6.22.6.1	General on +CTMQC.....	103
6.22.6.2	CTMQC Set/Read Syntax	103
6.22.6.3	CTMQC Response Syntax	103
6.22.7	Request New Logical PEI Connection +CTPCON.....	103
6.22.7.1	General on +CTPCON	103
6.22.7.2	CTPCON Set Syntax.....	104
6.22.7.3	CTPCON Response Syntax.....	104
6.22.8	MEX related Parameters	104
6.22.8.1	CONTEXT_READY timer	104
6.22.8.2	Data Class	104
6.22.8.3	Data Importance	105
6.22.8.4	Data Priority	105
6.22.8.5	DCOMP	105
6.22.8.6	Delay Class	105
6.22.8.7	Device address	105
6.22.8.8	Endpoint address	105
6.22.8.9	Maximum Transmission Unit.....	106
6.22.8.10	Mean Active Throughput	106
6.22.8.11	Mean Throughput.....	106
6.22.8.12	MEX Capability	107
6.22.8.13	MEX Connect Reject Cause.....	107
6.22.8.14	MEX Connect Report.....	108
6.22.8.15	MEX Data Importance	108
6.22.8.16	MEX Data Priority	108
6.22.8.17	MEX Deactivation Type	109
6.22.8.18	MEX Escalate DSCP5 Flag Enable.....	109

6.22.8.19	MEX Escalate DSCP5 Flag Reset.....	109
6.22.8.20	MEX Filter	109
6.22.8.21	MEX Filter Operation	109
6.22.8.22	MEX Filter Type	109
6.22.8.23	MEX Handle	110
6.22.8.24	MEX Mode	110
6.22.8.25	MEX Modify Reject Cause	110
6.22.8.26	MEX Modify Report	110
6.22.8.27	MEX NSAPI Usage	111
6.22.8.28	MEX PDP Address	111
6.22.8.29	MEX PDP Type	111
6.22.8.30	MEX PDU Priority Max	111
6.22.8.31	MEX Precedence.....	112
6.22.8.32	MEX precedence rank.....	112
6.22.8.33	MEX precedence supported	112
6.22.8.34	MEX Peer IP Filter.....	112
6.22.8.35	MEX QoS.....	112
6.22.8.36	MEX QoS Class	112
6.22.8.37	MEX QoS Class Access.....	112
6.22.8.38	MEX QoS Class Upper/Lower (Downlink).....	113
6.22.8.39	MEX QoS Class Upper/Lower (Uplink).....	113
6.22.8.40	MEX QoS Filter	113
6.22.8.41	MEX Transaction Type.....	113
6.22.8.42	Minimum Peak Throughput	113
6.22.8.43	Mobile IPv4 Information.....	114
6.22.8.44	NSAPI.....	114
6.22.8.45	NSAPI Data Priority	114
6.22.8.46	NSAPI QoS Negotiation	114
6.22.8.47	PCOMP	114
6.22.8.48	PCON result	115
6.22.8.49	PDU Priority	115
6.22.8.50	PDU Priority Max	115
6.22.8.51	Reliability Class	115
6.22.8.52	Schedule availability	115
6.22.8.53	Scheduled access.....	115
6.22.8.54	Scheduled Number of N-PDU's per grant.....	116
6.22.8.55	Scheduled N-PDU size.....	116
6.22.8.56	Schedule Repetition Period.....	116
6.22.8.57	Schedule Timing Error.....	116
6.22.8.58	Share response flag	117
7	TNP1 service description	117
7.1	Service primitives at the TNP1A-SAP	117
7.2	Service primitives at the TNP1B-SAP	117
7.3	Service primitives at TNP1A-SAP and TNP1B-SAP	117
7.4	Primitive descriptions.....	118
7.4.1	TNP1-Services CAPABILITY	118
7.4.2	TNP1-SDS-TL CAPABILITY	118
7.4.3	TNP1-IDENTIFICATION.....	118
7.4.4	TNP1-IDENTITIES.....	119
7.4.5	TNP1-REPORT	119
7.4.6	TNP1-SERVICE ACCESS.....	120
7.4.7	TNP1-SERVICE PROFILES.....	120
7.4.7.1	General on TNP1 service profiles	120
7.4.7.2	TNP1-SDS SERVICE PROFILE.....	120
7.4.7.3	TNP1-CC SERVICE PROFILE.....	121
7.4.7.4	TNP1-MM SERVICE PROFILE	121
7.4.7.5	TNP1-SDS-TL SERVICE PROFILE.....	121
7.4.8	TNP1-STATE.....	122
7.4.9	TNP1-UNITDATA.....	122
7.4.10	Mapping of TNP1 PDUs and MT2 service primitives.....	123
7.5	Parameter description	124

7.6	Service states for TNPIA-SAP	124
7.7	Service states for TNPIB-SAP.....	125
8	TNP1 protocol	125
8.1	Procedures	125
8.1.1	Establishing communication between TE2 user applications and MT2	125
8.1.2	Closing the TNP1 communication.....	125
8.1.3	Reporting normal and abnormal events	125
8.1.4	Querying MT2 identification information	125
8.1.5	Querying MT2 capabilities	126
8.1.6	Querying MT2 state	126
8.1.7	Setting/getting the service profile	126
8.1.8	Accessing CMCE and MM services	127
8.1.9	Circuit mode data.....	128
8.1.10	Requesting a new PEI connection.....	128
8.2	Protocol timers	129
8.3	PDU structure.....	129
8.3.1	General on PDU structure.....	129
8.3.2	Structure and encoding of type 1 elements	131
8.3.3	Structure and encoding of type 2 elements	131
8.3.4	Structure and encoding of type 3 elements	131
8.3.5	Examples of PDU encoding.....	132
8.4	TNP1 PDU descriptions	133
8.4.1	General on TNP1 PDU descriptions	133
8.4.2	PDU's relating to CC	133
8.4.2.1	TECC-ALERT IND	133
8.4.2.2	TECC-COMPLETE CON.....	134
8.4.2.3	TECC-COMPLETE IND.....	134
8.4.2.4	TECC-COMPLETE REQ	134
8.4.2.5	TECC-DTMF IND	135
8.4.2.6	TECC-DTMF REQ	135
8.4.2.7	TECC-MODIFY IND	135
8.4.2.8	TECC-MODIFY REQ	136
8.4.2.9	TECC-NOTIFY IND	136
8.4.2.10	TECC-PROCEED IND.....	137
8.4.2.11	TECC-RELEASE CON	137
8.4.2.12	TECC-RELEASE IND.....	137
8.4.2.13	TECC-RELEASE REQ.....	138
8.4.2.14	TECC-SETUP CON.....	138
8.4.2.15	TECC-SETUP IND.....	139
8.4.2.16	TECC-SETUP REQ	140
8.4.2.17	TECC-SETUP RES.....	140
8.4.2.18	TECC-TX CON	141
8.4.2.19	TECC-TX IND.....	141
8.4.2.20	TECC-TX REQ.....	142
8.4.3	PDU's relating to circuit mode data.....	142
8.4.3.1	TEMAC-FLOW CONTROL PDU	142
8.4.3.2	TEMAC-UNITDATA.....	142
8.4.4	PDU's relating to MM	142
8.4.4.1	General on MM PDU's	142
8.4.4.2	TEMM-ATTACH DETACH GROUP IDENTITY CON	143
8.4.4.3	TEMM-ATTACH DETACH GROUP IDENTITY IND	143
8.4.4.4	TEMM-ATTACH DETACH GROUP IDENTITY REQ	143
8.4.4.5	TEMM-DISABLING IND.....	144
8.4.4.6	TEMM-DEREGISTRATION REQ	144
8.4.4.7	TEMM-ENABLING IND	144
8.4.4.8	TEMM-ENERGY SAVING CON.....	144
8.4.4.9	TEMM-ENERGY SAVING IND	145
8.4.4.10	TEMM-ENERGY SAVING REQ	145
8.4.4.11	TEMM-REPORT IND.....	145
8.4.4.12	TEMM-REGISTRATION CON	146
8.4.4.13	TEMM-REGISTRATION IND	146

8.4.4.14	TEMM-REGISTRATION REQ	147
8.4.4.15	TEMM-SERVICE IND.....	147
8.4.4.16	TEMM-SERVICE REQ.....	147
8.4.4.17	TEMM-STATUS IND	148
8.4.4.18	TEMM-STATUS CON.....	148
8.4.4.19	TEMM-STATUS REQ	148
8.4.5	MT Application PDUs.....	149
8.4.5.1	TEMTA-SERVICES CAPABILITY RESP.....	149
8.4.5.2	TEMTA-SDS-TL CAPABILITY RESP.....	149
8.4.5.3	TEMTA-SERVICES CAPABILITY REQ.....	149
8.4.5.4	TEMTA-SDS-TL CAPABILITY REQ.....	150
8.4.5.5	TEMTA-IDENTITIES RES.....	150
8.4.5.6	TEMTA- IDENTITIES REQ.....	150
8.4.5.7	TEMTA-SETVOLUME REQ.....	150
8.4.5.8	TEMTA-SPEAKER-MIC REQ.....	151
8.4.5.9	TEMTA-SYSINFO RESP	151
8.4.5.10	TEMTA-SYSINFO REQ.....	151
8.4.5.11	TEMTA-IDENTIFICATION RES	151
8.4.5.12	TEMTA-IDENTIFICATION REQ.....	152
8.4.5.13	TEMTA-SDS STACK MESSAGES	152
8.4.5.13.1	General on TEMA-SDS stack messages	152
8.4.5.13.2	TEMTA-SDS DELETE MESSAGES.....	153
8.4.5.13.3	TEMTA-SDS MESSAGE ERROR.....	153
8.4.5.13.4	TEMTA-SDS MESSAGES IND.....	153
8.4.5.13.5	TEMTA-SDS MESSAGE REQ.....	154
8.4.5.13.6	TEMTA-SDS GET LIST BY KEY MESSAGES	154
8.4.5.13.7	TEMTA-SDS LIST MESSAGES REPLY	154
8.4.5.13.8	TEMTA-SDS NOTIFICATION.....	155
8.4.5.14	TEMTA-XXX SERVICE PROFILE RES	155
8.4.5.15	TEMTA-XXX SERVICE PROFILE REQ	156
8.4.5.16	TEMTA-XXX SERVICE PROFILE SET	157
8.4.5.17	TEMTA-STATE RES.....	158
8.4.5.18	TEMTA-STATE REQ.....	158
8.4.5.19	TEMTA-REPORT IND.....	158
8.4.5.20	TEMTA-NEW-PCON REQ.....	158
8.4.5.21	TEMTA-NEW-PCON CON	159
8.4.6	PDUs relating to SDS	159
8.4.6.1	General on SDS PDUs.....	159
8.4.6.2	TESDS-REPORT IND.....	159
8.4.6.3	TESDS-STATUS IND.....	160
8.4.6.4	TESDS-STATUS REQ.....	160
8.4.6.5	TESDS-UNITDATA IND	161
8.4.6.6	TESDS-UNITDATA REQ.....	162
8.4.7	PDUs relating to SDS-TL.....	162
8.4.7.1	TESDS-TL-ACK IND	162
8.4.7.2	TESDS-TL-ACK REQ.....	163
8.4.7.3	TESDS-TL-REPORT IND.....	164
8.4.7.4	TESDS-TL-REPORT REQ.....	165
8.4.7.5	TESDS-TL-TRANSFER IND.....	166
8.4.7.6	TESDS-TL-TRANSFER REQ.....	167
8.4.7.7	TESDS-TL-TNSDS-REPORT IND.....	168
8.4.7.8	TESDS-TL-UNITDATA IND	168
8.4.7.9	TESDS-TL-UNITDATA REQ	169
8.4.8	PDUs relating to SS	169
8.4.8.1	TESS-FACILITY CON	169
8.4.8.2	TESS-FACILITY IND.....	169
8.4.8.3	TESS-FACILITY REQ.....	170
8.4.8.4	TESS-FACILITY RES.....	170
8.4.9	PDUs relating to MEX.....	170
8.4.9.1	TEMX-CAPABILITY REQ	170
8.4.9.2	TEMX-CAPABILITY CON	170
8.4.9.3	TEMX-CONNECT REQ	171

8.4.9.4	TEMX-CONNECT CON	172
8.4.9.5	TEMX-BYPASS DATA REQ	172
8.4.9.6	TEMX-BYPASS DATA IND	173
8.4.9.7	TEMX-DELIVERY_IND	173
8.4.9.8	TEMX-END REQ	173
8.4.9.9	TEMX-END CON	174
8.4.9.10	TEMX-END IND	174
8.4.9.11	TEMX-HANDLE REQ	174
8.4.9.12	TEMX-HANDLE CON	174
8.4.9.13	TEMX-MODIFY REQ	175
8.4.9.14	TEMX-MODIFY CON	175
8.4.9.15	TEMX-MODIFY IND	176
8.4.9.16	TEMX-QOSCLASS REQ	176
8.4.9.17	TEMX-QOSCLASS CON	176
8.5	Information elements coding	177
8.5.1	General on information element coding	177
8.5.2	Access Priority (AP)	177
8.5.3	Acknowledgement required	177
8.5.4	Address extension	177
8.5.5	Area Selection (AS)	178
8.5.6	Attach detach request status	178
8.5.7	Basic service information	179
8.5.8	Battery charge	179
8.5.9	Bit error ratio	180
8.5.10	BS service details	180
8.5.11	Call amalgamation	181
8.5.12	Call handle	181
8.5.13	Called party extension	181
8.5.14	Called party self address type	181
8.5.15	Called party short number address (SNA)	182
8.5.16	Called party Short Subscriber Identity (SSI)	182
8.5.17	Called party type identifier	182
8.5.18	Calling party extension	182
8.5.19	Calling party Short Subscriber Identity (SSI)	182
8.5.20	Calling party type identifier	183
8.5.21	Call ownership	183
8.5.22	Call priority	183
8.5.23	Call queued	183
8.5.24	Call status	184
8.5.25	Call time-out	184
8.5.26	Call time-out, set-up phase	184
8.5.27	CC profile	185
8.5.28	Circuit mode and MS services	185
8.5.29	Circuit mode data	186
8.5.30	Class of usage	186
8.5.31	CLIR control	187
8.5.32	CONTEXT_READY timer	187
8.5.33	Data class	187
8.5.34	Data handle	188
8.5.35	Data importance	188
8.5.36	Data priority	188
8.5.37	DCOMP	188
8.5.38	Delay class	189
8.5.39	Delivery report request	189
8.5.40	Delivery status	189
8.5.41	Device address	191
8.5.42	Direct mode	191
8.5.43	Disconnect type	191
8.5.44	DTMF result	191
8.5.45	Disconnect cause	192
8.5.46	Disconnect status	192
8.5.47	DTMF digits	193

8.5.48	DTMF tone delimiter	193
8.5.49	Dual watch	193
8.5.50	Enable/Disable status	194
8.5.51	End to end encryption flag	194
8.5.52	Endpoint address	194
8.5.53	Energy economy mode	194
8.5.54	Energy economy mode status	195
8.5.55	External subscriber number	195
8.5.56	External subscriber number digits	195
8.5.57	Facility	195
8.5.58	Field strength	196
8.5.59	Forward address type identifier	196
8.5.60	Function	196
8.5.61	Group identity address type	197
8.5.62	Group identity attach/detach mode	197
8.5.63	Group identity attach/detach type identifier	197
8.5.64	Group identity attachment	197
8.5.65	Group identity attachment lifetime	198
8.5.66	Group identity detachment downlink	198
8.5.67	Group identity detachment uplink	198
8.5.68	Group identity downlink	199
8.5.69	Group identity report	199
8.5.70	Group identity uplink	199
8.5.71	Group Short Subscriber Identity (GSSI)	200
8.5.72	GTSI	200
8.5.73	Hardware version	200
8.5.74	Hook method selection	200
8.5.75	Internal temperature	200
8.5.76	ISO global object ID	201
8.5.77	ITSI	201
8.5.78	Key Mask	201
8.5.79	LA	201
8.5.80	Length indicator	202
8.5.81	Manufacturer identifier	202
8.5.82	Max data	202
8.5.83	Maximum transmission unit	202
8.5.84	MCC	203
8.5.85	Mean active throughput	203
8.5.86	Mean throughput	203
8.5.87	Message index	203
8.5.88	Message reference	204
8.5.89	Message reference handle	204
8.5.90	MEX capability	204
8.5.91	MEX connect reject cause	205
8.5.92	MEX connect report	206
8.5.93	MEX deactivation type	206
8.5.94	MEX delivery header	206
8.5.95	MEX delivery report	206
8.5.96	MEX escalate DSCP5 flag enable	207
8.5.97	MEX escalate DSCP5 flag reset	207
8.5.98	MEX filter - diffserv	207
8.5.99	MEX filter - port range	207
8.5.100	MEX filter operation	207
8.5.101	MEX filter type	208
8.5.102	MEX handle	208
8.5.103	MEX mode	208
8.5.104	MEX modify reject cause	208
8.5.105	MEX Modify report	209
8.5.105.1	Use MEX mode	209
8.5.105.2	Bypass to SNDCCP mode	209
8.5.106	MEX N-PDU	209
8.5.107	MEX NSAPI usage	210

8.5.108	MEX PDP address	210
8.5.108.1	IPV4 address	210
8.5.108.2	NSAPI	210
8.5.109	MEX PDP type	210
8.5.110	MEX Peer IP Filter	211
8.5.111	MEX precedence	211
8.5.112	MEX precedence rank	211
8.5.113	MEX precedence supported	212
8.5.114	MEX QoS	212
8.5.115	MEX QoS class	212
8.5.116	MEX QoS class access	212
8.5.117	MEX QoS class lower (downlink)	213
8.5.118	MEX QoS class upper (downlink)	213
8.5.119	MEX QoS class lower (uplink)	213
8.5.120	MEX QoS class upper (uplink)	213
8.5.121	MEX QoS filter	213
8.5.122	MEX Transaction type	213
8.5.123	Microphone on off	214
8.5.124	Minimum peak throughput	214
8.5.125	MM profile	214
8.5.126	MM transfer result	215
8.5.127	MNC	215
8.5.128	Mobile IPv4 information	215
8.5.129	Model	215
8.5.130	Modify	216
8.5.131	More information flag	216
8.5.132	MT2 default gateway address	216
8.5.133	Notification indicator	216
8.5.134	NSAPI	217
8.5.135	NSAPI data priority	217
8.5.136	NSAPI QoS negotiation	217
8.5.137	Number of groups	217
8.5.138	Number of messages	218
8.5.139	Over temperature indication	218
8.5.140	Packet data mode services	218
8.5.141	PCOMP	218
8.5.142	PCON result	219
8.5.143	PDU Group ID and PDU type	219
8.5.144	PDU priority	219
8.5.145	PDU priority max	219
8.5.146	PDU type values	220
8.5.147	Poll request	222
8.5.148	Poll response	222
8.5.149	Poll response addresses	222
8.5.150	Poll response number	223
8.5.151	Poll response percentage	223
8.5.152	Preferred LA list	223
8.5.153	Preferred MCC list	223
8.5.154	Preferred MNC list	224
8.5.155	Product serial number	224
8.5.156	Proprietary	224
8.5.157	Proprietary element owner	224
8.5.158	Protocol identifier	225
8.5.159	Protocol identifier kind	226
8.5.160	Reject cause	226
8.5.161	Registration status	226
8.5.162	Registration type	227
8.5.163	Reliability class	227
8.5.164	Report reason	227
8.5.165	Request to transmit/send data	228
8.5.166	Reset call time-out timer (T310)	228
8.5.167	Schedule available	228

8.5.168	Scheduled access	228
8.5.169	Scheduled N-PDU size	229
8.5.170	Scheduled number of N-PDUs per grant	229
8.5.171	Schedule repetition period	229
8.5.172	Schedule surplus flag	229
8.5.173	Schedule timing error.....	230
8.5.174	Share response flag	230
8.5.175	SDS control.....	230
8.5.176	SDS error	231
8.5.177	SDS full storage action	231
8.5.178	SDS message stack storage.....	231
8.5.179	SDS message status	231
8.5.180	SDS mode services	232
8.5.181	SDS notification.....	232
8.5.182	SDS profile type	232
8.5.183	SDS reference type	233
8.5.184	SDS stack message handling	233
8.5.185	SDS status profile	233
8.5.186	SDS type.....	234
8.5.187	SDS user data 1 profile	234
8.5.188	SDS user data 2 profile	234
8.5.189	SDS user data 3 Profile.....	234
8.5.190	SDS user data 4 Profile.....	234
8.5.191	SDS-TL service capability.....	234
8.5.192	SDS-TL service centre address type	235
8.5.193	SDS-TL service centre capability	235
8.5.194	SDS-TL service centre default address.....	235
8.5.195	SDS transfer result.....	235
8.5.196	Security.....	236
8.5.197	Security class of MS	236
8.5.198	Security information	236
8.5.199	Service profile operation.....	237
8.5.200	Service profile request result	237
8.5.201	Service selection	237
8.5.202	Service status	237
8.5.203	Set profile request.....	238
8.5.204	Short data type identifier.....	238
8.5.205	Short form report	238
8.5.206	Simplex/duplex selection.....	238
8.5.207	Software version	239
8.5.208	Speaker on off.....	239
8.5.209	SS PDU type.....	239
8.5.210	SS type	239
8.5.211	SSI	239
8.5.212	Stack usage	239
8.5.213	Status number	240
8.5.214	Storage	240
8.5.215	Store and forward PDU capability	240
8.5.216	Terminal Equipment Identity (TEI).....	240
8.5.217	Traffic stealing.....	241
8.5.218	TNP1 protocol version.....	241
8.5.219	TNP1 release.....	241
8.5.220	Transmission condition.....	241
8.5.221	Transmission grant.....	242
8.5.222	Transmission request permission	242
8.5.223	Transmission status.....	242
8.5.224	Transmitting party extension	242
8.5.225	Transmitting party Short Subscriber Identity (SSI)	243
8.5.226	Transmitting party type identifier	243
8.5.227	TX demand priority	243
8.5.228	Type 3 CMCE element identifier.....	243
8.5.229	Type 3 MM element identifier.....	244

8.5.230	Type 3 MTA element identifier	244
8.5.231	Type 3 SS element identifier.....	244
8.5.232	User application reference	245
8.5.233	User data	245
8.5.234	User defined data-1	245
8.5.235	User defined data-2.....	245
8.5.236	User defined data-3	245
8.5.237	Visitor Group Short Subscriber Identity (V)GSSI	246
8.5.238	Validity period	246
8.5.239	Volume level.....	246
Annex A (normative):	Formatting transparent circuit mode data to MAC PDU.....	247
Annex B (informative):	DMO Considerations.....	248
Annex C (informative):	Supplementary Services Considerations.....	249
Annex D (informative):	Supported functionality and PPP options.....	250
Annex E:	Void	251
Annex F (normative):	AT Multiplexing using +CMUX command	252
F.1	Introduction	252
F.2	Multiplexer mode activating procedure.....	253
F.3	DLCI service profile setting and changing procedure.....	253
F.4	Multiplexer mode close-down procedure.....	253
Annex G (informative):	DMO message sequences.....	254
G.1	Introduction	254
G.2	Configuring required operation	254
G.2.1	Set operating mode to DMO.....	254
G.2.2	Select gateway operation.....	254
G.2.3	Select DM gateway known to be present	255
G.2.4	DM gateway selected by MT	255
G.3	Call set-up	256
G.3.1	Incoming group call set-up (success)	256
G.3.2	Incoming individual call set-up with presence check (success)	256
G.3.3	Incoming individual call set-up with presence check (rejected by MT).....	257
G.3.4	Incoming individual call set-up with presence check (rejected by TE).....	257
G.3.5	Outgoing group call set-up (success).....	258
G.3.6	Outgoing individual call set-up with presence check (success).....	258
G.3.7	Outgoing group call set-up via gateway (success)	259
G.3.8	Outgoing individual call set-up via gateway (success).....	259
G.3.9	Outgoing call set-up (rejected by MT)	260
G.3.10	Outgoing individual call set-up with presence check (failure)	260
G.4	Call maintenance	261
G.4.1	End of transmission	261
G.4.2	End of transmission by another party.....	261
G.4.3	Transmit request when slave in reservation (success)	261
G.4.4	Transmit request via gateway when slave in reservation (success).....	262
G.4.5	Transmit request when master in reservation	262
G.4.6	Incoming transmit request when master in reservation (success).....	263
G.4.7	Incoming transmit request when slave in reservation.....	263
G.4.8	Pre-emptive transmit request when slave in occupation (success)	263
G.4.9	Incoming pre-emptive transmit request when master in occupation	264
G.4.10	Incoming pre-emption for new call when master in occupation.....	264
G.5	Call release	265

G.5.1	Call cleared by timeout when master in reservation.....	265
G.5.2	Call cleared by TE when master in reservation.....	265
G.5.3	Call cleared by other party when slave.....	265
G.5.4	Call cleared by timeout when slave.....	266
G.6	Transient Calls.....	266
G.6.1	Direct Call when operating with DM gateway.....	266
G.6.2	Direct Call when in V+D with dual watch on DMO.....	267
Annex H (informative):	Change requests	268
History		271

Intellectual Property Rights

IPRs essential or potentially essential to the present document may have been declared to ETSI. The information pertaining to these essential IPRs, if any, is publicly available for **ETSI members and non-members**, and can be found in ETSI SR 000 314: "*Intellectual Property Rights (IPRs); Essential, or potentially Essential, IPRs notified to ETSI in respect of ETSI standards*", which is available from the ETSI Secretariat. Latest updates are available on the ETSI Web server (<http://webapp.etsi.org/IPR/home.asp>).

Pursuant to the ETSI IPR Policy, no investigation, including IPR searches, has been carried out by ETSI. No guarantee can be given as to the existence of other IPRs not referenced in ETSI SR 000 314 (or the updates on the ETSI Web server) which are, or may be, or may become, essential to the present document.

Foreword

This European Standard (Telecommunications series) has been produced by ETSI Technical Committee Terrestrial Trunked Radio (TETRA), and is now submitted for the ETSI standards One-step Approval Procedure.

The present document is part 5 of a multi-part deliverable covering the Terrestrial Trunked Radio (TETRA); Voice plus Data (V+D), as identified below:

EN 300 392-1: "General network design";

EN 300 392-2: "Air Interface (AI)";

EN 300 392-3: "Interworking at the Inter-System Interface (ISI)";

ETS 300 392-4: "Gateways basic operation";

EN 300 392-5: "Peripheral Equipment Interface (PEI)";

EN 300 392-7: "Security";

EN 300 392-9: "General requirements for supplementary services";

EN 300 392-10: "Supplementary services stage 1";

EN 300 392-11: "Supplementary services stage 2";

EN 300 392-12: "Supplementary services stage 3";

ETS 300 392-13: "SDL model of the Air Interface (AI)";

ETS 300 392-14: "Protocol Implementation Conformance Statement (PICS) proforma specification";

TS 100 392-15: "TETRA frequency bands, duplex spacings and channel numbering";

TS 100 392-16: "Network Performance Metrics";

TR 100 392-17: "TETRA V+D and DMO specifications";

TS 100 392-18: "Air interface optimized applications".

NOTE: Part 10, sub-part 15 (Transfer of control), part 13 (SDL) and part 14 (PICS) of this multi-part deliverable are in status "historical" and are not maintained.

Proposed national transposition dates	
Date of latest announcement of this EN (doa):	3 months after ETSI publication
Date of latest publication of new National Standard or endorsement of this EN (dop/e):	6 months after doa
Date of withdrawal of any conflicting National Standard (dow):	6 months after doa

Introduction

The present document differs from version 1.3.1 of the PEI specification in the following key areas:

- Change requests approved against V1.3.1 of EN 300 392-5 have been included.
- DMO support is added.
- High speed data support is added.

Due to the extensive additions into the present document the figure and table numbering is modified to per clause format, see the ETSI drafting rules [i.6], clauses 21.3 and 22.4.

1 Scope

The present document specifies the functional and technical aspects of TETRA Peripheral Equipment Interface (PEI) that is the interface between a Terminal Equipment type 2 (TE2) and a Mobile Termination type 2 (MT2) at reference point R_T.

2 References

References are either specific (identified by date of publication and/or edition number or version number) or non-specific.

- For a specific reference, subsequent revisions do not apply.
- Non-specific reference may be made only to a complete document or a part thereof and only in the following cases:
 - if it is accepted that it will be possible to use all future changes of the referenced document for the purposes of the referring document;
 - for informative references.

Referenced documents which are not found to be publicly available in the expected location might be found at <http://docbox.etsi.org/Reference>.

NOTE: While any hyperlinks included in this clause were valid at the time of publication ETSI cannot guarantee their long term validity.

2.1 Normative references

The following referenced documents are indispensable for the application of the present document. For dated references, only the edition cited applies. For non-specific references, the latest edition of the referenced document (including any amendments) applies.

- [1] ETSI EN 300 392-1: "Terrestrial Trunked Radio (TETRA); Voice plus Data (V+D); Part 1: General network design".
- [2] ETSI TS 101 369: "Digital cellular telecommunications system (Phase 2+); Terminal Equipment to Mobile Station (TE-MS) multiplexer protocol (3GPP TS 07.10 version 7.2.0 Release 1998)".
- [3] ETSI EN 300 392-2: "Terrestrial Trunked Radio (TETRA); Voice plus Data (V+D); Part 2: Air Interface (AI)".
- [4] ITU-T Recommendation V.24: "List of definitions for interchange circuits between data terminal equipment (DTE) and data circuit-terminating equipment (DCE)".
- [5] ITU-T Recommendation V.250: "Serial asynchronous automatic dialling and control".
- [6] ITU-T Recommendation V.28: "Electrical characteristics for unbalanced double-current interchange circuits".
- [7] ETSI TS 100 916 (V7.8.0): "Digital cellular telecommunications system (Phase 2+); AT Command set for GSM Mobile Equipment (ME) (3GPP TS 07.07 version 7.8.0 Release 1998)".
- [8] ITU-T Recommendation T.50: "International Reference Alphabet (IRA) (Formerly International Alphabet No. 5 or IA5) - Information technology - 7-bit coded character set for information interchange".
- [9] ETSI TS 127 007 (V3.3.0): "Digital cellular telecommunications system (Phase 2+) (GSM); Universal Mobile Telecommunications System (UMTS); AT command set for 3GPP User Equipment (UE) (3G TS 27.007 version 3.3.0 Release 1999)".

- [10] IETF RFC 1661: "The Point-to-Point Protocol (PPP)".
- [11] IETF RFC 1662: "PPP in HDLC-like Framing".
- [12] ETSI EN 300 392-9: "Terrestrial Trunked Radio (TETRA); Voice plus Data (V+D); Part 9: General requirements for supplementary services".
- [13] ITU-T Recommendation E.164: "The international public telecommunication numbering plan".
- [14] ETSI EN 300 812-3: "Terrestrial Trunked Radio (TETRA); Subscriber Identity Module to Mobile Equipment (SIM-ME) interface; Part 3: Integrated Circuit (IC); Physical, logical and TSIM application characteristics".
- [15] ETSI ES 200 812-2: "Terrestrial Trunked Radio (TETRA); Subscriber Identity Module to Mobile Equipment (TSIM-ME) interface; Part 2: Universal Integrated Circuit Card (UICC); Characteristics of the TSIM application".
- [16] ETSI ETS 300 392-12-7: "Terrestrial Trunked Radio (TETRA); Voice plus Data (V+D); Part 12: Supplementary services stage 3; Sub-part 7: Short Number Addressing (SNA)".
- [17] ETSI EN 300 392-12-16: "Terrestrial Trunked Radio (TETRA); Voice plus Data (V+D); Part 12: Supplementary services stage 3; Sub-part 16: Pre-emptive Priority Call (PPC)".
- [18] ISO 8859-1: "Information technology - 8-bit single-byte coded graphic character sets - Part 1: Latin alphabet No. 1".
- [19] ITU-T Recommendation T.35: "Procedure for the allocation of ITU-T defined codes for non-standard facilities".
- [20] ETSI EN 300 392-7: "Terrestrial Trunked Radio (TETRA); Voice plus Data (V+D); Part 7: Security".
- [21] ETSI EN 300 392-12-8: "Terrestrial Trunked Radio (TETRA); Voice plus Data (V+D); Part 12: Supplementary services stage 3; Sub-part 8: Area Selection (AS)".
- [22] ETSI TS 100 392-2: "Terrestrial Trunked Radio (TETRA); Voice plus Data (V+D); Part 2: Air Interface (AI)".
- [23] ETSI TS 100 392-7: "Terrestrial Trunked Radio (TETRA); Voice plus Data (V+D); Part 7: Security".
- [24] ETSI TS 100 392-15: "Terrestrial Trunked Radio (TETRA) Voice plus Data (V+D); Part 15: TETRA frequency bands, duplex spacings and channel numbering".
- [25] ETSI EN 300 396-3: "Terrestrial Trunked Radio (TETRA); Technical requirements for Direct Mode Operation (DMO); Part 3: Mobile Station to Mobile Station (MS-MS) Air Interface (AI) protocol".
- [26] ETSI EN 300 396-6: "Terrestrial Trunked Radio (TETRA); Direct Mode Operation (DMO); Part 6: Security".
- [27] ITU-T Recommendation V.42bis: "Data compression procedures for data circuit-terminating equipment (DCE) using error correction procedures".
- [28] USB Implementers Forum, Inc: "Universal Serial Bus (USB) Specification, Revision 2.0".

NOTE: Available at: www.usb.org.

- [29] USB Implementers Forum Inc: "On-The-Go Supplement to the USB 2.0 Specification, Revision 1.2".

NOTE: Available at: <http://www.usb.org/home>.

- [30] USB Implementers Forum Inc.: "Wireless Universal Serial Bus Specification, Revision 1.0".

NOTE: Available at: www.usb.org.

[31] WiMedia Alliance: "Multiband OFDM Physical Layer Specification, Revision 1".

NOTE: Available at: <http://www.wimedia.org/en/index.asp>.

[32] Bluetooth Special Interest Group (SIG): "BLUETOOTH SPECIFICATION Version 2.1 + EDR; 26 July 2007".

NOTE: Available at: <https://www.bluetooth.org/apps/content/>.

[33] PCCA STD-101: "Data Transmission Systems and Equipment - Serial Asynchronous Automatic Dialing and Control for Character Mode DCE on Wireless Data Services".

NOTE: Available at: <http://www.pcca.org/standards/standards2.htm>.

2.2 Informative references

The following referenced documents are not essential to the use of the present document but they assist the user with regard to a particular subject area. For non-specific references, the latest version of the referenced document (including any amendments) applies.

[i.1] ETSI EN 300 392-12-10: "Terrestrial Trunked Radio (TETRA); Voice plus Data (V+D); Part 12: Supplementary services stage 3; Sub-part 10: Priority Call (PC)".

[i.2] ETSI TS 100 585 (V7.0.1): "Digital cellular telecommunications system (Phase 2+) (GSM); Use of Data Terminal Equipment - Data Circuit terminating; Equipment (DTE - DCE) interface for Short Message Service (SMS) and Cell Broadcast Service (CBS) (GSM 07.05 version 7.0.1 Release 1998)".

[i.3] ETSI TS 101 356 (V7.2.0): "Digital cellular telecommunications system (Phase 2+); General Packet Radio Service (GPRS); Mobile Station (MS) supporting GPRS (GSM 07.60 version 7.2.0 Release 1998)".

[i.4] ETSI EN 300 396-10: "Terrestrial Trunked Radio (TETRA); Technical requirements for Direct Mode Operation (DMO); Part 10: Managed Direct Mode Operation (M-DMO)".

[i.5] ITU-T Recommendation H.264: "Advanced video coding for generic audiovisual services".

[i.6] ETSI Drafting Rules (EDRs).

NOTE: Available at <http://portal.etsi.org/edithelp/HowToStart/home.htm?page=DraftingRules>.

[i.7] ETSI TR 102 300-5: "Terrestrial Trunked Radio (TETRA); Voice plus Data (V+D); Designers' guide; Part 5: Guidance on numbering and addressing".

[i.8] ETSI EN 301 344: "Digital cellular telecommunications system (Phase 2+) (GSM); General Packet Radio Service (GPRS); Service description; Stage 2 (GSM 03.60)".

3 Symbols and abbreviations

3.1 Symbols

For the purposes of the present document, the following symbols apply:

[...] Optional sub parameter of a command or an optional part of a Mobile Termination (MT) response is enclosed in square brackets

NOTE: Brackets themselves do not appear in the command line.

<...> Name enclosed in angle brackets is a syntactical element

NOTE: Brackets themselves do not appear in the command line.

<CR>	Carriage return character, the value is specified by command S3
<CtrlZ>	Character generated by CTRL and Z keys
<ESC>	Esc character
<LF>	Linefeed character, which value is specified with command S4
<SPACE>	One or more space characters
bold	Bold defined sub parameter value is the recommended default setting of this sub parameter

NOTE: In parameter type commands, this value should be used in factory settings, which are configured by ITU-T Recommendation V.250 [5] command &F0. In action type commands, this value should be used when sub parameter is not given.

3.2 Abbreviations

For the purposes of the present document, the following abbreviations apply:

AI	Air Interface
AP	Access Priority
AS	Area Selection
ASSI	Alias Short Subscriber Identity
AT	ATtention
ATD	ATtention Dial
BS	Base Station
CC	Call Control
CDPD	Cellular Digital Packet Data
CLIR	Calling Line Identification Restriction
CMCE	Circuit Mode Control Entity
CNMI	Command New Message Indication
CTCC	Command TETRA Call Connect
CTS	Clear To Send
CWUSB	Certified Wireless USB
DCD	Data Channel received line signal Detector
DCE	Data Circuit-terminating Equipment
DCK	Derived Cipher Key
DLC	Data Link Connection
DLCI	Data Link Connection Identifier
DLL	Data Link Layer
DMO	Direct Mode Operation
DSR	Data Set Ready
DTE	Data Terminal Equipment
DTMF	Dual Tone Multi Frequency
DTR	Data Terminal Ready
ERM	Error Recovery Mode
ESC	ESCape
GCK	Group Cipher Key
GPS	Global Positioning System
GSM	Global System for Mobile communications
GSSI	Group Short Subscriber Identity
GTSI	Group TETRA Subscriber Identity
IANA	Internet Assigned Numbers Authority
IP	Internet Protocol
IPCP	Internet Protocol Control Protocol
IPv4	Internet Protocol version 4
IPv6	Internet Protocol version 6
IRA	International Reference Alphabet
IT	Information Technology
ITSI	Individual TETRA Subscriber Identity
LA	Location Area
LCP	Link Control Protocol
LLC	Logical Link Control
LSB	Least Significant Bit
MAC	Medium Access Control

MCC	Mobile Country Code
MLE	Mobile Link Entity
MM	Mobility Management
MMI	Man Machine Interface
MNC	Mobile Network Code
MNI	Mobile Network Identity
MS	Mobile Station
MSB	Most Significant Bit
MT	Mobile Termination
MT2	Mobile Termination type 2
MTA	Mobile Terminal Application
PABX	Private Automatic Branch eXchange
PC	Personal Computer
PCCA	Portable Computer and Communications Association
PCON	logical PEI connection
PD	Packet Data
PDP	Pack Data Protocol
PDU	Packet Data Unit
PEI	Peripheral Equipment Interface
PG	Protective Ground
PPP	Point-to-Point Protocol
PSTN	Public Switched Telephone Network
PTT	Push To Talk
QoS	Quality of Service
RD	Received Data
RFC	Request for Further Comment
RFR	Ready For Receiving
RI	Ring Indicator
R _T	TETRA R reference point
RTS	Request To Send
SAP	Service Access Point
SCKN	Static Cipher Key Number
SDL	Specification and Description Language
SDS	Short Data Service
SG	Signal Ground
SIM	Subscriber Identity Module
SMS	Short Message Service
SNA	Short Number Addressing
SNDTCP	SubNetwork Dependant Convergence Protocol
SS	Supplementary Service
SSI	Short Subscriber Identity
STCH	S ^T ealing CHannel
SwMI	Switching and Management Infrastructure
TCH	Traffic CHannel
TD	Transmitted Data
TE	Terminal Equipment
TE2	Terminal Equipment type 2
TECC	Terminal Equipment Call Control
TEI	Terminal Equipment Identity
TEMAC	Terminal Equipment Media Access Control
TEMM	Terminal Equipment Mobility Management
TEMTA	Terminal Equipment Mobile Terminal Application
TESDS	Terminal Equipment Short Data Service
TL	Transport Layer
TLSDS	Transport Layer Short Data Service
TMD-SAP	Trunked Mode D-Service Access Point
TNCC	TETRA Network layer Call Control
TNMM	TETRA Network Mobility Management
TNP1	TETRA Network Protocol type 1
TNP1R	TETRA Network Protocol 1 Relay
TNSDS	TETRA Network layer Short Data Service

TNSS	TETRA Network layer Supplementary Service
TPNI	Talking Party Number Identification
TSI	TETRA Subscriber Identity
UDP	User Datagram Protocol
USB	Universal Serial Bus
USB-OTG	USB On-The-Go
V+D	Voice plus Data

NOTE: V+D corresponds to trunked mode operation.

WAP Wireless Application Protocol

4 Overview of TETRA PEI

4.1 Introduction

The TETRA PEI provides a link between a Data Terminal, TE2, such as a Personal Computer (PC) or specialist data terminal, and a TETRA Mobile Station, MT2 at a reference point R_T. The PEI provides external data devices with access to the services offered by a TETRA network.

The PEI is a dedicated point-to-point link, even for TNP1, which uses wide area addressing. In this issue of the document the PEI shall not be connected to a network.

The radio part of the MT may be operating in trunked mode (V+D) or may be operating in direct mode (DMO). The TE may switch the mode of operation of the MT.

With respect to data services, the TETRA PEI will be used for the following:

- transmission and reception of packet data (including setting of packet data control and QoS parameters) - V+D only;
- transmission and reception of circuit data (including setting of circuit data parameters); and
- transmission and reception of short data (including setting of short data parameters).

In addition to data services the TETRA PEI may be used for the following:

- set-up and control of speech calls (including setting of speech call parameters);
- access to general information of MT2 and network; and
- access to user applications located in MT2.

The TETRA PEI includes components which are not required by all the functions listed above and therefore, depending on the functionality that a MT2 supports, not all aspects of the PEI need to be implemented.

TETRA PEI has been designed to fulfil the following key requirements:

- a standard physical interface, widely adopted in the Information Technology (IT) world;
- minimal extra software in the TE2;
- broad compatibility with other wireless data systems; and
- access to the full range of MT2 functionality (TE applications may use profiles to restrict functionality).

4.2 Protocol architecture

The physical layer for the TETRA PEI is assumed to be a serial form channel. Use of the ITU-T Recommendations V.24 [4] and V.28 [6] type serial interface is defined in the present document in detail due to the widespread use in the computing industry. PEI uses a sub-set of ITU-T Recommendation V.24 [4] interchange circuits. The present document does allow a manufacturer to provide other data interfaces in addition (e.g. infra red and Ethernet) but V.24 is used throughout as the layer 1 definition. Where a modern plug and play style connectivity method is employed (e.g. USB, USB-OTG, CWUSB) more than one logical interface may be presented. Furthermore, V.24 may present as a virtual interface within a TE software execution environment. At least one V.24 serial interface shall be implemented as the primary PEI connection #1.

Figure 4.1 proposes the protocols to be used over the physical interface.

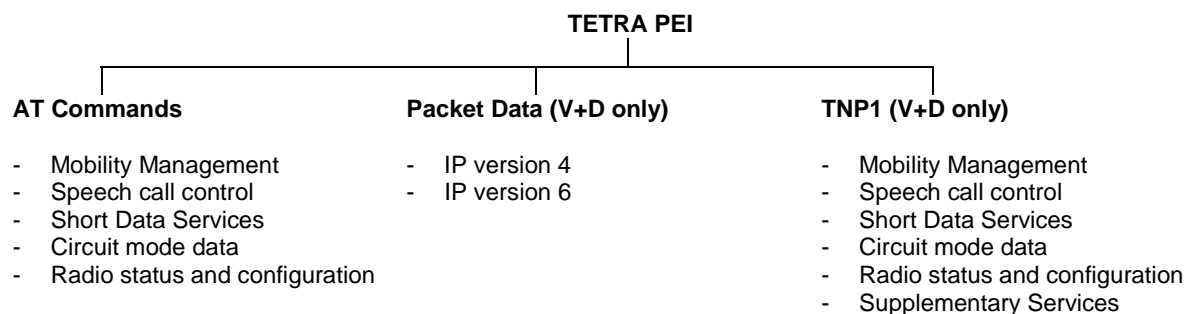

Figure 4.1: PEI Components

These three categories of service access are outlined in detail in the present document. Depending on the services being supported by a MT2, it may not be necessary to support all of these categories. The difference between AT command and TNP1 is that the TNP1 commands can be sent in parallel with ongoing packet data services whereas AT commands can only be sent in the command state.

4.3 Context model

The drawing in figure 4.2 shows the PEI in context with the MT and TE applications, in the case of V+D i.e. trunked mode operation. The present document specifies the signalling at the reference point R_T but the rest of the figure is useful to put the PEI in context with the rest of the TE and MT features. The names given to various SAPs in the figure are either Air Interface definitions taken from EN 300 392-2 [3] or given to the PEI for use throughout this overview. In direct mode, the V+D Air Interface stack components and SAPs are replaced by DMO Air Interface stack components and SAPs as shown in figure 4.3.

NOTE: The circuit mode voice service is never sent over the PEI. Only the call set up, maintenance and clear down signalling for speech calls are sent on the PEI. The actual voice packets go directly from the MT codec to the TMD-SAP or DMD-SAP. This switching is performed according to the "basic service information" element in call set up signalling.

Circuit mode data may be sent over the PEI, note that in TNP1 mode the data may be passed through the TNP1 entity in figure 4.2.

Figure 4.2 illustrates the possibility for the PEI connection to host using more than one logical pipe. Figure 4.2 only represents a single physical PEI connection with many pipes. However, several physical PEI connections may exist. Where multiple PEI connections are implemented, the PEI controlling entity shall manage the routing of control and data, presenting additional logical pipes. These may be physically different circuits but shall be logically represented as additional pipes, as shown in figure 4.2. Figure 4.3 presents only a single pipe, but also DMO interface may support multiple logical pipes as in figure 4.2.

Throughout the present document the aim is to reuse applications that already exist in the MT as a result of other TETRA specifications.

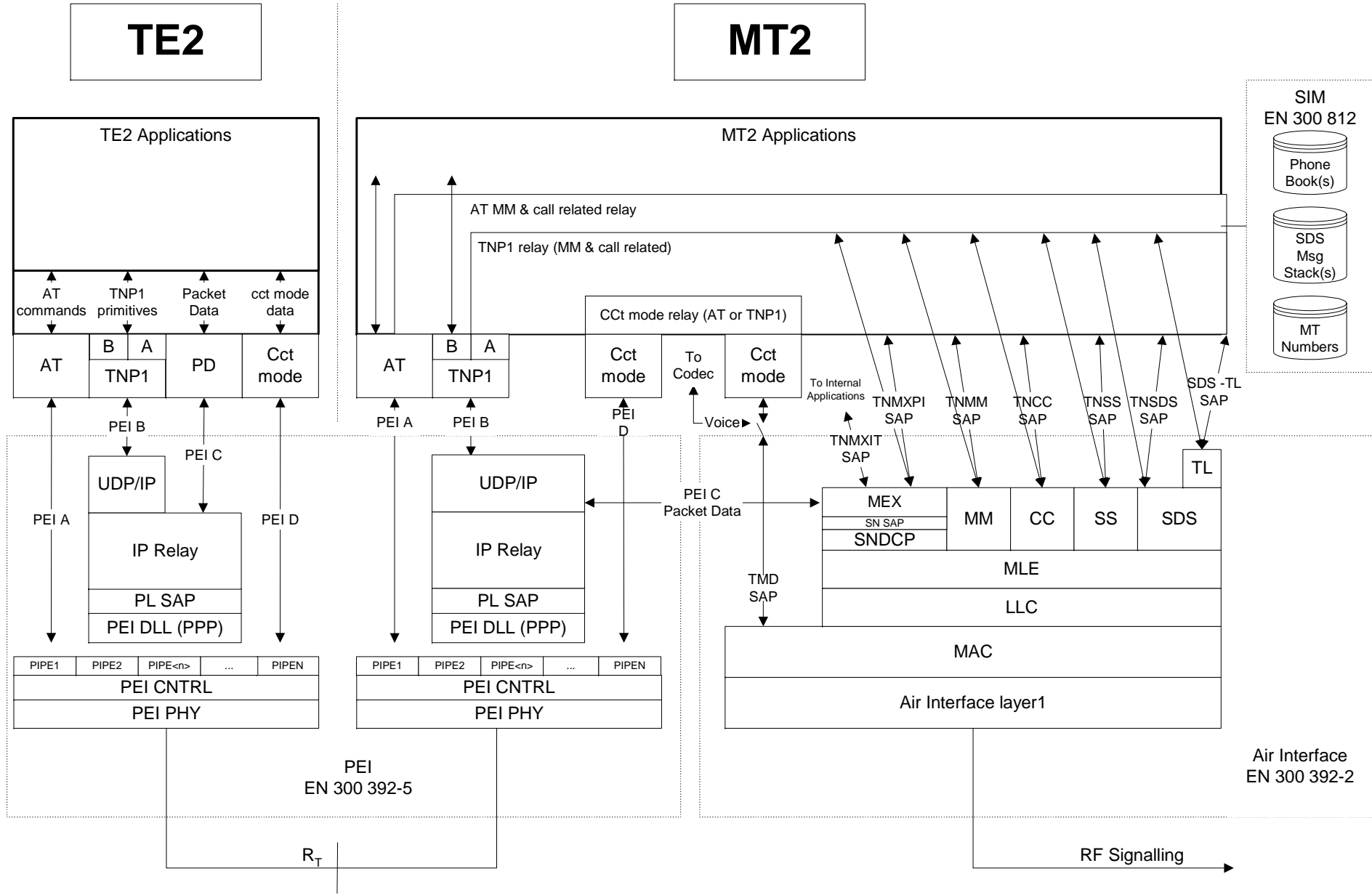

Figure 4.2: PEI Context V+D

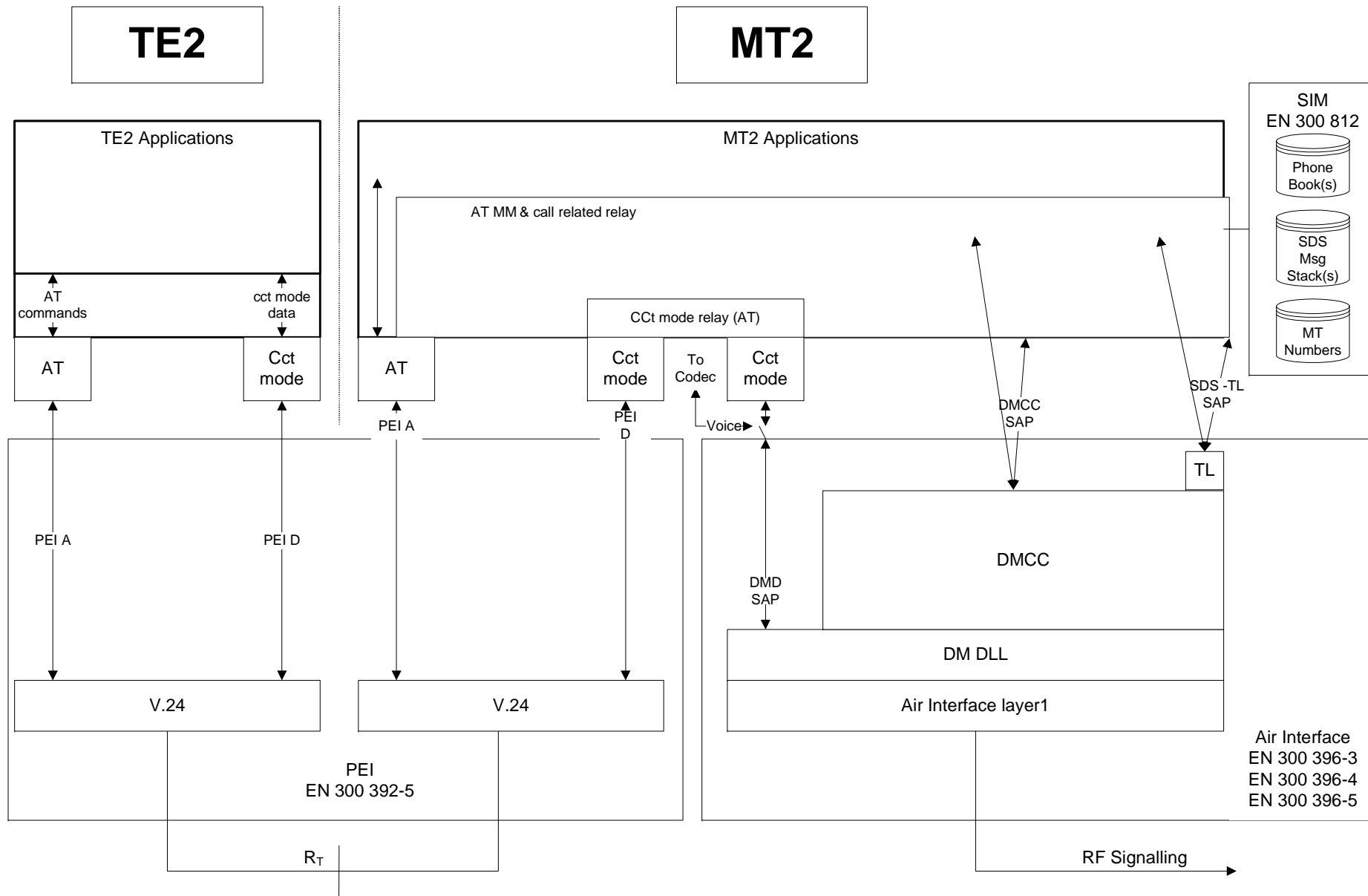

Figure 4.3: PEI Context DMO

4.4 Void

4.5 SDS Message stacks

Incoming and outgoing SDS messages are optionally stored on message stacks in the MT. For the purposes of the present document the SDS message stacks are taken to be those defined in the SIM and TSIM specifications EN 300 812-3 [14] and ES 200 812-2 [15]. The stacks are not necessarily identical to the SIM, as these are typically copied into the MT applications, as the SIM interface is somewhat slow for real time use. The stacks (or their copies) are used by the MT application to remove any link with the air interface for the timing of SDS message sending. In some implementations, they may also be used to store sent and received messages for later review by the MT or TE applications. This feature is particularly useful for the PEI as the TE and MT can synchronize their stacks by using read and write commands on link establishment.

NOTE 1: The behaviour of the SDS message stacks (SIMs) cannot be changed; they are fixed and linear. If a stack indicates it is full then no more messages can be received from the air interface or from the TE for that stack. Implementers should try to delete unneeded messages from the MT stack. Methods for determining the unneeded messages are outside the scope of the present document.

Indication of incoming messages to any stack may be relayed to applications of the MT, or to the PEI, or both. The choice is made by user commands, which set a profile of SDS stack operation. The PEI will use indications, sent to it, to read messages off the stack that are of interest to it (or its application). The TE should take care to read only the number of messages it can handle without memory overflow. This is especially important with SDS type 4 messages as they can contain many bytes each. It is an implementation decision as to when to read any subsequent SDS messages.

A summary of some of the SDS message stacks is given here for convenience so that the AT and TNP1 commands can be put in context, the specifications in EN 300 812-3 [14] and ES 200 812-2 [15] have priority. Commands sent on the PEI can be used to act on the messages in the stacks.

NOTE 2: For reference to all SDS stacks within the MT the TE should track the references given to messages (in the index field) within the MT. When using SDS-TL messaging there is an additional reference within the TL header (message reference), which is also generated within the MT.

The local referencing shall be implemented by exchange of messages at the start of any SDS PEI sequence. To ensure complicity of TE and MT references SDS transactions shall be initiated one at a time and use the returned MT reference for linking further responses. For SDS-TL this field would be the "message reference". For other SDS transactions this would be "SDS instance" for direct messages and the combination of "AI Service" and "Message Index" for messages that use the message stacks.

All stacks have up to 255 entries, each of which is made up of several fields. The fields pertinent to the PEI are briefly explained below.

4.5.1 Status message texts

For each status value that has been provisioned with a text string this stack holds the status value and the programmed string. The text string is coded in the SIMs using the default 8-bit alphabet ISO 8859-1 [18].

4.5.2 SDS 1 message texts

For each SDS1 value that has been provisioned with a text string this stack holds the SDS1 value and the programmed string. The text string is coded in the SIMs using the default 8-bit alphabet ISO 8859-1 [18].

4.5.3 Status and SDS types 1, 2 and 3

Message Index 0 to 65 535, used to identify messages more uniquely than the message pointer (256).

Address Message Destination or Source identifier.

Message Status Message sending and reading status (Received from AI but not read/Received from AI and read/Application originated to be sent/sent).

SDS type Status, SDS type 1 SDS type 2 SDS type 3.

SwMI Time Defined in EN 300 392-2 [3].

User Data Dependant on the SDS type.

NOTE: If the SwMI time is to be used by the TE for outgoing messages it is out of the scope of the present document to define how it is set.

4.5.4 SDS type 4

Message Index 0 to 65 535, used to identify messages more uniquely than the message pointer (256).

Address Message Destination or Source identifier.

Message Status Message sending and reading status (Received from AI but not read/Received from AI and read/ Application originated to be sent/sent).

Protocol ID SDS-TL protocol identifier. Defined in EN 300 392-2 [3].

Message Header If SDS-TL is used this field is the SDS-TL header (message reference, delivery report request, storage, validity period, service selection, forward address (only in case of storage).

SwMI Time Defined in EN 300 392-2 [3].

User Data If SDS-TL protocol is used this field includes the TL header information (e.g. PID and message reference).

NOTE 1: If the SwMI time is to be used by the TE for outgoing messages it is out of the scope of the present document to define how it is set.

NOTE 2: In AT commands for SDS-TL, the data is structured more like the air interface than the SIM definitions. That is the fields for protocol ID and the TL header are part of the use data. The application developer should understand these fields (see clause 4.8).

4.6 Phone books

The phone books are also defined in the SIM definitions in EN 300 812-3 [14] and ES 200 812-2 [15] and the MT may have access to several types of phone book. In particular there are books for PSTN numbers, TETRA numbers, group numbers and last numbers dialled or received.

In the present document TNP1 commands have no access to the phone books. The AT commands have access to a PSTN phone book only, for functionality similar to GSM.

The use of entries in this phone book (e.g. PABX numbers) is outside the scope of the present document.

Future versions of the present document will expand on the access to phone books in the MT.

4.7 Reserved status values considerations

The routing of all status values shall follow profile settings even if they contain reserved values (including the emergency value 0).

4.8 SDS-TL considerations

The SDS Transport Layer protocol is fully defined in EN 300 392-2 [3] and is in fact a layer on top of the standard SDS type 4 messages. This is shown in the context model of figures 4.2 and 4.3. The transport layer protocol elements are contained in a message header and are briefly:

- Protocol Identifier.
- Delivery Report request.
- Service Selection.

- Short Form Report.
- Storage (store and forward via the SwMI or a service centre).
- Validity Period.
- Message Reference.
- Message Reference Handle (applicable to TNP1 only as AT commands can only go "one at a time").
- Forward Addressing (applicable when "storage" is true).

The application developer should understand these features and know that the SDS-TL header elements shall be encoded as part of the user data parameter, both on AT command lines and in TNP1 PDUs.

The "user data" part of a SDS type 4 message includes SDS-TL header information. Some of the header element values and the treatment of the Transport Layer (TL) protocols should be set by the TE and some by the MT.

Only the application in the TE can know what values to put in some of the TL elements (protocol ID, delivery report request, service selection, storage and validity period). This means the TE manufacturer should understand the transport layer of SDS type 4 and be able to fill the relevant fields. The SDS-TL is defined in the TETRA air interface specification EN 300 392-2 [3], clause 29.

On the other hand the MT shall add the message reference to the data, as they are unique for the air interface, indeed SDS messages could be sent via the MT MMI (especially if the TE was not connected). For this reason the "message reference" for any given SDS-TL transfer shall be obtained from the MT.

NOTE: When using TNP1 commands the user application may make use of temporary message references (message reference handle). The AT command set does not use this reference, to keep more compatibility with GSM. The implication is that when using AT commands a second SDS-TL message cannot be sent until the MT has replied with the message identifier.

For store and forward applications there are two sides. The TE application will know if it wants to make use of the store and forward service centre and should indicate this to the MT. The service availability is sent in an Air Interface broadcast from the SwMI. As this may change as the MT roams the MT should forward (at least changes to) this broadcast information to the TE in near real time. The MT may still receive messages it cannot process and may have to look inside SDS-TL headers to confirm valid requests. Both TNP1 and AT commands will have the unsolicited response to carry system broadcast information.

Addressing is especially important for applications that want to send SDS-TL using a store and forward service centre. In this case the called party address field on the AT command line or the TNP1 PDU is that of the service centre. The final address (forward address) of the message is in the user data field. The service centre address can be obtained from the MT using AT or TNP1 commands. For details on addressing for store and forward services refer to EN 300 392-2 [3], clause 29.

The SDS-TL transport layer reports will be independent message exchanges, which are linked at the application layer by the SDS-TL "message reference". Local responses to message sending shall not be used to indicate that the destination user has read the SDS-TL message only that the SDS message has been sent or written to the message stack.

4.9 AT commands

4.9.1 General on AT commands

AT commands are widely used in the IT world as a means of controlling modems from a PC or other intelligent terminal. AT commands have been adopted by many wireless systems as a means for accessing data services (e.g. GSM, CDPD, Mobitex, etc.) and are therefore used as a basis in the TETRA PEI to give access to TETRA services. The TETRA services available using AT commands includes call control, mobility management and SDS, in both V+D and DMO. In V+D also QoS can be controlled using AT commands.

Access to Supplementary Services is not provided in this edition of the present document.

In addition there are commands to access the radio configuration and storage parameters.

Whilst compatibility with existing AT commands is important, it shall be borne in mind that the different services offered, as part of the TETRA specifications, (e.g. half duplex, group addressing, QoS and additional SDS services) will necessarily mean adaptation of the commands as defined in the present document.

The present document also gives AT commands that can be used to set up voice calls.

With reference to figures 4.2 and 4.3 the AT commands use the PEI A interface for commands.

Subsequent data calls will use the PEI D interface for circuit mode data or PEI C interface for packet data. Voice traffic is not carried over the PEI.

In the classical AT commands model, the MT effectively operates in one of two states, namely "Command" state and "On-line data" state. For the PEI this model has been altered slightly. The "On-line data" state is renamed to "AT circuit mode data" and there has been the addition of the "TNP1 or Packet Data" state. The "AT" is added to differentiate these states from any equivalent states entered by TNP1 commands.

The outline state diagram is shown in figure 4.4, if there is a conflict between the diagram and text the textual description takes precedence.

NOTE 1: When the MT or TE is not in "command state" then AT commands are ignored and only hardware or TE or MT escape sequences are recognized.

NOTE 2: The AT Command State Diagram applies to each Data Link Connection in multiplexer mode (see annex F).

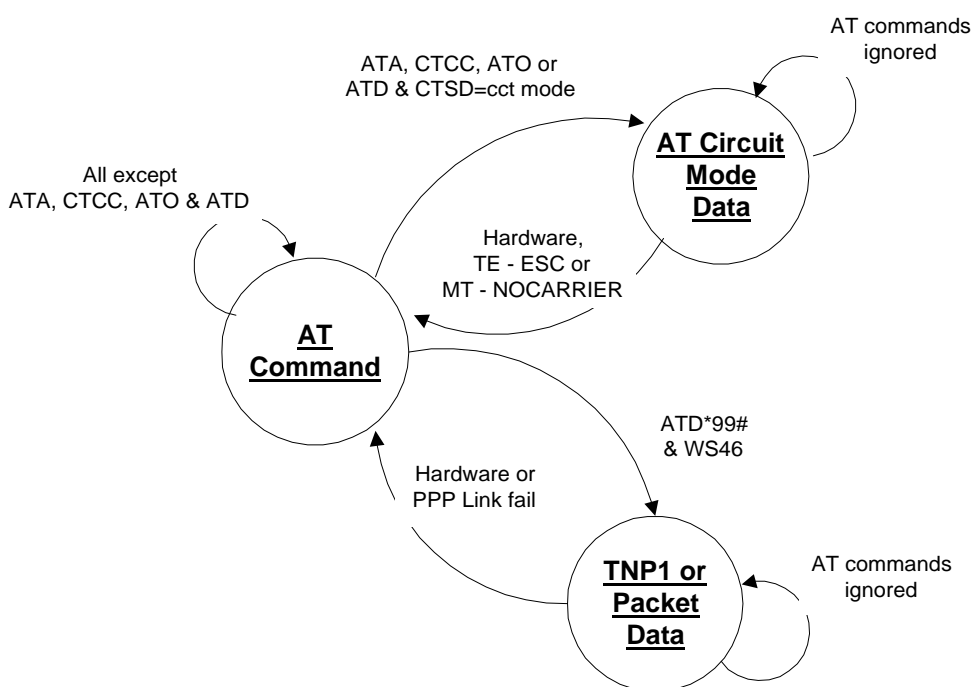

Figure 4.4: AT Command State Diagram

NOTE 3: When using the high speed connection that supports multiple channels (see clause 5.6.1), it is possible to have multiple logical PEI connections ("PCONs") between the TE and MT; the state machine in figure 4.4 applies independently to each logical connection. See clause 8.1.10 for a usage description of multiple PCONs.

In the following clauses, when using the high speed USB connection, V.24 circuits shall be taken to mean the equivalent virtual circuits provided by the USB data link layer.

4.9.2 AT command state

Both TE and MT enter this state on initialization or PEI link establishment (e.g. DTR detection or AT? with OK response). It is always entered from on line data state when any ongoing call is cleared or when the TE sends a recognized Escape sequence.

Signalling received from the TE on logical circuit TD (V.24 circuit 103) is treated as command lines and processed by the MT. The MT command responses and any unsolicited messages are sent to the TE on logical circuit RD (V.24 circuit 104).

With reference to figures 4.2 and 4.3 the signalling is sent on the interface PEI A.

In this state all commands and responses will be accepted and acted on.

This is the state where typically the MT operating modes are set, MM information is received, SDS messages are sent and received and circuit mode calls are established.

Voice call(s) signalling (from the TE or air interface) will lead to a voice call(s) being active in this state.

NOTE 1: It is recommended that any signalling related to the setting up of a circuit mode data call be rejected during a voice call maintenance phase as the TD and RD lines are needed for call maintenance and clear down.

NOTE 2: Voice traffic is not carried over the PEI. This would typically be via a microphone and speaker connected to the MT audio path.

If a voice call is in progress, the MT will monitor the Air Interface for call maintenance and clear down signalling. The MT will also monitor for loss of connection with the other party(s). The MT will pass appropriate voice call maintenance and clear down signalling to the TE. The clear down of a voice call by the other party, the SwMI or loss of RF connection will cause a PEI disconnect signal with the appropriate cause.

The TE will monitor its any MMI actions or other applications and pass appropriate call maintenance and clear down signalling to the MT.

NOTE 3: If the MT has SDS stacks it is recommended the TE synchronize all the stacks using the "list" and "read" commands, or the "write" commands when returning to AT command state.

4.9.3 AT circuit mode data state

A Circuit Mode Data call is in progress whilst in this state.

Signalling received from the TE on logical circuit TD (V.24 circuit 103) is forwarded as data to the appropriate destination (typically the MT U-Plane for transmission over the TETRA AI).

Circuit mode data destined for the TE is forwarded on logical circuit RD (V.24 circuit 104).

TE transmit flow control may be performed by the circuit CTS (V.24 circuit 106).

TE receive flow control may be performed by the circuit RTS (V.24 circuit 105).

NOTE: RS-232 E reuses RTS as Ready For Receiving (RFR) for TE receive flow control.

With reference to figures 4.2 and 4.3 the signalling is sent on the interface PEI D.

The MT will monitor the Air Interface for call maintenance and clear down signalling.

In this state all AT commands are ignored as the signalling is on PEI D and nothing is routed to the AT entity. The TE Escape sequence from the TE or "NO CARRIER" from the MT may be considered as AT commands and are exceptions, as they will be acted upon. AT commands in this sense include indications of SDS messages that can be concurrently accepted by the MT (either directly or via the stacks).

4.9.4 TNP1 and packet data state

A TNP1 or Packet Data session is in progress whilst in this state. The correct destination for signalling in either direction is determined by the UDP/IP addressing.

Signalling received from the TE by the MT is forwarded as data to the appropriate destination (typically the TNP1 relay or via MEX layer for transmission over the TETRA AI). All AT commands are ignored in this state. AT commands in this sense include indications of SDS messages that can be concurrently accepted by the MT (either directly or via the stacks).

Signalling destined for the TE from the MT (TNP1 or packet data) is forwarded on logical circuit RD (V.24 circuit 104).

With reference to figures 4.2 and 4.3 the signalling is sent on the interface PEI B or PEI C.

This state has two sub-states called "local" and "wide". The local sub-state is one where the MT has no context active towards the SwMI. The wide sub-state is one where the MT has a context active towards the SwMI.

4.9.5 Transitions between states

4.9.5.1 Transition from AT command state to AT circuit mode data state

The AT Circuit Mode Data state is entered from AT Command as indicated below:

- 1) To initiate an outgoing circuit mode data call the TE sends a valid ATD command on logical circuit TD, where the previous +CTSDC command had defined the circuit mode data call parameters.
- 2) To accept an incoming circuit mode data call the TE sends a CTCC command on logical circuit TD, where the call set up signalling indicated a circuit mode data call.
- 3) For compatibility with GSM AT commands an incoming call may be answered with the ATA command. If the TE accepts all call parameters (e.g. number of slots) set by the incoming signalling.
- 4) For an ongoing circuit mode data call that has been interrupted by the TE Escape sequence the TE can send the ATO command to resume the interrupted call.

4.9.5.2 Transition from AT circuit mode data state to AT command state

The AT circuit mode data state is always left for AT Command, in one of four ways. The first two are only available if the hardware connection has circuits 108 and 109. Options 3 and 4 are only viable if the MT and TE both support the Hayes improved escape sequence with guard time. If hardware lines are used, the sending of "ESC" or "NOCARRIER" is optional.

- 1) The TE turns circuit 108 off (DTR, behaviour set using "&D" command).
- 2) The MT turns circuit 109 off (DCD, behaviour set using "&C" command).
- 3) The TE sends a complete, special "escape" sequence with timing constrictions (e.g. "<guard delay> +++ <guard delay>") on logical circuit TD.
- 4) The MT sends a special "<guard delay> NO CARRIER <guard delay>" unsolicited response on logical circuit RD.

NOTE: This method is not in any existing standard but is in the "industry standard" Hayes AT User Manual. It should only be used if the hardware circuits are not available.

4.9.5.3 Transition from AT command state to TNP1 or packet data state

The TNP1 or Packet Data state is entered from AT Command, for TNP1 link establishment or outgoing packet data context activation, as indicated below. Note only outgoing packet data context creation is possible:

- 1) The IP addressing to be used (wide or local) is set using the +WS46 command.
- 2) The TE sends ATD*99# on logical circuit TD. After the MT sends "CONNECT" the MT and TE negotiate a PPP link by transmitting LCP datagrams on logical circuits TD and RD. The IP addresses negotiated are determined by the previous +WS46 command according to table 4.2.

4.9.5.4 Transition from TNP1 and packet data state to AT command state

- 1) The TE turns circuit 108 off (DTR, behaviour set using "&D" command).
- 2) The MT turns circuit 109 off (DCD, behaviour set using "&C" command).
- 3) Either the TE or MT in the DLL closes the PPP link.

4.10 TNP1 and IP network layer

4.10.1 General operation

In order to transfer messages over the PEI, TNP1 uses the services of UDP/IP, IP Relay and the PEI DLL. Where V.24 type serial interface is utilized, the DLL used is PPP, which is defined in RFC 1661 [10]. The network layer is established in accordance with RFC 1662 [11]. For additional logical PEI connections, where V.24 is not employed, the DLL shall be as defined in the relevant connectivity standard (e.g. for USB, the relevant USB device class, with appropriate TE driver and use of the IP stack in the MT). The MT should be able to support all options to allow for different TE connections. This issue of the present document does not define a list of required options. Implementers should check for supported options of different suppliers through the MoU processes.

For TNP1 to operate, an IP connection between MT2 and TE2 has to be established. The exact mode of network layer establishment is outside the scope of the present document but is based on the PPP and UDP/IP combination. After receiving an administrative open event from the service user the TNP1 entity, as a kind of IP application, should ask for a socket from the IP service task. From this point the TNP1 entity is ready for service.

The TNP1 signalling is carried via a dedicated UDP port.

The IANA have allocated a well-known port number of 4024/udp for this purpose, which is called tnp1-port.

The context of the network layer and its SAPs in the overall PEI is shown in figure 4.2.

4.10.2 IP addressing

There are two modes of IP operation supported by the PEI. Each mode has different addressing requirements as described below. In total the TE/MT combination needs three different addresses:

- 1) "TE IP". This is a fixed IP address used by all TEs its value is 10.0.0.100.
- 2) "MT IP". This is a fixed IP address used by all MTs its value is 10.0.0.101.
- 3) "MS IP<n>". This is a dynamic address given to the MT by the SwMI on context activation. Where multiple contexts are activated the SwMI may return either a single IP address or a different IP address for each context. Where multiple IP addresses are used the PEI shall use multiple logical connections to the TE to allow the TE to differentiate between different IP subnets offered by the network.

These addresses are used differently in the two modes described below:

- 1) In both modes IP packets from the TE2 to MT2 internal applications have to use the <MT-IP> address.
- 2) The default mode for the MT is "wide".

4.10.3 Local mode

In this mode TNP1 runs over the PEI and is used solely for control of the radio and call processing. AI services are available to TNP1 except packet data transfer. As TNP1 runs over UDP/IP it still needs an IP address at both the TE and MT in order to communicate. The addresses used are the two static addresses "TE IP" and "MT IP". These addresses are set on link establishment. To allow for a connection of equipment (e.g. PC) that does not know the static address the link can be established using dynamic address techniques but the address given is always "TE IP". The MS shall know if the TE wants local (TNP1) operation or wide (packet data transfer, with or without TNP1) to know whether to give "TE IP" or "MS IP". The TE shall use the AT command WS46 to set whether the TE wants a local connection or a wide connection (wide is the default).

The use of source and destination addresses for the different local communications is shown in table 4.1.

Table 4.1: Local mode address use

Comms/Address	TE2->MT2	MT2->TE2	TE2->XXX (note 1)	XXX->TE2 (note 1)	MT2->XXX (note 2)	XXX->MT2 (note 2)
Source Address	TE IP	MT IP	N/A	N/A	N/A	N/A
Destination Address	MT IP	TE IP	N/A	N/A	N/A	N/A
UDP/IP port	TNP1	TNP1	N/A	N/A	N/A	N/A
NOTE 1: These packets will be discarded by the MT.						
NOTE 2: These transactions are not applicable to the PEI.						

4.10.4 Wide mode

In this mode all TNP1 services are available, in addition packet data transfers towards the SwMI are possible. The address used by the TE is that given by the SwMI during context activation and is "MS IP<n>". To go into this mode the TE shall ensure the MT is in wide mode (the AT command WS46) and send the ATD command in order to activate a context towards the SwMI. The SwMI will assign the "MS IP" address, which will be used by the TE for packet data transfer.

The use of source and destination addresses for the different type of communications is shown in table 4.2. In this case the "MS IP" address is represented by XXX. The port numbers used as part of the addressing are labelled YYY and ZZZ.

NOTE: TNP1 messages always use the TNP1 port.

Table 4.2: Wide mode address use

Comms/Address	TE2->MT2	MT2->TE2	TE2->XXX	XXX->TE2	MT2->XXX	XXX->MT2
Source Address	MS IP	MT IP	MS IP	XXX	MS IP	XXX
Destination Address	MT IP	MS IP	XXX	MS IP	XXX	MS IP
UDP/IP port	TNP1	TNP1	YYY	YYY	ZZZ	ZZZ

4.11 TNP1 operation

The TETRA Network Protocol type 1 (TNP1) specifies a protocol to be used over the TETRA PEI designed to allow the TE to have control over the TETRA services. This includes mobility management; call control, QoS, SDS and supplementary services. In addition there are commands to access the radio configuration and storage parameters.

TNP1 itself is based on a connectionless, point-to-point, unreliable Network Layer Protocol.

With reference to figure 4.2 TNP1 commands and circuit mode data are carried over the PEI B interface via two SAPs.

- TNP1A-SAP, for conveying PDUs containing parameters required to invoke CMCE and MM service primitives, and to access circuit mode services of MAC;
- TNP1B-SAP, for communicating with user applications located in MT2.

There shall exist only one instance of TNP1A-SAP and TNP1B-SAP at a given point of time. No service access point identifier (SAPI) is provided, but the PDUs shall be routed to the right SAPs according to their PDU types.

Opening/closing of either of the TNP1A-SAP or TNP1B-SAP at either of the TNP1 peer entities will imply opening/closing of the same SAP at the peer entity.

The general availability of TNP1 services to the service users is defined by the link establishment status of the underlying PEI DLL service and UDP/IP service.

Packet data traffic initiated using TNP1 commands will use the PEI C interface. The differentiation between PEI B and PEI C (packet data) will be made using IP addresses set up at link establishment.

Circuit mode data calls initiated by TNP1 commands will use the PEI B interface and TEMAC-Unitdata packets. Control of the data packet transmission towards the MT may be achieved by using the TEMAC-Flow Control signalling.

NOTE 1: The voice traffic is not carried over the PEI but rather over the MT audio path.

Also shown in figure 4.2 is the MT TNP1 relay. Functions of the TNP1 Relay entity are:

- Transfer service requests between TNP1 entity and CC entity.
- Transfer SDS signalling between the TNP1 entity and either TNSDS SAP, TNSDS-TL SAP or the message stack.
- Transfer service requests between TNP1 entity and MM entity.
- Transfer circuit mode data and flow control indication between TNP1 entity and TMD SAP.

Routing of service requests between MT2 user applications and CMCE and MM entities is outside the scope of the present document. Similarly, rules for decision of which user application, located either in MT2 or ET2, shall handle the service primitives is outside the scope of the present document.

TNP1R is defined in order to clarify the relationship between the TNP1 protocol and MT2 services. The TNP1R-SAP is not intended to be a testable boundary.

NOTE 2: Implementation of any of the TNP1 PDUs is optional.

4.12 Link start up at the MT

Following common industry practice the PEI will always start with a single logical PEI connection in AT mode; with a high rate connection (see clause 5.6) further logical connections can subsequently be requested - see clause 8.1.10. Link establishment can be determined using the hardware signals (DTR, DSR) or by the TE sending "AT?" and receiving an "OK" response.

If the TE wants to use TNP1 it shall issue AT commands to start the UDP/IP link establishment in wide or local mode. For example, to go into wide TNP1 mode these would be WS46 = 14 followed by ATD*99#. The TNP1 link would be established as described in clause 6.8.4.3 negotiating the wide IP address.

NOTE 1: The default is "wide" mode, the WS46 = 14 command is strictly only needed if the local mode was previously selected.

NOTE 2: If the MT has SDS stacks it is recommended the TE synchronize all the stacks using the "list" and "read" commands, or the "write" commands when the PEI link is established.

5 Physical layer

5.1 General on physical layer

Clause 5 recommends the physical layers that should be used between a Terminal Equipment (TE) and a Mobile Termination (MT) at the TETRA reference point R_T. The TE represents a DTE. The MT represents a DCE.

The present document defines physical and protocol criteria related to both V.24/V.28 point-to-point configuration in clause 5.2 and the treatment of high rate, plug and play connectivity methods in clauses 5.3 and 5.4.

The point to point configurations use a sub-set of ITU-T Recommendations V.24 [4] and V.28 [6]. In addition to the electrical level it defines physical connection pin numbers for certain widely used connector types, and the lowest layer transmission format for ITU-T Recommendations V.24 [4] and V.28 [6].

NOTE: The TE and MT should have a minimum requirement of a hardware buffered UART on the serial port, to avoid loss of characters if the software is slow to read the incoming characters.

The physical layers for the high rate plug and play connectivity technologies shall be as defined in those technologies.

5.2 Physical layer for V.24/V.28

5.2.1 Electrical characteristics for V.24/V.28

The electrical characteristics should follow ITU-T Recommendation V.28 [6] for unbalanced signalling. Environments of high electrical noise may force implementers to adopt other electrical characteristics.

5.2.2 Physical connection

The present document does not specify the physical connection to be used at the interface. However, it is recommended that the MT presents a standard or commonly used interface to the TE (e.g. female DB-9 or RJ45). This may be presented via a MT specific cable.

If a D type connector is used, then it may be either a 25-pole or a 9-pole connector (receptacle).

If RJ11/RJ45 type connector is used, then it may be a 10-pole or 8-pole connector.

The pin assignment of the supported sub-set of V.24 signals to 9-pole and 25-pole D type connectors is shown in table 5.1, refer to ITU-T Recommendations V.24 [4] and V.28 [6]. The pin assignment follows current industry recommendations.

Table 5.1: V.24 interface pin assignment for Submin-D type connector

Circuit Number	Signal	Abbreviation	Submin-D type	
			9-pole	25-pole
101	Protective ground	PG	Screen	Screen + 1
102	Signal ground	SG	5	7
103	Transmitted Data	TD	3	2
104	Received Data	RD	2	3
105	Request to Send	RTS	7	4
106	Ready for sending (Clear to Send)	CTS	8	5
107	Data Set Ready	DSR	6	6
108/2	Data Terminal Ready	DTR	4	20
109	Data Channel received line signal Detector	DCD	1	8
125	Ring Indicator	RI	9	22
NOTE 1: The signal RTS may be reused as RFR according to RS-232E.				
NOTE 2: The Ring Indicator signal is not used in this version of the present document. The circuit is reserved for possible future use.				

The pin assignment of a sub-set of V.24 signals to RJ11/RJ45 type connectors is shown in table 5.2. The 8-pole assignments are given in RS-232D.

Table 5.2: V.24 interface pin assignment for RJ11/RJ45 type connector

Circuit Number	Signal	Abbreviation	RJ11/RJ45	
			8-pole	10-pole
101	Protective ground	PG		
102	Signal ground	SG	4	
103	Transmitted Data	TD	6	
104	Received Data	RD	5	
105	Request to Send	RTS	8	
106	Clear to Send	CTS	7	
107	Data Set Ready	DSR	1	
108/2	Data Terminal Ready	DTR	3	
109	Data Channel received line signal Detector	DCD	2	

NOTE: The Ring Indicator signal does not have a pin assigned for the 8-pole RJ11/45 connector.

5.2.3 Character format

To enable fully transparent data transmission an 8-bit character format shall be used by default. In 8-bit format, characters are transmitted asynchronously with 1 start bit and 1 stop bit. No bit is used for parity checking. The 8-bit code is identified by $b_8, b_7, b_6, b_5, b_4, b_3, b_2$ and b_1 , where b_8 is the Most-Significant Bit (MSB) and b_1 is the Least-Significant Bit (LSB). The bit combinations represent integer in the range 0 to 255 where b_8 has a weight of 128 and b_1 has a weight of 1.

The least-significant bit b_1 of the character is transmitted first.

The character format in the asynchronous operation is shown in figure 5.1.

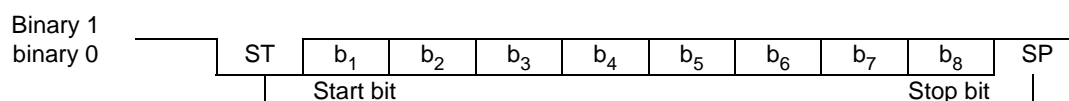
**Figure 5.1: Asynchronous character transmission**

Whilst the default is 8, N, 1 a MT may support other character formats, which a TE2 may select using the AT-command +ICF.

5.2.4 Data transmission rate for V.24/V.28

ITU-T Recommendation V.28 [6] shall apply. This generally defines signalling rates below 20 kbit/s, however under specific conditions described in annex A of ITU-T Recommendation V.28 [6], operation up to 115 kbit/s is possible.

The MT should be able to accept commands initially at 9 600 bit/s, as recommended in ITU-T Recommendation V.250 [5], and optionally be able to automatically detect the baud rate up to 115 kbit/s at the physical layer. Automatic baud rate detection at the establishment of the AT link needs the TE to transmit a sequence of redundant characters (e.g. "AT?") whilst waiting for a valid response (e.g. "OK").

5.3 Wire-line high rate connectivity technologies

5.3.1 General

The inclusion of higher bandwidth modulation schemes in the TETRA standard intends to broaden the spectrum of multimedia services offered to TETRA users. Data rates are comparable to that of 2.5G/3G networks, using high quality, real-time multimedia applications will be feasible in TETRA.

For example, in table 5.3, the average required throughput for real-time video is presented. The video resolution and frame sizes are derived based on ITU-T Recommendation H.264 [i.5]. It is clear that for TETRA2, using older physical link technologies such as V.24/V28 is no longer a feasible option.

Table 5.3: Average throughput for real-time video transmission

Multimedia service	Average throughput (kbit/s)
Real-time video (Resolution/frame)	
128 x 96 / 30,9 176 x 144 / 15,0	64
176 x 144 / 30,3 320 x 240 / 10,0	192

The following clauses describe connectivity standards which can be used for the PEI connection R_T . Note that in all of these cases the PEI DLL, as indicated in figure 4.2, is largely present within a typical implementation of the respective standard.

In all cases the High Rate connectivity standard will allow:

- Multiple Logical Connections - To allow multiple data "pipes" between the TE2 and MT2 or the connection of multiple TE2 to a single MT2.
- Connectivity Link Control - A transparent management of the physical link and logical connections between TE2 and MT2.
- Service Emulation - Where the endpoint of a "pipe" presents itself within the operating system of the TE2 as either a virtual Serial Port or IP Network Interface as appropriate. Note that a Virtual Serial port combined with PPP can also present an IP Network Interface in a similar manner to the use of V.24/V.28 as described above.

The connectivity technologies recommended by the present document in addition to V.24/V.28 include:

- USB Revision 2.0 (USB) [28];
- USB On-The-Go (USB-OTG) [29]; and
- Certified Wireless USB (CWUSB) [30].

Whilst each connectivity technology specifies its own mechanical format, cabling and connectors, these are not considered fully suitable for TETRA applications. Alternative mechanical formats and connectors may be used as appropriate for the intended application provided that equivalent electrical characteristics are maintained in order to safeguard the original intended electrical performance of the connectivity technology.

5.3.2 Universal Serial Bus

Universal Serial Bus (USB) [29] is a connectivity specification developed by several technology industry leaders. USB provides ease of use, expandability, and speed for the end user. USB was designed to improve plug-and-play capabilities by allowing devices to be hot-swapped. When a device is first connected, the host enumerates, recognizes it, and loads the appropriate device driver as required.

A USB system has an asymmetric design, consisting of a host controller and multiple daisy-chained devices. Additional USB hubs may be included in the chain, allowing branching into a tree structure, subject to a limit of 5 levels of branching per controller. No more than 127 devices, including the bus devices, may be connected to a single host controller.

In USB terminology, devices (and hubs) are referred to as functions. These functions have associated pipes (logical channels) which are connections from the host controller to a logical entity on the device endpoint. The pipes are synonymous to byte streams. These endpoints (and their respective pipes) are numbered 0 - 15 in each direction, so a function can have up to 32 active pipes, 16 inward and 16 outward. (The OUT direction shall be interpreted out of the host controller and the IN direction is into the host controller.) Each endpoint can transfer data in one direction only, either into or out of the device/function. Each pipe is uni-directional. Endpoint 0 is however reserved for the bus management in both directions and thus takes up two of the 32 endpoints. In these pipes, data is transferred in packets of varying length. Each pipe has a maximum packet length so a USB packet will often contain something on the order of 8 bytes, 16 bytes, 32 bytes, 64 bytes, 128 bytes, 256 bytes, 512 bytes or 1 024 bytes.

The USB specification provides a 5 V supply and return from which connected USB devices may draw power. Initially a device is only allowed to draw 100 mA. It may request more current from the upstream device in units of 100 mA up to a maximum of 500 mA.

USB 2.0: Key specifications:

- Support for up to 127 devices.
- Hot Plug and Play capability.
- Fully backward compatible with USB 1.0 and 1.1.
- Available in two versions: USB and Hi-Speed USB.
- Transmission speed of 12 Mbps for USB and 480 Mbps for Hi-Speed USB.
- Both isochronous and asynchronous data transfers.
- Cable length of up to 5 meters.
- Built-in power supply/distribution for low-power devices.
- All peripherals run at their highest rated speed instead of the speed of the slowest peripheral.

Where USB is operated without OTG capability, the TE2 shall implement the USB "Host" functionality and the MT2 shall implement the USB "function" functionality.

5.3.3 USB On-The-Go

USB On-The-Go [29] (USB OTG) is a supplement to the USB 2.0 specification that allows USB devices to transfer data directly between themselves.

Standard USB uses client/server architecture: one device acts as a USB "host" and the other as a USB "function". Only the USB host contains the necessary controls to manage the transfer the data. The USB "functions" do not contain such capability, so two USB "functions" cannot exchange the data without the use of a USB host.

USB On-The-Go was developed to overcome that shortfall. With USB On-The-Go, the USB OTG devices are given limited ability to transfer data between themselves. If both are USB OTG, the connecting cable determines which one will initially act as host, and the devices can negotiate to swap roles if needed. USB OTG devices can also connect to plain USB devices from a target peripheral list.

The OTG Supplement addresses the need for mobile interconnectivity by allowing a USB peripheral to have the following enhancements:

- Limited host capability to communicate with selected other USB peripherals.
- Low power features to preserve battery life.

5.4 Wireless high rate connectivity

5.4.1 General

A physical wired PEI can be replaced if desired by a wireless equivalent. There are security and physical connectivity issues associated with this - see clause 5.4.2 concerning security, and an example wireless technology in clauses 5.4.3 and 5.4.4.

5.4.2 Wireless Security

The requirements for, and strength of, wireless security vary from application to application, and may vary from country to country depending on regulatory requirements. Specific recommendations are currently beyond the scope of the present document, although a general recommendation is that the strength of the encryption be at least as good as that utilized on the TETRA air interface in any particular deployment.

5.4.3 Certified Wireless USB

Certified Wireless USB (CWUSB) [30] is defined in order to preserve the functionality of wired USB whilst eliminating the need for the wire.

The Physical Layer of CWUSB is defined to use Ultra Wide Band (UWB) technology as specified by the WiMedia Alliance Physical Layer Specification [31].

Physical Layer Data rates are 53,3 Mbit/s, 80 Mbit/s, 106,7 Mbit/s, 200 Mbit/s, 320 Mbit/s, 400 Mbit/s and 480 Mbit/s with multiple channels.

The majority of logical features of the CWUSB standard are equivalent to the wired counterpart USB. However, particular attention is paid towards security in CWUSB. Whilst security is inherent in the wired nature of USB, the CWUSB attempts to provide an equivalent level of security, but without the wire. This is achieved by specifying a mandatory use of AES-128/CCM using keys which are authenticated by both the host and device (function). Authentication is achieved using 3 072 bit RSA Public Key encryption with SHA-256 for hashing.

Where CWUSB is adopted, the MT2 shall implement as a Wireless USB "Function" and the TE2 shall operate as a Wireless USB "host".

5.4.4 Bluetooth

Bluetooth [32] is a radio standard and communication protocol primarily designed for low power consumption, with a short range based around low-cost transceiver ICs.

Bluetooth systems operate in the unlicensed Industrial-Scientific-Medical (ISM) radio band at 2,4 GHz. Low-power RF transmission provides communication between devices over a range of 10 m to 100 meters. A Bluetooth device playing the role of the "master" can communicate with up to 7 devices playing the role of the "slave". This network of "group of up to 8 devices" (1 master + 7 slaves) is defined as a piconet. Up to 255 further slave devices can be inactive, or parked, which the master device can bring into active status at any time. At any given time, data can be transferred between the master and 1 slave; but the master switches rapidly from slave to slave in a round-robin fashion.

6 AT command set

6.1 General on AT command set

This clause defines a profile of AT commands that may optionally be used in the PEI for controlling MT functions and TETRA network services from a TE. Whilst the whole clause is optional some commands have an "implementation" attribute of mandatory or optional. This attribute is conditional on the AT command set being implemented at all. In any case all the TETRA related commands should be implemented if the AT commands are implemented. Optional commands relate to the setting up of PEI parameters (e.g. S commands).

The terminology in relation to calls is that found in TETRA specifications.

Commands from ITU-T Recommendation V.250 [5] and existing digital cellular standards and TS 100 916 [7] are used whenever applicable.

The command prefixes "+C" for Digital Cellular are reserved as extensions to the basic command set in ITU-T Recommendation V.250 [5]. The present document uses the similar command prefixes and syntax to construct TETRA commands. Some existing commands have been taken as a basis and extended to include TETRA features. Some commands are specific to TETRA and so are new commands but use the "+C" prefix.

These AT commands allow access to voice, SDS, packet data and circuit data services.

6.2 Limitations

The AT implementation has the following limitations:

- Supplementary Services are not supported in the present document.
- The maximum length of a single line will be limited to that of the longest command (SDS-TL).
- AT commands can only be used when the TE and MT are both in the AT command state.
- All addressing digits in the command line are to be IRA characters.
- SDS, MM and MT status commands can be made during a voice call.
- The TE shall wait for a PEI response to an SDS message sending before sending another.

6.3 SDS user data

In AT commands the user data is defined by a combination of two parameters: A "length" parameter and the user data itself. The <length> parameter can be in any position before the <CR><LF> characters. The user data is after the <CR><LF> characters and before either a <CtrlZ> or <ESC> character. There shall no additional space characters between the <CR><LF> and the user data or between the user data and <CtrlZ>.

NOTE 1: The <length> parameter is mandatory and all commas before the <length> parameter are present.

NOTE 2: Although the <CR><LF> could have been used to identify the position of <length> parameter in earlier versions of the present document that is no more possible due to new parameters between the <length> parameter and the <CR><LF>.

NOTE 3: The trailing <CtrlZ> is used in commands, In responses the <CtrlZ> is not present.

The length parameter gives the length of the user data in bits (excluding the <CR>, <LF> and <CtrlZ> characters) represented as ASCII Decimal. Whilst the length parameter is not strictly necessary for all except SDS type 4 it is made mandatory for consistency and MT sanity checking of the other data types (status, SDS types 1 to 3).

The <CtrlZ> character is used to "send" the data; the <ESC> character may be used to cancel the command. The cancel functionality is included to enable cancellation of sending in the event of manual entering of commands, where the operator may have made a typing mistake.

NOTE 4: Cancelling a command by the <ESC> character is possible only after providing characters as defined by the <length> parameter.

The user data itself is represented as ASCII Hex characters. Coding starts at the MS bit; each block of four bits is represented by one character; the characters are presented in the same order as the bits themselves. If the number of bits is not divisible by four, then the least significant bits of the least significant Hex digit shall be packed with "0".

For example, for a data field of "1010 0101 1011 1":

- The length will be "13".
- The user data will be "A5B8".
- The relevant part of a command line to send this data will be 13<CR><LF>A5B8<CtrlZ>.

6.4 AT command syntax

6.4.1 General on AT command syntax

This clause summarizes general aspects on AT commands and issues related to them. For further information see clause 5 of ITU-T Recommendation V.250 [5] and clause 4 of TS 100 916 [7]. In the descriptions that follow, words enclosed in **<angle brackets>** are references to syntactical elements. When they appear in a command line, the brackets are not used. Words enclosed in **[square brackets]** represent optional items; such items may be omitted from the command line at the point where they are specified, and when the items are used the square brackets are not included in the command line. Other characters that appear in syntax descriptions shall appear in the places shown. Refer to clause 6.4.4 for leaving out trailing commas.

6.4.2 Command line

A command line is made up of four elements: the prefix, the operator, the body, and the termination character, the general structure is shown below.

- **<Command line>** = **<prefix><Body><termination character>**.

NOTE: The present document uses the generally used convention in the definition clauses of commands and presents normally only the **<Body>** part of the command line without the "AT" prefix, see clause 6.4.5 for complete examples.

6.4.2.1 Prefix

The command line prefix consists of the characters "AT" or "at". Alternatively, to repeat the execution of the previous command line, the characters "A/" or "a/".

6.4.2.2 Body

The body is made up of individual commands. Space characters are ignored and may be used freely for formatting purposes, unless they are embedded in numeric or string constants. The termination character may not appear in the body. The DCE should be capable of accepting at least 40 characters in the body.

The commands specified in the present document may be part of AT commands from other specifications, modified commands from other specifications or original commands to suit TETRA, the latter cannot be found in existing specifications. This body can have commands of types following those in ITU-T Recommendation V.250 [5] that is basic and extended. The extended commands have a body starting with the character "+".

6.4.2.3 Termination Character

The termination character is defined with the S3 register. The default value is <CR> (IRA 13).

6.4.2.4 Concatenating extended commands

Contrary to ITU-T Recommendation V.250 [5] concatenating extended commands using ";" is optional.

6.4.3 Command Types

AT commands can have up to four different forms, indicated by an operator within the command body, defined below.

- 1) **Execution:** a command that has no parameters will have a body containing no operator at all. The MT will execute the command and any response returned. Some basic commands have no operator but nonetheless perform a "set" operation. Examples are ATA where no parameters are available and &D1 where the "1" is a value equivalent to a "set".
- 2) **Set:** a command body containing the operator "=" is used in two ways. It can either be used to "set" a parameter by storing a value or values for later use. Alternatively it can be used as an execution; that is to invoke a particular function of the equipment together with parameters needed as part of that function.

Examples are `ATS3 = 13` which sets the `S3` parameter to `<CR>` and `+CMGL = <SDS status>` which will read a list of SDS messages.

- 3) **Test:** a command body containing the operator `"=?"` is used to determine if the MT supports the command from the TE. The MT will return `"OK"` if the command is supported. If there are supported parameters associated with this command the range of values will be returned as well.
- 4) **Read:** a command body containing the operator `"?"` will return the value or values of any stored parameters related to that command.

6.4.4 Parameters

Set and read command types have an associated list of parameters, some are mandatory and some are optional. Mandatory and optional parameters shall be treated in order separated by `","` characters before the second and all subsequent parameters. Optional parameters can be omitted if their place is "staked" by the `","`. Optional trailing parameters and optionally their preceding `","` can be omitted completely providing there are no more parameters present, refer to ITU-T Recommendation V.250 [5], clause 5.4.2.3. Any unused or omitted optional parameters shall be set to default values. Refer to clause 6.4.1 for optional parameters presentation.

In multiple line cases the optional trailing parameters and optionally their `","` can be omitted independently on each line.

Optionally in unsolicited multiple line cases the response can be amended by an additional `<CR><LF>` to speed up detection of the end of the unsolicited response.

Contrary to ITU-T Recommendation V.250 [5] in future versions of the present document new parameters may be added to commands and results. TE implementations should allow presence of the new parameters and ignore their values. MT implementations should allow presence of the new parameters and ignore their values, if asked. If there are one or more unknown parameters the receiving entity may return an error result and act as defined in clause 6.4.7.

In some commands with a `<length>` parameter followed by `<CR><LF>` and user data an addition of the new parameters need to be inserted between the `<length>` parameter and the `<CR><LF>`. Optional parameters and their `","` between the `<length>` parameter and the `<CR><LF>` can be omitted completely.

6.4.5 Examples

`ATCMD1<CR>` (basic execution command).

For the purpose of the next examples `AT+CMD3= <parameter1>, <parameter2>, <parameter3>, <parameter4>`, refer to clause 6.4.6.4.

`AT+CMD3=,,15,TETRA<CR>` (extended set command with two leading optional parameters omitted).

`AT+CMD3=2,,,<CR>` (extended set command with three trailing optional parameters omitted).

`AT+CMD3=2<CR>` (extended set command with three trailing optional parameters and related separating commas omitted).

`AT+CMD3? <CR>` (read command to get parameter values).

`AT+CMD3=? <CR>` (test command returns a range of parameters and OK if supported).

6.4.6 Information responses and result codes

6.4.6.1 General on information responses and result codes

The MT responses should follow the definitions in ITU-T Recommendation V.250 [5]. They may be "verbose" or "numeric", as set by the `"V"` command. There are two types of responses that may be issued by the MT: information text and result codes.

Both consist of three parts: a header, text or result, and a trailer. The characters transmitted for the header are determined by a user setting (see the `V` command). In verbose mode the trailer consists of two characters, being the character having the ordinal value of parameter `S3` followed by the character having the ordinal value of parameter `S4`.

NOTE: The responses and result codes don't contain any <prefix> i.e. "AT" at the beginning of a line, see clause 6.4.6.4 for complete examples.

6.4.6.2 Information Responses

Information results have text only after the header. The result text may be transmitted as a number or as a string, depending on a user-selectable setting (see the **V** command).

6.4.6.3 Result Code

There are three types of result codes: final, intermediate, and unsolicited.

A final result code indicates the completion of a full DCE action and a willingness to accept new commands from the DTE. The final result code is either **OK** if the command was recognized and acted upon or **[+CME] ERROR** if the command is not recognized or has invalid parameters.

An intermediate result code is a report of the progress of a DCE action. The **CONNECT** result code is an intermediate result code because it indicates a transition to the online data state. When the DCE moves back to the command state it will then issue a final result code (such as **OK**). Another example is a list of SDS messages from the stack. Not until the **OK** has been sent is the MT able to accept other commands.

Unsolicited result codes indicate the occurrence of an event not directly associated with the issuance of a command from the DTE.

6.4.6.4 Examples

The MT responses for the example commands above could be as shown below. This example shows verbose format but note that non-verbose responses shall be supported. This would change the header and trailer and use numbers instead of text in the result field.

The header and trailer are shown as <CR> and <LF> but they are in fact the contents of S3 and S4.

```
<CR><LF>                                     (header)
+CMD3: 3,0,15,"TETRA" <CR><LF>              (response to AT+CMD3?)
<CR><LF>OK<CR><LF>                           (final result code)
```

```
<CR><LF>                                     (header)
+CMD3: (0-3), (0,1), (0-12,15), ("TETRA", "IRA") <CR><LF> (response to AT+CMD3=?)
<CR><LF>OK<CR><LF>                           (final result code)
```

NOTE 1: ITU-T Recommendation V.250 [5] states in clause 5.7.2 that there is a single space between the colon ":" and the first parameter and no space between the result code name and the colon. That practise seems not to be formally followed in some examples of that document.

NOTE 2: If the result code is an error indication the response could be + CME ERROR: < extended error report code>. Error codes are described in clause 6.17.23.

The MT unsolicited result examples could be as shown below.

```
<CR><LF>                                     (header)
+CMD4: 2,1,7,"IRA" <CR><LF>                 (unsolicited response)
```

A multiline unsolicited result example:

```
<CR><LF>                                     (header)
+CMD5: 2,1,7,"TETRA" <CR><LF>              (unsolicited multiline response, line 1)
+CMD5: 1,0,12,"IRA" <CR><LF>              (unsolicited multiline response, line 2)
<CR><LF>                                     (optional trailer)
```

NOTE 3: No final result code follows an unsolicited result code.

A multiline result example, first line different to the following lines:

<CR><LF>	(header)
+CMD6: "TETRA" <CR><LF>	(response to AT+CMD6?, line 1)
+CMD6: 0, 7,12345 <CR><LF>	(response to AT+CMD6?, line 2)
+CMD6: 2, 7,45321 <CR><LF>	(response to AT+CMD6?, line 2)
<CR><LF>OK<CR><LF>	(final result code)

6.4.7 Handling of unknown parameters

When a command contains one or more unknown parameters the receiving entity may return ERROR or +CME ERROR: <extended error report code>. The <extended error report code> value should be "Unknown parameter" or "Syntax error" depending whether handling of commands containing unknown parameters is supported or not.

When a response to a command with one or more unknown parameters is either ERROR or +CME ERROR: with "Syntax error" or any other reason than "Unknown parameter" excluding "Parameter value out of range", then the responding entity does not support any handling of commands containing unknown parameters, refer to clauses 6.4.6.3, 6.5.2 and 6.16. The requesting entity may try to use test mode or modify the request and re-try.

When a response to a command with one or more unknown parameters is +CME ERROR: with "Unknown parameter", then the responding entity supports handling of commands containing unknown parameters and the requesting entity may use test mode or may set the mode of the handling of unknown parameters by +CMEE. Values "Enable +CME ERROR: <extended error report code> result code, use numeric <extended error report code> values and by-pass unknown parameters" and "Enable +CME ERROR: <extended error report code> result code, use verbose <extended error report code> values and by-pass unknown parameters" shall modify the behaviour of the MT so that unknown parameters do not generate +CME ERROR and are discarded without any action for all commands.

In addition to the +CME ERROR: with "Unknown parameter" value MT may send +CME PARAMETER unsolicited result indicating the location of the unknown parameter as a "parameter number", refer to clause 6.16.4.

If the MT does not understand the values of known parameters in the +CMEE command, then it should return ERROR or +CME ERROR with "Parameter value out of range".

NOTE 1: MT may use extended error report code value "Unknown parameter" only when it supports the handling of commands containing unknown parameters, otherwise the extended error report code value "Syntax error" is appropriate.

NOTE 2: The +CME ERROR: parameter <extended error report code> may be presented as a numeric or verbose value, refer to 6.17.22.

TE shall accept presence of new parameters and should ignore them.

6.5 Existing V.250 commands for call control

6.5.1 Commands

Table 6.1 summarizes commands from ITU-T Recommendation V.250 [5] relating to the control of call set up and control.

Those in the table are applicable to the PEI and are used as specified in ITU-T Recommendation V.250 [5]. All others will be ignored.

Table 6.1: ITU-T Recommendation V.250 [5] commands relating to call control

Command	Implementation	Comments
A	Optional	Answers a call
D [<dial string>]	Mandatory	Originates a call
H [<value>]	Optional	Hangs up a voice call
O	Optional	Changes state to on line data
NOTE 1: The ATA command is only suitable where there are no changes to the parameters set by the incoming call set up signalling.		
NOTE 2: The ATD command may not have a dial string, particularly for packet data session initiation.		

6.5.2 Result Codes

Note the result codes for the existing AT "D" and "A" commands may differ from those specified in ITU-T Recommendation V.250 [5]. In particular the TETRA result codes will be used to indicate the progress of an outgoing call, as the number of parameters is completely different from those envisaged in ITU-T Recommendation V.250 [5]. In some special cases the standard final result codes are allowed, these are indicated in table 6.2. All other cases should use the TETRA related commands.

Table 6.2: ITU-T Recommendation V.250 [5] results relating to call control

Result Code	Comments
BUSY	Engaged signal detected
CONNECT <text>	Issued if the call is connected with no change to call parameters. <text> is manufacturer specific and may include line speed, data compression, etc.
ERROR	Command line not recognized or illegal parameters
NO CARRIER	Issued as a result for ATD if the MT is out of coverage
NO DIAL TONE	MT is out of service (e. g. coverage)
OK	Command successfully executed

6.5.3 Dialed string and user identity

The allowed digits associated with the "D" command are:

- "0 1 2 3 4 5 6 7 8 9 * # +". Implementation of these characters is mandatory for TETRA.

The address type can be changed by the +CTSDC or +CTSDS commands. For details of numbering see the latest version of TR 102 300-5 [i.7].

The SNA shall contain 1 to 3 decimal digits.

The SSI shall contain 1 to 8 decimal digits. Any leading zeros of the SSI shall be suppressed.

The TSI shall contain 8 to 15 decimal digits. The most significant 3 digits represent the Mobile Country Code (MCC) in the range 0 to 999, the next 4 digits represent the Mobile Network Code (MNC) in the range 0 to 9 999 and when the calling/called party identity is defined the last 1 to 8 digits represent the Short Subscriber Identity part (SSI). Leading zeroes shall be present in the MCC and MNC parts and leading zeros of the SSI may be suppressed.

When TSI is used with the "num type" parameter, then the length of the SSI part in a TSI shall be at least 2 digits with an additional leading zero to make the length of the TSI to be at least 9 digits to differentiate it from an SSI.

The external subscriber number shall be a number as defined in ITU-T Recommendation E.164 [13].

The extended TSI is provided to support addresses that can not be presented using the above methods, The extended TSI shall contain decimal digits, The most significant 4 digits represent the Mobile Country Code (MCC) in the range 0 to 1 023, the next 5 digits represent the Mobile Network Code (MNC) in the range 0 to 16 383 and the last 8 digits represent the Short Subscriber Identity part (SSI) in the range 0 to 16 777 215. Leading zeroes shall be present in all parts i.e. the length of the extended TSI shall be 17 digits.

NOTE 1: At present the "open MNI" used in TETRA DMO is the main usage of the extended TSI.

NOTE 2: The extended TSI can be used instead of TSI, but its usage should be considered carefully due to backwards compatibility concerns.

6.6 Existing V.250 commands for PEI control

Table 6.3 summarizes commands from ITU-T Recommendation V.250 [5] relating to the formatting of commands and responses as well as the PEI hardware interface operation.

Those in the table 6.3 are applicable to the PEI and are used as specified in ITU-T Recommendation V.250 [5]. All others will be rejected.

Table 6.3: ITU-T Recommendation V.250 [5] commands relating to TETRA PEI

Command	Implementation	Comments
S0=[<value>]	Optional	Sets the number of call indications (rings) when the MT will automatically answer the call. Zero disables automatic answering and is the default.
S3=[<value>]	Mandatory	Command line termination character (mandatory default setting IRA 13 <cr>).
S4=[<value>]	Mandatory	Response formatting character (recommended default IRA 10 <lf>).
S5=[<value>]	Mandatory	Command line editing character (recommended default IRA 8 <backspace>).
E[<value>]	Mandatory	Command echo (recommended default 1 i.e. MT echoes commands back).
Q[<value>]	Mandatory	Result code suppression (recommended default 0 i.e. MT transmits result codes).
V[<value>]	Mandatory	MT response format (recommended default 1 i.e. verbose format).
X[<value>]	Optional	Defines CONNECT result code format; any added text (values 1 to 3) is manufacturer specific.
&C[<value>]	Optional	Determines how logical circuit 109 - Data Channel received line signal Detector (DCD) relates to the detection of received line signal from remote end (recommended default 1 i.e. logical circuit RLSD operation relates to detection of received signal) (see note).
&D[<value>]	Optional	Determines how MT responds when logical circuit 108/2 Data Terminal Ready (DTR) is changed from ON to OFF condition during either packet or circuit mode data state (recommended default 2 i.e. change causes MT to disconnect the call, return to command mode and return the result "OK") (see note).
+IFC=[<by_te> [,<by_ta>]]	Optional	TE-MT local flow control (recommended default 2,2 i.e. TE uses RTS (circuit 105) and MT uses CTS (circuit 106)).
+IPR=[<value>]	Optional	Sets a fixed PEI data rate if Auto baud rate detection is not supported (recommended default 0, i.e. automatic detection).
+ICF=[<format>[,<parity>]]	Optional	PEI character framing (recommended default 3,3, i.e. eight data bits, no parity, 1 stop bit).
NOTE: This command is not supported if the PEI uses a 4-pin connector.		

6.7 Existing V.250 commands for generic MT control

Table 6.4 summarizes commands from ITU-T Recommendation V.250 [5] relating to generic MT control.

Those in the table 6.4 are applicable to the PEI and are used as specified in ITU-T Recommendation V.250 [5]. All others will be rejected.

Table 6.4: ITU-T Recommendation V.250 [5] generic MT control commands

Command	Implementation	Comments
Z	Mandatory	MT sets all parameters to their defaults as specified by a user memory profile or by the manufacturer . This applies to the PEI communication parameters, S-registers and the service profiles. This command does not reboot the MT. For rebooting refer to clause 6.14.12.
&F	Mandatory	MT sets all parameters to their defaults as specified by the manufacturer.
I	Optional	Request manufacturer specific information about the MT.
+GMI	Mandatory	Request MT manufacturer identification.
+GMM	Mandatory	Request MT model identification.
+GMR	Mandatory	Request MT revision identification.
+GSN	Optional	Request MT serial number identification.
+GCI	Optional	Selects the country of installation for the MT using ITU-T Recommendation T.35 [19], annex A country codes.

6.8 Existing Hayes AT commands for PEI control

Table 6.5 summarizes commands from the Hayes AT user manual.

Those in the table 9 are applicable to the PEI. All others will be rejected.

Table 6.5: Hayes AT commands related to PEI

Command	Implementation	Comments
S2=[<value>]	Optional	Escape character (default setting IRA 43 <+>).
S12=[<value>]	Optional	Escape guard time (default 1 s).

6.9 Existing GSM commands for MT control

Table 6.6 summarizes commands from TS 100 916 [7] relating to MT control.

Those in the table 6.6 are applicable to the PEI and shall be used as specified in TS 100 916 [7] and TS 127 007 [9]. All others should be rejected.

Table 6.6: +Cellular commands related to PEI

Command	Implementation	Comments
+CBC	Optional	Informs the TE on the battery charger connection state <bcs> and the battery charge level <bcl> of the MT battery.
+CEER	Optional	Causes the MT to return one or more lines of information text on the reason for the failure in the last unsuccessful call set-up, call modification, or the reason for the last call release based on the information provided by the TETRA network.
+CSCS=[<chset>]	Optional	Informs the MT which character set (<chset>) is to be used by the TE. Default is International Reference Alphabet (ITU-T Recommendation T.50 [8]). Implementers should note that when the PEI has been configured for 8-bit framing at the physical layer and a 7 bit alphabet has been selected, then the MSB shall be set to 0. If 7 bits framing is used at the physical layer and 8-bits alpha-bet has been configured, errors will occur.
+CPAS	Optional	Returns the activity status <pas> of the MT.
+CSQ	Optional	Returns the received signal strength indication <rss> and the channel bit error ration <ber> from the MT.

6.10 Modified PCCA wireless extended commands

Table 6.7 summarizes commands from PCCA STD-101 [33] relating to MT control. The WS45 command sets the PEI side stack. The WS 46 command is used to set the UDP/IP link into the correct mode for TNP1 or IP packet data transfer (local or wide). The modifications relate to values of the parameters <m> <n>. WS45 only has the allowed value of "4" whilst WS46 needs two new parameters allocated by the PCCA.

In the case where a MT supports neither packet data nor TNP1 these commands will not be supported.

Table 6.7: +PCCA commands related to PEI

Command	Implementation	Comments
+WS45=<m>	Optional	Used to select the stack on the PEI. For this edition the only valid value of <m> is 4 (PPP datagram encapsulation).
+WS46=<n>	Optional	Used to select the Wireless Data Service (WDS) to be used by the MT.

For the TETRA PEI valid values of <n> will be:

- 14 **MS wide Data Service (existing value in PCCA STD-101 [33] for TDMA Digital Cellular).**
- 252 MT2 Local Data Service.
- 253 reserved.

NOTE: The two new values of <n> will be requested from the PCCA for TETRA.

6.11 Modified Cellular commands for MT control

6.11.1 General on cellular commands for MT control

This set of commands is modified GSM commands. They are defined in full, as existing specifications do not meet TETRA requirements.

The defined values for the parameters in these TETRA commands are collected in clause 6.17.

All commands can have normal or extended error reporting as described in clause 6.16.

6.11.2 MT Capabilities +GCAP

6.11.2.1 General on +GCAP

This command is an extension of the +GCAP command in the cellular set. The command operates in test and read modes. The changes are that the different services and MS capabilities related to TETRA are added to the response. The services and MS capabilities reported are those of the current primary operating mode, V+D or DMO.

Implementation of this command is optional.

6.11.2.2 Description

The read command returns the mandatory field "TETRA", the class of MS and a list of TETRA services that are supported by the MT connected on the PEI. Each service is defined as two "layers" and shall be on a new line.

NOTE: The PID is only used in conjunction with "service layer1" = SDS-TL.

6.11.2.3 GCAP Read and Unsolicited Result Code Text

+GCAP: TETRA , [<class of MS>], [<stack present>] <CR><LF>
 [<service layer1>], [<service layer2>] <CR><LF>

NOTE: The services "voice" and "circuit mode data" are contained within the <class of MS> element and need not be repeated in this response.

6.11.3 Network registration +CREG

6.11.3.1 General on +CREG

This command is an extension of the +CREG command in the cellular set. The command operates in test, set and read modes. The changes are in the response format. GSM has different location area definitions.

Implementation of this command is mandatory.

6.11.3.2 CREG Set Syntax

+CREG=<Reg unsolic>

6.11.3.3 Description

The set command controls the sending of an unsolicited result code by the value of <Reg unsolic>, typically reported when there is a change in the MT network registration status or location area.

6.11.3.4 CREG Read and Unsolicited Result Code Text

+CREG: <Reg stat>, [<LA>], [<MNI>]

6.11.4 Get MT TETRA identities +CNUM

6.11.4.1 General on +CNUM

This command is an extension of the +CNUM command in the cellular set. The command can only operate in test and read modes. The difference from GSM is that GSM specific parameters of speed, service and information transfer capability do not apply. In addition TETRA has different types of number, different values and the numbers themselves have different formats.

Either this command or set of commands in clause 6.11.5 is mandatory.

6.11.4.2 Description

The response to this command returns the TETRA subscriber identity number(s) programmed in the MT that are applicable to the current primary operating mode, V+D or DMO. If there is more than one number stored in the MT (e.g. groups and gateways) then each number will be returned on a separate line. There will always be an individual number returned but additional addresses such as groups will vary. Note the variable used for the identity is "called party identity". The "num type" variable is different from the "called party identity type" as it can distinguish groups, PABX/PSTN gateways and external subscriber numbers. The identity returned will be linked to the type of number defined by "num type".

6.11.4.3 CNUM Read Result Code Text

+CNUM: <num type>, <called party identity>, [<alpha>]<CR><LF>

[<num type>, <called party identity>, [<alpha>]<CR><LF>]

NOTE: The <CR><LF> on the last may be followed directly by the "OK".

6.11.5 Get MT TETRA Identities (alternative commands)

6.11.5.1 Get MT TETRA Fixed identity number(s): ITSI, and Gateway address(es) +CNUMF

6.11.5.1.1 General on +CNUMF

This command can only operate in test and read mode.

Implementation of this command is optional, if +CNUM is implemented, otherwise mandatory.

6.11.5.1.2 Description

The response to this command returns the TETRA Fixed identity number(s) programmed in the MT. There will always be an individual number (i.e. ITSI) returned as first identity, additional gateway address(es) (i.e. PSTN or PABX), and External Address(es).

The returned list cannot change, and so it may be requested once (at power up).

6.11.5.1.3 CNUMF Read Result Code Text

+CNUMF: <num type>, <called party identity>,[<alpha>]<CR><LF>

[<num type>, <called party identity>, [<alpha>]<CR><LF>]

NOTE: The <CR><LF> on the last may be followed directly by the "OK".

6.11.5.2 Get MT static group identities +CNUMS

6.11.5.2.1 General on +CNUMS

This command can operate in test, set and read mode.

Implementation of this command is optional, if +CNUM is implemented, otherwise mandatory.

6.11.5.2.2 Description

The response to this command returns the list of unique TETRA static group identities programmed in the MT that are currently available for "attachment" or the number of groups in this list.

The TE can request the total number of available groups, the total list of available groups, as well as asking for a specific range of them (from lower to upper range values).

If the lower and upper range limits are not set, the MT shall only return the total number of available static groups. In case the lower and upper range limits are set, the MT shall only return the list of available static groups.

When the values for lower and upper range limits are set to 1 and 4 096, the full set of static groups is returned by MT.

The list of identities returned will not contain repeats of an identity, i.e. all identities provided will be unique.

A response providing an empty string shall indicate there are no identities in the requested range (and there are no identities at any higher range).

The static group is list will change very rarely (only at migration between networks) and it can be requested at these occasions. Alternatively, the "unsolicited report" mechanism may be supported to ensure the TE does not request again the group list when it is not necessary to do so.

The available groups can change when a TE changes from V+D to DMO mode (and vice versa).

6.11.5.2.3 CNUMS Set Syntax

+CNUMS=<ident unsolic>, [<lower range limit>], [<upper range limit>]

NOTE: For a proper construction both <lower range limit> and <upper range limit> parameters are present or neither of those.

6.11.5.2.4 CNUMS Read and Unsolicited Result Code Text

+CNUMS: [<number of groups><CR><LF>]

[<num type>, <called party identity>, [<alpha>]<CR><LF>]

NOTE: In a read result code the <CR><LF> on the last may be followed directly by the "OK".

6.11.5.3 Get MT dynamic group identities +CNUMD

6.11.5.3.1 General on + CNUMD

This command can operate in test, set and read mode.

Implementation of this command is optional, if +CNUM is implemented, otherwise mandatory.

6.11.5.3.2 Description

The response to this command returns the list of unique TETRA dynamic group identities programmed in the MT or the number of groups in this list.

The new command for the DGNA groups allows the TE to request the number of available dynamic groups, the full set of currently assigned DGNA groups or as well as asks for a specific range of them.

If the lower and upper range limits are not set, the MT shall only return the total number of available dynamic groups. In case the lower and upper range limits are set, the MT shall only return the list of available dynamic groups.

When the values for lower and upper range limits are set to 1 and 4 096, the full set of DGNA assigned groups is returned by MT.

The list of identities returned will not contain repeats of an identity i.e. all identities provided will be unique.

A response providing an empty string shall indicate there are no identities in the requested range (and there are no identities at any higher range).

Differently from the static group list, this list can change more often (the assignments are altered by the SwMI), and therefore it is recommended that the "unsolicited report" mechanism is supported, ensuring that the TE is kept up-to-date of a change in the dynamic group list.

6.11.5.3.3 CNUMD Set Syntax

+CNUMD=<ident unsolic>, [<lower range limit>], [<upper range limit>]

NOTE: For a proper construction both <lower range limit> and <upper range limit> parameters are present or neither of those.

6.11.5.3.4 CNUMD Read and Unsolicited Result Code Text

+CNUMD:[<number of groups><CR><LF>]

[<num type>, <called party identity>, [<alpha>] <CR><LF>]

NOTE: In a read result code the <CR><LF> on the last may be followed directly by the "OK".

6.12 Modified GSM SDS message stack commands

6.12.1 General on Modified GSM SDS message stack commands

The commands for use with the TETRA SDS are based on those used in the GSM Short Message Service (SMS) TS 100 585 [i.2]. Fields and their contents cannot be identical but the same command names are used to ease understanding by GSM application developers. The GSM standard has different modes of operation for SMS message handling (block, PDU and text), these are for backward compatibility within GSM and as such are not applicable to TETRA. There is also a difference in the storage between GSM and TETRA. TETRA SDS message storage is based on the SDS services, whilst GSM has "preferred storage". For these reasons the contents of GSM and TETRA commands are necessarily different.

In order to support all values of all information elements and user data types a TETRA special mixed mode is used in which parameters are conveyed in text and the user data part is conveyed in HEX string. The HEX string is preceded by a length parameter and the command is initiated by a <CtrlZ> or cancelled by a <ESC>.

The defined values for the parameters in these TETRA commands are collected in clause 6.17.

All commands can have normal or extended error reporting as described in clause 6.16.

All new incoming SDS messages onto any of the SDS stacks are indicated to the TE by the +CMTI command.

NOTE: Throughout this clause the <AI service> variable is used but only the values 9 thru 13 are valid for SDS services.

6.12.2 Delete message +CMGD

6.12.2.1 General on +CMGD

This command is based on the GSM command. The difference is that the TETRA command has to define the stack and has no field to define the type of deletion. The command operates in test and set modes.

Implementation of this command is optional.

6.12.2.2 CMGD Set Syntax

+CMGD=<AI service>,[<message index>], [<message index>]

6.12.2.3 Description

The set command deletes the message from the message stack <AI service> at all given storage locations <message index>. If no index is given then all messages of the defined SDS type will be deleted.

6.12.3 List messages +CMGL

6.12.3.1 General on +CMGL

This command is based on the GSM list command. The difference is that the TETRA command has only one mode of operation and thus there is only one set of fields and their contents. The field definition and contents will differ from those found in GSM. The TETRA mode of operation is similar to that of GSM text and SMS status mode where only the index to the data is returned. The data message itself is retrieved using a CMGR command.

The command operates in test and set modes.

Implementation of this command is optional.

6.12.3.2 CMGL Set Syntax

+CMGL=<AI service>, [<SDS status>]

6.12.3.3 Description

The set command returns a list of messages stored in the MT message stack. Defined by <AI service>.

NOTE: The <AI service> variable is used but only the values 9 thru 13 are valid for SDS services.

If <SDS status> is present then only indices to messages with status value <SDS status> are returned. If not then all active message indices of SDS type defined by <AI service> are returned.

The result code text contains details of any messages in the stack that meet the set criteria.

The read message command +CMGR is used in conjunction with the <message index> to return the actual data.

6.12.3.4 CMGL Set Result Code Text

+CMGL: <AI service>, <message index>, <SDS status>, [<calling party identity>], [<calling party identity type>], [<called party identity>], [<called party identity type>]

NOTE 1: The presence of optional parameters depends on whether the message is MT originating or terminating.

For outgoing messages <calling party identity> and <calling party identity type> are not present, <called party identity> is mandatory and <calling party identity type> is optional.

For incoming messages <calling party identity> is optional although should always be included, <calling party identity type> is optional, <called party identity> is mandatory and <called party identity type> value is "TSI" due to air interface definitions.

NOTE 2: The "identity" is always paired with a "type". "Type" parameter value "PABX external subscriber number" or "PSTN external subscriber number" without "identity" parameter value can be used to indicate that an external subscriber number is not available.

6.12.4 Read message +CMGR

6.12.4.1 General on +CMGR

This command is based on the GSM command. The difference is that the TETRA command has to define the stack and can optionally read more than one SDS message. The command operates in test, set and unsolicited read modes.

Implementation of this command is optional.

6.12.4.2 CMGR Set Syntax

+CMGR=<AI service>, [<message index>], [<message index>]

6.12.4.3 Description

The set command reads the message from the message stack <AI service> at all given storage locations <message index>. If no message index is given then all messages of the defined SDS type will be read.

If <AI service> is "status" or SDS type 1 then the TE may associate the value read with a text string downloaded from the MT previously with a "CSTR" command. This is an application issue for implementers.

If the status of the message was "received unread" then it automatically changes to "received read" on the stack.

NOTE: The unsolicited result code may be used to inform the TE of any change in status of an outgoing message.

6.12.4.4 CMGR Set and unsolicited Result Codes

The set result is used to return data of the defined SDS type. The unsolicited result is used to inform the TE of a change in the SDS status parameter due to air interface lower layer sending reports, or if the stack has become full with incoming or MT originated messages.

+CMGR: <AI service>, <message index>, <SDS status>, <stack full>, [<calling party identity>], [<calling party identity type>], [<called party identity>], [<called party identity type>], [<area>], [<SwMI time>], <length><CR><LF>user data

NOTE 1: The presence of optional parameters in a set result code depends on whether the message is MT originating or terminating. The unsolicited result code will only have the first four parameters.

For outgoing messages <calling party identity> and <calling party identity type> are not present, <called party> is mandatory and <calling party identity type> is optional.

For incoming messages <calling party identity> is optional although should always be included, <calling party identity type> is optional, <called party identity> is mandatory and <called party identity type> value is "TSI" due to air interface definitions.

NOTE 2: The "type" parameter value "PABX external subscriber number" or "PSTN external subscriber number" without "identity" parameter value can be used to indicate that external subscriber number is not available.

NOTE 3: If the unsolicited result code indicates <stack full> the message index and SDS status fields will be set to those of the highest message index.

NOTE 4: If more than one index is defined in the set command, each message is retrieved in a separate result code.

6.12.5 Write message +CMGW

6.12.5.1 General on +CMGW

This command is based on the GSM command. The difference is that the TETRA command has to define the stack and does not operate in "text mode". The command operates in test set and unsolicited read modes.

Implementation of this command is optional.

6.12.5.2 CMGW Set Syntax

+CMGW = <called party identity>, <length><CR><LF>user data<CtrlZ>

6.12.5.3 Description

The set command writes the message to the message stack <AI service>. The <called party identity type> is preset in the current CTSDS command.

The result code informs the TE of where the message was written or if the stack is full. In TETRA this write message is used in conjunction with (after) a CTSDS command which presets some of the parameters needed for a message write.

NOTE: IF the SDS-TL protocol AND "store and forward" is used the called party identity will be an SDS service centre address (SwMI or external service centre). The message destination address (forward address) is inside the user data.

The message is not sent on the air interface automatically by the MT. The CMSS command shall be used to send the message on the air interface using the current settings of +CTSDS. The CMSS command uses the "AI service" and "message index" to reference the message. When transmitted on the air interface the SDS status automatically changes to "sent" on the stack.

6.12.5.4 CMGW Set Result Codes

The set result code is used to inform the TE of the index where the message was written.

+CMGW: <AI service>, <message index>, [<stack full>]

If the result code indicates <stack full> the message index field will be set to the value of the highest index.

6.12.6 Message send from store +CMSS

6.12.6.1 General on +CMSS

This command is based on the GSM command. The difference is that the TETRA command has to define the stack. The command operates in test and set modes.

Implementation of this command is optional.

6.12.6.2 CMSS Set Syntax

+CMSS = <AI service>, <message index>

6.12.6.3 Description

The set command tells the MT to send, on the air interface, the message held in the stack <AI service> at location <message index>.

The message is sent on the air interface using some of the current settings of +CTSDS. The SDS type is known from the stack by <AI service>. The called party identity type and the called party identity are also taken from the stack. The values for <area>, <end-to-end encryption> and <access priority> are taken from the current setting of CTSDS.

NOTE: In the present document the called party identity cannot be changed by this command. If that is needed then the +CMGR can be used to read the message from the stack and the +CMGW commands needs to be used to define a new called party identity for the message before the +CMSS command is used to send the message.

When transmitted, the status automatically changes to "sent" on the stack.

6.12.6.4 CMSS Set Result Codes

The set result code is used to inform the TE that the message has been sent on the air interface.

+CMSS: <AI service>, <message index>, [<message reference>]

The message reference is only present if the message sent was using the SDS-TL protocol.

6.12.7 New message indication +CMTI

6.12.7.1 General on +CMTI

This command is based on the GSM CNMI command and its response. The difference is that the TETRA command uses CTSP to set the profile, it has only one mode of operation and thus there is only one field (message index). It relates to incoming messages in the SDS message stacks, which are in turn based on the TETRA SIM.

The command operates in unsolicited result mode only. For compatibility the CNMI may be used in the test mode.

Implementation of this command is optional.

6.12.7.2 Description

An unsolicited result code to indicate a new message has been put on the message stack. The parameters indicate the type of SDS and the location on the stack.

NOTE 1: The CMTI unsolicited result code will not be used if the MT does not have a message stack, or if the profile has been set to "MT only". If the MT has no message stack the CTSDSR unsolicited result code will be used.

NOTE 2: The command will not be sent if a message is received whilst the PEI is in either "circuit mode data" or "packet data" state. If the MT is capable of receiving SDS whilst in a circuit mode call or packet data session, then it may buffer the TE indications until the PEI returns to "command" state. Or the TE may perform a CMGL and CMGR on return to AT command state. The latter is recommended, as it is more useful for long-term breaks in the PEI.

6.12.7.3 CMTI Unsolicited Result Code Text

+CMTI <AI service>, <message index>, [<stack full>]

If the result code indicates <stack full> the message index field will be set to the value of the highest message index.

6.13 Modified GSM SDS direct commands

6.13.1 General on GSM SDS direct commands

This clause describes the commands that are used to send and receive SDS messages directly. That is not via the SDS message stack.

The defined values for the parameters in these TETRA commands are collected in clause 6.17.

All commands can have normal or extended error reporting as described in clause 6.16.

6.13.2 Send message +CMGS

6.13.2.1 General on +CMGS

This command is based on the GSM command. The difference is that the TETRA command has only one mode of operation and thus there is only one set of fields and their contents. The field definition and contents will differ from those found in GSM.

The command operates in test and set modes. There is an unsolicited result code to indicate air interface transmission.

Implementation of this command is mandatory, if sending of SDS messages is supported.

6.13.2.2 CMGS Set Syntax

+CMGS= <called party identity >, <length><CR><LF>user data<CtrlZ>

6.13.2.3 Description

The command will send a data message to the MT over the PEI. The SDS type (<AI service>, <area>, <end-to-end encryption>, <access priority> and <called party identity type> relating to the message shall have been set with a previous +CTSDES command. If necessary, the required operating mode, V+D or DMO, shall have been set with a previous +CTOM command. Although only SDS type 4 has variable length the length field is mandatory for consistency and gives the MT a means for checking the current <AI service> parameter. The user data and length fields will follow the same constricts as those defined in clause 6.3.

6.13.2.4 CMGS Set and Unsolicited Result Code Text

The set result code only indicates delivery to the MT. In addition to the normal <OK> it contains a message reference <SDS instance>, which can be used to identify message upon unsolicited delivery status report result codes. For SDS-TL messages the SDS-TL message reference is returned. The unsolicited result code can be used to indicate later transmission over the air interface or the sending has failed.

+CMGS: <SDS Instance>, [<SDS status>], [<message reference>]

6.13.3 TETRA SDS Receive +CTSDSR

6.13.3.1 General on +CTSDSR

This command is not contained in any existing specifications. It is specific to TETRA.

The command operates in test and read modes.

Implementation of this command is mandatory, if reception of SDS messages is supported.

6.13.3.2 Description

This is an unsolicited message that carries an incoming SDS message from a MT that has no message stack.

6.13.3.3 CTSDSR unsolicited Result Codes

+CTSDSR: <AI service>, [<calling party identity>], [<calling party identity type>], <called party identity>, <called party identity type>, <length>, [<end to end encryption>]<CR><LF>user data

NOTE 1: Although the <calling party identity> parameter is optional, as the External subscriber number information element in the air interface is optional, it is recommended that with the SDS the <calling party identity> is always provided.

NOTE 2: The comma for the end to end encryption may be omitted, if the <end to end encryption> parameter is not present, refer to clause 6.4.4.

6.14 TETRA MT control commands

6.14.1 General on TETRA MT control commands

The defined values for the parameters in these TETRA commands are collected in clause 6.17.

All commands can have normal or extended error reporting as described in clause 6.16.

Implementation of this command is optional.

6.14.2 TETRA Broadcast +CTBCT

6.14.2.1 General on +CTBCT

This command is not contained in any existing specifications. It is specific to TETRA V+D and is used to inform the TE of broadcast information from the SwMI. The command operates in test and read modes, and as an unsolicited result code.

6.14.2.2 Description

This command is sent as an unsolicited result code from the MT every time it sees a change in the Sysinfo broadcast by the SwMI. The TE uses this information to determine the current SwMI features. The data is derived from the air interface SYSINFO with extended services element.

6.14.2.3 CTBCT Result Code text

+CTBCT: <LA>, <BS service>, <Security information>, <SDS-TL addressing>

6.14.3 TETRA Status Text Read +CTSTR

6.14.3.1 General on +CTSTR

This command is not contained in any existing specifications. It is specific to TETRA and is used by the MT to retrieve the text strings associated with SDS numeric values. The command operates in test, set and read modes.

Implementation of this command is optional.

6.14.3.2 CTSTR Set Syntax

+CTSTR=<AI service>

6.14.3.3 Description

The TE uses this command to retrieve text strings stored in the MT memories. Status and SDS type 1 in particular have text strings associate with them, which have meaning to a particular user or application. The TE would typically use this command at link recovery. Then the text strings looked up by the TE when reading SDS messages would be used in preference to the numeric value indicated in the <message index> field. Note the only valid values for <AI service> are those where text strings are given (status and SDS1). Status values shall be as defined in EN 300 392-2 [3], clause 14.8.34 Pre-coded status, and SDS1 values shall be as defined in EN 300 392-2 [3], clause 14.8.49 User defined data-1.

6.14.3.4 CTSTR Read Result Code text

+CTSTR: <AI service>, <Status (or SDS 1) value>, <text> <CR><LF>

[<Status (or SDS 1) value>, <text> <CR><LF>]

NOTE: The <CR><LF> on the last may be followed directly by the "OK".

6.14.4 TETRA Service Profile +CTSP

6.14.4.1 General on +CTSP

This command is not contained in any existing specifications. It is specific to TETRA and is used to modify which incoming signalling (from the air interface) from being sent to the TE by the MT. The command operates in test, set and read modes.

MS may have one service profile that covers both V+D and DMO or may have separate service profiles for each. The set and read commands apply to the primary operating mode, V+D or DMO, though in the former case they will apply to both modes. Optionally <AI mode> parameter may be used to define the operating mode that the command is applied to.

If MT supports multiple physical or logical links, then the command and its response shall be valid for the link that is used to convey the commands. Optionally <link identifier> parameter may be used to test, set and read parameters of other links. The default physical or logical link should have link identifier value "0". The mapping of other links is outside the scope of the present document.

Implementation of this command is optional.

6.14.4.2 CTSP Set Syntax

+CTSP=<service profile>, <service layer1>, [<service layer2>], [<AI mode>], [<link identifier>]

6.14.4.3 Description

This command is used to define whether incoming signalling (from the air interface) to the MT is sent to the PEI. MT manufacturers define default behaviour of MT and a TE may need to disable or enable each service for which it does not want or wants to accept signalling. The read command will return all services with a profile set by the TE or MT.

NOTE 1: The <service layer2> parameter need not be present if all of the <service layer2> services in a <service layer1> block are to be routed and are allowed to be routed according to table 6.8. See exceptions in note 2 of table 6.8.

It can be seen from table 6.8 that the MT cannot accept a setting for "TE only" or "Both" for the <service layer1> values of "MM" when <service layer2> is omitted. Where one of these "service profile" values is required for at least one <service layer2> entry, the TE sends the "service profile" values for each of the <service layer2> values in a block it wants to control. Note that "Reserved" <service layer2> values are undefined and may be set in future versions of the present document into any value.

NOTE 2: If the <service layer1> value is an SDS service and the MS has a message stack, then the service profile only applies to the routing of "new message in the stack" indications (CMTI).

Allowed values for the service profile parameter shall be according to table 6.8.

Table 6.8: Allowed values for service profile parameter

Service Layer1	Service Layer2	Allowed values for service profile parameter			
		0 [MT only]	1 [TE only]	2 [Both]	3 [Neither]
0	Call Control (CC)				
	0 - Voice	YES	YES	Note 1	Note 3
	1 - Data	YES	YES	Note 1	Note 3
	2 to 9 - Reserved	Undefined	Undefined	Undefined	Undefined
1	Mobility Management (MM)				
	10 - Registration	YES	YES	Note 1	Note 3
	11 - Group Management	YES	YES	Note 1	Note 3
	12 - Security	YES	NO	Note 1	Note 3
	13 - Enable	YES	NO	Note 1	Note 3
	14 - Energy Saving	YES	YES	Note 1	Note 3
15 to 19 - Reserved	Undefined	Undefined	Undefined	Undefined	
2	Short Data Service (SDS)				
	20 - Status	YES note 2	YES note 2	Notes 1 and 2	Note 3
	21 - SDS type 1	YES	YES	Note 1	Note 3
	22 - SDS type 2	YES	YES	Note 1	Note 3
	23 - SDS type 3	YES	YES	Note 1	Note 3
	24 - SDS type 4, PID values 0 to 127, note 4	YES	YES	Note 1	Note 3
	25 - SDS type 4, PID values 128 to 255, note 4	YES	YES	Note 1	Note 3
26 to 29 - Reserved	Undefined	Undefined	Undefined	Undefined	
3	Short Data Service type 4 without Transport Layer (SDS-TL) service, notes 4 and 5				
	0 - Reserved	Undefined	Undefined	Undefined	Undefined
	1 - OTAK	YES	Note 6	Note 6	Note 6
	2 - Simple Text Messaging	YES	YES	Note 1	Note 3
	3 - Simple GPS	YES	YES	Note 1	Note 3
	4 - WAP	YES	YES	Note 1	Note 3
	5 - WCMP	YES	YES	Note 1	Note 3
	6 - M-DMO	YES	Undefined	Undefined	Undefined
	7 - PIN authentication	YES	YES	Note 1	Note 3
	8 - End to End encrypted message	YES	Note 6	Note 6	Note 6
	9 - Simple immediate text messaging	YES	YES	Note 1	Note 3
	10 - Location information protocol	YES	YES	Note 1	Note 3
	11 - Net assist protocol	YES	YES	Note 1	Note 3
	12 - DOTAM	YES	YES	Note 1	Note 3
	13 to 63 - Reserved for future standard definition	Undefined	Undefined	Undefined	Undefined
	64 to 126 - Available for user application definition	YES	YES	Note 1	Note 3
127 - Reserved for extension	Undefined	Undefined	Undefined	Undefined	
3	Short Data Service type 4 with Transport Layer (SDS-TL) service, notes 4 and 5				
	128 to 129 - Reserved	Undefined	Undefined	Undefined	Undefined
	130 - Text Messaging	YES	YES	Note 1	Note 3
	131 - GPS	YES	YES	Note 1	Note 3
	132 - WAP	YES	YES	Note 1	Note 3
	133 - WCMP	YES	YES	Note 1	Note 3
134 - M-DMO	YES	Undefined	Undefined	Undefined	

Service Layer1	Service Layer2	Allowed values for service profile parameter			
		0 [MT only]	1 [TE only]	2 [Both]	3 [Neither]
	135 - Reserved for future standard definition	YES	Undefined	Undefined	Undefined
	136 - End to End encrypted message	YES	Note 6	Note 6	Note 6
	137 - Immediate text messaging	YES	YES	Note 1	Note 3
	138 - Message with user data header	YES	YES	Note 1	Note 3
	139 - Reserved for future standard definition	Undefined	Undefined	Undefined	Undefined
	140 - Concatenated SDS message	YES	YES	Note 1	Note 3
	141 to 191 - Reserved for future standard definition	Undefined	Undefined	Undefined	Undefined
	192 to 254 - Available for user application definition	YES	YES	Note 1	Note 3
	255 - Reserved for extension	Undefined	Undefined	Undefined	Undefined
4	Packet Data				
	30 - IPV4	YES	YES	Note 1	Note 3
	31 - IPV6	YES	YES	Note 1	Note 3
	32 to 39 - Reserved	Undefined	Undefined	Undefined	Undefined
NOTE 1: The behaviour of the MT will be implementation specific when this value is used.					
NOTE 2: If the Service layer2 value is "Status", the values 31 744 to 31 767 used for SDS-TL acknowledgements (EN 300 392-2 [3], clause 14.8.34) should be sent as defined for SDS-TL.					
NOTE 3: The use of the value "Neither" is not recommended. The behaviour of the MT will be implementation specific when this value is used.					
NOTE 4: SDS type 4 is not available as a separate service, but only as an underlying service for SDS-TL.					
NOTE 5: The service Layer2 parameter values shall be as defined for the protocol identifier (PID) in EN 300 392-2 [3], clause 29.4.3.9. Note that values 0 to 127 are for SDS-TL without transport service.					
NOTE 6: It is outside the scope of the present document whether this routing is allowed.					

EXAMPLE 1: AT+CTSP=0,2,24 All SDS type 4 PID values 0 to 127 without Transport layer routed to MT only.

EXAMPLE 2: AT+CTSP=1,2,25 SDS type 4 PID values 128 to 255 with Transport layer routed to TE only.

EXAMPLE 3: AT+CTSP=1,3,4 WAP without Transport layer routed to TE only.

EXAMPLE 4: AT+CTSP=1,3,132 WAP with Transport layer routed to TE only.

EXAMPLE 5: AT+CTSP=1,3 All SDS type 4 PID values 0 to 255 routed to TE only.

6.14.4.4 CTSP Read Result Code text

+CTSP: =<service profile>, <service layer1>, [<service layer2>], [<AI mode>], [<link identifier>] <CR><LF>

[<service profile>, <service layer1>, [<service layer2>], [<AI mode>], [<link identifier>] <CR><LF>]

NOTE: The <CR><LF> on the last line may be followed directly by the "OK".

6.14.5 TETRA service definition for Circuit Mode services +CTSDC

6.14.5.1 General on +CTSDC

This command is not contained in any existing specifications. It is specific to TETRA and is used in conjunction with (before) other commands to perform outgoing TETRA call set up (of any sort). The command and associated responses shall be as presented below. The command operates in test, set and read modes.

Implementation of this command is mandatory, if voice or circuit mode data calls are supported and other than default destination address type is used.

6.14.5.2 CTSDC Set Syntax

In V+D mode the set syntax is:

+CTSDC=<AI service>, <called party identity type>, [<area>], [<hook>], [<simplex>], [<end to end encryption>], [<comms type>], [<slots/codec>], [<RqTx>], [<priority>], [<CLIR control>]

In DMO mode the set syntax is:

```
+CTSDC=<AI service>, <called party ident type>, [<area>], [<hook>], [<simplex>], [<end to end encryption>],
[<comms type>], [<slots/codec>], [<RqTx>], [<priority level>], [<CLIR control>]
```

6.14.5.3 Description

This command sets all parameters to be used on the TETRA Air Interface in outgoing circuit mode call set up in V+D and DMO. A MT uses the parameters set with this command in subsequent call set up, after reception of a dial command (D).

Some parameters are conditional on others and need not be specified (as long as the syntax of ITU-T Recommendation V.250 [5] is followed). For example if the service is set to "TETRA speech" then the number of slots shall be 1, duplex circuit mode calls have no need for <RqTx>.

The MT should check for validity of the parameters and their combination before accepting the command. The valid combinations may vary from supplier to supplier for functionality that is optional or phased.

NOTE: Implementers should take care when mixing different services on the air interface.

6.14.5.4 CTSDC Read Result Code text

In V+D mode the read result code text is:

```
+CTSDC: <AI service>, <called party identity type>, [<area>], [<hook>], [<simplex>], [<end to end encryption>] ,
[<comms type>], [<slots/codec>], [<RqTx>], [<priority>], [<CLIR control>]
```

In DMO mode the read result code text is:

```
+CTSDC: <AI service>, <called party identity type>, [<area>], [<hook>], [<simplex>], [<end to end encryption>],
[<comms type>], [<slots/codec>], [<RqTx>], [<priority level>], [<CLIR control>]
```

6.14.6 TETRA service definition for SDS Service +CTSDS

6.14.6.1 General on +CTSDS

This command is not contained in any existing specifications. It is specific to TETRA and is used in conjunction with (before) commands that perform writing to the stack and sending of both TETRA STATUS and SDS messages. The command and associated responses shall be as presented below. The command operates in test, set and read modes.

Implementation of this command is mandatory, if sending of SDS messages is supported and other than default AI service or destination address type is used.

6.14.6.2 CTSDS Set Syntax

In V+D mode the set syntax is:

```
+CTSDS=<AI service>, <called party identity type>, [<area>], [<access priority>], [<end to end encryption>]
```

NOTE: The <end to end encryption> parameter is included for future expansion.

In DMO mode the set syntax is:

```
+CTSDS=<AI service>, <called party identity type>, [<area>], [<priority level>], [<end to end encryption>],
[<comms type>], [<importance factor>]
```

6.14.6.3 Description

This command sets parameters to be used on the TETRA air interface in outgoing Status and SDS messaging in V+D and DMO. The MT uses the parameters set with this command in subsequent SDS sending commands, either directly or via a message stack.

The MT should check for validity of the parameters and their combination before accepting the command. The valid combinations may vary from supplier to supplier for functionality that is optional or phased.

NOTE: Implementers should take care when mixing different services on the air interface.

6.14.6.4 CTSDS Read Result Code text

In V+D mode the read result code text is:

+CTSDS: <AI service>, <called party identity type>, [<area>], [<access priority>], [<end to end encryption>]

In DMO mode the read result code text is:

+CTSDS: <AI service>, <called party identity type>, [<area>], [<priority level>], [<end to end encryption>], [<comms type>], [<importance factor>]

6.14.7 TETRA operating mode +CTOM

6.14.7.1 General on +CTOM

This command is not contained in any existing specifications. It is specific to TETRA and is used in conjunction with (before) other commands that perform configuration, outgoing TETRA call set up, and sending of both TETRA STATUS and SDS messages. The command and associated responses shall be as presented below. The command operates in test, set and read modes. There is an unsolicited result code to indicate MT initiated changes.

Implementation of this command is mandatory, if DMO is supported.

6.14.7.2 CTOM Set Syntax

+CTOM=<AI mode>

6.14.7.3 Description

This command sets the operating mode of the MT to V+D, DMO or dual watch. In the latter case the command defines whether V+D or DMO is the primary operating mode, i.e. the operating mode to use for outgoing calls and from which incoming calls are assumed to be from unless otherwise notified. If this command has not been used then the MT may be in any operating mode.

If the TE has set the operating mode and the mode is changed by the MT, e.g. as a result of user action at the MT, then the MT shall use an unsolicited notification to report the new mode.

The primary operating mode affects the AI protocol stack used for subsequent outgoing calls and affects or may affect the MT's response to the following commands:

- MT Capabilities +GCAP.
- Get MT TETRA identities +CNUM.
- TETRA Service Profile +CTSP.

6.14.7.4 CTOM Read and Unsolicited Result Code text

+CTOM: <AI mode>

6.14.8 TETRA DM communication type +CTDCT

6.14.8.1 General on +CTDCT

This command is not contained in any existing specifications. It is specific to TETRA DMO and may be used in conjunction with (before) other commands to perform outgoing TETRA call set up and sending of both TETRA STATUS and SDS messages. The command and associated responses shall be as presented below. The command operates in test, set and read modes. There is an unsolicited result code to indicate MT initiated changes.

Implementation of this command is optional.

6.14.8.2 CTDCT Set Syntax

+CTDCT=<DM communication type>, [<gateway/repeater address>], [<MNI>], [<serviced GSSI>]

6.14.8.3 Description

This command sets the DM communication type of the MT for subsequent outgoing DMO calls and SDS. The default DM communication type is Any, i.e. the MT may determine the communication type used itself. Alternatively the TE may select direct communication between MSs, or routing via a DM-REP, DM-GATE or DM-REP/GATE. When communication is to be via a repeater or gateway, the address of the repeater or gateway may be supplied, including an MNI if the repeater or gateway is not on the home network of the MT. When communicating via a gateway, the MT may register on the gateway. A specific communication type value is available so that the MT can be requested to use direct MS-MS communication whilst remaining registered on a gateway. If the TE has set the DM communication type, and the DM communication type is changed by the MT, then the MT shall use an unsolicited notification to report the new DM communication type.

6.14.8.4 CTDCT Read and Unsolicited Result Code text

+CTDCT: <DM communication type>, [<gateway/repeater address>], [<MNI>], [<serviced GSSI>]

6.14.9 TETRA Transient communication type +CTTCT

6.14.9.1 General on +CTTCT

This command is not contained in any existing specification. It is specific to TETRA DMO and used for reporting the type of incoming calls and SDS that differ from the primary operating mode or DM communication type.

Implementation of this command is optional.

6.14.9.2 CTTCT Set Syntax

+CTTCT= <CT unsolic>

6.14.9.3 Description

The set command controls the sending of unsolicited result codes by the value of <CT unsolic>. If enabled the MT shall report a transient communication type either when a call or SDS is received in a mode that is not the primary operating mode, V+D or DMO, or when a call or SDS is received in DMO via a route that is not according to the current DM communication type. The MT shall report the unsolicited result code immediately prior to reporting the incoming call or SDS.

6.14.9.4 CTTCT Unsolicited Result Code Text

+CTTCT: <transient communication type >, [<gateway/repeater address>], [<MNI>]

6.14.10 TETRA DMO visible gateways/repeaters +CTDGR

6.14.10.1 General on +CTDGR

This command is not contained in any existing specifications. It is specific to TETRA DMO and for reporting "visible" gateways and/or repeaters. The command operates in test, set and read modes. There is an unsolicited result code for MT initiated reports when enabled.

Implementation of this command is optional.

6.14.10.2 CTDGR Set Syntax

+CTDGR=<GR unsolic>

6.14.10.3 Description

The set command controls the sending of unsolicited result codes by the value of <GR unsolic>. If enabled the MT sends an unsolicited result code whenever there is a change to the gateways and/or repeaters "visible" to the MT (through reception or lack of reception of presence signal), containing a list of the visible gateways and/or repeaters. The MT also responds similarly to a read command.

If there is more than one visible gateway or repeater, each one will be returned on a different line.

<DM communication type> is used to indicate whether it is a DM-REP, DM-GATE or DM-REP/GATE and the MT shall only use these three values when reporting visible gateways and repeaters. When the list is empty, then no gateways or repeaters are "visible".

The TE should check the <presence information> to determine whether a visible gateway or repeater is useable at the current time. The MT shall enforce usage restrictions and not rely on the TE.

6.14.10.4 CTDGR Read and Unsolicited Result Code text

+CTDGR: [<DM communication type>], [<gateway/repeater address>], [<MNI>],
[<presence information>]<CR><LF>

[[<DM communication type>], [<gateway/repeater address>], [<MNI>], [<presence information>]<CR><LF>]

NOTE: In a read result code the <CR><LF> on the last line may be followed directly by the "OK".

6.14.11 TETRA DM Carrier Selection +CTDCS

6.14.11.1 General on +CTDCS

This command is not contained in any existing specifications. It is specific to TETRA and is used to configure the DM carrier upon which the MT shall operate while in DMO. The command and associated responses shall be as presented below. The command operates in test, set and read modes. There is an unsolicited result code to indicate MT initiated changes.

Implementation of this command is optional.

6.14.11.2 CTDCS Set Syntax

+CTDCS=<DM carrier> [, <DM carrier> [, ... , <DM carrier>]]

6.14.11.3 Description

This command sets the DM carriers upon which the MT will initiate and receive calls and SDS. If multiple DM carriers are supported by the MT, the MT initiates calls on the first DM carrier but monitors all carriers for incoming calls.

If the TE has set the DM carrier and the DM carrier is changed by the MT, e.g. as a result of user action at the MT, then the MT shall use an unsolicited notification to report the changed carrier.

This command is only applicable when the operating mode is DMO. The command is optional to use as some MT can determine the DM carrier from the group specified in +CTGS command.

6.14.11.4 CTDCS Read and Unsolicited Result Code text

+CTDCS: <DM carrier> [, <DM carrier> [, ... , <DM carrier>]]

6.14.12 MT Reboot ATR

6.14.12.1 General on MT Reboot ATR

This command is a new command defined in this specification. The ATR command operates in execution mode. The difference with ATZ is that in addition to setting the PEI parameters to their default values, it causes the MT to reboot. The MT shall return OK before rebooting.

The reboot shall cause the same effect on the MT as pressing the power-down and power-up buttons, i.e. the MT will power-up in the same state (V+D or DMO, in or out of TXI) it was in before the command was executed. When the MT is registered in V+D and able and allowed to transmit, the command shall cause the MT to perform ITSI detach and ITSI attach procedures.

Implementation of this command is optional.

6.14.12.2 Description

This command allows the TE to reboot an MT.

6.14.12.3 ATR execution syntax

ATR

6.15 New TETRA call handling commands

6.15.1 General on new TETRA call handling commands

This clause deals with call handling of TETRA circuit mode (voice or data) calls and incoming SDS messages that are not sent to the message stack. New outgoing circuit mode call set up commands are used in conjunction with the service definition command +CTSDC. The two commands are used in sequence to set the behaviour of the MT and to initiate a call.

The defined values for the parameters in these TETRA commands are collected in clause 6.17.

All commands can have normal or extended error reporting as described in clause 6.16.

6.15.2 TETRA Call Connect +CTCC

6.15.2.1 General on +CTCC

This is an unsolicited response code and is not contained in any existing specifications.

Implementation of this command is mandatory, if voice or circuit mode data calls are supported.

6.15.2.2 Description

This unsolicited response code is specific to TETRA and followed by +CTXG command is used to end the call set up phase for incoming and outgoing calls to the MT for both V+D and DMO circuit mode calls. In DMO the MT shall use CTCC to mark the start of a circuit mode connection, even though there is no directly corresponding message on the air interface.

6.15.2.3 CTCC Unsolicited Result Code Text

+CTCC: <CC Instance>, [<hook>], <simplex>, [<AI service>], [<end to end encryption>], [<comms type>], [<slots/codec>], [<proprietary>]

6.15.3 TETRA Call Release +CTCR

6.15.3.1 General on +CTCR

This is an unsolicited response code and is not contained in any existing specifications.

Implementation of this command is mandatory, if voice or circuit mode data calls are supported.

6.15.3.2 Description

This response is specific to TETRA. In V+D it is based on the D-RELEASE message. In DMO it may be a result of local release, receipt of DM-DISCONNECT message or pre-emption for new call. It indicates to the TE that its call release (hang up) request has been successful or that the other party or the network has cleared an ongoing call.

6.15.3.3 CTCR Unsolicited Result Code Text

+CTCR: <CC instance >, <disconnect cause>

6.15.4 TETRA Incoming Call Notification +CTICN

6.15.4.1 General on +CTICN

This is an unsolicited response code and is not contained in any existing specifications.

Implementation of this command is mandatory, if voice or circuit mode data calls are supported.

6.15.4.2 Description

This unsolicited response is specific to TETRA. In V+D it is based on the TETRA D-SETUP, D-CONNECT ACK and D-INFO messages. In DMO it is based on DM-SETUP or DM-SETUP PRES messages. It indicates an incoming call and its progress to the TE. The TE uses the parameters set with this command to interpret how to handle the call (e.g. whether to sound a ringing tone (hook) or to start call maintenance (direct) or possibly to negotiate slot use according to the baud rate on the PEI).

Some parameters are conditional on others. For example if the service is set to "TETRA speech" then the number of slots shall be 1.

The fields <calling party identity type> and <calling party identity> will normally be present in the first notification messages unless the calling party has withheld them.

The optional fields <called party identity type> and <called party identity> are used for group calls only to indicate the group number (GSSI) of the called group for an incoming group call.

6.15.4.3 CTICN Unsolicited Result Code Text

In V+D mode the unsolicited result code text is:

+CTICN: <CC instance >, <call status>, <AI service>, [<calling party identity type>], [<calling party identity>], [<hook>], [<simplex>], [<end to end encryption>], [<comms type>], [<slots/codec>], [<called party identity type>], [<called party identity>], [<priority>]

In DMO mode the unsolicited result code text is:

+CTICN: <CC instance >, <call status>, <AI service>, [<calling party identity type>], [<calling party identity>], [<hook>], [<simplex>], [<end to end encryption>], [<comms type>], [<slots/codec>], [<called party identity type>], [<called party identity>], [<priority level>]

NOTE 1: The presence of optional parameters depends on whether the message is MT originating or terminating.

For outgoing messages <calling party identity> and <calling party identity> are not present, <called party> is mandatory and <calling party identity type> is optional.

For incoming messages <calling party identity> is optional although should always be included, <calling party identity type> is optional, <called party identity> is mandatory and <called party identity type> value is "TSI" due to air interface definitions.

NOTE 2: The "comms type" parameter value "PABX external subscriber number" or "PSTN external subscriber number" without "identity" parameter value can be used to indicate that an external subscriber number is not available.

NOTE 3: The command may not be backwards compatible with some implementations of V1.1.1 and V1.2.1 as there is one comma less before the <calling party identity type> parameter.

6.15.5 TETRA outgoing Call progress notification +CTOCP

6.15.5.1 General on +CTOCP

This is an unsolicited response code and is not contained in any existing specifications.

Implementation of this command is mandatory, if voice or circuit mode data calls are supported.

6.15.5.2 Description

This response gives an indication to the TE as to the progress of an outgoing call. It is specific to TETRA. In V+D it is based on the D-CALL PROCEEDING, D-ALERT and D-INFO messages. In DMO it is based on DM-GACK message, but may be used at other times for consistency of TE presentation. The reception by the MT of one of these air interface messages will result in this PEI message. All parameters are subject to change by the SwMI in the course of a call set up so the TE should check their values even though it set them in the CTSDC command.

6.15.5.3 CTOCP Unsolicited Result Code Text

+CTOCP: <CC instance >, <call status>, <AI service>, [<hook>], [<simplex>], [<end to end encryption>], [<comms type>], [<slots/codec>]

6.15.6 TETRA Group Set up +CTGS

6.15.6.1 General on +CTGS

This command is not contained in any existing specifications. The command should always supply the complete group selection and scanning requirements for the primary operating mode; that is there is no history to a sequence of commands.

The command operates in test, set and read modes.

Implementation of this command is mandatory, if group calls are supported to any other than default group.

6.15.6.2 CTGS Set Syntax

+CTGS=[<group type>], <called party identity> ... [, [<group type>], < called party identity>]

In V+D group type shall be used. In DMO the group type may be omitted, as it will be ignored.

6.15.6.3 Description

When the operating mode is V+D, this command is used to instruct the MT to set groups in the MT as selected or scanned. The set result codes will be given after all Air Interface signalling has been successfully completed. When the operating mode is DMO, this command is used to set the valid group addresses for the MT to use. The set result codes will be given once the MT has configured its DMO protocol stack.

If there is more than one group in the MT each group identity will be returned on a different line.

The result code can be unsolicited as the group attachments of the MT may change as it moves.

Note the variable "called party identity" is used but it shall be a group identity obtained via the +CNUM command. If not the set command should be rejected.

6.15.6.4 CTGS Read and unsolicited Result Code text

+CTGS: [<group type>], < Called Party Identity><CR><LF>

[[<group type>], < Called Party Identity><CR><LF>]

NOTE: In a read result code the <CR><LF> on the last line may be followed directly by the "OK".

6.15.7 TETRA SDS Receive +CTSDSR

See clause 6.13.3.

6.15.8 Transmit Demand +CTXD

6.15.8.1 General on +CTXD

This command is not contained in any existing specifications.

The command operates in test and set modes.

Implementation of this command is mandatory, if semi-duplex voice or circuit mode data calls are supported.

6.15.8.2 CTXD Set Syntax

+CTXD= <CC instance >, <TxDemandPriority>, [<end to end encryption>]

6.15.8.3 Description

This command is specific to TETRA. In V+D it is based on the U-TX DEMAND message. In DMO it may result in a changeover request (DM-TX REQUEST or DM-GTX REQUEST) or a pre-emption request (DM-PRE EMPT or DM-GPRE EMPT). In a simplex call this command is used in conjunction with the transmission grant response to control the transmissions of the MT. The TE will generate this command on pressing of the MMI representing the PTT. The only allowed result code is either OK or ERROR.

6.15.9 Up Transmit Ceased +CUTXC

6.15.9.1 General +CUTXC

This command is not contained in any existing specifications.

The command operates in test and set modes.

Implementation of this command is mandatory, if semi-duplex voice or circuit mode data calls are supported.

6.15.9.2 CUTXC Set Syntax

+CUTXC= <CC instance>.

6.15.9.3 Description

This command is specific to TETRA. In V+D it is based on the U-TxCeased message. In DMO it is based on the DM-TX CEASED message. In a simplex call this command is used in conjunction with the transmission grant response to control the transmissions. The TE will generate this command on release of the MMI representing the PTT. The only allowed result code is either OK or ERROR.

6.15.10 Transmission Grant +CTXG

6.15.10.1 General on +CTXG

This is an unsolicited response and is not contained in any existing specifications. It is used to inform the MT that a call set up phase has finished and the call maintenance phase should be entered.

Implementation of this command is mandatory, if voice or circuit mode data calls are supported.

6.15.10.2 Description

This response is specific to TETRA. In V+D it is based on the D-TX GRANT, D-CONNECT, D-SETUP, D-CONNECT ACK and D-CALL RESTORE messages. In DMO it is implied from other call set-up messages. It indicates to the TE the end of the call set up phase for incoming and outgoing calls (following +CTCC command) and who is allowed to transmit in a simplex call. Typically the TE may use this information to display the identity of the transmitting party.

6.15.10.3 CTXG Unsolicited Result Code Text

+CTXG: <CC instance>, <TxGrant>, <TxRqPrmsn>, <end to end encryption>, [<TPI type>], [<TPI>]

6.15.11 Down Transmission Ceased +CDTXC

6.15.11.1 General on +CDTXC

This is an unsolicited response and is not contained in any existing specifications.

Implementation of this command is mandatory, if semi-duplex voice or circuit mode data calls are supported.

6.15.11.2 Description

This response is specific to TETRA. In V+D it is based on the D-TX CEASED message. In DMO it is based on the DM-TX CEASED message. In simplex calls it indicates to the TE that the talking party has ceased its transmission so it can update its MMI. The TE may subsequently request permission to transmit depending on the value of <TxRqPrmsn>.

6.15.11.3 CDTXC Unsolicited Result Code Text

+CDTXC: <CC instance>, <TxRqPrmsn>

6.15.12 Transmission Continue +CTXN

6.15.12.1 General on +CTXN

This is an unsolicited response and is not contained in any existing specifications.

Implementation of this command is mandatory, if voice or circuit mode data calls are supported.

6.15.12.2 Description

This response is specific to TETRA and is based on the D-TX Continue message. In simplex calls it indicates to the TE that an interrupted speech item may continue. The TE may request permission to transmit depending on the value of <TxRqPrmsn>.

6.15.12.3 CTXN Unsolicited Result Code Text

+CTXN: <CC instance>, <TxCont>, <TxRqPrmsn>

6.15.13 Transmission Interrupt +CTXI

6.15.13.1 General on +CTXI

This is an unsolicited response and is not contained in any existing specifications.

Implementation of this command is mandatory, if voice or circuit mode data calls are supported.

6.15.13.2 Description

This response is specific to TETRA. In V+D it is based on the D-TX INTERRUPT message. In DMO it is based on the DM-PREEMPT message. It indicates to the TE that permission to transmit has been withdrawn.

6.15.13.3 CTXI Unsolicited Result Code Text

+CTXI: <CC instance >, <TxGrant>, <TxRqPrmsn>, <end to end encryption>, [<TPI type>], [<TPI>]

6.15.14 Transmission Wait +CTXW

6.15.14.1 General on +CTXW

This is an unsolicited response and is not contained in any existing specifications.

Implementation of this command is mandatory, if semi-duplex voice or circuit mode data calls are supported.

6.15.14.2 Description

This response is specific to TETRA and is based on the D-TX Wait message. In simplex calls it indicates to the TE that the call is being interrupted. The TE may request permission to transmit depending on the value of <TxRqPrmsn>.

6.15.14.3 CTXW Unsolicited Result Code Text

+CTXW: <CC instance >, <TxRqPrmsn>

6.15.15 Key Status +CTKST

6.15.15.1 General on +CTKST

This command is not contained in any existing specifications.

The command operates in set mode.

Implementation of this command is optional.

6.15.15.2 CTKST Set Syntax

+CTKST= <key name>, < key status >, [<Ancillary ID>]

6.15.15.3 Description

This command is specific to TETRA (but may also be used by other PMR technologies) and is intended to signal the state of a remote switch that may not be part of a TE. The ancillary ID indicates which ancillary device is operating the key and may be used by the MT for audio routing, for example. Interpretation of the key state is determined by the MT, which may control its transmissions in response to this command. The only allowed result code is either <OK> or <error>. Examples include a PTT switch, a hook switch, an alarm switch and soft keys whose purpose is determined by the MT.

NOTE 1: Although a TE is not precluded from using this command, it is recommended that it is only used by simple remote switch devices that have limited or no knowledge of the call status of the MT. Where a TE is used that has knowledge of the call status of the MT, it is recommended that the TE uses the call-status-dependent commands (e.g. AT+CTSDC, ATD, AT+CTXD, AT+CUTXC).

NOTE 2: If the MT has both a TE and a remote switch device attached, the interaction between remote switch key activity (e.g. PTT) and TE call-status-dependent commands is determined by the MT, similar to the MT handling of the interaction between PEI operation and any local or locally connected PTT or other key activity on the MT.

NOTE 3: If the MT has more than one remote switch device attached, the interaction between the key statuses of different remote switch devices is determined by the MT, similar to the MT handling of the interaction with any local or locally connected PTT or other keys. The MT may make use of the identity of the remote control link on which a command is received when determining its response to this command. The MT may make use of the ancillary identifier (if supplied) when determining its response to this command.

6.16 MT errors

6.16.1 General on MT errors

This clause describes how to enable extended error reporting from the MT using the +CMEE command and the form of those extended reports. These codes are identical to codes specified in TS 100 916 [7] and are seen as applicable to TETRA.

6.16.2 Report MT error +CMEE

6.16.2.1 General on +CMEE

This command is not contained in any existing specifications and is specific to TETRA.

The command operates in test, set and read modes.

Implementation of this command is optional.

6.16.2.2 CMEE Set Syntax

+CMEE=<extend error report>

6.16.2.3 Description

Set command disables or enables the use of the final result code +CME ERROR: <extended error report code>. When enabled, MT related errors cause +CME ERROR: <extended error report code> instead of the regular ERROR final result code. The +CME ERROR: <extended error report code> also defines how to handle unknown parameters.

6.16.2.4 CMEE Set Result Code Text

+CMEE: <extend error report>

6.16.3 MT error result code +CME ERROR

6.16.3.1 General on +CME ERROR

This command is not contained in any existing specifications and is specific to TETRA.

The command operates in test and unsolicited result modes.

Implementation of this command is mandatory.

6.16.3.2 Description

The response +CME ERROR: <extended error report code> result code is similar to the regular ERROR result code but gives the TE more detailed information on the command error.

The format of <extended error report code> can be either numeric or verbose. This is set with the command +CMEE.

NOTE: ITU-T Recommendation V.250 [5] command V does not affect the format of this result code.

6.16.3.3 CME ERROR Unsolicited Result Code Text

+CME ERROR <extended error report code>

6.16.4 MT result code +CME PARAMETER

6.16.4.1 General on +CME PARAMETER

This command is not contained in any existing specifications and is specific to TETRA.

The command operates in test and unsolicited result modes.

Implementation of this command is optional.

6.16.4.2 Description

The response +CME PARAMETER: <parameter number> result code may be used with +CME ERROR <Unknown parameter> result to indicate the location of unknown parameter. It may be also used to indicate location of unsupported parameter or unsupported parameter value.

6.16.4.3 CME PARAMETER Unsolicited Result Code Text

+CME PARAMETER <parameter number>.

6.17 Parameter description and values

6.17.1 General on parameters

This clause details the allowed values for the parameters used in the commands specific to TETRA. The value parameters shall be encoded in decimal digits using the default character set unless changed by the CSCS command.

The values are presented in both numeric and verbose formats where applicable.

The default values are underlined>.

The MT should check combinations of parameters in command lines to ensure they are compatible with TETRA operation.

6.17.2 Access Priority

The lower layers of the MT use this to give PDUs a priority for access to the air interface.

- **0 - Low;**
- 1 - High;
- 2 - Emergency.

6.17.3 AI Service

This parameter is used to determine the type of service to be used in air interface call set up signalling. The services are all defined in EN 300 392-2 [3] or EN 300 396-3 [25].

- **0 - TETRA speech;**
- 1 - 7,2 kbit/s unprotected data;
- 2 - Low protection 4,8 kbit/s short interleaving depth = 1;
- 3 - Low protection 4,8 kbit/s medium interleaving depth = 4;
- 4 - Low protection 4,8 kbit/s long interleaving depth = 8;
- 5 - High protection 2,4 kbit/s short interleaving depth = 1;
- 6 - High protection 2,4 kbit/s medium interleaving depth = 4;
- 7 - High protection 2,4 kbit/s high interleaving depth = 8;
- 8 - Packet Data (V+D only);
- 9 - SDS type 1 (16 bits);
- 10 - SDS type 2 (32 bits);
- 11 - SDS type 3 (64 bits);
- 12 - SDS type 4 (0 - 2 047 bits);
- 13 - Status (16 bits, some values are reserved in EN 300 392-2 [3]).

6.17.4 AI mode

This parameter is used to indicate the mode of operation or the air interface protocol stack.

- 0 - V+D (trunked mode operation);
- 1 - DMO;
- 2 - V+D with dual watch of DMO;
- 3 - DMO with dual watch of V+D;
- 4 - V+D and DMO (used in conjunction CTSP command).

6.17.5 Alpha

Optional alphanumeric string used to help MMI for TETRA identities returned with the CNUM command.

6.17.5a Ancillary ID

This parameter is a locally defined identifier of a particular ancillary device.

NOTE 1: The ancillary identifier may be used by the MT for audio routing or to distinguish between different types of ancillary device, e.g. remote microphone, remote speaker microphone, handset, headset, etc.

NOTE 2: The structure of the ancillary identifier is outside the scope of this specification. However, it is recommended to use a text string identifying e.g. the manufacturer and model of the ancillary.

NOTE 3: If multiple ancillary devices supporting the +CTKST command are connected to the MT, each device should supply a unique value of <Ancillary ID> so that the MT can determine the source of the command. If multiple ancillary devices do not have unique values of <Ancillary ID> they should be connected to different ports on the MT so that the MT may determine the source of the command from lower layer link information.

6.17.6 Area

Area used by V+D area selection supplementary service in call set up, refer to EN 300 392-12-8 [21]. In DMO omit this parameter unless making a group call via a gateway.

NOTE: Some SwMIs use this field without the SS to restrict group call area during the set up phase. The areas are predefined in the SwMI and are made up of Location Areas.

- 0 - Area not defined;
- 1 - Area 1;
- 2 - Area 2;
- 3 - Area 3;
- 4 - Area 4;
- 5 - Area 5;
- 6 - Area 6;
- 7 - Area 7;
- 8 - Area 8;
- 9 - Area 9;
- 10 - Area 10;

- 11 - Area 11;
- 12 - Area 12;
- 13 - Area 13;
- 14 - Area 14;
- 15 - All areas.

6.17.7 BS service

This parameter is used to indicate to the TE, the supported services of the BS where the MT is registered. The table is copied into table 6.9, from EN 300 392-2 [3] for convenience. The table in EN 300 392-2 [3] will always take precedence. The table gives a bit oriented indication of the MS capabilities. The value sent in the command line string will be the hex equivalent of the total bit array, with the MSB the one at the top of the table. For example a BS capable of all services will have the parameter value "FFF".

Table 6.9: BS Service Details

Information element	Length	Value	Remarks
Registration	1	0	Registration not required on this cell
		1	Registration mandatory on this cell
De-registration	1	0	De-registration not required on this cell
		1	De-registration mandatory on this cell
Priority cell	1	0	Cell is not a priority cell
		1	Cell is a priority cell
Minimum mode service	1	0	Cell may use minimum mode
		1	Cell never uses minimum mode
Migration	1	0	Migration is not supported by this cell
		1	Migration is supported by this cell
System wide services	1	0	System wide services temporarily not supported
		1	Normal mode
TETRA voice service	1	0	TETRA voice service is not supported on this cell
		1	TETRA voice service is supported on this cell
Circuit mode data service	1	0	Circuit mode data service is not supported on this cell
		1	Circuit mode data service is supported on this cell
Reserved	1	0	Service is not available on this cell
		1	Service is available on this cell
SNDP Service	1	0	SNDP service is not available on this cell
		1	SNDP service is available on this cell
Air interface encryption Service	1	0	Air interface encryption is not available on this cell
		1	Air interface encryption is available on this cell
Advanced link supported	1	0	Advanced link is not supported on this cell
		1	Advanced link is supported on this cell

6.17.8 Call status

This parameter is used to indicate the status of either incoming or outgoing circuit mode call set up. The values are sent in D-Call Proceeding and D-info on the air interface.

- **0 - Call progressing.**
- 1 - Call queued.
- 2 - Called party paged.
- 3 - Call continue.
- 4 - Hang time expired.

6.17.9 Called party identity

A digit stream to be interpreted dependant on the value of <called party identity type>. The presentation shall be in ASCII, refer to clause 6.5.3. If the called party identity type is an external subscriber number then the gateway identity is provisioned in the MT.

6.17.10 Calling party identity

A digit stream to be interpreted dependant on <calling party identity type>. The presentation shall be in ASCII, refer to clause 6.5.3.

Typically used by any TE MMI to display the identity of the calling party.

6.17.11 Called party identity type

This parameter is used to indicate the type of identity to be used as the called party address. The associated identity used in signalling will be interpreted differently according to this parameter. External subscriber number addresses are used in association with a PSTN or PABX gateway.

- **0** - SSI;
- 1 - TSI;
- 2 - SNA (V+D only);
- 3 - PABX external subscriber number (V+D or DMO if via a gateway);
- 4 - PSTN external subscriber number (V+D or DMO if via a gateway);

NOTE: The actual value of the gateway identities (PSTN, PABX) is provisioned in the MT and cannot be changed over the PEI by AT commands.

- 5 - Extended TSI.

6.17.12 Calling party identity type

This parameter is used to indicate the type of identity received as the calling party address. The associated identity used in signalling will be interpreted differently according to this parameter. External subscriber number addresses are used in association with a PSTN or PABX gateway.

- **0** - SSI;
- 1 - TSI;
- 2 - Reserved;
- 3 - PABX external subscriber number;
- 4 - PSTN external subscriber number;
- 5 - Extended TSI.

6.17.13 CC instance

A three-digit number used to identify an ongoing call. The originating MT assigns it. The number will be assigned at the beginning of any particular call (incoming or outgoing) and used to relate all PEI signalling related to that call. The value of CC instance is not used on the air interface, although there is an equivalent "call identity".

6.17.14 Class of MS

This parameter is used to indicate to the TE the capabilities of the MS regarding air interface characteristics. The value reported depends upon the mode of operation of the MS.

In V+D the parameter is as defined in table 6.10. In DMO the parameter is as defined in table 6.11.

Table 6.10 is a copy of table 16.30 "Class of MS information element contents" (ex. table 167) in clause 16.10.5 of EN 300 392-2 [3] (V2.5.2). If there is any discrepancy between table 6.10 and table 16.30 (or equivalent table number, if changed due to re-numbering of tables) of EN 300 392-2 [3] shall take precedence. The table gives a bit oriented indication of the MS capabilities. The value sent in the command line string will be the HEX equivalent of the total bit array, with the MSB the one at the top of the table 6.10.

EXAMPLE: A MS capable of all V+D services except security and Common SCCH will have the parameter value "FFFF20", when TETRA air interface standard version number is 010₂.

Table 6.10: Class of MS (V+D)

Information sub-element	Length	Value ₂	Remarks
Frequency simplex/duplex	1	0	Frequency simplex supported
		1	Frequency duplex and simplex supported
Single/multislot	1	0	Single slot supported
		1	Multislot and single slot supported
Concurrent multi-carrier operation	1	0	Single carrier operation supported
		1	Multi and single carrier operation supported
Voice	1	0	No voice calls supported
		1	Voice calls supported
End-to-end encryption	1	0	End-to-end encryption supported
		1	End-to-end encryption not supported
Circuit mode data	1	0	No circuit mode data supported
		1	Circuit mode data supported
TETRA packet data	1	0	TETRA packet data not supported
		1	TETRA packet data supported
Fast switching	1	0	Fast switching not supported
		1	Fast switching supported
DCK air interface encryption	1	0	DCK air interface encryption not supported
		1	DCK air interface encryption supported
CLCH needed on carrier change	1	0	No CLCH needed on carrier change
		1	CLCH needed on carrier change
Concurrent channels (i.e. concurrent services)	1	0	Concurrent channels not supported
		1	Concurrent channels supported
Advanced link	1	0	Advanced link not supported
		1	Advanced link supported
Minimum mode	1	0	Minimum mode not supported
		1	Minimum mode supported
Carrier specific signalling channel	1	0	Carrier specific signalling channel not supported
		1	Carrier specific signalling channel supported
Authentication	1	0	Authentication not supported
		1	Authentication supported
SCK air interface encryption	1	0	SCK air interface encryption not supported
		1	SCK air interface encryption supported
TETRA air interface standard version number	3	000	EN 300 392-2 [3], no security functions
		001	EN 300 392-2 [3] and EN 300 392-7 [20] V2.1.1
		010	EN 300 392-2 [3] V2.3.2 to TS 100 392-2 [22] V2.6.1 and EN 300 392-7 [20] V2.1.1 to TS 100 392-7 [23] V2.4.1
		011	EN 300 392-2 [3] V3.1.1 to V3.3.1 and EN 300 392-7 [20] V3.1.1
		100	Reserved
		etc.	etc.
		111	Reserved
Common SCCH	1	0	Common SCCH not supported
		1	Common SCCH supported
Reserved	1	0	Default value
		1	Reserved for future expansion
Reserved	1	0	Default value
		1	Reserved for future expansion
Reserved	1	0	Default value
		1	Reserved for future expansion
Reserved	1	0	Default value
		1	Reserved for future expansion

Table 6.11: +Class of MS (DMO)

Information sub-element	Length	Value ₂	Remark
Reserved	1	0	Default value
		1	Reserved for future expansion
Reserved	1	0	Default value
		1	Reserved for future expansion
Reserved	1	0	Default value
		1	Reserved for future expansion
Voice	1	0	No voice calls supported
		1	Voice calls supported
End-to-end encryption	1	0	End-to-end encryption supported
		1	End-to-end encryption not supported
Circuit mode data	1	0	No circuit mode data supported
		1	Circuit mode data supported
Reserved	1	0	Default value
		1	Reserved for future expansion
DM gateway operation	1	0	DM gateway operation not supported
		1	DM gateway operation supported
DM repeater operation	1	0	DM repeater operation not supported
		1	DM repeater operation supported
Reserved	1	0	Default value
		1	Reserved for future expansion
Reserved	1	0	Default value
		1	Reserved for future expansion
Reserved	1	0	Default value
		1	Reserved for future expansion
Reserved	1	0	Default value
		1	Reserved for future expansion
Reserved	1	0	Default value
		1	Reserved for future expansion
Reserved	1	0	Default value
		1	Reserved for future expansion
SCK air interface encryption	1	0	SCK air interface encryption not supported
		1	SCK air interface encryption supported
TETRA air interface standard version number	3	000	EN 300 396-3 [25], no security functions
		001	EN 300 396-3 [25] and EN 300 396-6 [26]
		010	Reserved
		etc.	etc.
Reserved	1	111	Reserved
		0	Default value
Reserved	1	1	Reserved for future expansion
		0	Default value
Reserved	1	1	Reserved for future expansion
		0	Default value
Reserved	1	1	Reserved for future expansion
		0	Default value
Reserved	1	1	Reserved for future expansion
		0	Default value
Reserved	1	1	Reserved for future expansion
		0	Default value

6.17.15 CLIR control

This parameter shall be used to control presentation of the user identity. In DMO this controls Talking Party Number Identification (TPNI) except for calls through a gateway, in which case it has no effect.

- 0 - Not implemented or use default mode;
- 1 - Reserved;
- 2 - Presentation not restricted;

- 3 - Presentation restricted.

6.17.16 Comms type

This parameter is used to indicate the type of communication to be used in the maintenance phase of the current call set up or to indicate whether to use acknowledged or unacknowledged SDS service in DMO.

- **0 - Point to Point (V+D) - Individual call with presence check (DMO);**
- 1 - Point to multipoint (V+D) - group call (DMO);
- 2 - Point to multipoint (acknowledged) (V+D only);
- 3 - Broadcast (V+D only);
- 4 - Individual call without presence check (DMO only);
- 5 - Acknowledged SDS (DMO);
- 6 - Unacknowledged SDS (DMO).

6.17.17 CT unsolic

This parameter enables the unsolicited reporting of TETRA Transient communication type messages.

- **0 - disable transient communication type unsolicited result code;**
- 1 - enable transient communication type unsolicited result code.

6.17.18 Disconnect cause

This parameter is given in the disconnect message from the MT when a circuit-mode call is cleared by the other end, the SwMI, the gateway (in the case of DMO) or the MT itself. The latter may have been requested by the TE. The TE could use the information in MMI or to initiate retries.

- 0 - Not defined or unknown;
- 1 - User request;
- 2 - Called party busy;
- 3 - Called party not reachable;
- 4 - Called party does not support encryption;
- 5 - Network congestion;
- 6 - Not allowed traffic;
- 7 - Incompatible traffic;
- 8 - Service not available;
- 9 - Pre-emption;
- 10 - Invalid call identifier;
- 11 - Called party rejection;
- 12 - No idle CC entity;
- 13 - Timer expiry;
- 14 - SwMI disconnect;

- 15 - No acknowledgement;
- 16 - Unknown TETRA identity;
- 17 - Supplementary Service dependent;
- 18 - Unknown external subscriber number;
- 19 - Call restoration failed;
- 20 - Called party requires encryption;
- 21 - Concurrent set-up not supported;
- 22 - Called party is under the same DM-GATE as the calling party;
- 23 - 30 - Reserved;
- 31 - Called party offered unacceptable service;
- 32 - Pre-emption by late entering gateway;
- 33 - Link to DM-REP not established or failed;
- 34 - Link to gateway failed;
- 35 - Call rejected by gateway;
- 36 - V+D call set-up failure;
- 37 - V+D resource lost or call timer expired;
- 38 - Transmit authorization lost;
- 39 - Channel has become occupied by other users;
- 40 - Security parameter mismatch.

6.17.19 DM carrier

This parameter is used to indicate the RF carrier number to use in DMO. It has the range 0 to 4 095. The usage of the TETRA frequency bands and channel numbering shall be as defined in TS 100 392-15 [24].

6.17.20 DM communication type

This parameter is used to indicate the communication type for outgoing calls in DMO, i.e. whether it is a direct communication between MSs, or whether it is being routed via a DM-REP, DM-GATE or DM-REP/GATE.

- **0 - Any, MT decides;**
- 1 - Direct MS-MS;
- 2 - Via DM-REP;
- 3 - Via DM-GATE;
- 4 - Via DM-REP/GATE;
- 5 - Reserved;
- 6 - Direct MS-MS, but maintain gateway registration.

6.17.21 End to End encryption

This parameter is used to indicate whether end-to-end encryption is to be used during an (either incoming or outgoing) circuit mode call.

- **0 - Clear;**
- 1 - Encrypted.

NOTE: The encryption referred to is end to end, not air interface.

6.17.22 Extended error report

- **0 - Disable +CME ERROR: <extended error report code> and use "ERROR";**
- 1 - Enable +CME ERROR: <extended error report code> result code and use numeric <extended error report code> values;
- 2 - Enable +CME ERROR: <extended error report code> result code and use verbose <extended error report code> values;
- 3 - Enable +CME ERROR: <extended error report code> result code, use numeric <extended error report code> values and by-pass unknown parameters;
- 4 - Enable +CME ERROR: <extended error report code> result code and use verbose <extended error report code> values and by-pass unknown parameters.

6.17.23 Extended error report codes

These are values returned as final result codes if extended error reporting is enabled and an error is encountered. The values shall be as defined in table 6.12.

Table 6.12: Meaning and Usage of extended error report codes

Value	Meaning	Usage or Comment
0	MT failure	The MT was unable to send the data over the air (e.g. to the SwMI)
1	No connection to MT	The MT can not establish a reliable communication with the TE
2	MT adapter link reserved	The PEI link of the MT is being used already
3	Operations not allowed	This is a general error report code which indicates that the MT supports the command but not in its current state. This code shall be used when no other code is more appropriate for the specific context
4	Operation not supported	The MT does not support the command
5	PH-SIM PIN required	The MT can not process any command until the PIN for the SIM is provided
6	Reserved	Reserved
7	Reserved	Reserved
8	Reserved	Reserved
9	Reserved	Reserved
10	SIM not inserted	The MT can not process the command due to the absence of a SIM
11	SIM CHV1 required	The SIM PIN1 is required for the MT to execute the command
12	SIM UNBLOCKING CHV1 required	MMI unblocking of the SIM PIN1 is required
13	SIM failure	The MT failed to access the SIM
14	SIM busy	The MT can not currently execute the command due to the SIM not being ready to proceed
15	SIM wrong	The MT does not recognize this SIM
16	Incorrect password	The entered PIN for the SIM is incorrect
17	SIM CHV2 required	The SIM PIN2 is required for the MT to execute the command
18	SIM UNBLOCKING CHV2 required	MMI unblocking of the SIM PIN2 is required
19	Reserved	Reserved
20	Memory full	The MT message stack is full
21	Invalid index	The requested message index in the message stack does not exist

Value	Meaning	Usage or Comment
22	Not found	The requested message index does not correspond to any message
23	Memory failure	The MT failed to store or access to its message stack
24	Text string too long	The text string associated with a status value is too long
25	Invalid characters in text string	The text string associated with a status value contains invalid characters
26	Dial string too long	The <dial string> is longer than 25 digits
27	Invalid characters in dial string	The <dial string> contains invalid characters
28	Reserved	Reserved
29	Reserved	Reserved
30	No network service	The MS is currently out of service and can not process the command
31	Network timeout	The MT did not receive any Layer 2 acknowledgement from the SwMI
32	Error decoding data	<user data> decoding failed
33	Parameter wrong type	At least one of the parameters is of the wrong type e.g. string instead of number or vice-versa
34	Parameter value out of range	At least one of the supported parameters in the command is out of range
35	Syntax error	The syntax of the command is incorrect e.g. mandatory parameters are missing or are exceeding
36	Data received without command	The MT received <user data> without AT+CMGS= ...<CR>
37	Timeout waiting for data	AT+CMGS command received, but timeout expired waiting for <user data>
38	Protocol identifier already registered	The TE has already registered the Protocol Identifier with the MT
39	Registration table full	Registration table in SDS-TL is full. The MT can no longer register a new Protocol Identifier until a registered Protocol Identifier is deregistered
40	Service not supported in DMO	The MT supports the requested service but not while it is in DMO
41	Transmission are inhibited	The MT is in Transmit inhibit mode and is not able to process the command in this state
42	Service Temporarily not available	The MT is involved in a signalling activity and is not able to process the command until the current transaction ends. In V+D, the signalling activity could be e.g. group attachment, group report, SDS processing, processing of DGNA, registration, authentication or any transaction requiring a response from the MS or the SwMI. In DMO, the signalling activity could be e.g. Call or SDS processing.
43	Service not supported in V+D	The MT supports the requested service but not while it is in V+D
44	Unknown parameter	The MT supports handling of unknown parameters
45	Reserved	Reserved
etc.	etc.	etc.
99	Reserved	Reserved
100	Unknown	The MT is not able to qualify the reason for rejection. Please consult your MT manufacturer
101	Reserved for use by GPRS	Value is specified in TS 101 356 [i.3]
etc.	Reserved for use by GPRS	etc.
150	Reserved for use by GPRS	Value is specified in TS 101 356 [i.3]
151	Reserved	Reserved
etc.	etc.	etc.
255	Reserved	Reserved
etc.	etc.	etc.
329	Reserved	Reserved
330	SMSC address unknown	The MT does not know the address of the Short message service centre

6.17.24 Gateway/repeater address

This parameter is used to indicate the address of a DM-REP, DM-GATE or DM-REP/GATE. It has the range 0 to 1023.

6.17.25 Group type

This parameter is used when setting the MT groups for use in V+D. A selected group will be used for outgoing calls. Either selected or scanned groups will receive incoming calls. Only incoming group calls with a priority higher than the scan level will interrupt ongoing group calls of a lower level.

If the group type is "none" all groups will be detached from the SwMI.

In DMO the group type may be omitted, as it will be ignored.

- **0 - None;**
- 1 - Select;
- 2 - Scan priority 1;
- 3 - Scan priority 2;
- 4 - Scan priority 3;
- 5 - Scan priority 4;
- 6 - Scan priority 5;
- 7 - Scan priority 6.

6.17.26 GR unsolic

This parameter enables the unsolicited reporting of changes in visible gateways and/or repeaters.

- **0 - disable visible gateways/repeaters unsolicited result code;**
- 1 - enable visible gateways/repeaters unsolicited result code.

6.17.27 Hook

This parameter is used to indicate the type signalling in either incoming or outgoing circuit mode call set up. An incoming hook signalling call should ring until answered by the TE. An incoming direct call will not ring but go straight to a circuit mode channel. This parameter may be omitted for DMO calls as all such calls are Direct.

- **0 - Hook signalling (V+D only);**
- 1 - Direct.

6.17.28 Ident unsolic

This parameter enables the unsolicited reporting of changes in group list.

- 0 - Disable TETRA identity unsolicited result;
- 1 - Enable TETRA identity unsolicited result.

6.17.29 Importance factor

This parameter is used to indicate the number of transmissions requested for unacknowledged short data in DMO. It has the range 1 to 6.

6.17.29a Key name

This parameter is used to indicate the function of a simple remote key.

- 0 – PTT (PRESS TO TALK), where "key pressed" simulates a PTT press and "key released" simulates a PTT release;
- 1 – hook switch, where "key pressed" means "off hook" and key released means "on hook", see EN 300 392-2 [3] clauses 14.5.1 to 14.5.3.1 for a description of the use of hook signalling;
- 2 – Emergency key, where "key pressed" means the emergency key has been pressed and "key released" means that the user has stopped pressing the emergency key;

- 3 to 100 - reserved;
- 101 to 110 - soft keys 1 to 10;
- 111 to 199 - available for proprietary use;
- 200 and beyond - reserved.

NOTE: The behaviour of the MT on receipt of key presses and releases is outside the scope of the present document.

6.17.29b Key status

This parameter is used to indicate the status of a simple remote key.

- 0 – key released;
- 1 – key pressed;
- 2 – key pressed and then released.

NOTE 1: The time the remote key device waits between a key being pressed or released and the remote key device sending a key status message is outside the scope of the present document.

NOTE 2: The behaviour of the MT on receipt of two successive presses of a particular key without an intervening release of that key is outside the scope of the present document.

6.17.30 LA

14-bit location area code of EN 300 392-2 [3], clause 16.10.30, presented in character set defined by +CSCS as a decimal number in range 0 to 16 393.

NOTE: This field is only valid if the MT is registered (<Reg stat> = 1 or 5).

6.17.31 Length

This parameter indicates the length of the "user data" field in SDS related commands. The length is given in ASCII decimal. The length does not include the command line parameters used to delineate the user data (<CR>, <LF>, <CtrlZ> or <ESC> characters). In the event of optional parameters not present on the command line, the length parameter can be identified as the one before the <CR><LF> characters.

6.17.32 Link identifier

The Link identifier parameter defines the physical or logical PEI link.

- 0 Default link;
- 1 Link number 1;
- etc. etc.
- 127 Link number 127.

6.17.33 Lower range Limit

This parameter sets the lower range limit value of a subset of the full group list.

- 1 to 4 096.

6.17.34 Message index

An identifier, for use with SDS message stack entries. This is independent of the memory location and is used in operations on the message stack. There is a different message index for each of the two stacks, one for Status, SDS 1 to 3 and one for SDS 4. It has the range 0 to 65 535.

6.17.35 Message reference

An identifier used in the SDS-TL message protocol. For definition see EN 300 392-2 [3], clause 29.

NOTE: EN 300 812-3 [14] defines that the value "FF" is used when the message is waiting for transmission and no real value is not yet allocated.

6.17.36 MNI

24 bits Mobile Network Identity, see EN 300 392-1 [1] presented in character set defined by +CSCS.

NOTE: This field is only valid if the MT has roamed (<Reg stat> = 5).

6.17.37 Number of groups

This parameter indicates the number of groups in a static or dynamic group list.

- 0 to 4 095.

6.17.38 Num type

This parameter is used to indicate the type of identity returned by the +CNUM command. The service centre is used as (an optional) part of the SDS-TL transport service protocol. The gateways returned are those used in the SwMI for access to PSTN and PABX services.

- 0 - Individual (ISSI or ITSI);
- 1 - Group (GSSI or GTSI);
- 2 - PSTN Gateway (ISSI or ITSI);
- 3 - PABX Gateway (ISSI or ITSI);
- 4 - Service Centre (ISSI or ITSI);
- 5 - Service Centre (E.164 number);
- 6 - Individual (extended TSI);
- 7 - Group (extended TSI).

6.17.39 Parameter number

The Parameter number shall indicate the position of the parameter.

- 1 First parameter;
- 2 Second parameter;
- etc.

6.17.40 PID

This parameter is used in the capability and profile setting commands. It shall be used in conjunction with a "service layer1" of SDS-TL. Value taken for the PIDs are those defined in EN 300 392-2 [3], clause 29.4.3.9.

- 0 to 255.

6.17.41 Presence information

This parameter is a value in the range 0 to 7 that shall be treated as three flags.

- Bit 0 - SwMI availability flag:
 - 0 - SwMI not available or repeater;
 - 1 - SwMI available;
- Bit 1 - DM-REP function flag:
 - 0 - function not available or repeater;
 - 1 - function available;
- Bit 2 - Usage restriction:
 - 0 - use of gateway or repeater not restricted;
 - 1 - use by MT is restricted.

For example value 1 means that it is a gateway, the gateway is in contact with the SwMI, the gateway does not support the DM-REP function and use of the gateway by the MT is not restricted.

6.17.42 Priority

This parameter is used to indicate the priority to be used in resource queueing of either incoming or outgoing circuit mode call set up. Refer to EN 300 392-12-10 [i.1] and EN 300 392-12-16 [17] for further details.

- 0 - Priority not defined by this parameter;
- 1 - Priority 1;
- 2 - Priority 2;
- 3 - Priority 3;
- 4 - Priority 4;
- 5 - Priority 5;
- 6 - Priority 6;
- 7 - Priority 7;
- 8 - Priority 8;
- 9 - Priority 9;
- **10 - Priority 10;**
- 11 - Priority 11;
- 12 - Priority 12;
- 13 - Priority 13;
- 14 - Priority 14;
- 15 - Priority 15.

6.17.43 Priority level

This parameter is used to indicate the priority level for DMO calls, refer to EN 300 396-3 [25] for further details.

- **0 - Normal priority;**
- 1 - High priority;
- 2 - Pre-emptive priority;
- 3 - Emergency pre-emptive priority.

6.17.44 Proprietary

This is a variable sized information element used to convey specific information relating to other fields in the current command. It is included for possible future expansion of some commands.

This element shall include the "proprietary element owner" element as the first field.

6.17.45 Proprietary element owner

This is the first part of the proprietary field to identify the manufacturer of the MT.

- **0 - Reserved;**
- 1 to 255 - Allocated to each manufacturer by ETSI (see annex H of EN 300 392-2 [3]).

6.17.46 Reg stat

This parameter is used to indicate the registration status of the MT to the TEI.

- 0 - Registering or searching a network, one or more networks are available;
- **1 - Registered, home network;**
- 2 - Not registered, no network currently available;
- 3 - System reject, no other network available;
- 4 - Unknown;
- 5 - Registered, visited network.

6.17.47 Reg unsolic

This parameter enables the unsolicited reporting of changes in registration status and/or Location Area.

- 0 - disable network registration unsolicited result code;
- 1 - enable network registration unsolicited result code for change in registration status (Reg status) only;
- 2 - enable network registration unsolicited result code LA for change in registration status, MNI or LA.

6.17.48 RqTx

This parameter is used in outgoing simplex circuit mode calls to give the call originator the first speech/data item. This parameter may be omitted for DMO calls as all such calls give the call originator the first speech/data item.

- **0 - Request to Tx;**
- 1 - No Request to Tx (V+D only).

6.17.49 SDS instance

A two-digit number identifying a particular SDS message in sending of Status and SDS messages without using the stack. The originating MT assigns this number. The number will be assigned at the beginning of any particular message sending and used to relate all PEI signalling related to that message sending. The value of SDS instance is not used on the air interface.

6.17.50 SDS-TL addressing

This parameter is used to indicate the SwMI support for its preferred SDS-TL addressing method as described in the extended services broadcast. Refer to EN 300 392-2 [3] for further details.

- **0 - Reserved;**
- 1 - Service centre addressing preferred;
- 2 - Never use service centre addressing;
- 3 - MS choice to use service centre addressing.

6.17.51 SDS Status

This parameter is used to indicate the status of outgoing and incoming SDS messages.

MT uses message stack:

- 0 - Incoming message stored and unread;
- 1 - Incoming message stored and read;
- 2 - Outgoing message stored and unsent;
- 3 - Outgoing message stored and sent.

MT does not use message stack:

- 4 - Outgoing message successfully sent;
- 5 - Outgoing message transmission failed.

6.17.52 Security information

An indication of whether the SwMI supports Air Interface encryption and if so what level. The full details can be found in EN 300 392-7 [20].

NOTE: Due to security reasons the associated air interface Key information is not passed over the PEI. Class 1 systems have no AI encryption, class 2 systems use SCK AI encryption, and class 3 systems use authentication and AI encryption with both SCK and DCK.

- **0 - Class 1;**
- 1 - Class 2;
- 2 - Class 3.

6.17.53 Service profile

This parameter is used to tell the MS where to route, or allow routing of air interface downlink and uplink signalling respectively. Its main purposes are to prevent unnecessary signalling and to avoid conflict in responses.

- **0 - MT Only;**
- 1 - TE Only;
- 2 - Both;
- 3 - Neither.

6.17.54 Service layer1

This parameter is used to indicate the MS capabilities and to set profiles directing services to and from the TE and/or MT. Each one is split into "layer2" sub-parameters.

- 0 - CC;
- 1 - MM;
- 2 - SDS;
- 3 - SDS-TL;
- 4 - Packet Data (only applicable to V+D).

6.17.55 Service layer2

This parameter is used (in conjunction with "service layer1" to indicate the MS capabilities and to set profiles directing services to and from the TE and/or MT. The set is split into groups of ten, where each group relates to a "layer1" except for layer1 value "SDS-TL", refer to clause 6.14.4.3.

- 0 - Voice;
- 1 - Data;
- 2 - 9 Reserved;
- 10 - Registration;
- 11 - Group Management;
- 12 - Security;
- 13 - Enable;
- 14 - Energy saving;
- 15 - 19 Reserved;
- 20 - Status;
- 21 - SDS type 1;
- 22 - SDS type 2;
- 23 - SDS type 3;
- 24 - SDS type 4 (not SDS-TL);

NOTE: SDS type 4 as an independent service is no more accessible as the SDS-TL maps on it and uses the first eight bits as the Protocol Identifier.

- 25 to 29 Reserved;
- 30 - IPV4;
- 31 - IPV6;

- 32 to 39 Reserved.

6.17.56 Serviced GSSI

A digit stream to be interpreted as a GSSI. The presentation shall be in ASCII. The MT passes the serviced GSSI to the gateway on registering to indicate a GSSI that it wishes to use.

6.17.57 Simplex

This parameter is used to indicate the type of circuit mode channel in either an incoming or an outgoing call set up. Simplex channels will be used in conjunction with transmission request and grant signalling once the call is established (maintenance phase). This parameter may be omitted for DMO calls as all such calls are Simplex.

- **0 - Duplex** (V+D only);
- 1 - Simplex.

6.17.58 Slots/Codec

The meaning of this parameter is dependant on the value of <AI service> in the same command. If <AI service> is a data service then this field is used to indicate the number of air interface slots to be used in either incoming or outgoing packet or circuit mode data call set up. If <AI service> is the voice service then this field indicates the type of Codec used.

Data

- 0 - 1 slot;
- 1 - 2 slots (V+D only);
- 2 - 3 slots (V+D only);
- 3 - 4 slots (V+D only).

Speech

- **1 - TETRA encoded speech (1 slot);**
- 2 - Reserved;
- 3 - Reserved;
- 4 - Proprietary encoded speech.

6.17.59 Stack full

This parameter is used to indicate when the MT message stack is full. TE applications should take care to ensure the stack does not stay full, as the MT can receive no more messages from the air interface. The application should delete messages from the stack before any more arrive.

- **0 - Stack not full;**
- 1 - Stack full.

6.17.60 Stack present

This parameter is used to indicate if the MT supports a SDS message stack.

- **0 - Stack present;**
- 1 - Stack not present.

6.17.61 TPI (Transmitting Party Identity)

A digit stream to be interpreted dependant on <TPI type>. Typically used by the TE MMI to display the identity of the party currently transmitting in a simplex call.

6.17.62 TPI (Transmitting Party Identity) type

This parameter is used in the call maintenance of a simplex call. It informs the TE how to interpret the Transmitting Party Identity field.

- **0 - SSI;**
- 1 - TSI;
- 2 - External subscriber number.

NOTE: The SSI refers to the current network to which the MT is registered.

6.17.63 Transient communication type

This parameter is used to indicate the communication type in either V+D or DMO.

- 0 - V+D;
- 1 - DMO - Direct MS-MS;
- 2 - DMO - Via DM-REP;
- 3 - DMO - Via DM-GATE;
- 4 - DMO - Via DM-REP/GATE.

6.17.64 TxCont

This parameter is used in the call maintenance phase of simplex circuit mode calls. When received from the MT the TE will know that any interruption of a call has ceased.

- 0 - Do not continue;
- **1 - Continue.**

6.17.65 TxDemandPriority

This parameter is used in the call maintenance phase of simplex circuit mode calls. It sets the priority to be used in a particular Tx Demand.

- 0 - Low;
- **1 - High;**
- 2 - Pre-emptive;
- 3 - Emergency.

6.17.66 TxGrant

This parameter is used in the call maintenance phase of simplex circuit mode calls. When received from the MT the TE will know what to do with the transmitter on the established circuit.

- 0 - Transmission granted;
- **1 - Transmission not granted;**

- 2 - Transmission queued;
- 3 - Transmission granted to another.

6.17.67 TxRqPrmsn

This parameter is used in the call maintenance phase of simplex circuit mode calls. It tells the TE whether it is allowed to request a transmission permission.

- **0 - Allowed to request;**
- 1 - Not allowed to request.

6.17.68 Upper range limit

This parameter sets the upper range limit value of a subset of the full group list.

- 1 to 4 096.

6.17.69 User data

This is ASCII Hex representation of the user data bit stream in SDS related messages. Coding is done starting at the MS bit; each block of four bits is represented by one character; the characters are presented in the same order as the bits themselves (no swapping of nibbles). If the number of bits is not divisible by four, then the least significant bits of the least significant Hex digit are packed with "0".

6.18 Outgoing call set up methodology

6.18.1 General on outgoing call set up methodology

This clause describes the procedures for successful set up of outgoing calls. In the event of an error at any step the MT will reply with an error message and the call set up will be cancelled.

6.18.2 Voice calls

The initiation of an outgoing voice call normally takes two commands.

- 1) A +CTSDC command is used to set parameters for subsequent dial commands.
- 2) A D command is used to initiate a call set up using the predefined parameters.

Subsequent calls of the same type (e.g. group) do not need a new +CTSDC command but it is recommended that a new set of parameters be set for every call. Implementers should take care that no calls overlap if they have different CTSDC parameters.

In some cases the TE will have to select the required operating mode (+CTOM) and/or select the required DM communication type (+CTDCT), prior to sending the +CTSDC command, but this only needs doing if a change is required.

The application within the TE may have different forms of MMI to generate these commands but these commands will always be used to initiate an outgoing call. For example the MMI could have a PTT which when pushed would generate a set of signalling to initiate a group call.

The MT interprets the "D" command in different ways depending on the <AI service> and <called party identity type> parameters set by the +CTSDC command. The dialled string is normally used as the called party address and the call is set up using the parameters set by the previous +CTSDC command.

The MT should check the dialled string for valid numbering. Illegal numbers or combinations of the dialled string and the +CTSDC parameters shall cause an error result code.

A voice call is set up on an "ATD" command if the <AI service> parameter has been set to voice. The dialled string in the "ATD" command will be treated in different ways depending on the values of <called party identity type>, <comms type> and <AI service>. When the final result code indicates successful execution of the "ATD" command the MT and TE still treat signalling on TD and RD as commands. This allows other services such as SDS and other voice calls to run concurrently, if the MT supports it.

- 1) If the <called party identity type> is PABX the MT will put the PABX gateway into the called party field on the air interface and the dialled string into the external subscriber number parameter.
- 2) If the <called party identity type> is PSTN the MT will put the PSTN gateway into the called party field on the air interface and the dialled string into the external subscriber number parameter.
- 3) In all other cases the MT will perform computations on the dialled string to generate the called party address field used on the air interface. The computations will depend on the value of <called party identity type>.

The outgoing call progress responses (+CTOCP) inform the TE of the call set up progress. The use of call progress signalling is implementation dependant, but for example will be used by the TE to indicate a resource queue.

The reception of a connect (+CTCC) message and a subsequent transmission grant (+CTXG) message informs the TE to enter the call maintenance phase.

In some cases the final result code may be "CONNECT". This special case shall be predetermined in both the MS and TE. Such predetermination is outside the scope of the present document and for this reason its use is not recommended.

6.18.3 Circuit mode data calls

The initiation of an outgoing circuit mode data call normally takes two commands.

- 1) A +CTSDC command is used to set parameters for subsequent dial commands.
- 2) A D command is used to initiate a call set up using the predefined parameters.

Subsequent calls of the same type do not need a new +CTSDC command but it is recommended that a new set of parameters be set for every call. Implementers should take care that no calls overlap if they have different CTSDC parameters.

In some cases the TE will have to select the required operating mode (+CTOM) and/or select the required DM communication type (+CTDCT), prior to sending the +CTSDC command, but this only needs doing if a change is required.

The MT interprets the "D" command in different ways depending on the <AI service> and <called party identity type> parameters set by the +CTSDC command. The dialled string is normally used as the called party address and the call is set up using the parameters set by the previous +CTSDC command.

The MT should check the dialled string for valid numbering. Illegal numbers or combinations of the dialled string and the +CTSDC parameters shall cause an error result code.

A circuit mode data call is set up on a "ATD" command if the <AI service> parameter has been set to one of the circuit mode data selections (values 1 to 7). The MT will generate the called party address field used on the air interface from the dialled string in the "ATD" command. The computations will depend on the value of <called party identity type>. Note PSTN and PABX are not valid values of <called party identity type>. When the final result code indicates successful execution of the "ATD" command the MT and TE change to AT circuit mode data state. Signalling on TD and RD is treated as data and passed through the MT as a transparent stream.

The outgoing call progress responses (+CTOCP) inform the TE of the call set up progress. The use of call progress signalling is implementation dependant, but for example will be used by the TE to indicate a resource queue.

The entrance in the call maintenance phase is marked by the reception of a connect (+CTCC) message, a transmission grant (+CTXG) message, and the final result code "CONNECT". Both TE and MT will change state to AT circuit mode data.

6.18.4 Sending of SDS messages

6.18.4.1 General on sending of SDS messages

The initiation of an outgoing SDS message can be done in two ways, directly to the air interface, or via the stack. In either case sending a message normally takes two commands. The choice of which method to use for SDS sending is TE and MT implementation dependant. If the MT does not have message stack capability then "direct" shall be used.

- 1) A +CTSDS command is used to set parameters for subsequent CMGW or CMGS commands.
- 2) A CMGW or CMGS command is used to send the message (stack or direct) using the predefined parameters.

Subsequent calls of the same type do not need a new +CTSDS command but it is recommended that a new set of parameters be set for every call. Implementers should take care that no calls overlap if they have different CTSDS parameters.

In some cases the TE will have to select the required operating mode (+CTOM) and/or select the required DM communication type (+CTDCT), prior to sending the +CTSDS command, but this only needs doing if a change is required.

6.18.4.2 Send via Stack

The CTSDS command is followed by a CMGW command, which writes the message to the stack. The response to the command informs the TE of a reference (message index) within the stack. The message is sent (later) on the air interface using a CMSS command from the TE. The CMSS command does not use the current setting for "called party identity type" of the CTSDS command but that stored in the stack for that message index. The other parameters of the U-SDS Data air interface PDU will be made up from the current CTSDS command.

If the message was a SDS-TL with a PID indicating use of the TL protocol the response will contain the message reference of the SDS-TL layer.

NOTE: SDS messages that have not been sent on the air interface can be deleted from this stack, effectively cancelling the send request.

6.18.4.3 Direct Send

An SDS direct send is initiated by a "CMGS" command if the <AI service> parameter has been set to one of the valid SDS selection (values 9 - 13). The MT will generate the called party address field used on the air interface from the address field in the "CMGS" command. The computations will depend on the value of <called party identity type>.

NOTE: PSTN and PABX are not valid <called party identity types> for SDS messages.

6.19 Incoming call set up methodology

6.19.1 General on incoming call set up methodology

This clause describes the procedures for successful incoming calls. In the event of an error at any step the MT or TE will reply with an error message and the call set up will be cancelled.

Incoming calls are always indicated by unsolicited messages from the MT towards the TE. The type of message and its parameters will tell the TE all details of the incoming call.

6.19.2 Voice calls

The unsolicited response (+CTICN) informs the TE that a voice call request has been made to the TE/MT station. The parameters are used to determine further TE actions. For example the parameters <hook> and <simplex> values will determine whether the TE starts a ring tone or goes straight to the call maintenance phase and whether to use the PTT in speech calls.

In the event of hook signalling the TE will send the standard command "A" when the TE MMI (or application) goes "off hook" to continue the call set up process.

The incoming call progress may be updated by further optional messages (+CTICN) to inform the TE of the call set up progress and for example will be used by the TE to indicate a resource queue.

In the event of a voice call with direct signalling the TE MMI will indicate open voice paths to selected speakers and microphones.

When the call is ready for completion the MT sends a connect (+CTCC) message and a subsequent transmission grant (+CTXG) message to the TE and both enter the call maintenance phase.

6.19.3 Circuit mode data calls

The unsolicited response (+CTICN) with the right parameters informs the TE that a circuit mode data call request has been made to the TE/MT station. The parameters are used to determine further TE actions. For example the parameters <hook> and <slots/codec> values will determine whether the TE starts a ring tone or goes straight to the call maintenance phase and whether it needs to change the baud rate of the PEI.

In the event of hook signalling the TE will send the standard command "A" when the TE MMI goes "off hook" to continue the call set up process.

The incoming call progress may be updated by further optional messages (+CTICN) to inform the TE of the call set up progress and for example will be used by the TE to indicate a resource queue.

In the event of a circuit mode data call with direct signalling the TE MMI will indicate connection and connect the data device to the circuit.

When the call is ready for completion the MT sends a connect (+CTCC) message, a transmission grant (+CTXG) message, and the final result code "CONNECT" to the TE and both will change state to AT circuit mode data. Signalling on TD and RD will now be treated as data. Call maintenance is described in clause 6.15.8.

6.19.4 Reception of SDS messages

6.19.4.1 Received via Stack

The TE will receive the unsolicited message +CMTI to indicate a new message has been stored on the MT message stack. The parameters of this message will inform the TE of the type of message and where it is to be found. A "list" and subsequent "read" message are used to retrieve the messages from the appropriate stack. SDS-TL messages will need handling according to the SDS-TL protocol, including sending a "consumed" message back to the source.

Both TE and MT stay in the command state.

6.19.4.2 Direct Received

The TE will receive the unsolicited message +CTSDSR, which has all parameters to define the message type and its contents. SDS-TL messages will need handling according to the SDS-TL protocol, including sending a "consumed" message back to the source.

6.20 Voice and circuit mode data call maintenance commands

In the voice and circuit mode data call maintenance phase the treatment of signalling on circuits TD and RD will be used for in call signalling, including disconnect.

In voice calls, the <simplex> parameter will indicate to the TE whether or not to use the MMI and commands associated with PTT. The outgoing commands are "transmit demand" and "transmit ceased" (+CTXD, +CUTXC). The associated responses will be "transmission granted" and "transmission ceased" (+CTXG, +CDTXC). The TE will use these for MMI purposes, including the display of the talking party identity.

In order to use these commands the TE and MT shall change into the AT command state (using hardware or escape signalling) the Transmit arbitration commands can be used. Once the transmit direction has been established the TE shall send an ATO command which (when acknowledged) will put both back into AT circuit data mode.

6.21 Call clear down commands

6.21.1 General on call clear down commands

All circuit mode (voice and data) calls and packet data sessions have a clear down phase. These are treated differently depending on the type of call that is in progress and which end clears the call.

6.21.2 TE Initiated clear

- 1) A voice call can be cleared from the TE, by sending the standard command "H".
- 2) A circuit mode data call can be cleared from the TE, in one of two ways depending on the setting of the "&D" command. If the "&D" command has been set to "2" (orderly clear down of call) the TE drops the DTR circuit.
 - If the hardware is not present then the "&D" command has been set to "0" (ignore DTR). In this case the TE sends an escape character (set by S2) sequence with guard times (set by S12) on the TD line. The MT shall be capable of decoding this sequence out of the transparent data stream.

6.21.3 Network and MT Initiated clear

All calls will be subject to clearing by a remote station, the SwMI or the MT itself. Definitions of the source of a clear are beyond the scope of the present document but include reasons such as the other party clearing the call, time outs and pre-emption. Different services will have different timeouts, some set in a MT and some in the SwMI. Examples are speech item duration (different for different speech services), circuit mode data duration and packet data session timer.

The TE will receive signalling as though the MT cleared the call.

- 1) A voice call can be cleared from the MT, by sending the release command (+CTCR) with its associated "disconnect cause" to indicate why and where the call clear was originated.
- 2) A circuit mode data call can be cleared from the MT in one of two ways:
 - if the circuit DCD is available and &C has been set to 1 the MT drops the DCD circuit;
 - if the hardware is not present then the &C has been set to 0 (ignore DCD) the MT can send the special "NO CARRIER" sequence with guard times. The TE shall be capable of decoding this sequence out of the transparent data stream.

6.22 MEX layer support

6.22.1 MEX Capability +CTMCAP

6.22.1.1 General on +CTMCAP

This command is used to request the MEX precedence capability for a given MEX handle.

6.22.1.2 CTMCAP Read Syntax

+CTMCAP=?<MEX handle>

6.22.1.3 CTMCAP Response Syntax

CTMCAP: <MEX handle>, <MEX capability>

This returns the value of MEX capability for the given MEX handle.

6.22.2 MEX Connect +CTMCON

6.22.2.1 General on +CTMCON

This command is used to initiate a PDP context with a set of QoS parameters, using the given MEX handle (which must have been previously requested).

6.22.2.2 CTMCON Set Syntax

+CTMCON= <MEX handle>, [<MEX QoS filter>], [<MEX QoS class lower (uplink)>], [<MEX QoS class upper (uplink)>], [<MEX QoS class lower (downlink)>], [<MEX Escalate DSCP5 Flag Enable>], <MEX Escalate DSCP5 Flag Reset>, [<MEX QoS class upper (downlink)>], [<MEX PDP type>], [<MEX PDP address>], [<NSAPI>], [<DCOMP>], [<PCOMP>], [<NSAPI QoS Negotiation>], [<NSAPI data priority>]

6.22.2.3 CTMCON Result Code Syntax

+CTMCON: <MEX handle>, <MEX connect report>, [<MEX connect reject cause>], <MTU>, [<MEX PDP type>], [<MEX PDP address>], [<DCOMP>], [<PCOMP>], [<NSAPI QoS Negotiation>], <MEX precedence supported>, [<MEX precedence rank>], [<PDU priority max>], [<mobile IPV4 information>]

6.22.3 MEX End +CTMEND

6.22.3.1 General on +CTMEND

This command is used to terminate a PDP context; this can be initiated by both the TE2 and MT2.

6.22.3.2 CTMEND Set Syntax

+CTMCON=<MEX handle>, [<NSAPI>], <MEX deactivation type>

This is for the TE2 to terminate the given PDP context; a response will always be returned.

6.22.3.3 CTMEND Response and Unsolicited Result Code Syntax

CTMEND: <MEX handle>, [<NSAPI>], <MEX deactivation type>

If this message is received unsolicited, then the MT2 is terminating the given PDP context.

6.22.4 MEX Handle +CTMHDL MEX Handle

6.22.4.1 General on +CTMHDL

This command is used to request a MEX handle (which is synonymous with PDP context) from the MEX, and to indicate whether any subsequent MEX communication using this handle should be dealt with by the MEX, or routed direct to SNDCP.

6.22.4.2 CTMHDL Set Syntax

+CTMHDL=<MEX handle>, <MEX mode>

MEX handle is set to 0 when requesting a new handle.

6.22.4.3 CTMHDL Response Syntax

CTMCON: <MEX handle>, <MEX mode>

This returns the value to MEX handle to use for the given request; failure to allocate a handle is indicated by a value of #FF.

6.22.5 MEX Modify +CTMMOD

6.22.5.1 General on +CTMMOD

This command is used to modify an already established PDP context with a new set of QoS parameters, using the given MEX handle (which must have been previously requested). This can be initiated either by the TE2 or the MT2.

6.22.5.2 CTMMOD Set Syntax

+CTMMOD= <MEX handle>,[<MEX QoS filter>], [<MEX filter operation>], [<MEX QoS class lower (uplink)>], [<MEX QoS class upper (uplink)>], [<MEX QoS class lower (downlink)>], [<MEX QoS class upper (downlink)>], [<MEX NSAPI usage>], [< NSAPI QoS Negotiation>]

6.22.5.3 CTMMOD Result Code Syntax

+CTMMOD: <MEX handle> <MEX modify report>, [<MEX modify reject cause>], [< NSAPI QoS Negotiation>], [<MEX precedence supported>], [<MEX precedence rank>]

6.22.5.4 CTMMOD Unsolicited Report Syntax

+CTMMOD: <MEX handle>, [< NSAPI QoS Negotiation>], [<Schedule availability>], [<MEX precedence supported>], [<MEX precedence rank>]

6.22.6 MEX QOS Class +CTMQC

6.22.6.1 General on +CTMQC

This command is used to a set of QoS parameters with a given MEX handle (which must have been previously requested).

6.22.6.2 CTMQC Set/Read Syntax

+CTMQC=<MEX handle>, <MEX QoS class>, [<MEX QoS Class Access>], [<MEX QoS>], [<MEX Precedence>], [<MEX Data Priority>], [<MEX PDU Priority Max>], [<MEX Data Importance>]

This is for the TE2 to set QoS parameters for the given MEX handle; a response will always be returned. The read form shall omit the optional parameters.

6.22.6.3 CTMQC Response Syntax

CTMQC: <MEX handle>, <MEX QoS class>, <MEX QoS Class Access>, <MEX QoS>, <MEX Precedence>, <MEX Data Priority>, <MEX PDU Priority Max>, <MEX Data Importance>

This returns the current QoS settings for the given MEX handle.

6.22.7 Request New Logical PEI Connection +CTPCON

6.22.7.1 General on +CTPCON

This command is used to request a new logical PEI connection (PCON) when operating with a high speed connectivity technology.

6.22.7.2 CTPCON Set Syntax

+CTPCON=<Share response flag>

This requests a new PCON, and determines whether or not all responses to requests made on the new PCON should also be sent to the original requesting PCON.

6.22.7.3 CTPCON Response Syntax

CTPCON: <PCON result>, [<Device address>], [<Endpoint address>]

This returns (in the success case) the physical device and end-point address of the new PCON.

6.22.8 MEX related Parameters

6.22.8.1 CONTEXT_READY timer

This parameter sets the value for the SNDTCP CONTEXT-READY timer

- **0 - track READY timer;**
- 1 - 200 ms;
- 2 - 500 ms;
- 3 - 700 ms;
- 4 - 1 s;
- 5 - 2 s;
- 6 - 3 s;
- 7 - 5 s;
- 8 - 10 s;
- 9 - 20 s;
- 10 - 30 s;
- 11 - 60 s;
- 12 - 120 s;
- 13 - 180 s;
- 14 - 300 s.

6.22.8.2 Data Class

This parameter identifies a multimedia class to be used for the current MEX handle.

- 0 - Real time class - layer 2 link optimized for data which cannot tolerate delivery delay (late packets discarded by the receiving application);
- 1 - Telemetry class - layer 2 link optimized for intermittent data which can tolerate moderate delivery delay and packet loss;
- **2 - Background class - layer 2 link optimized for data which are intolerant of packet loss.**

6.22.8.3 Data Importance

This parameter defines the SNDCP data importance for the MEX handle: in circumstances where the MS SNDCP decides to delete or cancel untransmitted N PDUs, "data importance" allows the MS SNDCP to preferentially delete or cancel N PDUs containing lower importance data. Data importance is not transmitted over the air interface.

- 0 - Low;
- 1 - Medium;
- **2 - High.**

6.22.8.4 Data Priority

This parameter is used by SNDCP to determine ordering of data transmission.

- **0 - Lowest data priority;**
- etc.;
- 7 - Highest data priority.

6.22.8.5 DCOMP

This parameter is used to negotiate data compression at the SNDCP layer.

- **0 - No compression;**
- 1- ITU-T Recommendation V.42bis [27];
- 2- BSD compression;
- 3- Predictor compression;
- 4- BSD uncompressible packet.

6.22.8.6 Delay Class

This parameter specifies the degree of delay in transmission that can be tolerated for the MEX handle.

- 0 - Low;
- 1 - Moderate;
- 2 - High;
- **3 - Unpredictable.**

6.22.8.7 Device address

This parameter contains the device address upon which a new PCON has been created upon request by the TE2; its format depends on the specific physical connection technology used.

6.22.8.8 Endpoint address

This parameter contains the endpoint address assigned by the MT2 when a new PCON is requested; range is dependent on the specific physical connection technology used. Where there is an addressing distinction relating to the direction of flow (as in USB), this address shall refer to the TE2 -> MT2 direction.

6.22.8.9 Maximum Transmission Unit

This is the maximum size of N PDU which may be presented by the MS service user to SNDCP for transport over the air interface. This typically represents the maximum size of IP packet (prior to adding SNDCP header and performing compression) which may be carried over the air interface.

- 0 - Reserved;
- 1 - 296 octets;
- **2 - 576 octets;**
- 3 - 1 006 octets;
- 4 - 1 500 octets;
- 5 - 2 002 octets.

6.22.8.10 Mean Active Throughput

This is the mean throughput of N PDUs expected by the SNDCP service user while the PDP context's CONTEXT_READY timer is active.

The values are as for MEX minimum peak throughput.

6.22.8.11 Mean Throughput

This is the mean throughput of N PDUs expected by the SNDCP service user, averaged over the expected lifetime of the PDP context. It is given in units of octets hour⁻¹.

- 1 - 100 (~0,22 bits/s);
- 2 - 200 (~0,44 bits/s);
- 3 - 500 (~1,11 bits/s);
- 4 - 1 000 (~2,2 bits/s);
- 5 - 2 000 (~4,4 bits/s);
- 6 - 5 000 (~11,1 bits/s);
- **7 - 10 000 (~22 bits/s);**
- 8 - 20 000 (~44 bits/s);
- 9 - 50 000 (~111 bits/s);
- 10 - 100 000 (~0,22 kbits/s);
- 11 - 200 000 (~0,44 kbits/s);
- 12- 500 000 (~1,11 kbits/s);
- 13 - 1 000 000 (~2,2 kbits/s);
- 14 - 2 000 000 (~4,4 kbits/s);
- 15 - 5 000 000 (~11,1 kbits/s);
- 16 - 10 000 000 (~22 kbits/s);
- 17 - 20 000 000 (~44 kbits/s);
- 18 - 50 000 000 (~111 kbits/s);

- 19 - Best effort.

NOTE: These values follow those given for GPRS (see EN 301 344 [i.8]).

6.22.8.12 MEX Capability

This parameter identifies MEX precedence capability

- **0 - MEX Precedence is not supported;**
- 1 - MEX Precedence is supported.

6.22.8.13 MEX Connect Reject Cause

This parameter identifies the cause of a refused or failed MEX connection request.

- 0 - Undefined;
- 1 - MS not provisioned for Packet Data;
- 2 - IPv4 not supported;
- 3 - IPv6 not supported;
- 4 - IPv4 dynamic address negotiation not supported;
- 5 - IPv6 stateful address autoconfiguration not supported;
- 6 - IPv6 stateless address autoconfiguration not supported;
- 7 - Dynamic address pool empty;
- 8 - Static address not correct;
- 9 - Static address in use;
- 10 - Static address not allowed;
- 11 - Static IP address congestion;
- 12 - TETRA Packet Data not supported on this location area;
- 13 - TETRA Packet Data not supported on this network;
- 14 - Temporary rejection;
- 15 - Packet Data MS Type not supported;
- 16 - SNDCP version not supported;
- 17 - Mobile IPv4 not supported;
- 18 - Mobile IPv4 Co located Care of Addresses not supported;
- 19 - Maximum allowed PDP contexts per ITSI exceeded;
- 20 - User authentication failed;
- 21 - Activation rejected by external PDN;
- 22 - Access point name index not correct;
- 23 - No response from network;
- 24 - Bad response from network;

- 25 - NSAPI not available;
- 26 - NSAPI already allocated;
- 27 - Requested minimum peak throughput not available;
- 28 - Scheduled access not supported;
- 29 - Requested schedule not available;
- 30 - Requested QoS not available;
- 31 - Secondary PDP contexts not supported;
- 32 - Primary PDP context does not exist;
- 33 - Asymmetric QoS not supported;
- 34 - Automatic QoS filter not supported;
- 35 - Specified QoS filter not supported;
- 36 - QoS filter type not supported.

6.22.8.14 MEX Connect Report

This parameter identifies the result of a MEX connection request.

- 0 - Failure;
- 1 - Success (not used in "Bypass to SNDCCP" mode);
- 2 - Success (QoS Parameters changed).

6.22.8.15 MEX Data Importance

See EN 300 392-2 [3], clauses 30.2.3.6 and 28.2.3.2 for details of usage.

- 0 - Low;
- 1 - Medium;
- 2 - High.

6.22.8.16 MEX Data Priority

See EN 300 392-2 [3], clauses 30.2.3.4 and 28.2.3.2 for details of usage.

- 0 - Low Data Priority;
- 1;
- 2;
- 3;
- 4;
- 5;
- 6;
- 7 - High Data Priority.

6.22.8.17 MEX Deactivation Type

This parameter determines how MEX connections are to be deactivated.

- 0 - Deactivate all NSAPIs;
- 1 - Deactivate all MEX Contexts;
- 2 - Deactivate MEX Context given in the PDU.

6.22.8.18 MEX Escalate DSCP5 Flag Enable

This parameter indicates whether bit 5 of the Diffserv DSCP field in the IP Header is used for escalation of temporary IP packet priority.

- **0 - Do not use bit 5 of DSCP for priority escalation;**
- 1 - Use bit 5 of DSCP for priority escalation.

6.22.8.19 MEX Escalate DSCP5 Flag Reset

This parameter instructs the MEX to reset bit 5 of the Diffserv DSCP field in the IP Header which may be used by the application to flag that the IP packet priority should be escalated. Where Diffserv may be used for multiple hops in the IP network, resetting this flag can prevent any problems in Diffserv QoS policies outside of the TETRA network.

- **0 - Do not reset;**
- 1 - Reset Escalate priority flag - DSCP bit 5.

6.22.8.20 MEX Filter

If MEX filter type = TCP or UDP port, this parameter identifies a range of TCP or UDP ports to which a given QoS should apply and is a sequence of:

- Lower port value in range 0 to 65 535, upper port value in range 0 to 65 535.

If MEX filter type = diffserv, this parameter identifies the value of the Differentiated Services Code Point (DCSP) field in the IP header, and takes any legitimate value for that field.

6.22.8.21 MEX Filter Operation

Determines how the QoS filter is to be handled.

- **0 - Add this QoS filter to any existing QoS filter for this PDP context;**
- 1 - Replace any existing QoS filter for this PDP context by this QoS filter;
- 2 - Remove this QoS filter from the existing QoS filter for this PDP context.

6.22.8.22 MEX Filter Type

Identifies on what packet types filtering is to be performed.

- 0 - Automatic - the downlink port to NSAPI binding is derived from the uplink packet (and vice versa);
- **1 - All port types;**
- 2 - UDP only;
- 3 - TCP only;
- 4 - IP header Diffserv DSCP field.

6.22.8.23 MEX Handle

This parameter identifies a specific MEX connection, with an associated QoS.

- 0 - Use to indicate no Handle. Used to support legacy applications requiring a simply defined PDP context;
- 1 to 254 - Valid Handle Identifiers;
- 255 - Used to indicate failure to generate a valid handle. Only used in Confirmation or Indication primitives.

6.22.8.24 MEX Mode

This parameter governs how MEX operates for the given MEX handle.

- 0 - Use Mex;
- 1 - Bypass to SINDCP;
- 2 - Deallocate handle.

6.22.8.25 MEX Modify Reject Cause

This parameter identifies the cause of a refused or failed MEX modification request.

- 0 - Undefined;
- 1 - Temporary rejection;
- 2 - No response from network;
- 3 - Bad response from network;
- 4 - NSAPI not activated;
- 5 - Requested minimum peak throughput not available;
- 6 - Scheduled access not supported;
- 7 - Requested schedule not supported;
- 8 - Requested QoS not available;
- 9 - Secondary PDP contexts not supported;
- 10 - Primary PDP context does not exist;
- 11 - Asymmetric QoS not supported;
- 12 - Automatic QoS filter not supported;
- 13 - Specified QoS filter not supported;
- 14 - QoS filter type not supported.

6.22.8.26 MEX Modify Report

This parameter identifies the result of a MEX modification request; this has two variants, depending on the MEX Mode:

- Use MEX Mode:
 - 0 - Failure (No parameters are change from their previous value);
 - 1 - Success Local (One or more of MEX Precedence, PDU Priority, Data Importance, Data Priority have changed from their previous value);

- 2 - Success (One or more of the MEX NSAPI QoS parameters were changed from their previous value);
- 3 - Full Success (All requested parameter changes have been made).
- Bypass to SNDCP Mode:
 - 0 - Failure (the NSAPI QoS negotiation parameter was not changed from its previous value);
 - 1 - Success (one or more of the items in the NSAPI QoS negotiation parameter were changed from their previous values).

6.22.8.27 MEX NSAPI Usage

This parameter is used to modify the operation of a given NSAPI:

- 0 - Schedule paused;
- **1 - PDP context paused.**

6.22.8.28 MEX PDP Address

Either

- IPv4 address (only when a primary PDP context is being requested), in the form of decimal "dot quad" notation i.e. aaa.bbb.ccc.ddd; or
- NSAPI (only when a secondary PDP context is being requested).

6.22.8.29 MEX PDP Type

This parameter identifies a type of IP address:

- 0 - IPv4 (static address);
- 1 - IPv4 (dynamic address negotiation);
- 2 - IPv6;
- 3 - Mobile IPv4 - Foreign Agent care of address requested;
- 4 - Mobile IPv4 - Co located care of address requested;
- 5 - Primary NSAPI (secondary PDP context requested).

6.22.8.30 MEX PDU Priority Max

See EN 300 392-2 [3], clauses 30.2.3.5 and 28.2.3.2 for details of usage.

- 0 - Low PDU Priority;
- 1;
- 2;
- 3;
- 4;
- 5;
- 6;
- 7 - High PDU Priority.

6.22.8.31 MEX Precedence

This parameter defined how frequently packets are transmitted for a given MEX handle.

- 0 - Reserved;
- **1 - lowest precedence;**
- 2 to 14 - Valid Precedence Levels;
- 15 - Reserved.

6.22.8.32 MEX precedence rank

This parameter represents the percentage available (0 decimal places) MEX precedence - see EN 300 392-2 [3], clause 30.2.3.3. Note that the value 0 represents a positive rank value less than 0,5 %, **not** 0 %. Note that value 0 will also return if MEX precedence is not supported. It is recommended to use +CTMCAP where differentiation may be required.

6.22.8.33 MEX precedence supported

This parameter reports whether or not MEX precedence is supported:

- **0 - MEX precedence is not supported;**
- 1 - MEX precedence is supported.

6.22.8.34 MEX Peer IP Filter

This parameter identifies an IP addresses to which a given QoS should apply, and is in the form of decimal "dot quad" notation i.e. aaa.bbb.ccc.ddd

6.22.8.35 MEX QoS

This parameter fully defines the QoS in MEX, and consists of the concatenation of parameters:

- MEX precedence, data priority, PDU priority, data importance, NSAPI QoS negotiation [, scheduled access].

NOTE: If scheduled access is not required, all constituent fields are omitted and not defaulted.

6.22.8.36 MEX QoS Class

This parameter is an index to an array of sets of defined QoS settings:

- 0 - Identifier of the default QoS settings for a legacy PDP context creation;
- 1 to 8 - Identifiers of Specified QoS Class parameters - see EN 300 392-2 [3], clause 30.2.2.4;
- 9 to 32 - Identifiers of Manufacturer set Read Only QoS Class parameters;
- 33 to 255 - Identifiers of User writable QoS Class parameters.

6.22.8.37 MEX QoS Class Access

This parameter controls and indicates access to the MEX QoS Class entries:

- 0 - Read;
- 1 - Write;
- 2 - Write and lock;

- 3 - Unlock;
- 4 - Locked.

6.22.8.38 MEX QoS Class Upper/Lower (Downlink)

This parameter defines upper [lower] values for a usable MEX QoS Class value on the downlink, and has the same values as MEX QoS Class.

6.22.8.39 MEX QoS Class Upper/Lower (Uplink)

This parameter defines upper [lower] values for a usable MEX QoS Class value on the uplink, and has the same values as MEX QoS Class.

6.22.8.40 MEX QoS Filter

This parameter defines how filtering is to be applied, and consists of the sequence of parameters:

- MEX Filter Type, MEX Filter [, MEX Peer IP Filter], MEX Transaction Type.

6.22.8.41 MEX Transaction Type

This parameter indicates the IP transport type and client/server relationship for a MEX handle.

- 0 - Uplink Filter (Not available when using "Bypass to SNDSCP mode");
- 1 - Downlink Filter;
- 2 - Uplink Automatic Filter (Not available when using "Bypass to SNDSCP mode");
- 3 - Downlink Automatic Filter.

NOTE 1: Uplink Filter and Uplink Automatic Filter are not available when using "Bypass to SNDSCP mode".

NOTE 2: Uplink Automatic Filter and Downlink Automatic filter are not applicable when MEX Filter Type is "Diffserv".

6.22.8.42 Minimum Peak Throughput

This is the minimum peak throughput of N PDUs in units of octets/s requested or offered for a particular PDP context.

- 1 - < 1 000;
- 2 - \geq 1 000;
- 3 - \geq 2 000;
- 4 - \geq 4 000;
- 5 - \geq 8 000;
- 6 - \geq 16 000;
- 7 - \geq 32 000;
- 8 - \geq 64 000.

6.22.8.43 Mobile IPv4 Information

This parameter defines parameters for setting up a mobile IPv4 PDP context; it consists of a mandatory sequence of the following values, defined in EN 300 392-2 [3], clause 28.4.5:

- FA Care of Address, Sequence Number, FA Registration Lifetime, Register via FA (R), FA Busy (B), Home Agent (H), Foreign Agent (F), Minimal Encapsulation (M), GRE Encapsulation (G), Van Jacobsen Compression (V).

6.22.8.44 NSAPI

This parameter is only used in "Bypass to SMDCP" mode and mimics the SMDCP NSAPI parameter. See EN 300 392-2 [3], clause 28.1 for a full definition as applied to SN-DATA, SN-NSAPI Alloc, SN-NSAPI Configure, SN-NSAPI Dealloc, SN-NSAPI Modify.

- 0 - Reserved;
- 1 to 14 - Dynamically allocated.

6.22.8.45 NSAPI Data Priority

This parameter is only used in "Bypass to SMDCP" mode and mimics the SMDCP NSAPI Data Priority parameter. See EN 300 392-2 [3], clause 28.1 for a full definition as applied to SN-NSAPI Alloc and SN-NSAPI CONFIGURE.

- 0 - Lowest Data priority;
- etc.;
- 7 - Highest Data priority.

6.22.8.46 NSAPI QoS Negotiation

This parameter mimics the SMDCP NSAPI QoS Negotiation parameter; it is represented as a mandatory sequence of the following parameters:

- Minimum Peak Throughput, Mean Throughput, Mean Active Throughput, Data Class, Delay Class, Reliability Class, CONTEXT READY timer, Scheduled Access.

6.22.8.47 PCOMP

This parameter is used to negotiate protocol compression at the SMDCP layer.

- **0 - No compression;**
- 1 - Van Jacobson compressed TCP/IP;
- 2 - Van Jacobson non-compressed TCP/IP;
- 3 - FULL_HEADER;
- 4 - COMPRESSED_TCP;
- 5 - COMPRESSED_TCP_NODELTA;
- 6 - COMPRESSED_NON_TCP;
- 7 - COMPRESSED_RTP_8;
- 8 - COMPRESSED_RTP_16;
- 9 - COMPRESSED_UDP_8;
- 10 - COMPRESSED_UDP_16;

- 11 - CONTEXT_STATE;
- Others - For further standardization (a list of fixed or negotiated algorithms e.g. IPv6).

6.22.8.48 PCON result

This parameter returns the result of a new PCON request.

- 0 - Request failed;
- 1 - Request succeeded.

6.22.8.49 PDU Priority

This parameter defines the PDU priority as applied by SNDSCP.

- **0 - Lowest PDU priority;**
- etc.;
- 7 - Highest PDU priority.

6.22.8.50 PDU Priority Max

This parameter defines the maximum allowed value for PDU Priority.

- **0 - Lowest PDU priority;**
- etc.;
- 7 - Highest PDU priority.

6.22.8.51 Reliability Class

This parameter defines the degree of reliability that a packet transmission must have.

- 0 - High (uses an acknowledged link with FCS enabled);
- **1 - Moderate (uses an acknowledged link with FCS disabled);**
- 2 - Low (uses the unacknowledged basic link, normally with FCS disabled and no retransmissions).

6.22.8.52 Schedule availability

This parameter defines availability of a schedule:

- 1 - Available;
- 2 - Cancelled;
- 3 - Suspended.

6.22.8.53 Scheduled access

This parameter defines the parameters for a scheduled QoS, and is a mandatory sequence of:

- schedule repetition period, schedule timing error, scheduled number of N PDUs per grant, scheduled N PDU size.

NOTE: The scheduled N PDU size parameter should be repeated as many times as necessary, delimited by a comma, to indicate a size for each scheduled N PDU per grant.

6.22.8.54 Scheduled Number of N-PDU's per grant

This parameter identifies the number of N-PDUs that can be transmitted in a scheduled slot:

- 1;
- 2;
- etc.;
- 7.

6.22.8.55 Scheduled N-PDU size

This parameter identifies the maximum packet size that can be transmitted in a scheduled slot:

- 1 octet;
- 2 octets;
- etc.;
- 2 002 octets.

6.22.8.56 Schedule Repetition Period

This parameter identifies the interval between scheduled slots:

- 4 slot durations;
- 5 slot durations;
- etc.;
- 706 slot durations (10 s).

NOTE: A slot has a duration of 85/6 ms.

6.22.8.57 Schedule Timing Error

This parameter defines an acceptable error in a scheduled transmission: the SwMI sets the earliest timing of successive scheduled slot grants relative to the time of the first slot grant. The schedule timing error is the maximum acceptable delay of a scheduled slot grant beyond the earliest time of a scheduled slot grant. The SNDCP application should not propose a schedule timing error which is greater than the schedule repetition period.

- 0 - \leq 1 slot duration;
- 1 - \leq 2 slot durations;
- 2 - \leq 4 slot durations;
- 3 - \leq 8 slot durations;
- 4 - \leq 16 slot durations;
- 5 - \leq 32 slot durations;
- 6 - \leq 64 slot durations;
- 7 - \leq 128 slot durations.

NOTE: A slot has a duration of 85/6 ms.

6.22.8.58 Share response flag

This parameter is used when requesting a new PCON to determine whether all responses sent to the new PCON are also sent to the originating PCON.

- 0 - Do not replicate responses to originating PCON;
- 1 - Replicate responses to originating PCON.

7 TNP1 service description

7.1 Service primitives at the TNP1A-SAP

TNP1-SERVICE ACCESS request/indication: these primitives shall be used to extend the access to CMCE and MM services to the user applications located in TE2.

TNP1- SDS SERVICE PROFILE request/indication/response/confirm: these primitives shall be used by the user applications located in TE2 to specify the SDS 1/2/3 and Status service profile.

TNP1- CC SERVICE PROFILE request/indication/response/confirm: these primitives shall be used by the user applications located in TE2 to specify the CC service profile.

TNP1- MM SERVICE PROFILE request/indication/response/confirm: these primitives shall be used by the user applications located in TE2 to specify the MM service profile.

TNP1- SDS-TL SERVICE PROFILE request/indication/response/confirm: these primitives shall be used by the user applications located in TE2 to specify the SDS-TL service profile.

TNP1-UNITDATA request/indication: these primitives shall be used to send and receive U-plane circuit mode traffic to/from TMD-SAP.

TNP1-UNITDATA REPORT indication: this primitive shall be used deliver indications from U-plane circuit mode traffic.

7.2 Service primitives at the TNP1B-SAP

TNP1- SDS-TL CAPABILITY request/indication/response/confirm: these primitives shall be used to query the essential SDS-TL capabilities of a MT2 by user applications located in a TE2.

TNP1- SERVICES CAPABILITY request/indication/response/confirm: these primitives shall be used to query the essential capabilities (out of the SDS-TL capabilities) of a MT2 by user applications located in a TE2.

TNP1-IDENTIFICATION request/indication/response/confirm: these primitives shall be used to query the essential identification data of a MT2 by user applications located in a TE2.

TNP1-STATE request/indication/response/confirm: these primitives shall be used to query basic information of the operational state of a MT2 by user applications located in a TE2.

7.3 Service primitives at TNP1A-SAP and TNP1B-SAP

TNP1-CLOSE request/indication: these primitives shall be used to close the communication between peer TNP1 entities.

TNP1-OPEN request/indication: these primitives shall be used to close the communication between peer TNP1 entities.

TNP1-REPORT indication: this primitive shall be used to inform the user application about abnormal conditions within TNP1.

7.4 Primitive descriptions

7.4.1 TNP1-Services CAPABILITY

TNP1-SERVICES CAPABILITY request: shall be used by a TE2 user application to request capability information.

TNP1-SERVICES CAPABILITY indication: shall indicate a capability information request to the MT2 application in charge of providing the capability information.

TNP1-SERVICES CAPABILITY response: shall be used to initiate the capability information delivery by the MT2 application in charge of providing the capability information.

TNP1-SERVICES CAPABILITY confirm: shall be used to deliver the capability information to an MT2 application.

The parameters of the primitives shall be as defined in table 7.1.

Table 7.1: Parameters for the primitive TNP1-SERVICES CAPABILITY

Parameter	Request	Indication	Response	Confirm
Circuit mode and MS services	-	-	M	M
Security	-	-	M	M
SDS mode services	-	-	M	M
Packet mode services	-	-	M	M
Reserved, note			M	M
NOTE: The reserved field is 8 bits in length.				

7.4.2 TNP1-SDS-TL CAPABILITY

TNP1-SDS-TL CAPABILITY request: shall be used by a TE2 user application to request capability information.

TNP1-SDS-TL CAPABILITY indication: shall indicate a capability information request to the MT2 application in charge of providing the capability information.

TNP1-SDS-TL CAPABILITY response: shall be used to initiate the capability information delivery by the MT2 application in charge of providing the capability information.

TNP1-SDS-TL CAPABILITY confirm: shall be used to deliver the capability information to an MT2 application.

The parameters of the primitives shall be as defined in table 7.2. Its content shall be according to table 8.45.

Table 7.2: Parameters for the primitive TNP1-SDS-TL CAPABILITY

Parameter	Request	Indication	Response	Confirm
SDS-TL services	-	-	M	M

7.4.3 TNP1-IDENTIFICATION

TNP1-IDENTIFICATION request: shall be used by a TE2 user application to request identification information.

TNP1-IDENTIFICATION indication: shall indicate an identification information request to the MT2 application in charge of providing the identification information.

TNP1-IDENTIFICATION response: shall be used to initiate the identification information delivery by the MT2 application in charge of providing the identification information.

TNP1-IDENTIFICATION confirm: shall be used to deliver the identification information to the requesting MT2 application.

The parameters of the primitives shall be as defined in table 7.3.

Table 7.3: Parameters for the primitive TNP1-IDENTIFICATION

Parameter	Request	Indication	Response	Confirm
Terminal equipment identity	-	-	M	M
Manufacturer identifier	-	-	M	M
Model	-	-	M	M
Software version	-	-	M	M
Hardware version	-	-	O	O
Product serial No	-	-	O	O
ISO global object ID	-	-	O	O
TNP1 protocol version	-	-	O	O
TNP1 release	-	-	O	O

7.4.4 TNP1-IDENTITIES

TNP1-IDENTITIES request: shall be used by a TE2 user application to request the radio identities.

TNP1-IDENTITIES indication: shall indicate an identities information request to the MT2 application in charge of providing the identities information.

TNP1-IDENTITIES response: shall be used to initiate the identities information delivery by the MT2 application in charge of providing the identities information.

TNP1-IDENTITIES confirm: shall be used to deliver the identities information to the requesting MT2 application.

The parameters of the primitives shall be as defined in table 7.4.

Table 7.4: Parameters for the primitive TNP1-IDENTITIES

Parameter	Request	Indication	Response	Confirm
ITSI	-	-	M	M
Number of static groups	-	-	M	M
GTSI	-	-	M	M
Number of dynamic groups	-	-	M	M
GTSI	-	-	M	M
More information flag	-	-	M	M

7.4.5 TNP1-REPORT

TNP1-REPORT indication: this primitive shall be used to inform the user application about normal and abnormal conditions within TNP1 and PEI DLL.

The parameters of the primitives shall be as defined in table 7.5.

Table 7.5: Parameters for the primitive TNP1-REPORT

Parameter	Indication
Report reason	M
Cause	O (note)
Result	O (note)
NOTE:	Shall be present only when Reason indicates a "PEI DLL failure". Cause and Result shall be given the values of the corresponding PL-REPORT indication.

7.4.6 TNP1-SERVICE ACCESS

TNP1-SERVICE ACCESS request: shall be used to initiate transmission of a TNP1 PDU to the peer entity. The PDU that shall be generated and transmitted, shall be defined by the parameter "PDU Type".

TNP1-SERVICE ACCESS indication: shall be used to transfer the values of the information elements of a received TNP1 PDU to the service user.

The parameters of the primitives are defined in table 7.6.

Table 7.6: Parameters for the primitive TNP1-SERVICE ACCESS

Parameter	Request	Indication
PDU Type	M	M
PDU parameters	M (note)	M (note)
NOTE: Depending on the MT2 service. Some service primitives do not require any parameters.		

7.4.7 TNP1-SERVICE PROFILES

7.4.7.1 General on TNP1 service profiles

The TNP1 Service Profiles will be used to define the level of concurrency that is allowed for the MT and the TE while TNP1 is active. The concurrency defined is per service type, where for each service type a separate Service Profile is defined. It is assumed that the Service Profiles for the different services are unrelated.

The Service Profile for each service is defined in clauses 7.4.7.2 to 7.4.7.5.

There is no need of service profile for the Supplementary services. The SS are related to other service types. DGNA is to be handled by the Mobility attach/detach service. Other SS are to be handled by the application controlling the Call Control.

7.4.7.2 TNP1-SDS SERVICE PROFILE

TNP1-SDS SERVICE PROFILE request: shall be used by a TE2 user application to set the service profile of TE2 user applications for SDS access or to get the current state of the profile. The operation is selected with parameter Service Profile Operation.

TNP1-SDS SERVICE PROFILE indication: shall indicate the TNP1 Relay service profile configuration.

TNP1-SDS SERVICE PROFILE response: shall be used by the TNP1 Relay to initiate a service profile delivery to TE2 user application.

TNP1-SDS SERVICE PROFILE confirm: shall indicate the delivery of the service profile information to the TE2 user application.

The parameters of the primitives shall be as defined in table 7.7.

Table 7.7: Parameters for the primitive TNP1-SDS SERVICE PROFILE

Parameter	Request	Indication	Response	Confirm
Service profile operation	M	M	-	-
SDS status profile	O (note)	O (note)	M	M
SDS user data 1 profile	O (note)	O (note)	M	M
SDS user data 2 profile	O (note)	O (note)	M	M
SDS user data 3 profile	O (note)	O (note)	M	M
Service profile request result	-	-	M	M
Set profile request	O (note)	O (note)		
NOTE: Not relevant when Service profile operation = Get service profile.				

7.4.7.3 TNP1-CC SERVICE PROFILE

TNP1-CC SERVICE PROFILE request: shall be used by a TE2 user application to set the service profile of TE2 user applications for CC access or to get the current state of the profile. The operation is selected with parameter Service Profile Operation.

TNP1-CC SERVICE PROFILE indication: shall indicate the TNP1 Relay service profile configuration.

TNP1-CC SERVICE PROFILE response: shall be used by the TNP1 Relay to initiate a service profile delivery to TE2 user application.

TNP1-CC SERVICE PROFILE confirm: shall indicate the delivery of the service profile information to the TE2 user application.

The parameters of the primitives shall be as defined in table 7.8.

Table 7.8: Parameters for the primitive TNP1-CC SERVICE PROFILE

Parameter	Request	Indication	Response	Confirm
Service profile operation	M	M	-	-
CC profile	O (note)	O (note)	M	M
Service profile request result	-	-	M	M
Set Profile request	O (note)	O (note)	-	-
NOTE: Not relevant when Service profile operation = Get service profile.				

7.4.7.4 TNP1-MM SERVICE PROFILE

TNP1-MM SERVICE PROFILE request: shall be used by a TE2 user application to set the service profile of TE2 user applications for MM access or to get the current state of the profile. The operation is selected with parameter Service Profile Operation.

TNP1-MM SERVICE PROFILE indication: shall indicate the TNP1 Relay service profile configuration.

TNP1-MM SERVICE PROFILE response: shall be used by the TNP1 Relay to initiate a service profile delivery to TE2 user application.

TNP1-MM SERVICE PROFILE confirm: shall indicate the delivery of the service profile information to the TE2 user application.

The parameters of the primitives shall be as defined in table 7.9.

Table 7.9: Parameters for the primitive TNP1-MM SERVICE PROFILE

Parameter	Request	Indication	Response	Confirm
Service profile operation	M	M	-	-
MM profile	O (note)	O (note)	M	M
Service profile request result	-	-	M	M
Set profile request	O (note)	O (note)	-	-
NOTE: Not relevant when Service profile operation = Get service profile.				

7.4.7.5 TNP1-SDS-TL SERVICE PROFILE

TNP1-SDS-TL SERVICE PROFILE request: shall be used by a TE2 user application to set the service profile of TE2 user applications for SDS-TL access or to get the current state of the profile. The operation is selected with parameter Service Profile Operation.

TNP1-SDS-TL SERVICE PROFILE indication: shall indicate the TNP1 Relay service profile configuration.

TNP1-SDS-TL SERVICE PROFILE response: shall be used by the TNP1 Relay to initiate a service profile delivery to TE2 user application.

TNP1-SDS-TL SERVICE PROFILE confirm: shall indicate the delivery of the service profile information to the TE2 user application.

The parameters of the primitives shall be as defined in table 7.10.

Table 7.10: Parameters for the primitive TNP1-SDS-TL SERVICE PROFILE

Parameter	Request	Indication	Response	Confirm
Service profile operation	M	M	-	-
Protocol identifier kind	M	M	M	M
Protocol identifier	M	M	M	M
SDS user data 4 profile	O (note)	O (note)	M	M
Service profile request result	-	-	M	M
Set profile request	O (note)	O (note)		

NOTE: Not relevant when Service PROFILE OPERATION = Get service profile.

7.4.8 TNP1-STATE

TNP1-STATE request: shall be used by a TE2 user application to request basic information of the operational state of MT2.

TNP1-STATE indication: shall indicate a state information request to the MT2 user application in charge of providing information of the operational state of MT2.

TNP1-STATE response: shall be used to initiate the state information delivery by the MT2 application in charge of providing the state information.

TNP1-STATE confirm: shall be used to deliver the state information to a TE2 application.

The parameters of the primitives shall be as defined in table 7.11.

Table 7.11: Parameters for the primitive TNP1-STATE

Parameter	Request	Indication	Response	Confirm
Battery charge	-	-	O	O
Field strength	-	-	M	M
Bit error ratio	-	-	M	M
Internal temperature	-	-	O	O
Over temperature indication	-	-	O	O
Proprietary	-	-	O	O

7.4.9 TNP1-UNITDATA

TNP1-UNITDATA request: shall be used to send U-plane circuit mode traffic through TMD-SAP.

TNP1-UNITDATA indication: shall be used to receive U-plane circuit mode traffic from TMD-SAP.

The parameters of the primitives are defined in table 7.12.

Table 7.12: Parameters for the primitive TNP1-UNITDATA

Parameter	Request	Indication
PDU Type	M	M
Stolen	M	M
Data indicator	M	M
User data	M	M

7.4.10 Mapping of TNP1 PDUs and MT2 service primitives

Table 7.13 defines the mapping between TNP1 PDUs and service primitives available at TNP1A-SAP, TNP1B-SAP, TNCC-SAP, TNSS-SAP, TNSDS-SAP and TNMM-SAP. The mapping shall be applied in the TNP1 Relay.

Table 7.13: Mapping between TNP1 PDUs and MT2 service primitives

TNP1 PDU	Service primitive
TECC-ALERT IND	TNCC-ALERT indication
TECC-COMplete REQ	TNCC-COMplete request
TECC-COMplete IND	TNCC-COMplete indication
TECC-COMplete CON	TNCC-COMplete confirm
TECC-DTMF REQ	TNCC-DTMF request
TECC-DTMF IND	TNCC-DTMF indication
TECC-MODIFY REQ	TNCC-MODIFY request
TECC-MODIFY IND	TNCC-MODIFY indication
TECC-NOTIFY IND	TNCC-NOTIFY indication
TECC-PROCEED IND	TNCC-PROCEED indication
TECC-RELEASE REQ	TNCC-RELEASE request
TECC-RELEASE IND	TNCC-RELEASE indication
TECC-RELEASE CON	TNCC-RELEASE confirm
TECC-SETUP REQ	TNCC-SETUP request
TECC-SETUP IND	TNCC-SETUP indication
TECC-SETUP RES	TNCC-SETUP response
TECC-SETUP CON	TNCC-SETUP confirm
TECC-TX REQ	TNCC-TX request
TECC-TX IND	TNCC-TX indication
TECC-TX CON	TNCC-TX confirm
TESS-ERROR IND	TNSS-ERROR indication
TESS-INFO REQ	TNSS-INFO request
TESS-INFO IND	TNSS-INFO indication
TESS-INFO RES	TNSS-INFO response
TESS-INFO CON	TNSS-INFO confirm
TESS-SERVICE REQ	TNSS-SERVICE request
TESS-SERVICE IND	TNSS-SERVICE indication
TESS-SERVICE RES	TNSS-SERVICE response
TESS-SERVICE CON	TNSS-SERVICE confirm
TESDS-STATUS REQ	TNSDS-STATUS request
TESDS-STATUS IND	TNSDS-STATUS indication
TESDS-REPORT IND	TNSDS-REPORT indication
TESDS-UNITDATA REQ	TNSDS-UNITDATA request
TESDS-UNITDATA IND	TNSDS-UNITDATA indication
TEMM-ATTACH DETACH GROUP IDENTITY REQ	TNMM-ATTACH DETACH GROUP IDENTITY request
TEMM-ATTACH DETACH GROUP IDENTITY IND	TNMM-ATTACH DETACH GROUP IDENTITY indication
TEMM-ATTACH DETACH GROUP IDENTITY CON	TNMM-ATTACH DETACH GROUP IDENTITY confirm
TEMM-DISABLING IND	TNMM-DISABLING indication
TEMM-ENABLING IND	TNMM-ENABLING indication
TEMM-ENERGY SAVING REQ	TNMM-ENERGY SAVING request
TEMM-ENERGY SAVING CON	TNMM-ENERGY SAVING confirm
TEMM-REPORT IND	TNMM-REPORT indication
TEMM-REGISTRATION IND	TNMM-REGISTRATION indication
TEMM-REGISTRATION CON	TNMM-REGISTRATION confirm
TEMM-SERVICE IND	TNMM-SERVICE indication
TEMTA-XXX CAPABILITY REQ	TNP1-XXX CAPABILITY request
TEMTA-XXX CAPABILITY RESP	TNP1-XXX CAPABILITY response
TEMTA-IDENTIFICATION REQ	TNP1-IDENTIFICATION request
TEMTA-IDENTIFICATION RESP	TNP1-IDENTIFICATION response
TEMTA-OPERATION	TNP1-OPERATION request/indication
TEMTA-XXX SERVICE PROFILE	TNP1-XXX SERVICE PROFILE request
TEMTA-XXX SERVICE PROFILE RESP	TNP1-XXX SERVICE PROFILE response
TEMTA-STATE REQ	TNP1-STATE request
TEMTA-STATE RESP	TNP1-STATE response

7.5 Parameter description

All the parameters that are not defined in this clause, are defined in clause 8.5.

Cause =

Definition of EN 300 392-2 [3], clause 20.2.4 shall apply as applicable.

Data Indicator

Data available;

No data available.

PDU parameters =

A set of parameters required to fill the information elements of the PDU defined by the parameter MT2 service. Each parameter shall be equally enumerated and its values shall have equal interpretation as the corresponding PDU information element. Parameters for filling the PDU information elements shall be available in the following manner:

- One parameter for each Mandatory information element of the PDU;
- One parameter for each Optional information element required in the specific use of the PDU;
- One parameter for each Conditional information element required by the existence of a determining Optional information element in the PDU.

PDU type =

The parameter defines the PDU that shall be generated as a consequence of a service request, the indication type service primitive that shall be generated as a response to a received PDU.

The values of PDU Type and their interpretation shall be equal to the values and interpretation of PDU Type information element encoding defined in clause 8.5.91.

Result =

Definition of EN 300 392-2 [3], clause 20.2.4.3 shall apply as applicable.

Stolen

- 0 User data originates from a normal slot.
- 1 User data originates from a stolen slot.
- 2 User data is to be delivered in a normal slot.
- 3 User data is to be delivered in a stolen slot.

7.6 Service states for TNP1A-SAP

The TNP1A-SAP has three states, described below:

CLOSED: no services of the TNP1A-SAP are available to the service users. No service requests shall be issued.

IDLE: all services and service requests of TNP1A-SAP are available to the service users.

PROFILE CHANGE: change of the service profile is requested but not yet completed. No other TNP1A-SAP services or service requests shall be accessed while the profile change is in progress.

7.7 Service states for TNP1B-SAP

CLOSED: the services of the TNP1B-SAP are not available to the service users. No service requests shall be issued.

IDLE: all services of TNP1B-SAP are available to the service users.

8 TNP1 protocol

8.1 Procedures

8.1.1 Establishing communication between TE2 user applications and MT2

As TNP1 runs over a UDP/IP link the TNP1 communication between TE2 and MT2 is always established when the IP link is established. When the TNP1 entity receives an indication that the IP link is established it shall issue TNP1-OPEN indication.

8.1.2 Closing the TNP1 communication

The TNP1 communication will be closed when the IP link between the TE2 and the MT2 is disconnected. On detection of that disconnection a TNP1-CLOSE indication shall be issued by TNP1 entity.

8.1.3 Reporting normal and abnormal events

At any moment when the TNP1 communication is established, the application level entities may receive TNP1-REPORT indications that inform about abnormal events within the TNP1 peer entity. Both TE2 and MT2 TNP1 entities may report failures, see figures 8.1 and 8.2.

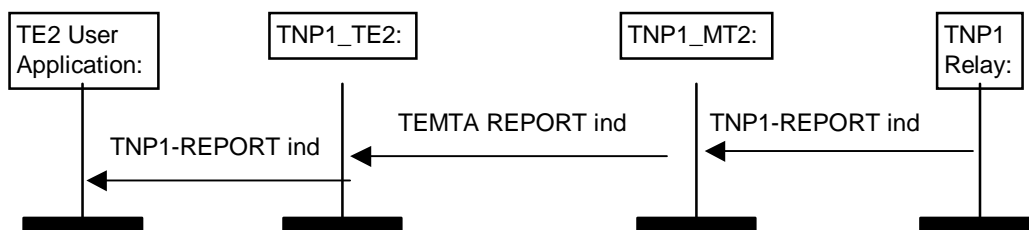

Figure 8.1: Reporting normal and abnormal events from TNP1 peer entity, MT2 end

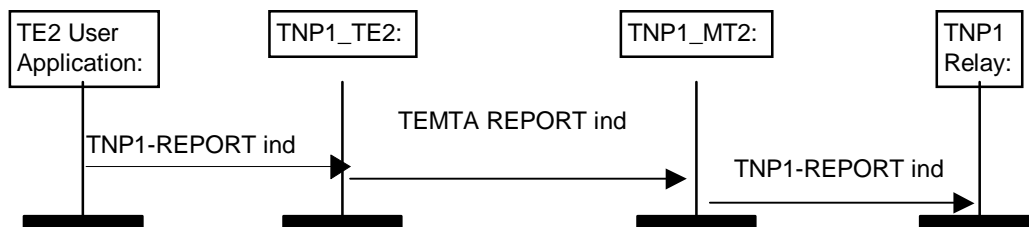

Figure 8.2: Reporting normal and abnormal events from TE2

8.1.4 Querying MT2 identification information

To query the MT2 identification information, a TE2 user application may issue a TNP1-IDENTIFICATION request. There shall be an application present in MT2 that responds to a TNP1-IDENTIFICATION indication with a TNP1-IDENTIFICATION response, refer to figure 8.3.

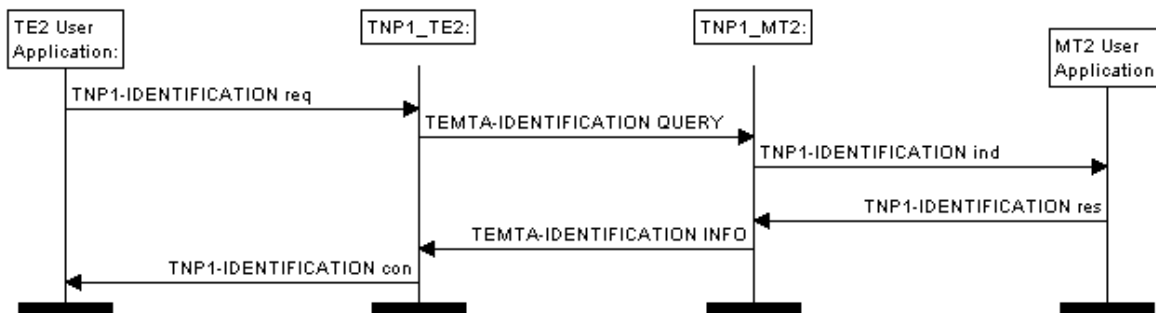

Figure 8.3: Querying MT2 identification information

8.1.5 Querying MT2 capabilities

To query the MT2 capabilities, a TE2 user application may issue a TNP1-CAPABILITY request. There shall be an application present in MT2 that responds to a TNP1-CAPABILITY indication with a TNP1-CAPABILITY response, see figure 8.4.

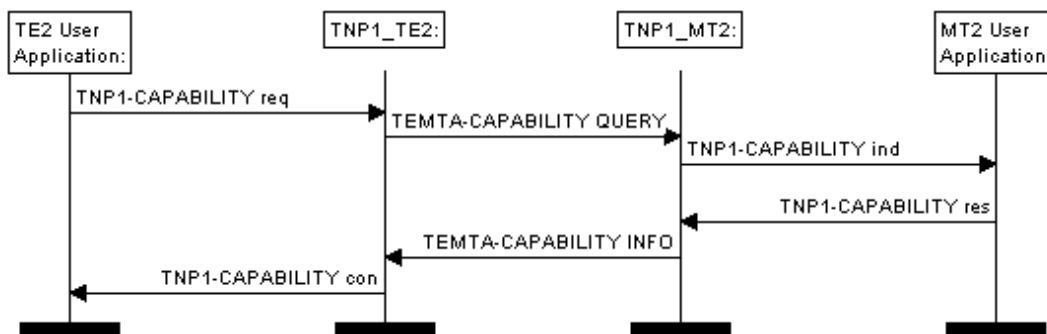

Figure 8.4: Querying MT2 capabilities

8.1.6 Querying MT2 state

To query current state of the MT2, a TE2 user application may issue a TNP1-STATE request. There shall be an application present in MT2 that responds to a TNP1-STATE indication with a TNP1-STATE response, see figure 8.5.

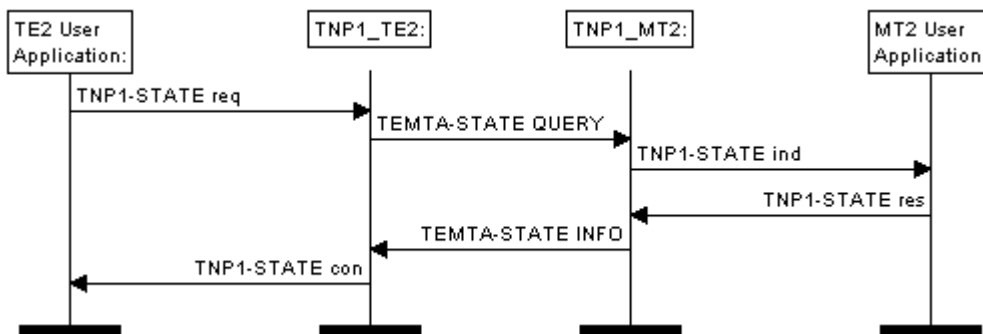

Figure 8.5: Querying MT2 state

8.1.7 Setting/getting the service profile

To get or set the current state of the MT2, a TE2 user application may issue a TNP1-XXX SERVICE PROFILE request. The selection between "get" and "set" operations shall be done with parameter Service Profile Operation. For both operations, there shall be an application present in MT2 that responds to a TNP1-XXX SERVICE PROFILE indication with a TNP1-XXX SERVICE PROFILE response, see figure 8.6.

Where XXX stands for SDS/CC/MM/SDS-TL.

The application shall:

- Optionally maintain a service profile according to successive "set" operations.
- Return the service profile as a response to "set" and "get" operations. The response to "set" shall indicate the profile after the "set" operation.

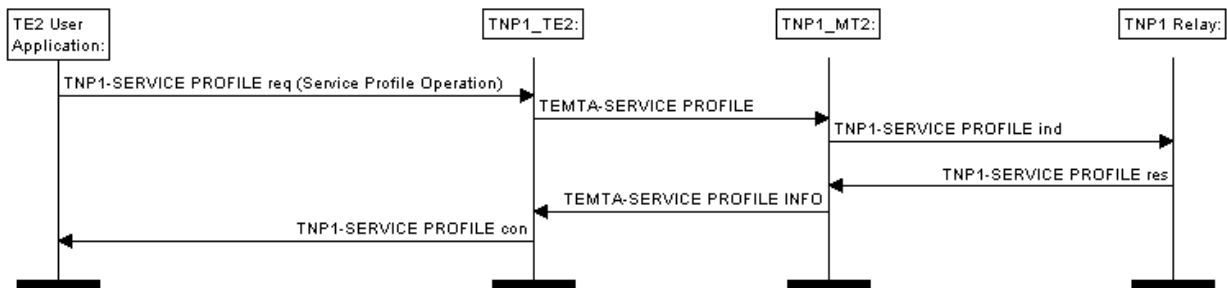

Figure 8.6: Setting/getting the service profile

8.1.8 Accessing CMCE and MM services

User applications in TE2 shall access CMCE and MM services by issuing the TNP1-SERVICE ACCESS request, see figure 8.7.

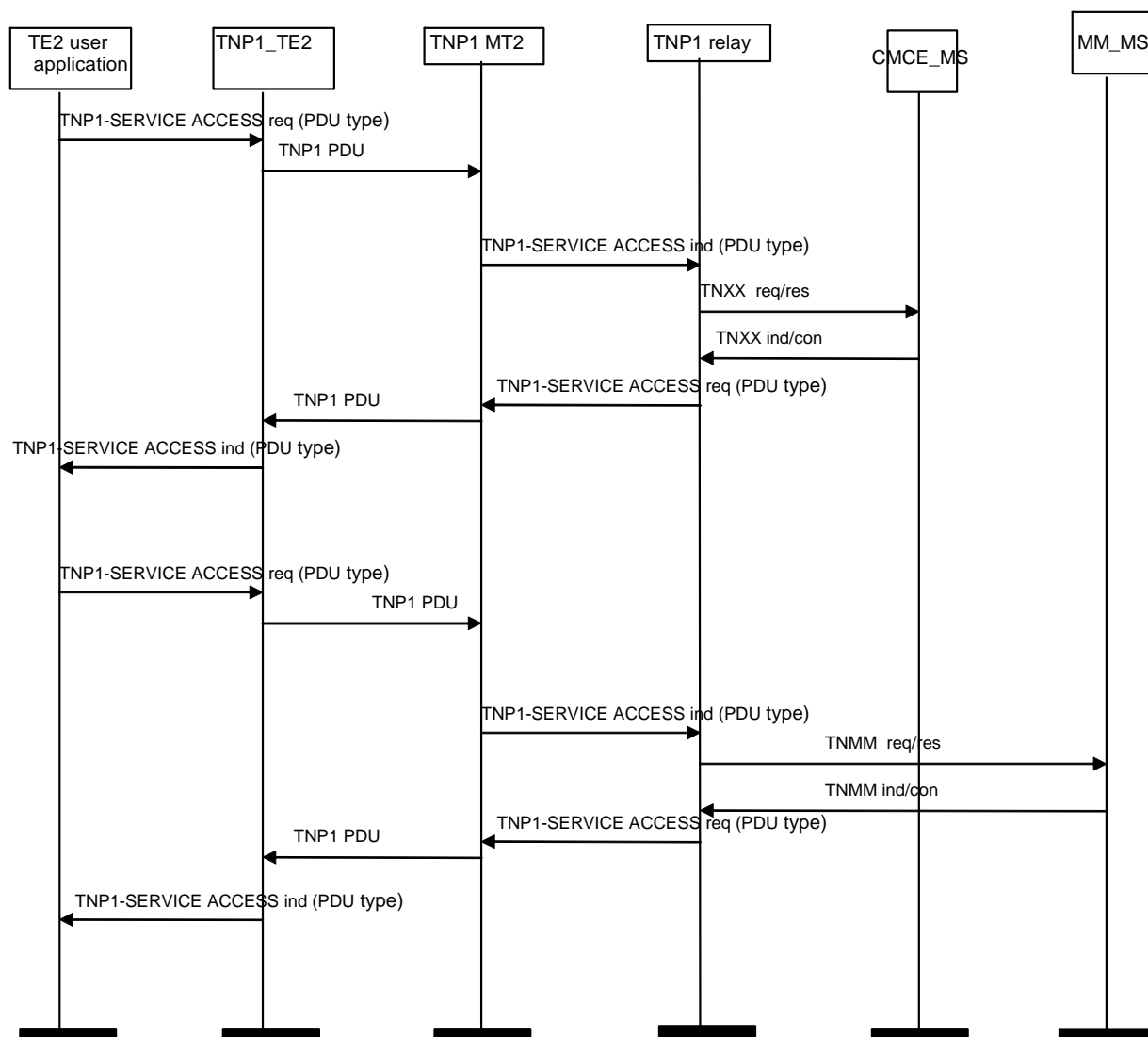

Figure 8.7: Accessing CMCE and MM services

The CC, SDS and MM procedures are defined in detail in clauses 14 and 15 of EN 300 392-2 [3].

8.1.9 Circuit mode data

Within the context of TNP1, circuit mode data is transmitted in-band using the TEMAC-UNITDATA PDU together with the TNP1-UNITDATA request and indication primitives. Flow control may be achieved using the TEMAC Flow Control PDUs.

8.1.10 Requesting a new PEI connection

In the TETRA 1 version of PEI, there is only one possible logical PEI connection at any given time between the TE2 and MT2, although it may be possible to have one or more simultaneous packet data connections - see clause 4.13. It is therefore possible to configure and maintain several packet data QoS contexts using the AT command set prior to entering the packet data state, but once in the packet data state the TNP1 must be used.

In TETRA 2, multiple independent logical PEI connections (PCONs) are possible. For TE2 applications wishing to use multiple connections, the TNP1 PDU TEMTA-NEW-PCON REQ/CTPCON AT command) is used (see figure 8.8). This results (in the successful case) in the MT2 assigning a new physical connection endpoint address in the TE2, which can then be used by the TE2 as an independent logical channel, or pipe. Note that the mechanism by which TE2 applications attach to a pipe using the endpoint address is platform dependent. Subsequent responses to requests made over the new pipe may be elected to be shared over the originating pipe dependent on the "share response flag" value in the originating request.

In this way, for example, an implementer may reserve the original PCON as a "control" channel, with dynamically created additional PCONs used as data channels.

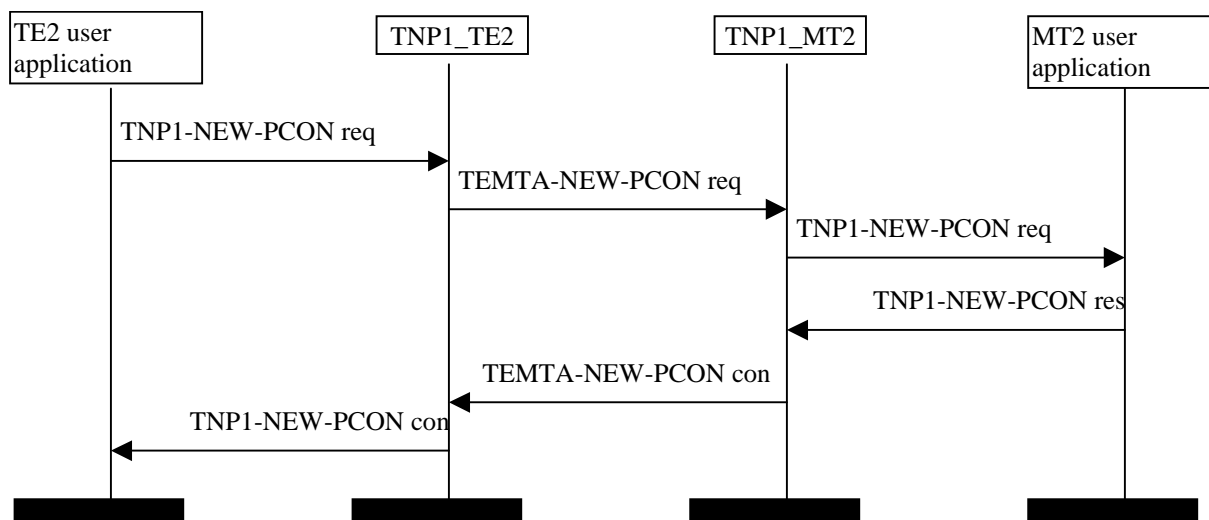

Figure 8.8: Requesting a new PEI connection (PCON)

8.2 Protocol timers

For MM and CMCE services and procedures, the timers defined in EN 300 392-2 [3] shall apply.

8.3 PDU structure

8.3.1 General on PDU structure

The boundaries of TNP1 PDUs are aligned to octet boundaries to ease handling and to be suitable for transmission over an underlying octet-oriented serial link.

Two length values are specified for each information element. The length in octets ($Length_8$) defines the number of octets that shall be reserved for the element. The length in bits ($Length_2$) defines the number of bits within the octets of the information element that are used for encoding the value carried by the element.

The generic TNP1 PDU layout shall be as defined in table 8.1.

Table 8.1: TNP1 PDU layout

Information element	Length ₂	Length ₈
PDU Group ID	8	1
PDU Type	8	1
Type 1 element (1)	Constant	Constant
Type 1 element (2)	Constant	Constant
etc.	etc.	etc.
Type 1 element (n)	Constant	Constant
P-bit	8	1
Type 2 element (1)	Constant	Constant
Type 2 element (2)	Constant	Constant
P-bit	8	1
etc.	etc.	etc.
P-bit	8	1
Type 2 element (n)	Constant	Constant
Type 3 element descriptor (1)	16	2
Type 3 element (1)	Varies	Varies
Type 3 element descriptor (2)	16	2
Type 3 element (2)	Varies	Varies
etc.	etc.	etc.
Type 3 element descriptor (n)	16	2
Type 3 element (n)	Varies	Varies

The first two information element of each PDU shall be the PDU GoupID and PDU Type, used for translation of the PDU as a request or response and to determine the peer entity for that request or response.

The PDU Type may be followed by a variable number of type 1, 2, 3 elements. Type 1 elements are either mandatory or conditional to a type 1 or type 2 element and shall be placed within the PDU in a fixed order as specified in the PDU description tables. Lengths of type 1 element are constant. Conditional elements are not marked by any type label, but follow rules of type 1. A conditional (type 1) element shall be present only as defined by the element on which it is conditional. When a type 2 element is not present, then all other elements conditional on it shall not be present.

Type 2 elements are optional and shall be placed within the PDU in a fixed order as specified in the PDU description tables. Lengths of type 2 elements are constant. The presence of a type 2 element is indicated with a Presence bit (P-bit) as defined in clause 8.3.3.

The type 1 and/or type 2 elements may be followed by a variable number of type 3 elements. A type 3 element is always preceded with a type 3 element descriptor that defines presence, type and length of the subsequent type 3 element. Type 3 Elements are optional and shall be normally placed at the PDU end in numerical order as specified within the type 3 element identifier. The presence of a type 3 element is indicated with a presence bit (M-bit) as defined in clause 8.3.4. Type 3 element coding can contain sub-elements, which can be either of type 1, 2 or 3.

Type 3 element descriptors are not shown in the PDU description tables, nor is their length taken into account in the PDU descriptions.

NOTE 1: The last existing information element whether type 1, 2 or 3 is not followed either by a P or M-bit, contrary to the air interface PDU encoding.

The octet and bit ordering within each information element shall be as defined in figure 8.9. When an information element contains more than one octet, the most significant octet (octet 1) containing the Most Significant Bit (MSB) b_n of the information element shall be transmitted first. The MSB of an information element can be any of the bits in that octet. If the MSB of the information element is not bit number 8, then all bits having a higher bit number shall be set to zero. The Least Significant Bit (LSB) b_1 of the information element shall be transmitted as the first bit of the least significant octet (octet n). The bits are numbered within each octet as defined in figure 8.9. The bit 1 of an octet shall be transmitted first.

NOTE 2: In the air interface the bits of an information element are in order from the most significant bit to the least significant bit and the most significant bit is sent first (closest to the beginning of the MAC slot).

8	7	6	5	4	3	2	1	Bit number
b_n (MSB)	b_{n-1}	b_{n-2}	b_{n-3}	b_{n-4}	b_{n-5}	b_{n-6}	b_{n-7}	Octet 1 (most significant octet)
...	etc.
b_{16}	b_{15}	b_{14}	b_{13}	b_{12}	b_{11}	b_{10}	b_9	Octet m-1
b_8	b_7	b_6	b_5	b_4	b_3	b_2	b_1 (LSB)	Octet m (least significant octet)

Figure 8.9: Octet and bit order in information elements of TNP1 PDUs

8.3.2 Structure and encoding of type 1 elements

Each type 1 Element has a fixed length within a PDU. The length of the type 1 Element ($Length_8$) in bytes is derived from the length of the associated information element ($Length_2$) with the following formula:

$$Length_8 = 1 + ((Length_2 - 1) \text{ div } 8)$$

The bits of the associated information element shall be right aligned to the octets of type 1 element, the least significant bit positioned to the bit 1 of the least significant octet. Unused bits of the most significant octet are set to zero.

NOTE 1: Conditional information elements are constructed as type 1 elements, but there is no type information in the PDU description.

NOTE 2: Some variable length information elements are indicated as type 1, when the construction is a Number of information elements followed by the constant length information elements.

8.3.3 Structure and encoding of type 2 elements

Each type 2 Element has a fixed length within a PDU. The length of the type 2 element ($Length_8$) in bytes is derived from the length of the associated information element ($Length_2$) with the following formula:

$$Length_8 = 2 + ((Length_2 - 1) \text{ div } 8)$$

The bits of the associated information element shall be right aligned to the octets of the type 2 element, the least significant bit positioned to the bit 1 of the least significant octet.

The presence of a valid value in the type 2 element is indicated with a Presence bit (P-bit). The P-Bit is positioned in the most significant bit of the most significant octet (b_n of the information element). The P-bit shall be set to "1" to indicate a present value and "0" to indicate a non-present value. Unused bits of the most significant octet are set to "0". Consequently the P-bit uses a whole octet and its value is either 128 or 0.

For a non-present type 2 element, the mapping shall result in $Length_8$ placeholder octet with all bits set to "0".

8.3.4 Structure and encoding of type 3 elements

A type 3 element is made up of three sub-elements; M bit, element identifier and length.

The M-bit, type 3 element identifier and Length Indicator (LI) of a type 3 element shall be mapped to a two-octet type 3 element descriptor preceding the information element itself, as depicted in figure 8.10.

8	7	6	5	4	3	2	1	bit	
M-bit	Type 3 element identifier					LI_{11}	LI_{10}	LI_9	Octet 1
LI_8	LI_7	LI_6	LI_5	LI_4	LI_3	LI_2	LI_1	Octet 2	

Figure 8.10: Structure of type 3 Element Identifier

The presence of a type 3 element is indicated with a more bit (M-bit) placed in bit 8 of octet 1. The M-bit shall be set to "1" if a type 3 element exists and to "0" if not.

If the M-bit is set to "0", then all other bits of the type 3 element descriptor shall be set to zero, too. Thus the length of type 3 element identifier is always 2 octets as shown in table 8.1 and in figure 8.10.

The type 3 element identifier can have one of four different sets of values, depending on the type of PDU in which it is contained. The four sets are CMCE, MM, MTA and SS.

The Length Indicator (LI) is an eleven-bit integer value defining the length of the subsequent type 3 element in bits. The most significant bit LI₁₁ of the Length Indicator is mapped in bit 3 of octet 1 and the least significant bit LI₁ in bit 1 of octet 2.

The length of the type 3 element user data in octets (Length₈) is derived from the length of the associated information element in bits (Length₂), using the following formula:

$$\text{Length}_8 = 1 + ((\text{Length}_2 - 1) \text{ div } 8)$$

The bits of the associated information element are right aligned to the octets of the type 3 element, the least significant bit positioned to the bit 1 of the least significant octet. Unused bits of the most significant octet are set to zero.

NOTE: The M-bit as such is redundant as the Length part of the type 3 element descriptor is set to a non-zero value, when the M-bit is "1" and to zero value, when the M-bit is "0".

Type 3 element coding of a PDU can contain sub-elements that can be either of type 1, 2 or 3. When sub-elements exist, the value of Length Indicator in associated type 3 element identifier shall be set to indicate the total number of bits contained in the octet-mapped sub-elements, i.e. the value of Length Indicator is the number of octets times 8.

8.3.5 Examples of PDU encoding

Table 8.2 gives an example of PDU encoding using the TECC-MODIFY IND PDU as defined in table 8.10.

Table 8.2: Example of TECC-MODIFY IND PDU contents

Information element	Length ₂	Length ₈	Type	C/O/M	PDU bits	Remarks
PDU Group ID	8	1	1	M	00001001	CC
PDU Type	8	1	1	M	00000111	TECC-MODIFY IND
Call handle	16	2	1	M	nnnnnnnn	Any
					nnnnnnnn	
					10000000	P-bit, optional element present
Basic service information	8	2	2	O	00010000	Speech, encr., pnt-to-pnt, one slot
					10000000	P-bit, optional element present
Simplex/duplex selection	1	1	2	O	10000000	Duplex requested
					00000000	P-bit, optional element not present
Call time-out	4	1	2	O		Empty, no bits
					10101000	M-bit, Optional element present,
					00010001	Proprietary, length 17 bits
Proprietary (data)			3	O	nnnnnnnn	Proprietary element owner, any
					00000001	Data "1 1111 1101" (right aligned)
					11111101	

In the example in the table 8.2 the total length of the PDU is 14 octets.

Table 8.3 gives an example of PDU encoding of the same PDU as in the table 8.2 in the case of no optional elements included.

NOTE: The example is given only for explanation of the PDU encoding. In normal use that PDU should have at least one optional element present.

Table 8.3: Example of TECC-MODIFY IND PDU contents without optional information elements

Information element	Length ₂	Length ₈	Type	C/O/M	PDU bits	Remarks
PDU Group ID	8	1	1	M	00001001	CC
PDU Type	8	1	1	M	00000111	TECC-MODIFY IND
Call handle	16	2	1	M	nnnnnnnn	Any
					nnnnnnnn	
					00000000	P-bit, optional element not present
Basic service information	8	2	2	O		Empty, no bits
					00000000	P-bit, optional element not present
Simplex/duplex selection	1	1	2	O		Empty, no bits
					00000000	P-bit, optional element not present
Call time-out	4	1	2	O		Empty, no bits
					00000000	M-bit, Optional type 3 element not present, length 0 bits
					00000000	Proprietary element owner, Empty
Proprietary (data)			3	O		Empty, no bits

The total length of the PDU in the table 8.3 is 9 octets.

8.4 TNP1 PDU descriptions

8.4.1 General on TNP1 PDU descriptions

The PDUs are designed to map easily onto the primitives defined in EN 300 392-2 [3] at the TNMM-SAP, TNCC-SAP, TNSDS-SAP and TNSDS-TL-SAP. The mapping is not exact, as some supplementary services fields have been added to the call control PDUs. Supplementary Services PDUs still exist for non-call related services.

In all the tables below the "length" column is left blank if the element is itself made up of other elements (i.e. is a structure). Sometimes the length of the structure is fixed and sometimes it is variable.

8.4.2 PDUs relating to CC

8.4.2.1 TECC-ALERT IND

This PDU shall be used to convey the parameters of TNCC-ALERT indication from MT2 to TE2 as defined in table 8.4.

Table 8.4: TECC-ALERT IND PDU contents

Information element	Length ₂	Length ₈	Type	C/O/M	Remarks
PDU Group ID	8	1	1	M	CC
PDU Type	8	1	1	M	TECC-ALERT IND
Call handle	16	2	1	M	
Call time-out, set-up phase	3	1	1	M	
Simplex/duplex selection	1	1	1	M	
Basic service information	8	2	2	O	see note
Call queued	1	1	2	O	
Notification indicator	6	1	2	O	
Facility			3	O	
Proprietary			3	O	
NOTE:	If different from requested.				

8.4.2.2 TECC-COMplete CON

This PDU shall be used to convey the parameters of TNCC-COMplete confirm from MT2 to TE2 as defined in table 8.5.

Table 8.5: TECC-COMplete CON PDU contents

Information element	Length ₂	Length ₈	Type	C/O/M	Remarks
PDU Group ID	8	1	1	M	CC
PDU Type	8	1	1	M	TECC-COMplete CON
Call handle	16	2	1	M	
Call time-out	4	1	1	M	
Transmission grant	2	1	1	M	
Transmission request permission	1	1	1	M	
Notification indicator	6	1	2	O	
Facility			3	O	
Proprietary			3	O	

8.4.2.3 TECC-COMplete IND

This PDU shall be used to convey the parameters of TNCC-COMplete indication from MT2 to TE2 as defined in table 8.6.

Table 8.6: TECC-COMplete IND PDU contents

Information element	Length ₂	Length ₈	Type	C/O/M	Remarks
PDU Group ID	8	1	1	M	CC
PDU Type	8	1	1	M	TECC-COMplete IND
Call handle	16	2	1	M	
Call time-out	4	1	1	M	
Transmission grant	2	1	1	M	
Transmission request permission	1	1	1	M	
Notification indicator	6	1	2	O	
Facility			3	O	
Proprietary			3	O	

8.4.2.4 TECC-COMplete REQ

This PDU shall be used to convey the parameters of TNCC-COMplete request from TE2 to MT2 as defined in table 8.7.

Table 8.7: TECC-COMplete REQ PDU contents

Information element	Length ₂	Length ₈	Type	C/O/M	Remarks
PDU Group ID	8	1	1	M	CC
PDU Type	8	1	1	M	TECC-COMplete REQ
Call handle	16	2	1	M	
Hook method selection	1	1	1	M	
Simplex/duplex selection	1	1	1	M	
Access priority	2	1	2	O	
Basic service information (offered)	8	2	2	O	
Traffic stealing	1	1	2	O	
Facility			3	O	
Proprietary			3	O	

8.4.2.5 TECC-DTMF IND

This PDU shall be used to convey the parameters of TNCC-DTMF indication from MT2 to TE2 as defined in table 8.8.

Table 8.8: TECC-DTMF IND PDU contents

Information element	Length ₂	Length ₈	Type	C/O/M	Remarks
PDU Group ID	8	1	1	M	CC
PDU Type	8	1	1	M	TECC-DTMF IND
Call handle	16	2	1	M	
DTMF tone delimiter	1	1	1	O	see note 1
DTMF result	1	1		C	see note 2
Number of DTMF digits	8	1		C	see note 3
DTMF digit				C	see notes 3 and 4
Proprietary			3	O	
NOTE 1: The time difference between "DTMF tone start" and "DTMF tone end" may not correspond to the tone duration at the originator.					
NOTE 2: Present when DTMF tone delimiter is not present.					
NOTE 3: Present when DTMF tone delimiter is present and set to "DTMF tone start".					
NOTE 4: This element shall be repeated according to the number of DTMF digits.					

8.4.2.6 TECC-DTMF REQ

This PDU shall be used to convey the parameters of TNCC-DTMF request from TE2 to MT2 as defined in table 8.9.

Table 8.9: TECC-DTMF REQ PDU contents

Information element	Length ₂	Length ₈	Type	C/O/M	Remarks
PDU Group ID	8	1	1	M	CC
PDU Type	8	1	1	M	TECC-DTMF REQ
Call handle	16	2	1	M	
DTMF tone delimiter	1	1	1	M	
Number of DTMF digits	8	1		C	see note 1
DTMF digit				C	see notes 1 and 2
Access priority	2	1	2	O	
Traffic stealing	1	1	2	O	
Proprietary			3	O	
NOTE 1: Present when the value of DTMF tone delimiter is "DTMF tone start".					
NOTE 2: This element shall be repeated according to the number of DTMF digits.					

8.4.2.7 TECC-MODIFY IND

This PDU shall be used to convey the parameters of TNCC-MODIFY indication from MT2 to TE2 as defined in table 8.10.

Table 8.10: TECC-MODIFY IND PDU contents

Information element	Length ₂	Length ₈	Type	C/O/M	Remarks
PDU Group ID	8	1	1	M	CC
PDU Type	8	1	1	M	TECC-MODIFY IND
Call handle	16	2	1	M	
Basic service information	8	2	2	O	
Simplex/duplex selection	1	1	2	O	
Call time-out	4	1	2	O	
Proprietary			3	O	

8.4.2.8 TECC-MODIFY REQ

This PDU shall be used to convey the parameters of TNCC-MODIFY request from TE2 to MT2 as defined in table 8.11.

Table 8.11: TECC-MODIFY REQ PDU contents

Information element	Length ₂	Length ₈	Type	C/O/M	Remarks
PDU Group ID	8	1	1	M	CC
PDU Type	8	1	1	M	TECC-MODIFY REQ
Call handle	16	2	1	M	
Access priority	2	1	2	O	
Basic service information	8	2	2	O	
Simplex/duplex selection	1	1	2	O	
Traffic stealing	1	1	2	O	
Proprietary			3	O	

8.4.2.9 TECC-NOTIFY IND

This PDU shall be used to convey the parameters of TNCC-NOTIFY indication from MT2 to TE2 as defined in table 8.12.

Table 8.12: TECC-NOTIFY IND PDU contents

Information element	Length ₂	Length ₈	Type	C/O/M	Remarks
PDU Group ID	8	1	1	M	CC
PDU Type	8	1	1	M	TECC-NOTIFY IND
Call handle	16	2	1	M	see note 1
Call status	3	1	2	O	
Call time-out, set-up phase	3	1	2	O	
Call time-out	4	1	2	O	
Call ownership	1	1	2	O	
Notification indicator	6	1	2	O	
Poll request	1	1	2	O	see note 2
Poll response percentage	6	1	2	O	see note 2
Poll response number	6	1	2	O	see note 2
Poll response addresses			3	O	see note 2
Facility			3	O	
Proprietary			3	O	
NOTE 1: If the message is sent connectionless the call handle shall be a dummy call handle.					
NOTE 2: Shall be valid for acknowledged group call only. Only one of these values is applicable in a service primitive.					

8.4.2.10 TECC-PROCEED IND

This PDU shall be used to convey the parameters of TNCC-PROCEED indication from MT2 to TE2 as defined in table 8.13.

Table 8.13: TECC-PROCEED IND PDU contents

Information element	Length ₂	Length ₈	Type	C/O/M	Remarks
PDU Group ID	8	1	1	M	CC
PDU Type	8	1	1	M	TECC-PROCEED IND
Call handle	16	2	1	M	
Basic service information	8	2	2	O	see note
Call status	3	1	2	O	
Hook method selection	1	1	2	O	
Simplex/duplex selection	1	1	2	O	
Notification indicator	6	1	2	O	
Facility			3	O	
Proprietary			3	O	

NOTE: If different from requested.

8.4.2.11 TECC-RELEASE CON

This PDU shall be used to convey the parameters of TNCC-RELEASE confirm from MT2 to TE2 as defined in table 8.14.

Table 8.14: TECC-RELEASE CON PDU contents

Information element	Length ₂	Length ₈	Type	C/O/M	Remarks
PDU Group ID	8	1	1	M	CC
PDU Type	8	1	1	M	TECC-RELEASE CON
Call handle	16	2	1	M	
Disconnect cause	5	1	1	M	
Disconnect status	2	1	1	M	
Notification indicator	6	1	2	O	
Facility			3	O	
Proprietary			3	O	

8.4.2.12 TECC-RELEASE IND

This PDU shall be used to convey the parameters of TNCC-RELEASE indication from MT2 to TE2 as defined in table 8.15.

Table 8.15: TECC-RELEASE IND PDU contents

Information element	Length ₂	Length ₈	Type	C/O/M	Remarks
PDU Group ID	8	1	1	M	CC
PDU Type	8	1	1	M	TECC-RELEASE IND
Call handle	16	2	1	M	
Disconnect cause	5	1	1	M	
Notification indicator	6	1	2	O	
Facility			3	O	
Proprietary			3	O	

8.4.2.13 TECC-RELEASE REQ

This PDU shall be used to convey the parameters of TNCC-RELEASE request from TE2 to MT2 as defined in table 8.16.

Table 8.16: TECC-RELEASE REQ PDU contents

Information element	Length ₂	Length ₈	Type	C/O/M	Remarks
PDU Group ID	8	1	1	M	CC
PDU Type	8	1	1	M	TECC-RELEASE REQ
Call handle	16	2	1	M	
Disconnect cause	5	1	1	M	
Disconnect type	2	1	1	M	
Traffic stealing	1	1	2	O	
Access priority	2	1	2	O	
Facility			3	O	
Proprietary			3	O	

8.4.2.14 TECC-SETUP CON

This PDU shall be used to convey the parameters of TNCC-SETUP confirm from MT2 to TE2 as defined in table 8.17.

Table 8.17: TECC-SETUP CON PDU contents

Information element	Length ₂	Length ₈	Type	C/O/M	Remarks
PDU Group ID	8	1	1	M	CC
PDU Type	8	1	1	M	TECC-SETUP CON
Call handle	16	2	1	M	
Basic service information	8	1	1	M	see note
Call time-out	4	1	1	M	
Hook method selection	1	1	1	M	
Transmission grant	2	1	1	M	
Transmission request permission	1	1	1	M	
Call ownership	1	1	1	M	
Call amalgamation	2	1	1	M	
Simplex/duplex selection	1	1	1	M	
Call priority	4	1	2	O	
Notification indicator	6	1	2	O	
Facility			3	O	
Proprietary			3	O	

NOTE: If different from requested.

8.4.2.15 TECC-SETUP IND

This PDU shall be used to convey the parameters of TNCC-SETUP indication from MT2 to TE2 as defined in table 8.18.

Table 8.18: TECC-SETUP IND PDU contents

Information element	Length ₂	Length ₈	Type	C/O/M	Remarks
PDU Group ID	8	1	1	M	CC
PDU Type	8	1	1	M	TECC-SETUP IND
Call handle	16	2	1	M	
Hook method selection	1	1	1	M	
Simplex/duplex selection	1	1	1	M	
Basic service information	8	1	1	M	
Transmission grant	2	1	1	M	
Transmission request permission	1	1	1	M	
Call priority	4	1	1	M	
Call time-out	4	1	1	M	
Called party type identifier	3	1	1	M	
Called party SSI	24	3		C	see note 1
Called party extension	24	3		C	see note 1
Calling party type identifier	2	1	2	O	
Calling party SSI	24	3		C	see note 2
Calling party extension	24	3		C	see note 2
External subscriber number (calling)	variable	variable	1	M	
CLIR control	2	1	2	O	
Notification indicator	6	1	2	O	
Facility			3	O	
Proprietary			3	O	
NOTE 1: Shall be conditional on the value of Called Party Type Identifier (CPTI):					
- CPTI = 0012; Called Party SSI;					
- CPTI = 0102; Called Party SSI + Called Party Extension.					
NOTE 2: Shall be conditional on the value of Calling Party Identifier (CGPTI):					
- CGPTI = 012; Calling Party SSI;					
- CGPTI = 102; Calling Party SSI + Calling Party Extension.					

8.4.2.16 TECC-SETUP REQ

This PDU shall be used to convey the parameters of TNCC-SETUP request from TE2 to MT2 as defined in table 8.19.

Table 8.19: TECC-SETUP REQ PDU contents

Information element	Length ₂	Length ₈	Type	C/O/M	Remarks
PDU Group ID	8	1	1	M	CC
PDU Type	8	1	1	M	TECC-SETUP REQ
Hook method selection	1	1	1	M	
Simplex/duplex selection	1	1	1	M	
Basic service information	8	1	1	M	
Request to transmit/send data	1	1	1	M	
Call priority	4	1	1	M	
Called party type identifier	3	1	1	M	SNA/SSI/TSI
Called party SNA	8	1		C	see note 1
Called party SSI	24	3		C	see note 1
Called party extension	24	3		C	see note 1
External subscriber number (called)	variable	variable	1	M	
Area selection	4	1	1	O	see note 2
Access priority	2	1	2	O	see note 3
Traffic stealing	1	1	2	O	see note 4
CLIR control	2	1	2	O	
Facility			3	O	
Proprietary			3	O	
NOTE 1: Shall be conditional on the value of Called Party Type Identifier (CPTI):					
- CPTI = 000 ₂ ; Called Party SNA;					
- CPTI = 001 ₂ ; Called Party SSI;					
- CPTI = 010 ₂ ; Called Party SSI + Called Party Extension.					
NOTE 2: If not used then the MT2 should use value "not defined".					
NOTE 3: If not used then the MT2 should use value "low priority".					
NOTE 4: If not used then the MT2 should use value "no stealing".					

8.4.2.17 TECC-SETUP RES

This PDU shall be used to convey the parameters of TNCC-SETUP response from TE2 to MT2 as defined in table 8.20.

Table 8.20: TECC-SETUP RES PDU contents

Information element	Length ₂	Length ₈	Type	C/O/M	Remarks
PDU Group ID	8	1	1	M	CC
PDU Type	8	1	1	M	TECC-SETUP RES
Call handle	14	2	1	M	
Hook method selection	1	1	1	M	
Simplex/duplex selection	1	1	2	O	
Basic service information	8	2	2	O	
Access priority	2	1	2	O	see note 1
Traffic stealing	1	1	2	O	see note 2
CLIR control	2	1	2	O	
Facility			3	O	
Proprietary			3	O	
NOTE 1: If not used then the MT2 should use value "low priority".					
NOTE 2: If not used then the MT2 should use value "no stealing".					

8.4.2.18 TECC-TX CON

This PDU shall be used to convey the parameters of TNCC-TX confirm from MT2 to TE2 as defined in table 8.21.

Table 8.21: TECC-TX CON PDU contents

Information element	Length ₂	Length ₈	Type	C/O/M	Remarks
PDU Group ID	8	1	1	M	CC
PDU Type	8	1	1	M	TECC-TX CON
Call handle	16	2	1	M	
Transmission status	2	1	1	M	
Transmission request permission	1	1	1	M	
End to end encryption flag	1	1	1	M	
Notification indicator	6	1	2	O	
Facility			3	O	
Proprietary			3	O	

8.4.2.19 TECC-TX IND

This PDU shall be used to convey the parameters of TNCC-TX indication from MT2 to TE2 as defined in table 8.22.

Table 8.22: TECC-TX IND PDU contents

Information element	Length ₂	Length ₈	Type	C/O/M	Remarks
PDU Group ID	8	1	1	M	CC
PDU Type	8	1	1	M	TECC-TX IND
Call handle	14	2	1	M	
Transmission status	2	1	1	M	
Transmission request permission	1	1	1	M	
End to end encryption flag	1	1	1	M	
Transmitting party type identifier	2	1	2	O	
Transmitting party SSI	24	3		C	see note
Transmitting party extension	24	3		C	see note
External subscriber number	variable	variable	1	M	
Notification indicator	6	1	2	O	
Facility			3	O	
Proprietary			3	O	
NOTE: Shall be conditional on the value of Transmitting Party Type Identifier (TPTI): TPTI = 012; Transmitting Party SSI; TPTI = 102; Transmitting Party SSI + Transmitting Party Extension.					

8.4.2.20 TECC-TX REQ

This PDU shall be used to convey the parameters of TNCC-TX request from TE2 to MT2 as defined in table 8.23.

Table 8.23: TECC-TX REQ PDU contents

Information element	Length ₂	Length ₈	Type	C/O/M	Remarks
PDU Group ID	8	1	1	M	CC
PDU Type	8	1	1	M	TECC-TX REQ
Call handle	16	2	1	M	
Transmission condition	1	1	1	M	
TX demand priority	2	1	2	M	
End to end encryption flag	1	1	2	M	
Access priority	2	1	2	O	see note 1
Traffic stealing	1	1	2	O	see note 2
Facility			3	O	
Proprietary			3	O	
NOTE 1: If not used then the MT2 should use value "low priority".					
NOTE 2: If not used then the MT2 should use value "no stealing".					

8.4.3 PDUs relating to circuit mode data

8.4.3.1 TEMAC-FLOW CONTROL PDU

This PDU shall be used to control circuit mode data rate between TE2 application and MT2 as defined in table 8.24.

The receiver of data shall transmit this PDU to limit the data to the number of blocks specified. Either the TE or the MT can use this but the MT will most likely use it as the air interface normally operates at a lower speed than the PEI.

Table 8.24: TEMAC-FLOW CONTROL PDU contents

Information element	Length ₂	Length ₈	Type	C/O/M	Remarks
PDU Group ID	8	1	1	M	Circuit mode traffic
PDU type	8	1	1	M	TEMAC-FLOW CONTROL
Max data	8	1	1	M	

8.4.3.2 TEMAC-UNITDATA

This PDU shall be used to transmit circuit mode data between TE2 application and MT2 as defined in table 8.25.

Table 8.25: TEMAC-UNITDATA PDU contents

Information element	Length ₂	Length ₈	Type	C/O/M	Remarks
PDU Group ID	8	1	1	M	Circuit mode traffic
PDU type	8	1	1	M	TEMAC-UNITDATA
Call identity	14	2	1	M	
Traffic stealing	1	1	1	M	
Circuit mode data				C	

8.4.4 PDUs relating to MM

8.4.4.1 General on MM PDUs

NOTE: TEMM-REGISTRATION PDUs are not recommended to be controlled by the TE application.

8.4.4.2 TEMM-ATTACH DETACH GROUP IDENTITY CON

This PDU shall be used to convey the parameters of TNMM-ATTACH DETACH GROUP IDENTITY confirm from MT2 to TE2 as defined in table 8.26.

Table 8.26: TEMM-ATTACH DETACH GROUP IDENTITY CON PDU contents

Information element	Length ₂	Length ₈	Type	C/O/M	Remarks
PDU Group ID	8	1	1	M	MM
PDU Type	8	1	1	M	TEMM-ATTACH DETACH GROUP IDENTITY CON
Attach detach request status	3	1	1	M	
Group identity attach/detach mode	1	1	1	M	
Number of groups	4	1	1	M	
Group identity downlink				C	see note
Group identity report	1	1	2	O	
Proprietary			3	O	

NOTE: Repeatable according to the Number of groups.

8.4.4.3 TEMM-ATTACH DETACH GROUP IDENTITY IND

This PDU shall be used to convey the parameters of TNMM-ATTACH DETACH GROUP IDENTITY indication from MT2 to TE2 as defined in table 8.27.

Table 8.27: TEMM-ATTACH DETACH GROUP IDENTITY IND PDU contents

Information element	Length ₂	Length ₈	Type	C/O/M	Remarks
PDU Group ID	8	1	1	M	MM
PDU Type	8	1	1	M	TEMM-ATTACH DETACH GROUP IDENTITY IND
Number of groups	4	1	1	M	
Group identity downlink				C	see note
Proprietary			3	O	

NOTE: Repeatable according to the Number of groups.

8.4.4.4 TEMM-ATTACH DETACH GROUP IDENTITY REQ

This PDU shall be used to convey the parameters of TNMM-ATTACH DETACH GROUP IDENTITY request from TE2 to MT2 as defined in table 8.28.

Table 8.28: TEMM-ATTACH DETACH GROUP IDENTITY REQ PDU contents

Information element	Length ₂	Length ₈	Type	C/O/M	Remarks
PDU Group ID	8	1	1	M	MM
PDU Type	8	1	1	M	TEMM-ATTACH DETACH GROUP IDENTITY REQ
Group identity attach/detach mode	1	1	1	M	
Number of groups	4	1	1	M	
Group identity uplink				C	see note
Group identity report	1	1	2	O	
Proprietary			3	O	

NOTE: Repeatable according to the Number of groups.

8.4.4.5 TEMM-DISABLING IND

This PDU shall be used to convey the parameters of TNMM-DISABLING indication from MT2 to TE2 as defined in table 8.29.

Table 8.29: TEMM-DISABLING IND PDU contents

Information element	Length ₂	Length ₈	Type	C/O/M	Remarks
PDU Group ID	8	1	1	M	MM
PDU Type	8	1	1	M	TEMM-DISABLING IND
Enable/disable status (for subscription)	2	1	1	M	
Enable/disable status (for equipment)	2	1	1	M	

8.4.4.6 TEMM-DEREGISTRATION REQ

This PDU shall be used to convey the parameters of TNMM-DEREGISTRATION request from TE2 to MT2 as defined in table 8.30.

Table 8.30: TEMM-DEREGISTRATION REQ PDU contents

Information element	Length ₂	Length ₈	Type	C/O/M	Remarks
PDU Group ID	8	1	1	M	MM
PDU Type	8	1	1	M	TEMM-DEREGISTRATION REQ
ISSI	24	3	2	O	
Address extension	24	3	2	O	

8.4.4.7 TEMM-ENABLING IND

This PDU shall be used to convey the parameters of TNMM-ENABLING indication from MT2 to TE2 as defined in table 8.31.

Table 8.31: TEMM-ENABLING IND PDU contents

Information element	Length ₂	Length ₈	Type	C/O/M	Remarks
PDU Group ID	8	1	1	M	MM
PDU Type	8	1	1	M	TEMM-ENABLING IND
Enable/disable status (for subscription)	2	1	1	M	
Enable/disable status (for equipment)	2	1	1	M	

8.4.4.8 TEMM-ENERGY SAVING CON

This PDU shall be used to convey the parameters of TNMM-ENERGY SAVING confirm from MT2 to TE2 as defined in table 8.32.

Table 8.32: TEMM-ENERGY SAVING CON PDU contents

Information element	Length ₂	Length ₈	Type	C/O/M	Remarks
PDU Group ID	8	1	1	M	MM
PDU Type	8	1	1	M	TEMM-ENERGY SAVING CON
Energy economy mode	3	1	1	M	
Energy economy mode status	1	1	1	M	

8.4.4.9 TEMM-ENERGY SAVING IND

This PDU shall be used to convey the parameters of TNMM-ENERGY SAVING indication from TE2 to MT2 as defined in table 8.33.

Table 8.33: TEMM-ENERGY SAVING IND PDU contents

Information element	Length ₂	Length ₈	Type	C/O/M	Remarks
PDU Group ID	8	1	1	M	MM
PDU Type	8	1	1	M	TEMM-ENERGY SAVING IND
Energy economy mode	3	1	2	O	
Energy economy mode status	1	1	2	O	

8.4.4.10 TEMM-ENERGY SAVING REQ

This PDU shall be used to convey the parameters of TNMM-ENERGY SAVING request from TE2 to MT2 as defined in table 8.34.

Table 8.34: TEMM-ENERGY SAVING REQ PDU contents

Information element	Length ₂	Length ₈	Type	C/O/M	Remarks
PDU Group ID	8	1	1	M	MM
PDU Type	8	1	1	M	TEMM-ENERGY SAVING REQ
Energy economy mode	3	1	1	M	

8.4.4.11 TEMM-REPORT IND

This PDU shall be used to convey the parameters of TNMM-REPORT indication from MT2 to TE2 as defined in table 8.35.

Table 8.35: TEMM-REPORT IND PDU contents

Information element	Length ₂	Length ₈	Type	C/O/M	Remarks
PDU Group ID	8	1	1	M	MM
PDU Type	8	1	1	M	TEMM-REPORT IND
MM transfer result	1	1	1	M	

8.4.4.12 TEMM-REGISTRATION CON

This PDU shall be used to convey the parameters of TNMM-REGISTRATION confirm from MT2 to TE2 as defined in table 8.36.

Table 8.36: TEMM-REGISTRATION CON PDU contents

Information element	Length ₂	Length ₈	Type	C/O/M	Remarks
PDU Group ID	8	1	1	M	MM
PDU Type	8	1	1	M	TEMM-REGISTRATION CON
Registration status	1	1	1	M	
Registration reject cause	5	1		C	see note 1
LA (where registered)	14	2	1	M	
MCC (where registered)	10	2	1	M	
MNC (where registered)	14	2	1	M	
Number of groups	4	1	1	M	
Group identity downlink				C	see note 2
Energy economy mode	3	1	2	O	
Energy economy mode status	1	1	2	O	
Group identity attach/detach mode	1	1	2	O	
NOTE 1: Shall be present if "Registration status" = Failure.					
NOTE 2: Shall be repeated according to the Number of groups.					

8.4.4.13 TEMM-REGISTRATION IND

This PDU shall be used to convey the parameters of TNMM-REGISTRATION indication from MT2 to TE2 as defined in table 8.37.

Table 8.37: TEMM-REGISTRATION IND PDU contents

Information element	Length ₂	Length ₈	Type	C/O/M	Remarks
PDU Group ID	8	1	1	M	MM
PDU Type	8	1	1	M	TEMM-REGISTRATION IND
Registration status	2	1	1	M	
Registration reject cause	5	1		C	see note 1
LA (where registered)	14	2	1	M	
MCC (where registered)	10	2	1	M	
MNC (where registered)	14	2	1	M	
Number of groups	4	1	1	M	
Group identity downlink				C	see note 2
Group identity attach/detach mode	1	1	2	O	
NOTE 1: Shall be present "if Registration "status = Failure.					
NOTE 2: Shall be repeated according to the Number of groups.					

8.4.4.14 TEMM-REGISTRATION REQ

This PDU shall be used to convey the parameters of TNMM-REGISTRATION request from TE2 to MT2 as defined in table 8.38.

Table 8.38: TEMM-REGISTRATION REQ PDU contents

Information element	Length ₂	Length ₈	Type	C/O/M	Remarks
PDU Group ID	8	1	1	M	MM
PDU Type	8	1	1	M	TEMM-REGISTRATION REQ
Registration type	2	1	1	M	
ISSI	24	3	1	M	
MCC (of the ISSI)	10	2	1	M	
MNC (of the ISSI)	14	2	1	M	
Number of groups	4	1	1	M	
Group identity uplink				C	see note 1
Preferred LA list			2	O	see note 2
Preferred MCC list			2	O	see note 3
Preferred MNC list			2	O	see note 3
Energy economy mode	3	1	2	O	
Group identity attach/detach mode	1	1	2	O	
NOTE 1: Shall be repeatable as the number of groups.					
NOTE 2: Shall be used if Registration Type = "No new ITSI - forward registration".					
NOTE 3: Shall be used if Registration Type = "New ITSI"; or Registration Type = "No new ITSI - forward registration".					

8.4.4.15 TEMM-SERVICE IND

This PDU shall be used to convey the parameters of TNMM-SERVICE indication from MT2 to TE2 as defined in table 8.39.

Table 8.39: TEMM-SERVICE IND PDU contents

Information element	Length ₂	Length ₈	Type	C/O/M	Remarks
PDU Group ID	8	1	1	M	MM
PDU Type	8	1	1	M	TEMM-SERVICE IND
Service status	2	1	1	M	
Enable/disable status	3	1	1	M	

8.4.4.16 TEMM-SERVICE REQ

This PDU shall be used to request the service status information from TE2 to MT2 as defined in table 8.40.

Table 8.40: TEMM-SERVICE REQ PDU contents

Information element	Length ₂	Length ₈	Type	C/O/M	Remarks
PDU Group ID	8	1	1	M	MM
PDU Type	8	1	1	M	TEMM-SERVICE REQ

8.4.4.17 TEMM-STATUS IND

This PDU shall be used to convey the parameters of TNMM-STATUS indication from MT2 to TE2 as defined in table 8.41.

Table 8.41: TEMM-STATUS IND PDU contents

Information element	Length ₂	Length ₈	Type	C/O/M	Remarks
PDU Group ID	8	1	1	M	MM
PDU Type	8	1	1	M	TEMM-STATUS IND
Service status	2	1	1	M	
Enable/disable status	3	1	1	M	
Dual watch	4	1	2	O	
Energy economy mode	3	1	2	O	see note
NOTE: Applicable with the dual watch parameter.					

8.4.4.18 TEMM-STATUS CON

This PDU shall be used to convey the parameters of TNMM-STATUS confirm from MT2 to TE2 as defined in table 8.42.

Table 8.42: TEMM-STATUS CON PDU contents

Information element	Length ₂	Length ₈	Type	C/O/M	Remarks
PDU Group ID	8	1	1	M	MM
PDU Type	8	1	1	M	TEMM-STATUS CON
Dual watch	4	1	2	O	
Energy economy mode	3	1	2	O	see note
NOTE: Applicable with the dual watch parameter.					

8.4.4.19 TEMM-STATUS REQ

This PDU shall be used to convey the parameters of TNMM-STATUS request from TE2 to MT2 as defined in table 8.43.

Table 8.43: TEMM-STATUS REQ PDU contents

Information element	Length ₂	Length ₈	Type	C/O/M	Remarks
PDU Group ID	8	1	1	M	MM
PDU Type	8	1	1	M	TEMM-STATUS REQ
Direct mode	1	1	2	O	
Dual watch	4	1	2	O	
Energy economy mode	3	1	2	O	see note
NOTE: Applicable with the dual watch parameter.					

8.4.5 MT Application PDUs

8.4.5.1 TEMTA-SERVICES CAPABILITY RESP

This PDU shall be used to convey the parameters of TNP1- SERVICES CAPABILITY response from MT2 to TE2 as defined in table 8.44.

Table 8.44: TEMTA-SERVICES CAPABILITY RESP PDU contents

Information element	Length ₂	Length ₈	Type	C/O/M	Remarks
PDU Group ID	8	1	1	M	MT2 application
PDU Type	8	1	1	M	TEMTA-SERVICES CAPABILITY RESP
Circuit mode and MS services	24	3	1	M	
Security			1	M	
SDS mode services		4	1	M	
Packet mode services	4	1	1	M	
Reserved	8	1	1	M	
Proprietary			3	O	
NOTE: Reserved for future indication of capabilities (e.g. transaction protocol).					

8.4.5.2 TEMTA-SDS-TL CAPABILITY RESP

This PDU shall be used to convey the parameters of TNP1- SDS-TL CAPABILITY response from MT2 to TE2 as defined in table 8.45.

Table 8.45: TEMTA-SDS-TL CAPABILITY RESP PDU contents

Information element	Length ₂	Length ₈	Type	C/O/M	Remarks
PDU Group ID	8	1	1	M	MT2 application
PDU Type	8	1	1	M	TEMTA-SDS-TL CAPABILITY RESP
SDS-TL service capability	1	1	1	M	
SDS-TL Service centre capability	1	1		C	see note 1
Store and forward PDU capability	3	1		C	see notes 1 and 2
SDS-TL service centre default address				C	see notes 1 and 2
Proprietary			3	O	
NOTE 1: Shall be present if the "SDS-TL service capability" is "Capable".					
NOTE 2: Shall be present if the "SDS-TL Service centre capability" is "Capable".					

8.4.5.3 TEMTA-SERVICES CAPABILITY REQ

This PDU shall be used to convey the parameters of TNP1-SERVICES CAPABILITY request from TE2 to MT2 as defined in table 8.46.

Table 8.46: TEMTA-SERVICES CAPABILITY REQ PDU contents

Information element	Length ₂	Length ₈	Type	C/O/M	Remarks
PDU Group ID	8	1	1	M	MT2 application
PDU Type	8	1	1	M	TEMTA-SERVICES CAPABILITY REQ

8.4.5.4 TEMTA-SDS-TL CAPABILITY REQ

This PDU shall be used to convey the parameters of TNP1- SDS-TL CAPABILITY request from TE2 to MT2 as defined in table 8.47.

Table 8.47: TEMTA-SDS-TL CAPABILITY REQ PDU contents

Information element	Length ₂	Length ₈	Type	C/O/M	Remarks
PDU Group ID	8	1	1	M	MT2 application
PDU Type	8	1	1	M	TEMTA-SDS-TL CAPABILITY REQ

8.4.5.5 TEMTA-IDENTITIES RES

This PDU shall be used to convey the identities information elements from the MT2 to TE2 as defined in table 8.48.

Table 8.48: TEMTA-IDENTITIES RES PDU contents

Information element	Length ₂	Length ₈	Type	C/O/M	Remarks
PDU Group ID	8	1	1	M	MT2 application
PDU Type	8	1	1	M	TEMTA-IDENTITIES RES
ITSI			1	M	
Number of static groups	4	1	1	M	
GTSI				C	see note 1
Number of dynamic groups	8	1	1	M	
GTSI				C	see note 2
More information flag	1	1	1	M	see note 3
NOTE 1: Shall be repeated as defined by the number of static groups.					
NOTE 2: Shall be repeated as defined by the number of dynamic groups.					
NOTE 3: If this flag is set to "yes" the TE shall not send any more commands until all identities have been returned by the MT (flag set to "no").					

8.4.5.6 TEMTA- IDENTITIES REQ

This PDU shall be used to request the identities information elements from the MT2 as defined in table 8.49.

Table 8.49: TEMTA-IDENTITIES REQ PDU contents

Information element	Length ₂	Length ₈	Type	C/O/M	Remarks
PDU Group ID	8	1	1	M	MT2 application
PDU Type	8	1	1	M	TEMTA- IDENTITIES REQ

8.4.5.7 TEMTA-SETVOLUME REQ

This PDU shall be used to control the volume setting from the TE2 as defined in table 8.50.

Table 8.50: TEMTA-SETVOLUME REQ PDU contents

Information element	Length ₂	Length ₈	Type	C/O/M	Remarks
PDU Group ID	8	1	1	M	MT2 application
PDU Type	8	1	1	M	TEMTA-SETVOLUME REQ
Volume level	6	1	1	M	

8.4.5.8 TEMTA-SPEAKER-MIC REQ

This PDU shall be used to control the speaker/microphone from the TE2 as defined in table 8.51.

Table 8.51: TEMTA-SETVOLUME REQ PDU contents

Information element	Length ₂	Length ₈	Type	C/O/M	Remarks
PDU Group ID	8	1	1	M	MT2 application
PDU Type	8	1	1	M	TEMTA-SPEAKER-MIC REQ
Speaker on off	1	1	2	O	
Microphone on off	1	1	2	O	

8.4.5.9 TEMTA-SYSINFO RESP

This PDU shall be used to convey the Sysinfo information elements from the MT2 to TE2 as defined in table 8.52.

Table 8.52: TEMTA-SYSINFO RESP PDU contents

Information element	Length ₂	Length ₈	Type	C/O/M	Remarks
PDU Group ID	8	1	1	M	MT2 application
PDU Type	8	1	1	M	TEMTA-SYSINFO RESP
Security information	8	1	1	M	
BS service details	12	2	1	M	

NOTE: The MT will send this PDU on TE request or on any change in the broadcast information.

8.4.5.10 TEMTA-SYSINFO REQ

This PDU shall be used to request the Sysinfo information elements from the TE2 to MT2 as defined in table 8.53.

Table 8.53: TEMTA-SYSINFO REQ PDU contents

Information element	Length ₂	Length ₈	Type	C/O/M	Remarks
PDU Group ID	8	1	1	M	MT2 application
PDU Type	8	1	1	M	TEMTA-SYSINFO REQ

8.4.5.11 TEMTA-IDENTIFICATION RES

This PDU shall be used to convey the parameters of TNP1-IDENTIFICATION response from MT2 to TE2 as defined in table 8.54.

Table 8.54: TEMTA-IDENTIFICATION RES PDU contents

Information element	Length ₂	Length ₈	Type	C/O/M	Remarks
PDU Group ID	8	1	1	M	MT2 application
PDU type	8	1	1	M	TEMTA-IDENTIFICATION RES
Terminal equipment identity	60	8	1	M	
Manufacturer Identifier			3	M	
Model			3	M	
Software version			3	M	
Hardware version			3	O	
Product serial number			3	O	
ISO global object ID			3	O	
TNP1 protocol version			3	O	
TNP1 release			3	O	note
Proprietary			3	O	
NOTE: The TNP1 release shall inform the TE2 user application about the MT2 TNP1 release. Contents of this information element is not be restricted by the standard (every manufacture can use this field for his purposes).					

8.4.5.12 TEMTA-IDENTIFICATION REQ

This PDU shall be used to convey the parameters of TNP1-IDENTIFICATION request from TE2 to MT2 as defined in table 8.55.

Table 8.55: TEMTA-IDENTIFICATION REQ PDU contents

Information element	Length ₂	Length ₈	Type	C/O/M	Remarks
PDU Group ID	8	1	1	M	MT2 application
PDU Type	8	1		M	TEMTA-IDENTIFICATION REQ

8.4.5.13 TEMTA-SDS STACK MESSAGES

8.4.5.13.1 General on TEMA-SDS stack messages

All incoming/outgoing SDS messages (from/to the air interface) may be stored on a message stack in the MT. There are two stacks, as defined in TS 127 007 [9], one for Status, SDSS type 1/2/3 and another for SDS4 messages.

Each stack should have 255 entries, each of which has the following fields:

SDS type - Status, SDS type 1/2/3/4

SDS message format in the SDS stacks, as described in TS 127 007 [9], clause 10.3.42 (for SDS4) and in clause 10.3.41 (for SDS status/1/2/3).

8.4.5.13.2 TEMTA-SDS DELETE MESSAGES

This PDU shall be used to delete from an MT2 a list of SDS messages in the SDS message stack as defined in table 8.56.

Table 8.56: TEMTA-SDS DELETE MESSAGES REQ PDU contents

Information element	Length ₂	Length ₈	Type	C/O/M	Remarks
PDU Group ID	8	1	1	M	MT2 application
PDU Type	8	1	1	M	TEMTA-SDS DELETE MESSAGES
SDS type	3	1	1	M	
Number of messages	8	1	1	M	
Message index	16	1		C	see notes 1 and 2
NOTE 1: Shall be repeated as defined by the number of messages to be deleted.					
NOTE 2: The index is a record for each message that will be used to point to the SDS message in the stack.					

8.4.5.13.3 TEMTA-SDS MESSAGE ERROR

This PDU shall be a response from the MT2 to SDS message error in the SDS message stack as defined in table 8.57.

Table 8.57: TEMTA-SDS MESSAGE ERROR PDU contents

Information element	Length ₂	Length ₈	Type	C/O/M	Remarks
PDU Group ID	8	1	1	M	MT2 application
PDU Type	8	1	1	M	TEMTA-SDS MESSAGE ERROR
SDS type	3	1	1	M	
Message index	16	1	1	M	see note
SDS error	3	1	1	M	see note
NOTE: This message shall be used as a response to Request message if the request is not valid.					

8.4.5.13.4 TEMTA-SDS MESSAGES IND

This PDU shall be used to convey an SDS message in the SDS message stack from MT2 to TE2 as defined in table 8.58.

Table 8.58: TEMTA-SDS MESSAGE IND PDU contents

Information element	Length ₂	Length ₈	Type	C/O/M	Remarks
PDU Group ID	8	1	1	M	MT2 application
PDU Type	8	1	1	M	TEMTA-SDS MESSAGE IND
SDS type	3	1	1	M	
SDS or SDS-TL data message				M	see note
NOTE: The format shall be as described in TS 127 007 [9], clause 10.3.42 for SDS4 and in clause 10.3.41 for SDS status/1/2/3.					

8.4.5.13.5 TEMTA-SDS MESSAGE REQ

This PDU shall be used to request from a MT2 an SDS message in the SDS message stack as defined in table 8.59.

Table 8.59: TEMTA-SDS MESSAGE REQ PDU contents

Information element	Length ₂	Length ₈	Type	C/O/M	Remarks
PDU Group ID	8	1	1	M	MT2 application
PDU Type	8	1	1	M	TEMTA-SDS MESSAGE REQ
SDS type	3	1	1	M	
Message index	16	1	1	M	

8.4.5.13.6 TEMTA-SDS GET LIST BY KEY MESSAGES

This PDU is used to access to SDS messages that are satisfied to given key(s) as defined in table 8.60. As a result a list of indexes of the relevant messages will be sent to the application.

Table 8.60: TEMTA-SDS MESSAGE GET LIST MESSAGES PDU contents

Information element	Length ₂	Length ₈	Type	C/O/M	Remarks
PDU Group ID	8	1	1	M	MT2 application
PDU Type	8	1	1	M	TEMTA-SDS MESSAGE GET LIST MESSAGES
Key mask	4	1	1	M	
SDS type	3	1		C	see note
SDS message status	3	1		C	see note
NOTE: Shall be conditional on the value of key mask information element.					

8.4.5.13.7 TEMTA-SDS LIST MESSAGES REPLY

This PDU shall be used as a reply to delete request or to get list messages as defined in table 8.61. The SDS message identity shall contain all the deleted messages with their new status.

Table 8.61: TEMTA-SDS LIST MESSAGES REPLY PDU contents

Information element	Length ₂	Length ₈	Type	C/O/M	Remarks
PDU Group ID	8	1	1	M	MT2 application
PDU Type	8	1	1	M	TEMTA-SDS LIST MESSAGES REPLY
Number of messages	8	1	1	M	
Message index	16	1	1	M	see note
SDS message status	3	1	1	M	see note
SDS type	3	1	1	M	see note
NOTE: Shall be repeated as defined by the number of messages information element.					

8.4.5.13.8 TEMTA-SDS NOTIFICATION

This PDU shall be used as a notification to the user application about "message stack full" or a downlink message was received in the message stack, as defined in table 8.62.

Table 8.62: TEMTA-SDS NOTIFICATION PDU contents

Information element	Length ₂	Length ₈	Type	C/O/M	Remarks
PDU Group ID	8	1	1	M	MT2 application
PDU Type	8	1	1	M	TEMTA-SDS NOTIFICATION
SDS type	3	1	1	M	note
SDS notification	1	1	1	M	
NOTE: The SDS type is used to indicate the appropriate stack.					

8.4.5.14 TEMTA-XXX SERVICE PROFILE RES

This PDU shall be used to convey the parameters of TNP1-XXX SERVICE PROFILE response from MT2 to TE2 as defined in tables 8.63, 8.64, 8.65 and 8.66.

Table 8.63: TEMTA-SDS SERVICE PROFILE RES PDU contents

Information element	Length ₂	Length ₈	Type	C/O/M	Remarks
PDU Group ID	8	1	1	M	MT2 application
PDU Type	8	1	1	M	TEMTA-XXX SERVICE PROFILE RES
Service profile request result	2	1	1	M	
SDS profile type	8	1	1	M	
SDS status profile				C	see note
SDS user data 1 profile				C	see note
SDS user data 2 profile				C	see note
SDS user data 3 profile				C	see note
NOTE: Conditional on SDS profile type.					

Table 8.64: TEMTA-CC SERVICE PROFILE RES PDU contents

Information element	Length ₂	Length ₈	Type	C/O/M	Remarks
PDU Group ID	8	1	1	M	MT2 application
PDU Type	8	1	1	M	TEMTA-CC SERVICE PROFILE RES
Service profile request result	2	1	1	M	
CC profile			1	M	

Table 8.65: TEMTA-MM SERVICE PROFILE RES PDU contents

Information element	Length ₂	Length ₈	Type	C/O/M	Remarks
PDU Group ID	8	1	1	M	MT2 application
PDU Type	8	1	1	M	TEMTA-MM SERVICE PROFILE RES
Service profile request result	2	1	1	M	
MM profile			1	M	

Table 8.66: TEMTA-SDS-TL SERVICE PROFILE RESP PDU contents

Information element	Length ₂	Length ₈	Type	C/O/M	Remarks
PDU Group ID	8	1	1	M	MT2 application
PDU Type	8	1	1	M	TEMTA-SDS-TL SERVICE PROFILE RES
Protocol identifier kind	1	1	1	M	
Protocol identifier	8	1	1	M	
Service profile request result	2	1	1	M	
SDS user data 4 profile				M	

8.4.5.15 TEMTA-XXX SERVICE PROFILE REQ

These PDUs shall be used to request the parameters of TNP1-XXX SERVICE PROFILE from TE2 to MT2 as defined in tables 8.67, 8.68, 8.69 and 8.70.

Table 8.67: TEMTA-SDS SERVICE PROFILE REQ PDU contents

Information element	Length ₂	Length ₈	Type	C/O/M	Remarks
PDU Group ID	8	1	1	M	MT2 application
PDU Type	8	1	1	M	TEMTA-SDS SERVICE PROFILE REQ
SDS profile type	8	1	1	M	

Table 8.68: TEMTA-CC SERVICE PROFILE REQ PDU contents

Information element	Length ₂	Length ₈	Type	C/O/M	Remarks
PDU Group ID	8	1	1	M	MT2 application
PDU Type	8	1	1	M	TEMTA-CC SERVICE PROFILE REQ

Table 8.69: TEMTA-MM SERVICE PROFILE REQ PDU contents

Information element	Length ₂	Length ₈	Type	C/O/M	Remarks
PDU Group ID	8	1	1	M	MT2 application
PDU Type	8	1	1	M	TEMTA-MM SERVICE PROFILE REQ

Table 8.8.70: TEMTA-SDS-TL SERVICE PROFILE REQ PDU contents

Information element	Length ₂	Length ₈	Type	C/O/M	Remarks
PDU Group ID	8	1	1	M	MT2 application
PDU Type	8	1	1	M	TEMTA-SDS-TL SERVICE PROFILE REQ
Protocol identifier kind	1	1	1	M	
Protocol identifier	8	1	1	M	

8.4.5.16 TEMTA-XXX SERVICE PROFILE SET

This PDU shall be used to convey the parameters of TNP1-XXX SERVICE PROFILE request from TE2 to MT2 as defined in tables 8.71, 8.72, 8.73 and 8.74.

Table 8.71: TEMTA-SDS SERVICE PROFILE SET PDU contents

Information element	Length ₂	Length ₈	Type	C/O/M	Remarks
PDU Group ID	8	1	1	M	MT2 application
PDU Type	8	1	1	M	TEMTA-XXX SERVICE PROFILE SET
SDS profile type	8	1	1	M	
Set profile request	8	1	1	M	
SDS status profile				C	see note
SDS user data 1 profile				C	see note
SDS user data 2 profile				C	see note
SDS user data 3 profile				C	see note

NOTE: Conditional on SDS profile type and set profile request.

Table 8.72: TEMTA-CC SERVICE PROFILE SET PDU contents

Information element	Length ₂	Length ₈	Type	C/O/M	Remarks
PDU Group ID	8	1	1	M	MT2 application
PDU Type	8	1	1	M	TEMTA-CC SERVICE PROFILE SET
Set profile request	8	1	1	M	
CC profile				C	see note

NOTE: Conditional on set profile request.

Table 8.73: TEMTA-MM SERVICE PROFILE SET PDU contents

Information element	Length ₂	Length ₈	Type	C/O/M	Remarks
PDU Group ID	8	1	1	M	MT2 application
PDU Type	8	1	1	M	TEMTA-MM SERVICE PROFILE SET
Set profile request	8	1	1	M	
MM profile				C	see note

NOTE: Conditional on set profile request.

Table 8.74: TEMTA-SDS-TL SERVICE PROFILE SET PDU contents

Information element	Length ₂	Length ₈	Type	C/O/M	Remarks
PDU Group ID	8	1	1	M	MT2 application
PDU Type	8	1	1	M	TEMTA-SDS-TL SERVICE PROFILE SET
Protocol identifier kind	1	1	1	M	
Protocol identifier	8	1	1	M	
Set profile request	8	1	1	M	
SDS user data 4 profile				C	see note

NOTE: Conditional on set profile request.

8.4.5.17 TEMTA-STATE RES

This PDU shall be used to convey the parameters of TNP1-STATE response from MT2 to TE2 as defined in table 8.75.

Table 8.75: TEMTA-STATE RES PDU contents

Information element	Length ₂	Length ₈	Type	C/O/M	Remarks
PDU Group ID	8	1	1	M	MT2 application
PDU Type	8	1	1	M	TEMTA-STATE RES
Field Strength	7	1	1	M	
Bit error ratio	8	1	1	M	
Battery charge	7	1	2	O	
Internal temperature	16	8	2	O	
Over temperature indication	1	1	2	O	
Proprietary			3	O	

8.4.5.18 TEMTA-STATE REQ

This PDU shall be used to convey the parameters of TNP1-STATE request from TE2 to MT2 as defined in table 8.76.

Table 8.76: TEMTA-STATE REQ PDU contents

Information element	Length ₂	Length ₈	Type	C/O/M	Remarks
PDU Group ID	8	1	1	M	MT2 application
PDU Type	8	1	1	M	TEMTA-STATE REQ

8.4.5.19 TEMTA-REPORT IND

This PDU shall be used to convey the parameters of TNP1-REPORT primitive from either the TE2 to MT2 or vice versa, as defined in table 8.77.

Table 8.77: TEMTA-REPORT IND PDU contents

Information element	Length ₂	Length ₈	Type	C/O/M	Remarks
PDU Group ID	8	1	1	M	MT2 application
PDU Type	8	1	1	M	TEMTA-REPORT IND
Report reason	8	1	1	M	
PDU type	16	2	1	M	note
NOTE:	This information element shall contain the PDU type of the unrecognized, received PDU, to which this message is the reply.				

Neither TE nor MT shall send more than two successive failure reports. In this event it is considered the link, applications or DLL are not working and the link shall be declared as failed.

8.4.5.20 TEMTA-NEW-PCON REQ

This PDU shall be used to convey the parameters of TEMTA-NEW-PCON request from TE2 to MT2 as defined in table 8.78.

Table 8.78: TEMTA-NEW-PCON REQ PDU contents

Information element	Length ₂	Length ₈	Type	C/O/M	Remark
PDU GroupID	8	1	1	M	MT2 application
PDU type	8	1	1	M	TEMTA-NEW-PCON REQ
Share response flag	1	1	1	M	

8.4.5.21 TEMTA-NEW-PCON CON

This PDU shall be used to convey the parameters of TEMTA-NEW-PCON confirmation from MT2 to TE2 as defined in table 8.79.

Table 8.79: TEMTA-NEW-PCON CON PDU contents

Information element	Length ₂	Length ₈	Type	C/O/M	Remark
PDU GroupID	8	1	1	M	MT2 application
PDU type	8	1	1	M	TEMTA-NEW-PCON CON
PCON result	1	1	1	M	
Device address	32	4		C	See note
Endpoint address	32	4		C	See note
NOTE: Only included if PCON result is successful.					

8.4.6 PDUs relating to SDS

8.4.6.1 General on SDS PDUs

These SDS PDUs are used to convey information TE2 and TNSDS service access point in the MT2. For an SDS message stack support TEMTA PDUs are defined in clause 8.4.5.13.

8.4.6.2 TESDS-REPORT IND

This PDU shall be used to convey the parameters of TNSDS-REPORT indication from MT2 to TE2 as defined in table 8.80.

Table 8.80: TESDS-REPORT IND PDU contents

Information element	Length ₂	Length ₈	Type	C/O/M	Remarks
PDU Group ID	8	1	1	M	SDS
PDU Type	8	1	1	M	TESDS-REPORT IND
SDS transfer result	8	1	1	M	
User application reference	8	1	1	M	

8.4.6.3 TESDS-STATUS IND

This PDU shall be used to convey the parameters of TNSDS-STATUS indication from MT2 to TE2 as defined in table 8.81.

Table 8.81: TESDS-STATUS IND PDU contents

Information element	Length ₂	Length ₈	Type	C/O/M	Remarks
PDU Group ID	8	1	1	M	SDS
PDU Type	8	1	1	M	TESDS-STATUS IND
Called party self address type	2	1	1	M	
Called party type identifier	3	1	1	M	
Called party SSI	24	3		C	See note 1
Called party extension	24	3		C	See note 1
Calling party type identifier	2	1	1	M	
Calling party SSI	24	3		C	See note 2
Calling party extension	24	3		C	See note 2
External subscriber number (calling)	variable	variable	1	M	
Status number	16	2	1	M	
NOTE 1: Shall be conditional on the value of Called Party Type Identifier (CDPTI): - CDPTI = 001 ₂ ; Called Party SSI; - CDPTI = 010 ₂ ; Called Party SSI + Called Party Extension. NOTE 2: Shall be conditional on the value of Calling Party Type Identifier (CGPTI): - CGPTI = 01 ₂ ; Calling Party SSI; - CGPTI = 10 ₂ ; Calling Party SSI + Calling Party Extension.					

8.4.6.4 TESDS-STATUS REQ

This PDU shall be used to convey the parameters of TNSDS-STATUS request from TE2 to MT2 as defined in table 8.82.

Table 8.82: TESDS-STATUS REQ PDU contents

Information element	Length ₂	Length ₈	Type	C/O/M	Remarks
PDU Group ID	8	1	1	M	SDS
PDU Type	8	1	1	M	TESDS-STATUS REQ
Called party type identifier	3	1	1	M	
Called party SNA	8	1		C	See note
Called party SSI	24	3		C	See note
Called party extension	24	3		C	See note
Called external subscriber number	variable	variable	1	M	
User application reference	8	1	1	M	
Status number	16	2	1	M	
Access priority	2	1	2	O	
Traffic stealing	1	1	2	O	
Area selection	4	1	2	O	
NOTE: Shall be conditional on the value of Called Party Type Identifier (CPTI): - CPTI = 000 ₂ ; Called Party SNA; - CPTI = 001 ₂ ; Called Party SSI; - CPTI = 010 ₂ ; Called Party SSI + Called Party Extension.					

8.4.6.5 TESDS-UNITDATA IND

This PDU shall be used to convey the parameters of TNSDS-UNITDATA indication from MT2 to TE2 as defined in table 8.83.

Table 8.83: TESDS-UNITDATA IND PDU contents

Information element	Length ₂	Length ₈	Type	C/O/M	Remarks
PDU Group ID	8	1	1	M	SDS
PDU Type	8	1	1	M	TESDS-UNITDATA IND
Called party self address type	2	1	1	M	
Called party type identifier	3	1	1	M	
Called party SSI	24	3		C	See note 1
Called party extension	24	3		C	See note 1
Calling party type identifier	2	1	1	M	
Calling party SSI	24	3		C	See note 2
Calling party extension	24	3		C	See note 2
Calling external subscriber number	variable	variable	1	M	
Short data type identifier	2	1	1	M	
User defined data-1	16	2		C	See note 3
User defined data-2	32	4		C	See note 3
User defined data-3	64	8		C	See note 3
<p>NOTE 1: Shall be conditional on the value of Called Party Type Identifier (CDPTI):</p> <ul style="list-style-type: none"> - CDPTI = 001₂; Called Party SSI; - CDPTI = 010₂; Called Party SSI + Called Party Extension. <p>NOTE 2: Shall be conditional on the value of Calling Party Type Identifier (CGPTI):</p> <ul style="list-style-type: none"> - CGPTI = 01₂; Calling Party SSI; - CGPTI = 10₂; Calling Party SSI + Calling Party Extension. <p>NOTE 3: Shall be conditional on the value of Short Data Type Identifier (SDTI):</p> <ul style="list-style-type: none"> - SDTI = 0; User Defined Data-1; - SDTI = 1; User Defined Data-2; - SDTI = 2; User Defined Data-3. 					

8.4.6.6 TESDS-UNITDATA REQ

This PDU shall be used to convey the parameters of TNSDS-UNITDATA request from TE2 to MT2 as defined in table 8.84.

Table 8.84: TESDS-UNITDATA REQ PDU contents

Information element	Length ₂	Length ₈	Type	C/O/M	Remarks
PDU Group ID	8	1	1	M	SDS
PDU Type	8	1	1	M	TESDS-UNITDATA REQ
Called party type identifier	3	1	1	M	
Called party SNA	8	1		C	See note 1
Called party SSI	24	3		C	See note 1
Called party extension	24	3		C	See note 1
Called external subscriber number	variable	variable	1	M	
User application reference	8	1	1	M	
Short data type identifier	2	1	1	M	
User defined data-1	16	2		C	See note 2
User defined data-2	32	4		C	See note 2
User defined data-3	64	8		C	See note 2
Access priority	2	1	2	O	
Traffic stealing	1	1	2	O	
Area selection	4	1	2	O	
NOTE 1: Shall be conditional on the value of Called Party Type Identifier (CPTI):					
- CPTI = 0002; Called Party SNA;					
- CPTI = 0012; Called Party SSI;					
- CPTI = 0102; Called Party SSI + Called Party Extension.					
- CPTI = 1002; MT2 default gateway address (refer TESDS-STATUS REQ PDU).					
NOTE 2: Shall be conditional on the value of Short Data Type Identifier (SDTI):					
- SDTI = 0; User Defined Data-1;					
- SDTI = 1; User Defined Data-2;					
- SDTI = 2; User Defined Data-3.					

8.4.7 PDUs relating to SDS-TL

8.4.7.1 TESDS-TL-ACK IND

This PDU shall be used to convey the parameters of TLSDS-ACK indication from MT2 to TE2 as defined in table 8.85.

Table 8.85: TESDS-TL-ACK IND PDU contents

Information element	Length ₂	Length ₈	Type	C/O/M	Remarks
PDU Group ID	8	1	1	M	SDS-TL
PDU Type	8	1	1	M	TESDS-TL-ACK IND
Called party self address type	2	1	1	M	
Called party type identifier	3	1	1	M	
Called party SSI	24	3		C	See note 1
Called party extension	24	3		C	See note 1
Calling party type identifier	3	1	1	M	
Calling party SSI	24	3		C	See note 2
Calling party extension	24	3		C	See note 2
Calling external subscriber number	variable	variable	1	M	
Protocol identifier	8	1	1	M	
Delivery status	8	1	1	M	
Message reference	8	1	1	M	
NOTE 1: Shall be conditional on the value of Called Party Type Identifier (CDPTI):					
- CDPTI = 0012; Called Party SSI;					
- CDPTI = 0102; Called Party SSI + Called Party Extension.					
NOTE 2: Shall be conditional on the value of Calling Party Type Identifier (CGPTI):					
- CGPTI = 012; Calling Party SSI;					
- CGPTI = 102; Calling Party SSI + Calling Party Extension.					

8.4.7.2 TESDS-TL-ACK REQ

This PDU shall be used to convey the parameters of TLSDS-ACK request from TE2 to MT2 as defined in table 8.86.

Table 8.86: TESDS-TL-ACK REQ PDU contents

Information element	Length ₂	Length ₈	Type	C/O/M	Remarks
PDU Group ID	8	1	1	M	SDS-TL
PDU Type	8	1	1	M	TESDS-TL-ACK REQ
Called party type identifier	3	1	1	M	
Called party SNA	8	1		C	See note 1
Called party SSI	24	3		C	See note 1
Called party extension	24	3		C	See note 1
Called external subscriber number	variable	variable	1	M	
Protocol identifier	8	1	1	M	
Delivery status	8	1	1	M	
Message reference	8	1	1	M	
Storage	1	1	1	M	See note 2
Access priority	2	1	2	O	
Traffic stealing	1	1	2	O	
Area selection	4	1	2	O	
NOTE 1: Shall be conditional on the value of Called Party Type Identifier (CPTI): <ul style="list-style-type: none"> - CPTI = 0; Called Party SNA; - CPTI = 1; Called Party SSI; - CPTI = 2; Called Party SSI + Called Party Extension. NOTE 2: The storage shall be "storage not allowed".					

8.4.7.3 TESDS-TL-REPORT IND

This PDU shall be used to convey the parameters of TLSDS-REPORT indication from MT2 to TE2 as defined in table 8.87.

Table 8.87: TESDS-TL-REPORT IND PDU contents

Information element	Length ₂	Length ₈	Type	C/O/M	Remarks
PDU Group ID	8	1	1	M	SDS-TL
PDU Type	8	1	1	M	TESDS-TL-REPORT IND
Called party self address type	2	1	1	M	
Called party type identifier	3	1	1	M	
Called party SSI	24	3		C	See note 1
Called party extension	24	3		C	See note 1
Calling party type identifier	2	1	1	M	See note 2
Calling party SSI	24	3		C	
Calling party extension	24	3		C	
Calling external subscriber number	variable	variable	1	M	
Protocol identifier	8	1	1	M	
Acknowledgement required	1	1	1	M	
Delivery status	8	1	1	M	
Message reference	8	1	1	M	
Message reference handle	8	1	1	M	
Storage	1	1	1	M	
Validity period	6	1		C	See note 3
Forward address type identifier	4	1		C	See note 3
Forward address SNA	8	1		C	See notes 3 and 4
Forward address SSI	24	3		C	See notes 3 and 4
Forward address extension	24	3		C	See notes 3 and 4
Forward address external subscriber number	variable	variable		C	See notes 3 and 4
User data	Variable			M	
<p>NOTE 1: Shall be conditional on the value of Called Party Type Identifier (CDPTI):</p> <ul style="list-style-type: none"> - CDPTI = 1; Called Party SSI; - CDPTI = 2; Called Party SSI + Called Party Extension. <p>NOTE 2: Shall be conditional on the value of Calling Party Type Identifier (CGPTI):</p> <ul style="list-style-type: none"> - CGPTI = 012; Calling Party SSI; - CGPTI = 102; Calling Party SSI + Calling Party Extension. <p>NOTE 3: Shall be conditional on the value of Storage:</p> <ul style="list-style-type: none"> - Storage = 0; - Storage = 1; validity period + Forward address. <p>NOTE 4: Shall be conditional on the value of Forward Address Type Identifier (FATI):</p> <ul style="list-style-type: none"> - FATI = 0; Forward Address SNA; - FATI = 1; Forward Address SSI; - FATI = 2, Forward Address SSI + Forward Address Extension; - FATI = 3; Forward External subscriber number. 					

8.4.7.4 TESDS-TL-REPORT REQ

This PDU shall be used to convey the parameters of TLSDS-REPORT request from TE2 to MT2 as defined in table 8.88.

Table 8.88: TESDS-TL-REPORT REQ PDU contents

Information element	Length ₂	Length ₈	Type	C/O/M	Remarks
PDU Group ID	8	1	1	M	SDS-TL
PDU Type	8	1	1	M	TESDS-TL-REPORT REQ
Called party type identifier	3	1	1	M	
Called party SNA	8	1		C	See note 1
Called party SSI	24	3		C	See note 1
Called party extension	24	3		C	See note 1
Called external subscriber number	variable	variable	1	M	
Protocol identifier	8	1	1	M	
Acknowledgement required	1	1	1	M	
Delivery status	8	1	1	M	
Message reference	8	1	1	M	
Storage	1	1	1	M	
Validity period	6	1		C	See note 2
Forward address type identifier	4	1		C	See note 2
Forward address SNA	8	1		C	See notes 2 and 3
Forward address SSI	24	3		C	See notes 2 and 3
Forward address extension	24	3		C	See notes 2 and 3
Forward address external subscriber number	variable	variable		C	See notes 2 and 3
Access priority	2	1	2	O	
Traffic stealing	1	1	2	O	
Area selection	4	1	2	O	
User data	Variable			M	
NOTE 1: Shall be conditional on the value of Called Party Type Identifier (CPTI):					
- CPTI = 0; Called Party SNA;					
- CPTI = 1; Called Party SSI;					
- CPTI = 2; Called Party SSI + Called Party Extension.					
NOTE 2: Shall be conditional on the value of Storage:					
- Storage = 0;					
- Storage = 1;					
- Validity period + Forward address.					
NOTE 3: Shall be conditional on the value of Forward Address Type Identifier (FATI):					
- FATI = 0; Forward Address SNA;					
- FATI = 1; Forward Address SSI;					
- FATI = 2, Forward Address SSI + Forward Address Extension;					
- FATI = 3; Forward External subscriber number.					

8.4.7.5 TESDS-TL-TRANSFER IND

This PDU shall be used to convey the parameters of TLSDS-TRANSFER indication from MT2 to TE2 as defined in table 8.89.

Table 8.89: TESDS-TL-TRANSFR IND PDU contents

Information element	Length ₂	Length ₈	Type	C/O/M	Remarks
PDU Group ID	8	1	1	M	SDS-TL
PDU Type	8	1	1	M	TESDS-TL-TRANSFR IND
Called party self address type	2	1	1	M	
Called party type identifier	3	1	1	M	
Called party SSI	24	3		C	See note 1
Called party extension	24	3		C	See note 1
Calling party type identifier	2	1	1	M	
Calling party SSI	24	3		C	See note 2
Calling party extension	24	3		C	See note 2
Calling external subscriber number	variable	variable	1	M	
Protocol identifier	8	1	1	M	
Delivery report request	2	1	1	M	
Short form report	1	1	1	M	
Message reference	8	1	1	M	
Storage	1	1	1	M	
Validity period	6	1		C	See note 3
Forward address type identifier	4	1		C	See note 3
Forward address SNA	8	1		C	See notes 3 and 4
Forward address SSI	24	3		C	See notes 3 and 4
Forward address extension	24	3		C	See notes 3 and 4
Forward address External subscriber number	variable	variable		C	See notes 3 and 4
User data	variable	variable	1	M	
<p>NOTE 1: Shall be conditional on the value of Called Party Type Identifier (CPTI):</p> <ul style="list-style-type: none"> - CDPTI = 1; Called Party SSI; - CDPTI = 2; Called Party SSI + Called Party Extension. <p>NOTE 2: Shall be conditional on the value of Calling Party Type Identifier (CGPTI):</p> <ul style="list-style-type: none"> - CGPTI = 012; Calling Party SSI; - CGPTI = 102; Calling Party SSI + Calling Party Extension. <p>NOTE 3: Shall be conditional on the value of Storage:</p> <ul style="list-style-type: none"> - Storage = 0; - Storage = 1; Validity period + Forward address. <p>NOTE 4: Shall be conditional on the value of Forward address Type Identifier (FATI):</p> <ul style="list-style-type: none"> - FATI = 0; Forward Address SNA; - FATI = 1; Forward Address SSI; - FATI = 2; Forward Address SSI + Forward Address Extension; - FATI = 3; Forward External subscriber number. 					

8.4.7.6 TESDS-TL-TRANSFER REQ

This PDU shall be used to convey the parameters of TLSDS-TRANSFER request from TE2 to MT2 as defined in table 8.90.

Table 8.90: TESDS-TL-TRANSFER REQ PDU contents

Information element	Length ₂	Length ₈	Type	C/O/M	Remarks
PDU Group ID	8	1	1	M	SDS-TL
PDU Type	8	1	1	M	TESDS-TL-TRANSFER REQ
Called party type identifier	3	1	1	M	
Called party SNA	8	1		C	See note 1
Called party SSI	24	3		C	See note 1
Called party extension	24	3		C	See note 1
Called external subscriber number	variable	variable	1	M	
Protocol identifier	8	1	1	M	
Delivery report request	2	1	1	M	
Service selection	1	1	1	M	
Message reference handle	8	1	1	M	
Storage	1	1	1	M	
Validity period	6	1		C	See note 2
Forward address type identifier	4	1		C	See note 2
Forward address SNA	8	1		C	See notes 2 and 3
Forward address SSI	24	3		C	See notes 2 and 3
Forward address extension	24	3		C	See notes 2 and 3
Forward address external subscriber number	variable	variable		C	See notes 2 and 3
Access priority	2	1	2	O	
Traffic stealing	1	1	2	O	
Area selection	4	1	2	O	
User data	variable			M	
<p>NOTE 1: Shall be conditional on the value of Called Party Type Identifier (CPTI):</p> <ul style="list-style-type: none"> - CPTI = 0; Called Party SNA; - CPTI = 1; Called Party SSI; - CPTI = 2; Called Party SSI + Called Party Extension. <p>NOTE 2: Shall be conditional on the value of Storage:</p> <ul style="list-style-type: none"> - Storage = 0; - Storage = 1; - Validity period + Forward address. <p>NOTE 3: Shall be conditional on the value of Forward address Type Identifier (FATI):</p> <ul style="list-style-type: none"> - FATI = 0; Forward Address SNA; - FATI = 1; Forward Address SSI; - FATI = 2; Forward Address SSI + Forward Address Extension; - FATI = 3; Forward External subscriber number. 					

8.4.7.7 TESDS-TL-TNSDS-REPORT IND

This PDU shall be used to convey the parameters of TESDS-TL-TNSDS-REPORT indication from MT2 to TE2 as defined in table 8.91.

Table 8.91: TESDS-TL-TNSDS-REPORT IND PDU contents

Information element	Length ₂	Length ₈	Type	C/O/M	Remarks
PDU Group ID	8	1	1	M	SDS-TL
PDU Type	8	1	1	M	TESDS-TL-TNSDS-REPORT IND
SDS reference type	2	1	1	M	
User application reference	8	1		C	See note
Message reference handle	8	1		C	See note
Message reference	8	1		C	See note
SDS transfer result	8	1	1	M	
NOTE: Shall be conditional on the value of the SDS Reference Type (SRFT): <ul style="list-style-type: none"> - SRFT = 0; Message reference handle + Message reference (in case the TESDS-TL-TRANSFER REQ has been transmitted successfully or the transmission failure. - SRFT = 1; Message reference (in case the TESDS-TL-ACK REQ/TESDS-TL-REPORT-REQ have been transmitted successfully or the transmission failure. - SRFT = 2; User Application Reference (in case the TESDS-TL-UNIT-DATA REQ has been transmitted successfully or the transmission failure. 					

8.4.7.8 TESDS-TL-UNITDATA IND

This PDU shall be used to convey the parameters of TNSDS-TL-UNITDATA indication from MT2 to TE2 as defined in table 8.92.

Table 8.92: TESDS-TL-UNITDATA IND PDU contents

Information element	Length ₂	Length ₈	Type	C/O/M	Remarks
PDU Group ID	8	1	1	M	SDS-TL
PDU Type	8	1	1	M	TESDS-TL-UNITDATA IND
Called party self address type	2	1	1	M	
Called party type identifier	3	1	1	M	
Called party SSI	24	3		C	See note 1
Called party extension	24	3		C	See note 1
Calling party type identifier	2	1	1	M	
Calling party SSI	24	3		C	See note 2
Calling party extension	24	3		C	See note 2
Calling external subscriber number	variable	variable	1	M	
Protocol identifier	8	1	1	M	
User data	variable	variable	1	M	
NOTE 1: Shall be conditional on the value of Called Party Type Identifier (CDPTI): <ul style="list-style-type: none"> - CDPTI = 0012; Called Party SSI; - CDPTI = 0102; Called Party SSI + Called Party Extension. NOTE 2: Shall be conditional on the value of Calling Party Type Identifier (CGPTI): <ul style="list-style-type: none"> - CGPTI = 012; Calling Party SSI; - CGPTI = 102; Calling Party SSI + Calling Party Extension. 					

8.4.7.9 TESDS-TL-UNITDATA REQ

This PDU shall be used to convey the parameters of TNSDS-TL-UNITDATA request from TE2 to MT2 as defined in table 8.93.

Table 8.93: TESDS-TL-UNITDATA REQ PDU contents

Information element	Length ₂	Length ₈	Type	C/O/M	Remarks
PDU Group ID	8	1	1	M	SDS-TL
PDU Type	8	1	1	M	TESDS-TL-UNITDATA REQ
Called party type identifier	3	1	1	M	
Called party SNA	8	1		C	See note
Called party SSI	24	3		C	See note
Called party extension	24	3		C	See note
Called external subscriber number	variable	variable	1	M	
User application reference	8	1	1	M	
Protocol identifier	8	1	1	M	
Access priority	2	1	2	O	
Traffic stealing	1	1	2	O	
Area selection	4	1	2	O	
User data	variable	variable		M	
NOTE: Shall be conditional on the value of Called Party Type Identifier (CPTI):					
- CPTI = 0; Called Party SNA;					
- CPTI = 1; Called Party SSI;					
- CPTI = 2; Called Party SSI + Called Party Extension.					

8.4.8 PDUs relating to SS

8.4.8.1 TESS-FACILITY CON

This PDU shall be used to convey the parameters of TNSS-FACILITY confirm from MT2 to TE2 as defined in table 8.94.

Table 8.94: TESS-FACILITY CON PDU contents

Information element	Length ₂	Length ₈	Type	C/O/M	Remarks
PDU Group ID	8	1	1	M	SS
PDU Type	8	1	1	M	TESS-FACILITY CON
SS type	6	1	1	M	
SS PDU type			3	M	
SS facility parameters			3	O	

8.4.8.2 TESS-FACILITY IND

This PDU shall be used to convey the parameters of TNSS-FACILITY indication from MT2 to TE2 as defined in table 8.95.

Table 8.95: TESS-FACILITY IND PDU contents

Information element	Length ₂	Length ₈	Type	C/O/M	Remarks
PDU Group ID	8	1	1	M	SS
PDU Type	8	1	1	M	TESS-FACILITY IND
SS type	6	1	1	M	
SS PDU type			3	M	
SS facility parameters			3	O	

8.4.8.3 TESS-FACILITY REQ

This PDU shall be used to convey the parameters of TNSS-FACILITY request from TE2 to MT2 as defined in table 8.96.

Table 8.96: TESS-FACILITY REQ PDU contents

Information element	Length ₂	Length ₈	Type	C/O/M	Remarks
PDU Group ID	8	1	1	M	SS
PDU Type	8	1	1	M	TESS-FACILITY REQ
SS type	6	1	1	M	
SS PDU type			3	M	
SS facility parameters			3	O	

8.4.8.4 TESS-FACILITY RES

This PDU shall be used to convey the parameters of TNSS-FACILITY response from TE2 to MT2 as defined in table 8.97.

Table 8.97: TESS-FACILITY RES PDU contents

Information element	Length ₂	Length ₈	Type	C/O/M	Remarks
PDU Group ID	8	1	1	M	SS
PDU Type	8	1	1	M	TESS-FACILITY RES
SS type	6	1	1	M	
SS PDU type			3	M	
SS facility parameters			3	O	

8.4.9 PDUs relating to MEX

8.4.9.1 TEMX-CAPABILITY REQ

This PDU shall be used to convey the parameters of TEMX-CAPABILITY request from TE2 to MT2 as defined in table 8.98.

Table 8.98: TEMX-CAPABILITY REQ PDU contents

Information element	Length ₂	Length ₈	Type	C/O/M	Remark
PDU Group ID	8	1	1	M	MEX
PDU type	8	1	1	M	TEMX-CAPABILITY REQ
MEX handle	8	1	1	M	

8.4.9.2 TEMX-CAPABILITY CON

This PDU shall be used to convey the parameters of TEMX-CAPABILITY confirmation from MT2 to TE2 as defined in table 8.99.

Table 8.99: TEMX-CAPABILITY CON PDU contents

Information element	Length ₂	Length ₈	Type	C/O/M	Remark
PDU Group ID	8	1	1	M	MEX
PDU type	8	1	1	M	TEMX-CAPABILITY CON
MEX handle	8	1	1	M	
MEX capability	1	1	1	M	

8.4.9.3 TEMX-CONNECT REQ

This PDU shall be used to convey the parameters of TEMX-CONNECT request from TE2 to MT2 as defined in table 8.100.

Table 8.100: TEMX-CONNECT REQ PDU contents

Information element	Length ₂	Length ₈	Type	C/O/M	Remark
PDU Group ID	8	1	1	M	MEX
PDU type	8	1	1	M	TEMX-CONNECT REQ
MEX handle	8	1	1	M	
MEX QoS filter	Variable	Variable	2	O	
MEX QoS class lower (Uplink)	8	1		C	See note 1
MEX QoS class upper (Uplink)	8	1		C	See note 1
MEX QoS class lower (Downlink)	8	1	2	O	See note 1
MEX QoS class upper (Downlink)	8	1	2	O	See note 1
MEX Escalate DSCP5 flag enable	1	1	2	O	See note 1
MEX Escalate DSCP5 flag reset	1	1	2	O	See note 1
MEX PDP type	3	1		C	See note 2
MEX PDP address	Variable	Variable		C	See notes 4 and 5
NSAPI	4	1		C	See note 2
DCOMP	4	1	2	O	See notes 2 and 3
PCOMP	4	1	2	O	See notes 2 and 3
NSAPI QoS negotiation	Variable	Variable	2	O	See notes 2 and 3
NSAPI data priority	3	1	2	O	See notes 2 and 3
NOTE 1: Only used if the "MEX handle" was returned with MEX mode as "Use MEX".					
NOTE 2: Only used if the "MEX handle" was returned with MEX mode as "Bypass to SNDCP".					
NOTE 3: Optional, refer to SN-NSAPI Alloc - see EN 300 392-2 [3], clause 28.2.3.1.					
NOTE 4: Conditional on MEX PDP type information element, not present in case of IPv4 dynamic address negotiation or IPv6, refer to SN-NSAPI Alloc - see EN 300 392-2 [3], clause 28.2.3.1.					
NOTE 5: Parameter field size varies depending on type of address, as specified in the MEX PDP Type IE.					

8.4.9.4 TEMX-CONNECT CON

This PDU shall be used to convey the parameters of TEMX-CONNECT confirmation from TE2 to MT2 as defined in table 8.101.

Table 8.101: TEMX-CONNECT CON PDU contents

Information element	Length ₂	Length ₈	Type	C/O/M	Remark
PDU Group ID	8	1	1	M	MEX
PDU type	8	1	1	M	TEMX-CONNECT CON
MEX handle	8	1	1	M	
MEX connect report	2	1	1	M	
MEX connect reject cause	6	1		C	See note 1
Maximum transmission unit	16	2	1	M	
MEX PDP type	3	1		C	See note 2
MEX PDP address	Variable	Variable		C	See notes 2 and 3
DCOMP	4	1	2	O	See notes 4
PCOMP	4	1	2	O	See notes 4
NSAPI QoS negotiation	Variable	Variable	2	O	See notes 4
PDU priority max	3	1		C	See note 2
Mobile IPv4 information	120	15		C	See note 2
MEX precedence supported	1	1		C	See note 5
MEX precedence rank	7	1		C	See notes 5 and 6
NOTE 1: Present if MEX report is "Failure".					
NOTE 2: Shall be present, if MEX connect report is "Success (QoS parameter changed)". Refer to SN-NSAPI Alloc - see EN 300 392-2 [3], clause 28.2.3.1.					
NOTE 3: Parameter field size varies depending on type of address, as specified in the MEX PDP Type IE.					
NOTE 4: Only used if the "MEX handle" was returned with MEX mode as "Bypass to SNDPCP" and the values has changed. Refer to SN-NSAPI Alloc - see EN 300 392-2 [3], clause 28.2.3.1.					
NOTE 5: Only used if the "MEX handle" was returned with MEX mode as "Use MEX".					
NOTE 6: MEX precedence rank is only returned if "MEX precedence supported" is true (value = 1).					

8.4.9.5 TEMX-BYPASS DATA REQ

This PDU shall be used to convey the parameters of TEMX-BYPASS DATA request from TE2 to MT2 as defined in table 8.102.

Table 8.102: TEMX-BYPASS DATA REQ PDU contents

Information element	Length ₂	Length ₈	Type	C/O/M	Remark
PDU Group ID	8	1	1	M	MEX
PDU type	8	1	1	M	TEMX-BYPASS DATA REQ
MEX handle	8	1	1	M	See note 1
NSAPI	4	1		C	See note 2
Data handle	32	4		C	See note 2
PDU priority	3	1		C	See note 2
Data priority	3	1		C	See note 2
Data importance	2	1		C	See note 2
Schedule surplus flag	1	1		C	See note 2
MEX N-PDU	Variable	Variable	1	M	
NOTE 1: MEX handle shall be set to "Bypass to SNDPCP".					
NOTE 2: Only present if MEX handle represents "Bypass to SNDPCP".					

8.4.9.6 TEMX-BYPASS DATA IND

The TEMX-BYPASS DATA IND PDU shall be used to convey the parameters of TEMX-BYPASS DATA indication from MT2 to TE2 as defined in table 8.103.

Table 8.103: TEMX-BYPASS DATA IND PDU contents

Information element	Length ₂	Length ₈	Type	C/O/M	Remark
PDU Group ID	8	1	1	M	MEX
PDU type	8	1	1	M	TEMX-BYPASS DATA IND
MEX handle	8	1	1	M	See note 1
NSAPI	4	1		C	See note 2
MEX N-PDU	Variable	Variable	1	M	
NOTE 1: MEX handle shall be set to "Bypass to SNDTCP".					
NOTE 2: Only present if MEX handle represents "Bypass to SNDTCP".					

8.4.9.7 TEMX-DELIVERY_IND

This PDU shall be used to convey the parameters of TEMX-DELIVERY indication from MT2 to TE2 as defined in table 8.104.

NOTE: This PDU may be only delivered if MEX Mode for MEX Handle is "Bypass to SNDTCP"; an equivalent delivery failure in "Use MEX Mode" may be reported as an ICMP packet across the PEI.

Table 8.104: TEMX-DELIVERY IND PDU contents

Information element	Length ₂	Length ₈	Type	C/O/M	Remark
PDU Group ID	8	1	1	M	MEX
PDU type	8	1	1	M	TEMX-DELIVERY IND
MEX handle	8	1	1	M	
Data handle	32	4		C	See note 1
MEX delivery report	3	1		M	See note 2
MEX delivery header	Variable	Variable		C	See note 3
NOTE 1: Only present if MEX Handle represents "Bypass to SNDTCP".					
NOTE 2: Valid for specific values also in the case of "Bypass to SNCP".					
NOTE 3: Only present if MEX Handle represents "Use MEX".					

8.4.9.8 TEMX-END REQ

This PDU shall be used to convey the parameters of TEMX-END request from TE2 to MT2 as defined in table 8.105.

Table 8.105: TEMX-END REQ PDU contents

Information element	Length ₂	Length ₈	Type	C/O/M	Remark
PDU Group ID	8	1	1	M	MEX
PDU type	8	1	1	M	TEMX-END REQ
mex handle	8	1	1	M	
NSAPI	4	1		C	See note
MEX deactivation type	2	1	1	M	
NOTE: Only present if MEX handle represents "Bypass to SNDTCP".					

8.4.9.9 TEMX-END CON

This PDU shall be used to convey the parameters of TEMX-END confirmation from MT2 to TE2 as defined in table 8.106.

Table 8.106: TEMX-END CON PDU contents

Information element	Length ₂	Length ₈	Type	C/O/M	Remark
PDU Group ID	8	1	1	M	MEX
PDU type	8	1	1	M	TEMX-END CON
MEX handle	8	1	1	M	
NSAPI	4	1		C	See note
MEX deactivation type	2	1	1	M	
NOTE: Only present if MEX handle represents "Bypass to SNDCCP".					

8.4.9.10 TEMX-END IND

This PDU shall be used to convey the parameters of TEMX-END indication from MT2 to TE2 as defined in table 8.107.

Table 8.107: TEMX-END IND PDU contents

Information element	Length ₂	Length ₈	Type	C/O/M	Remark
PDU Group ID	8	1	1	M	MEX
PDU type	8	1	1	M	TEMX-END IND
MEX Handle	8	1	1	M	
NSAPI	4	1		C	See note
MEX Deactivation Type	2	1	1	M	
NOTE: Only present if MEX handle represents "Bypass to SNDCCP".					

8.4.9.11 TEMX-HANDLE REQ

This PDU shall be used to convey the parameters of TEMX-HANDLE request from TE2 to MT2 as defined in table 8.108.

Table 8.108: TEMX- HANDLE REQ PDU contents

Information element	Length ₂	Length ₈	Type	C/O/M	Remark
PDU Group ID	8	1	1	M	MEX
PDU type	8	1	1	M	TEMX- HANDLE REQ
MEX handle	8	1	1	M	
MEX mode	2	1	1	M	

8.4.9.12 TEMX-HANDLE CON

This PDU shall be used to convey the parameters of TEMX- HANDLE confirmation from MT2 to TE2 as defined in table 8.109.

Table 8.109: TEMX- HANDLE CON PDU contents

Information element	Length ₂	Length ₈	Type	C/O/M	Remark
PDU Group ID	8	1	1	M	MEX
PDU type	8	1	1	M	TEMX- HANDLE CON
MEX handle	8	1	1	M	
MEX mode	2	1	1	M	

8.4.9.13 TEMX-MODIFY REQ

This PDU shall be used to convey the parameters of TEMX-MODIFY request from TE2 to MT2 as defined in table 8.110.

Table 8.110: TEMX-MODIFY REQ PDU contents

Information element	Length ₂	Length ₈	Type	C/O/M	Remark
PDU Group ID	8	1	1	M	MEX
PDU type	8	1	1	M	TEMX-MODIFY REQ
MEX handle	8	1	1	M	
MEX QoS filter	Variable	Variable	2	O	
MEX filter operation	2	1	2	O	
MEX QoS class lower (Uplink)	8	1		C	See note 1
MEX QoS class upper (Uplink)	8	1		C	See note 1
MEX QoS class lower (Downlink)	8	1		C	See notes 1 and 4
MEX QoS class upper (Downlink)	8	1		C	See notes 1 and 4
MEX NSAPI usage	1	1	2	O	
NSAPI QoS negotiation	Variable	Variable		C	See notes 2 and 3
NOTE 1: Only used if the "MEX handle" was returned with MEX mode as "Use MEX".					
NOTE 2: Only used if the "MEX handle" was returned with MEX mode as "Bypass to SNDCP".					
NOTE 3: Refer to SN-NSAPI Alloc - see EN 300 392-2 [3], clause 28.2.3.1.					
NOTE 4: Only if SNDCP supports asynchronous QoS.					

8.4.9.14 TEMX-MODIFY CON

This PDU shall be used to convey the parameters of TEMX-MODIFY confirmation from MT2 to TE2 as defined in table 8.111.

Table 8.111: TEMX-MODIFY CON PDU contents

Information element	Length ₂	Length ₈	Type	C/O/M	Remark
PDU Group ID	8	1	1	M	MEX
PDU type	8	1	1	M	TEMX-MODIFY CON
MEX handle	8	1	1	M	
MEX modify report	2	1	1	M	
MEX modify reject cause	4	1		C	See note 3
NSAPI QoS negotiation	Variable	Variable		C	See note 2
MEX precedence supported	1	1		C	See note 1
MEX precedence rank	7	1		C	See notes 1 and 4
NOTE 1: Only used if the "MEX handle" was returned with MEX mode as "Use MEX".					
NOTE 2: Only used if the "MEX handle" was returned with MEX mode as "Bypass to SNDCP".					
NOTE 3: Present if MEX Modify report is "Failure".					
NOTE 4: MEX precedence rank is only returned if "MEX precedence supported" is true (value = 1).					

8.4.9.15 TEMX-MODIFY IND

This PDU shall be used to convey the parameters of TEMX-MODIFY indication from MT2 to TE2 as defined in table 8.112.

Table 8.112: TEMX-MODIFY IND PDU contents

Information element	Length ₂	Length ₈	Type	C/O/M	Remark
PDU Group ID	8	1	1	M	MEX
PDU type	8	2	1	M	TEMX-MODIFY IND
MEX handle	8	1	1	M	
MEX precedence supported	1	1		C	See note 1
MEX precedence rank	7	1		C	See notes 1 and 4
NSAPI QoS negotiation	Variable	Variable	2	O	See notes 2 and 3
Schedule availability	2	1	2	O	
NOTE 1: Only used if the "MEX handle" was returned with MEX mode as "Use MEX".					
NOTE 2: Only used if the "MEX handle" was returned with MEX mode as "Bypass to SNDPCP".					
NOTE 3: Refer to SN-NSAPI Alloc - see EN 300 392-2 [3], clause 28.2.3.1.					
NOTE 4: MEX precedence rank is only returned if "MEX precedence supported" is true (value = 1).					

8.4.9.16 TEMX-QOSCLASS REQ

This PDU shall be used to convey the parameters of TEMX-QOSCLASS request from TE2 to MT2 as defined in table 8.113.

Table 8.113: TEMX-QOSCLASS REQ PDU contents

Information element	Length ₂	Length ₈	Type	C/O/M	Remark
PDU Group ID	8	1	1	M	MEX
PDU type	8	1	1	M	TEMX-QOSCLASS REQ
MEX handle	8	1	1	M	
MEX QoS class	8	1	1	M	
MEX QoS class access	3	1	1	M	
MEX QoS	Variable	Variable		C	See note
NOTE: Not present if MEX QoS class access is "Read".					

8.4.9.17 TEMX-QOSCLASS CON

This PDU shall be used to convey the parameters of TEMX-QOSCLASS confirmation from MT2 to TE2 as defined in table 8.114.

Table 8.114: TEMX-QOSCLASS CON PDU contents

Information element	Length ₂	Length ₈	Type	C/O/M	Remark
PDU Group ID	8	1	1	M	MEX
PDU type	8	1	1	M	TEMX-QOSCLASS CON
MEX handle	8	1	1	M	
MEX QoS class	8	1	1	M	
MEX QoS class access	3	1	1	M	See note
MEX QoS	Variable	Variable	1	M	
NOTE: "Read" is indicated if the MEX QoS class is Read Only. "Write" is indicated if the "MEX QoS class" entry has been updated.					

8.5 Information elements coding

8.5.1 General on information element coding

Any of the following information elements can be coded as TNPI type 1, 2 or 3 depending on the PDU.

The lengths (Length) of the information elements and their sub-elements are defined in number of bits.

All information element values not explicitly defined are reserved and shall not be used in this version of the protocol.

Most of the information elements defined in this clause are originally defined for TETRA AI protocols in EN 300 392-2 [3]. Whenever the definition of the present document and EN 300 392-2 [3] differ, EN 300 392-2 [3] takes precedence.

8.5.2 Access Priority (AP)

The AP information element shall indicate to the accessed entity urgency of the service request as defined in table 8.115. This information element is that described in EN 300 392-2 [3], clause 11.

Table 8.115: Access Priority information element contents

Information element	Length	Value ₂	Remarks
Access Priority	2	00	Low priority
		01	High priority
		10	Emergency priority

8.5.3 Acknowledgement required

The acknowledgement required information element shall indicate acknowledgement request for the message as defined in table 8.116.

Table 8.116: Acknowledgement required information element contents

Information element	Length	Value ₂	Remarks
Acknowledgement required	1	0	Acknowledgement not required
		1	Acknowledgement required

8.5.4 Address extension

The address extension information element shall indicate the extended part of TSI address as defined in table 8.117.

Table 8.117: Address extension information element contents

Information element	Length	Value	Remarks
Mobile country code (MCC)	10	any	
Mobile Network Code (MNC)	14	any	

8.5.5 Area Selection (AS)

The AS information element shall indicate to the SwMI the distribution of the call as defined in table 8.118.

Table 8.118: Area selection information element contents

Information element	Length	Value ₂	Remarks
Area Selection	4	0000	Area not defined
		0001	Area 1
		0010	Area 2
		etc.	etc.
		1110	Area 14
		1111	All Areas this system

8.5.6 Attach detach request status

The attach detach request status information element is defined in table 8.119.

Table 8.119: Attach detach request status information element contents

Information element	Length	Value ₂	Remarks
Attach Request Status	3	000	Attach status none
		001	Attach success
		010	Attach reject (MM is busy)
		011	Attach timeout (T535 expires)
		100	Attached failed
		101	Attached break
		110	Attached reject SwMI report active
		111	Not supported by MT

8.5.7 Basic service information

The basic service information element shall inform the SwMI what basic service is requested as defined in table 8.120. The total element length of the information element is 8 bits.

Table 8.120: Basic service information element contents

Information sub-element	Length	Value ₂	Remarks
Circuit mode type Note 1	3	000	Speech: TCH/S
		001	Unprotected: TCH/7.2
		010	Low Protection: TCH/4.8, N = 1
		011	Low Protection: TCH/4.8, N = 4
		100	Low Protection: TCH/4.8, N = 8
		101	High Protection: TCH/2.4, N = 1
		110	High Protection: TCH/2.4, N = 4
		111	High Protection: TCH/2.4, N = 8
End to end encryption flag Note 2	1	0	Clear Mode
		1	End-to-end encryption
Communication type	2	00	Point-to-point
		01	Point-to-multipoint
		10	Point-to-multipoint Acknowledged
		11	Broadcast
Slots per frame Note 3	2	00	One slot
		01	Two slots
		10	Three slots
		11	Four slots
NOTE 1: Indicates the traffic channel (TCH) type and the interleaving depth N. NOTE 2: Indicates whether the circuit mode speech or circuit mode data is end-to-end encrypted. NOTE 3: Indicates the required bit rate for a circuit mode data call. For TCH/7.2, TCH/4.8 and TCH/2.4 the resulting bit rate is the TCH bit rate multiplied by the number of slots per frame. (For example, TCH/7.2 in four time slots per frame gives a circuit mode data rate of 28,8 kbit/s.) For TCH/S this element shall be present (set to 0).			

8.5.8 Battery charge

The battery charge information element shall indicate the charging state of the MT2 battery as defined in table 8.121.

Table 8.121: Battery Charge information element contents

Information element	Length	Value	Remarks
Battery charge	7	0	Empty
		etc.	etc.
		100	Full
		101	Reserved
		etc.	etc.
		127	Reserved

8.5.9 Bit error ratio

The bit error ratio information element shall indicate the bit error ratio detected by the MT2 in the AI as defined in table 8.122.

Table 8.122: Bit Error Ratio information element contents

Information element	Length	Value	Remarks
Bit error ratio	8	0	BER < 0,01 %
		1	0,01 % to less than 0,1 %
		2	0,1 % to less than 0,5 %
		3	0,5 % to less than 1,0 %
		4	1,0 % to less than 2,0 %
		5	2,0 % to less than 4,0 %
		6	4,0 % to less than 8,0 %
		7	≥ 8,0 %
		8	Reserved
		etc.	etc.
		98	Reserved
		99	Not known or detectable
		100	Reserved
		etc.	etc.
254	Reserved		

8.5.10 BS service details

The BS service details information element includes the parameters included in the BS service details - see clause 18.5.2 in EN 300 392-2 [3], as defined in table 8.123.

Table 8.123: BS service details information element

Information sub-element	Length	Value	Remarks
Registration	1	0	Registration not required on this cell
		1	Registration mandatory on this cell
De-registration	1	0	De-registration not required on this cell
		1	De-registration mandatory on this cell
Priority cell	1	0	Cell is not a priority cell
		1	Cell is a priority cell
Minimum mode service	1	0	Cell may use minimum mode
		1	Cell never uses minimum mode
Migration	1	0	Migration is not supported by this cell
		1	Migration is supported by this cell
System wide services	1	0	System wide services temporarily not supported
		1	Normal mode
TETRA voice service	1	0	TETRA voice service is not supported on this cell
		1	TETRA voice service is supported on this cell
Circuit mode data service	1	0	Circuit mode data service is not supported on this cell
		1	Circuit mode data service is supported on this cell
Reserved	1	0	Default value
		1	Reserved for future expansion
NDCP Service	1	0	SNDCP service is not available on this cell
		1	SNDCP service is available on this cell
Air interface encryption Service	1	0	Air interface encryption is not available on this cell
		1	Air interface encryption is available on this cell
Advanced link supported	1	0	Advanced link is not supported on this cell
		1	Advanced link is supported on this cell

8.5.11 Call amalgamation

The call amalgamation information element is as defined in table 8.124.

Table 8.124: Call amalgamation information element contents

Information element	Length	Value	Remarks
Call amalgamation	1	0	Call not amalgamated
		1	Call amalgamated

8.5.12 Call handle

The call handle information element shall be used to distinguish between multiple or concurrent service instances as defined in table 8.125.

Table 8.125: Call handle information element contents

Information element	Length	Value	Remarks
Call handle	16	0	Dummy call handle
		1	Call instance label
		etc.	etc.
		$2^{16} - 1$	Call instance label

NOTE: This information element is not used on the air interface, although there is an equivalent information element "call identity".

8.5.13 Called party extension

The called party extension information element shall indicate to the SwMI the extended part of the TSI address of the called user as defined in table 8.126.

Table 8.126: Called party extension information element contents

Information element	Length	Value	Remarks
Country Code	10	any	See EN 300 392-1 [1], clause 7
Network Code	14	any	See EN 300 392-1 [1], clause 7

8.5.14 Called party self address type

The called party self address type information element shall indicate the address, which is followed in the PDU as defined in table 8.127.

Table 8.127: Called Party self address type information element contents

Information element	Length	Value ₂	Remarks
Called party self address type	2	00	Reserved
		01	Individual address
		10	Group address
		11	Broadcast

8.5.15 Called party short number address (SNA)

The called party short number address information element shall indicate to the SwMI the Short Number address (SNA) of the called user as defined in table 8.128.

Table 8.128: Called party short number address information element contents

Information element	Length ₂	Value	Remarks
Called party short number address	8	0 to 255	See ETS 300 392-12-7 [16]

8.5.16 Called party Short Subscriber Identity (SSI)

The called party short subscriber identity information element shall indicate to the SwMI the Short Subscriber Identity (SSI) address of the called user as defined in table 8.129.

Table 8.129: Called party short subscriber identity information element contents

Information element	Length	Value	Remarks
Short subscriber identity	24	any	See EN 300 392-1 [1], clause 7

8.5.17 Called party type identifier

The called party type identifier information element shall indicate the type of address, which shall follow in the PDU as defined in table 8.130.

Table 8.130: Called party type identifier information element contents

Information element	Length	Value ₂	Remarks
Called party type identifier	3	000	Short Number Address (SNA)
		001	Short Subscriber Identity (SSI)
		010	Tetra Subscriber Identity (TSI = MNI+SSI)
		011	Reserved
		100	MT2 external subscriber number default gateway address

8.5.18 Calling party extension

The calling party extension information element shall indicate the extended part of the TSI address of the calling user as defined in table 8.131.

Table 8.131: Calling party extension information element contents

Information element	Length	Value	Remarks
Country Code	10	any	See EN 300 392-1 [1], clause 7
Network Code	14	any	See EN 300 392-1 [1], clause 7

8.5.19 Calling party Short Subscriber Identity (SSI)

The calling party short subscriber identity information element shall indicate the Short Subscriber Identity (SSI) address of the calling user as defined in table 8.132.

Table 8.132: Calling party short subscriber identity information element contents

Information element	Length	Value	Remarks
Short subscriber identity	24	any	See EN 300 392-1 [1], clause 7

8.5.20 Calling party type identifier

The calling party type identifier information element coding shall indicate the type of address, which shall follow in the PDU as defined in table 8.133.

Table 8.133: Calling Party Type Identifier information element contents

Information element	Length	Value	Remarks
Calling party type identifier	2	0	Reserved
		1	Short Subscriber Identity (SSI)
		2	Tetra Subscriber Identity (TSI = MNI + SSI)
		3	None

8.5.21 Call ownership

The call ownership information element in group call shall indicate to the MS whether it is capable to disconnect the call or not as defined in table 8.134. In individual call it shall indicate to both parties whether the call set up is for a normal or amalgamated call.

Table 8.134: Call ownership information element contents

Information element	Length	Value ₂	Remarks
Call ownership	1	0	Not a call owner (Group call) Normal call set up (Individual call)
		1	A call owner (Group call) Amalgamated call (Individual call)

8.5.22 Call priority

The call priority information element shall inform the SwMI or the MS/LS about the call priority as defined in table 8.135.

Table 8.135: Call priority information element contents

Information element	Length	Value ₂	Remarks
Call priority	4	0000	Priority not defined
		0001	Priority 1 (Lowest priority)
		0010	Priority 2
		etc.	etc.
		1011	Priority 11
		1100	Pre-emptive priority 1
		1101	Pre-emptive priority 2
		1110	Pre-emptive priority 3
1111	Pre-emptive priority 4		

8.5.23 Call queued

The call queued information element shall inform the calling MS/LS that the call has been put in queue as defined in table 8.136.

Table 8.136: Call queued information element contents

Information element	Length	Value ₂	Remarks
Call queued	1	0	Call is not queued
		1	Call is queued

8.5.24 Call status

The call status information element shall inform the MS/LS about the status of the call as defined in table 8.137.

Table 8.137: Call status information element contents

Information element	Length	Value ₂	Remarks
Call status	3	000	Call is progressing
		001	Call is queued
		010	Requested subscriber is paged
		011	Call Continue
		100	Hang time expired
		101	Reserved
		110	Reserved
		111	Reserved

8.5.25 Call time-out

The call time-out information element shall set the maximum call time (T310) as defined in table 8.138.

Table 8.138: Call time-out information element contents

Information element	Length	Value ₂	Remarks
Call time-out	4	0000	Infinite Time
		0001	30 s
		0010	45 s
		0011	60 s
		0100	2 minutes
		0101	3 minutes
		0110	4 minutes
		0111	5 minutes
		1000	6 minutes
		1001	8 minutes
		1010	10 minutes
		1011	12 minutes
		1100	15 minutes
		1101	20 minutes
		1110	30 minutes
1111	Reserved		

8.5.26 Call time-out, set-up phase

The call time-out, set-up phase information element (T301 and T302) shall set the maximum set-up time valid for the call set up phase as defined in table 8.139.

Table 8.139: Call time-out, set-up phase information element contents

Information element	Length	Value ₂	Remarks
Call time out, set-up phase	3	000	Use predefined value (note)
		001	1 s
		010	2 s
		011	5 s
		100	10 s
		101	20 s
		110	30 s
		111	60 s

NOTE: This value shall indicate that the MS/LS shall use a predefined value for the timer.

8.5.27 CC profile

The CC profile information element shall define operation of the TNP1 Relay for CC signalling messages as defined in table 8.140.

Table 8.140: CC profile information element contents

Information element	Length	Value	Remarks
Speech voice call control	1	0	Speech Voice call control - MT controlled
		1	Speech Voice call control - TE controlled
Data voice call control	1	0	Data Voice call control - MT controlled
		1	Data Voice call control - TE controlled

8.5.28 Circuit mode and MS services

The circuit mode and MS services information element shall list the circuit mode capabilities of the MT2 as defined in table 8.141. Table 8.141 contains information on which circuit mode types, as defined in clause 14.8.17a EN 300 392-2 [3], MT2 supports and includes a copy of table 16.30 "Class of MS information element contents" (e.g. table 167) in clause 16.10.5 of EN 300 392-2 [3] (V2.5.2). If there is any discrepancy between table 8.141 and table 16.30 (or equivalent table number, if changed due to re-numbering of tables) of EN 300 392-2 [3] shall take precedence. It shall not give any information of the capabilities of the underlying network. This information element shall contain sub-elements so that the total length₂ is 29 bits, which are encoded into four octets in the PDUs.

Table 8.141: Circuit mode and MS services information element contents

Information element	Length	Value ₂	Remarks
TETRA encoded speech	1	0	Not capable
		1	Capable
7,2 kbit/s unprotected data	1	0	Not capable
		1	Capable
4,8 kbit/s unprotected data, Interleaving depth = 1	1	0	Not capable
		1	Capable
4,8 kbit/s unprotected data, Interleaving depth = 4	1	0	Not capable
		1	Capable
4,8 kbit/s unprotected data, Interleaving depth = 8	1	0	Not capable
		1	Capable
2,4 kbit/s unprotected data, Interleaving depth = 1	1	0	Not capable
		1	Capable
2,4 kbit/s unprotected data, Interleaving depth = 4	1	0	Not capable
		1	Capable
2,4 kbit/s unprotected data, Interleaving depth = 8	1	0	Not capable
		1	Capable
Frequency simplex/duplex	1	0	Frequency simplex supported
		1	Frequency duplex and simplex supported
Single/multislot	1	0	Single slot supported
		1	Multislot and single slot supported
Concurrent multicarrier operation	1	0	Single carrier operation supported
		1	Multi and single carrier operation supported
Fast switching MS	1	0	Fast switching not supported
		1	Fast switching supported
DCK air interface encryption	1	0	DCK air interface encryption not supported
		1	DCK air interface encryption supported
CLCH needed on carrier change	1	0	No CLCH needed on carrier change
		1	CLCH needed on carrier change
Concurrent channels (Concurrent services)	1	0	Concurrent channels not supported
		1	Concurrent channels supported
Advanced link	1	0	Advanced link not supported
		1	Advanced link supported
Minimum mode	1	0	Minimum mode not supported
		1	Minimum mode supported

Information element	Length	Value ₂	Remarks
Carrier specific signalling channel	1	0	Carrier specific signalling channel not supported
		1	Carrier specific signalling channel supported
Authentication	1	0	Authentication not supported
		1	Authentication supported
SCK air interface encryption	1	0	SCK air interface encryption not supported
		1	SCK air interface encryption supported
TETRA air interface standard version number	3	000	EN 300 392-2 [3], no security functions
		001	EN 300 392-2 [3] and EN 300 392-7 [20] V2.1.1
		010	EN 300 392-2 [3] V2.3.2 to TS 100 392-2 [22] V2.6.1 and EN 300 392-7 [20] V2.1.1 to TS 100 392-2 [22] V2.4.1
		011	EN 300 392-2 [3] V3.1.1 to V3.3.1 and EN 300 392-7 [20] V3.1.1
		100	Reserved
		etc.	etc.
		111	Reserved
Common SCCH	1	0	Common SCCH not supported
		1	Common SCCH supported
Reserved	1	0	Default value
		1	Reserved for future expansion
Reserved	1	0	Default value
		1	Reserved for future expansion
Reserved	1	0	Default value
		1	Reserved for future expansion
Reserved	1	0	Default value
		1	Reserved for future expansion

8.5.29 Circuit mode data

The circuit mode data information element shall carry data related to circuit mode traffic as defined in table 8.142.

Table 8.142: Circuit mode data information element contents

Information element	Length ₂	Value	Remarks
Circuit mode data	varies	any	

8.5.30 Class of usage

The class of usage information element shall be encoded and defined in table 8.143.

Table 8.143: Class of usage information element contents

Information element	Length	Value ₂	Remarks
Class of usage	3	000	Class of Usage 1
		001	Class of Usage 2
		010	Class of Usage 3
		011	Class of Usage 4
		100	Class of Usage 5
		101	Class of Usage 6
		110	Class of Usage 7
		111	Class of Usage 8

8.5.31 CLIR control

The CLIR control information element shall be encoded as defined in table 8.144.

Table 8.144: CLIR control information element contents

Information element	Length	Value ₂	Remarks
CLIR control	2	00	Not implemented or use default mode
		01	Reserved
		10	Presentation not restricted
		11	Presentation restricted

8.5.32 CONTEXT_READY timer

The CONTEXT_READY timer information element shall be encoded as defined in table 8.145.

Table 8.145: Context of the CONTEXT_READY timer information element

Information element	Length	Value	Remark
CONTEXT READY timer	4	0	track READY timer
		1	200 ms
		2	500 ms
		3	700 ms
		4	1 s
		5	2 s
		6	3 s
		7	5 s
		8	10 s
		9	20 s
		10	30 s
		11	60 s
		12	120 s
		13	180 s
14	300 s		

8.5.33 Data class

The Data class information element shall be encoded as defined in table 8.146.

Table 8.146: Context of the Data class information element

Information element	Length	Value	Remark
Data class	2	0	Real time class - layer 2 link optimized for data which cannot tolerate delivery delay (late packets discarded by the receiving application)
		1	Telemetry class - layer 2 link optimized for intermittent data which can tolerate moderate delivery delay and packet loss
		2	Background class - layer 2 link optimized for data which are intolerant of packet loss

8.5.34 Data handle

The Data handle information element shall be encoded as defined in table 8.147.

Table 8.147: Context of the Data handle information element

Information element	Length	Value	Remark
Data handle	32	0 - ($2^{32} - 1$)	This parameter is only used in "Bypass to SNDCP" mode and mimics the SNDCP Data Handle parameter. See EN 300 392-2 [3], clause 28.1 for a full definition as applied to SN-DATA and SN-UNITDATA

8.5.35 Data importance

The Data importance information element shall be encoded as defined in table 8.148.

Table 8.148: Context of the Data importance information element

Information element	Length	Value	Remark
Data importance	2	0	Low
		1	Medium
		2	High

8.5.36 Data priority

The Data priority information element shall be encoded as defined in table 8.149.

Table 8.149: Context of the Data priority information element

Information element	Length	Value	Remark
Data priority	3	0	Priority 0 (lowest)
		1	Priority 1
		2	Priority 2
		3	Priority 3
		4	Priority 4
		5	Priority 5
		6	Priority 6
		7	Priority 7 (highest)

8.5.37 DCOMP

The DCOMP information element shall be encoded as defined in table 8.150.

Table 8.150: Context of the DCOMP information element

Information element	Length	Value	Remark
DCOMP	4	0	No compression
		1	ITU-T Recommendation V.42bis [27]
		2	BSD compression
		3	Predictor compression
		4	BSD uncompressible packet
		Others	Reserved for further compression algorithms(a list of fixed or negotiated algorithms e.g. PKZIP, FAX, MPEG)

8.5.38 Delay class

The Delay class information element shall be encoded as defined in table 8.151.

Table 8.151: Context of the Delay class information element

Information element	Length	Value	Remark
Delay class	2	0	Low
		1	Moderate
		2	High
		3	Unpredictable

8.5.39 Delivery report request

The delivery report request information element shall be encoded as defined in table 8.152.

Table 8.152: Delivery report request information element contents

Information element	Length	Value ₂	Remarks
Delivery report request	2	00	No delivery report request
		01	Message received report requested
		10	Message consumed report requested
		11	Message received and consumed report requested

8.5.40 Delivery status

The delivery status information element shall be encoded as defined in table 8.153.

Table 8.153: Delivery status information element contents

Information element	Length	Value	Remarks	Report source
Delivery status	8	000xxxx ₂	SDS data transfer success	-
		0000000 ₂	SDS receipt acknowledged by destination	Destination
		00000001 ₂	SDS receipt report acknowledgement	SwMI/Source
		00000010 ₂	SDS consumed by destination	Destination
		00000011 ₂	SDS consumed report acknowledgement	SwMI/Source
		00000100 ₂	SDS message forwarded to external network	SwMI
		00000101 ₂	SDS sent to group, acknowledgements prevented	SwMI
		00000110 ₂ to 00011111 ₂	Reserved	-
		001xxxx ₂	Temporary error, SwMI still trying to transfer SDS data	-
		00100000 ₂	Congestion, message stored by SwMI	SwMI
		00100001 ₂	message stored by SwMI	SwMI
		00100010 ₂	Destination not reachable, message stored by SwMI	SwMI
		00100011 ₂ to 00111111 ₂	Reserved	-
		010xxxx ₂	SDS data transfer failed, SwMI is not making any more transfer attempts	-
		01000000 ₂	Network overload	SwMI
		01000001 ₂	Service permanently not available on BS	SwMI
		01000010 ₂	Service temporary not available on BS	SwMI

Information element	Length	Value	Remarks	Report source
		01000011 ₂	Source is not authorized for SDS	SwMI
		01000100 ₂	Destination is not authorized for SDS	SwMI
		01000101 ₂	Unknown destination, gateway, or service centre address	SwMI
		01000110 ₂	Unknown forward address	SwMI
		01000111 ₂	Group address with individual service	SwMI
		01001000 ₂	Validity period expired, message not received by far end	SwMI
		01001001 ₂	Validity period expired, message not consumed by far end	SwMI
		01001010 ₂	Delivery failed	SwMI
		01001011 ₂	Destination not registered on system	SwMI
		01001100 ₂	Destination queue full	SwMI
		01001101 ₂	Message too long for destination or gateway	SwMI
		01001110 ₂	Destination does not support SDS-TL data transfer service PDUs	SwMI/Destination
		01001111 ₂	Destination host not connected	Destination
		01010000 ₂	Protocol not supported	Destination
		01010001 ₂	Data coding scheme not supported	Destination
		01010010 ₂	Destination memory full, message discarded	Destination
		01010011 ₂	Destination not accepting SDS messages	SwMI
		01010100 ₂	Reserved	-
01010101 ₂	Reserved	-		
		01010110 ₂	Destination address administratively prohibited	SwMI
		01010111 ₂	Can not route to external network	SwMI
		01011000 ₂	Unknown external subscriber number	SwMI
		01011001 ₂	Negative report acknowledgement	Source
		01011010 ₂	Destination not reachable, message delivery failed	SwMI
		01011011 ₂ to 01011111 ₂	Reserved	-
		011xxxx ₂	Flow control messages	-
		01100000 ₂	Destination memory full	Destination
		01100001 ₂	Destination memory available	Destination
		01100010 ₂	Start pending messages	Destination
		01100011 ₂	No pending messages	SwMI
		01100100 ₂ to 01111111 ₂	Reserved	-
		100xxxx ₂	End to end control messages	-
		10000000 ₂	Stop sending	Destination
		10000001 ₂	Start sending	Destination
		10000010 ₂ to 10011111 ₂	Available for user application definition, note	Destination
		101xxxx ₂ to 111xxxx ₂	Reserved for future use	-

NOTE: These values may be co-ordinated outside the scope of the present document in order to prevent clashed.

8.5.41 Device address

The Device address information element shall be encoded as defined in table 8.154.

Table 8.154: Context of the Device address information element

Information element	Length	Value	Remark
Device address	32	Variable	Device address on which a new PCON has been created. Actual format is dependent on the specific physical connection technology used

8.5.42 Direct mode

The direct mode information element shall be encoded as defined in table 8.155.

Table 8.155: Direct mode information element contents

Information element	Length	Value	Remarks
Direct mode	1	1	Start of direct mode operation

8.5.43 Disconnect type

The disconnect type information element shall be encoded as defined in table 8.156.

Table 8.156: Disconnect type information element contents

Information element	Length	Value	Remarks
Disconnect type	2	00	Disconnect call
		01	Leave call without disconnection
		10	Leave call temporarily
		11	Reserved

8.5.44 DTMF result

The DTMF information element shall be encoded as defined in table 8.157.

Table 8.157: DTMF Result element contents

Information element	Length	Value	Remarks
DTMF Result	1	0	DTMF not supported
		1	DTMF not subscribed

8.5.45 Disconnect cause

The disconnect cause information element shall inform the MS/LS or the infrastructure of the reason for the release/disconnection as defined in table 8.158.

Table 8.158: Disconnect cause information element contents

Information element	Length	Value ₂	Remarks
Disconnect cause	5	00000	Cause not defined or unknown
		00001	User requested disconnect
		00010	Called party busy
		00011	Called party not reachable
		00100	Called party does not support encryption
		00101	Congestion in infrastructure
		00110	Not allowed traffic case
		00111	Incompatible traffic case
		01000	Requested service not available
		01001	Pre-emptive use of resource
		01010	Invalid Call Identifier
		01011	Call Rejected by the called party
		01100	No idle CC entity
		01101	Expiry of timer
		01110	SwMI requested Disconnection
		01111	Acknowledged Service not completed
		10000	Reserved
etc.	etc.		
11111	Reserved		

8.5.46 Disconnect status

The disconnect status information element shall be encoded as defined in table 8.159.

Table 8.159: Disconnect status information element contents

Information element	Length	Value	Remarks
Disconnect status	2	00	Disconnect successful
		01	Disconnect unsuccessful, the release is released from the call
		10	Disconnection unsuccessful, not the call owner, the user is released from the call
		11	The user is released from the call

8.5.47 DTMF digits

The DTMF information element shall allow the transfer of DTMF digits (n digits where n shall be less than or equal to 255) to another user application. Each digit shall be encoded as defined in table 8.160.

Table 8.160: DTMF information element contents

Information element	Length	Value ₂	Remarks
DTMF digit	4	0000	Digit "0"
		0001	Digit "1"
		0010	Digit "2"
		0011	Digit "3"
		0100	Digit "4"
		0101	Digit "5"
		0110	Digit "6"
		0111	Digit "7"
		1000	Digit "8"
		1001	Digit "9"
		1010	Digit "*"
		1011	Digit "#"
		1100	Digit "A"
		1101	Digit "B"
1110	Digit "C"		
1111	Digit "D"		

8.5.48 DTMF tone delimiter

The DTMF tone delimiter information element is defined in table 8.161.

Table 8.161: DTMF tone delimiter information element contents

Information element	Length	Value	Remarks
DTMF tone delimiter	1	0	DTMF tone start
		1	DTMF tone end

8.5.49 Dual watch

The dual watch information element is defined in table 8.162.

Table 8.162: Dual Watch information element contents

Information element	Length	Value ₂	Remarks
Dual watch	4	0000	Starting dual watch mode
		0001	Modify or resume dual watch mode
		0010	Dual watch mode accepted
		0011	Dual watch mode rejected
		0100	Dual watch mode not supported
		0101	Terminating dual watch mode
		0110	Terminating dual watch mode response
		0111	Dual watch energy economy group changed by SwMI
		1000	Dual watch mode terminated by SwMI

8.5.50 Enable/Disable status

The Enable/disable status information element shall indicate which of the enable/disable status types (i.e. temporary or permanent) for TEI or equipment is requested as defined in table 8.163.

Table 8.163: Enable/disable status information element contents

Information element	Length	Value	Remarks
Enable/disable status	2	0	Enabled
		1	Temporary disabled
		2	Permanent disabled
		3	Not used

8.5.51 End to end encryption flag

The end-to-end encryption flag information element shall indicate/request for end-to-end encryption, as defined in table 8.164.

Table 8.164: End-to-end encryption flag information element contents

Information element	Length	Value	Remarks
End to end encryption flag	1	0	Clear
		1	End to End encrypted

8.5.52 Endpoint address

The Endpoint address information element shall be encoded as defined in table 8.165.

Table 8.165: Context of the Endpoint address information element

Information element	Length	Value	Remark
Endpoint address	32	Variable	Endpoint address assigned by MT2 on creation of a new PCON. Range of valid addresses is dependent on the specific physical connection technology used. Where there is an addressing distinction relating to the direction of flow (as in USB), this address shall refer to the TE2 to MT2 direction

8.5.53 Energy economy mode

The energy economy mode information element shall be used to indicate which energy saving scheme is requested (if any) as defined in table 166.

Table 8.166: Energy economy mode information element contents

Information element	Length	Value ₂	Remarks
Energy economy mode	3	000	Stay alive
		001	Economy mode 1 (EG1)
		010	Economy mode 2 (EG2)
		011	Economy mode 3 (EG3)
		100	Economy mode 4 (EG4)
		101	Economy mode 5 (EG5)
		110	Economy mode 6 (EG6)
		111	Economy mode 7 (EG7)

8.5.54 Energy economy mode status

The energy economy mode status information element shall be encoded as defined in table 8.167.

Table 8.167: Energy economy mode status information element contents

Information element	Length	Value	Remarks
Energy economy mode status	1	0	Accepted
		1	Rejected

8.5.55 External subscriber number

The external subscriber number information element is a structure with two fields. First a length element, second the list of digits. The external subscriber number information element shall be encoded as described in table 8.168.

Table 8.168: External subscriber number information element contents

Information element	Length	Remarks
Number of digits	8	See notes 2 and 3
External subscriber number digit	4	See note 1
NOTE 1: This information element shall be repeated according to the number of digits.		
NOTE 2: The number of digits will be 0 if no external number is present.		
NOTE 3: When building the PDUs, if the number of digits is odd then the value 1111 ₂ will be appended to the end of the string of digits.		

8.5.56 External subscriber number digits

Each digit in the external subscriber number information element shall be as defined in table 8.169.

Table 8.169: External subscriber digit information element contents

Information element	Length	Value ₂	Remarks
External subscriber number digit	4	0000	Digit "0"
		0001	Digit "1"
		0010	Digit "2"
		0011	Digit "3"
		0100	Digit "4"
		0101	Digit "5"
		0110	Digit "6"
		0111	Digit "7"
		1000	Digit "8"
		1001	Digit "9"
		1010	Digit "*"
		1011	Digit "#"
		1100	Digit "+"
		1101	Reserved
		1110	Reserved
1111	Reserved		

8.5.57 Facility

The facility information element is an optional variable length information element and shall be used to send and receive SS information appended to the PDUs, which can carry the facility information element.

The size and the structure of the facility information element are dependent on each individual SS and shall be further detailed in the SS protocol clauses.

There can be multiple facility information elements in the same PDU.

8.5.58 Field strength

The field strength information element shall indicate the current field strength detected by the MT2 as defined in table 8.170. See EN 300 392-2 [3], clause 10.3.

Table 8.170: Field strength information element contents

Information element	Length	Value	DBm	Remarks
Field strength	7	0	-	Parameter not available
		1	-115	
		2	-114	
		etc.	etc.	
		65	-51	
		66	-50	
		67	More than -50	
		68		Reserved
		etc.	-	etc.
		98	-	Reserved
		99	-	Not know or not detectable
		100	-	Reserved
		etc.	-	etc.
		127	-	Reserved

8.5.59 Forward address type identifier

The forward address type identifier information element coding shall indicate the type of address as defined in table 8.171.

Table 8.171: Forward address type identifier information element contents

Information element	Length	Value	Remarks
Forward address type identifier	4	0000	SNA
		0001	Short Subscriber Identity (SSI)
		0010	Tetra Subscriber Identity (TSI)
		0011	External Subscriber Number
		0100	Reserved
		etc.	etc.
		1111	Reserved

8.5.60 Function

The function information element shall associate a predefined function to the PDU as defined in table 8.172.

Table 8.172: Function information element contents

Information element	Length	Value ₂	Remarks
Function	7	0000000	Available for proprietary user applications
		etc.	etc.
		0111111	Available for proprietary user applications
		1000000	Reserved
		etc.	etc.
		1111111	Reserved

8.5.61 Group identity address type

The group identity address type information element shall indicate type of group identity address type in the attachment/detachment of group identities as defined in table 8.173.

Table 8.173: Group identity address type information element contents

Information element	Length	Value	Remarks
Group identity address type	2	0	GSSI
		1	GTSI
		2	(V)GSSI
		3	GTSI+(V)GSSI

8.5.62 Group identity attach/detach mode

The group identity attach/detach mode information element shall indicate the mode of the attachment/detachment of group identities as defined in table 8.174.

Table 8.174: Group identity attach/detach mode information element contents

Information element	Length	Value	Remarks
Group Identity Attach/Detach Mode	1	0	Amendment
		1	Detach all currently active group identities and attach group identities defined in the group identity (downlink/uplink) element (if any)

8.5.63 Group identity attach/detach type identifier

The group identity attach/detach type identifier information element shall be encoded as defined in table 8.175.

Table 8.175: Group identity attach/detach type identifier information element contents

Information element	Length	Value	Remarks
Group identity attach/detach type identifier	1	0	Attached
		1	Detached

8.5.64 Group identity attachment

The group identity attachment information element shall be encoded as defined in table 8.176.

Table 8.176: Group identity attachment information element contents

Information element	Length	Value	Remarks
Group identity attachment lifetime	2	any	
Class of usage	3	any	

8.5.65 Group identity attachment lifetime

The group identity attachment lifetime information element shall indicate a lifetime of the attachment of the group identity defined by the infrastructure for a MS as defined in table 8.177.

Table 8.177: Group identity attachment lifetime information element contents

Information element	Length	Value	Remarks
Group identity attachment lifetime	2	00	Attachment not needed
		01	Attachment for next ITSI attach required
		10	Attachment not allowed for next ITSI attach
		11	Attachment for next location update required

8.5.66 Group identity detachment downlink

The group identity detachment information element shall indicate the infrastructure detachment reasons as defined in table 8.178.

Table 8.178: Group identity detachment downlink information element contents

Information element	Length	Value ₂	Remarks
Group identity detachment downlink	2	00	Unknown group identity (note)
		01	Temporary 1 detachment (note)
		10	Temporary 2 detachment (note)
		11	Permanent detachment (note)
NOTE: All these values are network dependent.			

8.5.67 Group identity detachment uplink

The group identity detachment uplink information element shall indicate the MS detachment reasons as defined in table 8.179.

Table 8.179: Group identity detachment uplink information element contents

Information element	Length	Value	Remarks
Group identity detachment uplink	2	0	Unknown group identity
		1	No valid encryption key (end-to-end)
		2	User initiated
		3	Capacity exceeded

8.5.68 Group identity downlink

The group identity downlink information element shall be used to join the parameters for a group identity attachment/detachment used by the infrastructure as defined in table 8.180.

Table 8.180: Group identity downlink information element contents

Information element	Length	Value	Type	C/O/M	Remarks
Group identity attach/detach type identifier	1	any	1	M	
Group identity attachment	5	any		C	See note 1
Group identity detachment downlink	2	any		C	See note 1
Group identity address type	2	any	1	M	
GSSI	24	any		C	See note 2
Address extension	24	any		C	See note 2
NOTE 1: Shall be conditional on the value of Group Identity Attach/Detach Type Identifier (GIADTI):					
- GIADTI = 0; Group Identity Attachment;					
- GIADTI = 1; Group Identity Detachment Downlink.					
NOTE 2: Shall be conditional on the value of Group Identity Address Type (GIAT):					
- GIAT = 0; GSSI;					
- GIAT = 1; GSSI + Address Extension (GTSI).					

8.5.69 Group identity report

The group identity report information element shall indicate whether all MSs active group identities shall be reported as defined in table 8.181.

Table 8.181: Group identity report information element contents

Information element	Length	Value	Remarks
Group identity report	1	0	Not report request
		1	Report request

8.5.70 Group identity uplink

The group identity uplink information element shall be used to join the parameters for a group identity attachment/detachment used by the MS as defined in table 8.182.

Table 8.182: Group identity uplink information element contents

Information element	Length	Value	Type	C/O/M	Remarks
Group identity attach/detach type identifier	1	any	1	M	
Class of usage	3	any		C	See note 1
Group identity detachment uplink	2	any		C	See note 1
Group identity address type	2	any	1	M	
GSSI	24	any		C	See note 2
Address extension	24	any		C	See note 2
NOTE 1: Shall be conditional on the value of Group Identity Attach/Detach Type Identifier (GIADTI):					
- GIADTI = 0; Class of Usage;					
- GIADTI = 1; Group Identity Detachment uplink.					
NOTE 2: Shall be conditional on the value of Group Identity Address Type (GIAT):					
- GIAT = 0; GSSI;					
- GIAT = 1; GSSI + Address Extension (GTSI).					

8.5.71 Group Short Subscriber Identity (GSSI)

The GSSI information element shall indicate the GSSI or (V) GSSI that the MS shall use in subsequent contacts with the SwMI, as defined in table 8.183.

Table 8.183: Group Short Subscriber Identity information element contents

Information element	Length	Value	Remarks
GSSI	24	any	See EN 300 392-1 [1]

8.5.72 GTSI

The ITSI information element shall indicate a group identity as defined in table 8.184.

Table 8.184: GTSI information element contents

Information element	Length	Value	Remarks
Group Short Subscriber Identity (GSSI)	24	any	See EN 300 392-1 [1]
Address extension	24	any	See EN 300 392-1 [1]

8.5.73 Hardware version

The hardware version information element shall inform the TE2 user application about the MT2 hardware version as defined in table 8.185. The total number of characters, including line terminators, shall not exceed 128 characters.

Table 8.185: Hardware version information element contents

Information element	Length	Value	Remarks
Hardware version	n x 8	any	8 bits for each ASCII alphabet character

8.5.74 Hook method selection

The hook method selection information element shall inform the infrastructure and the called user(s) of the preferred hook method as defined in table 8.186.

Table 8.186: Hook method selection information element contents

Information element	Length	Value	Remarks
Hook method selection	1	0	No hook signalling (direct through-connect)
		1	Hook on/Hook off signalling

8.5.75 Internal temperature

The internal temperature information element shall indicate the MT2 temperature as defined in table 8.187.

Table 8.187: Internal temperature information element contents

Information element	Length	Value	Remarks
Temperature scale	1	0	Celsius
		1	Fahrenheit
Temperature sign	1	0	Positive degree
		1	Negative degree
Temperature degree	8	0 to 255	
Temperature sub degree	4	0 to 15	Additional 1/16 degree precision
Reserved	2	00	Reserved

EXAMPLE: 1 0 00100101 0001 00 means: Celsius, positive, $37 + 1/16$ degrees.

8.5.76 ISO global object ID

The ISO global object ID information element shall inform the TE2 user application about the MT2 identification in terms of global ISO definition as defined in table 8.188. The characters shall be aligned sequentially. The total number of characters, including line terminators, shall not exceed 256 characters.

Table 8.188: ISO global object ID information element contents

Information element	Length	Value	Remarks
ISO global object ID	$n \times 8$	any	8 bits for each ASCII alphabet character

8.5.77 ITSI

The ITSI information element shall indicate identity of the radio as defined in table 8.189.

Table 8.189: ITSI information element contents

Information element	Length	Value	Remarks
SSI	24	any	ISSI of the MS
Address extension	24	any	MNI of the MS

8.5.78 Key Mask

The key mask information element indicates type of keys that shall appear in the request and be checked among SDS stack messages. The key mask can include multiple keys as defined in table 8.190.

Table 8.190: Key mask information element contents

Information element	Length	Value ₂	Remarks
Key mask	4	1111	All keys shall appear
		0001	SDS type
		0010	SDS message status
		0011	SDS type and SDS message status
		0100	Reserved
		etc.	etc.
		1110	Reserved

8.5.79 LA

The LA information element shall indicate the area in which a cell is located, either the serving cell or a neighbour cell as define in table 8.191.

Table 8.191: Location area information element contents

Information element	Length	Value	Remarks
LA	14	any	

8.5.80 Length indicator

The length indicator information element shall define the length of the next information element such as Application user data as defined in table 8.192.

Table 8.192: Length indicator information element contents

Information element	Length	Value	Remarks
Length indicator	11	0	0 bits
		1	1 bit
		etc.	etc.
		$2^{11} - 1$	2 047 bits

8.5.81 Manufacturer identifier

The manufacturer identifier information element shall inform the TE2 user application about the manufacturer of the MT2 as defined in table 8.193.

Table 8.193: Manufacturer IDENTIFIER information element contents

Information element	Length	Value	Remarks
Manufacturer identifier	n x 8	any	8 bits for each ASCII alphabet character

8.5.82 Max data

The max data information element shall indicate how much data MT2 can accept from TE2 as defined in table 8.194. The amount of data shall be measured in timeslots as used in the current circuit mode type.

Table 8.194: Max DATA information element contents

Information element	Length	Value	Remarks
Max data	8	0	No data
		1	1 timeslot
		2	2 timeslots
		etc.	etc.
		$(2^8 - 1)$	255 timeslots

8.5.83 Maximum transmission unit

The Maximum transmission unit information element shall be encoded as defined in table 8.195.

Table 8.195: Context of the Maximum transmission unit information element

Information element	Length	Value	Remark
Maximum transmission unit	3	0	Reserved
		1	296 octets
		2	576 octets
		3	1 006 octets
		4	1 500 octets
		5	2 002 octets
		6	Reserved
		7	Reserved

8.5.84 MCC

The MCC information element shall indicate the mobile country code, as defined in table 8.196.

Table 8.196: MCC information element contents

Information element	Length	Value	Remarks
MCC	10	any	See EN 300 392-1 [1], clause 7

8.5.85 Mean active throughput

This is the mean active throughput of N PDUs expected by the SNDCP service user while the PDP context's CONTEXT_READY timer is active. The values are the same as minimum peak throughput.

8.5.86 Mean throughput

This is the mean throughput of N PDUs expected by the SNDCP service user, averaged over the expected lifetime of the PDP context. It is given in units of octets/h.

The Mean throughput information element shall be encoded as defined in table 8.197.

Table 8.197: Context of the Mean throughput information element

Information element	Length	Value	Remark
Mean throughput	5	0	No value given
		10	100 (~0,22 bits/s)
		2	200 (~0,44 bits/s)
		3	500 (~1,11 bits/s)
		4	1 000 (~2,2 bits/s)
		5	2 000 (~4,4 bits/s)
		6	5 000 (~11,1 bits/s)
		7	10 000 (~22 bits/s)
		8	20 000 (~44 bits/s)
		9	50 000 (~111 bits/s)
		10	100 000 (~0,22 kbits/s)
		11	200 000 (~0,44 kbits/s)
		12	500 000 (~1,11 kbits/s)
		13	1 000 000 (~2,2 kbits/s)
		14	2 000 000 (~4,4 kbits/s)
		15	5 000 000 (~11,1 kbits/s)
		16	10 000 000 (~22 kbits/s)
		17	20 000 000 (~44 kbits/s)
		18	50 000 000 (~111 kbits/s)
		19	Reserved
etc.	etc.		
30	Reserved		
31	Best effort		

8.5.87 Message index

The message index information element shall point to an SDS message in the MT2 SDS message stack (stack for SDS status, SDS1/2/3 or SDS 4), as defined in table 8.198.

Table 8.198: Message index information element contents

Information element	Length	Value	Remarks
Message index	16	0 to 65 535	

8.5.88 Message reference

The message reference information element shall be as defined in table 8.199.

Table 8.199: Message reference information element contents

Information element	Length	Value	Remarks
Message reference	8	0 to 255	

8.5.89 Message reference handle

The message reference handle information element shall be as defined in table 8.200.

Table 8.200: Message reference handle information element contents

Information element	Length	Value	Remarks
Message reference handle	8	0 to 255	

8.5.90 MEX capability

The MEX capability information element shall be encoded as defined in table 8.201.

Table 8.201: Context of the MEX capability information element

Information element	Length	Value	Remark
MEX capability	1	0	MEX precedence is not supported
		1	MEX precedence is supported

8.5.91 MEX connect reject cause

The MEX connect reject cause information element shall be encoded as defined in table 8.202.

Table 8.202: Context of the MEX connect reject cause information element

Information element	Length	Value	Remark
MEX connect reject cause	6	0	Undefined
		1	MS not provisioned for Packet Data
		2	IPv4 not supported
		3	IPv6 not supported
		4	IPv4 dynamic address negotiation not supported
		5	IPv6 stateful address autoconfiguration not supported
		6	IPv6 stateless address autoconfiguration not supported
		7	Dynamic address pool empty
		8	Static address not correct
		9	Static address in use
		10	Static address not allowed
		11	Static IP address congestion
		12	TETRA Packet Data not supported on this location area
		13	TETRA Packet Data not supported on this network
		14	Temporary rejection
		15	Packet Data MS Type not supported
		16	SNDCP version not supported
		17	Mobile IPv4 not supported
		18	Mobile IPv4 Co located Care of Addresses not supported
		19	Maximum allowed PDP contexts per ITSI exceeded
		20	User authentication failed
		21	Activation rejected by external PDN
		22	Access point name index not correct
		23	No response from network
		24	Bad response from network
		25	NSAPI not available
		26	NSAPI already allocated
		27	Requested minimum peak throughput not available
		28	Scheduled access not supported
		29	Requested schedule not available
		30	Requested QoS not available
		31	Secondary PDP context does not exist
		32	Primary PDP context does not exist
		33	Asymmetric QoS not supported
		34	Automatic QoS filter not supported
		35	Specified QoS filter not supported
36	QoS filter type not supported		

8.5.92 MEX connect report

The MEX connect report information element shall be encoded as defined in table 8.203.

Table 8.203: Context of the MEX connect report information element

Information element	Length	Value	Remark
MEX connect report	2	0	Failure
		1	Success (not used in "Bypass to SNDPC" mode)
		2	Success (QoS parameters changed)

8.5.93 MEX deactivation type

The MEX deactivation type information element shall be encoded as defined in table 8.204.

Table 8.204: Context of the MEX deactivation type information element

Information element	Length	Value	Remark
MEX deactivation type	2	0	Deactivate all NSAPIs
		1	Deactivate all MEX contexts
		2	Deactivate MEX context given in the PDU

8.5.94 MEX delivery header

The MEX delivery header information element shall be encoded as defined in table 8.205.

Table 8.205: Context of the MEX delivery header information element

Information element	Length	Value	Remark
MEX delivery header	≤ 672	Varies	This parameter consists of the full IP header plus the first 64 bytes of data of the IP packet for delivery failed

8.5.95 MEX delivery report

The MEX delivery report information element shall be encoded as defined in table 8.206.

Table 8.206: Context of the MEX delivery report information element

Information element	Length	Value	Remark
MEX delivery report	3	0	Success
		1	Failure
		2	Deleted or cancelled by SNDPC
		3	Packet exceeds MTU (only used if MEX Handle represents "Use MEX")
		4	Packet was surplus to schedule (only used if MEX Handle represents "Use MEX")

8.5.96 MEX escalate DSCP5 flag enable

The MEX escalate DSCP5 flag enable information element shall be encoded as defined in table 8.207.

Table 8.207: Context of the MEX escalate DSCP5 flag enable information element

Information element	Length	Value	Remark
MEX escalate DSCP5 flag enable	1	0	DSCP bit 5 is not used for priority escalation
		1	DSCP bit 5 is used for priority escalation

8.5.97 MEX escalate DSCP5 flag reset

The MEX escalate DSCP5 flag reset information element shall be encoded as defined in table 8.208.

Table 8.208: Context of the MEX escalate DSCP5 flag reset information element

Information element	Length	Value	Remark
MEX escalate DSCP5 flag reset	1	0	MEX Escalate Flag Reset bit 5 of DSCP is not reset
		1	MEX Escalate Flag Reset bit 5 of DSCP is automatically reset by MEX

8.5.98 MEX filter - diffserv

The MEX filter - diffserv information element shall be encoded as defined in table 8.209.

Table 8.209: Context of the MEX filter - diffserv information element

Information element	Length	Value	Remark
MEX diffserv	8	Varies	Takes any legitimate value for the IP header Differentiated Services Code Point (DSCP) field

8.5.99 MEX filter - port range

The MEX filter - port range information element shall be encoded as defined in table 8.210.

Table 8.210: Context of the MEX filter - port range information element

Information element	Length	Value	Remark
MEX Port - lower	16	0 - 65 535	Lower of TCP/UDP port number in a range
MEX Port - upper	16	0 - 65 535	Upper of TCP/UDP port number in a range

8.5.100 MEX filter operation

The MEX filter operation information element shall be encoded as defined in table 8.211.

Table 8.211: Context of the MEX filter operation information element

Information element	Length	Value	Remark
MEX filter operation	2	0	Add this QoS filter to any existing QoS filter for this PDP context
		1	Replace any existing QoS filter for this PDP context by this QoS filter
		2	Remove this QoS filter the existing QoS filter for this PDP context

8.5.101 MEX filter type

The MEX filter type information element shall be encoded as defined in table 8.212.

Table 8.212: Context of the MEX filter type information element

Information element	Length	Value	Remark
MEX filter type	3	0	Automatic
		1	All port types
		2	UDP only
		3	TCP only
		4	Diffserv

NOTE: Diffserv is not applicable to either the "Automatic Uplink Filter" or "Automatic Downlink Filter", MEX Transaction types.

8.5.102 MEX handle

The MEX handle information element shall be encoded as defined in table 8.213.

Table 8.213: Context of the MEX handle information element

Information element	Length	Value	Remark
MEX handle	8	0	Bypass to SNDSCP, see note 1
		1 to 254	Use MEX, see note 2
		255	No valid MEX handle, see note 3
NOTE 1: No MEX handle. Used to support legacy applications requiring a simply defined PDP context.			
NOTE 2: These values shall be valid handle identifiers.			
NOTE 3: Used to indicate failure to generate a valid handle. Only used in confirmation or indication PDUs.			

8.5.103 MEX mode

The MEX mode information element shall be encoded as defined in table 8.214.

Table 8.214: Context of the MEX mode information element

Information element	Length	Value	Remark
MEX mode	2	0	Use MEX
		1	Bypass to SNDSCP
		2	Deallocate handle

8.5.104 MEX modify reject cause

The MEX modify reject cause information element shall be encoded as defined in table 8.215.

Table 8.215: Context of the MEX modify reject cause information element

Information element	Length	Value	Remark
MEX modify reject cause	4	0	Undefined
		1	Temporary rejection
		2	No response from network
		3	Bad response from network
		4	NSAPI not activated
		5	Requested minimum peak throughput not available
		6	Scheduled access not supported
		7	Requested schedule not supported
		8	Requested QoS not available

8.5.105 MEX Modify report

This has two variants, depending on the MEX mode: Use MEX mode and Bypass MEX mode.

8.5.105.1 Use MEX mode

The Use MEX mode information element shall be encoded as defined in table 8.216.

Table 8.216: Context of the Use MEX mode information element

Information element	Length	Value	Remark
MEX Modify report (Use MEX mode)	2	0	Failure (No parameters are change from their previous value)
		1	Success Local (One or more of MEX Precedence, PDU Priority, Data Importance, Data Priority have changed from their previous value)
		2	Success (One or more of the MEX NSAPI QoS parameters were changed from their previous value)
		3	Full Success (All requested parameter changes have been made)

8.5.105.2 Bypass to SNDCP mode

The Bypass to SNDCP mode information element shall be encoded as defined in table 8.217.

Table 8.217: Context of the Bypass to SNDCP mode information element

Information element	Length	Value	Remark
MEX Modify report (Bypass to SNDCP mode)	2	0	Failure (the NSAPI QoS negotiation parameter was not changed from its previous value)
		1	Success (one or more of the items in the NSAPI QoS negotiation parameter were changed from their previous values)

8.5.106 MEX N-PDU

The MEX N-PDU information element shall be encoded as defined in table 8.218.

Table 8.218: Context of the MEX N-PDU information element

Information element	Length	Value	Remark
MEX N-PDU	20 - 65 535 octets	Varies	This contains the IP packet to be passed to/from SNDCP; its length is determined from the length of the UDP packet delivering the TNP1 TEMX-DATA message

8.5.107 MEX NSAPI usage

The MEX NSAPI usage information element shall be encoded as defined in table 8.219.

Table 8.219: Context of the MEX NSAPI usage information element

Information element	Length	Value	Remark
MEX NSAPI usage	1	0	Schedule paused
		1	PDP context paused

8.5.108 MEX PDP address

The MEX PDP address can be IPV4 or NSAPI address.

8.5.108.1 IPV4 address

Used only when a primary PDP context is being requested.

The MEX PDP address information element shall be encoded as defined in table 8.220.

Table 8.220: Context of the MEX PDP address information element

Information element	Length	Value	Remark
PDP address byte 0	8	0 - 255	Byte 0 (left-most byte in dot quad notation) of IPv4 address
PDP address byte 1	8	0 - 255	Byte 1
PDP address byte 2	8	0 - 255	Byte 2
PDP address byte 3	8	0 - 255	Byte 3 (right-most byte in dot quad notation) of IPv4 address

8.5.108.2 NSAPI

Used only when a secondary PDP context is being requested.

See NSAPI information element.

8.5.109 MEX PDP type

The MEX PDP type information element shall be encoded as defined in table 8.221.

Table 8.221: Context of the MEX PDP type information element

Information element	Length	Value	Remark
MEX PDP type	3	0	IPv4 (static address)
		1	IPv4 (dynamic address negotiation)
		2	IPv6
		3	Mobile IPv4 - foreign agent care-of-address requested
		4	Mobile IPv4 - co-located care-of-address requested
		5	Primary NSAPI (secondary PDP context requested)

8.5.110 MEX Peer IP Filter

The MEX Peer IP Filter information element shall be encoded as defined in table 8.222.

Table 8.222: Context of the MEX Peer IP Filter information element

Information element	Length	Value	Remark
Peer IP address byte 0	8	0 - 255	Byte 0 (left-most byte in dot quad notation) of IPv4 address
Peer IP address byte 1	8	0 - 255	Byte 1
Peer IP address byte 2	8	0 - 255	Byte 2
Peer IP address byte 3	8	0 - 255	Byte 3 (right-most byte in dot quad notation) of IPv4 address

8.5.111 MEX precedence

The MEX precedence information element shall be encoded as defined in table 8.223.

Table 8.223: Context of the MEX precedence information element

Information element	Length	Value	Remark
MEX Precedence	4	0	Reserved
		1	Precedence level = 1 (lowest)
		2	Precedence level = 2
		3	Precedence level = 3
		4	Precedence level = 4
		5	Precedence level = 5
		6	Precedence level = 6
		7	Precedence level = 7
		8	Precedence level = 8
		9	Precedence level = 9
		10	Precedence level = 10
		11	Precedence level = 11
		12	Precedence level = 12
		13	Precedence level = 13
		14	Precedence level = 14 (highest)
15	Reserved		

8.5.112 MEX precedence rank

The MEX precedence rank information element shall be encoded as defined in table 8.224.

Table 8.224: Context of the MEX precedence rank information element

Information element	Length	Value	Remark
MEX precedence rank	7	0 - 100	Represents the percentage available MEX precedence - see EN 300 392-2 [3], clause 30.2.3.3. Note that the value "0" represents a positive rank value less than 0,5 %, not 0,0 %

8.5.113 MEX precedence supported

The MEX precedence supported information element shall be encoded as defined in table 8.225.

Table 8.225: Context of the MEX precedence supported information element

Information element	Length	Value	Remark
MEX precedence supported	1	0	MEX precedence is not supported
		1	MEX precedence is supported

8.5.114 MEX QoS

The MEX QoS information element shall be encoded as defined in table 8.226.

Table 8.226: Context of the MEX QoS information element

Information element	Length	Value	Remark
MEX precedence	8		See MEX precedence IE
Data priority	8		See Data priority IE
PDU priority	8		See PDU priority IE
Data importance	8		See Data importance IE
NSAPI QoS Negotiation	Variable		See NSAPI QoS Negotiation IE
Scheduled access	Variable		See Scheduled access IE

NOTE: The IE lengths are rounded up to the nearest octet multiple of the individual IE length.

8.5.115 MEX QoS class

The MEX QoS class information element shall be encoded as defined in table 8.227.

Table 8.227: Context of the MEX QoS class information element

Information element	Length	Value	Remark
MEX QoS class	8	0	Identifier of the default QoS settings for a legacy PDP context creation
		1 - 8	Identifiers of Specified QoS Class parameters
		9 - 32	Identifiers of manufacturer set read only QoS class parameters
		33 - 255	Identifiers of user-writable QoS class parameters

8.5.116 MEX QoS class access

The MEX QoS class access information element shall be encoded as defined in table 8.228.

Table 8.228: Context of the MEX QoS class access information element

Information element	Length	Value	Remark
MEX QoS class access	3	0	Read
		1	Write
		2	Write and Lock
		3	Unlock
		4	Locked

8.5.117 MEX QoS class lower (downlink)

Same values as MEX QoS class.

8.5.118 MEX QoS class upper (downlink)

Same values as MEX QoS class.

8.5.119 MEX QoS class lower (uplink)

Same values as MEX QoS class.

8.5.120 MEX QoS class upper (uplink)

Same values as MEX QoS class.

8.5.121 MEX QoS filter

The MEX QoS filter information element shall be encoded as defined in table 8.229.

Table 8.229: Context of the MEX QoS filter information element

Information element	Length	Value	Remark
MEX filter type	8		See MEX filter type IE
MEX filter - port range	32		See MEX filter - port range IE - only present if MEX filter type is port-related
MEX filter - diffserv	8		See MEX filter - diffserv IE - only present if MEX filter type is diffserv
MEX transaction type	8		See MEX transaction type IE
MEX peer IP filter	32		See MEX peer IP filter IE. Note that this is an optional IE, indicated using the normal encoding of optional elements

NOTE: The IE lengths are rounded up to the nearest octet multiple of the individual IE length.

8.5.122 MEX Transaction type

The MEX transaction type information element shall be encoded as defined in table 8.230.

Table 8.230: Context of the MEX transaction type information element

Information element	Length	Value	Remark
MEX transaction type	2	0	Uplink filter (not available when using "Bypass to SMDCP mode")
		1	Downlink filter
		2	Uplink automatic filter (not available when using "Bypass to SMDCP mode", or when MEX filter type is "Diffserv")
		3	Downlink automatic filter (not available when MEX filter type is "Diffserv")

8.5.123 Microphone on off

The microphone on off information element shall be as defined in table 8.231.

Table 8.231: Microphone on off information element contents

Information element	Length	Value	Remarks
Microphone on off	1	0	Microphone off
		1	Microphone on

8.5.124 Minimum peak throughput

This is the minimum peak throughput of N PDUs in units of octets s-1 requested or offered for a particular PDP context.

The Minimum peak throughput information element shall be encoded as defined in table 8.232.

Table 8.232: Context of the Minimum peak throughput information element

Information element	Length	Value	Remark
Minimum peak throughput	4	0	No value given
		1	< 1 000
		2	≥ 1 000
		3	≥ 2 000
		4	≥ 4 000
		5	≥ 8 000
		6	≥ 16 000
		7	≥ 32 000
		8	≥ 64 000
		9	Reserved
		etc.	etc.
		15	Reserved

8.5.125 MM profile

The MM profile information element shall define operation of the TNPI Relay for MM signalling messages as defined in table 8.233.

Table 8.233: MM profile information element contents

Information element	Length	Value	Remarks
Registration/De-registration control (note)	1	0	Registration/De-registration - MT controlled
		1	Registration/De-registration - TE controlled
Security control (authentication, enable/disable, encryption) (note)	1	0	Security - MT controlled
		1	Security - TE controlled
MM status control (energy saving, dual watch) (note)	1	0	MM status control - MT controlled
		1	MM status control - TE controlled
Group management control (group attach/detach) (note)	1	0	Group Management - MT controlled
		1	Group Management -TE controlled

NOTE: All the updates will be sent to both applications (MT and TE).

8.5.126 MM transfer result

The MM transfer result information element shall inform the TE2 user application about the success of the U-ITSI DETACH transfer as defined in table 8.234.

Table 8.234: MM transfer result information element contents

Information element	Length	Value ₂	Remarks
MM transfer result	1	0	Transfer successful done
		1	Transfer fail

8.5.127 MNC

The MNC information element shall indicate the mobile network code, as defined in table 8.235.

Table 8.235: MNC information element contents

Information element	Length	Value	Remarks
MNC	14	any	See EN 300 392-1 [1], clause 7

8.5.128 Mobile IPv4 information

The Mobile IPv4 information information element shall be encoded as defined in table 8.236.

Table 8.236: Context of the Mobile IPv4 information information element

Information element	Length	C/O/M	Value	Remark
FA Care of Address	32	M		
Sequence Number	16	M		
FA Registration Lifetime	16	M		
Register via FA (R)	8	M	0	Registration via FA not required
			1	Registration via FA required
FA Busy (B)	8	M	0	Accepting Registrations
			1	Accepting no Registrations
Home Agent (H)	8	M	0	Offers no HA Services
			1	Offers HA Services
Foreign Agent (F)	8	M	0	Offers no HA Services
			1	Offers HA Services
Minimal Encapsulation (M)	8	M	0	Not Supported
			1	Supported
GRE Encapsulation (G)	8	M	0	Not Supported
			1	Supported
Van Jacobsen Compression (V)	8	M	0	Not Supported
			1	Supported

NOTE: The size of the individual information fields are rounded up to the nearest octet.

8.5.129 Model

The model information element shall inform the TE2 user application about the MT2 model as defined in table 8.237.

Table 8.237: Model information element contents

Information element	Length	Value	Remarks
Model	n × 8	any	8 bits for each ASCII alphabet character

8.5.130 Modify

The modify information element shall be used to change an ongoing call either to a new basic service or the behaviour from simplex to duplex or reverse as defined in table 8.238.

Table 8.238: Modify information element contents

Information element	Length	Value	Remarks
Simplex/Duplex selection	1	any	See description of the Simplex/Duplex selection information element
Basic service information	8	any	See description of the basic service information element

8.5.131 More information flag

The more information flag information element shall be used to indicate to the application that there are more messages as defined in table 8.239. If this flag is set to "more information" the TE shall not send any more commands until all related data has been returned by the MT (flag set to "no more information").

Table 8.239: More information flag information element contents

Information element	Length	Value	Remarks
More information flag	1	0	No more information
		1	More information

8.5.132 MT2 default gateway address

The MT2 default gateway address information element shall be encoded as defined in table 8.240.

Table 8.240: MT2 gateway default address information element contents

Information element	Length	Value	Type	C/O/M	Remarks
Address type identifier	2	any	1	M	
SSI	24	any		C	See note
Address extension	24	any		C	See note
NOTE: Shall be conditional on the value of Address Type Identifier (ATI):					
- ATI = 1; SSI;					
- ATI = 2; SSI + Address Extension.					

8.5.133 Notification indicator

The notification indicator information element shall be used in SSs by the SwMI to inform a MS/LS of various events as presented in table 8.241 and defined in EN 300 392-9 [12], clause 7.2.

Table 8.241: Notification indicator information element contents

Information element	Length	Value	Remarks
Notification indicator	6	0 - 63	See EN 300 392-9 [12]

8.5.134 NSAPI

The NSAPI information element shall be encoded as defined in table 8.242.

Table 8.242: Context of the NSAPI information element

Information element	Length	Value	Remark
NSAPI	4	0	Reserved
		1 - 14	Dynamically allocated
		15	Reserved

8.5.135 NSAPI data priority

The NSAPI data priority information element shall be encoded as defined in table 8.243.

Table 8.243: Context of the NSAPI data priority information element

Information element	Length	Value	Remark
NSAPI Data priority	3	0	Priority 0 (lowest)
		1	Priority 1
		2	Priority 2
		3	Priority 3
		4	Priority 4
		5	Priority 5
		6	Priority 6
		7	Priority 7 (highest)

8.5.136 NSAPI QoS negotiation

The NSAPI QoS negotiation information element shall be encoded as defined in table 8.244.

Table 8.244: Context of the NSAPI QoS negotiation information element

Information element	Length	Value	Remark
Minimum Peak Throughput	8		See Minimum Peak Throughput IE
Mean Throughput	8		See Mean Throughput IE
Mean Active Throughput	8		See Mean Active Throughput IE
Data Class	8		See Data Class IE
Delay Class	8		See Delay Class IE
Reliability Class	8		See Reliability Class IE
CONTEXT READY timer	8		See CONTEXT READY timer IE
Scheduled Access	Variable		See Scheduled Access IE

NOTE: The IE lengths are rounded up to the nearest octet multiple of the individual IE length.

8.5.137 Number of groups

The number of groups information element shall indicate the number of uplink or downlink groups identity as defined in table 8.245.

Table 8.245: Number of groups information element contents

Information element	Length	Value	Remarks
Number of groups	4	0 to 15	

8.5.138 Number of messages

The number of messages information element shall be used for repeatable sub elements, as defined in table 8.246.

Table 8.246: Number of messages information element contents

Information element	Length	Value	Remarks
Number of messages	8	0 to 254	
		255	All messages

8.5.139 Over temperature indication

The MTE over temperature indication information element shall be as defined in table 8.247.

Table 8.247: Over temperature indication information element contents

Information element	Length	Value	Remarks
Over temperature indication	1	0	Normal temperature
		1	Over temperature

8.5.140 Packet data mode services

The data mode services information element shall list the packet data mode capabilities of the MT2. It shall not give any information of the capabilities of the underlying network as defined in table 8.248.

Table 8.248: Packet data mode services information element contents

Information element	Length	Value	Remarks
Ipv4	1	0	Not capable
		1	Capable
Ipv6	1	0	Not capable
		1	Capable
Reserved	1	0	Not capable
		1	Capable
Reserved	1	0	Not capable
		1	Capable

8.5.141 PCOMP

The PCOP information element shall be encoded as defined in table 8.249.

Table 8.249: Context of the PCOMP information element

Information element	Length	Value	Remark
PCOMP	4	0	No compression
		1	Van Jacobson compressed TCP/IP
		2	Van Jacobson non-compressed TCP/IP
		3	FULL_HEADER
		4	COMPRESSED_TCP
		5	COMPRESSED_TCP_NODELTA
		6	COMPRESSED_NON_TCP
		7	COMPRESSED_RTP_8
		8	COMPRESSED_RTP_16
		9	COMPRESSED_UDP_8
		10	COMPRESSED_UDP_16
		11	CONTEXT_STATE
others	For further standardization (a list of fixed or negotiated algorithms e.g. IPv6)		

8.5.142 PCON result

The PCON result information element shall be encoded as defined in table 8.250.

Table 8.250: Context of the PCON result information element

Information element	Length	Value	Remark
PCON result	1	0	PCON failed to be created
		1	PCON successfully created

8.5.143 PDU Group ID and PDU type

The PDU Group ID and PDU type information element shall identify the purpose of the TNP1 PDU sent over the PEI as defined in tables 8.251 and 8.253.

Table 8.251: PDU Group ID and PDU type information elements contents

Information element	Length	Value	Type	C/O/M	Remarks
PDU Group ID	8	any	1	M	Refer to clause 8.5.92
PDU ID	8	any	1	M	Refer to clause 8.5.92

8.5.144 PDU priority

The PDU priority information element shall be encoded as defined in table 8.252.

Table 8.252: Context of the PDU priority information element

Information element	Length	Value	Remark
PDU priority	3	0	Priority 0 (lowest)
		1	Priority 1
		2	Priority 2
		3	Priority 3
		4	Priority 4
		5	Priority 5
		6	Priority 6
		7	Priority 7 (highest)

8.5.145 PDU priority max

The PDU priority max information element shall have the same values as PDU priority.

8.5.146 PDU type values

The PDU type values information element shall be encoded as defined in table 8.253. All the unused group ID and PDU ID values are reserved.

Table 8.253: PDU type values information element contents

Group ID	Group ID value ₂	PDU Name	PDU ID value ₂
CC	00001001	TECC-ALERT IND	00000001
		TECC-COMplete CON	00000010
		TECC-COMplete IND	00000011
		TECC-COMplete REQ	00000100
		TECC-DTMF IND	00000101
		TECC-DTMF REQ	00000110
		TECC-MODIFY IND	00000111
		TECC-MODIFY REQ	00001000
		TECC-NOTIFY IND	00001001
		TECC-PROCEED IND	00001010
		TECC-RELEASE CON	00001011
		TECC-RELEASE IND	00001100
		TECC-RELEASE REQ	00001101
		TECC-SETUP CON	00001110
		TECC-SETUP IND	00001111
		TECC-SETUP REQ	00010000
		TECC-SETUP RES	00010001
		TECC-TX CON	00010010
TECC-TX IND	00010011		
TECC-TX REQ	00010100		
SS	00001011	TESS-FACILITY CON	00000000
		TESS-FACILITY IND	00000001
		TESS-FACILITY REQ	00000010
		TESS-FACILITY RES	00000011
SDS	00001111	TESDS-REPORT IND	00000000
		TESDS-STATUS IND	00000001
		TESDS-STATUS REQ	00000010
		TESDS-UNITDATA IND	00000011
SDS-TL	00001111	TESDS-UNITDATA REQ	00000100
		TESDS-TL-ACK IND	00001011
		TESDS-TL-ACK REQ	00001100
		TESDS-TL-REPORT IND	00001101
		TESDS-TL-REPORT REQ	00001110
		TESDS-TL-TNSDS-REPORT IND	00001111
		TESDS-TL-TRANSFER IND	00010000
		TESDS-TL-TRANSFER REQ	00010001
TESDS-TL-UNITDATA IND	00010010		
TESDS-TL-UNITDATA REQ	00010011		

Group ID	Group ID value ₂	PDU Name	PDU ID value ₂
MM	00010001	TEMM-ATTACH DETACH GROUP IDENTITY CON	00000000
		TEMM-ATTACH DETACH GROUP IDENTITY IND	00000001
		TEMM-ATTACH DETACH GROUP IDENTITY REQ	00000010
		TEMM-ENERGY SAVING CON	00000100
		TEMM-ENERGY SAVING REQ	00000101
		TEMM-ENERGY SAVING IND	00000110
		TEMM-REPORT IND	00000111
		TEMM-REGISTRATION CON	00001000
		TEMM-REGISTRATION IND	00001001
		TEMM-REGISTRATION REQ	00001010
		TEMM-DEREGISTRATION REQ	00001011
		TEMM-SERVICE IND	00001100
		TEMM-DISABLING IND	00001101
		TEMM-ENABLING IND	00001110
		TEMM-STATUS CON	00001111
		TEMM-STATUS IND	00010000
		TEMM-STATUS REQ	00010001
		TEMM-SERVICE REQ	00010010
Circuit mode traffic related	00010011	TEMAC-FLOW CONTROL	00000000
		TEMAC-UNITDATA	00000001
MT2 user application PDUs	00010100	TEMTA-IDENTIFICATION RESP	00000001
		TEMTA-IDENTIFICATION REQ	00000010
		TEMTA-SERVICES CAPABILITY RESP	00000011
		TEMTA-SERVICES CAPABILITY REQ	00000100
		TEMTA-SDS-TL CAPABILITY RESP	00000101
		TEMTA-SDS-TL CAPABILITY REQ	00000110
		TEMTA-SDS DELETE MESSAGES REQ	00000111
		TEMTA-SDS MESSAGE ERROR	00001000
		TEMTA-SDS MESSAGE IND	00001001
		TEMTA-SDS GET LIST MESSAGES BY KEY REQ	00001010
		TEMTA-SDS LIST MESSAGES REPLY	00001011
		TEMTA-SDS NOTIFICATION	00001100
		TEMTA-SDS SERVICE PROFILE RESP	00001110
		TEMTA-SDS SERVICE PROFILE SET	00001111
		TEMTA-SDS SERVICE PROFILE REQ	00010000
		TEMTA-CC SERVICE PROFILE RESP	00010001
		TEMTA-CC SERVICE PROFILE SET	00010010
		TEMTA-CC SERVICE PROFILE REQ	00010011
		TEMTA-MM SERVICE PROFILE RESP	00010100
		TEMTA-MM SERVICE PROFILE SET	00010101
		TEMTA-MM SERVICE PROFILE REQ	00010110
		TEMTA-SDS-TL SERVICE PROFILE RESP	00010111
		TEMTA-SDS-TL SERVICE PROFILE SET	00011000
		TEMTA-SDS-TL SERVICE PROFILE REQ	00011001
		TEMTA-STATE RESP	00011101
		TEMTA-STATE REQ	00011110
		TEMTA-SYSINFO RESP	00011111
		TEMTA-SYSINFO REQ	00100000
		TEMTA-IDENTITIES RESP	00100001
		TEMTA-IDENTITIES REQ	00100010
		TEMTA-REPORT IND	00100011
		TEMTA-SPEAKER-MIC REQ	00100101
TEMTA-SETVOLUME REQ	00100110		

Group ID	Group ID value ₂	PDU Name	PDU ID value ₂
		TEMTA-SDS MESSAGE REQ	00100111
		TEMTA-NEW-PCON REQ	00101000
		TEMTA-NEW-PCON CON	00101001
MEX	00010101	TEMX-CAPABILITY REQ	00000000
		TEMX-CAPABILITY CON	00000001
		TEMX-HANDLE REQ	00000010
		TEMX-HANDLE CON	00000011
		TEMX-CONNECT REQ	00000100
		TEMX-CONNECT CON	00000101
		TEMX-END REQ	00000110
		TEMX-END CON	00000111
		TEMX-END IND	00001000
		TEMX-MODIFY REQ	00001001
		TEMX-MODIFY CON	00001010
		TEMX-MODIFY IND	00001011
		TEMX-QOSCLASS REQ	00001100
		TEMX-QOSCLASS CON	00001101
		TEMX-BYPASS DATA REQ	00001110
		TEMX-BYPASS DATA IND	00001111

8.5.147 Poll request

This poll request information element shall be used by the SwMI to request a poll response back from the MS/LS when an acknowledged group call has been initiated as defined in table 8.254.

Table 8.254: Poll request information element contents

Information element	Length	Value	Remarks
Poll request	1	0	No poll answer requested
		1	Poll answer requested

8.5.148 Poll response

This poll response information element shall be used by the MS/LS to respond to a poll request in an acknowledged group call from the SwMI as defined in table 8.255.

Table 8.255: Poll response information element contents

Information element	Length	Value	Remarks
Poll response	1	0	No Poll response
		1	Poll response

8.5.149 Poll response addresses

The poll response addresses information element shall provide the addresses on responding group members in an acknowledged group call as defined in table 8.256.

Table 8.256: Poll response addresses information element contents

Information element	Length	Value	Remarks
1 st TSI address	48	any	For TSI address definition see EN 300 392-1 [1]
2 nd TSI address	48	any	clause 7
etc.	etc.	any	
Nth TSI address	48	any	

8.5.150 Poll response number

The poll response number information element shall provide the number of responding group members in an acknowledged group call as defined in table 8.257.

Table 8.257: Poll response number information element contents

Information element	Length	Value	Remarks
Number of responding group members	6	0 to 63	

8.5.151 Poll response percentage

The poll response percentage information element shall provide the percentage of responding group members in an acknowledged group call as defined in table 8.258.

Table 8.258: Poll response percentage information element contents

Information element	Length	Value	Remarks
Percentage of responding number of group members	6	0	0 %
		1	2 %
		etc.	etc.
		50	100 %
		51	Reserved
		etc.	etc.
		63	Reserved

8.5.152 Preferred LA list

The preferred LA list information element shall define the list of the preferred location areas used for cell selection as defined in table 8.259.

Table 8.259: Preferred LA list information element contents

Information element	Length	Value	Type	C/O/M	Remarks
Number (of LA)	8	any	1	M	
LA	14	any		C	See note
NOTE: This element shall be repeatable according to the number field.					

8.5.153 Preferred MCC list

The preferred MCC list information element shall define the list of the preferred MCC used for cell selection as defined in table 8.260.

Table 8.260: Preferred MCC list information element contents

Information element	Length	Value	Type	C/O/M	Remarks
Number of MCCs	8	any	1	M	
MCC	10	any		C	See note
NOTE: This element shall be repeatable according to the number of MCCs information element.					

8.5.154 Preferred MNC list

The preferred MNC list information element shall define the list of the preferred MNC used for cell selection as defined in table 8.261.

Table 8.261: Preferred MNC list information element contents

Information element	Length	Value	Type	C/O/M	Remarks
Number of MNCs	8	any	1	M	
MNC	14	any		C	See note
NOTE: This element shall be repeatable according to the number of MNCs information element.					

8.5.155 Product serial number

The product serial number information element shall inform the TE2 user application about the MT2 production number as defined in table 8.262.

Table 8.262: Product serial number information element contents

Information element	Length	Value	Remarks
Product serial number	n × 8		8 bits for each ASCII alphabet character

8.5.156 Proprietary

Proprietary is an optional, variable length information element and may be used to send and receive proprietary defined information appended to the PDUs. The proprietary information element is not used on the air interface.

The first information element following any type 3 element identifier "proprietary" shall be a numeric Manufacturer identifier information element. The subsequent information element(s) are manufacturer-specific.

The proprietary information element shall be encoded as defined in table 8.263.

Table 8.263: Proprietary information element contents

Information element	Length	Value	Remarks
Proprietary element owner	8		See clause 8.5.103 for definition
Proprietary	Varies		See note
NOTE: The use, the size and the rest of the structure of the proprietary information element are outside the scope of the present document.			

8.5.157 Proprietary element owner

The proprietary information element owner element shall inform the TE2 user application about the manufacturer of the MT2 as defined in table 8.264.

Table 8.264: Proprietary element owner information element contents

Information element	Length	Value	Remarks
Proprietary element owner	8	0	Reserved
		1 to 255	To be allocated to manufacturers by ETSI
NOTE: This information element and the method of allocation are described in further detail in annex H of EN 300 392-2 [3].			

8.5.158 Protocol identifier

The protocol identifier information element shall refer to the user application utilizing the SDS-TL protocol as defined in EN 300 392-2 [3] in table 29.21 and copied here as table 8.265. If any discrepancies the EN 300 392-2 [3], table 29.21 shall take precedence. The clause numbers in table 8.265 are clauses of EN 300 392-2 [3].

Table 8.265: Protocol identifier information element contents (informative)

Information element	Length	Value	Remarks	Clause
Protocol identifier	8	00000000 ₂	Reserved, notes 1 and 2	-
		00000001 ₂	OTAK (Over The Air re-Keying for end to end encryption), refer to EN 300 392-7 [20], clause 7.6, see notes 2 and 3	29.5.1
		00000010 ₂	Simple Text Messaging, see note 2	29.5.2
		00000011 ₂	Simple GPS, see note 2	29.5.5
		00000100 ₂	Wireless Datagram Protocol WAP, see note 2	29.5.8
		00000101 ₂	Wireless Control Message Protocol WCMP, see note 2	29.5.8
		00000110 ₂	M-DMO (Managed DMO), refer to EN 300 396-10 [i.4], see note 2	29.5.1
		00000111 ₂	PIN authentication, see note 2	29.5.1
		00001000 ₂	End-to-end encrypted message, see notes 2 and 6	-
		00001001 ₂	Simple immediate text messaging, see note 2	29.5.2
		00001010 ₂ to 00111111 ₂	Reserved for future standard definition, see note 2	29.5.1
		01000000 ₂ to 01111111 ₂	Available for user application definition, see notes 2 and 4	29.5.1
		10000000 ₂ to 10000001 ₂	Reserved, see note 5	-
		10000010 ₂	Text Messaging, see note 5	29.5.3
		10000011 ₂	GPS, see note 5	29.5.6
		10000100 ₂	Wireless Datagram Protocol WAP, see note 5	29.5.8
		10000101 ₂	Wireless Control Message Protocol WCMP, see note 5	29.5.8
		10000110 ₂	M-DMO (Managed DMO), refer to EN 300 396-10 [i.4], see note 5	29.5.1
		10000111 ₂	Reserved for future standard definition, note 5	-
		10001000 ₂	End-to-end encrypted message, see notes 5 and 6	-
10001001 ₂	Immediate text messaging, see note 5	29.5.3		
10001010 ₂ to 10111111 ₂	Reserved for future standard definition, see note 5	-		
11000000 ₂ to 11111111 ₂	Available for user application definition, see notes 4 and 5	-		
NOTE 1: This protocol identifier value should not be used as it is not allocated for a pre-defined application.				
NOTE 2: The SDS-TL data transfer service shall not be used for these protocol identifiers, refer to EN 300 392-2 [3], clause 29.4.1.				
NOTE 3: In the EN 300 392-7 [20], clause 7.6 the protocol identifier is identified as "SDS type 4 header".				
NOTE 4: The assignment of these protocol identifiers will be co-ordinated in order to prevent clashes, refer to annex J.				
NOTE 5: The SDS-TL data transfer service shall be used for these protocol identifiers.				
NOTE 6: Refer to TETRA MoU SFPG recommendation 07 for information.				

8.5.159 Protocol identifier kind

This protocol identifier kind information element shall be used by the MS to request an SDTSL profile kind as defined in table 8.266.

Table 8.266: PI kind information element contents

Information element	Length	Value	Remarks
Protocol identifier kind	1	0	For all protocol identifiers
		1	For protocol identifiers according to protocol identifier

8.5.160 Reject cause

The reject cause information element shall indicate what type of rejection has been detected as defined in table 8.267.

Table 8.267: Reject cause information element contents

Information element	Length	Value ₂	Remarks
Reject Cause	5	00000	Reserved
		00001	ITSI unknown
		00010	Illegal MS
		00011	Location Area not allowed
		00100	Location Area unknown
		00101	Network failure
		00110	Congestion
		00111	Service not supported
		01000	Service not subscribed
		01001	Mandatory element error
		01010	Message consistency error
		01011	Roaming not supported
		01100	Migration not supported
		01101	No cipher KSG
		01110	Identified cipher KSG not supported
		01111	Requested cipher key type not available
		10000	Identified cipher key not available
		10001	Incompatible service
10010	Reserved		
etc.	etc.		
11111	Reserved		

8.5.161 Registration status

The registration status information element shall indicate the success/failure of the most recent registration attempt as defined in table 8.268.

Table 8.268: Registration status information element contents

Information element	Length	Value	Remarks
Registration status	1	0	Success
		1	Failure

8.5.162 Registration type

The registration type information element shall indicate the registration type of the registration request as defined in table 8.269.

Table 8.269: Registration type information element contents

Information element	Length	Value	Remarks
Registration type	2	0	No new ITSI - periodic registration
		1	No new ITSI - forward registration
		2	New ITSI

8.5.163 Reliability class

The Reliability class information element shall be encoded as defined in table 8.270.

Table 8.270: Context of the Reliability class information element

Information element	Length	Value	Remark
Reliability class	2	0	High (uses an acknowledged link with FCS enabled)
		1	Moderate (uses an acknowledged link with FCS disabled)
		2	Low (uses the unacknowledged basic link, normally with FCS disabled and no retransmissions)

8.5.164 Report reason

The transaction reason information element shall indicate what is the reason for the abnormal event report as defined in table 8.271.

Table 8.271: Report reason information element contents

Information element	Length	Value ₂	Remarks
Report reason	7	000000	Success
		000001	Unrecognized PDU
		000010	Facility or addressing not supported
		000011	Protocol state mismatch detected
		000100	Illegal PDU structure
		000101	Illegal value of an information element
		000110	PEI DLL failure
		000111	Reserved
		etc.	etc.
		011111	Reserved
		100000	Proprietary
		etc.	etc.
		111111	Proprietary

8.5.165 Request to transmit/send data

The request to transmit/send data information element shall inform the infrastructure about immediate request to transmit or data transmission at through-connection as defined in table 8.272.

Table 8.272: Request to transmit/send data information element contents

Information element	Length	Value	Remarks
Request to transmit/send data	1	0	Request to transmit/send data
		1	Request that other MS/LS may transmit/send data

8.5.166 Reset call time-out timer (T310)

The reset call time-out timer information element shall reset and start the overall call length timer T310 in the MS/LS. The timer shall be started with the current value as defined in table 8.273.

Table 8.273: Reset Call time-out timer information element contents

Information element	Length	Value	Remarks
Reset call time-out value	1	0	No reset of call time-out timer T310
		1	Reset call time-out timer T310

8.5.167 Schedule available

The Schedule available information element shall be encoded as defined in table 8.274.

Table 8.274: Schedule available information element

Information element	Length	Value	Remark
Schedule available	2	0	Reserved
		1	Schedule available
		2	Cancelled
		3	Suspended

8.5.168 Scheduled access

The Scheduled access information element shall be encoded as defined in table 8.275.

Table 8.275: Context of the Scheduled access information element

Information element	Length	Value	Remark
Schedule repetition period	16		See Schedule repetition period IE
Schedule timing error	8		See Schedule timing error IE
Scheduled number of N-PDUs per grant	8		See Scheduled number of N-PDUs per grant IE
Scheduled N-PDU size	16 x n		See Scheduled N-PDU size IE. "n" is the value of the IE "Scheduled number of N-PDUs per grant"

NOTE: The IE lengths are rounded up to the nearest octet multiple of the individual IE length.

8.5.169 Scheduled N-PDU size

The Scheduled N-PDU size information element shall be encoded as defined in table 8.276.

Table 8.276: Context of the Scheduled N-PDU size information element

Information element	Length	Value	Remark
Scheduled N-PDU size	11	1 - 2 002	Number of octets

8.5.170 Scheduled number of N-PDUs per grant

The Scheduled number of N-PDUs per grant information element shall be encoded as defined in table 8.277.

Table 8.277: Context of the Scheduled number of N-PDUs per grant information element

Information element	Length	Value	Remark
Scheduled number of N-PDUs per grant	3	1	
		2	
		3	
		4	
		5	
		6	
		7	

8.5.171 Schedule repetition period

The Schedule repetition period information element shall be encoded as defined in table 8.278.

Table 8.278: Context of the Schedule repetition period information element

Information element	Length	Value	Remark
Schedule repetition period	10	4 - 706	Slot durations (706 slots = 10 s)

8.5.172 Schedule surplus flag

The Schedule surplus flag information element shall be encoded as defined in table 8.279.

Table 8.279: Context of the Schedule surplus flag information element

Information element	Length	Value	Remark
Schedule surplus flag	1	0	Number of octets
		1	Surplus to schedule

8.5.173 Schedule timing error

The Schedule timing error information element shall be encoded as defined in table 8.279a.

Table 8.279a: Context of the Schedule timing error information element

Information element	Length	Value	Remark
Schedule timing error	3	0	≤ 1 slot duration
		1	≤ 2 slot durations
		2	≤ 4 slot durations
		3	≤ 8 slot durations
		4	≤ 16 slot durations
		5	≤ 32 slot durations
		6	≤ 64 slot durations
		7	≤ 128 slot durations

NOTE 1: A slot has a duration of 85/6 ms.

NOTE 2: The SwMI sets the earliest timing of successive scheduled slot grants relative to the time of the first slot grant. The schedule timing error is the maximum acceptable delay of a scheduled slot grant beyond the earliest time of a scheduled slot grant. The SINDCP application should not propose a schedule timing error which is greater than the schedule repetition period.

8.5.174 Share response flag

The Share response flag information element shall be encoded as defined in table 8.280.

Table 8.280: Context of the Share response flag information element

Information element	Length	Value	Remark
Share response flag	1	0	Do not replicate responses to originating PCON
		1	Replicate responses to originating PCON

8.5.175 SDS control

The SDS control information element shall be encoded as defined in table 8.281.

Table 8.281: SDS control information element contents

Information Element	Length	Value	Remarks
SDS control (SDS 1/2/3/4)	2	0	SDS - MT controlled
		1	SDS - TE controlled
		2	Reserved
		3	SDS - Neither

8.5.176 SDS error

The SDS error information element shall indicate reason for unsuccessful result as defined in table 8.282.

Table 8.282: SDS error information element contents

Information element	Length	Value	Remarks
SDS error	3	0	Request failed for undefined reason
		1	Request not supported
		2	SDS message not available
		3	Reserved
		etc.	etc.
		7	Reserved

8.5.177 SDS full storage action

The SDS full storage action information element shall be encoded as defined in table 8.283.

Table 8.283: SDS full storage action information element contents

Information element	Length	Value	Remarks
SDS full storage action	2	0	Re-write the first old record
		1	Re-write the last record
		2	Reject message
		3	Reserved

8.5.178 SDS message stack storage

The SDS message stack storage information element shall be encoded as defined in table 8.284.

Table 8.284: SDS message stack storage information element contents

Information element	Length	Value	Remarks
SDS message stack storage	2	0	Downlink message storage in message stack
		1	Uplink message storage in message stack
		2	Uplink and Downlink message storage in message stack
		3	Reserved

8.5.179 SDS message status

The SDS message status information element shall indicate status of the SDS message in the MT2 SDS message stack as defined in table 8.285.

Table 8.285: SDS message status information element contents

Information element	Length	Value ₂	Remarks
SDS message status	3	000	Record not used
		001	Message received by application; message read
		010	RFU
		011	Message received by application; message to be read
		100	RFU
		101	Application originates a message; message sent to network
		111	Application originates a message; message to be sent to network

8.5.180 SDS mode services

The SDS mode services information element shall list the SDS mode capabilities of the MT2, as defined in table 8.286.

Table 8.286: SDS mode services information element contents

Information Element	Length	Value ₂	Remarks
Status	1	0	Not capable
		1	Capable
SDS type 1	1	0	Not capable
		1	Capable
SDS type 2	1	0	Not capable
		1	Capable
SDS type 3	1	0	Not capable
		1	Capable
SDS type 4	2	00	Not capable
		01	Capable with SDS4 direct only
		10	Capable with TL and direct also
		11	Reserved
SDS message stack in MT2	1	0	Not capable
		1	Capable
Reserved	1	0	Reserved
MT2 Default Gateway address	24		Conditional on one of the SDS capability

8.5.181 SDS notification

The SDS notification element shall indicate the status of the stack when receiving new SDS message as defined in table 8.287.

Table 8.287: SDS notification element contents

Information element	Length	Value	Remarks
SDS notification	1	0	Message stack available
		1	Message stack full

8.5.182 SDS profile type

The SDS profile type information element shall indicate the type of the SDS 1/2/3/status service profile requested/indicated, as defined in table 8.288.

Table 8.288: SDS profile type information element contents

Information Element	Length	Value	Remarks
SDS profile type	8	0	Service profile for SDS 1
		1	Service profile for SDS 2
		2	Service profile for SDS 3
		3	Service profile for SDS status

8.5.183 SDS reference type

The SDS reference type information element shall be defined in table 8.289.

Table 8.289: SDS reference type information element contents

Information element	Length	Value	Remarks
SDS reference type	2	0	Message reference handle + message reference
		1	Message reference
		2	User application reference
		3	Reserved

8.5.184 SDS stack message handling

The SDS stack message handling information element shall be encoded as defined in table 8.290.

Table 8.290: SDS stack message handling information element contents

Information element	Length	Value	Type	C/O/M	Remarks
Stack usage	1	any	1	M	See note 1
SDS message stack storage	2	any		C	See notes 1 and 2
SDS full storage action	2	any		C	See notes 1 and 2
SDS validity period	5	any		C	See notes 1 and 2
NOTE 1: Relevant only when MT has a stack capability (see SDS mode services).					
NOTE 2: Shall be conditional on the value of the "Stack usage" (SU):					
- SU = 1: SDS message stack storage + SDS Full Storage action + SDS validity period;					
- SU = 0: Shall not be present.					

8.5.185 SDS status profile

The SDS status profile information element shall be encoded as defined in table 8.291.

Table 8.291: SDS status profile information element contents

Information element	Length	Type	C/O/M	Value	Remarks
SDS stack message handling					According to the definition
User status control, note	1	1	M	0	User status - MT controlled
				1	User status - TE controlled
Default status control, note	1	1	M	0	Other status - MT controlled
				1	Other status - TE controlled
NOTE: User Status is defined as Status with values: 8000-EFFF. For other status values, no additional profile is required:					
- Status Ack (defined as FE00-FE0F) - both applications will receive;					
- SDS-TL short reporting (defined as 7B00-7FFF) - according to SDS-TL profile;					
- Emergency alarm- both applications can send the message;					
- Call back request (defined as FEF0 or FEF4) - according to the Call control profile;					
- Other - as defined in default status control.					

8.5.186 SDS type

The SDS type information element shall indicate type of the SDS message in the MT2 SDS message stack as defined in table 8.292.

Table 8.292: SDS type information element contents

Information element	Length	Value	Remarks
SDS type	3	0	SDS type 1
		1	SDS type 2
		2	SDS type 3
		3	SDS status
		4	SDS type 4
		5	Reserved
		6	Reserved
		7	Reserved

8.5.187 SDS user data 1 profile

The SDS user data 1 profile information element shall define operation of the TNP1 Relay for SDS type 1 messages as defined in table 8.293.

Table 8.293: SDS user data 1 profile information element contents

Information element	Length	Value	Remarks
SDS control	2	any	
SDS stack message handling			

8.5.188 SDS user data 2 profile

The SDS user data 2 profile information element shall define operation of the TNP1 Relay for SDS type 2 messages. The format shall be as in SDS user data profile 1.

8.5.189 SDS user data 3 Profile

The SDS user data 3 profile information element shall define operation of the TNP1 Relay for SDS type 3 messages. The format shall be as in SDS user data profile 1.

8.5.190 SDS user data 4 Profile

The SDS user data 4 profile information element shall define operation of the TNP1 Relay for SDS type 4 messages of a certain SDS type 4 protocol. The SDS user data 4 profile information element shall define operation of the TNP1 Relay for SDS type 4 messages. The format shall be as in SDS user data profile 1.

8.5.191 SDS-TL service capability

The SDS service capability information element shall list the SDS-TL capability of the MT2 as defined in table 8.294.

Table 8.294: SDS-TL service capability information element contents

Information element	Length	Value	Remarks
SDS-TL service capability	1	0	Not capable
		1	Capable

8.5.192 SDS-TL service centre address type

The SDS service centre address type information element shall list the SDS-TL capability of the MT2 as defined in table 8.295.

Table 8.295: SDS-TL service centre address type information element contents

Information element	Length	Value	Remarks
SDS-TL service centre address type	3	0	Short Number Address (SNA)
		1	Short Subscriber Identity (SSI)
		2	Tetra Subscriber Identity (TSI = MNI+SSI)
		3	SSI+external subscriber address

8.5.193 SDS-TL service centre capability

The SDS-TL service centre capability information element shall list the service centre capability of the MT2 as defined in table 8.296.

Table 8.296: SDS-TL service centre capability information element contents

Information element	Length	Value	Remarks
SDS-TL service centre capability	1	0	Not capable
		1	Capable

8.5.194 SDS-TL service centre default address

The SDS-TL service default address information element shall indicate the service centre default address as defined in table 8.297.

Table 8.297: SDS-TL service centre default address information element contents

Information element	Length	Value	Type	C/O/M	Remarks
SDS-TL service centre address type	3	any	1	M	
Short number address (SNA)	8	any		C	See note
SSI	24			C	See note
Extension	24			C	See note
External subscriber number	variable	variable		C	See note
NOTE: Shall be conditional on the service centre address type.					

8.5.195 SDS transfer result

The SDS transfer result information element shall inform the TE2 user application about the success of the SDS transmittal as defined in table 8.298.

Table 8.298: SDS transfer result information element contents

Information element	Length ₂	Value ₂	Remarks
SDS transfer result	8	00000000	Failed for undefined reason
		00000001	Success
		00000010	Requested service not supported
		00000011	Reserved
		etc.	etc.
		11111111	Reserved

8.5.196 Security

The security information element shall indicate the security capabilities of MT2 as defined in table 8.299.

Table 8.299: Security information element contents

Information element	Length	Value	Type	C/O/M	Remarks
Security class of MS	2	any	1	M	
End to end encryption flag	1	any	1	M	

8.5.197 Security class of MS

The security class information element shall indicate the security class of MS as defined in table 8.300.

Table 8.300: Security class of MS information element contents

Information element	Length	Value	Remarks
Security class of MS	2	0	Security class 1
		1	Security class 2
		2	Security class 3
		3	Reserved

8.5.198 Security information

The information element security information shall indicate the security information included in the extended services broadcast information, as defined in table 8.301.

Table 8.301: Security information element contents

Information sub-element	Length	Type	C/O/M	Value	Remarks
Authentication	1	1	M	0	Authentication not required in this cell
				1	Authentication required in this cell
Security class 1	1	1	M	0	Security class 1 MS not supported on this cell
				1	Security class 1 MS supported on this cell
Security class 2 or 3	1	1	M	0	Security class 2 MS supported on this cell
				1	Security class 3 MS supported on this cell
SCKN (note 1)	5		C	any	
DCK retrieval during initial cell selection (note 2)	1		C	0	Service not supported
				1	Service supported
DCK retrieval during cell re-selection (note 2)	1		C	0	Service not supported
				1	Service supported
GCK supported (note 2)	1		C	0	Service not supported
				1	Service supported
NOTE 1: Shall be conditional on the value of "security class 2 or 3" (sc23):					
- SC23 = 0; SCKN;					
- SC23 = 1.					
NOTE 2: Shall be conditional on the value of "security class 2 or 3" (sc23):					
- SC23 = 1; DCK retrieval during initial cell selection + DCK retrieval during cell re-selection + GCK supported;					
- SC23 = 0.					

8.5.199 Service profile operation

The service profile operation information element shall specify the operation performed on the TNPI Relay service profile as defined in table 8.302.

Table 8.302: Service profile operation information element contents

Information element	Length	Value	Remarks
Service profile operation	2	0	Get service profile
		1	Set service profile
		2	Reserved
		3	Reserved

8.5.200 Service profile request result

The service profile request result information element shall specify if the set request was successful or not as defined in table 8.303.

Table 8.303: Service Profile request result information element contents

Information element	Length	Value	Remarks
Service profile request result	2	0	Unsuccessful
		1	Success
		2	Not applicable
		3	Unsupported feature

8.5.201 Service selection

The service selection information element shall indicate which of the service selection is indicated as defined in table 8.304.

Table 8.304: Service selection information element contents

Information element	Length	Value	Remarks
Service selection	1	0	Individual service
		1	Group or individual service

8.5.202 Service status

The service status information element shall indicate which of the service status is indicated as defined in table 8.305.

Table 8.305: Service status information element contents

Information element	Length	Value	Remarks
Service status	2	0	In service
		1	In service waiting for registration
		2	Out of service
		3	Reserved

8.5.203 Set profile request

The set profile request information element shall indicate which one of the set operation for the profile set request PDU is requested as defined in table 8.306.

Table 8.306: Set profile request information element contents

Information element	Length	Value	Remarks
Set operation profile request	8	0	Set current service profile
		1	Set current service profile and store as user defined Service profile
		2	Restore user defined service profile (to the current service profile)
		3	Restore default service profile (to the current service profile)
		4	Reserved
		etc.	etc.
		255	Reserved

8.5.204 Short data type identifier

The short data type identifier information element shall identify the length of the user-defined data sent to or received from the SwMI as defined in table 8.307.

Table 8.307: Short DATA TYPE IDENTIFIER information element contents

Information element	Length	Value	Remarks
Short data type identifier	2	0	User defined data 1 element is 16 bits long
		1	User defined data 2 element is 32 bits long
		2	User defined data 3 element is 64 bits long
		3	Reserved

8.5.205 Short form report

The short form report information element shall indicate request for short report as defined in table 8.308.

Table 8.308: Short form report information element contents

Information element	Length	Value	Remarks
Short form report	1	0	Short form report recommended during the validity period of the message
		1	Only standard report allowed

8.5.206 Simplex/duplex selection

The simplex/duplex selection information element shall inform the infrastructure the preferred mode of operation as defined in table 8.309.

Table 8.309: Simplex/duplex selection information element contents

Information element	Length	Value	Remarks
Simplex/duplex selection	1	0	Simplex requested
		1	Duplex requested

8.5.207 Software version

The software version information element shall inform the TE2 user application about the MT2 software version as defined in table 8.310. The total number of characters, including line terminators, shall not exceed 128 characters.

Table 8.310: Software version information element contents

Information element	Length ₂	Value	Remarks
Software version	n x 8		8 bits for each ASCII alphabet character

8.5.208 Speaker on off

The speaker on off information element shall be as defined in table 8.311.

Table 8.311: Speaker on off information element contents

Information element	Length	Value	Remarks
Speaker on off	1	0	Speaker Off
		1	Speaker On

8.5.209 SS PDU type

The SS PDU type information element is a mandatory information element and shall be the next element after SS type in every SS PDU. The information element encoding shall be as defined in EN 300 392-9 [12], clause 8.2.

8.5.210 SS type

The SS type information element shall specify the SS in question. The information element encoding shall be as defined in EN 300 392-9 [12], clause 8.1 for the SS type information element.

8.5.211 SSI

The SSI information element shall indicate the ASSI or (V) ASSI that the MS shall use in subsequent contacts with the SwMI as defined in table 8.312.

Table 8.312: Short Subscriber Identifier information element contents

Information element	Length	Value	Remarks
Short Subscriber Identity (SSI)	24		See EN 300 392-1 [1], clause 7

8.5.212 Stack usage

The stack usage information element shall give information indicating if the stack is used as defined in table 8.313.

Table 8.313: stack usage information element contents

Information element	Length	Value	Remarks
Stack usage	1	0	The messages are not stored in the stack
		1	The messages are stored in the stack

8.5.213 Status number

The status number information element shall define general-purpose status messages known to all TETRA systems as defined in EN 300 392-2 [3] and repeated in table 8.314.

Table 8.314: Status number information element contents

Information element	Length	Value	Remarks
Status number	16	0	Emergency
		1	Reserved
		etc.	etc.
		31 743	Reserved
		31 744	Refer to SDS-TL in clause 29 of EN 300 392-2 [3]
		etc.	etc.
		32 767	Refer to SDS-TL in clause 29 of EN 300 392-2 [3]
		32 768	Available for TETRA network and user specific definitions
		etc.	etc.
		65 535	Available for TETRA network and user specific definitions

8.5.214 Storage

The storage information element shall indicate if the SwMI is allowed to store the message as defined in table 8.315.

Table 8.315: Storage information element contents

Information element	Length	Value	Remarks
Storage	1	0	Storage not allowed
		1	Storage allowed

8.5.215 Store and forward PDU capability

The Store and forward capability information element shall give information on what PDUs store and forward are used as defined in table 8.316.

Table 8.316: Store and forward PDU capability information element content

Information element	Length	Value	Remarks
Store and forward PDU capability	2	0	None
		1	Transfer
		2	Transfer Report
		3	Transfer Report Ack

8.5.216 Terminal Equipment Identity (TEI)

TEI information element shall contain the TEI value of the MT2 as defined in EN 300 392-1 [1], clause 7.5 and repeated in table 8.317.

Table 8.317: TEI information element contents

Information element	Length	Value	Remarks
Type Approval Code (TAC)	24		8 characters (see note)
Final Assembly Code (FAC)	8		3 characters (see note)
Electronic Serial Number (ESN)	24		8 characters (see note)
Spare (SPR)	4		Reserved
NOTE: Each information element is a binary number and its values shall be presented as printable ASCII characters from "0" to "9", most significant digit placed first.			

8.5.217 Traffic stealing

The traffic stealing information element shall inform the MS/LS about preferred stealing policy as defined in table 8.318.

Table 8.318: Traffic stealing information element contents

Information element	Length ₂	Value	Remarks
Traffic Stealing	1	0	Do not steal traffic
		1	Steal traffic

8.5.218 TNP1 protocol version

The TNP1 protocol version information element shall inform the TE2 user application about the MT2 TNP1 protocol version as defined in table 8.319. The TNP1 protocol version shall contain the version of the present document.

The format of the TNP1 protocol version shall be according to the following rule: V1.2.1CRxxx where the V1.2.1 represents the version of the present document and the CRxxx represents the change request. The detail how change request number is allocated is outside the scope of the present document.

Table 8.319: Protocol version information element contents

Information element	Length	Value	Remarks
TNP1 protocol version	$n \times 8$		8 bits for each ASCII alphabet character

8.5.219 TNP1 release

The TNP1 release information element is devoted for free text manufacture dependent, as defined in table 8.320. The length of the TNP1 release information element is outside the scope of the present document.

Table 8.320: TNP1 release information element contents

Information element	Length	Value	Remarks
TNP1 release	$n \times 8$		8 bits for each ASCII alphabet character

8.5.220 Transmission condition

The transmission condition information element shall inform the MS/LS about requested transmission condition as defined in table 8.321.

Table 8.321: Transmission condition information element contents

Information element	Length	Value	Remarks
Transmission condition	1	0	Request to transmit
		1	Transmission ceased

8.5.221 Transmission grant

The transmission grant information element shall inform the MS/LS about permission to transmit as defined in table 8.322.

Table 8.322: Transmission grant information element contents

Information element	Length	Value	Remarks
Transmission grant	2	0	Transmission granted
		1	Transmission not granted
		2	Transmission request queued
		3	Transmission granted to another user

8.5.222 Transmission request permission

The transmission request permission information element shall inform the MS/LS if it is allowed to request for transmit permission as defined in table 8.323.

Table 8.323: Transmission request permission information element contents

Information element	Length	Value	Remarks
Transmission request permission	1	0	Allowed to request for transmission
		1	Not allowed to request for transmission

8.5.223 Transmission status

The transmission status information element shall be encoded as defined in table 8.324.

Table 8.324: Transmission status information element content

Information element	Length	Value ₂	Remarks
Transmission status	3	000	Transmission ceased
		001	Transmission granted
		010	Transmission not granted
		011	Transmission request queued
		100	Transmission granted to another user
		101	Transmission interrupt
		110	Transmission wait
		111	Transmission request failed

8.5.224 Transmitting party extension

The transmitting party extension information element shall indicate the extended part of the TSI address of the transmitting user as defined in table 8.325.

Table 8.325: Transmitting party extension information element contents

Information element	Length	Value	Remarks
Country Code	10	any	See EN 300 392-1 [1], clause 7
Network Code	14	any	See EN 300 392-1 [1], clause 7

8.5.225 Transmitting party Short Subscriber Identity (SSI)

The transmitting party Short Subscriber Identity information element shall indicate the Short Subscriber Identity (SSI) address of the transmitting user as defined in table 8.326.

Table 8.326: Transmitting party Short Subscriber Identity information element contents

Information element	Length	Value	Remarks
Short subscriber identity	24		See EN 300 392-1 [1], clause 7

8.5.226 Transmitting party type identifier

The transmitting party type identifier information element coding shall indicate the type of address, which shall follow in the PDU as defined in table 8.327.

Table 8.327: Transmitting party type identifier information element contents

Information element	Length	Value	Remarks
Transmitting party type identifier	2	0	Reserved
		1	Short Subscriber Identity (SSI)
		2	Tetra Subscriber Identity (TSI)
		3	Reserved

8.5.227 TX demand priority

The TX demand priority information element shall inform the SwMI about the importance of a TX-Demand as defined in table 8.328.

Table 8.328: TX demand priority information element contents

Information element	Length	Value	Remarks
TX demand priority	2	0	Low Priority level
		1	High Priority level
		2	Pre-emptive Priority level
		3	Emergency Pre-emptive Priority level

8.5.228 Type 3 CMCE element identifier

The type 3 CMCE element identifier information element shall indicate the type of the following type 3 element in the circuit mode and short data PDUs as defined in table 8.329.

Table 8.329: Type 3 CMCE element identifier information element contents

Information element	Length	Value ₂	Remarks
Type 3 CMCE element identifier	4	0000	Reserved
		0001	DTMF
		0010	External Subscriber number
		0011	Facility
		0100	Poll Response Addresses
		0101	Proprietary
		0110	Reserved for future type 3 CMCE element
		Etc.	etc.
1111	Reserved for future type 3 CMCE element		

8.5.229 Type 3 MM element identifier

The type 3 MM element identifier information element shall indicate the type of the following type 3 element in the mobility management PDUs as defined in table 8.330.

Table 8.330: Type 3 MM element identifier information element contents

Information element	Length	Value ₂	Remarks
Type 3 MM element identifier	4	0000	Reserved
		0001	Group identity location demand Ack
		0010	New registered area
		0011	Group identity location demand
		0100	Proprietary
		0101	Group identity location accept
		0110	Security
		0111	Group identity downlink
		1000	Group identity uplink
		1001	Reserved for future type 3 MM element
		etc.	etc.
		1111	Reserved for future type 3 MM element

8.5.230 Type 3 MTA element identifier

The type 3 MTA element identifier information element shall indicate the type of the following type 3 element in the MT application PDUs as defined in table 8.331.

Table 8.331: Type 3 MTA element identifier information element contents

Information element	Length	Value ₂	Remarks
Type 3 MTA element identifier	4	0000	Reserved
		0001	Manufacturer Identifier
		0010	Model
		0011	Software Version
		0100	Hardware Version
		0101	Product Serial No
		0110	ISO Global Object ID
		0111	TNP1 Protocol Version
		1000	TNP1 Release
		1001	Proprietary
		1010	Reserved for future type 3 MTA element
		etc.	etc.
		1111	Reserved for future type 3 MTA element

8.5.231 Type 3 SS element identifier

The type 3 SS element identifier information element shall indicate the type of the following type 3 element in the Supplementary services PDUs as defined in table 8.332.

Table 8.332: Type 3 SS element identifier information element contents

Information element	Length	Value ₂	Remarks
Type 3 SS element identifier	4	0000	Reserved
		0001	SS PDU type
		0010	SS facility parameters
		0011	Proprietary
		0100	Reserved for future type 3 SS element
		etc.	etc.
		1111	Reserved for future type 3 SS element

8.5.232 User application reference

The User application reference information element shall be used in local SDS and SDS-TL report indication as defined in table 8.333.

Table 8.333: User Application Reference element identifier information element contents

Information element	Length	Value	Remarks
User application reference	8	Any	

8.5.233 User data

The user data information element shall contain the application data as defined in table 8.334.

Table 8.334: User data information element contents

Information element	Length ₂	Length ₈	Type	C/O/M	Remarks
Length indicator	11	2	1	M	
Application user data	varies		1	C	See notes 1 and 2
NOTE 1: The length of this information element in bits shall be as defined by the Length indicator information element.					
NOTE 2: All bits are available for the user application.					

8.5.234 User defined data-1

The user defined data-1 information element shall enable the user applications to determine their own interpretation of the SDS message as defined in table 8.335.

Table 8.335: User defined data-1 information element contents

Information element	Length	Value	Remarks
User defined data-1	16	0 to $(2^{16} - 1)$	All values available for the user application

8.5.235 User defined data-2

The user defined data-2 information element shall enable the user applications to determine their own interpretation of the SDS message as defined in table 8.336.

Table 8.336: User defined data-2 information element contents

Information element	Length	Value	Remarks
User defined data-2	32	0 to $(2^{32} - 1)$	All values available for the user application

8.5.236 User defined data-3

The user defined data-3 information element shall enable the user applications to determine their own interpretation of the SDS message as defined in table 8.337.

Table 8.337: User defined data-3 information element contents

Information element	Length	Value	Remarks
User defined data-3	64	0 to $(2^{64} - 1)$	All values available for the user application

8.5.237 Visitor Group Short Subscriber Identity (V)GSSI

The (V)GSSI information element shall indicate that the MS shall use in subsequent contacts with the SwMI as defined in table 8.338.

Table 8.338: Visitor Group Short Subscriber Identity information element contents

Information element	Length	Value	Remarks
Visitor Group Short Subscriber Identity	24		See EN 300 392-1 [1]

8.5.238 Validity period

The validity period information element is defined in table 8.339.

Table 8.339: Validity period information element contents

Information element	Length	Value	Remarks
Validity period (VP)	6	0	No validity period, see note 1
		1 to 6	VP x 10 seconds, see note 2
		7 to 10	(VP - 5) x 1 minute, see note 3
		11 to 16	(VP - 10) x 10 minutes, see note 4
		17 to 21	(VP - 15) x 1 hour, see note 5
		22 to 24	(VP - 20) x 6 hour, see note 6
		25 to 30	(VP - 24) x 2 day, see note 7
		31	Infinite validity period, see note 8
		32	The MT2 default Validity period shall be used
NOTE 1: In this case, the SwMI should attempt to deliver the message. If unsuccessful, the message is dropped.			
NOTE 2: 10 s intervals up to 60 s.			
NOTE 3: 1 minute intervals up to 5 minutes.			
NOTE 4: 10 minute intervals up to 1 h.			
NOTE 5: 1 h intervals up to 6 h.			
NOTE 6: 6 h intervals up to 24 h.			
NOTE 7: 2 day intervals up to 12 days.			
NOTE 8: In this case, the SwMI should attempt to deliver the message until expiry of a network dependant maximum time.			

8.5.239 Volume level

The Volume level information element is defined in table 8.340.

Table 8.340: Volume level information element contents

Information element	Length	Value	Remarks
Volume level	6	0	Minimum
		1 to 64	Volume level setting (64 - maximum)

Annex A (normative): Formatting transparent circuit mode data to MAC PDU

The MAC-TRAFFIC PDU is used for sending U-plane traffic data on the uplink and downlink using TCH/S, TCH/7.2, TCH/4.8 or TCH/2.4, as defined in EN 300 392-2 [3], clause 21.4.6. This PDU has no header and all capacity is devoted to traffic information passed to and from the U-plane. When the MAC is in traffic mode, this PDU type is assumed unless the slot flag indicates the presence of the STCH.

This annex defines the formatting of transparent circuit mode data in the MAC-TRAFFIC PDU. This formatting should be used for all transparent circuit mode data originating from/targeted to TE2 over R_T and applications internal to MT2. Figure A.1 defines the general formatting to be applied to all TCHs. The Most Significant Bit (MSB) of any octet is placed in the MAC TRAFFIC PDU bit with the smallest ordinal number. Values for total number of octets (N) and total number of bits (B) per a MAC TRAFFIC PDU are defined in table A.1 for different TCHs.

Octet	1	2	etc.	N
MAC block bit	1 to 8	9 to 16	etc.	(B - 8) to B

Figure A.1: Octet and bit alignment in MAC TRAFFIC PDU

Table A.1: Capacity of a single MAC TRAFFIC PDU at different logical channels

Logical channel	Number of data bits (B)	Octets/timeslot (N)
TCH/7,2	432	54
TCH/4,8	288	36
TCH/2,4	144	18

The 8-bit (octet) formatting defined in this annex should be used as basic formatting to transfer transparent mode data of any character length. For other character lengths than 8-bit, a mapping to this basic formatting should be defined at application level.

NOTE: This mechanism removes all redundant information from the serial line lower layer character format and no information about possible parity bit or number of stop bits will be transferred over the AI. As a result e.g. 4 800 bit/s second low protected data rate is equivalent to 6 600 bit/s, when the serial line interface applies start bit, eight information bits, parity bit and one stop bit.

For half MAC blocks, the same octet and bit ordering and alignment should apply.

Annex B (informative): DMO Considerations

This annex is a reminder of the need for DMO to be included in a later edition of the present document. Both AT and TNP1 will need commands for DMO.

The context diagram will need updating to include DMO.

Features that will affect the DMO commands are:

- Select DMO or V+D mode. The mode command should differentiate V+D, DMO, dual watch, repeater and gateway modes. The profile, capability and service definition commands would then apply to the selected mode.
- The addressing during DMO mode may be different due to the repeater and gateway identities. This may need a change of the call set up commands or a new command to set the repeater or gateway address.
- An additional command to indicate DM channel state (available, occupied, reserved) and "in repeater range".
- The selection of DMO RF carrier and colour code. The reverse direction - to get the information on what channels and colour codes are available. The colour codes could be related to the MNI.
- There is no MM information in DMO.
- There are additional values for call set up and clear down elements, conversely some V+D reasons are not applicable.
- There are no full duplex calls in DMO.
- There is no packet data in DMO.
- There is no multi slot data in DMO.
- There are only four levels of priority in DMO (15 in V+D).
- DMO has acknowledged SDS transfer.

Annex C (informative): Supplementary Services Considerations

This annex is a place marker for future editions. When the air interface supplementary services become stable the PEI will have to cater for transfer of this information to and from the TE. The vehicle for supplementary services will be the SS facility elements. The coding of air interface SS facility elements will involve packing the air interface element bits into octets for use on the PEI.

Annex D (informative): Supported functionality and PPP options

At the initial publication date of the present standard, the following functionality and PPP options are supported in some MT2s on the market:

- Single PDP context.
- Context activation and context deactivation.
- Datagram relay from TE to SwMI and from SwMI to TE.
- IP static and dynamic addressing.
- IP user authentication.
- Header compression.

The following functionality may not available at present:

- Multiple PDP contexts.
- IP broadcast and multicast.
- Data compression.
- Mobile IPv4.
- IPv6 addressing.

Annex E:
Void

Annex F (normative): AT Multiplexing using +CMUX command

F.1 Introduction

The multiplexer protocol defined in TS 101 369 [2] operates between an MS and a TE and allows a number of simultaneous sessions over a normal serial asynchronous interface, where each session consists of a stream of bytes transferring various kinds of data. The multiplexer allows a complete system to be partitioned in a flexible way between a MS and TE, and provides a mechanism for conveying streams of data between TE and MS over a single start-stop framed, serial link.

In TETRA, AT multiplexer may be used to enable SDS and packet data to work in parallel, or DMO and V+D AT commands when the MS is working in dual watch.

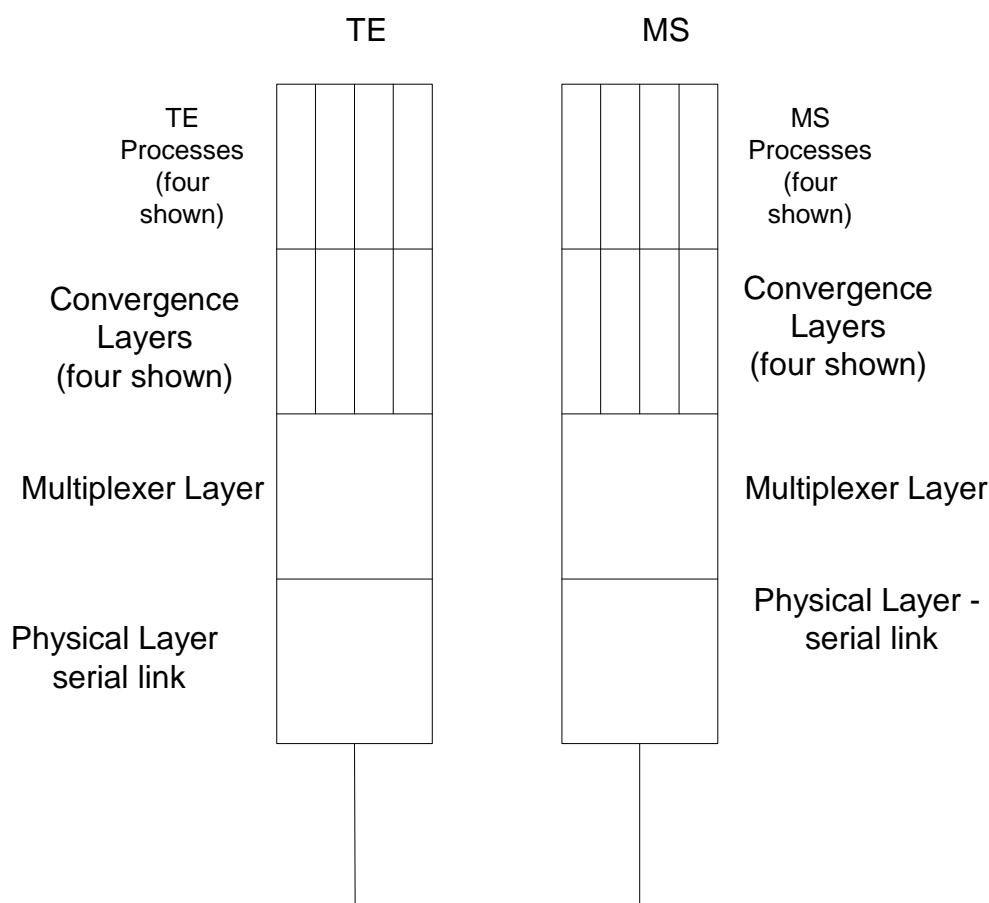

Figure F.1: AT multiplexer protocol stacks

Each channel between TE and MS is called a Data Link Connection (DLC) and has an identifier (DLCI). Each DLC may support individual flow control procedures for buffer management proposes.

DLCs have two modes of operation which are Error Recovery Mode (ERM) and non-Error Recovery Mode (non-ERM).

For more details on the multiplexer protocol and modes, see TS 101 369 [2].

F.2 Multiplexer mode activating procedure

The +CMUX command defined in TS 100 916 [7] starts the AT multiplexer mode, under which, each defined Data Link Connection shall meet the AT command requirements specified in clause 4.9.

The TE and MT may support the +CMUX command.

If the MT supports the +CMUX command, it shall support the Basic option, in which the multiplexer does not make use of any transparency mechanism nor error recovery method (see TS 100 916 [7], clause 5.7).

The MT may also support the Advanced option with or without error recovery mode.

F.3 DLCI service profile setting and changing procedure

Being in multiplexer mode, the TE may intend to establish different services on different DLCIs. For this purpose, the existing AT command +CTSP (see clause 6.14.4) shall be used to define or change the service profile for each DLCI.

F.4 Multiplexer mode close-down procedure

Initiation of the close-down will come from higher layers in either the TE or MS. Once the command to close down is received the multiplexer will close down each DLC in turn using the procedures as defined in TS 101 369 [2], clause 5.8.2.

Annex G (informative): DMO message sequences

G.1 Introduction

This annex contains some examples of message sequences between TE and MT, together with the messages that are sent over the DMO air interface to show the context. The examples are by no means exhaustive, particularly in the possible air interface messages, but the intention is that the MT should minimize the impact on the TE to MT message sequences for equivalent situations (from a TE perspective).

The TE interface provided by the MT in DMO is intended to be a similar to V+D as possible.

G.2 Configuring required operation

G.2.1 Set operating mode to DMO

Information flow for setting operating mode to DMO is presented in figure G.1.

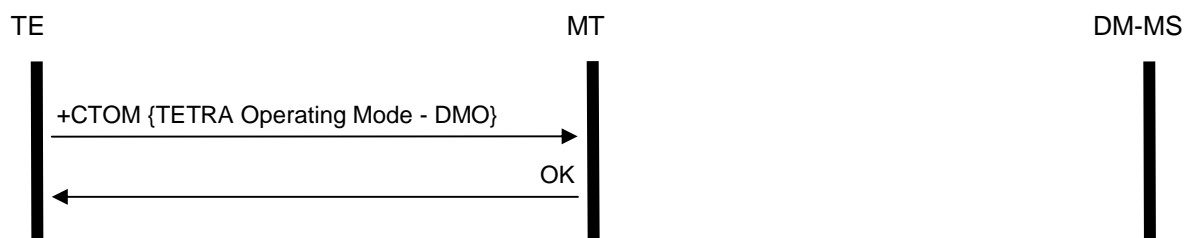

Figure G.1: Set operating mode to DMO

G.2.2 Select gateway operation

Information flow for selecting gateway operating mode is presented in figure G.2.

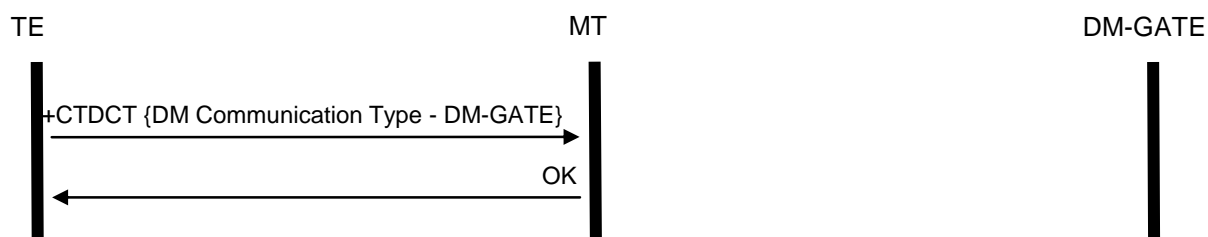

Figure G.2: Select gateway operation

G.2.3 Select DM gateway known to be present

Information flow for selecting DM gateway known to be present is presented in figure G.3.

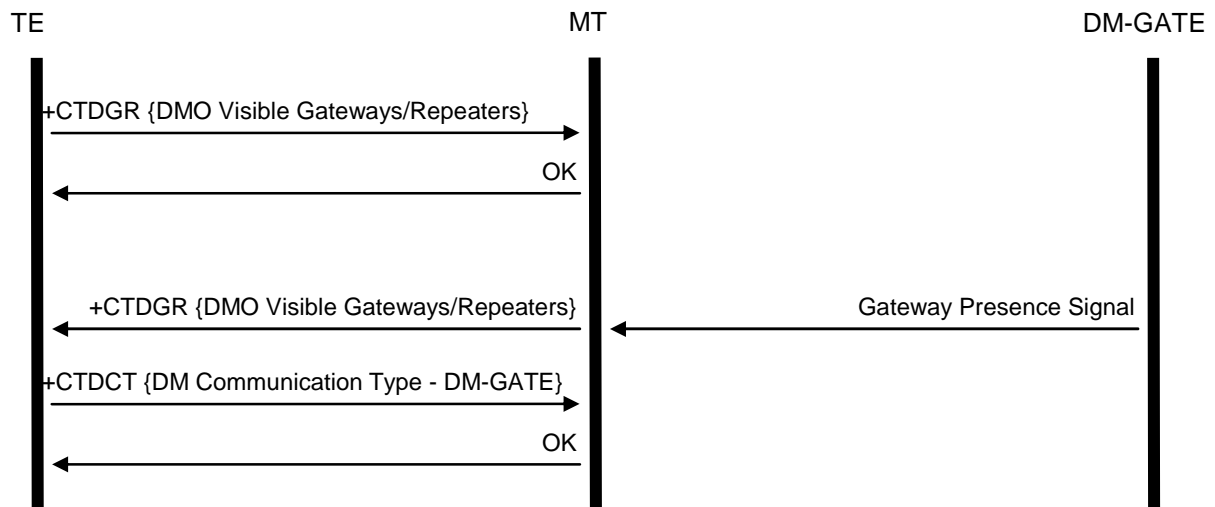

Figure G.3: Select DM gateway known to be present

G.2.4 DM gateway selected by MT

Information flow for DM gateway selected by MT is presented in figure G.4.

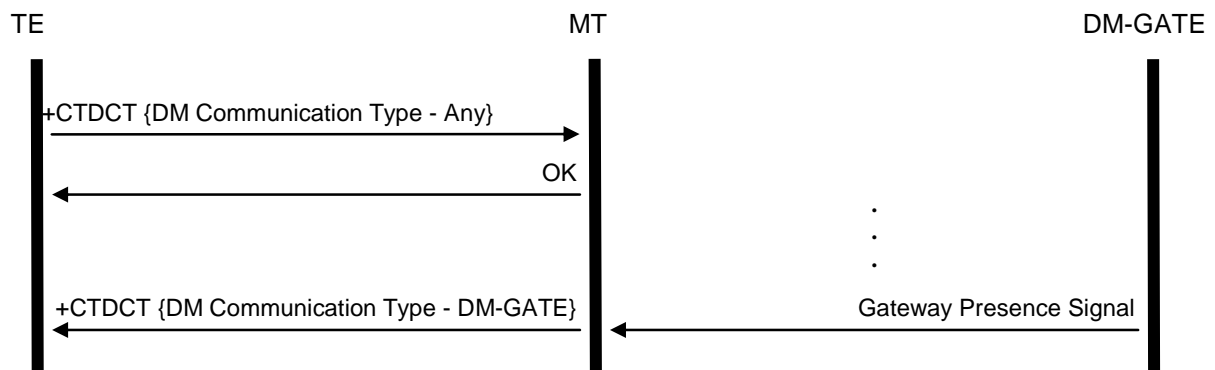

Figure G.4: DM gateway selected by MT

G.3 Call set-up

G.3.1 Incoming group call set-up (success)

Information flow for a successful incoming group call is presented in figure G.5.

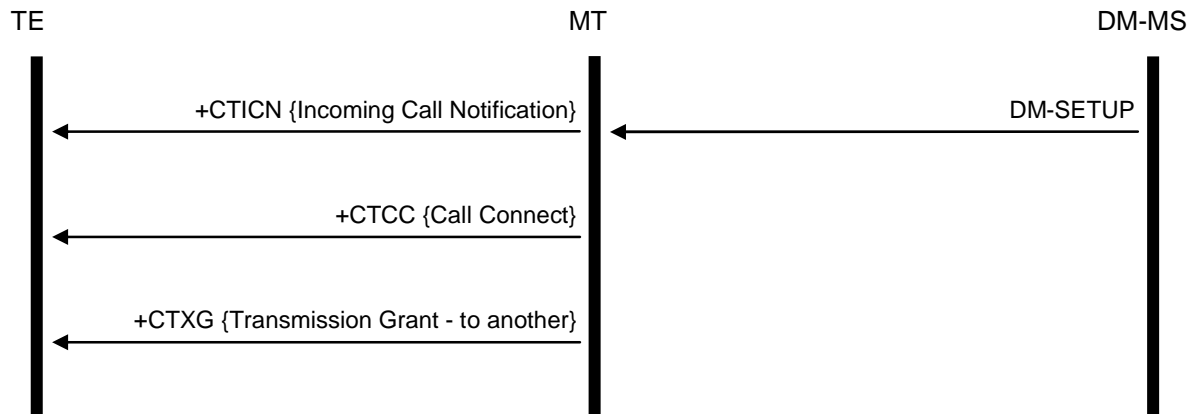

Figure G.5: Incoming group call set-up (success)

The message sequence is the same for an incoming individual call without presence check. The DM-MS may be a DM-MS, DM-REP, DM-GATE or DM-REP/GATE.

G.3.2 Incoming individual call set-up with presence check (success)

Information flow for a successful incoming group call with presence check is presented in figure G.6.

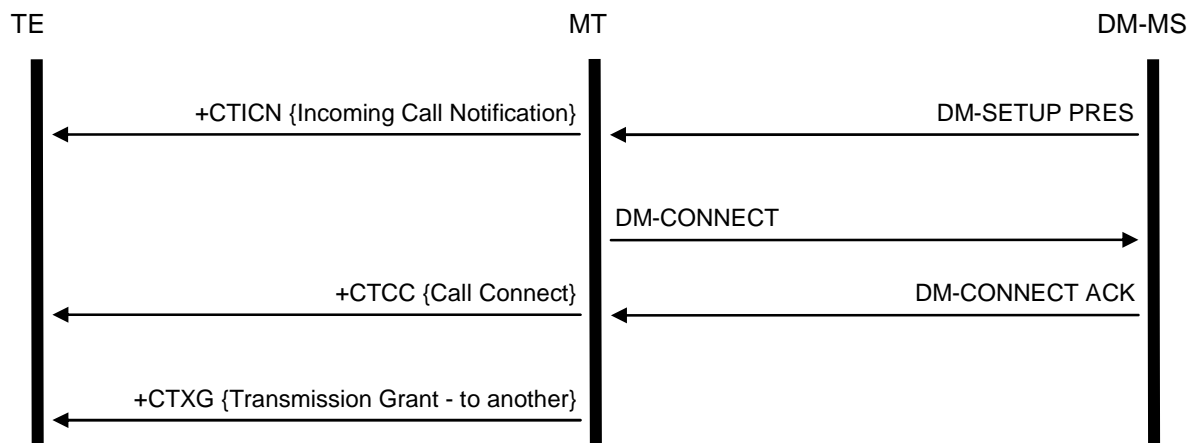

Figure G.6: Incoming individual call set-up with presence check (success)

The DM-MS may be a DM-MS, DM-REP, DM-GATE or DM-REP/GATE.

G.3.3 Incoming individual call set-up with presence check (rejected by MT)

Information flow for MT rejected incoming group call with presence check is presented in figure G.7.

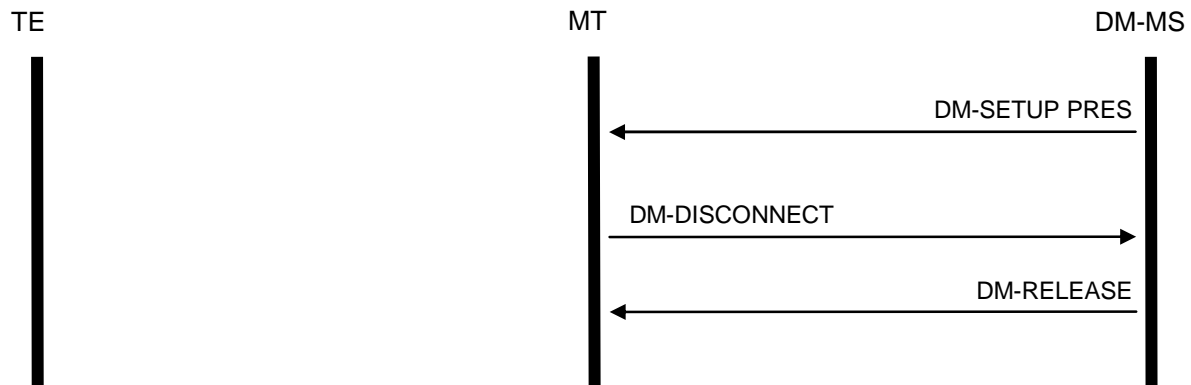

Figure G.7: Incoming individual call set-up with presence check (rejected by MT)

The DM-MS may be a DM-MS, DM-REP, DM-GATE or DM-REP/GATE.

G.3.4 Incoming individual call set-up with presence check (rejected by TE)

Information flow for TE rejected incoming group call with presence check is presented in figure G.8.

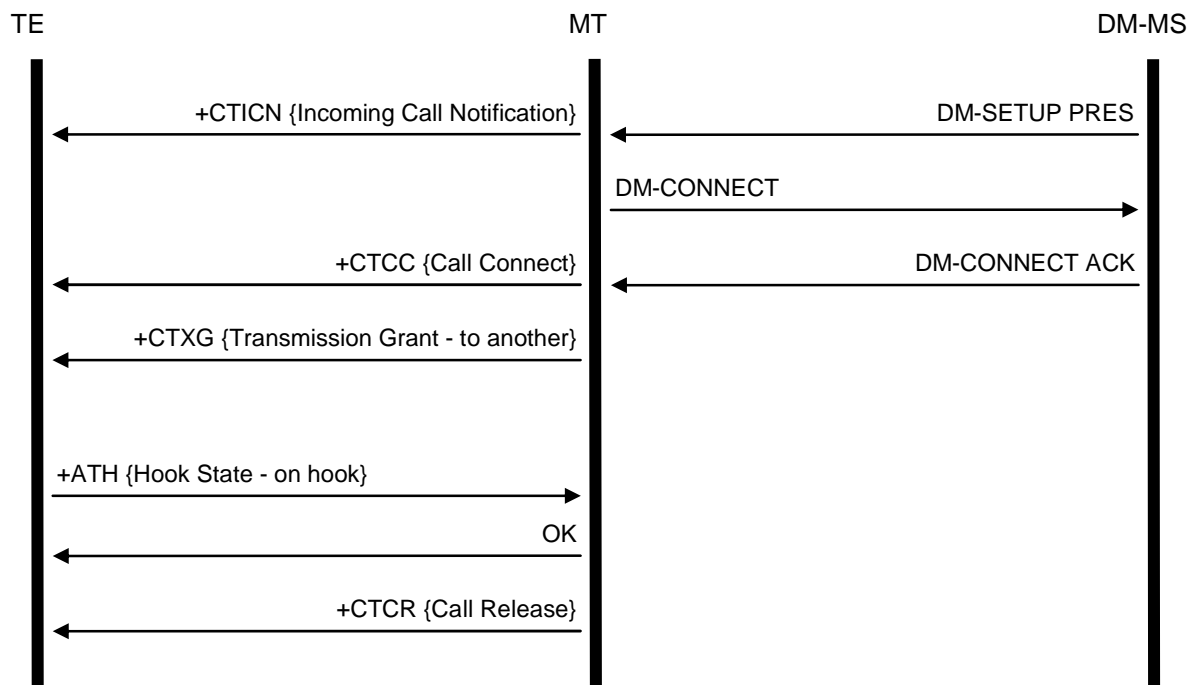

Figure G.8: Incoming individual call set-up with presence check (rejected by TE)

The MT responds to the presence check. TE rejects the call with +ATH. MT is a Slave so performs a local release. The DM-MS may be a DM-MS, DM-REP, DM-GATE or DM-REP/GATE.

G.3.5 Outgoing group call set-up (success)

Information flow for a successful outgoing group call is presented in figure G.9.

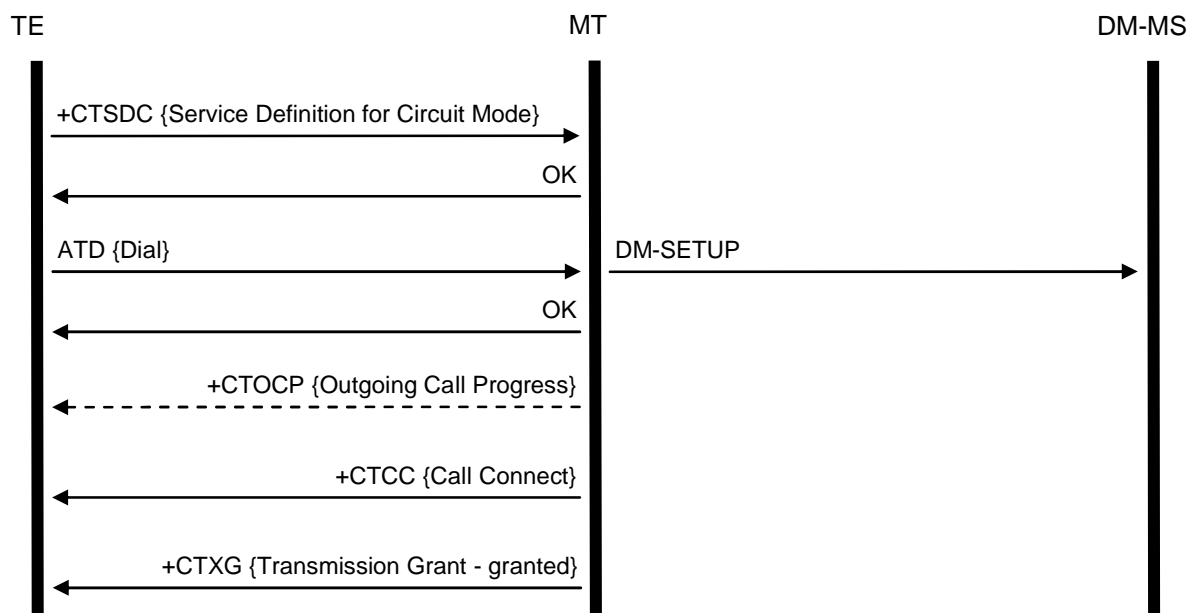

Figure G.9: Outgoing group call set-up (success)

The message sequence is the same for an outgoing individual call without presence check. The DM-MS may be a DM-MS or DM-REP.

G.3.6 Outgoing individual call set-up with presence check (success)

Information flow for a successful outgoing group call with presence check is presented in figure G.10.

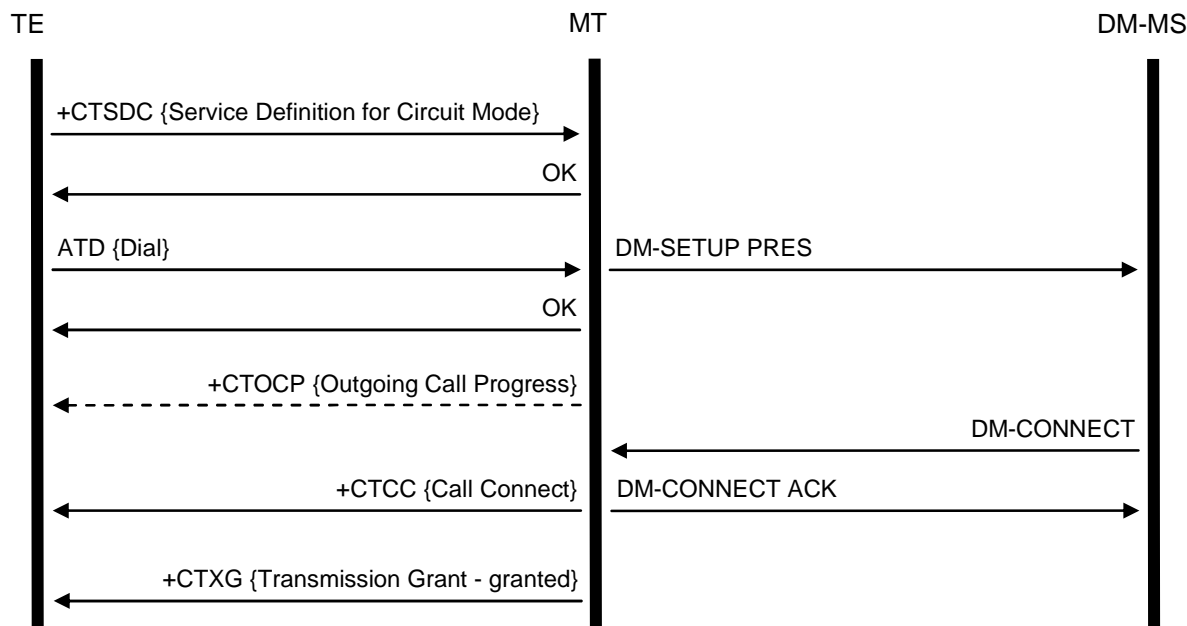

Figure G.10: Outgoing individual call set-up with presence check (success)

The DM-MS may be a DM-MS or DM-REP.

G.3.7 Outgoing group call set-up via gateway (success)

Information flow for a successful outgoing group call via gateway is presented in figure G.11.

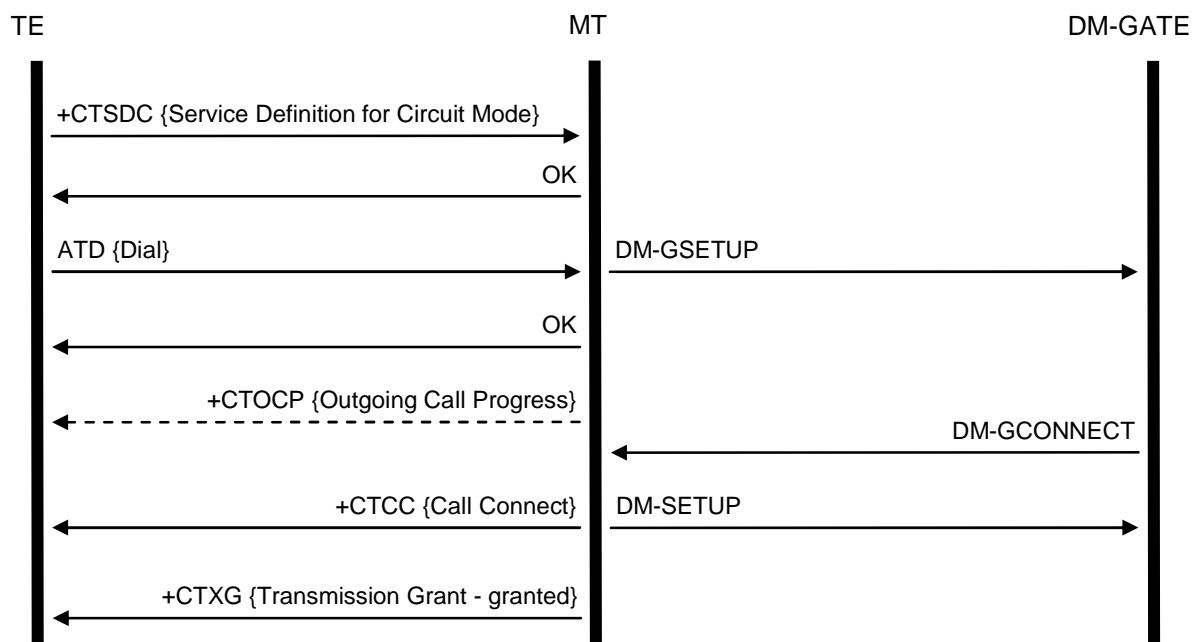

Figure G.11: Outgoing group call set-up via gateway (success)

G.3.8 Outgoing individual call set-up via gateway (success)

Information flow for a successful outgoing individual call via gateway is presented in figure G.12.

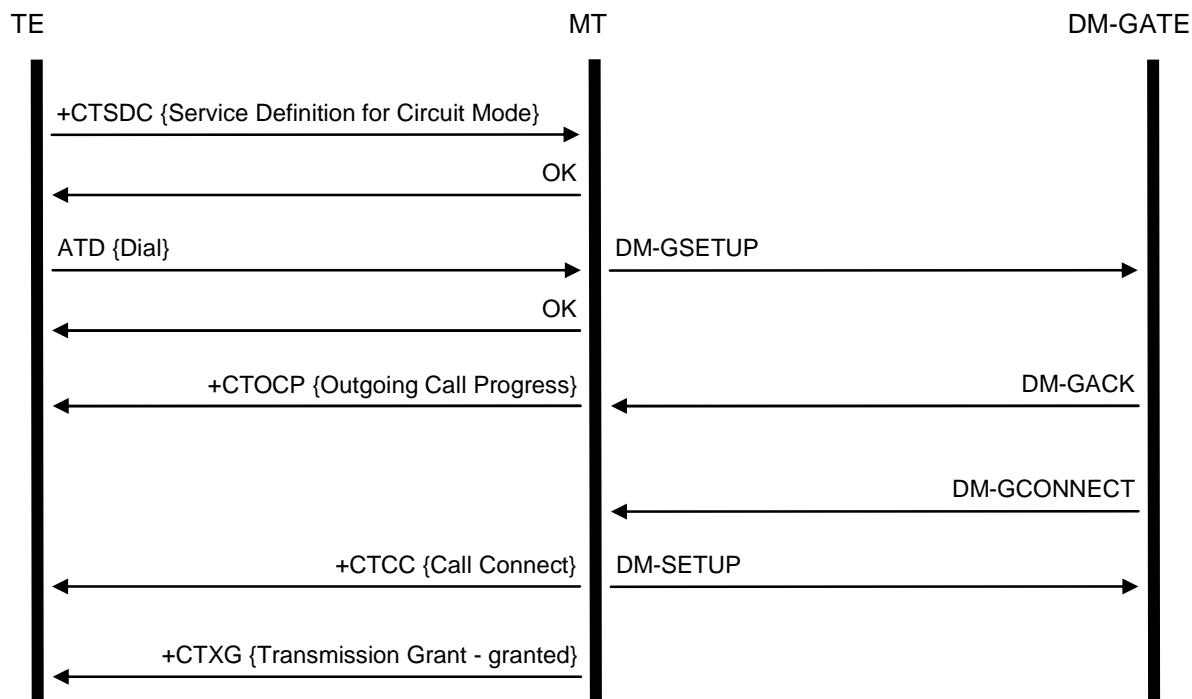

Figure G.12: Outgoing individual call set-up via gateway (success)

G.3.9 Outgoing call set-up (rejected by MT)

Information flow for a MT rejected outgoing group call is presented in figure G.13.

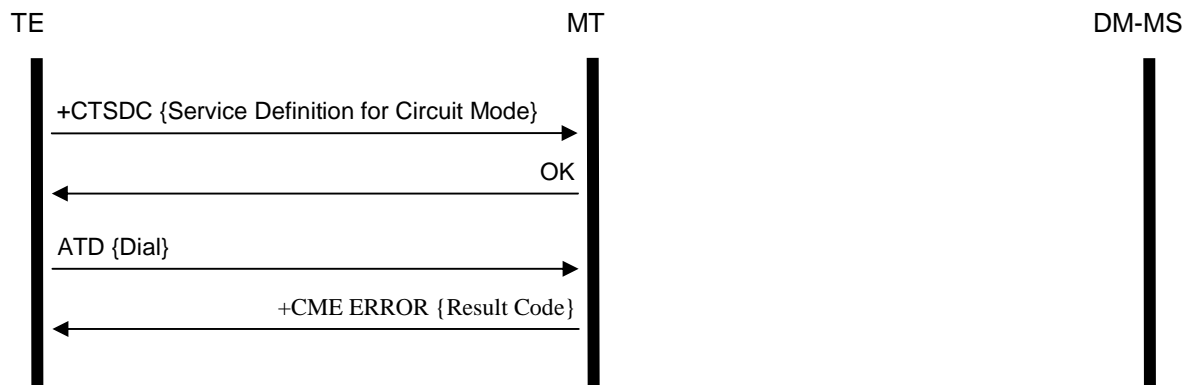

Figure G.13: Outgoing individual call set-up with presence check (failure)

The DM-MS may be a DM-MS or DM-REP.

G.3.10 Outgoing individual call set-up with presence check (failure)

Information flow for a failed outgoing individual call with presence check is presented in figure G.14.

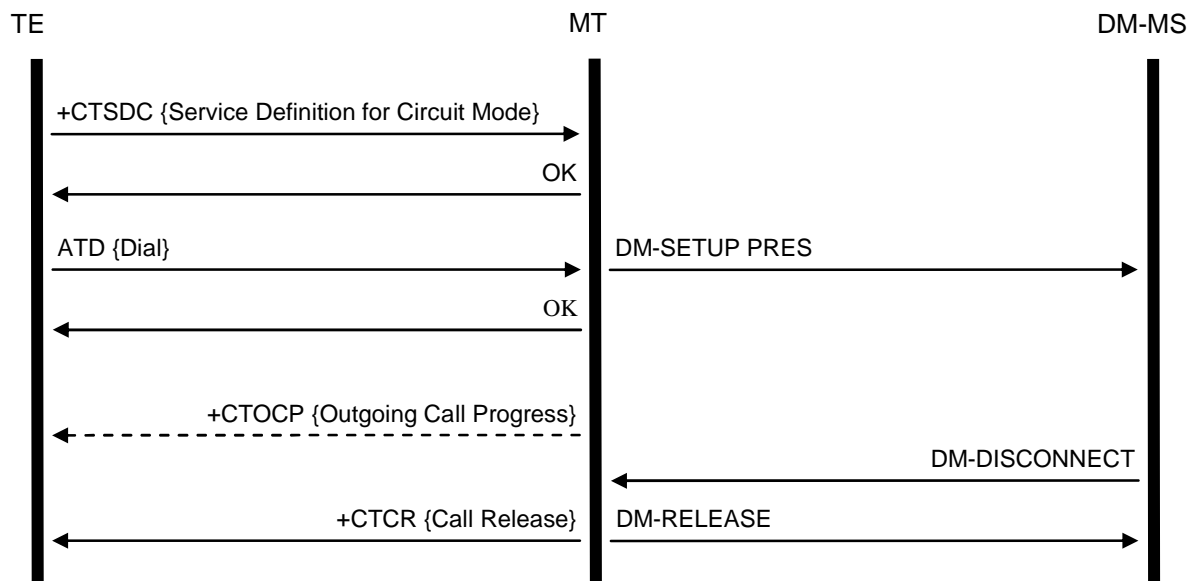

Figure G.14: Outgoing individual call set-up with presence check (failure)

The DM-MS may be a DM-MS or DM-REP.

G.4 Call maintenance

G.4.1 End of transmission

Information flow for an end of transmission action is presented in figure G.15.

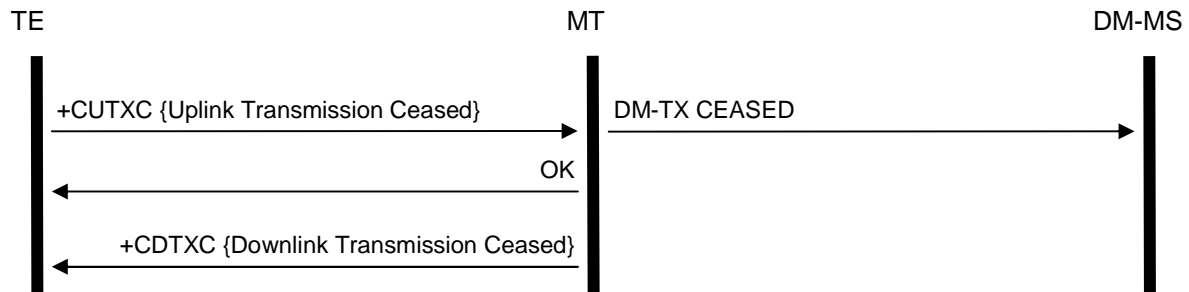

Figure G.15: End of transmission

The DM-MS may be a DM-MS, DM-REP, DM-GATE or DM-REP/GATE.

G.4.2 End of transmission by another party

Information flow for an end of transmission by another party action is presented in figure G.16.

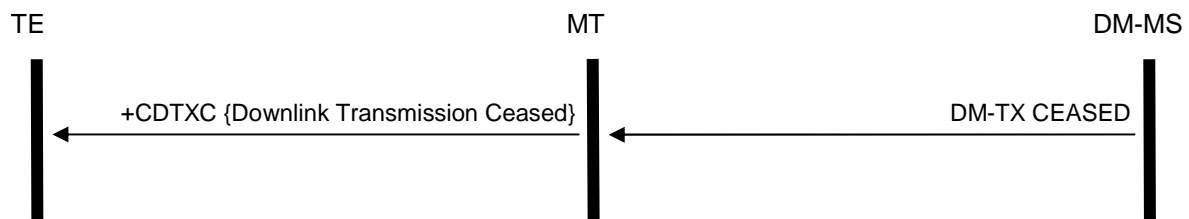

Figure G.16: End of transmission by another party

The DM-MS may be a DM-MS, DM-REP, DM-GATE or DM-REP/GATE.

G.4.3 Transmit request when slave in reservation (success)

Information flow for a successful transmit request when slave in reservation is presented in figure G.17.

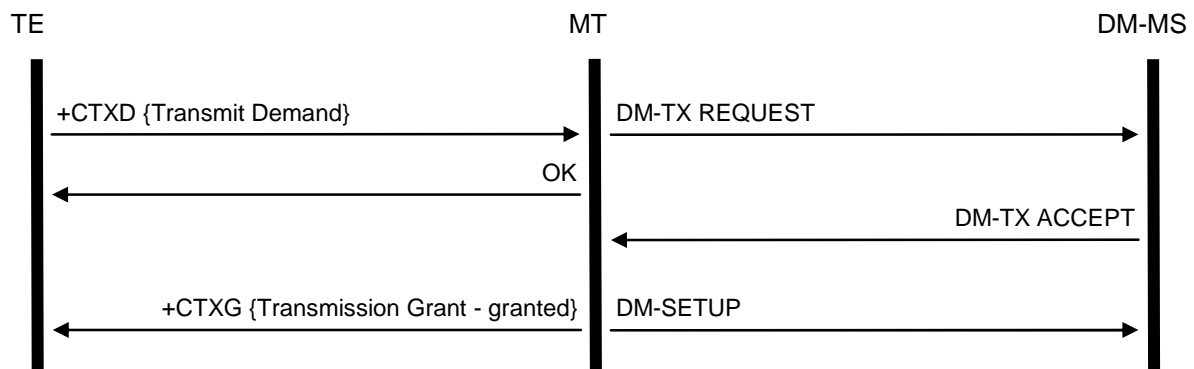

Figure G.17: Transmit request when slave in reservation (success)

The DM-MS may be a DM-MS or DM-REP.

G.4.4 Transmit request via gateway when slave in reservation (success)

Information flow for a successful transmit request via gateway when slave in reservation is presented in figure G.18.

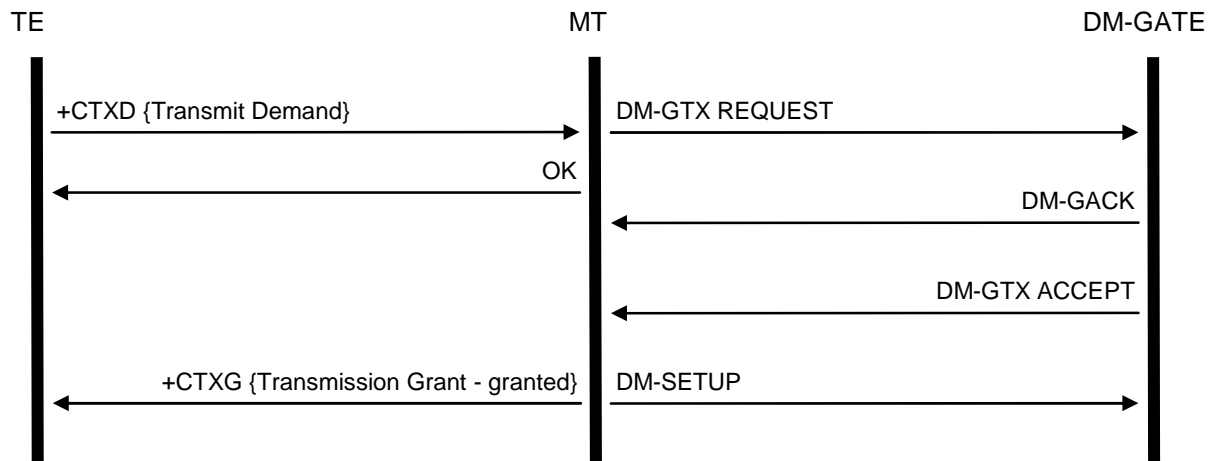

Figure G.18: Transmit request via gateway when slave in reservation (success)

G.4.5 Transmit request when master in reservation

Information flow for a successful transmit request when master in reservation is presented in figure G.19.

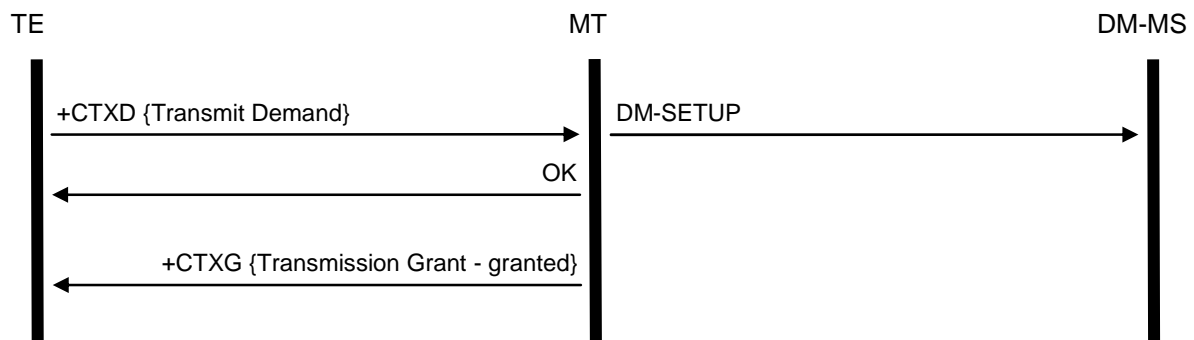

Figure G.19: Transmit request when master in reservation

The DM-MS may be a DM-MS or DM-REP.

G.4.6 Incoming transmit request when master in reservation (success)

Information flow for an incoming successful transmit request when master in reservation is presented in figure G.20.

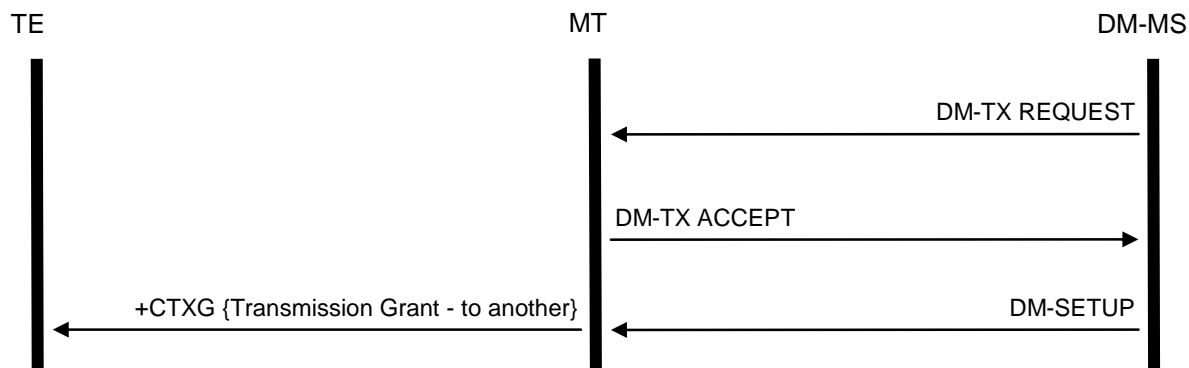

Figure G.20: Incoming transmit request when master in reservation (success)

The DM-MS may be a DM-MS or DM-REP.

G.4.7 Incoming transmit request when slave in reservation

Information flow for an incoming transmit request when slave in reservation is presented in figure G.21.

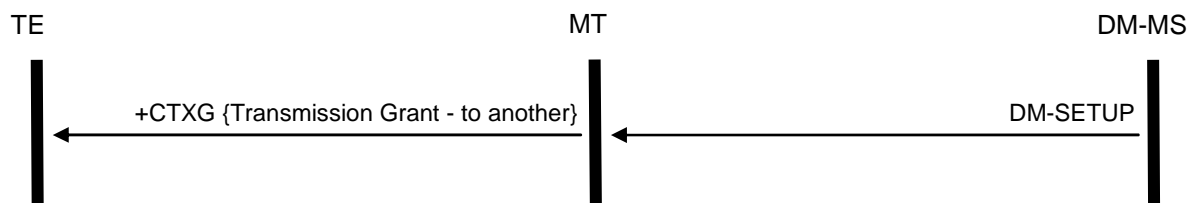

Figure G.21: Incoming transmit request when slave in reservation

The DM-MS may be a DM-MS, DM-REP, DM-GATE or DM-REP/GATE.

G.4.8 Pre-emptive transmit request when slave in occupation (success)

Information flow for a successful pre-emptive transmit request when slave in occupation is presented in figure G.22.

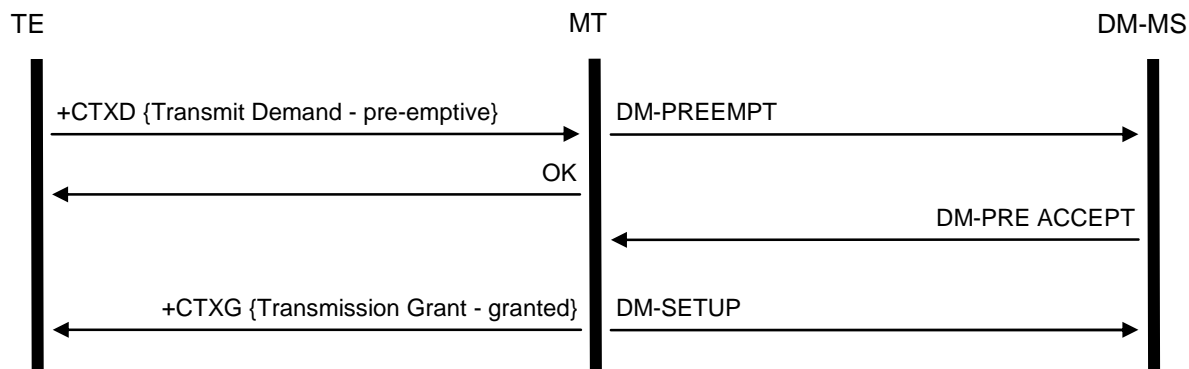

Figure G.22: Pre-emptive transmit request when slave in occupation (success)

The DM-MS may be a DM-MS or DM-REP.

G.4.9 Incoming pre-emptive transmit request when master in occupation

Information flow for an incoming pre-emptive transmit request when master in occupation is presented in figure G.23.

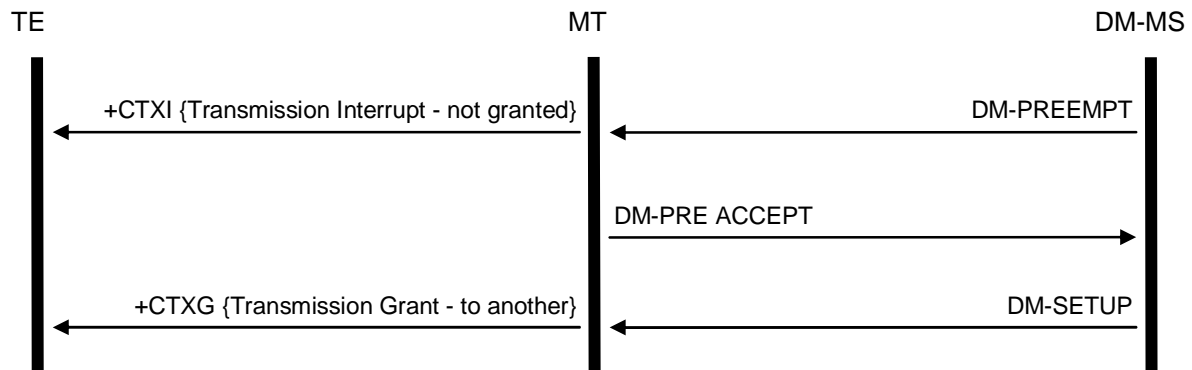

Figure G.23: Incoming pre-emptive transmit request when master in occupation (success)

The DM-MS may be a DM-MS, DM-REP, DM-GATE or DM-REP/GATE.

G.4.10 Incoming pre-emption for new call when master in occupation

Information flow for an incoming pre-emption for a new call when master in occupation is presented in figure G.24.

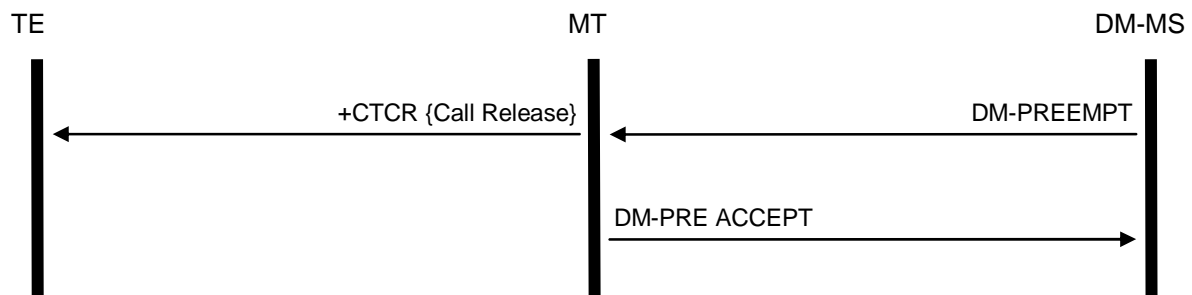

Figure G.24: Incoming pre-emption for new call when master in occupation (success)

The DM-MS may be a DM-MS, DM-REP, DM-GATE or DM-REP/GATE.

G.5 Call release

G.5.1 Call cleared by timeout when master in reservation

Information flow for a call cleared by timeout when master in reservation is presented in figure G.25.



Figure G.25: Call cleared by timeout when master in reservation

The DM-MS may be a DM-MS or DM-REP.

G.5.2 Call cleared by TE when master in reservation

Information flow for a call cleared by TE when master in reservation is presented in figure G.26.

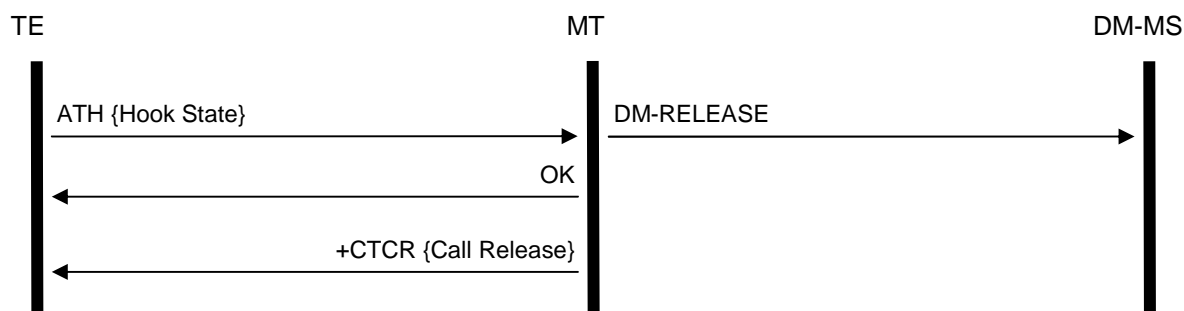

Figure G.26: Call cleared by TE when master in reservation

The DM-MS may be a DM-MS or DM-REP.

G.5.3 Call cleared by other party when slave

Information flow for a call cleared by other party when slave is presented in figure G.27.

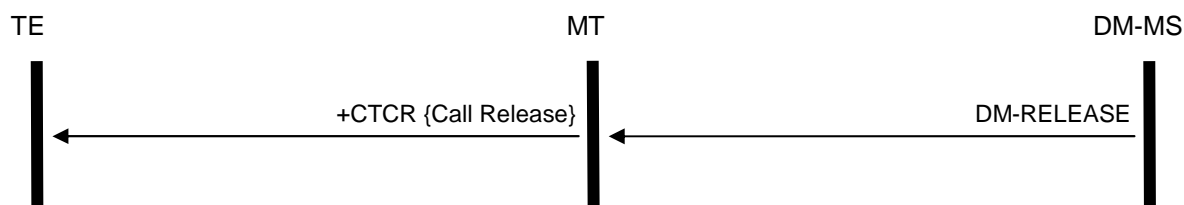

Figure G.27: Call cleared by other party when slave

The DM-MS may be a DM-MS, DM-REP, DM-GATE or DM-REP/GATE.

G.5.4 Call cleared by timeout when slave

Information flow for a call cleared by timeout when slave is presented in figure G.28.

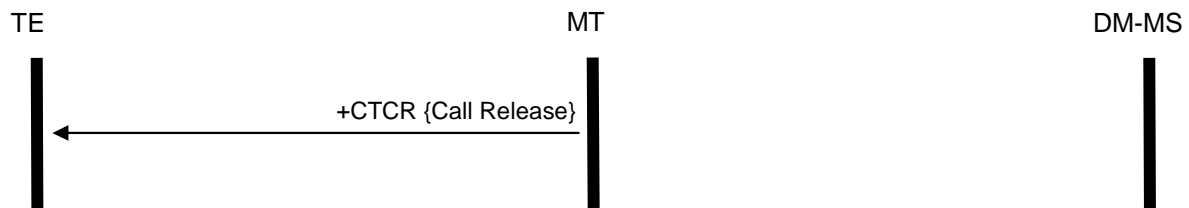

Figure G.28: Call cleared by timeout when slave

The DM-MS may be a DM-MS, DM-REP, DM-GATE or DM-REP/GATE.

G.6 Transient Calls

G.6.1 Direct Call when operating with DM gateway

Information flow for a direct call when operating with DM gateway is presented in figure G.29.

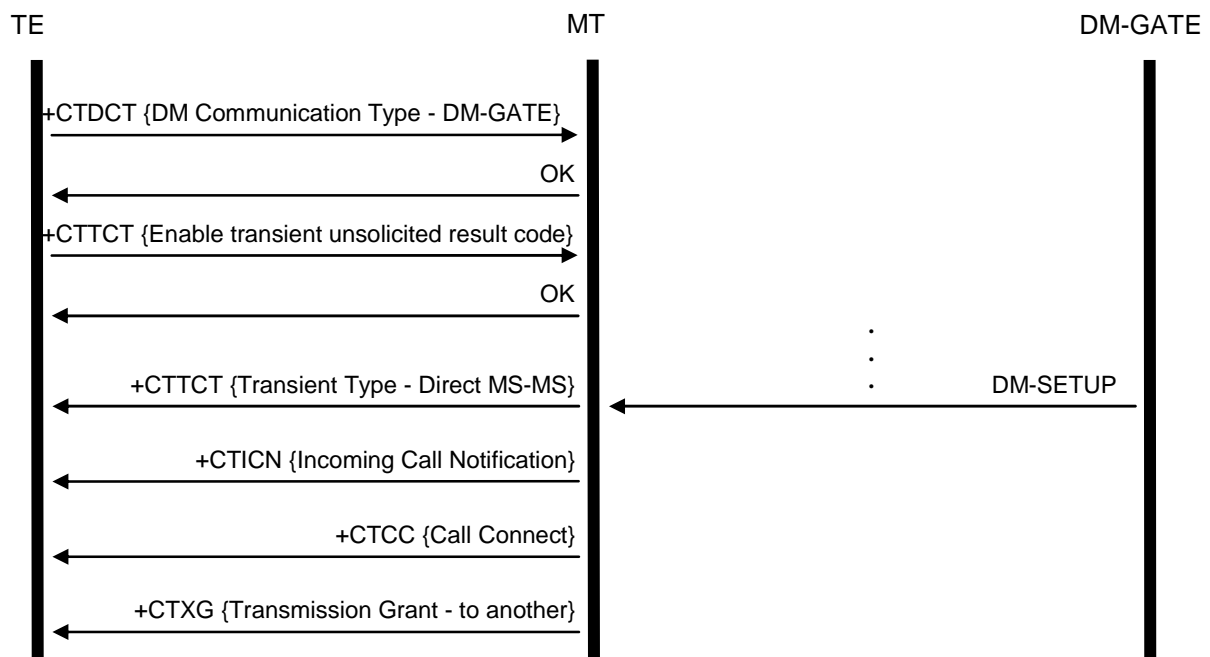

Figure G.29: Direct call when operating with DM gateway

G.6.2 Direct Call when in V+D with dual watch on DMO

Information flow for a direct call when in V+D with dual watch on DMO is presented in figure G.30.

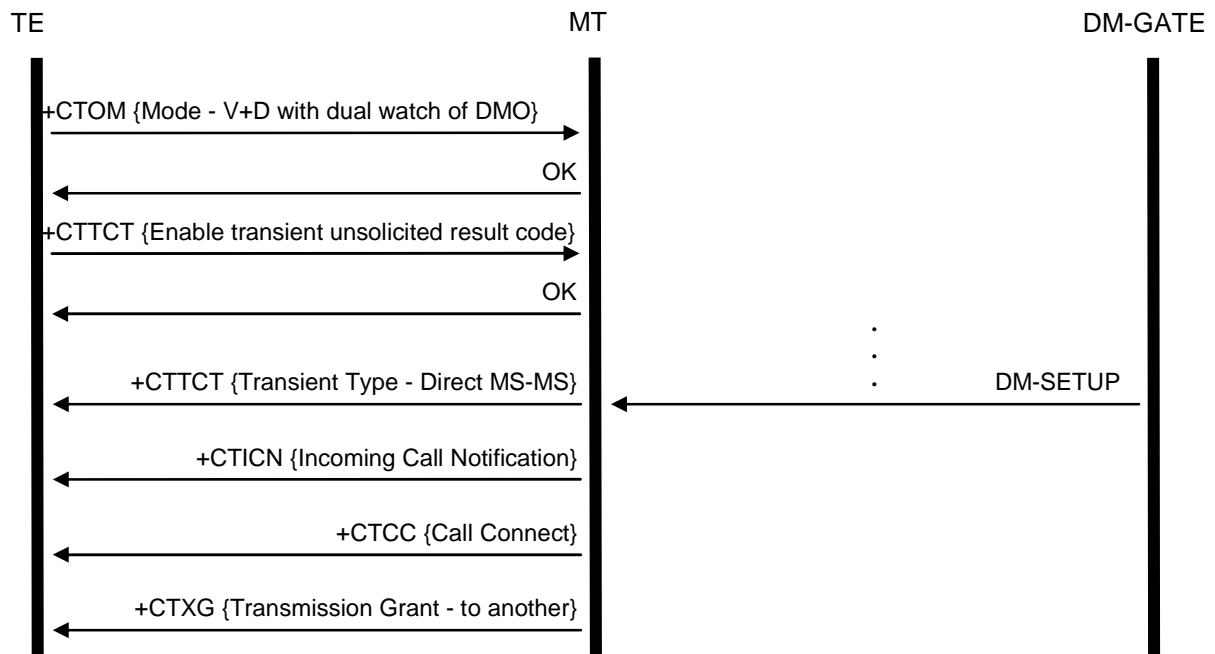

Figure G.30: Direct call when in V+D with dual watch on DMO

Annex H (informative): Change requests

The present document contains change requests as described in table H.1.

Table H.1: Change requests

No	CR vers.	Standard Version	TS	EN	Clauses affected	Title
001	APP	V1.1.1	X	X	8.4.7.4	TNP1: remove "Short form report" element from TESDS-TL-REPORT REQ
002	APP	V1.1.1	X	X	8.5.71, 8.5.169	TNP1: add "Length indicator" o the variable length SDS-TL User data
003	APP	V1.1.1	X	X	8.4.5.2	TNP1 SDSTL capability
004	APP	V1.1.1	X	X	8.5.92	TNP1 Missing PDUs IDs
005	APP	V1.1.1	X	X	8.4.5.13.6, 8.5.69	TNP1 SDS message status
006	APP	V1.1.1	X	X	8.5.117A	TNP1 SDS message stack notification
007	APP	V1.1.1	X	X	8.4.5.17	TNP1 Bit Error Ratio & Field strength
008	APP	V1.1.1	X	X	8.3.1	TNP1 PDUs structure
009	APP	V1.1.1	X	X	6.17.19	PEI error codes vs. GSM error codes
010	APP	V1.1.1	X	X	8.5.112, 8.5.123	TNP1: add "Neither" to "SDS control"
011	APP	V1.1.1	X	X	8.4.4.15A, 8.4.5.11, 8.4.5.13.5, 8.5.92	TNP1: Fields changes in several PDUs
012	APP	V1.1.1	X	X	8.4.6.4, 8.4.6.5, 8.4.6.6, 8.4.7.1, 8.4.7.3, 8.4.7.5, 8.4.7.8	TNP1: C/O/M fields changed in several SDS and SDS-TL PDUs
013	APP	V1.1.1	X	X	8.4.5.1, 8.5.8, 7.4.8	TNP1: Battery charge optional
014	APP	V1.1.1	X	X	8.4.6.4, 8.4.6.5, 8.4.6.6, 8.4.7.1, 8.4.7.2, 8.4.7.3, 8.4.7.4, 8.4.7.6, 8.4.7.6, 8.4.7.8, 8.4.7.9	TNP1: ESN mandatory
015	APP	V1.1.1	X	X	8.3.1	TNP1: Wrong references
016	APP	V1.1.1	X	X	8.3.1, 8.3.2, 8.3.3	TNP1: PDU encoding rules
017	APP	V1.1.1	X	X	8.4.2.9	PDU encoding rule in 8.4.2.9 TECC-NOTIFY IND
018	APP	V1.1.1	X	X	4.10.1	TNP1: Port numbers allocated by IANA
019	APP	V1.1.1	X	X	8.5.8, 8.5.9, 8.5.12, 8.5.13, 8.5.15, 8.5.16, 8.5.18, 8.5.19, 8.5.22, 8.5.33, 8.5.49, 8.5.50, 8.5.51, 8.5.62, 8.5.63, 8.5.71, 8.5.77, 8.5.79, 8.5.81, 8.5.86, 8.5.95, 8.5.104, 8.5.113, 8.5.114, 8.3.115, 8.5.122, 8.5.131, 8.5.133, 8.5.135, 8.5.138, 8.5.139, 8.5.147, 8.5.160, 8.5.161, 8.5.174	Editorial completion of some table on the (missing) reserved values
101	21	V1.2.1	X	X	6.17.13, 8.5.28	TETRA version number
103	10	V1.2.1	X	X	2, 3.2, 4.9.1, annex F	Adding Multiplexing mode in AT commands
104	20	V1.2.1	X	X	6.15.4.2, 6.15.4.3	Called Party ID in Group Calls
105	REJ					Withdrawn
106	10	V1.2.1	X	X	Many	Various editorial Inconsistencies
107	11	V1.2.1	X	X	6.15.4.3	Addition of call priority element in +CTICN.
108	20	V1.2.1	X	X	6.15.7.3	Addition of Calling Party element to +CTSDSR

No	CR vers.	Standard Version	TS	EN	Clauses affected	Title
109	10	V1.2.1	X	X	6.17.37	Addition of SDS status parameter in the +CMGS command
110	10	V1.2.1	X	X	6.12.7.3	Removal of User data parameter from +CMTI command
111	10	V1.2.1	X	X	6.17.16	Addition of the "Called party requires encryption" disconnect cause parameter to the +CTCR command
112	10	V1.2.1	X	X	6.11.5 (new), 6.17.21a, 6.17.23a, 6.17.51a	Introduction of new AT Commands for Tetra Identities
113	10	V1.2.1	X	X	6.17.19	A new extended error report code is needed to indicate that the requested service is not supported in DMO
114	10	V1.2.1	X	X	6.15.2.1, 6.15.2.3, 6.15.10.1, 6.15.10.2, 6.18.2, 6.18.3, 6.19.2, 6.19.3	Making +CTXG mandatory for both voice and circuit mode data calls, and CONNECT for circuit mode data calls
115	10	V1.2.1	X	X	6.15.5.2	Removal of the association of CTOCP with D-CONNECT
116	11	V1.2.1	X	X	6.12.7.3	Potential encoding mistake in 6.12.7.3
117	20	V1.2.1	X	X	6.17.22, 6.17.26, 6.17.32	Alteration of description Addition of an extra value for a "reg stat" value to remove inaccurate definition of default value.
118	10	V1.2.1	X	X	6.17.19	New entries in "Result Code" for "service not available" and "transmissions are inhibited"
119	10	V1.2.1	X	X	16.4.4.1, 16.4.4.3	MT default values are defined by manufacturers
120	10	V1.2.1	X	X	6.12.3.4, 6.12.4.4, 6.15.4.3	Harmonization of calling/called address and calling/called address type definitions
121	10	V1.2.1	X	X	6.17.19	Usage of PEI error report codes
122	10	V1.2.1	X	X	6.17.32	Clarification of the reg stat values
123	10	V1.2.1	X	X	6.17.22	Location area code presentation
124	10	V1.2.1	X	X	6.11, 6.12, 6.13, 6.14, 6.15 (General clauses)	Mandatory/optional definitions
125	10	V1.2.1	X	X	6.13.3, 6.15.7	+CTSDSR incoming SDS messages
126	10	V1.2.1	X	X	4.12	TNP1 setup reference
201	REJ	V1.3.1	X	X	6.14.4.3	Service profile
202	10	V1.3.1	X	X	2, 3, 4, 6, new annex G	Extension of PEI to support DMO features
203	10	V1.3.1	X	X	8.3.5, 8.4	TNP1 PDU type length
204	10	V1.3.1	X	X	Many	Updates for TEDS support
205	10	V1.3.1	X	X	6.17.19	Extended error codes for DMO
206	10	V1.3.1	X	X	6.14.4, 6.17.4, 6.17.32 (new)	Presentation of the service layer2 and PID parameters
207	10	V1.3.1	X	X	6.17.13, 8.5.28	Version number update
208	10	V1.3.1	X	X	6.3, 6.4.1, 6.4.4, many others in clause 6	AT command optional parameters presentation and use of commas
209	10	V1.3.1	X	X	6.4.7, 6.16.2.3, 6.16.4, 6.17.22, 6.17.23, 6.17.38	New parameters
210	10	V1.3.1	X	X	6.4.6.4, 6.12.1, 6.15.8.3, 6.15.9.3	Reference and presentation mistakes
211	REJ	V1.3.1	X	X	6.13.4	SDS Receive end-to-end encrypted
212	10	V1.3.1	X	X	6.11.2.3, 6.15.6.4	Additional lines encoding
213	10	V1.3.1	X	X	3.1, 6.4.2.4, 6.4.5, 6.4.6.4, 6.12.4.4, 6.15.2.3	Editorial corrections and clarifications
214	01	V1.3.1	X	X	6.17.4, 6.17.16	DMO modifications
301	10	V1.3.1	X	X	6.7, 6.14.12	Change to ATZ command and introduction of ATR for rebooting
302	10	V1.3.1	X	X	6.14.4.3, 6.16.4.4	Service Profile for SDS type 4
303	10	V2.1.1	X	X	6.15.15 (new), 6.17.5a (new), 6.17.29a (new), 6.17.29b (new)	Key press indication
304	10	V2.1.1	X	X	6.5.3, 6.17.9, 6.17.10, 6.17.11, 6.17.12, 6.17.38	Open TSI presentation
305	10	V2.1.1	X	X	6.4.3, 6.4.6.1	Clarification to the usage of "AT" prefix

No	CR vers.	Standard Version	TS	EN	Clauses affected	Title
402	11	V2.1.1	X	X	6.14.4.3	Service profile allowed values for new services
404	02	V2.1.1	X	X	6.4.4, 6.4.5	Clarification to the usage of separating commas

History

Document history		
V1.1.1	September 2001	Publication
V1.2.1	November 2003	Publication
V1.3.1	August 2007	Publication
V2.2.0	March 2010	One-step Approval Procedure OAP 20100710: 2010-03-12 to 2010-07-12