

EN 300 188-1 V1.2.4 (1998-06)

European Standard (Telecommunications series)

**Integrated Services Digital Network (ISDN);
Three Party (3PTY) supplementary service;
Digital Subscriber Signalling System No. one (DSS1) protocol;
Part 1: Protocol specification**



Reference

REN/SPS-05145-J2-1 (1q90iqo.PDF)

Keywords

ISDN, 3PTY, DSS1, supplementary service

ETSI

Postal address

F-06921 Sophia Antipolis Cedex - FRANCE

Office address

650 Route des Lucioles - Sophia Antipolis
Valbonne - FRANCE
Tel.: +33 4 92 94 42 00 Fax: +33 4 93 65 47 16
Siret N° 348 623 562 00017 - NAF 742 C
Association à but non lucratif enregistrée à la
Sous-Préfecture de Grasse (06) N° 7803/88

Internet

secretariat@etsi.fr
<http://www.etsi.fr>
<http://www.etsi.org>

Copyright Notification

No part may be reproduced except as authorized by written permission.
The copyright and the foregoing restriction extend to reproduction in all media.

© European Telecommunications Standards Institute 1998.
All rights reserved.

Contents

Intellectual Property Rights.....	5
Foreword.....	5
1 Scope	7
2 Normative references.....	7
3 Definitions	8
4 Abbreviations.....	9
5 Description	9
6 Operational requirements	10
6.1 Provision and withdrawal.....	10
6.2 Requirements on the originating network side.....	10
6.3 Requirements on the destination network side	10
7 Coding requirements.....	10
7.1 Coding of the Facility information element components.....	10
7.2 Coding of the Notification indicator information element	11
8 State definitions.....	11
9 Signalling procedures at the coincident S and T reference point	12
9.1 Activation, deactivation and registration	12
9.2 Invocation and operation.....	12
9.2.1 Request for a three-way conversation	12
9.2.1.1 Normal operation.....	12
9.2.1.2 Exceptional procedures	13
9.2.2 Disconnection of one remote user, and retention of the other	13
9.2.2.1 Normal operation.....	13
9.2.2.2 Exceptional procedures	15
9.2.3 Disconnection of both remote users, and terminating the call	15
9.2.3.1 Normal operation.....	15
9.2.3.2 Exceptional procedures	15
9.2.4 Creation of a private communication with a remote user.....	16
9.2.4.1 Normal operation.....	16
9.2.4.2 Exceptional procedures	17
9.2.5 Remote user terminates the call	18
9.2.5.1 Normal operation.....	18
9.2.5.2 Exceptional procedures	19

10	Procedures for interworking with private ISDNs	19
11	Interactions with other networks.....	19
12	Interactions with other supplementary services.....	19
13	Parameter values (timers).....	19
14	Dynamic description (SDL diagrams).....	19
Annex A (informative): Signalling flows		31
A.1	Request for a three-way conversation.....	31
A.2	Disconnection of one remote user, and retention of the other.....	32
A.3	Disconnection of both remote users and terminating the call	33
A.4	Creation of a private communication with a remote user.....	34
A.5	Remote user terminates the call	35
Annex B (informative): Changes with respect to the previous ETS 300 188-1		36
History		37

Intellectual Property Rights

IPRs essential or potentially essential to the present document may have been declared to ETSI. The information pertaining to these essential IPRs, if any, is publicly available for **ETSI members and non-members**, and can be found in SR 000 314: "*Intellectual Property Rights (IPRs); Essential, or potentially Essential, IPRs notified to ETSI in respect of ETSI standards*", which is available **free of charge** from the ETSI Secretariat. Latest updates are available on the ETSI Web server (<http://www.etsi.fr/ipr> or <http://www.etsi.org/ipr>).

Pursuant to the ETSI IPR Policy, no investigation, including IPR searches, has been carried out by ETSI. No guarantee can be given as to the existence of other IPRs not referenced in SR 000 314 (or the updates on the ETSI Web server) which are, or may be, or may become, essential to the present document.

Foreword

This European Standard (Telecommunications series) has been produced by ETSI Technical Committee Signalling Protocols and Switching (SPS).

The present document is part 1 of a multi-part standard covering the Digital Subscriber Signalling System No. one (DSS1) protocol specification for the Integrated Services Digital Network (ISDN) Three Party (3PTY) supplementary service, as described below:

- Part 1: "Protocol specification";**
- Part 2: "Protocol Implementation Conformance Statement (PICS) proforma specification";
- Part 3: "Test Suite Structure and Test Purposes (TSS&TP) specification for the user";
- Part 4: "Abstract Test Suite (ATS) and partial Protocol Implementation eXtra Information for Testing (PIXIT) proforma specification for the user";
- Part 5: "Test Suite Structure and Test Purposes (TSS&TP) specification for the network";
- Part 6: "Abstract Test Suite (ATS) and partial Protocol Implementation eXtra Information for Testing (PIXIT) proforma specification for the network".

In accordance with CCITT Recommendation I.130, the following three level structure is used to describe the supplementary telecommunications services as provided by European public telecommunications operators under the pan-European Integrated Services Digital Network (ISDN):

- Stage 1: is an overall service description, from the user's standpoint;
- Stage 2: identifies the functional capabilities and information flows needed to support the service described in stage 1; and,
- Stage 3: defines the signalling system protocols and switching functions needed to implement the service described in stage 1.

The present document details the stage 3 aspects (signalling system protocols and switching functions) needed to support the Three Party (3PTY) supplementary service. The stage 1 and stage 2 aspects are detailed in ETS 300 186 and ETS 300 187, respectively.

The present version updates the references to the basic call specifications and incorporates all previous amendments and corrigenda.

National transposition dates

Date of adoption of this EN:	19 June 1998
Date of latest announcement of this EN (doa):	30 September 1998
Date of latest publication of new National Standard or endorsement of this EN (dop/e):	31 March 1999
Date of withdrawal of any conflicting National Standard (dow):	31 March 1999

1 Scope

This first part of EN 300 188 specifies the stage three of the Three Party (3PTY) supplementary service for the pan-European Integrated Services Digital Network (ISDN) as provided by European public telecommunications operators at the T reference point or coincident S and T reference point (as defined in CCITT Recommendation I.411 [5]) by means of the Digital Subscriber Signalling System No. one (DSS1) protocol. Stage three identifies the protocol procedures and switching functions needed to support a telecommunications service (see CCITT Recommendation I.130 [3]).

In addition the present document specifies the protocol requirements at the T reference point where the service is provided to the user via a private ISDN.

The present document does not specify the additional protocol requirements where the service is provided to the user via a telecommunications network that is not an ISDN.

The 3PTY supplementary service enables a user to establish, participate in and control, a three-way conversation, i.e. a simultaneous communication involving the served user and two remote users.

The 3PTY supplementary service is applicable to all circuit-switched telecommunication services carrying speech.

Further parts of the present document specify the method of testing required to identify conformance to the present document.

The present document is applicable to equipment, supporting the 3PTY supplementary service, to be attached at either side of a T reference point or coincident S and T reference point when used as an access to the public ISDN.

2 Normative references

References may be made to:

- a) specific versions of publications (identified by date of publication, edition number, version number, etc.), in which case, subsequent revisions to the referenced document do not apply; or
- b) all versions up to and including the identified version (identified by "up to and including" before the version identity); or
- c) all versions subsequent to and including the identified version (identified by "onwards" following the version identity); or
- d) publications without mention of a specific version, in which case the latest version applies.

A non-specific reference to an ETS shall also be taken to refer to later versions published as an EN with the same number.

- | | |
|-----|--|
| [1] | CCITT Recommendation E.164: "Numbering plan for the ISDN era". |
| [2] | CCITT Recommendation I.112: "Vocabulary of terms for ISDNs". |
| [3] | CCITT Recommendation I.130 (1988): "Method for the characterisation of telecommunication services supported by an ISDN and network capabilities of an ISDN". |
| [4] | CCITT Recommendation I.210: "Principles of telecommunication services supported by an ISDN and the means to describe them". |
| [5] | CCITT Recommendation I.411 (1988): "ISDN user-network interfaces - Reference configurations". |
| [6] | CCITT Recommendation Q.9 (1988): "Vocabulary of switching and signalling terms". |
| [7] | CCITT Recommendation X.208 (1988): "Specification of Abstract Syntax Notation One (ASN.1)". |
| [8] | CCITT Recommendation X.209 (1988): "Specification of basic encoding rules for Abstract Syntax Notation One (ASN.1)". |

- [9] CCITT Recommendation X.219 (1988): "Remote operations: Model, notation and service definition".
- [10] CCITT Recommendation Z.100 (1988): "Functional Specification and Description Language (SDL)".
- [11] EN 300 403-1: "Integrated Services Digital Network (ISDN); Digital Subscriber Signalling System No. one (DSS1) protocol; Signalling network layer for circuit-mode basic call control; Part 1: Protocol specification [ITU-T Recommendation Q.931 (1993), modified]".
- [12] EN 300 403-2: "Integrated Services Digital Network (ISDN); Digital Subscriber Signalling System No. one (DSS1) protocol; Signalling network layer for circuit-mode basic call control; Part 2: Specification and Description Language (SDL) diagrams".
- [13] ETS 300 402-1: "Integrated Services Digital Network (ISDN); Digital Subscriber Signalling System No. one (DSS1) protocol; Data link layer; Part 1: General aspects".
- [14] EN 300 195-1: "Integrated Services Digital Network (ISDN); Supplementary service interactions; Digital Subscriber Signalling System No. one (DSS1) protocol; Part 1: Protocol specification".
- [15] EN 300 196-1: "Integrated Services Digital Network (ISDN); Generic functional protocol for the support of supplementary services; Digital Subscriber Signalling System No. one (DSS1) protocol; Part 1: Protocol specification".

3 Definitions

For the purposes of the present document, the following definitions apply:

active-held connection: A connection between two users where at the served user, the call state is Active, and the auxiliary state is Call Held.

active-idle connection: A connection between two users where at the served user, the call state is Active, and the auxiliary state is Idle.

call reference: See EN 300 196-1 [15], clause 3.

call state: A state as defined in EN 300 403-1 [11] subclause 2.1 for either the user side or the network side as appropriate. A call state may exist for each call reference value (and for each additional responding Connection Endpoint Identifier (CEI) in the incoming call state).

call: See CCITT Recommendation Q.9 [6], definition 2201.

connection endpoint identifier: The identifier that identifies the data link connection which is used to transfer the signalling information (for the complete definition see EN 300 402-1 [13], subclause 3.4.1).

connection: See CCITT Recommendation Q.9 [6], definition 0011.

Integrated Services Digital Network (ISDN): See CCITT Recommendation I.112 [2], definition 308.

invoke component: See EN 300 196-1 [15], subclause 8.2.2.1. Where reference is made to "xxxx" invoke component, an invoke component is meant with its operation value set to the value of the operation "xxxx".

ISDN number: A number conforming to the numbering plan and structure specified in CCITT Recommendation E.164 [1].

network: The DSS1 protocol entity at the network side of the user-network interface.

private communication: Communication between the served user and one remote user. This excludes communication with the other remote user.

reject component: See EN 300 196-1 [15], subclause 8.2.2.4.

remote user: The two other users to the served user which are involved in the two calls that are joined together in a three-way conversation. The remote users are distinguished as user B and user C.

return error component: See EN 300 196-1 [15], subclause 8.2.2.3. Where reference is made to "xxxx" return error component, a return error component is meant which is related to an "xxxx" invoke component.

return result component: See EN 300 196-1 [15], subclause 8.2.2.2. Where reference is made to "xxxx" return result component, a return result component is meant which is related to an "xxxx" invoke component.

served user: The user (DSS1 protocol entity) which invokes this supplementary service; this user is also referred to as user A.

service; telecommunications service: See CCITT Recommendation I.112 [2], definition 201.

supplementary service: See CCITT Recommendation I.210 [4], § 2.4.

three-way bridge: The network equipment which performs connections between three users to allow three-way conversation.

three-way conversation: Communication between all three users, i.e. the served user and both remote users.

user: The DSS1 protocol entity at the user side of the user-network interface.

4 Abbreviations

For the purposes of the present document, the following abbreviations apply:

3PTY	Three Party
ASN.1	Abstract Syntax Notation one
CEI	Connection Endpoint Identifier
CR	Call Reference
DSS1	Digital Subscriber Signalling System No. one
ISDN	Integrated Services Digital Network
PSTN	Public Switched Telephone Network
SDL	Specification and Description Language

5 Description

The served user, which has only one Active-Idle connection, and at least one Active-Held connection can join the Active-Idle connection with one of the Active-Held connections, to form a three-way conversation.

NOTE 1: Each call, to be involved in the 3PTY supplementary service, can have been originated by either the served user, or by the appropriate remote user.

During the three-way conversation the served user can request that the network:

- explicitly disconnects one of the remote users, and the connection to that remote user;
- terminates the three-way conversation; or
- creates a private communication with one of the remote users.

Either of the remote users (user B or user C) can request that the network disconnects the connection.

Remote users are notified of these actions.

NOTE 2: During an interim period of time, some networks may not support the transfer of the notification to the remote users.

NOTE 3: The protocol for implementation of the 3PTY supplementary service is restricted to implementations where only one call within an Active-Idle connection exists for that CEI value. User implementations, e.g. multifunctional terminals, that in a normal operation support more than one call with an Active-Idle connection on the same CEI value, cannot make effective use of this protocol.

6 Operational requirements

6.1 Provision and withdrawal

The 3PTY supplementary service shall be provided by prior arrangement with the service provider.

The 3PTY supplementary service shall be withdrawn by the service provider upon request of the subscriber or for service provider reasons.

6.2 Requirements on the originating network side

The requirements of EN 300 403-1 [11], subclause 5.1 shall apply.

6.3 Requirements on the destination network side

The requirements of EN 300 403-1 [11], subclause 5.2 shall apply.

7 Coding requirements

7.1 Coding of the Facility information element components

Table 1 shows the definition of the operations and types required for the 3PTY supplementary service using ASN.1 as defined in CCITT Recommendations X.208 [7] and X.209 [8], and using the OPERATION macro as defined in CCITT Recommendation X.219 [9], figure 4/X.219.

The formal definition of the component types to encode these operations and types is provided in EN 300 196-1 [15], clause D.1.

The inclusion of components in Facility information elements is defined in EN 300 196-1 [15], subclause 11.2.2.1.

Table 1: Definition of operations for the 3PTY supplementary service

```

Three-Party-Operations {ccitt identified-organization etsi (0) 188 operations-and-types (1)}
DEFINITIONS EXPLICIT TAGS ::=
BEGIN
EXPORTS
    Begin3PTY, End3PTY;
IMPORTS
    OPERATION
    FROM Remote-Operation-Notation
        {joint-iso-ccitt remote-operations (4) notation (0)}

    notSubscribed, notAvailable, invalidCallState,
    resourceUnavailable,
    supplementaryServiceInteractionNotAllowed
    FROM General-Errors
        {ccitt identified-organization etsi (0) 196 general-errors (2)};

Begin3PTY      ::= OPERATION
                RESULT
                ERRORS {notSubscribed, notAvailable, invalidCallState,
                resourceUnavailable,
                supplementaryServiceInteractionNotAllowed}

```

Table 1 (concluded): Definition of operations for the 3PTY supplementary service

```

-- The present document does not provide procedures for the generation of the error
"notAvailable"

```

End3PTY	:: =	OPERATION RESULT ERRORS {invalidCallState}
begin3PTY		Begin3PTY :: = 4
end3PTY		End3PTY :: = 5
END		

All components (invoke, return result, return error and reject) shall be included within a Facility information element. The Facility information element shall be included in the message as specified in clause 9.

7.2 Coding of the Notification indicator information element

The notification description is contained in octet 3 of the Notification indicator information element and shall be coded as shown in table 2.

NOTE: The following guidance is given for the interpretation of the notification descriptions at a remote user. A notification description of "Remote hold" indicates a loss of communication path in the B-channel. When three-way conversation exists, this may be due to termination of the three-way conversation, which will be indicated by a subsequent notification description of "Conference disconnected", or due to operation of some supplementary services, e.g. the call hold supplementary service. When the notification description of "Conference disconnected" is received, a communication path exists in the B-channel, unless the notification description is accompanied by, or immediately followed by, a notification description of "Remote hold", which indicates a loss of communication path in the B-channel.

Table 2: Codepoints in the Notification indicator information element

Bits	
8 7 6 5 4 3 2 1	
1 1 0 0 0 0 1 0	Conference established (note 1)
1 1 0 0 0 0 1 1	Conference disconnected (note 2)
1 1 1 1 1 0 0 1	Remote hold
NOTE 1:	The user takes part in a multiparty call.
NOTE 2:	The user takes part in a normal two-party call.

8 State definitions

The call states as specified in EN 300 403-1 [11], subclause 2.1 shall apply.

The auxiliary states as specified in EN 300 196-1 [15], subclause 7.1.2 shall apply.

The following states are defined for the network:

- **3PTY Idle:** an occurrence of the 3PTY supplementary service has not been requested;
- **3PTY Active:** an occurrence of the 3PTY supplementary service exists;
- **3PTY Await Retrieve:** a Retrieve function should be initiated by the user prior to ending of the 3PTY supplementary service;
- **3PTY Await Hold And Retrieve:** a Hold function and a Retrieve function should be initiated by the user prior to ending of the 3PTY supplementary service;
- **3PTY Await Hold:** a Hold function should be initiated by the user prior to ending of the 3PTY supplementary service.

The following states are defined for the user:

- **3PTY Idle:** an occurrence of the 3PTY supplementary service has not been requested;
- **3PTY Active:** an occurrence of the 3PTY supplementary service exists;
- **Begin3PTY Request:** the 3PTY supplementary service has been requested by the served user;
- **End3PTY Request:** the served user wants to have a private conversation with one of the remote users.

9 Signalling procedures at the coincident S and T reference point

9.1 Activation, deactivation and registration

Not applicable, i.e. no signalling procedures are required for the activation, deactivation and registration of the 3PTY supplementary service.

9.2 Invocation and operation

9.2.1 Request for a three-way conversation

9.2.1.1 Normal operation

In order to request the 3PTY supplementary service, the served user requires two calls each related to the same CEI value, one with each of the remote users. One call shall have an Active-Idle connection. The other call shall have an Active-Held connection. The served user shall have no other calls with Active-Idle connections related to the same CEI value. Other calls with Active-Held connections may exist.

To request the 3PTY supplementary service, the served user shall send to the network a Begin3PTY invoke component according to the procedures of EN 300 196-1 [15], subclause 8.3.1.1, within a FACILITY message, and using the Call Reference (CR) of the appropriate Active-Held connection.

NOTE: The other CR is implicitly identified by the constraint that it is the only Active-Idle connection.

On receiving this request, the network shall check whether:

- the 3PTY supplementary service is allowed to this user;
- the received request relates to an Active-Held connection;
- for the CEI value on which the request is received, a single Active-Idle connection exists;
- that a three-way bridge is available for use;
- no three-way bridge that is controlled by the served user is already included in the Active-Idle connection or in the Active-Held connection; and
- the requirements of EN 300 195-1 [14] are met for the other supplementary service interactions.

If these requirements are met, the network shall:

- a) allocate a three-way bridge;
- b) attach the identified connections to this three-way bridge using the B-channel of the Active-Idle connection to support user information transfer with the served user;
- c) return to the served user a Begin3PTY return result component according to the procedures of EN 300 196-1 [15], subclause 8.3.1.1, within a FACILITY message, and using the CR of the appropriate Active-Held connection; and

- d) send a NOTIFY message to the remote users containing a Notification indicator information element with a notification description of "Conference established".

When the served user receives a correctly encoded Begin3PTY return result component, within a FACILITY message, the user shall accept the provided information and shall not respond to the network.

As a result of the procedures of this subclause, the call states and the auxiliary states of the two connections, at both the network and the user, are unchanged.

9.2.1.2 Exceptional procedures

On receiving a Begin3PTY invoke component, within a FACILITY message, according to the procedures of EN 300 196-1 [15], subclause 8.3.1.1, but three-way conversation is not allowed, the network shall return to the served user a Begin3PTY return error component, according to the procedures of EN 300 196-1 [15], subclause 8.3.1.1, within a FACILITY message, or in any other appropriate call control message, and using the CR of the connection on which the message has been received, and take no action on any connections for that user.

The error included in the Begin3PTY return error component shall be one of the following:

- "notSubscribed", if the 3PTY service has not been subscribed;
- "invalidCallState", if the received request does not relate to an Active-Held connection, or no Active-Idle connection exists for that CEI value, or more than one Active-Idle connection exists for that CEI value;
- "resourceUnavailable", if a three-way bridge is not available for use;
- "supplementaryServiceInteractionNotAllowed", if a three-way bridge already exists in one or both of the identified connections, and the three-way bridge relates to the same served user, or if the provision of the service is precluded by a procedure within EN 300 195-1 [14].

The served user, on receiving a Begin3PTY return error component, shall take no action, and remain in the state that existed before the Begin3PTY invoke component was sent.

If the network receives a Begin3PTY invoke component in a message other than a FACILITY message then the network shall return a Begin3PTY return error component according to the procedures of EN 300 196-1 [15], subclause 8.3.1.1. The error included in the Begin3PTY return error component shall be "invalidCallState". The Begin3PTY return error component shall be returned to the served user by the appropriate call control message or call hold and retrieve family of messages as specified in EN 300 196-1 [15], clause 7, or a FACILITY message.

The served user, on receiving a reject component, shall take no action, and remain in the state that existed before the Begin3PTY invoke component was sent.

The network, on receiving a reject component, shall take no action, and remain in the state that existed before the reject component was received.

Once the network decides that the 3PTY supplementary service has been successfully invoked, up until the time that the network decides that the three-way conversation is ended, the following procedures apply. If the network receives a RETRIEVE message for the Active-Held connection, then the Retrieve function shall be rejected according to the procedures of EN 300 196-1 [15] with cause #29 "Facility rejected".

9.2.2 Disconnection of one remote user, and retention of the other

9.2.2.1 Normal operation

The remote user to be disconnected is identified at the served user by the CR relating to either the Active-Held connection, or to the Active-Idle connection. Depending on which applies, one of the two following procedures shall be followed:

- a) If the remote user to be disconnected is identified at the served user by a CR relating to the Active-Idle connection, the served user shall send a DISCONNECT message with that CR, in accordance with the procedures of EN 300 403-1 [11], subclause 5.3.

On receiving such a DISCONNECT message, the network shall:

- i) clear the connection to the appropriate remote user;

NOTE 1: The receipt of clearing information at this remote user indicates the end of three-way conversation.

- ii) continue clearing the identified CR to the served user in accordance with the procedures of EN 300 403-1 [11], subclause 5.3. The network shall provide any appropriate reservation function as defined in EN 300 196-1 [15], subclause 10.1, in association with this clearing;
- iii) remove the three-way bridge from the Active-Held connection to the other remote user;
- iv) release the three-way bridge; and,
- v) send a NOTIFY message to the remaining remote user containing a Notification indicator information element with a notification description of "Remote hold".

On receiving the RELEASE message, as provided by the procedures of EN 300 403-1 [11], subclause 5.3, the served user shall:

- i) continue to clear the CR on which clearing was initiated in accordance with the procedures of subclause 5.3 of EN 300 403-1 [11]; and,
- ii) use the CR relating to the Active-Held connection, perform the Retrieve function in accordance with the procedures of EN 300 196-1 [15], subclause 7.4.

NOTE 2: The served user may need to allow for completion of clearing of the CR on which clearing was initiated before performing the Retrieve function in order to ensure success of channel selection during the Retrieve function.

On receiving a RETRIEVE message indicating a request for the Retrieve function, the network shall:

- i) complete the Retrieve function (according to the procedures of subclause 7.4 of EN 300 196-1 [15]), using any appropriate reservation (according to the procedures of subclause 10.1 of EN 300 196-1 [15]);

NOTE 3: A Notification indicator information element with a notification description of "Remote retrieval" is not sent to the remote user under these circumstances.

- ii) send a NOTIFY message to the remaining remote user containing a Notification indicator information element with a notification description of "Conference disconnected".

As a result of the procedures of this item of this subclause, the call state of the remaining connection, at both the network and the served user, is unchanged. The auxiliary state is Idle.

- b) If the remote user to be disconnected is identified at the served user by a CR relating to the Active-Held connection, the served user shall send a DISCONNECT message with that CR, in accordance with the procedures of EN 300 403-1 [11], subclause 5.3.

On receiving such a DISCONNECT message, the network shall:

- i) clear the connection to the appropriate remote user;

NOTE 4: The receipt of clearing information at this remote user indicates the end of three-way conversation.

- ii) continue clearing the identified CR to the served user in accordance with the procedures of EN 300 403-1 [11], subclause 5.3;
- iii) remove the three-way bridge from the Active-Idle connection to the other remote user;
- iv) release the three-way bridge; and,
- v) send a NOTIFY message to the remaining remote user containing a Notification indicator information element with a notification description of "Conference disconnected".

As a result of the procedures of this item of this subclause, the call state and the auxiliary state of the remaining connection, at both the network and the served user, are unchanged.

9.2.2.2 Exceptional procedures

All exceptional conditions shall be treated according to the procedures of EN 300 403-1 [11], subclause 5.8.

9.2.3 Disconnection of both remote users, and terminating the call

9.2.3.1 Normal operation

The served user shall send a DISCONNECT message on both:

- the CR relating to the Active-Held connection. Subsequent procedures shall be according to subclause 9.2.2.1 item b);
- the CR relating to the Active-Idle connection. Subsequent procedures shall be according to subclause 9.2.2.1 item a) except that the served user shall not perform the Retrieve function.

The network shall create the notification towards the remaining remote user only on disconnection of the first remote user.

NOTE: Any notification description received at a remote user immediately prior to a clearing indication is cancelled by that clearing indicator and can be ignored.

9.2.3.2 Exceptional procedures

All exceptional conditions shall be treated according to the procedures of EN 300 403-1 [11], subclause 5.8.

9.2.4 Creation of a private communication with a remote user

9.2.4.1 Normal operation

The remote user, for which a private communication is required, is identified at the served user by a CR relating to either the Active-Held connection, or to the Active-Idle connection. Depending on which applies, one of the two following procedures shall be followed:

- a) If the remote user, for which a private communication is required, is identified at the served user by a CR relating to the Active-Held connection, the served user shall send an End3PTY invoke component to the network in a FACILITY message with that CR, in accordance with the procedures of EN 300 196-1 [15], subclause 8.3.1.1.

On receiving such an invoke component in a FACILITY message, the network shall:

- i) remove the three-way bridge from both the Active-Idle connection and the Active-Held connection;
- ii) release the three-way bridge;
- iii) return to the served user an End3PTY return result component, within a FACILITY message, according to the procedures of EN 300 196-1 [15], subclause 8.3.1.1, and using the CR of the Active-Held connection;
- iv) send a NOTIFY message to the remote user with which private communication is required containing a Notification indicator information element with a notification description of "Remote hold"; and,
- v) send a NOTIFY message to the other remote user containing a Notification indicator information element with a notification description of "Conference disconnected".

When the served user receives a correctly encoded End3PTY return result component, within a FACILITY message, the user shall accept the provided information and shall:

- i) use the CR relating to the Active-Idle connection, perform the Hold function in accordance with the procedures of EN 300 196-1 [15], subclause 7.2;
- ii) use the CR relating to the Active-Held connection, perform the Retrieve function in accordance with the procedures of EN 300 196-1 [15], subclause 7.4.

NOTE 1: If the network processes the RETRIEVE message before the HOLD message (e.g. the user sends a RETRIEVE message before the Hold function is completed, or due to internal message handling in the network), the successful outcome of the Retrieve function will depend on the availability of a free B-channel. In case a free B-channel is not available, the network cannot successfully complete the Retrieve function. In order to ensure success of channel selection during the Retrieve function, unless the user knows that a free B-channel is available, the user should wait for completion of the Hold function before performing the Retrieve function.

The network shall complete the Hold and Retrieve functions (according to the procedures of subclauses 7.2 and 7.4 of EN 300 196-1 [15]), creating and using any appropriate reservation (according to the procedures of subclause 10.1 of EN 300 196-1 [15]). On successful completion of the Hold function (i.e. the HOLD ACKNOWLEDGE message is sent) the network shall send a NOTIFY message, to the remote user that is not to be included in the private communication, containing a Notification indicator information element with a notification description of "Remote hold". On successful completion of the Retrieve function (i.e. RETRIEVE ACKNOWLEDGE message is sent) the network shall send a NOTIFY message, to the remote user for whom private communication is desired, containing a Notification indicator information element with a notification description of "Conference disconnected".

NOTE 2: A Notification indicator information element with a notification description of "Remote retrieval" is not sent to the remote user under these circumstances.

As a result of the procedures of this item of this subclause, the call state of the connections, at both the network and the served user, is unchanged. The auxiliary state of the connection of the private communication changes from Call Held to Idle. The auxiliary state of the other connection changes from Idle to Call Held.

- b) If the remote user, for which a private communication is required, is identified at the served user by the CR relating to the Active-Idle connection, the served user shall send an End3PTY invoke component to the network in a FACILITY message with that CR, in accordance with the procedures of EN 300 196-1 [15], subclause 8.3.1.1.

On receiving such an invoke component in a FACILITY message, the network shall:

- i) remove the three-way bridge from both the Active-Idle connection and the Active-Held connection;
- ii) release the three-way bridge;
- iii) return to the served user an End3PTY return result component, within a FACILITY message, according to the procedures of EN 300 196-1 [15], subclause 8.3.1.1, and using the CR of the Active-Idle connection;
- iv) send a NOTIFY message to both remote users containing a Notification indicator information element with a notification description of "Conference disconnected"; and,
- v) send to the remote user for which private communication is not required, either in the same NOTIFY message as (iv), or in a subsequent NOTIFY message, a Notification indicator information element with a notification description of "Remote hold".

NOTE 3: If any intervening protocol between the network of the served user and the network of the remote user does not support transmission of two notification descriptions in the same message, then this should be mapped at that point to a message containing a single notification description of "Conference disconnected", and a subsequent message containing a notification description of "Remote hold".

When the served user receives a correctly encoded End3PTY return result component, within a FACILITY message, the user shall accept the provided information and take no further action.

As a result of the procedures of this item of this subclause, the call state and the auxiliary state of the connections, at both the network and the served user, are unchanged.

9.2.4.2 Exceptional procedures

On receiving an End3PTY invoke component, within a FACILITY message, according to the procedures of EN 300 196-1 [15], subclause 8.3.1.1, but no three-way conversation exists, the network shall return to the served user an End3PTY return error component, according to the procedures of EN 300 196-1 [15], subclause 8.3.1.1, in any appropriate message and using the CR on which the message has been received.

On receiving an End3PTY invoke component, within a message other than a FACILITY message, according to the procedures of EN 300 196-1 [15], subclause 8.3.1.1, but no three-way conversation exists, the network shall return to the served user an End3PTY return error component, according to the procedures of EN 300 196-1 [15], subclause 8.3.1.1, in any appropriate message and using the CR on which the message has been received.

On receiving an End3PTY invoke component, within a message other than a FACILITY message, according to the procedures of EN 300 196-1 [15], subclause 8.3.1.1, and a three-way conversation exists, the network shall return to the served user an End3PTY return error component, according to the procedures of EN 300 196-1 [15], subclause 8.3.1.1, in any appropriate message and using the CR on which the message has been received.

The error included in the End3PTY return error component shall be "invalidCallState".

The served user, on receiving an End3PTY return error component, shall take no action, and remain in the state that existed before the End3PTY invoke component was sent.

The served user, on receiving a reject component, shall take no action, and remain in the state that existed before the End3PTY invoke component was sent.

The network, on receiving a reject component, shall take no action, and remain in the state that existed before the reject component was received.

9.2.5 Remote user terminates the call

9.2.5.1 Normal operation

The remote user to be disconnected is identified at the served user by a CR relating to either an Active-Held connection, or to an Active-Idle connection. Depending on which applies, one of the two following procedures shall be followed:

- a) If a remote user (or remote network), identified at the served user by a CR relating to the Active-Idle connection, clears the connection according to the procedures of EN 300 403-1 [11], subclause 5.3, then the network shall:
 - i) send a DISCONNECT message with that CR to the served user, in accordance with the procedures of EN 300 403-1 [11], subclause 5.3;
 - ii) remove the three-way bridge from the Active-Held connection to the other remote user;
 - iii) release the three-way bridge; and,
 - iv) send a NOTIFY message to the remaining remote user containing a Notification indicator information element with a notification description of "Remote hold".

On receiving the DISCONNECT message, as provided by the procedures of EN 300 403-1 [11], subclause 5.3, the served user shall:

- i) continue to clear the CR on which clearing was initiated in accordance with the procedures of subclause 5.3 of EN 300 403-1 [11]; and,
- ii) use the CR relating to the Active-Held connection, perform the Retrieve function in accordance with the procedures of EN 300 196-1 [15], subclause 7.4.

NOTE 1: The served user may need to allow for completion of clearing of the CR on which clearing was initiated before performing the Retrieve function in order to ensure success of channel selection during the Retrieve function.

On receiving a RETRIEVE message indicating a request for the RETRIEVE function, the network shall:

- i) complete the Retrieve function (according to the procedures of subclause 7.4. of EN 300 196-1 [15]), using any appropriate reservation (according to the procedures of subclause 10.1 of EN 300 196-1 [15]);

NOTE 2: A Notification indicator information element with a notification description of "Remote retrieval" is not sent to the remote user under these circumstances.

- ii) send a NOTIFY message to the remaining remote user containing a Notification indicator information element with a notification element description of "Conference disconnected".

As a result of the procedures of this item of this subclause, the call state of the remaining connection, at both the network and the served user, is unchanged. The auxiliary state is Idle.

- b) If a remote user (or remote network), identified at the served user by a CR relating to an Active-Held connection, clears the connection according to the procedures of EN 300 403-1 [11], subclause 5.3, then the network shall:
 - i) send a DISCONNECT message with that CR to the served user, in accordance with the procedures of EN 300 403-1 [11], subclause 5.3;
 - ii) remove the three-way bridge from the Active-Idle connection to the other remote user;
 - iii) release the three-way bridge; and,
 - iv) send a NOTIFY message to the remaining remote user containing a Notification indicator information element with a notification description of "Conference disconnected".

As a result of the procedures of this item of this subclause, the call state and the auxiliary state of the remaining connection, at both the network and the served user, are unchanged.

9.2.5.2 Exceptional procedures

All exceptional conditions shall be treated according to the procedures of EN 300 403-1 [11], subclause 5.8.

10 Procedures for interworking with private ISDNs

Notifications from a private ISDN shall be transferred through the public ISDN, if the service provider resides in a private ISDN.

If the remote user resides in a private ISDN, then the public network shall send the notifications according to the procedures of subclause 9.2.

Other procedures for the coincident S and T reference point do not apply at the T reference point i.e. procedures for the control of a three-way bridge in the network (DSS1 protocol entity) of a public ISDN when the served user (DSS1 protocol entity) is a private ISDN are outside the scope of the present document.

11 Interactions with other networks

Remote users in a Public Switched Telecommunication Network (PSTN) need not receive notifications.

12 Interactions with other supplementary services

The interaction with other supplementary services shall be as specified in EN 300 195-1 [14].

13 Parameter values (timers)

No timers are defined.

14 Dynamic description (SDL diagrams)

The dynamic descriptions are specified in figures 1 and 2. Figures 1 and 2 are specified according to CCITT Recommendation Z.100 [10]; figure 1 shows the user of the 3PTY supplementary service and figure 2 shows the network.

The Specification and Description Language (SDL) diagrams for the notification procedure of the remote users are according to EN 300 403-2 [12].

Process 3PTY_User

SE0188_F1.1(4)

Two basic connections are involved in the 3PTY supplementary service:
- one Active-Held connection; and
- one Active-Idle connection.

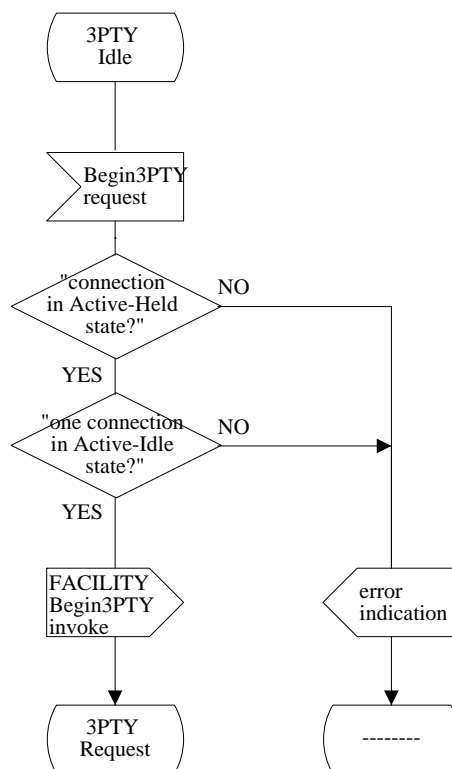

Figure 1 (sheet 1 of 4): SDL diagrams for user

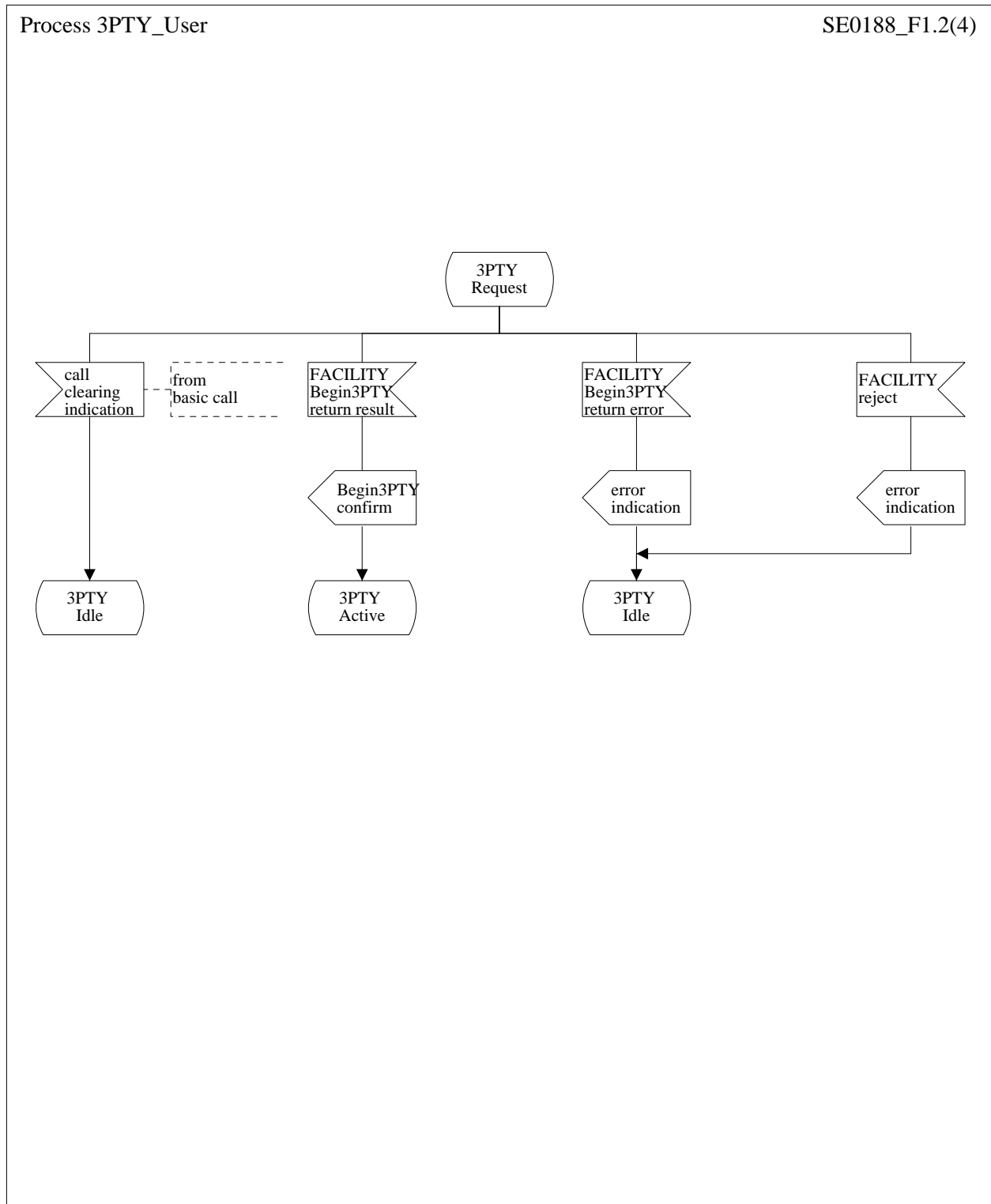

Figure 1 (sheet 2 of 4): SDL diagrams for user

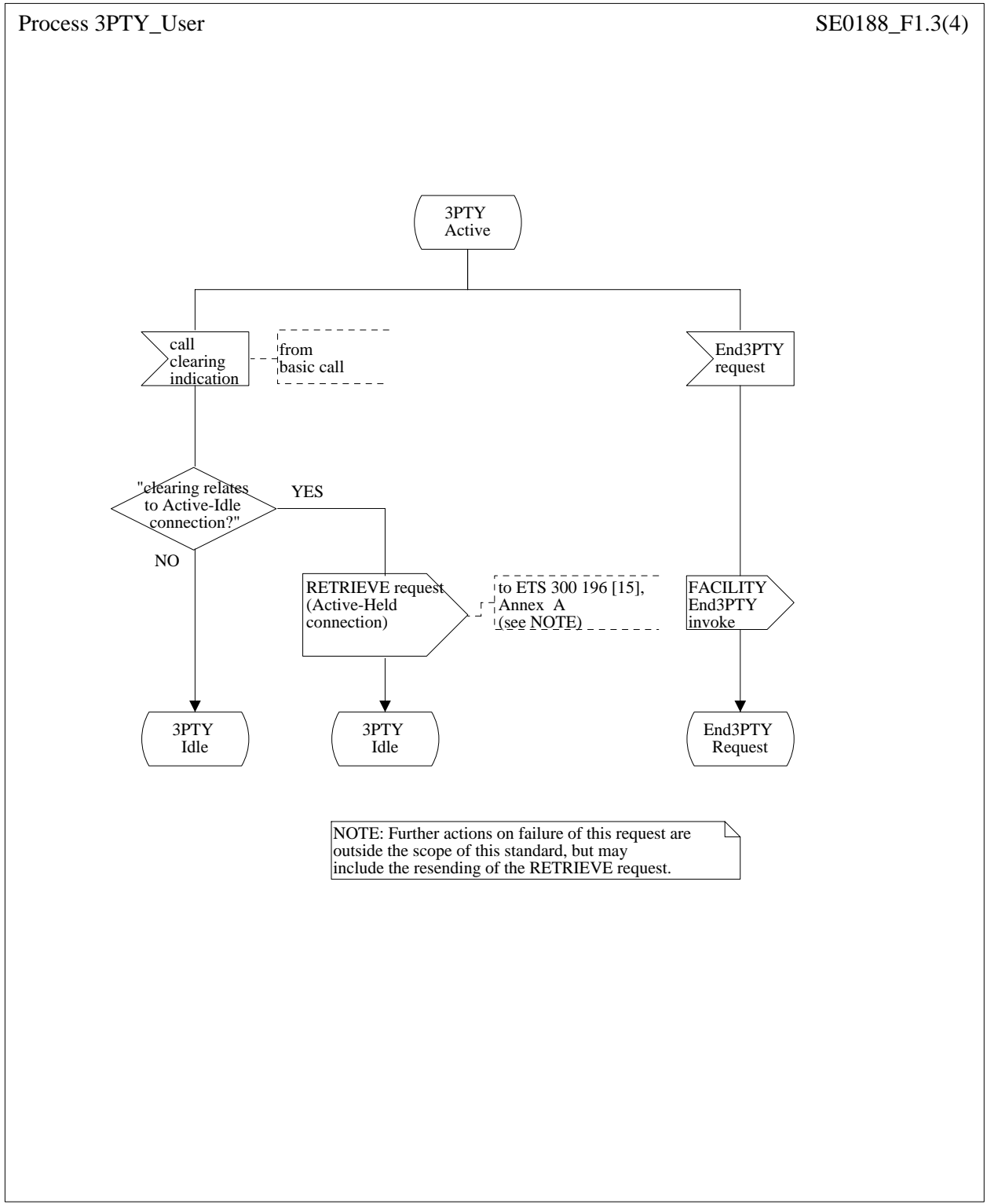

Figure 1 (sheet 3 of 4): SDL diagrams for user

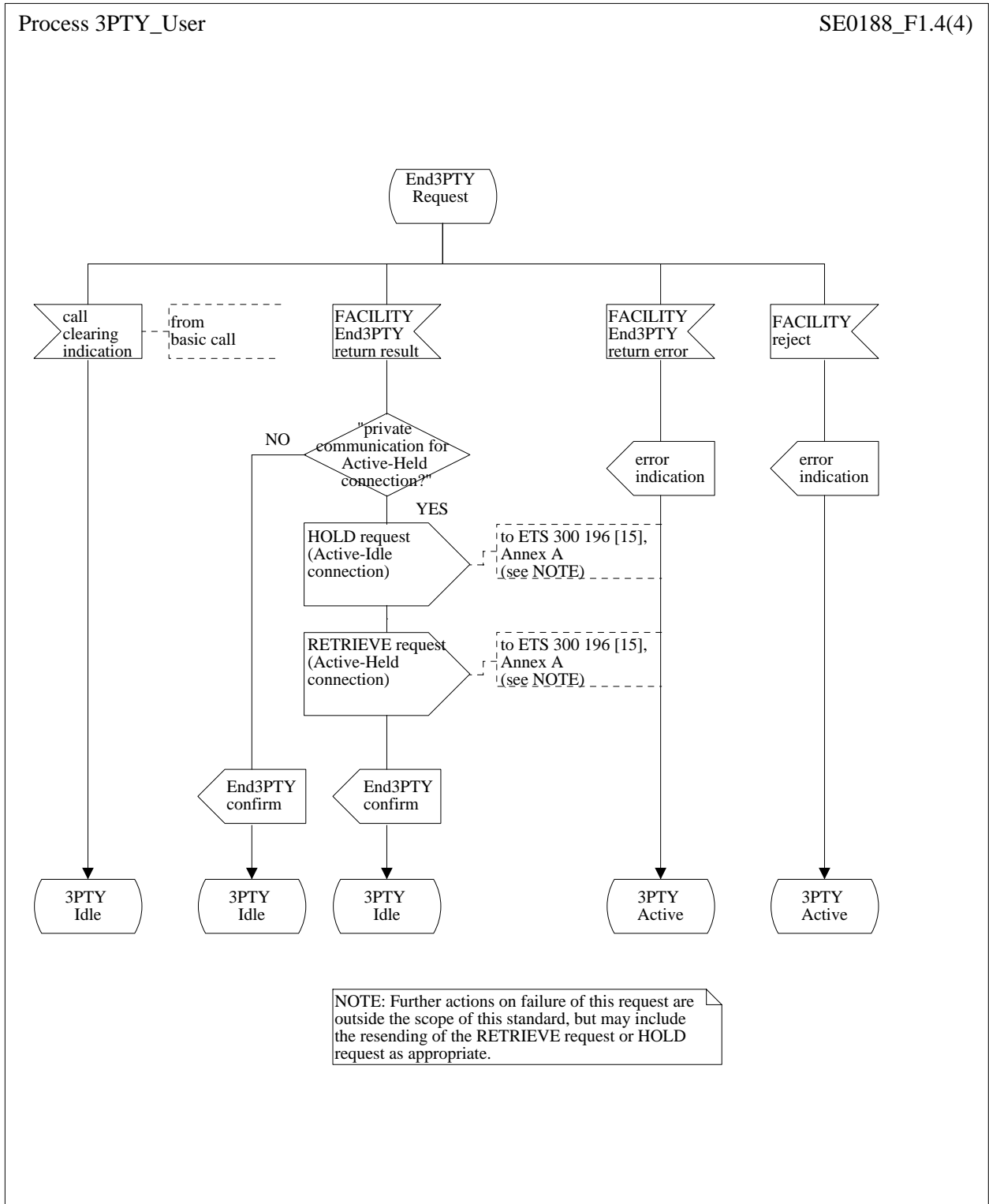

Figure 1 (sheet 4 of 4): SDL diagrams for user

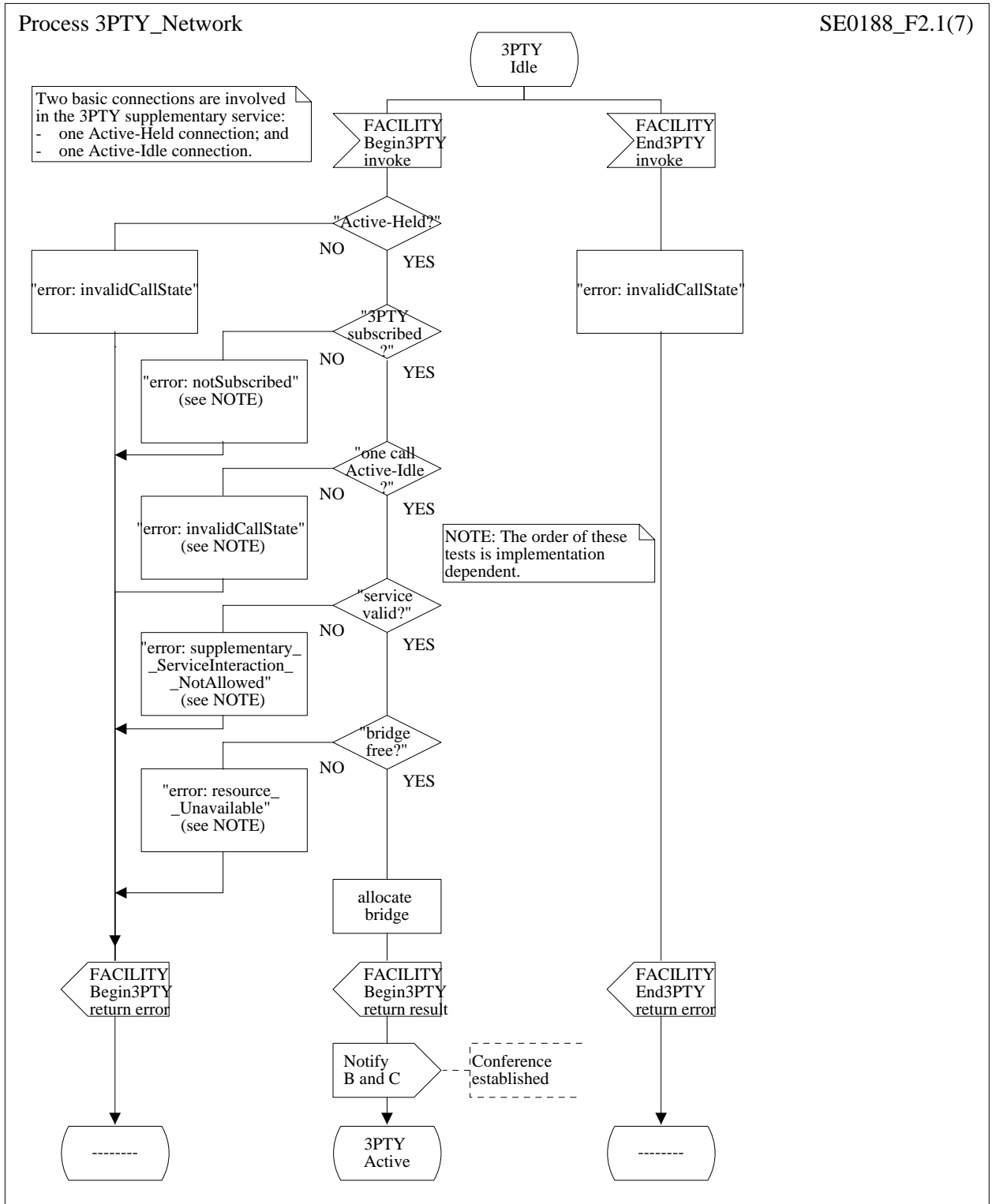

Figure 2 (sheet 1 of 7): SDL diagrams for Network

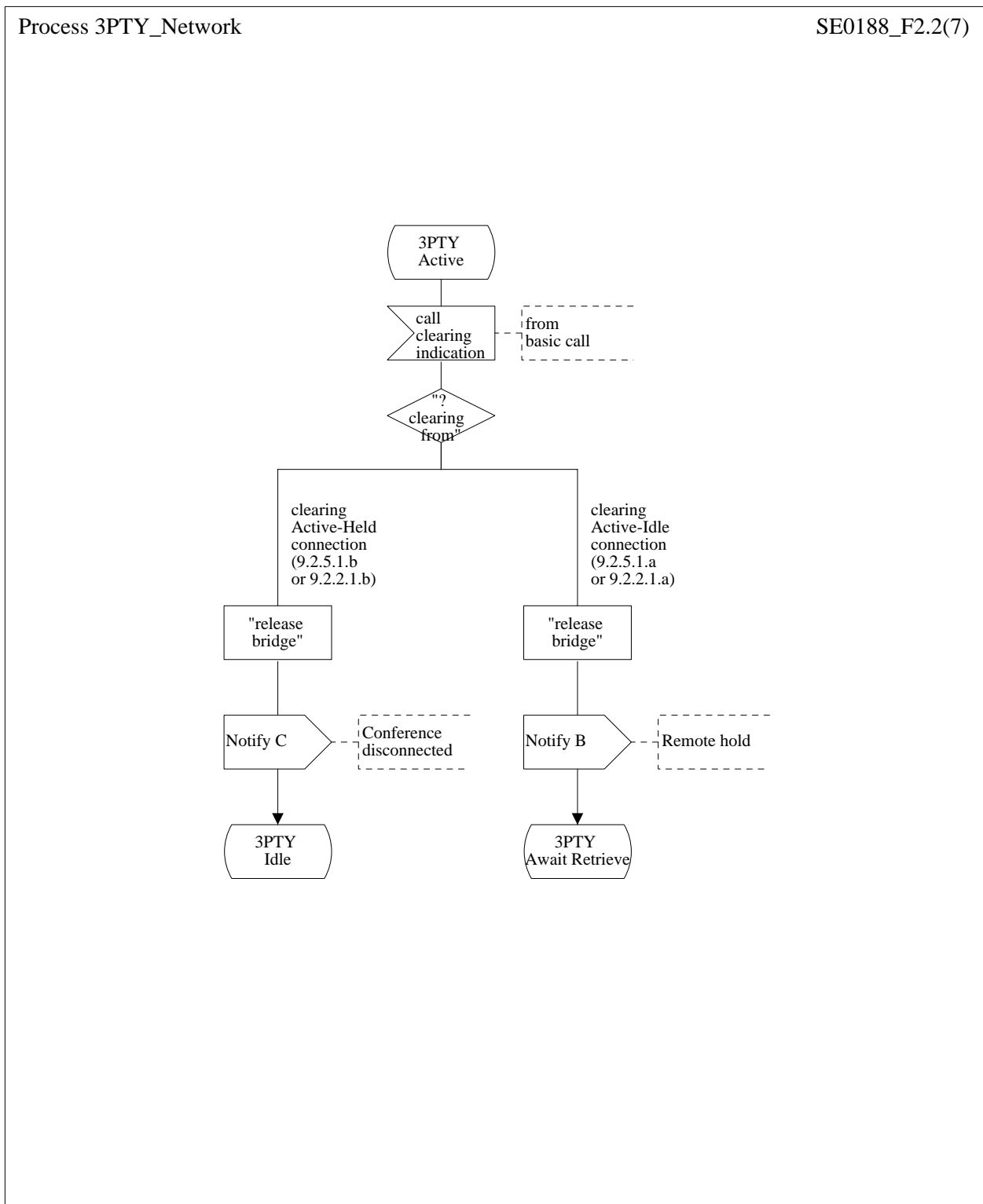

Figure 2 (sheet 2 of 7): SDL diagrams for network

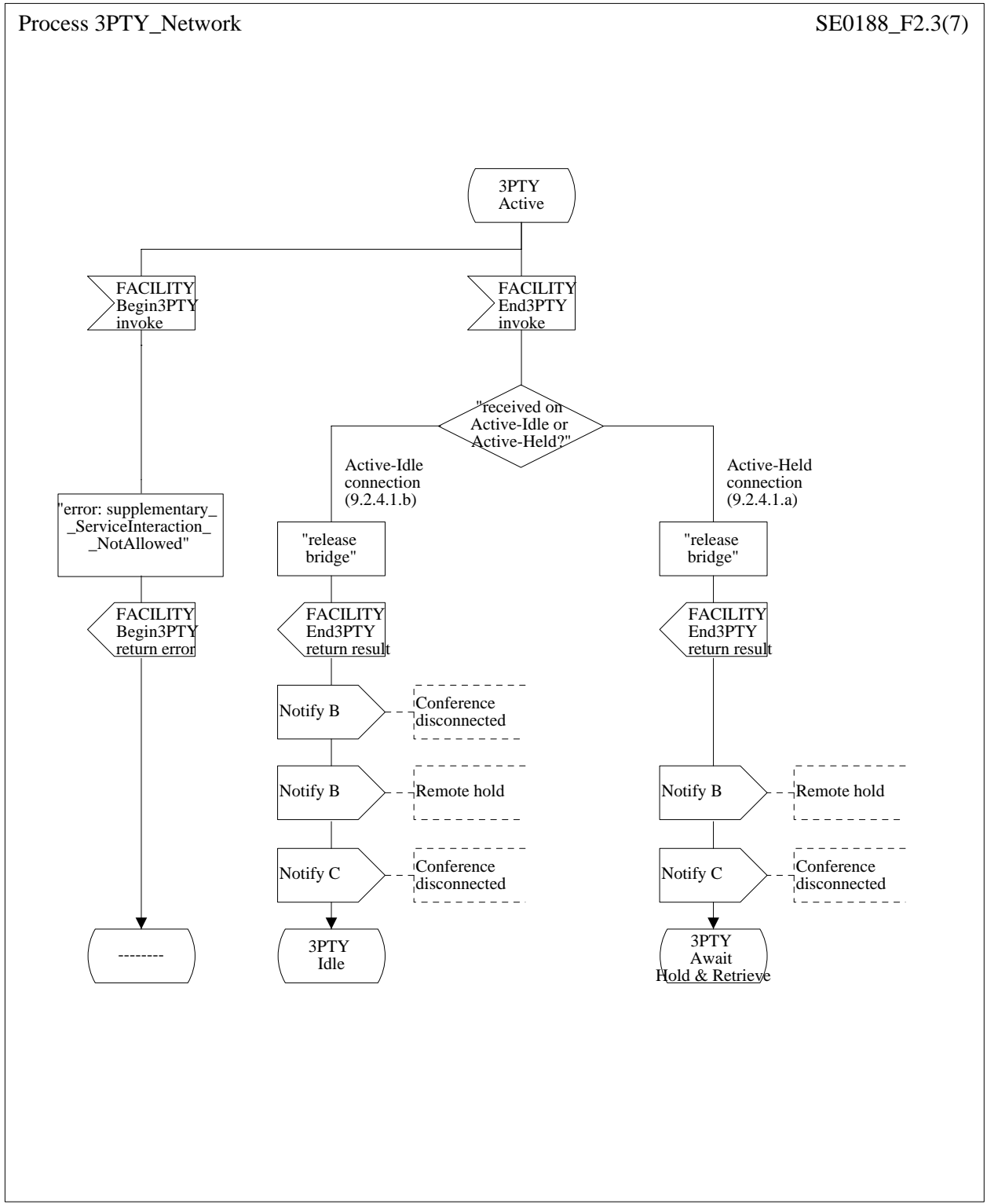

Figure 2 (sheet 3 of 7): SDL diagrams for network

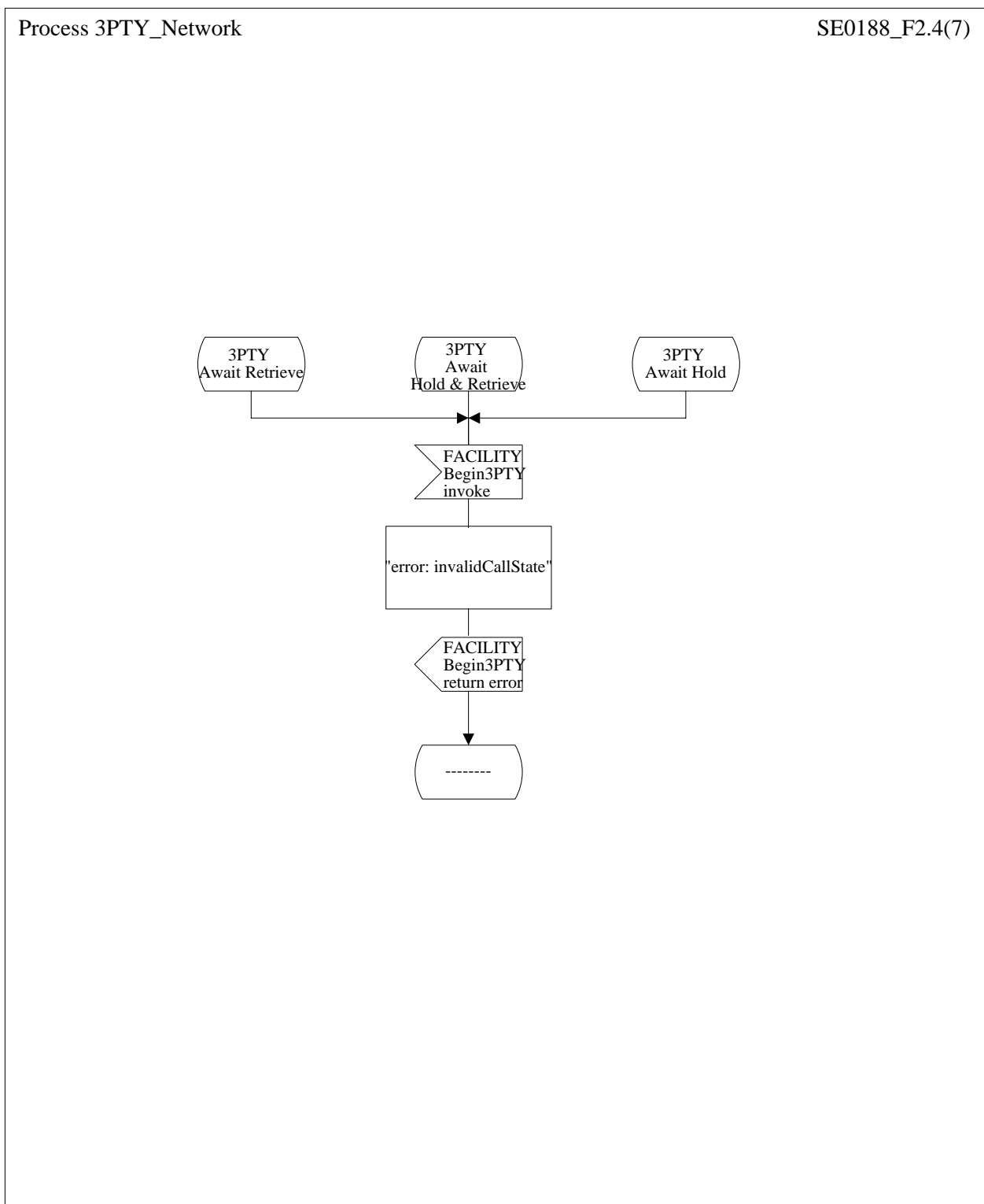

Figure 2 (sheet 4 of 7): SDL diagrams for network

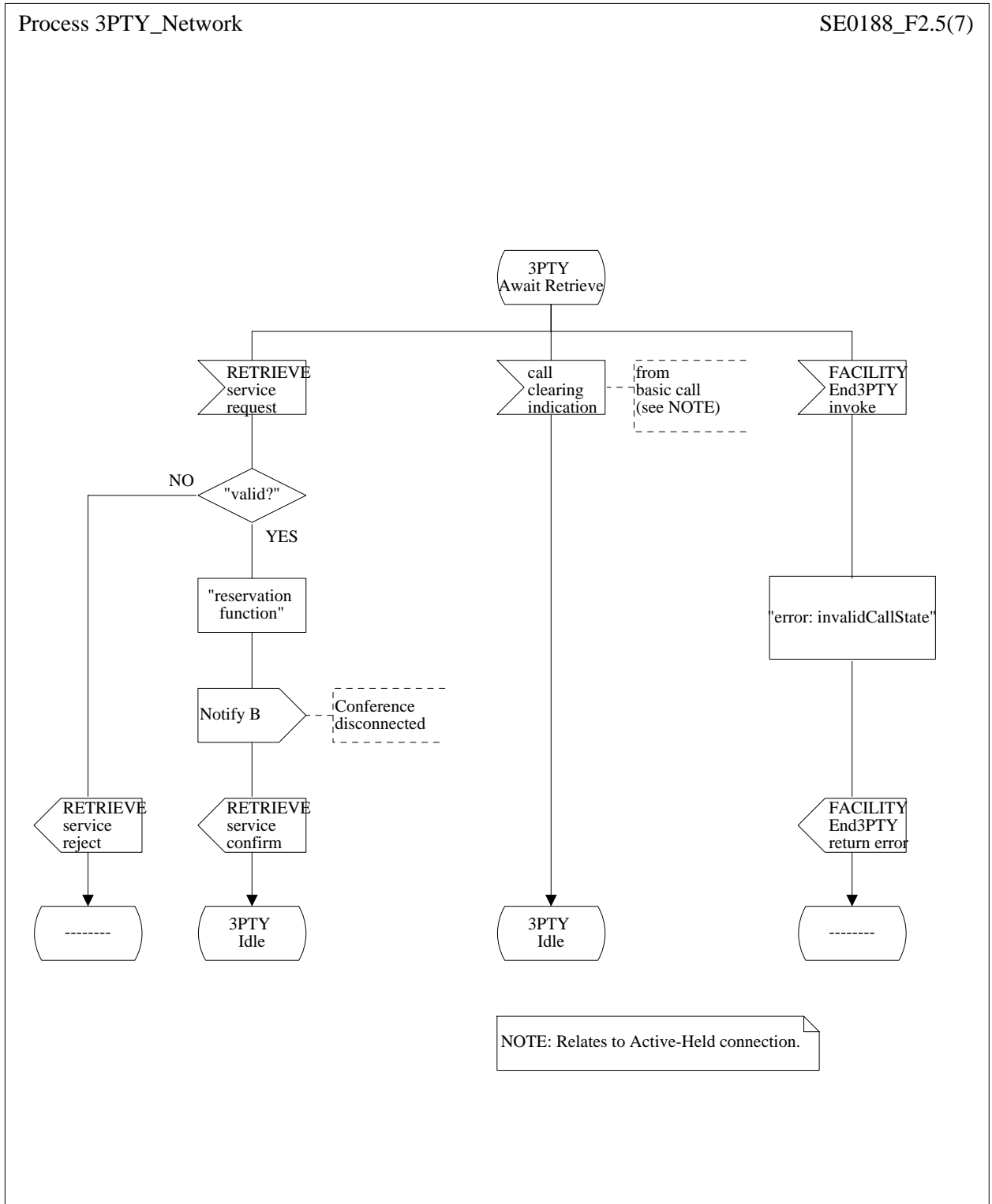

Figure 2 (sheet 5 of 7): SDL diagrams for network

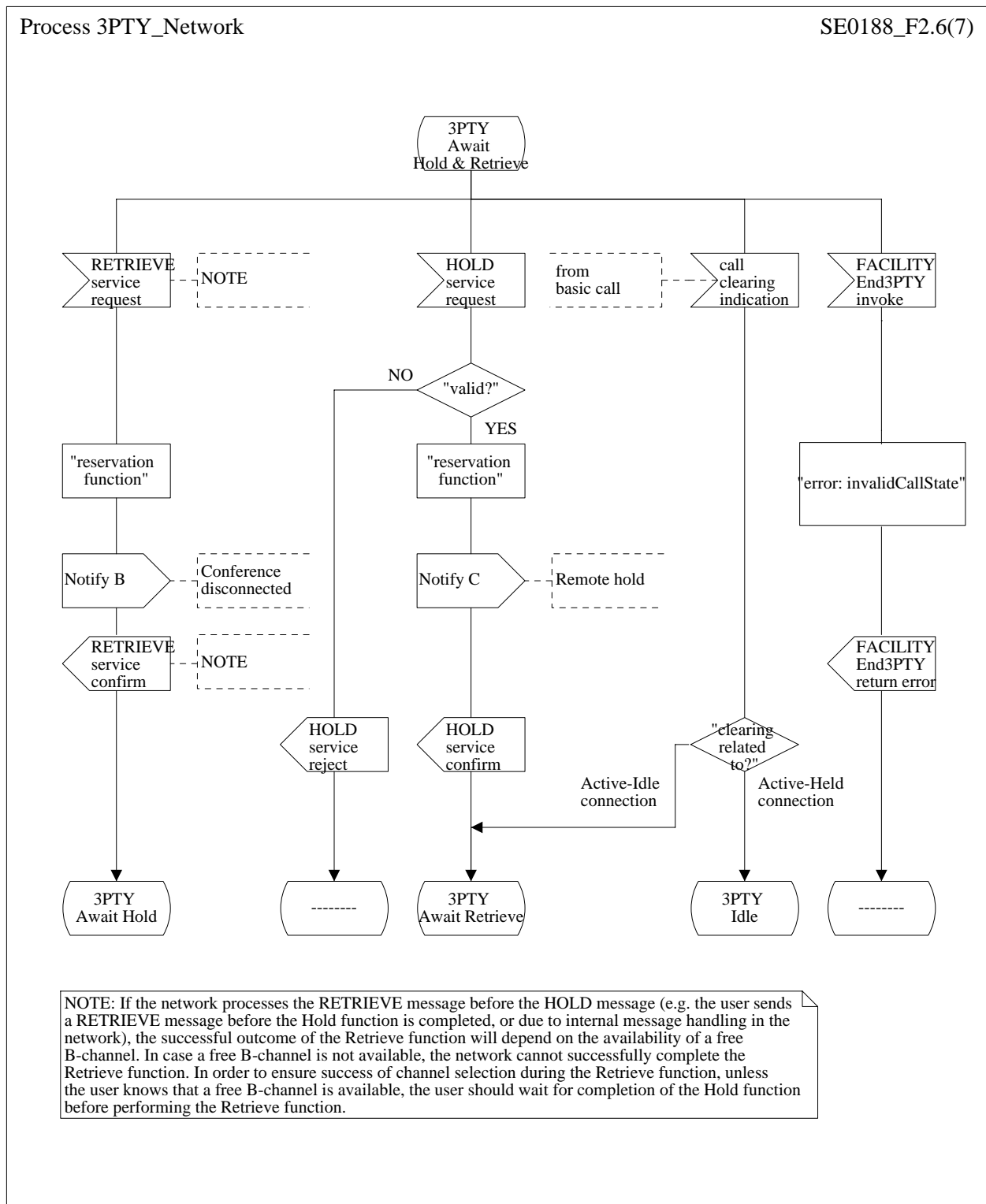

Figure 2 (sheet 6 of 7): SDL diagrams for network

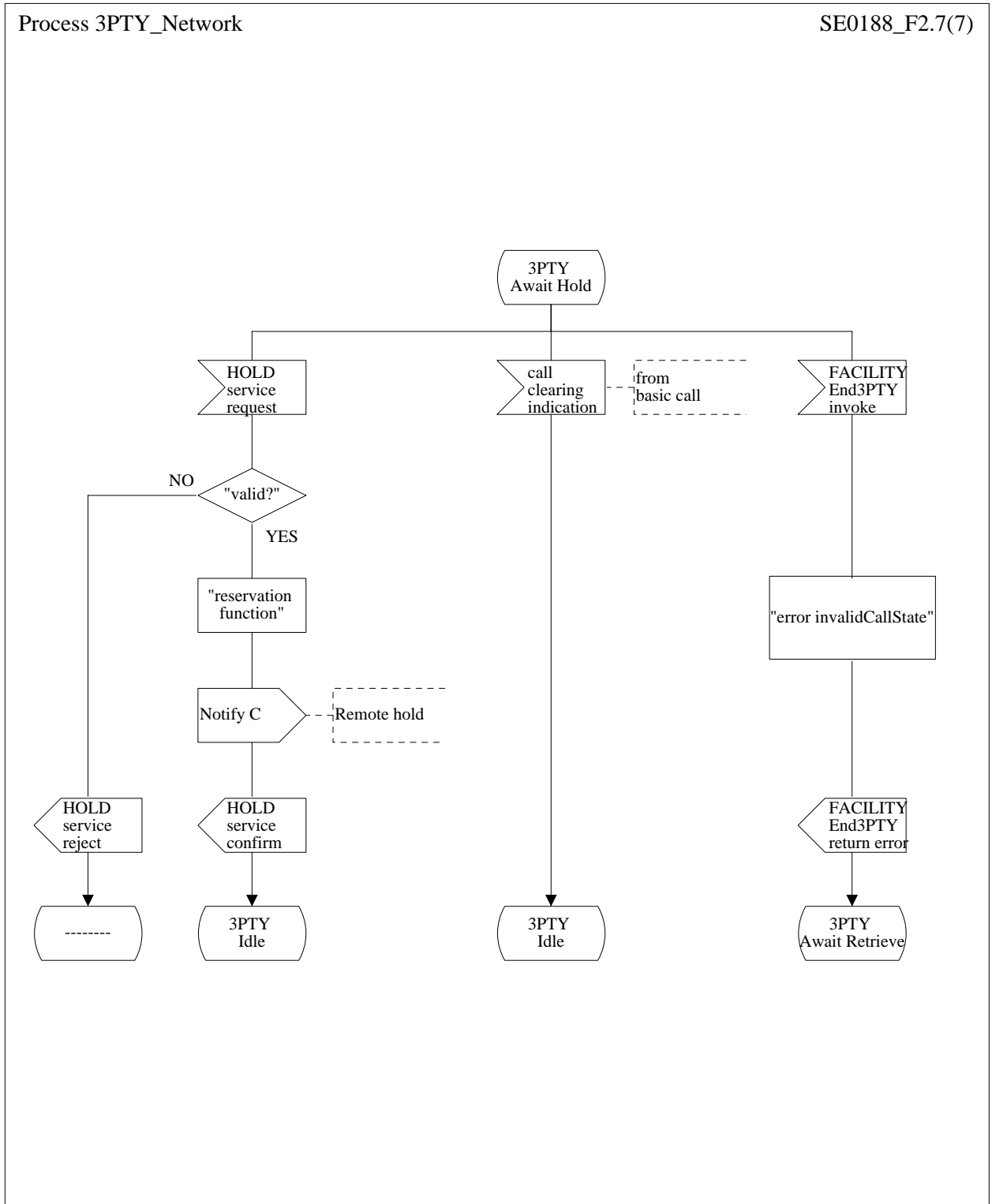

Figure 2 (sheet 7 of 7): SDL diagrams for network

Annex A (informative): Signalling flows

The signalling flows for the 3PTY supplementary service are shown as follows:

- Figure A.1: Request for a three-way conversation;
- Figure A.2: Disconnection of user B;
- Figure A.3: Disconnection of user C;
- Figure A.4: Disconnection of both remote users, user B released first;
- Figure A.5: Disconnection of both remote users, user C released first;
- Figure A.6: Creating a private communication with user B;
- Figure A.7: Creating a private communication with user C;
- Figure A.8: User B disconnects;
- Figure A.9: User C disconnects.

These figures do not reflect all the information elements described in the basic call control (see EN 300 403-1 [11]). They are only examples describing the operation of the 3PTY supplementary service.

Key to figures A.1 to A.9

CRx, CRy	Call reference used
A - B	Call between user A and user B
A - C	Call between user A and user C
Conf. establ.	Conference established
Conf. disc.	Conference disconnected
FIE	Facility information element
Rem. retr.	Remote retrieval
Rem. hold	Remote hold
ret. res.	return result

A.1 Request for a three-way conversation

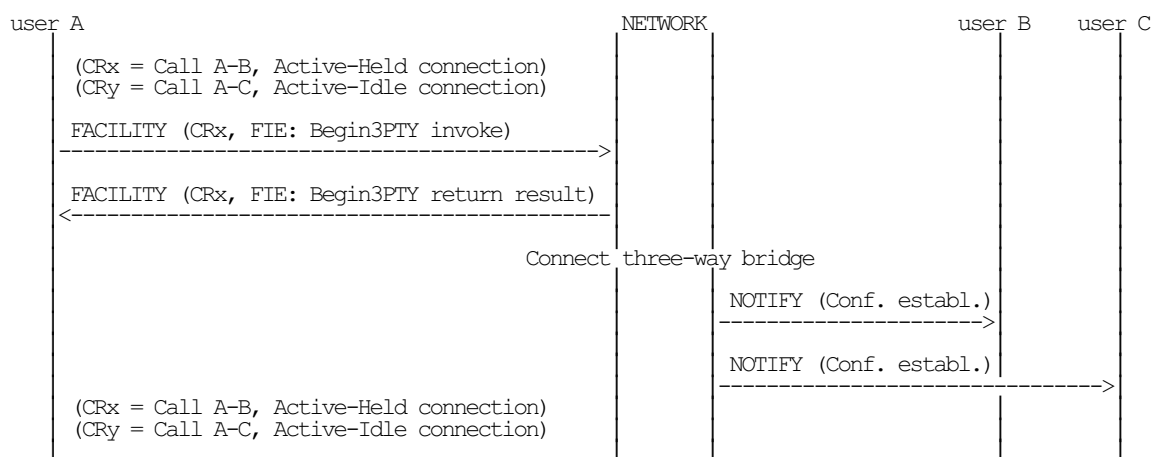

Figure A.1: Request for a three-way conversation

A.2 Disconnection of one remote user, and retention of the other

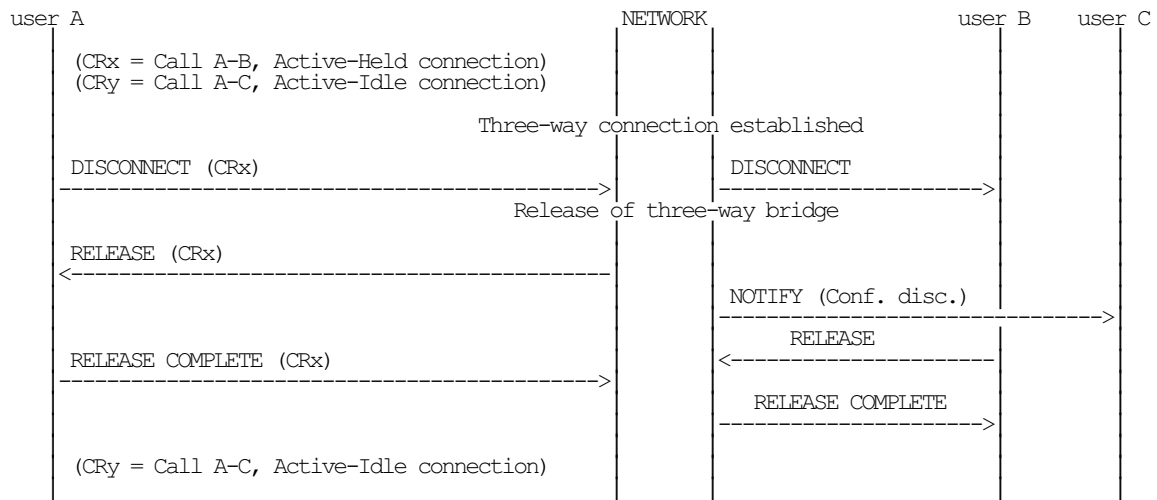

Figure A.2: Disconnection of user B

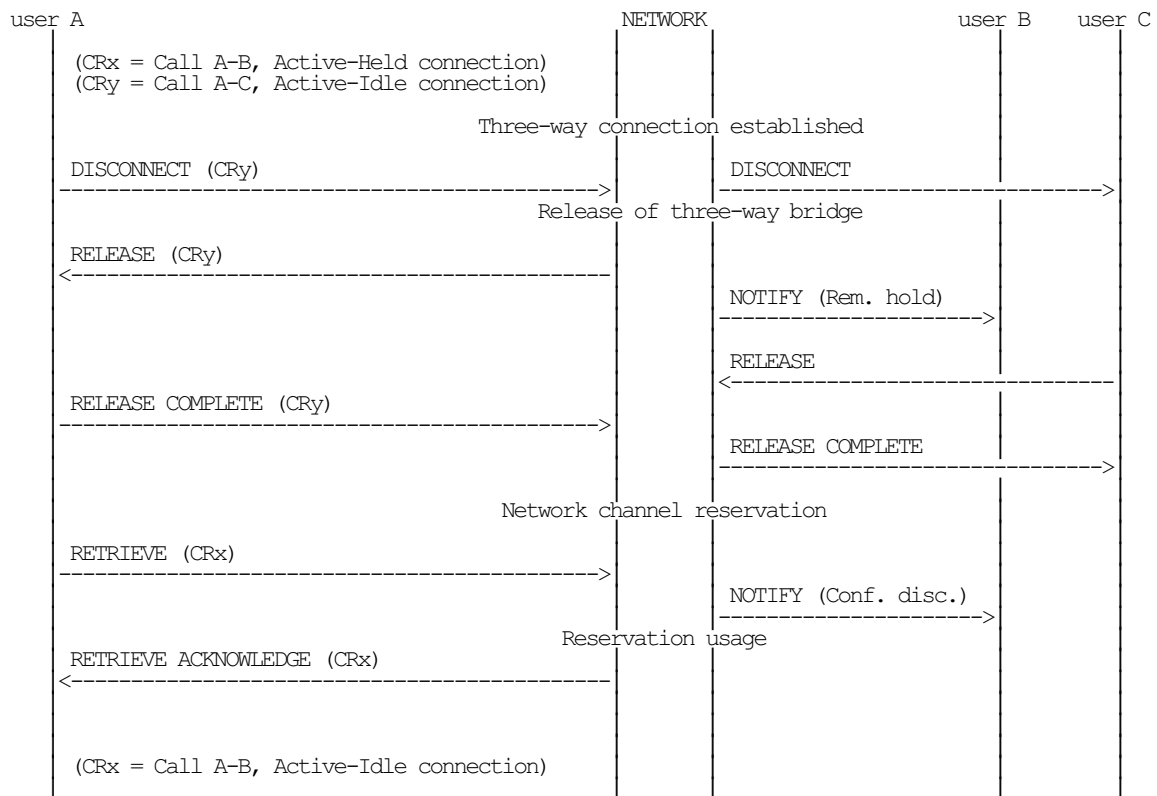

Figure A.3: Disconnection of user C

A.3 Disconnection of both remote users and terminating the call

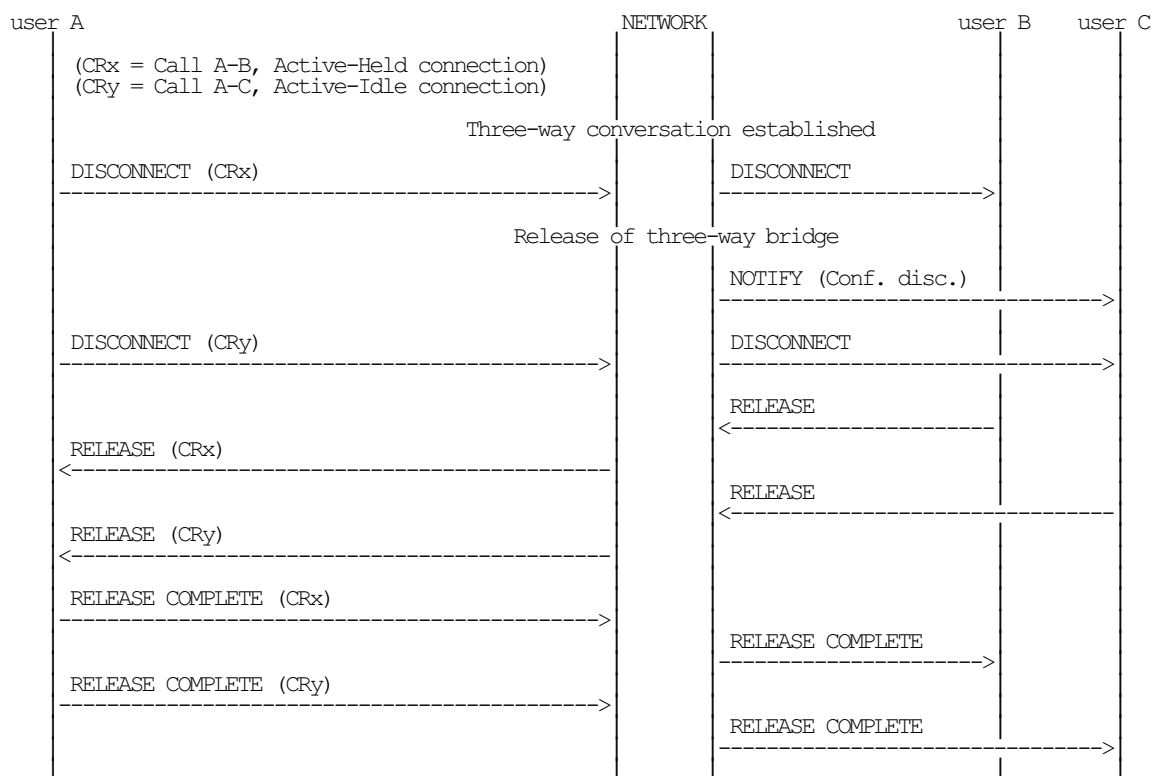

Figure A.4: Disconnection of both remote users, user B released first

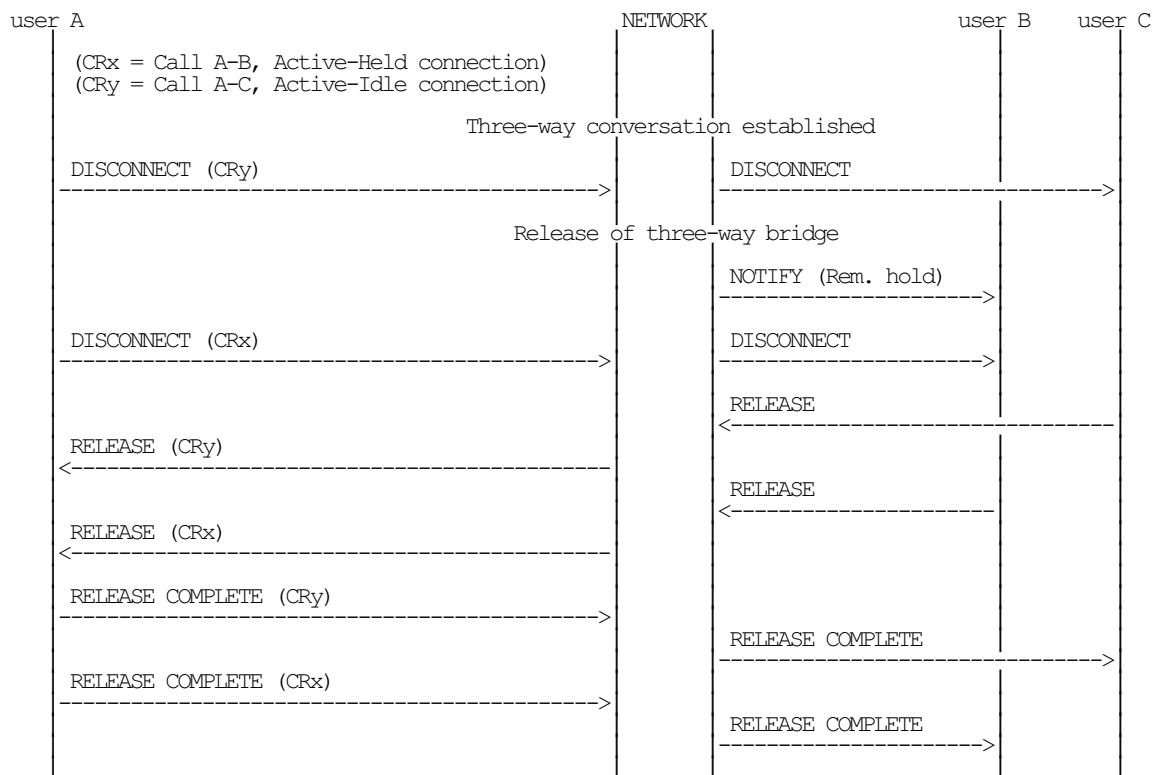

Figure A.5: Disconnection of both remote users, user C released first

A.4 Creation of a private communication with a remote user

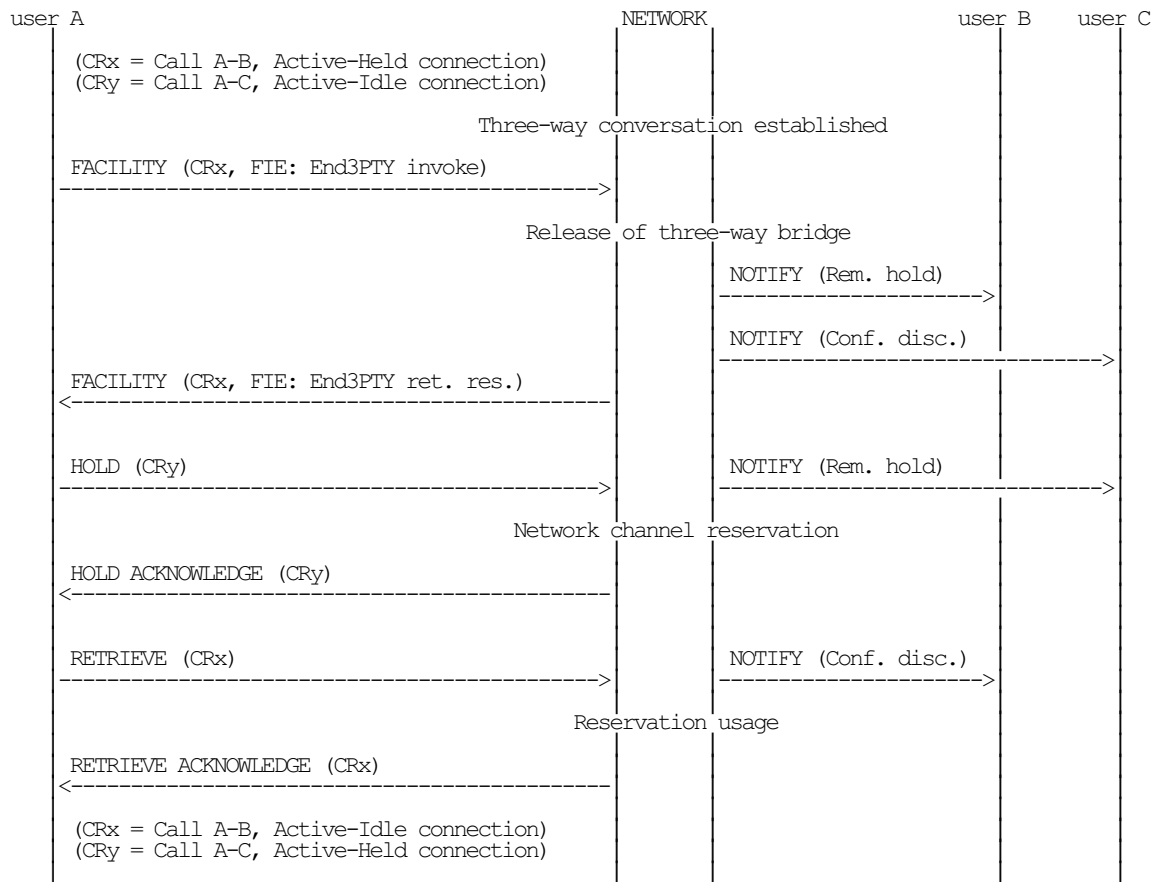

Figure A.6: Creating a private communication with user B

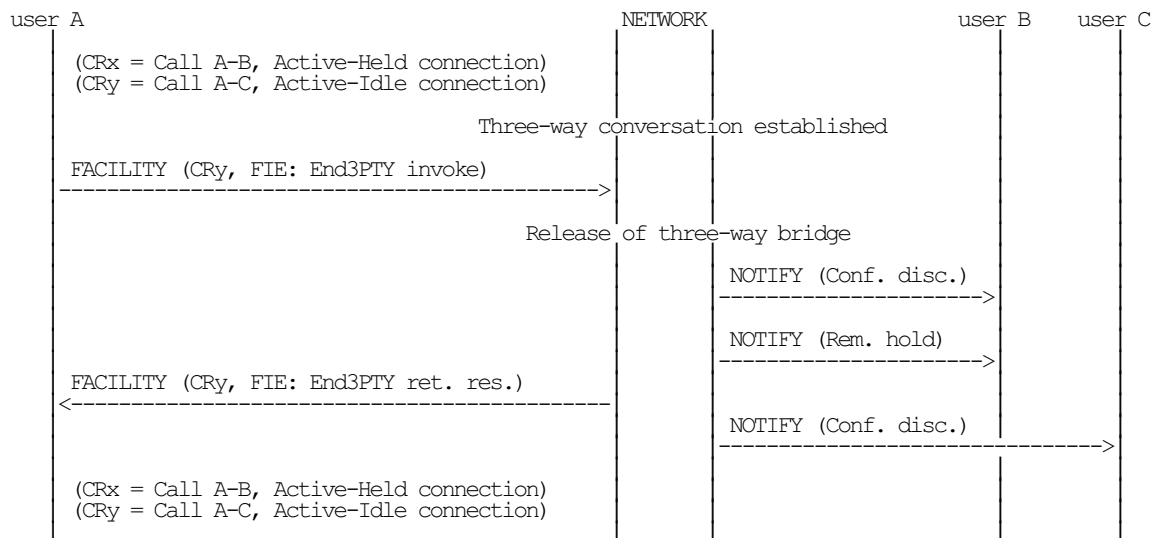

Figure A.7: Creating a private communication with user C

A.5 Remote user terminates the call

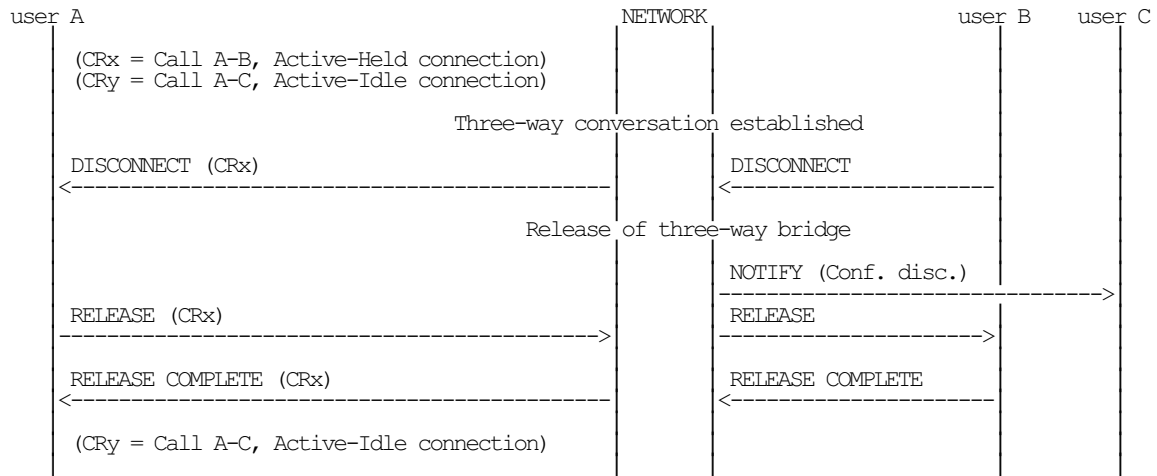

Figure A.8: User B disconnects

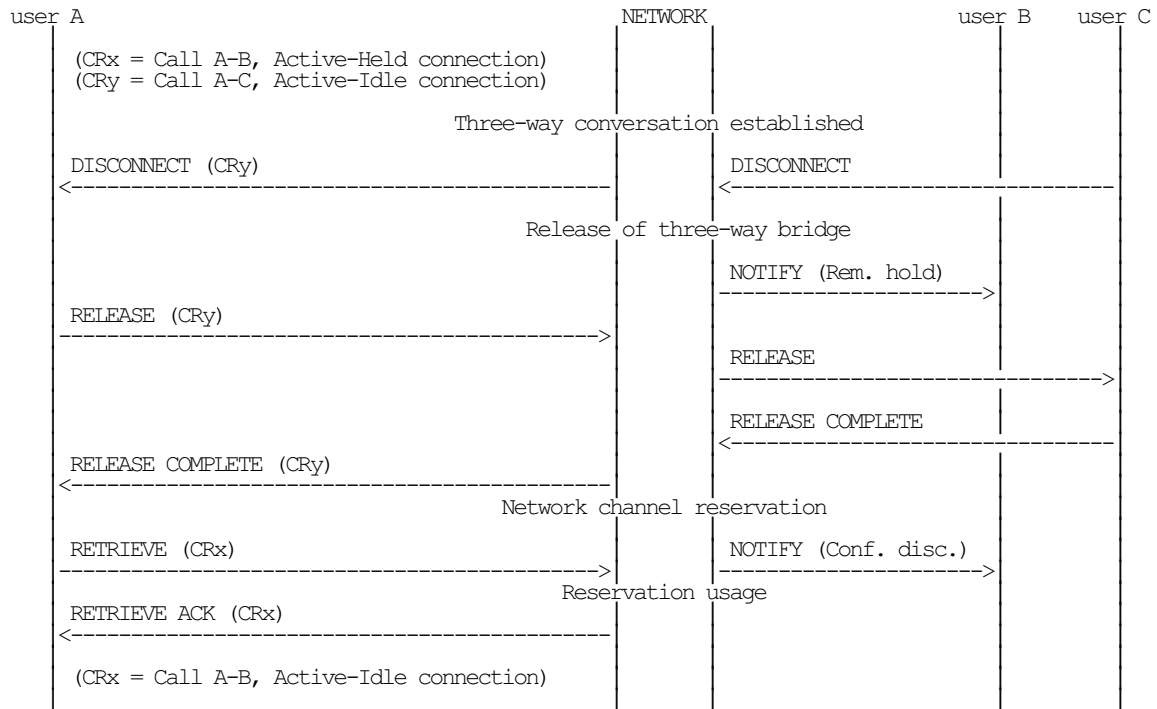

Figure A.9: User C disconnects

Annex B (informative): Changes with respect to the previous ETS 300 188-1

The following changes have been done:

- conversion to EN layout;
- replacement of references to ETS 300 102 with EN 300 403;
- substitution of non-specific references to basic standards where the intention is to refer to the latest version.

History

Document history		
Edition 1	August 1993	Publication as ETS 300 188-1
V1.2.3	February 1998	One-step Approval Procedure OAP 9824: 1998-02-13 to 1998-06-12
V1.2.4	June 1998	Publication