

EN 300 185-1 V1.2.4 (1998-06)

European Standard (Telecommunications series)

**Integrated Services Digital Network (ISDN);
Conference call, add-on (CONF) supplementary service;
Digital Subscriber Signalling System No. one (DSS1) protocol;
Part 1: Protocol specification**



Reference

REN/SPS-05145-J1-1 (1po90iqo.PDF)

Keywords

ISDN, CONF, DSS1, supplementary service**ETSI**

Postal address

F-06921 Sophia Antipolis Cedex - FRANCE

Office address

650 Route des Lucioles - Sophia Antipolis
Valbonne - FRANCE
Tel.: +33 4 92 94 42 00 Fax: +33 4 93 65 47 16
Siret N° 348 623 562 00017 - NAF 742 C
Association à but non lucratif enregistrée à la
Sous-Préfecture de Grasse (06) N° 7803/88

Internet

secretariat@etsi.fr
<http://www.etsi.fr>
<http://www.etsi.org>

Copyright Notification

No part may be reproduced except as authorized by written permission.
The copyright and the foregoing restriction extend to reproduction in all media.

© European Telecommunications Standards Institute 1998.
All rights reserved.

Contents

Intellectual Property Rights.....	5
Foreword.....	5
1 Scope	7
2 Normative references.....	7
3 Definitions	8
4 Abbreviations.....	9
5 Description	9
6 Operational requirements	9
6.1 Provision and withdrawal.....	9
6.2 Requirements on the originating network side.....	9
6.3 Requirements on the destination network side	9
7 Coding requirements.....	9
8 State definitions.....	11
9 Signalling procedures at the coincident S and T reference point	12
9.1 Activation, deactivation and registration	12
9.2 Invocation and operation.....	12
9.2.1 Beginning the conference from the Null call state.....	12
9.2.1.1 Normal operation.....	12
9.2.1.2 Exceptional procedures	12
9.2.2 Beginning the conference from the Active call state (N10, U10).....	13
9.2.2.1 Normal operation.....	13
9.2.2.2 Exceptional procedure.....	13
9.2.3 Adding a remote user.....	13
9.2.3.1 Normal operation.....	13
9.2.3.2 Exceptional procedures	14
9.2.4 Isolate a remote user.....	14
9.2.4.1 Normal operation.....	14
9.2.4.2 Exceptional procedures	15
9.2.5 Reattach a remote user.....	15
9.2.5.1 Normal operation.....	15
9.2.5.2 Exceptional procedures	15
9.2.6 Splitting a remote user.....	15
9.2.6.1 Normal operation.....	15
9.2.6.2 Exceptional procedures	16
9.2.7 Disconnect a remote user.....	16
9.2.7.1 Normal operation.....	16
9.2.7.2 Exceptional procedures	16
9.2.8 Disconnection by a remote user.....	17
9.2.8.1 Normal operation.....	17
9.2.8.2 Exceptional procedures	17
9.2.9 Terminate the conference.....	17
9.2.9.1 Normal operation.....	17
9.2.9.2 Exceptional procedures	17

10	Procedures for interworking with private ISDNs	17
11	Interactions with other networks.....	17
12	Interactions with other supplementary services.....	18
13	Parameter values (timers).....	18
14	Dynamic description (SDL diagrams).....	18
Annex A (informative): Signalling flows		35
Annex B (informative): Changes with respect to the previous ETS 300 185-1		43
History.....		44

Intellectual Property Rights

IPRs essential or potentially essential to the present document may have been declared to ETSI. The information pertaining to these essential IPRs, if any, is publicly available for **ETSI members and non-members**, and can be found in SR 000 314: "*Intellectual Property Rights (IPRs); Essential, or potentially Essential, IPRs notified to ETSI in respect of ETSI standards*", which is available **free of charge** from the ETSI Secretariat. Latest updates are available on the ETSI Web server (<http://www.etsi.fr/ipr> or <http://www.etsi.org/ipr>).

Pursuant to the ETSI IPR Policy, no investigation, including IPR searches, has been carried out by ETSI. No guarantee can be given as to the existence of other IPRs not referenced in SR 000 314 (or the updates on the ETSI Web server) which are, or may be, or may become, essential to the present document.

Foreword

This European Standard (Telecommunications series) has been produced by ETSI Technical Committee Signalling Protocols and Switching (SPS).

The present document is part 1 of a multi-part standard covering the Digital Subscriber Signalling System No. one (DSS1) protocol specification for the Integrated Services Digital Network (ISDN) Conference call, add-on (CONF) supplementary service, as described below:

- Part 1: "Protocol specification";**
- Part 2: "Protocol Implementation Conformance Statement (PICS) proforma specification";
- Part 3: "Test Suite Structure and Test Purposes (TSS&TP) specification for the user";
- Part 4: "Abstract Test Suite (ATS) and partial Protocol Implementation eXtra Information for Testing (PIXIT) proforma specification for the user";
- Part 5: "Test Suite Structure and Test Purposes (TSS&TP) specification for the network";
- Part 6: "Abstract Test Suite (ATS) and partial Protocol Implementation eXtra Information for Testing (PIXIT) proforma specification for the network".

In accordance with CCITT Recommendation I.130, the following three level structure is used to describe the supplementary telecommunications services as provided by European public telecommunications operators under the pan-European Integrated Services Digital Network (ISDN):

- Stage 1: is an overall service description, from the user's standpoint;
- Stage 2: identifies the functional capabilities and information flows needed to support the service described in stage 1; and
- Stage 3: defines the signalling system protocols and switching functions needed to implement the service described in stage 1.

The present document details the stage 3 aspects (signalling system protocols and switching functions) to support the Conference call, add-on (CONF) supplementary service. The stage 1 and stage 2 aspects are detailed in ETS 300 183 and ETS 300 184, respectively.

The present version updates the references to the basic call specifications and incorporates all previous amendments and corrigenda.

National transposition dates

Date of adoption of this EN:	19 June 1998
Date of latest announcement of this EN (doa):	30 September 1998
Date of latest publication of new National Standard or endorsement of this EN (dop/e):	31 March 1999
Date of withdrawal of any conflicting National Standard (dow):	31 March 1999

1 Scope

This first part of EN 300 185 specifies the stage three of the Conference call, add-on (CONF) supplementary service for the pan-European Integrated Services Digital Network (ISDN) as provided by European public telecommunications operators at the T reference point or coincident S and T reference point (as defined in CCITT Recommendation I.411 [1]) by means of the Digital Subscriber Signalling System No. one (DSS1). Stage 3 identifies the protocol procedures and switching functions needed to support a telecommunications service (see CCITT Recommendation I.130 [2]).

In addition, the present document specifies the protocol requirements at the T reference point where the service is provided to the user via an intermediate private ISDN.

The present document does not specify the additional protocol requirements where the service is provided to the user via a telecommunications network that is not an ISDN.

The CONF supplementary service provides a user with the ability to have a multi-connection call, i.e. a simultaneous communication between more than two parties.

The CONF supplementary service is applicable to all telecommunication services carrying speech.

Further parts of the present document specify the method of testing required to identify conformance to the present document.

The present document is applicable to equipment supporting the CONF supplementary service, to be attached at either side of a T reference point or coincident S and T reference point when used as an access to the public ISDN.

2 Normative references

References may be made to:

- a) specific versions of publications (identified by date of publication, edition number, version number, etc.), in which case, subsequent revisions to the referenced document do not apply; or
- b) all versions up to and including the identified version (identified by "up to and including" before the version identity); or
- c) all versions subsequent to and including the identified version (identified by "onwards" following the version identity); or
- d) publications without mention of a specific version, in which case the latest version applies.

A non-specific reference to an ETS shall also be taken to refer to later versions published as an EN with the same number.

- | | |
|-----|---|
| [1] | CCITT Recommendation I.411 (1988): "ISDN user-network interfaces - Reference configurations". |
| [2] | CCITT Recommendation I.130 (1988): "Method for the characterisation of telecommunication services supported by an ISDN and network capabilities of an ISDN". |
| [3] | EN 300 196-1: "Integrated Services Digital Network (ISDN); Generic functional protocol for the support of supplementary services; Digital Subscriber Signalling System No. one (DSS1) protocol; Part 1: Protocol specification". |
| [4] | EN 300 403-1: "Integrated Services Digital Network (ISDN); Digital Subscriber Signalling System No. one (DSS1) protocol; Signalling network layer for circuit-mode basic call control; Part 1: Protocol specification [ITU-T Recommendation Q.931 (1993), modified]". |
| [5] | EN 300 195-1: "Integrated Services Digital Network (ISDN); Supplementary service interactions; Digital Subscriber Signalling System No. one (DSS1) protocol; Part 1: Protocol specification". |
| [6] | EN 300 403-2: "Integrated Services Digital Network (ISDN); Digital Subscriber Signalling System No. one (DSS1) protocol; Signalling network layer for circuit-mode basic call control; Part 2: Specification and Description Language (SDL) diagrams". |

- [7] CCITT Recommendation I.112: "Vocabulary of terms for ISDNs".
- [8] CCITT Recommendation X.208 (1988): "Specification of Abstract Syntax Notation One (ASN.1)".
- [9] CCITT Recommendation X.219 (1988): "Remote operations: Model, Notation and Service definition".
- [10] CCITT Recommendation Z.100 (1988): "Functional Specification and Description Language (SDL)".
- [11] ETS 300 184: "Integrated Services Digital Network (ISDN); Conference call, add-on (CONF) supplementary service; Functional capabilities and information flows".
- [12] CCITT Recommendation Q.71 (1988): "ISDN 64 kbit/s circuit mode switched bearer services".
- [13] CCITT Recommendation I.210 (1988): "Principles of telecommunication services supported by an ISDN and the means to describe them".

3 Definitions

For the purposes of the present document, the following definitions apply:

add: An action initiated by the served user that adds a new remote user to the conference.

auxiliary state: A state as defined in EN 300 196-1 [3], subclause 7.4. An auxiliary state may exist for a call reference in parallel with the call state.

call state: A state as defined in EN 300 403-1 [4], subclause 2.1 for either the user or the network as appropriate. A call state may exist for each call reference (and for each additional responding CEI in the incoming call states).

conference ID: An identifier that identifies an instance of the CONF supplementary service.

drop: An action initiated by the served user that disconnects a remote user from the conference.

Integrated Services Digital Network (ISDN): See CCITT Recommendation I.112 [7], § 2.3, definition 308.

invoke component: See EN 300 196-1 [3], subclause 8.2.2.1. Where reference is made to a "xxxx" invoke component, an invoke component is meant with its operation value set to the value of operation "xxxx".

isolate: An action initiated by the served user that restricts communications with a participant of the conference.

network: The DSS1 protocol entity at the network side of the user-network interface.

party ID: An identifier that identifies a participant within an instance of the CONF supplementary service.

reattach: An action initiated by the served user that re-establishes the communication with a participant of the conference.

remote user: The DSS1 protocol entity at the user side of the user-network interface which is involved in an instance of the CONF supplementary service but which has no control of it.

return error component: See EN 300 196-1 [3], subclause 8.2.2.3. Where reference is made to a "xxxx" return error component, a return error component is meant which is related to a "xxxx" invoke component.

return result component: See EN 300 196-1 [3], subclause 8.2.2.2. Where reference is made to a "xxxx" return result component, a return result component is meant which is related to a "xxxx" invoke component.

served user: The DSS1 protocol entity at the user side of the user-network interface used to request and control the CONF supplementary service.

service; telecommunications service: See CCITT Recommendation I.112 [7], § 2.2, definition 201.

split: An action initiated by the served user that creates a normal call between the served user and a remote user.

supplementary service: See CCITT Recommendation I.210 [13], § 2.4.

user: The DSS1 protocol entity at the user side of the user-network interface.

4 Abbreviations

For the purposes of the present document, the following abbreviations apply:

ASN.1	Abstract Syntax Notation One
CONF	Conference call, add-on
DSS1	Digital Subscriber Signalling System No. one
ISDN	Integrated Services Digital Network
PSTN	Public Switched Telephone Network
SDL	Specification Description Language

5 Description

The CONF supplementary service can be invoked either from the Null call state (N0, U0) or, additionally, as a network option from an existing call in the Active call state (N10, U10).

When the CONF supplementary service is invoked, conference resources (e.g. a "bridge") are allocated to the served user. In the case of invocation from an active call, this call shall be automatically connected by the network to the conference resources.

Once a conference is active, remote users may be added, dropped, isolated (i.e. prevented from communicating with the conference), reattached or split (i.e. removed from the conference but remain connected to the conference controller).

Remote users are notified of these actions.

NOTE: During an interim period of time, some networks may not support the transfer of notifications.

6 Operational requirements

6.1 Provision and withdrawal

Not applicable.

6.2 Requirements on the originating network side

Not applicable.

6.3 Requirements on the destination network side

Not applicable.

7 Coding requirements

Table 1 shows the definition of the operations and errors required for the CONF supplementary service using ASN.1 as specified in CCITT Recommendation X.208 [8] and using the OPERATION and ERROR macro as defined in figure 4/X.219 of CCITT Recommendation X.219 [9].

The formal definition of the component types to encode these operations and errors is provided in EN 300 196-1 [3], annex D, clause D.1.

The inclusion of components in Facility information elements is defined in EN 300 196-1 [3], subclause 11.2.2.1.

Table 1: Definition of operations and errors for the CONF supplementary service

```

Conference-Add-On-Operations {ccitt identified-organization etsi (0) 185 operations-and-types
(1)}

DEFINITIONS EXPLICIT TAGS ::=
BEGIN

EXPORTS      BeginCONF, AddCONF, SplitCONF, DropCONF,
             IsolateCONF, ReattachCONF, PartyDISC,
             IllConferenceId, IllPartyId,
             NumberOfPartiesExceeded,
             NotActive, NotAllowed, PartyId, ConferenceId, ConfSize;

IMPORTS      OPERATION,
             ERROR
             FROM Remote-Operation-Notation
                 {joint-iso-ccitt remote-operations(4) notation(0)}
             notSubscribed, notAvailable,
             supplementaryServiceInteractionNotAllowed,
             resourceUnavailable, invalidCallState
             FROM General-Errors
                 {ccitt identified-organization etsi(0) 196 general-errors (2)};

BeginCONF ::= OPERATION
             ARGUMENT    ConfSize -- optional
             RESULT SEQUENCE {
                 ConferenceId,
                 PartyId OPTIONAL }
             ERRORS {notSubscribed, notAvailable,
                 resourceUnavailable,
                 invalidCallState,
                 NumberOfPartiesExceeded}

AddCONF ::= OPERATION
           ARGUMENT    ConferenceId
           RESULT PartyId
           ERRORS {IllConferenceId,
                 NumberOfPartiesExceeded,
                 NotAllowed,
                 supplementaryServiceInteractionNotAllowed,
                 invalidCallState}

SplitCONF ::= OPERATION
            ARGUMENT    SEQUENCE {
                ConferenceId,
                PartyId}
            RESULT
            ERRORS {IllConferenceId, IllPartyId}

DropCONF ::= OPERATION
            ARGUMENT    PartyId
            RESULT
            ERRORS {IllPartyId, NotActive}

IsolateCONF ::= OPERATION
              ARGUMENT    PartyId
              RESULT
              ERRORS {IllPartyId, NotActive}

ReattachCONF ::= OPERATION
               ARGUMENT    PartyId
               RESULT
               ERRORS {IllPartyId, NotActive}

```

Table 1 (concluded): Definition of operations and errors for the CONF supplementary service

PartyDISC ::=	OPERATION	ARGUMENT	PartyId
IllConferenceId	::= ERROR		
IllPartyId	::= ERROR		
NumberOfPartiesExceeded	::= ERROR		
NotActive	::= ERROR		
NotAllowed	::= ERROR		
PartyId	::= INTEGER (0..127)		
ConferenceId	::= INTEGER (0..127)		
ConfSize	::= INTEGER (0..127)		
beginCONF	BeginCONF		::= 40
addCONF	AddCONF		::= 41
splitCONF	SplitCONF		::= 42
dropCONF	DropCONF		::= 43
isolateCONF	IsolateCONF		::= 44
reattachCONF	ReattachCONF		::= 45
partyDISC	PartyDISC		::= 46
illConferenceId	IllConferenceId		::= 28
illPartyId	IllPartyId		::= 29
numberOfPartiesExceeded	NumberOfPartiesExceeded		::= 30
notActive	NotActive		::= 31
notAllowed	NotAllowed		::= 32
END -- of Conference-Add-On-Operations			

All components (invoke, return result, return error and reject) shall be included within a Facility information element. This Facility information element may be included in any appropriate message as specified in EN 300 196-1 [3], subclause 8.3.1.1, unless a more restricting specification is given in clause 9.

Table 2 contains the additional codepoints for the CONF supplementary service which shall be employed in octet 3 of the Notification indicator information element (to be conveyed in the NOTIFY message).

Table 2: Additional codepoints in the Notification indicator information element

Bits	
8 7 6 5 4 3 2 1	
1 1 0 0 0 0 1 0	Conference established (note 1)
1 1 0 0 0 0 1 1	Conference disconnected (note 2)
1 1 0 0 0 1 0 0	Other party added
1 1 0 0 0 1 0 1	Isolated
1 1 0 0 0 1 1 0	Reattached
1 1 0 0 0 1 1 1	Other party isolated
1 1 0 0 1 0 0 0	Other party reattached
1 1 0 0 1 0 0 1	Other party split
1 1 0 0 1 0 1 0	Other party disconnected
NOTE 1: The user takes part in a multiparty call.	
NOTE 2: The user takes part in a normal two-party call.	

8 State definitions

The states associated with basic call control given in EN 300 403-1 [4] shall apply.

9 Signalling procedures at the coincident S and T reference point

9.1 Activation, deactivation and registration

Not applicable, i.e. no signalling procedures are required for the activation, deactivation and registration of the CONF supplementary service.

9.2 Invocation and operation

9.2.1 Beginning the conference from the Null call state

9.2.1.1 Normal operation

To request a conference from the Null call state (U0), the served user shall send a SETUP message to the network including a Facility information element and a Bearer capability information element. The Facility information element shall contain a BeginCONF invoke component. This component may contain a ConfSize parameter indicating the maximum number of remote users. If this parameter is not provided, then the network shall set the conference size to a network dependent value. The Bearer capability information element shall indicate an appropriate bearer capability with regard to the applicability of the CONF supplementary service. The Called party number and Called party subaddress information element shall be omitted by the user. For the purpose of basic call processing the network shall regard the SETUP message as containing all the information necessary to establish the connection to the conference bridge, i.e. the SETUP ACKNOWLEDGE message shall not be used. Further, the normal basic call procedures apply according to subclause 5.1 of EN 300 403-1 [4].

When the network responds with a CONNECT message it shall include a BeginCONF return result component in a Facility information element. This component contains a ConferenceId parameter. The network shall allocate a ConferenceId that is unique for all accesses assigned for the served user. The ConferenceId shall be used in some operations to identify the conference explicitly.

When the user receives a correctly encoded BeginCONF return result component the user shall accept the provided information, save the included ConferenceId and shall not respond to the network.

The procedures used to request a conference are completely independent from other calls.

9.2.1.2 Exceptional procedures

If the user is not subscribed to the CONF supplementary service, the network shall start the basic call clearing procedures as defined in subclause 5.3 of EN 300 403-1 [4]. One of the messages sent by the network to the served user shall contain a Facility information element with a BeginCONF return error component indicating "notSubscribed". Furthermore, this message shall contain a Cause information element indicating cause #31 "Normal, unspecified" and a location of "public network serving the local user".

If the network cannot accept the operation because the conference size as requested by the user exceeds the size supported by the network, the network shall start the basic call clearing procedures as defined in subclause 5.3 of EN 300 403-1 [4]. One of the messages sent by the network to the served user shall contain a Facility information element with a BeginCONF return error component indicating "numberOfPartiesExceeded". Furthermore, this message shall contain a Cause information element indicating cause #31 "Normal, unspecified" and a location of "public network serving the local user".

If the network cannot accept the operation because of lack of a conference bridge or other resources, the network shall start the basic call clearing procedures as defined in subclause 5.3 of EN 300 403-1 [4]. One of the messages sent by the network to the served user shall contain a Facility information element with a BeginCONF return error component indicating "resourceUnavailable". Furthermore, this message shall contain a Cause information element indicating cause #31 "Normal, unspecified" and a location of "public network serving the local user".

If the user indicates an in-appropriate bearer capability, the network shall start the basic call clearing procedures as defined in subclause 5.3 of EN 300 403-1 [4]. One of the messages sent by the network to the served user shall contain a Facility information element with a BeginCONF-Return-Error component indicating the error "notAvailable". Furthermore, this message shall contain a Cause information element indicating cause #31 "Normal, unspecified" and a location of "public network serving the local user".

9.2.2 Beginning the conference from the Active call state (N10, U10)

9.2.2.1 Normal operation

To accept a request for a conference from an active call is a network option.

To request a conference the served user shall send a FACILITY message to the network indicating the call reference of the existing call and including a Facility information element. This Facility information element shall contain a BeginCONF invoke component. This component may contain a ConfSize parameter indicating the maximum number of remote users. If this parameter is not provided, then the network shall set the conference size to a network dependent value. The served user shall only request a conference for a connection, identified by the call reference, with an appropriate bearer capability. This connection can be either in the (Active, Idle) or (Active, Call Held) state.

The network shall send a BeginCONF return result component to the served user in a FACILITY message. This component contains a ConferenceId and PartyId parameter. The ConferenceId shall be used in some operations to identify the conference explicitly. The network shall allocate a ConferenceId that is unique for all accesses assigned for the served user. The PartyId shall be used in subsequent operations to identify the remote user of the original call.

When the user receives a correctly encoded BeginCONF return result component the user shall accept the provided information, save the included ConferenceId and PartyId parameter and shall not respond to the network.

The procedures to generate PartyId's are outside the scope of the present document. The requirements with respect to PartyId's are that a PartyId used to identify a remote user shall not be used again until the remote user identified by this PartyId has been dropped from the conference, i.e. a PartyId shall be unique within the context of a single conference.

The call state and auxiliary state of the network and the served user shall not be changed.

The network shall send a NOTIFY message to the remote user with a Notification indicator information element indicating that this remote user has been added to the conference ("Conference established").

9.2.2.2 Exceptional procedure

If the user is not subscribed to the CONF supplementary service, the network shall send a BeginCONF return error component indicating "notSubscribed" to the served user in a FACILITY message.

If the network cannot accept the operation because the conference size as requested by the user exceeds the size supported by the network, the network shall send a BeginCONF return error component indicating "numberOfPartiesExceeded" to the served user in a FACILITY message.

If the network cannot accept this operation because of lack of a conference bridge or other resources, the network shall send a BeginCONF return error component indicating "resourceUnavailable" to the served user in a FACILITY message.

If the network receives a BeginCONF invoke component for a call reference value that is not in the Active call state (N10) and not in the Null call state (N0), the network shall send a BeginCONF return result component indicating the error "invalidCallState" to the served user in a FACILITY message.

If the user indicates an in-appropriate bearer capability, the network shall send a BeginCONF-Return-Error component indicating "notAvailable" to the served user in a FACILITY message.

9.2.3 Adding a remote user

9.2.3.1 Normal operation

To add a new remote user, the connection to the conference bridge can be either in the (Active, Idle) state or in the (Active, Call Held) state. The notation (Active, Call Held) is defined in EN 300 196-1 [3], subclause 7.5. The served

user shall only add a remote user for a connection with an appropriate bearer capability. The connection to the remote user to be added shall be either in the (Active, Idle) state or (Active, Call Held) state.

The served user shall send a FACILITY message to the network indicating the call reference of the call to be added and including an AddCONF invoke component. This component contains a ConferenceId parameter indicating the conference.

The network shall send a DISCONNECT message to the served user containing a Facility information element with an AddCONF return result component and continue clearing according to subclause 5.3.3 of EN 300 403-1 [4]. This component contains a PartyId. This PartyId shall be used in subsequent operations to identify the added remote user. The first clearing message shall contain a Cause information element indicating cause #31 "Normal, unspecified" and a location of "public network serving the local user".

When the user receives a correctly encoded AddCONF return result component, the user shall accept the provided information, save the included PartyId and shall not respond to the network.

The procedures to generate PartyId's are outside the scope of the present document. The requirements with respect to PartyId's are that a PartyId used to identify a remote user shall not be used again until the remote user identified by this PartyId has been dropped from the conference, i.e. a PartyId shall be unique within the context of a single conference.

The call state and auxiliary state of the network and the served user for the call reference identifying the connection to the conference bridge shall not be changed.

NOTE: If the connection to the conference bridge was in the (Active, Call Held) state, the served user can retrieve the connection in order for communication to take place. This procedure is part of the call hold supplementary service.

The network shall send a NOTIFY message to the added remote user with a Notification indicator information element indicating that this remote user has been added to the conference ("Conference established").

The network shall send a NOTIFY message to all other remote users with a Notification indicator information element indicating that a new remote user has been added to the conference ("Other party added").

9.2.3.2 Exceptional procedures

If the ConferenceId used is not associated with a conference known to the network, the network shall send an AddCONF return error component indicating "illConferenceId" to the served user in a FACILITY message.

NOTE: This error can also occur as a result of routing constraints.

If the network cannot accept this operation because the maximum number of parties has been reached, the network shall send an AddCONF return error component indicating "NumberOfPartiesExceeded" to the served user in a FACILITY message.

If the network cannot accept this operation because addition of the call would result in violation of Closed User Group rules, the network shall send an AddCONF return error component indicating "supplementaryServiceInteractionNotAllowed" to the served user in a FACILITY message.

If the network receives a Facility information element containing an AddCONF invoke component for a call reference value that is not in the Active call state (N10) and not in the Null call state (N0), the network shall send an AddCONF return error component to the served user in a FACILITY message indicating the error "invalidCallState".

If the network cannot accept this operation for any other reason, the network shall send an AddCONF return error component indicating "notAllowed" to the served user in a FACILITY message.

9.2.4 Isolate a remote user

9.2.4.1 Normal operation

To isolate a remote user, the served user shall send an IsolateCONF invoke component to the network in a FACILITY message. The component includes a PartyId parameter identifying the remote user to be isolated.

To indicate a successful operation, the network shall send an IsolateCONF return result component to the served user in a FACILITY message.

When the user receives a correctly encoded IsolateCONF return result component the user shall accept the provided information and shall not respond to the network.

After execution of the IsolateCONF operation the remote user remains connected to the conference but communication is not possible.

The network shall send a NOTIFY message to the isolated remote user with a Notification indicator information element indicating "Isolated".

The network shall send a NOTIFY message to all other remote users with a Notification indicator information element indicating that a remote user has been isolated ("Other party isolated").

9.2.4.2 Exceptional procedures

If the PartyId used is not associated with a remote user, the network shall send an IsolateCONF return error component indicating "illPartyId" to the served user in a FACILITY message.

If the network cannot accept this operation because the conference has not successfully been established, the network shall send an IsolateCONF return error component indicating "notActive" to the served user in a FACILITY message.

If the remote user indicated in the IsolateCONF invoke component is already isolated, then the network shall not treat this as an error but shall return an IsolateCONF return result component to the served user in a FACILITY message.

9.2.5 Reattach a remote user

9.2.5.1 Normal operation

To reattach an isolated remote user, the served user shall send a ReattachCONF invoke component to the network in a FACILITY message. The component includes a PartyId parameter identifying the remote user to be reattached.

To indicate a successful operation, the network shall connect the reattached remote user to the conference and send a ReattachCONF return result component to the served user in a FACILITY message.

When the user receives a correctly encoded ReattachCONF return result component, the user shall accept the provided information and shall not respond to the network.

The network shall send a NOTIFY message to the reattached remote user with a Notification indicator information element indicating "Reattached".

The network shall send a NOTIFY message to all other parties with a Notification indicator information element indicating that a remote user has been reattached ("Other party reattached").

9.2.5.2 Exceptional procedures

If the PartyId used is not associated with a remote user, the network shall send a ReattachCONF return error component indicating "illPartyId" to the served user in a FACILITY message.

If the network cannot accept this operation because the conference has not successfully been established, the network shall send a ReattachCONF return error component indicating "notActive" to the served user in a FACILITY message.

If the remote user indicated in the ReattachCONF invoke component is already reattached, then the network shall not treat this as an error but return a ReattachCONF return result component to the served user in a FACILITY message.

9.2.6 Splitting a remote user

9.2.6.1 Normal operation

To split a remote user that may be isolated, the served user shall send a SETUP message to the network including a Facility information element and a Bearer capability information element. The Facility information element shall contain a SplitCONF invoke component. This component contains a ConferenceId parameter identifying the conference and a PartyId parameter identifying the remote user to be split. The Bearer capability information element shall indicate an

appropriate bearer capability with regard to the applicability of the CONF supplementary service. The Called party number and Called party subaddress information element shall be omitted by the user. Further, the normal basic call procedures apply according to subclause 5.1 of EN 300 403-1 [4].

To indicate a successful operation, the network shall send a SplitCONF return result component to the served user in the CONNECT message.

On sending the SplitCONF return result component, the network shall release the PartyId; the PartyId may be used to identify future remote users.

When the served user receives a correctly encoded SplitCONF return result component, the user shall accept the provided information, release the PartyId included in the invoke component and shall not respond to the network.

After execution of the SplitCONF operation the served user has a separate call with the indicated remote user. All other remote users are still involved in the conference.

The network shall send a NOTIFY message to the split remote user with a Notification indicator information element indicating "Conference disconnected".

The network shall send a NOTIFY message to all other remote users with a Notification indicator information element indicating that a remote user has been split ("Other party split").

9.2.6.2 Exceptional procedures

If the ConferenceId used is not associated with a conference, the network shall start the basic call clearing procedures according to subclause 5.3 of EN 300 403-1 [4]. One of the messages sent to the served user shall contain a SplitCONF return error component indicating "illConferenceId". Furthermore, this message shall contain a Cause information element indicating cause #31 "Normal, unspecified" and a location of "public network serving the local user".

If the PartyId used is not associated with a remote user, the network shall start the basic call clearing procedures according to subclause 5.3 of EN 300 403-1 [4]. One of the messages sent to the served user shall contain a SplitCONF return error component indicating "illPartyId". Furthermore, this message shall contain a Cause information element indicating cause #31 "Normal, unspecified" and a location of "public network serving the local user".

9.2.7 Disconnect a remote user

9.2.7.1 Normal operation

To disconnect a remote user, the served user shall send a DropCONF invoke component to the network in a FACILITY message. The component includes a PartyId parameter identifying the remote user to be disconnected.

To indicate that the identified remote user has been removed from the conference and that the clearing procedures according to subclause 5.3.4 of EN 300 403-1 [4] are in progress at the remote user, the network shall send a DropCONF return result component to the served user in a FACILITY message.

When the user receives a correctly encoded DropCONF return result component, the user shall accept the provided information and shall not respond to the network.

The PartyId shall be released by the user and the network and can be used to identify future remote users.

The network shall send a NOTIFY message to all other remote users with a Notification indicator information element indicating that a remote user has been disconnected ("Other party disconnected").

9.2.7.2 Exceptional procedures

If the PartyId used is not associated with a remote user, the network shall send a DropCONF return error component to the served user in a FACILITY message. A parameter included in this component shall indicate "illPartyId".

If the network cannot accept this operation because the conference has not successfully been established, the network shall send a DropCONF return error component to the served user. A parameter included in this component shall indicate "notActive".

9.2.8 Disconnection by a remote user

9.2.8.1 Normal operation

At any time a remote user can disconnect from the conference by using the call clearing procedures according to subclause 5.3.3 of EN 300 403-1 [4]. To indicate the served user that such a remote user has been removed from the conference, the network shall send a PartyDISC invoke component in a FACILITY message to the served user with a parameter indicating the PartyId associated with this remote user, after the remote user is disconnected from the conference bridge.

On sending the PartyDISC invoke component, the network shall release the PartyId; the PartyId can be used to identify future remote users. On receiving the PartyDISC invoke component, the user shall release the PartyId.

The network shall send a NOTIFY message to all other remote users with a Notification indicator information element indicating that a remote user has been disconnected ("Other party disconnected").

9.2.8.2 Exceptional procedures

Not applicable.

9.2.9 Terminate the conference

9.2.9.1 Normal operation

To terminate the conference, the served user shall clear the connection to the network by using the basic call clearing procedures according to subclause 5.3.3 of EN 300 403-1 [4].

On sending or receiving the RELEASE COMPLETE message associated with clearing the connection, the user shall release the PartyId associated with each remote user, and shall release the ConferenceId associated with the clearing of the connection.

On receiving the DISCONNECT message, the network shall make the conference unavailable, i.e. all subsequent operations invoked for this conference by the user shall be responded to with the appropriate return error component specifying "notActive" or "IllConferenceId" depending on the operation requested. On sending or receiving the RELEASE COMPLETE message associated with clearing the connection, the network shall release the PartyId associated with each remote user, and shall release the ConferenceId associated with the clearing of the connection. The ConferenceId shall be available for re-use on other conferences.

9.2.9.2 Exceptional procedures

If the connection between the served user and the network is cleared for some reason, then the conference shall be terminated.

10 Procedures for interworking with private ISDNs

If the served user, residing in a private network, requests the CONF supplementary service, as provided by the public network, the procedures of subclause 9.2 shall apply.

If the remote user resides in a private ISDN then the public network shall send the notifications according to the procedures of subclause 9.2.

Where the service provider resides in a private network and remote users in the public network, when appropriate the private network shall send the notification codepoints as defined in the present document to the public network in NOTIFY messages.

11 Interactions with other networks

Remote users in a Public Switched Telephone Network (PSTN) need not receive notifications.

12 Interactions with other supplementary services

The interactions with other supplementary services shall be as specified in EN 300 195-1 [5].

13 Parameter values (timers)

No specific timers are required.

14 Dynamic description (SDL diagrams)

Figures 1 to 7 show the SDL diagrams for the user-side process and figures 8 to 14 show the SDL diagrams for the network-side process.

NOTE: The SDLs take into account the access protocol aspects only. The functional behaviour is not reflected in the SDLs.

The SDL diagrams are specified according to CCITT Recommendation Z.100 [10].

The SDLs make reference to the information flows CONF, CONF REJECT, ADD, ADD REJECT, SPLIT, SPLIT REJECT, ISOLATE, ISOLATE REJECT, REATTACH, REATTACH REJECT, DROP, DROP REJECT and INFORM 6 as specified in ETS 300 184 [11] and SETUP as specified in CCITT Recommendation Q.71 [12].

The SDLs for the local clearing procedure applied after a call has been added to the conference, are according to EN 300 403-2 [6].

The SDLs for the notification procedure of the remote users are according to EN 300 403-2 [6].

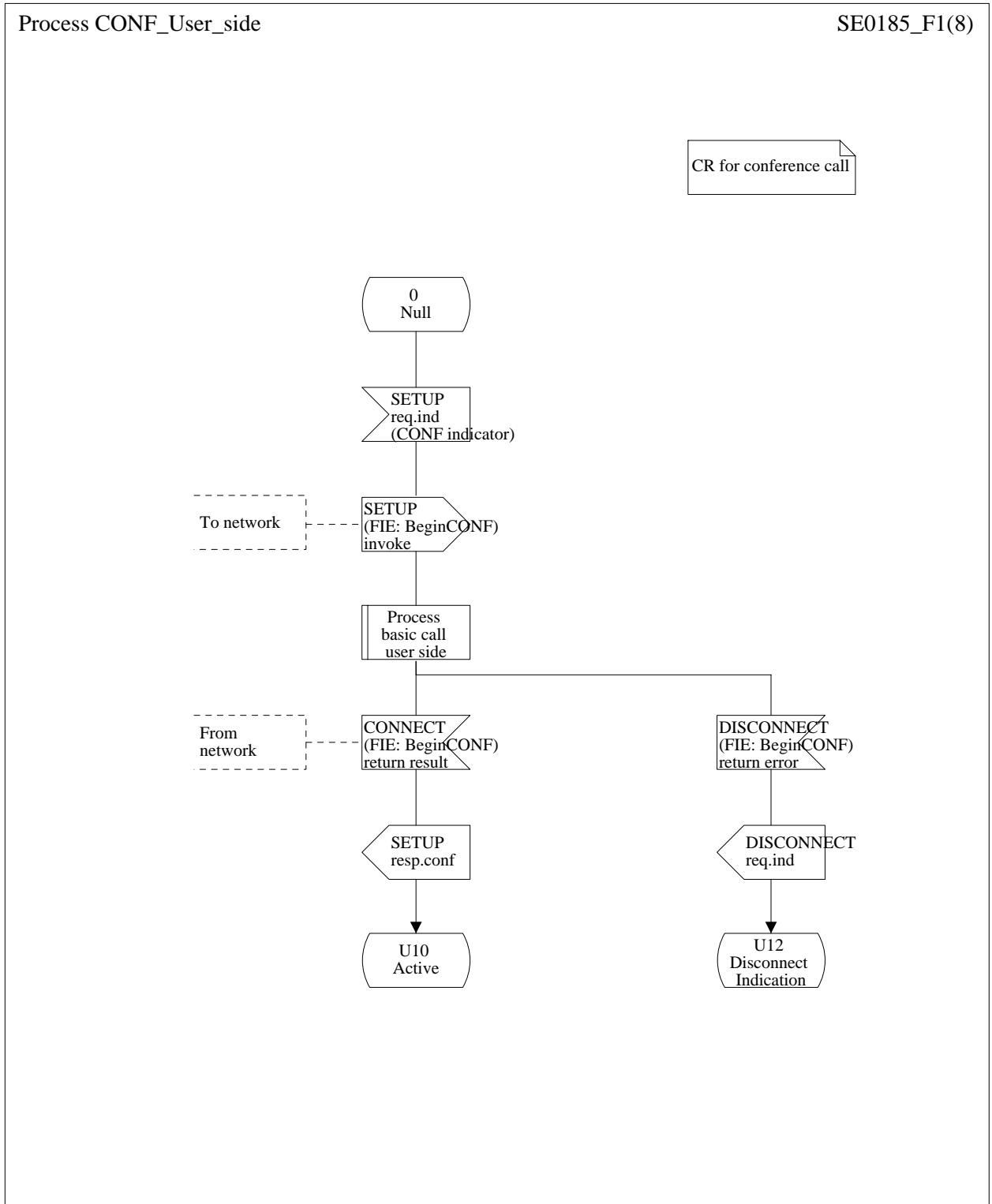

Figure 1: User-side SDL - Begin from Null call state

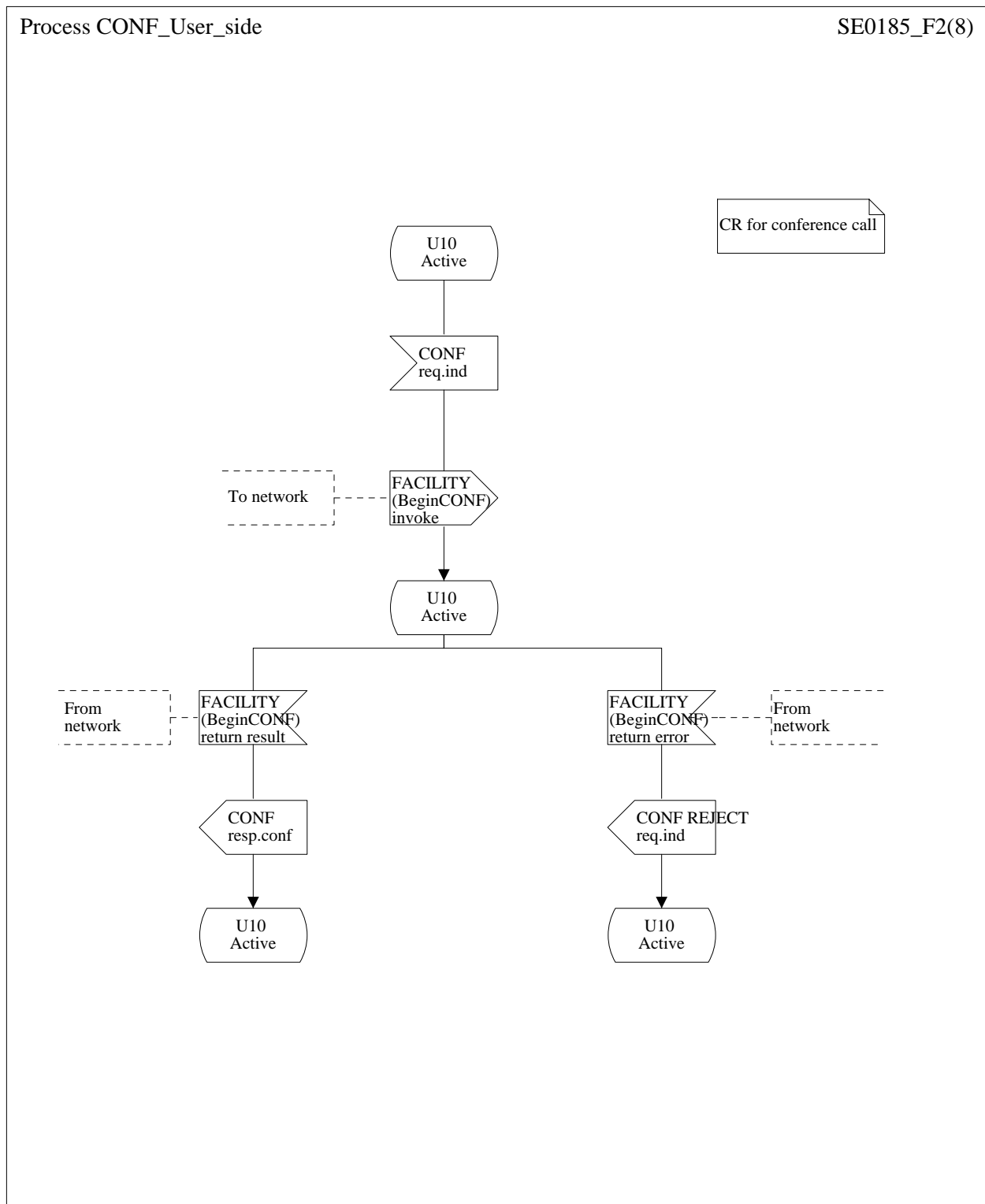

Figure 2: User-side SDL - Begin from Active call state

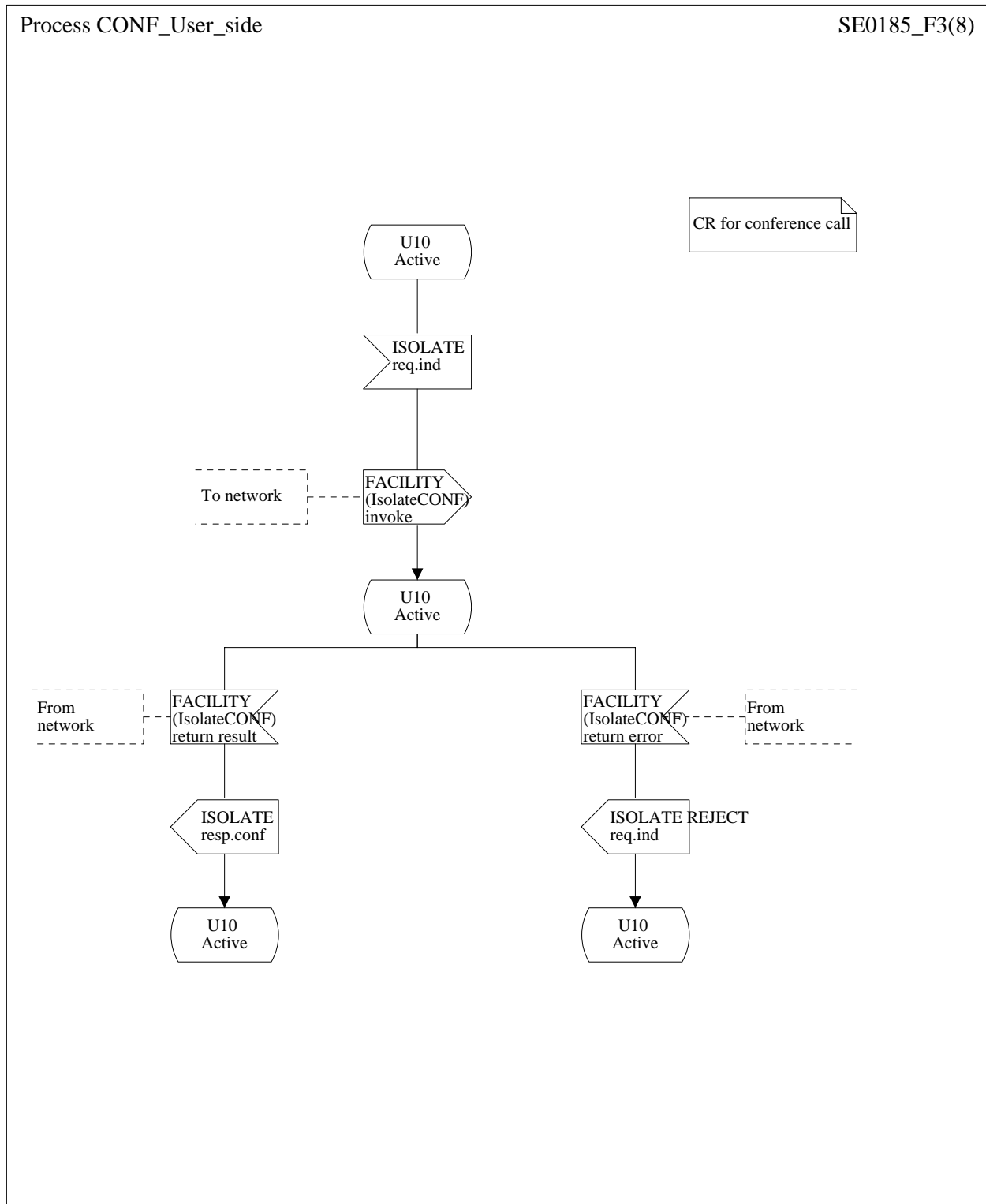

Figure 3: User-side SDL - ISOLATE

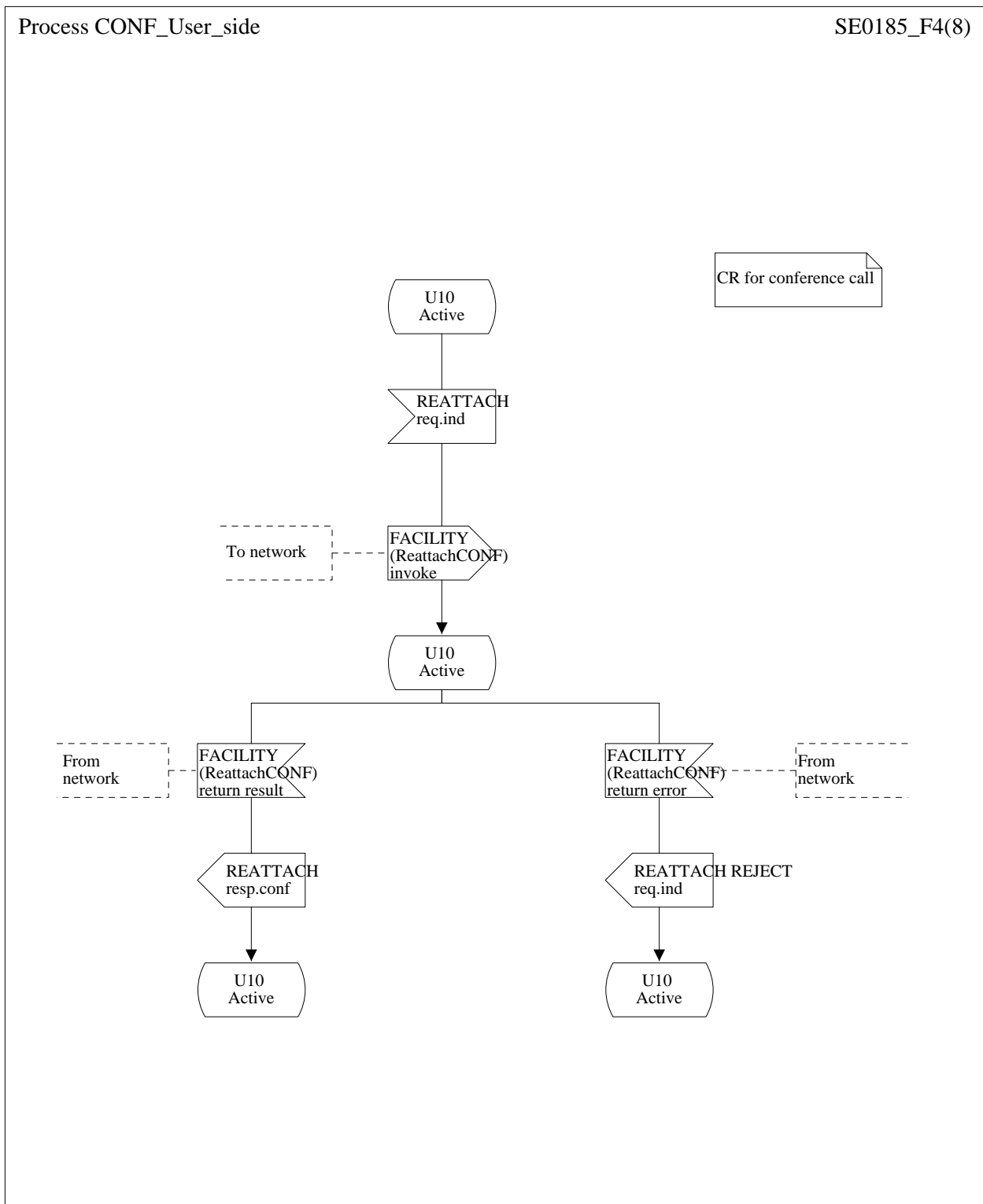

Figure 4: User-side SDL - REATTACH

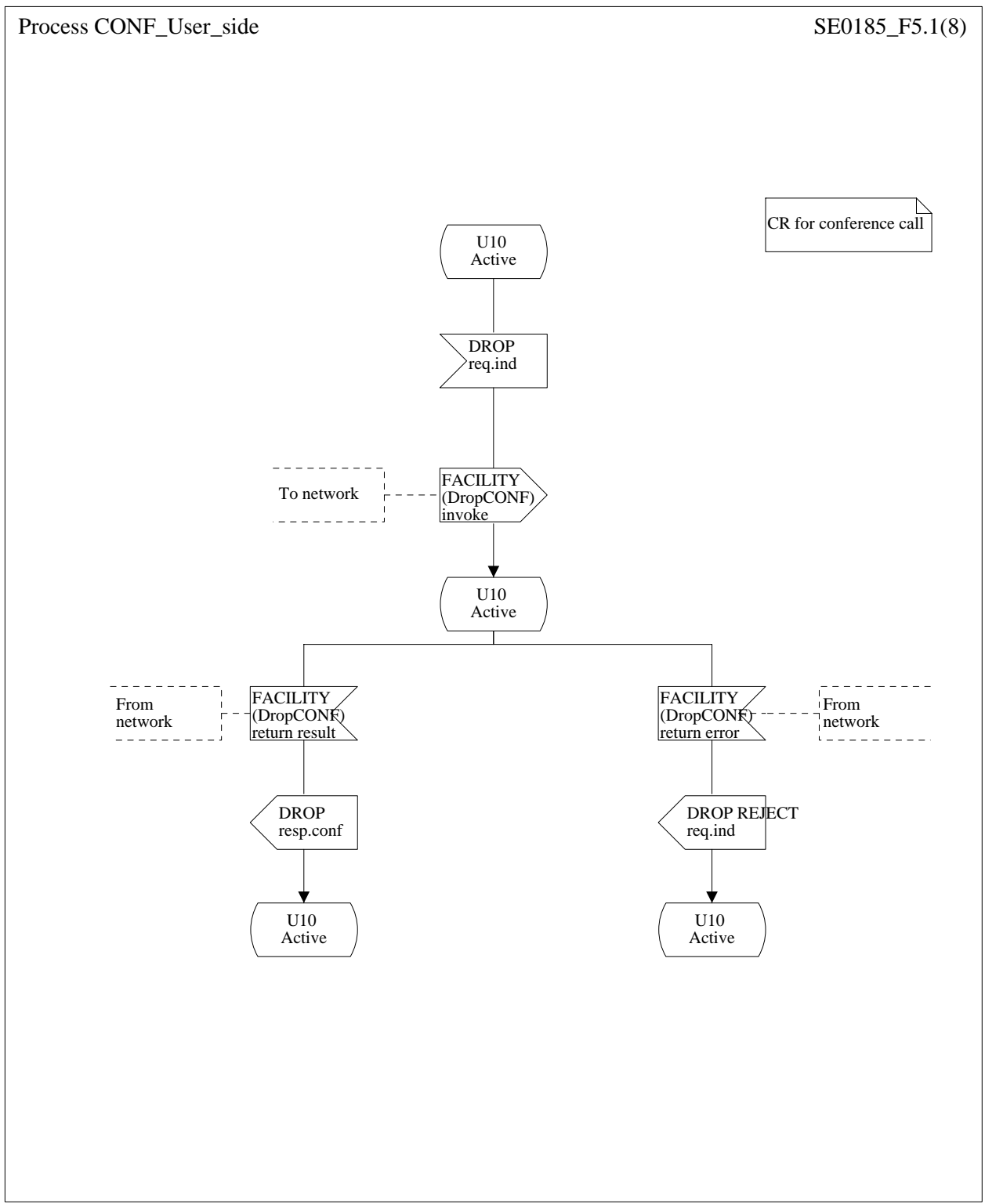

Figure 5 (sheet 1 of 2): User-side SDL - DROP

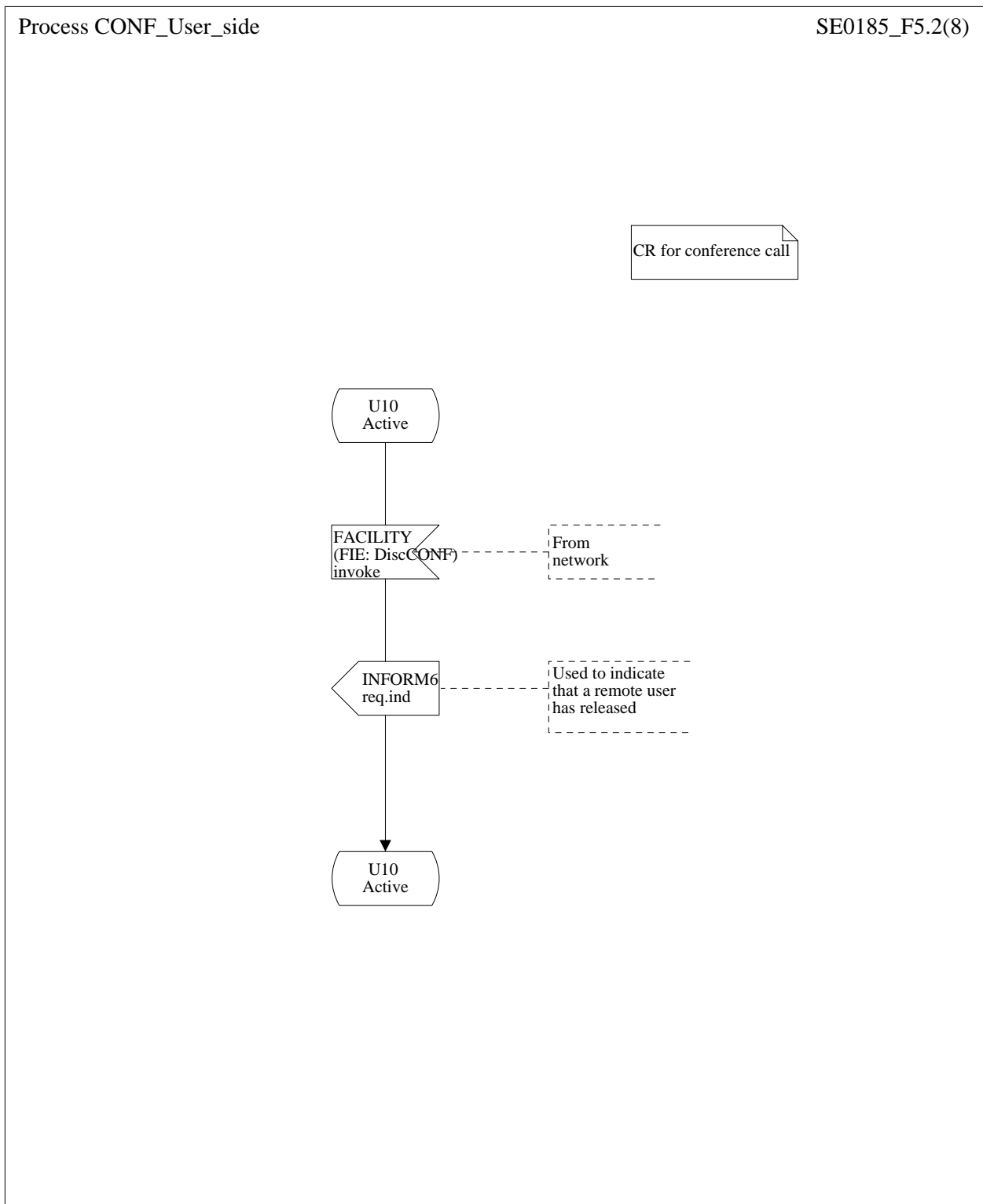

Figure 5 (sheet 2 of 2): User-side SDL - DISCONNECT

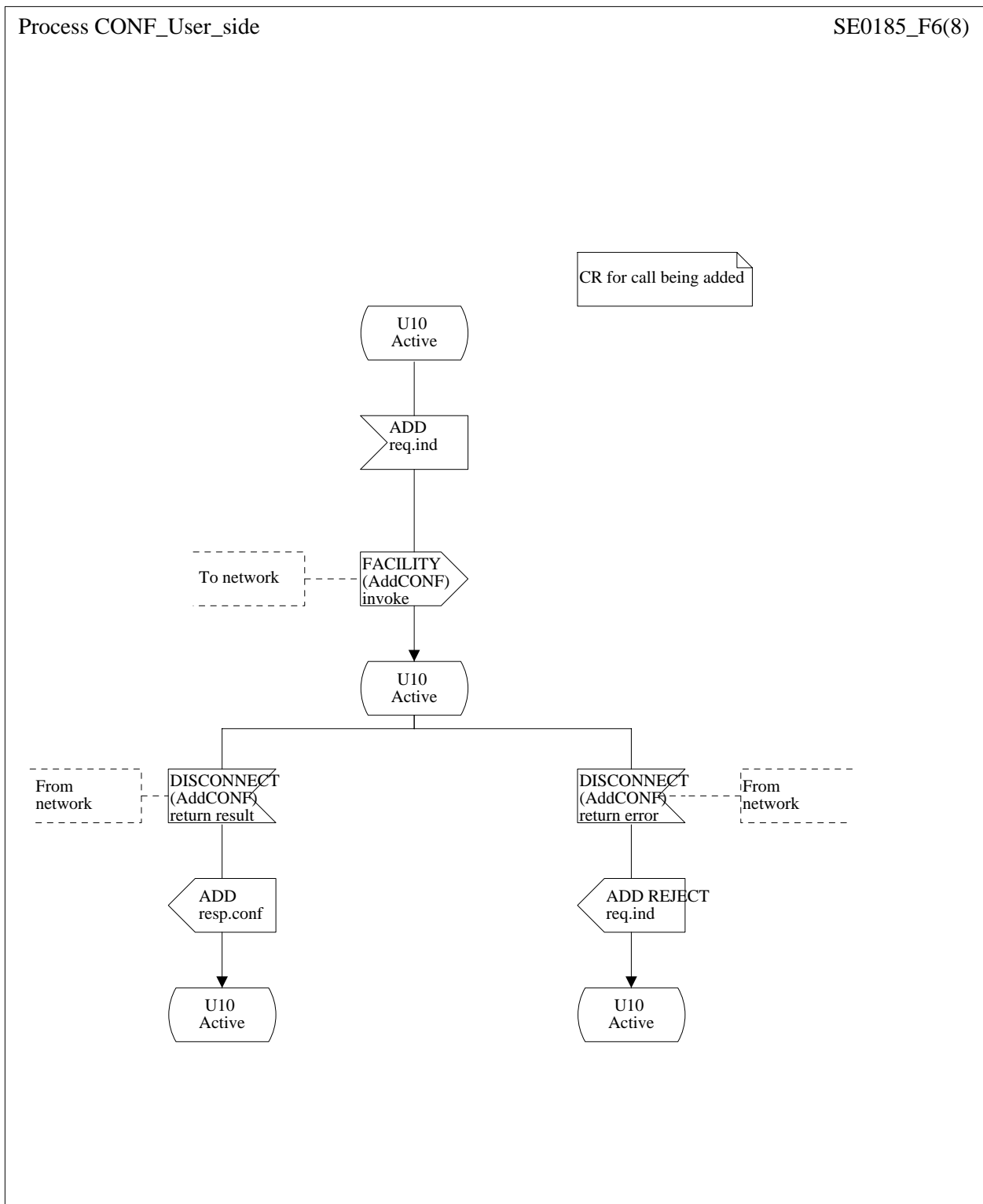

Figure 6: User-side SDL - ADD

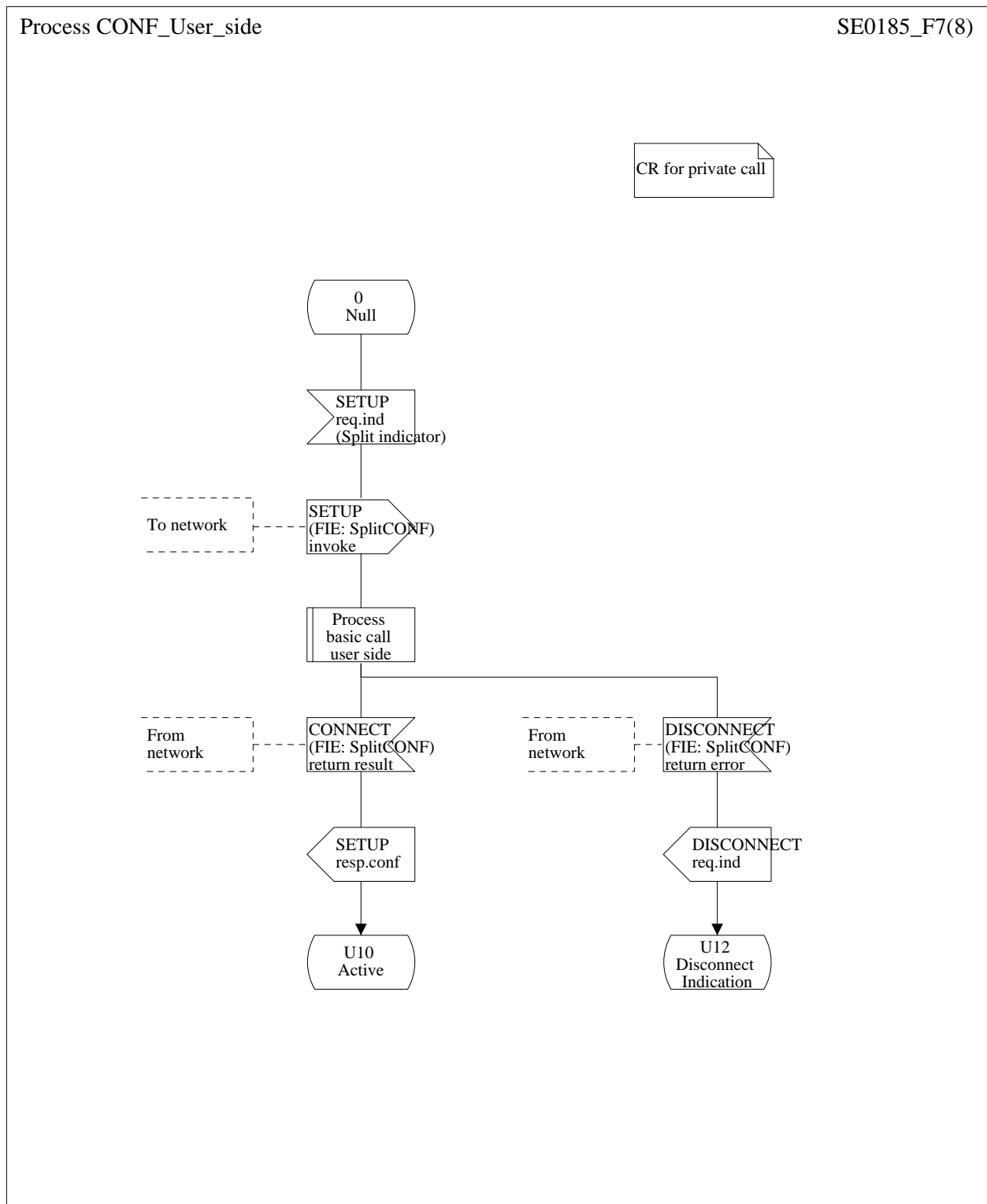

Figure 7: User-side SDL - SPLIT

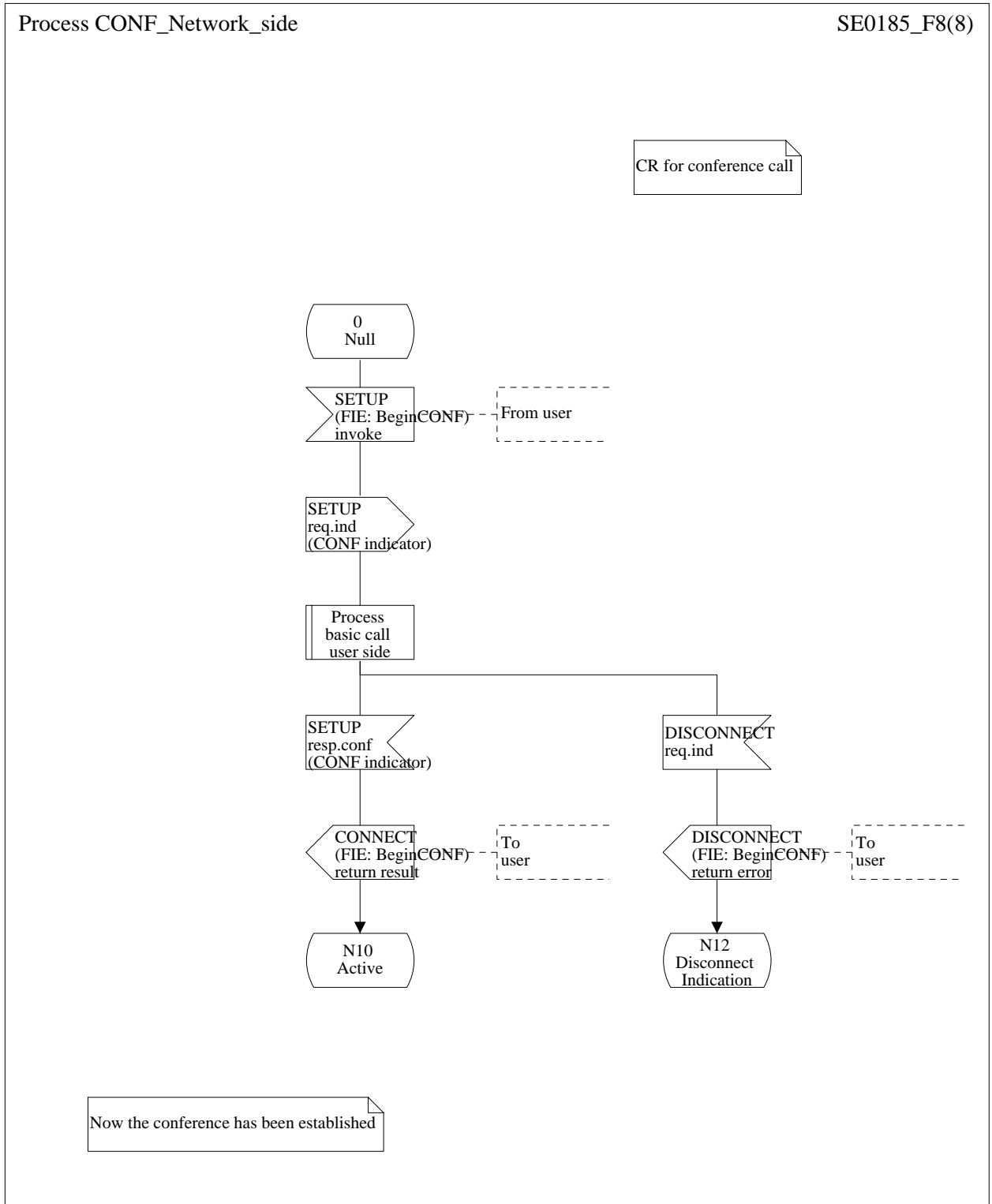

Figure 8: Network-side SDL - Begin from Null call state

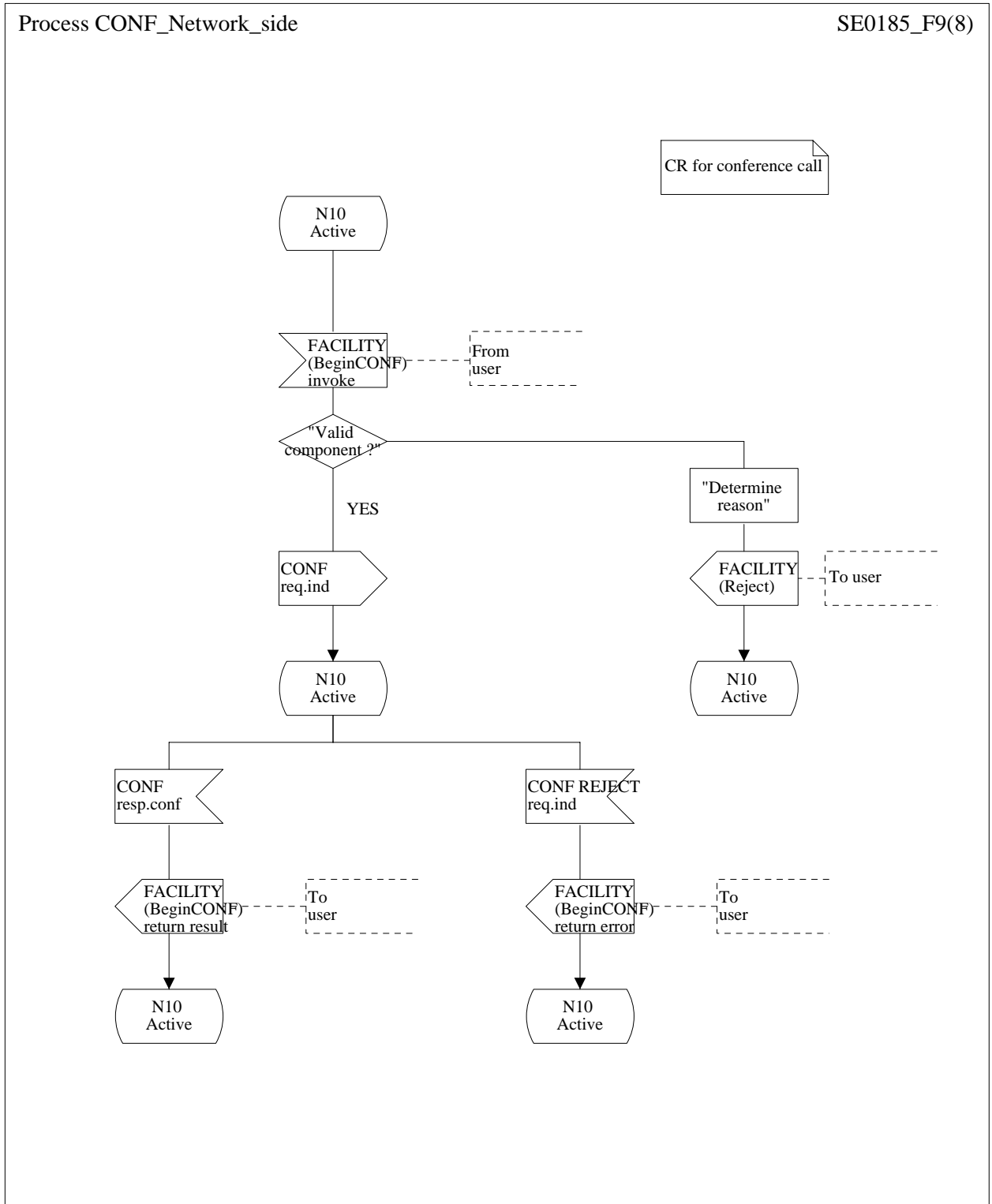

Figure 9: Network-side SDL - Begin from Active call state

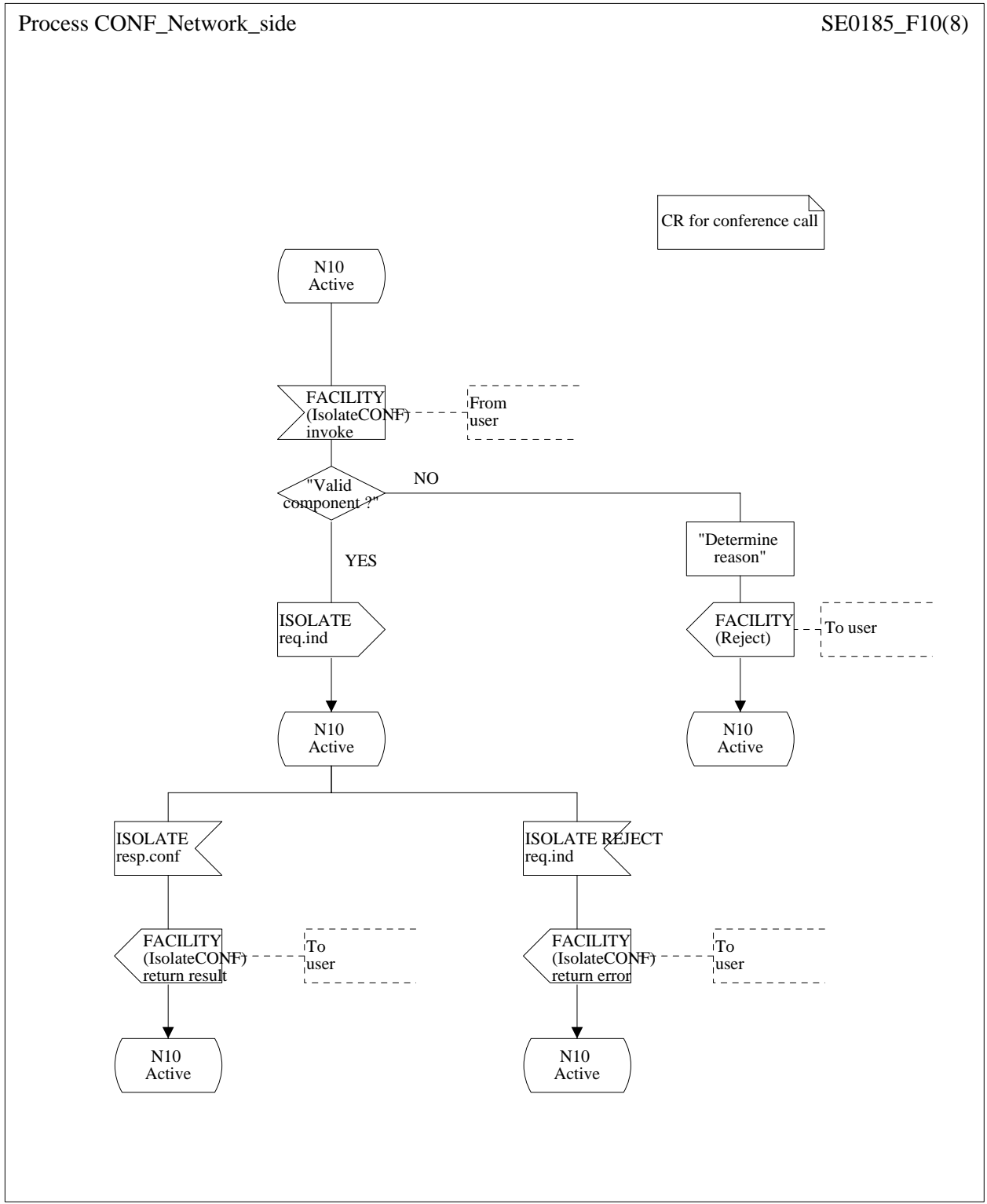

Figure 10: Network-side SDL - ISOLATE

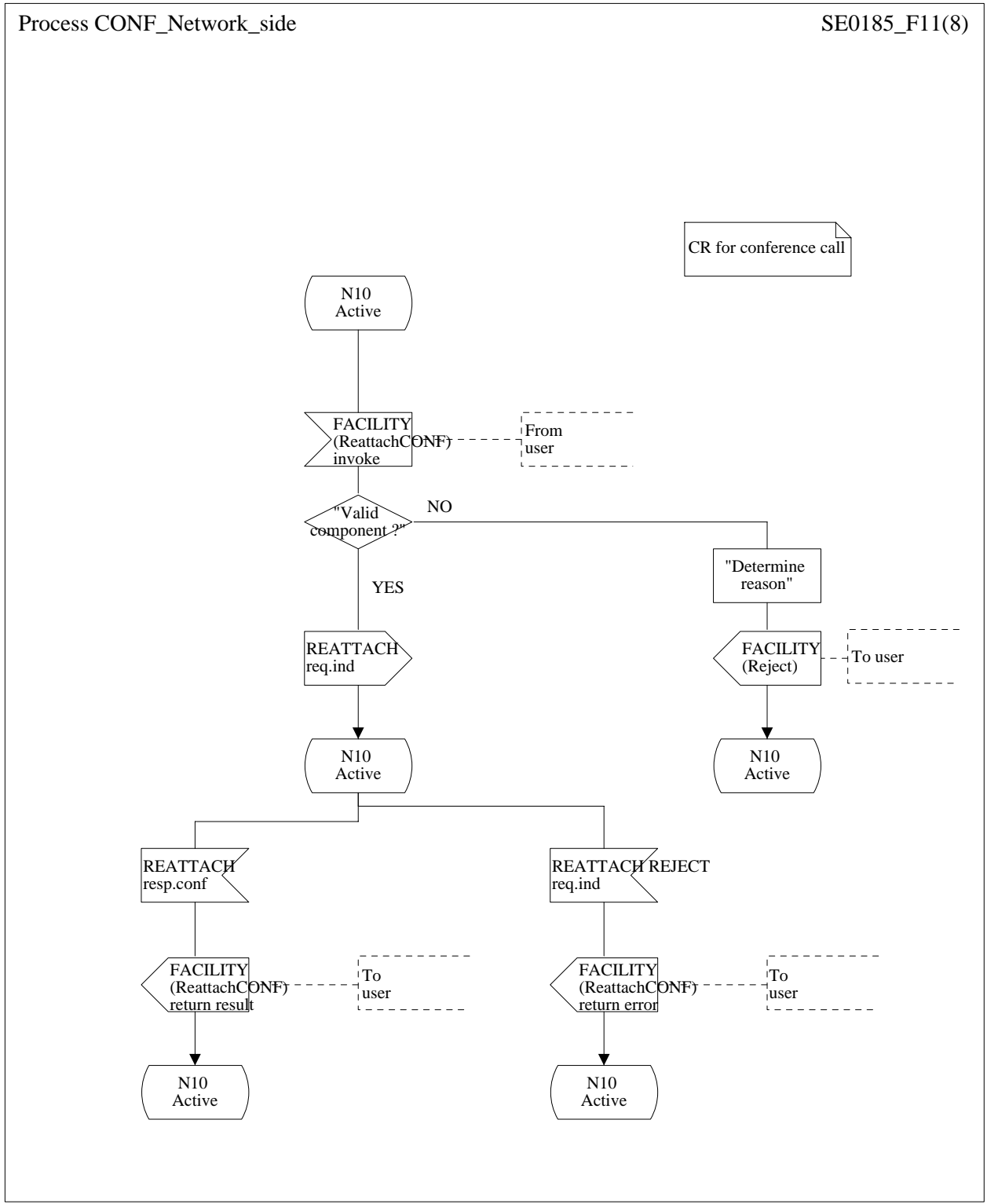

Figure 11: Network-side SDL - REATTACH

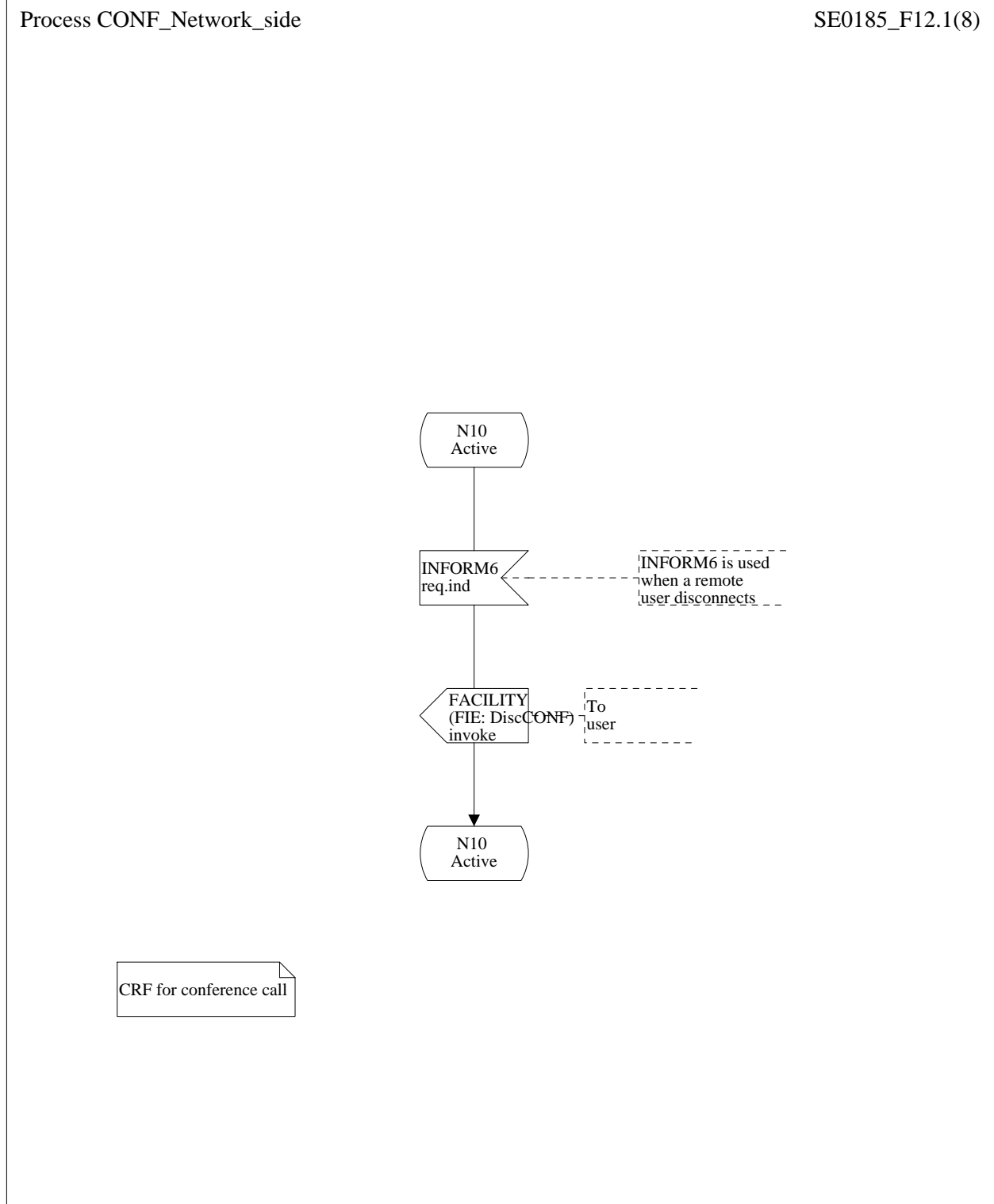

Figure 12 (sheet 1 of 2): Network-side SDL - DROP

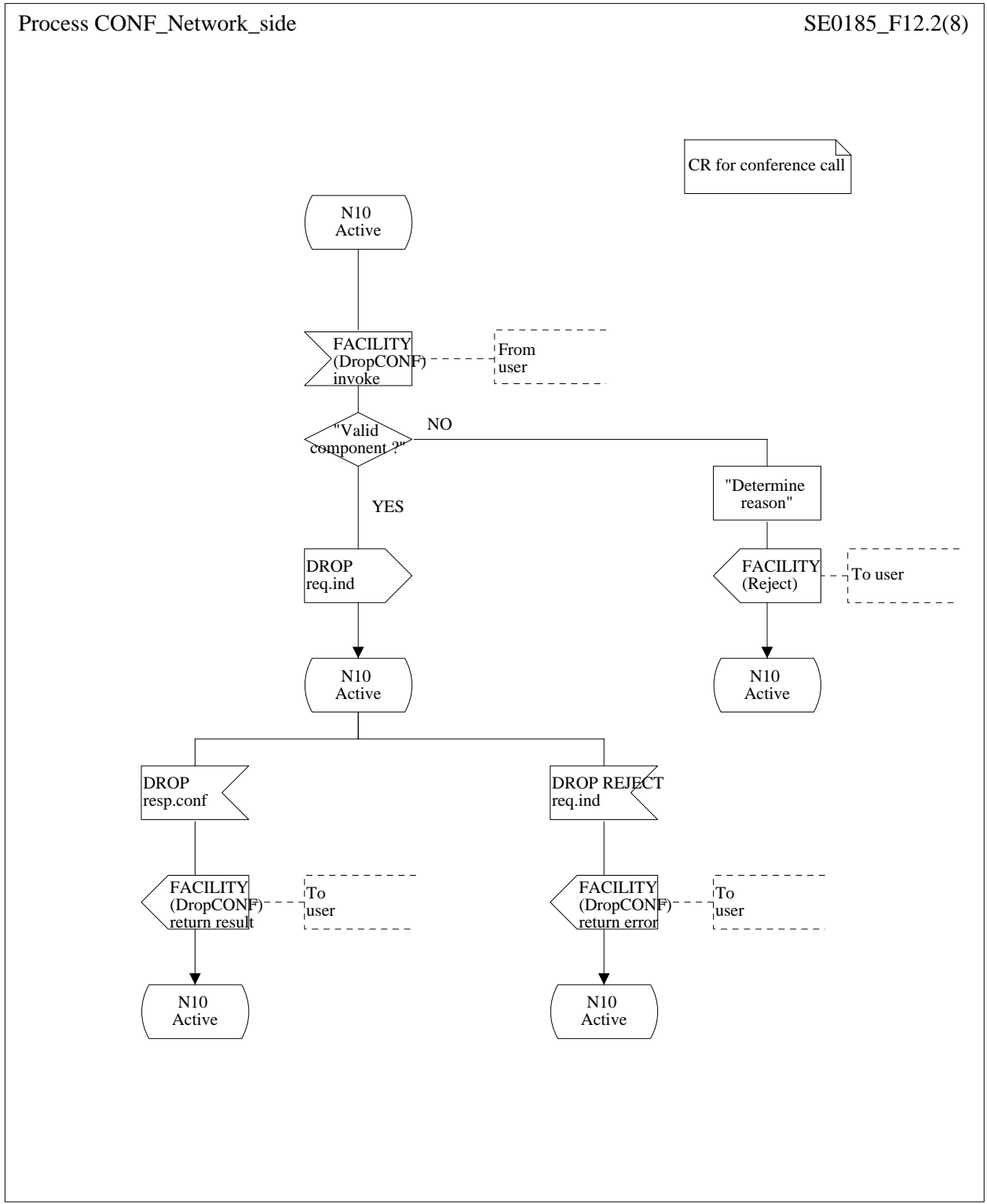

Figure 12 (sheet 2 of 2): Network-side SDL - DISCONNECT

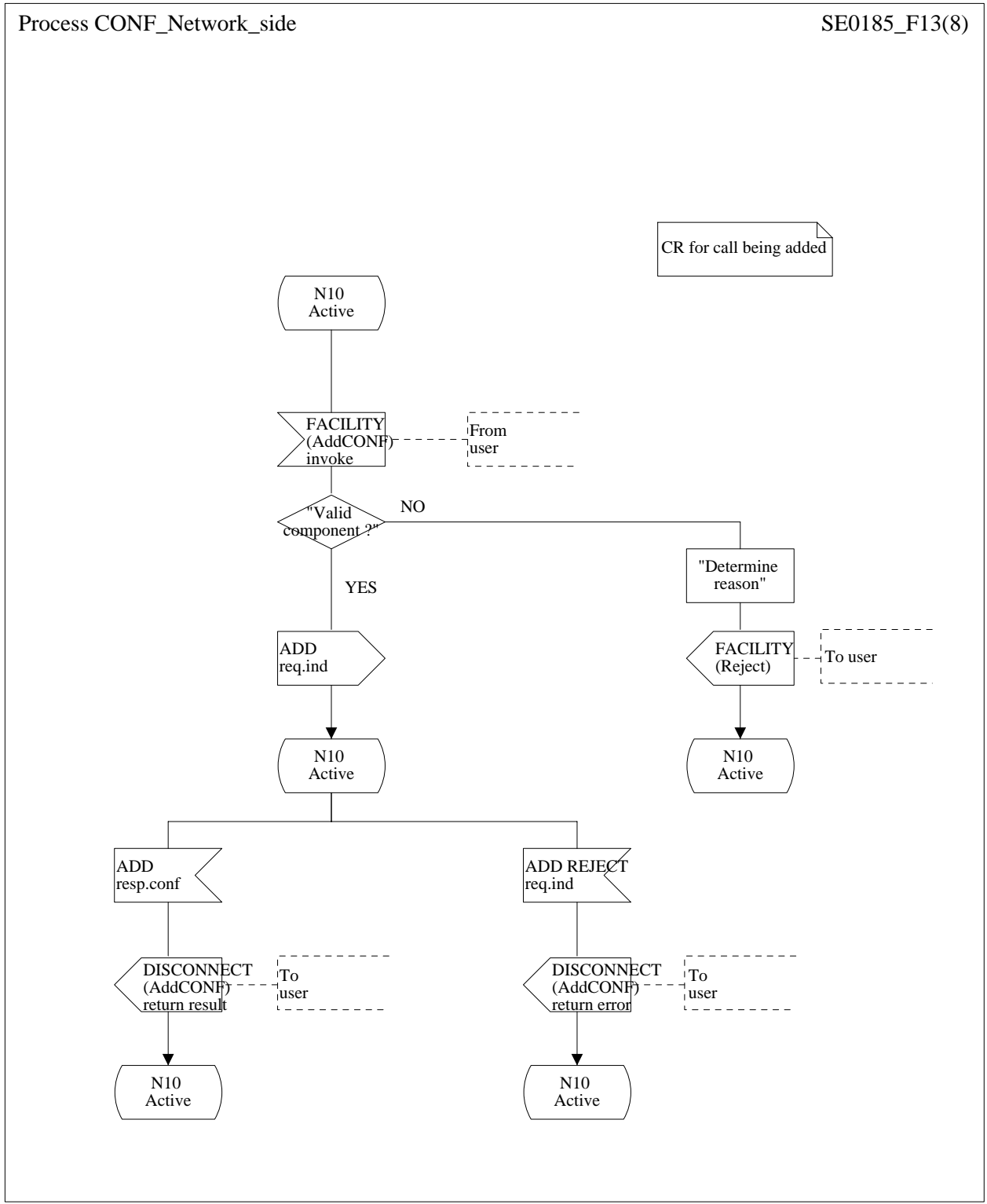

Figure 13: Network-side SDL - ADD

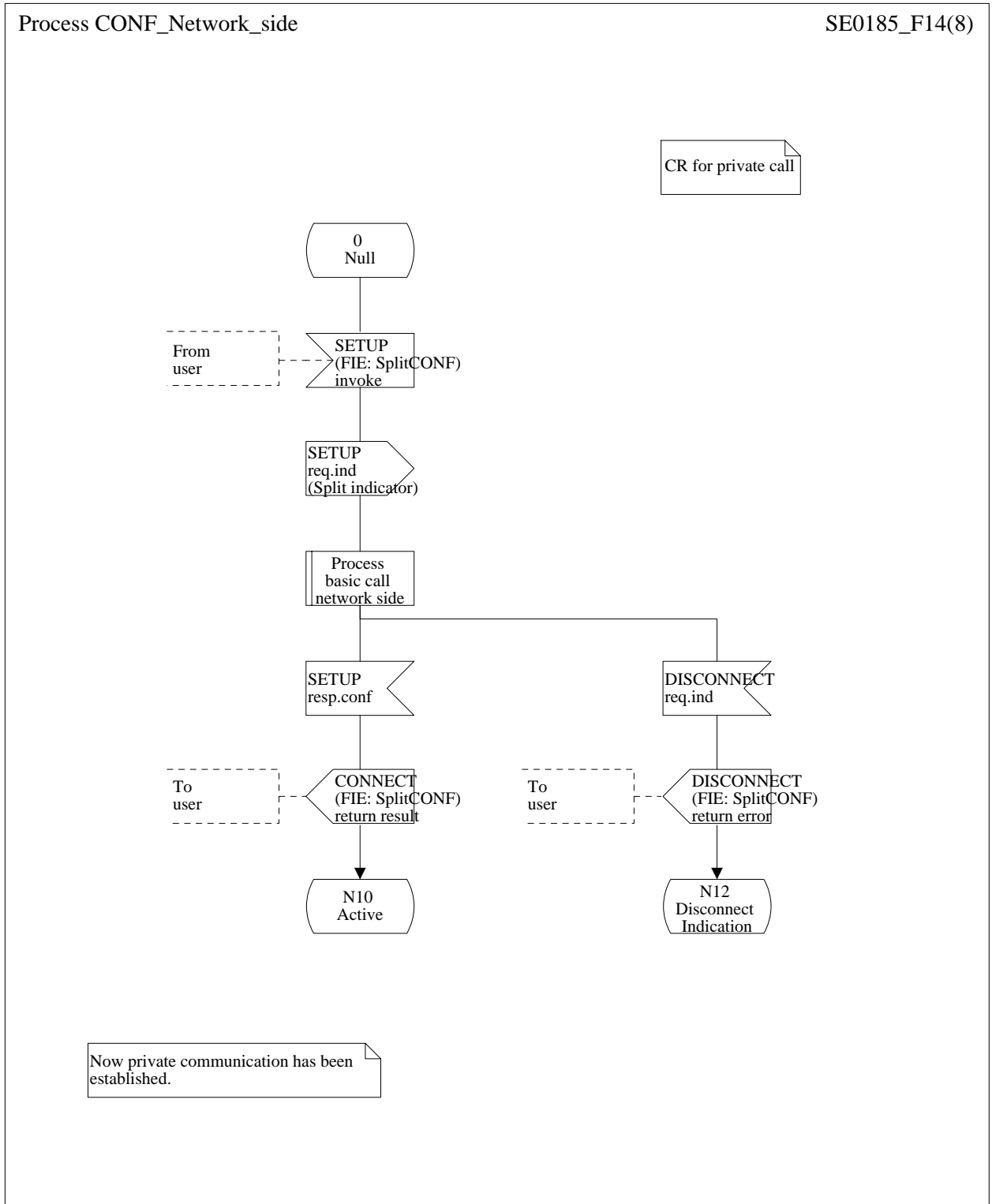

Figure 14: Network-side SDL - SPLIT

Annex A (informative): Signalling flows

The message flows for the CONF supplementary service are shown as follows:

- Figure A.1 Beginning a conference from the Null call state (U0);
- Figure A.2 Beginning a conference from the Active call state (U10);
- Figure A.3 Adding an existing call to the conference;
- Figure A.4 Adding an existing call - coincident S/T reference point procedures;
- Figure A.5 Adding a new call to the conference - T-reference point procedures;
- Figure A.6 Adding an incoming call to the conference - coincident S/T reference point procedures;
- Figure A.7 Isolate a remote user;
- Figure A.8 Reattach a remote user;
- Figure A.9 Split a remote user;
- Figure A.10 Disconnect remote user by served user;
- Figure A.11 Disconnect by remote user;
- Figure A.12 Clear the conference.

NOTE: Figures A.1 to A.12 use the identifiers X and N to identify remote users. Identifier X represents the remote user which is being explicitly identified by the conference controller. Identifier N represents the remainder of the remote parties not being identified by the conference controller.

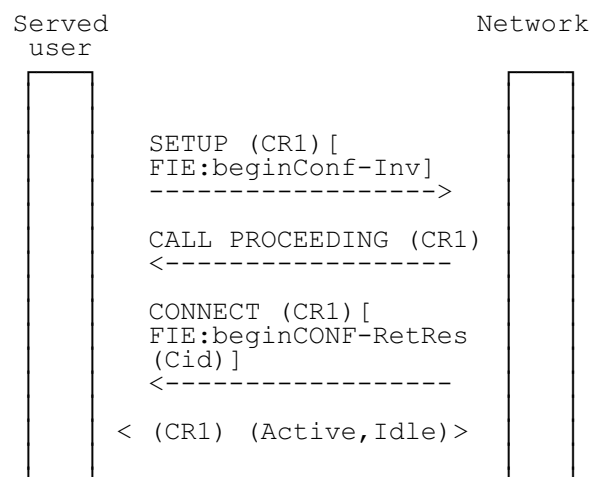

Figure A.1: Beginning a conference from the Null call state (U0)

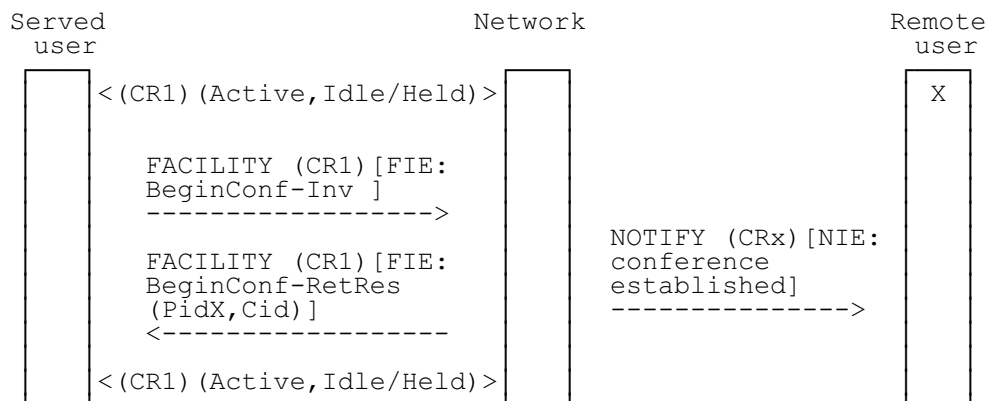

Figure A.2: Beginning a conference from the Active call state (U10)

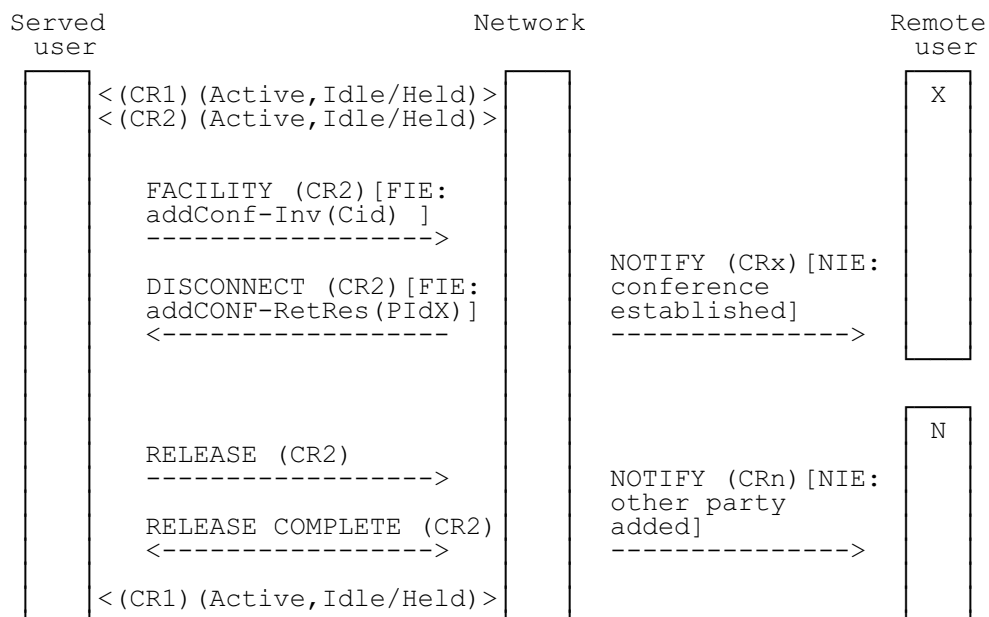
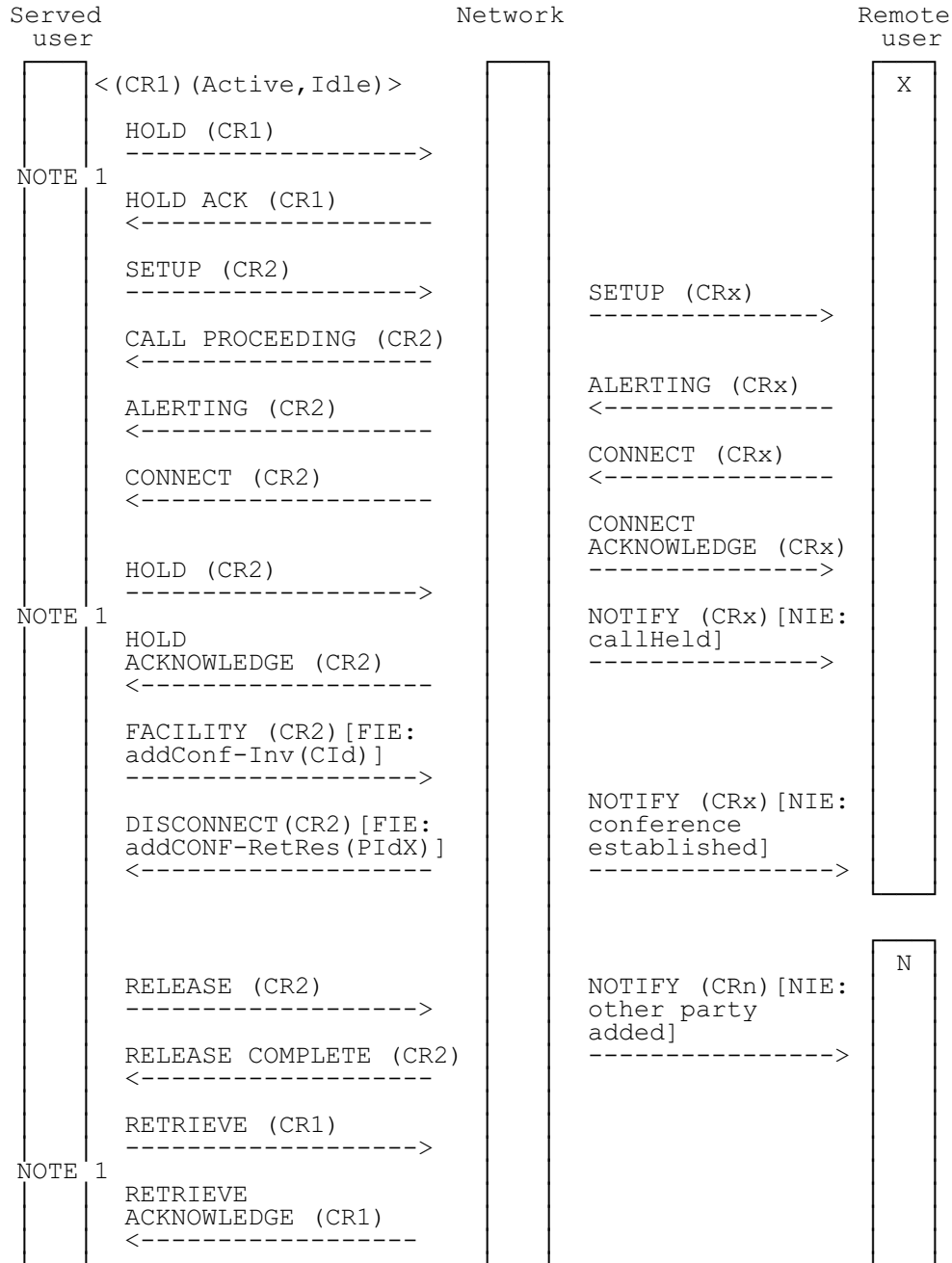

Figure A.3: Adding an existing call to the conference



NOTE 1: This example uses the call hold supplementary service. The call hold supplementary service is not an essential part of the CONF supplementary service.

NOTE 2: This example shows a possible procedure between the served user and the network at the coincident S/T reference point.

Figure A.4: Adding a new call to the conference - coincident S/T reference point procedure

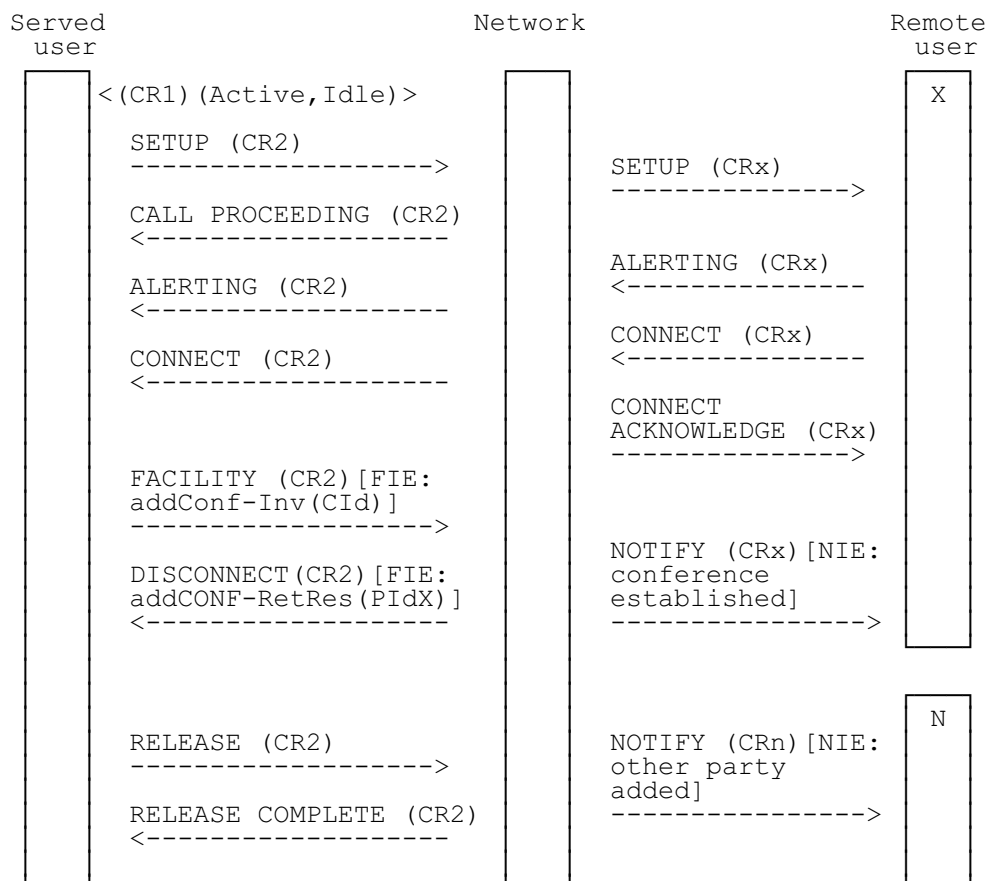

NOTE: This example is also valid at the coincident S/T reference point.

Figure A.5: Adding a new call to the conference - T-reference point procedures

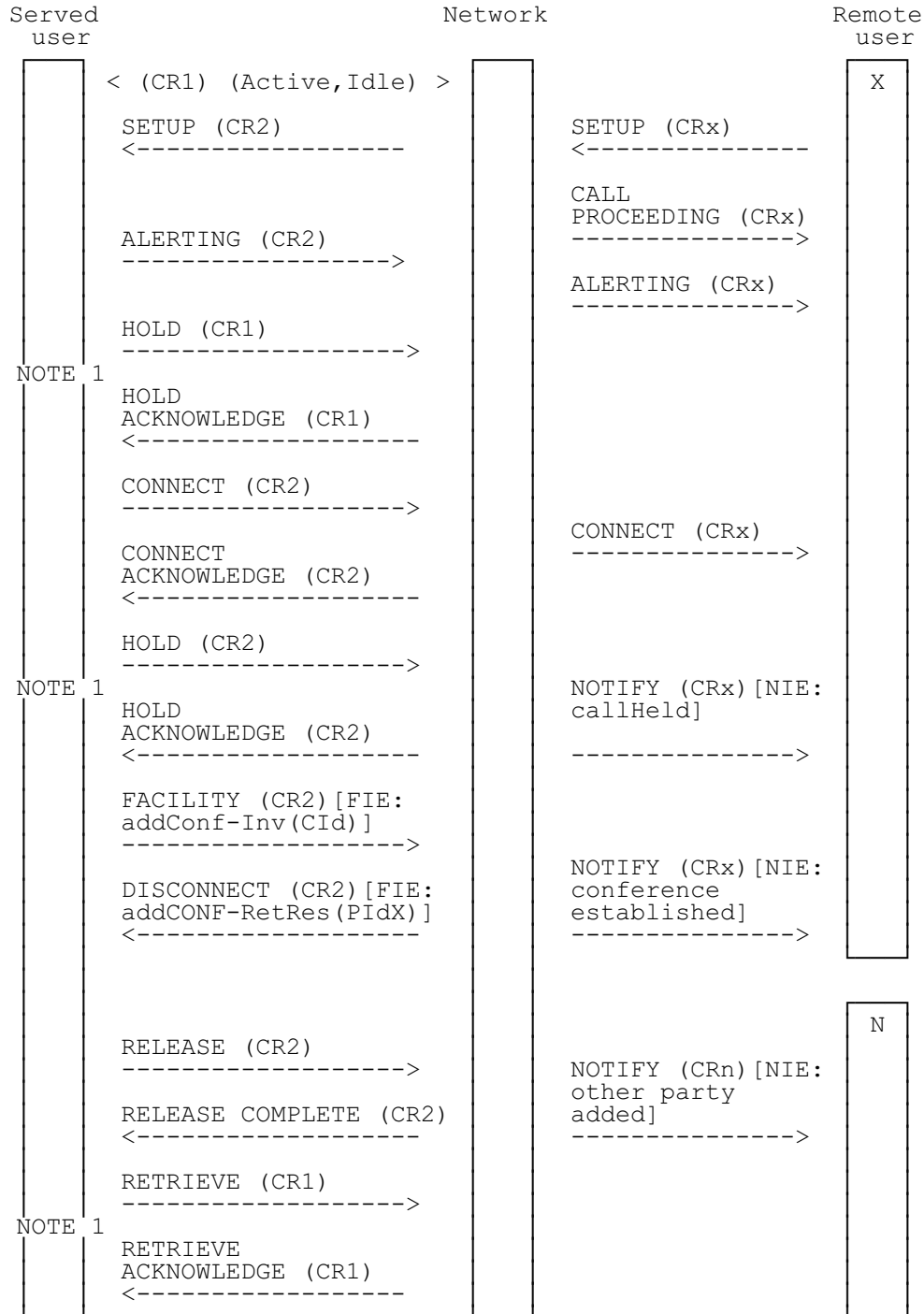

NOTE 1: This example uses the call hold supplementary service. The call hold supplementary service is not an essential part of the CONF supplementary service.

NOTE 2: This example shows a possible procedure between the served user and the network at the coincident S/T reference point.

Figure A.6: Adding an incoming call to the conference - coincident S/T reference point procedure

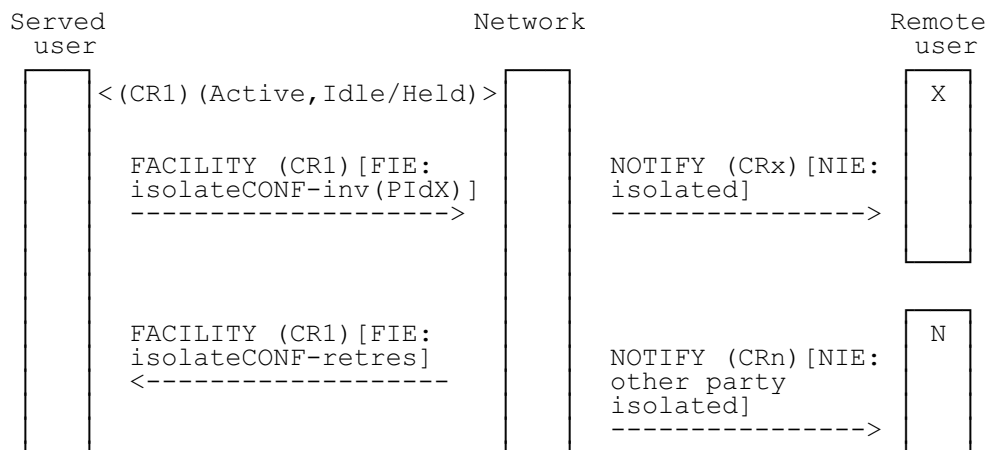

Figure A.7: Isolate a remote user

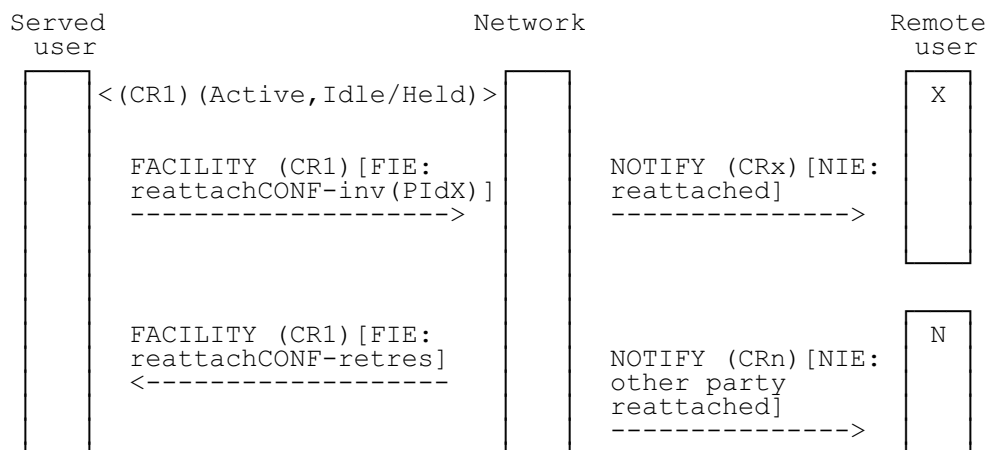

Figure A.8: Reattach a remote user

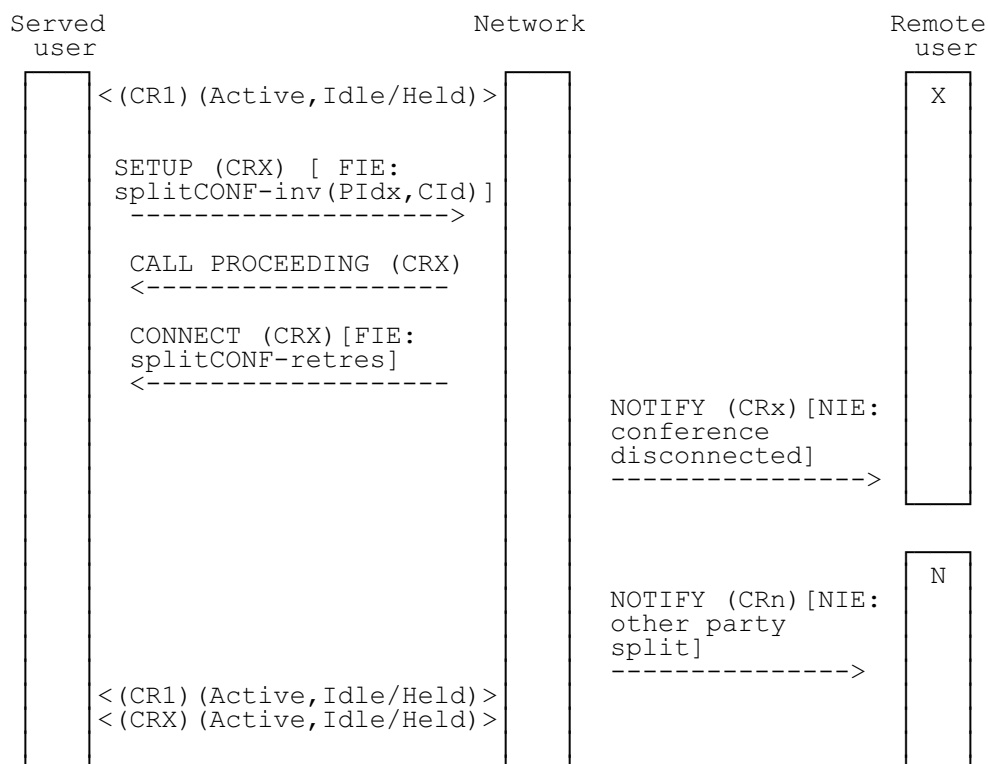

Figure A.9: Split a remote user

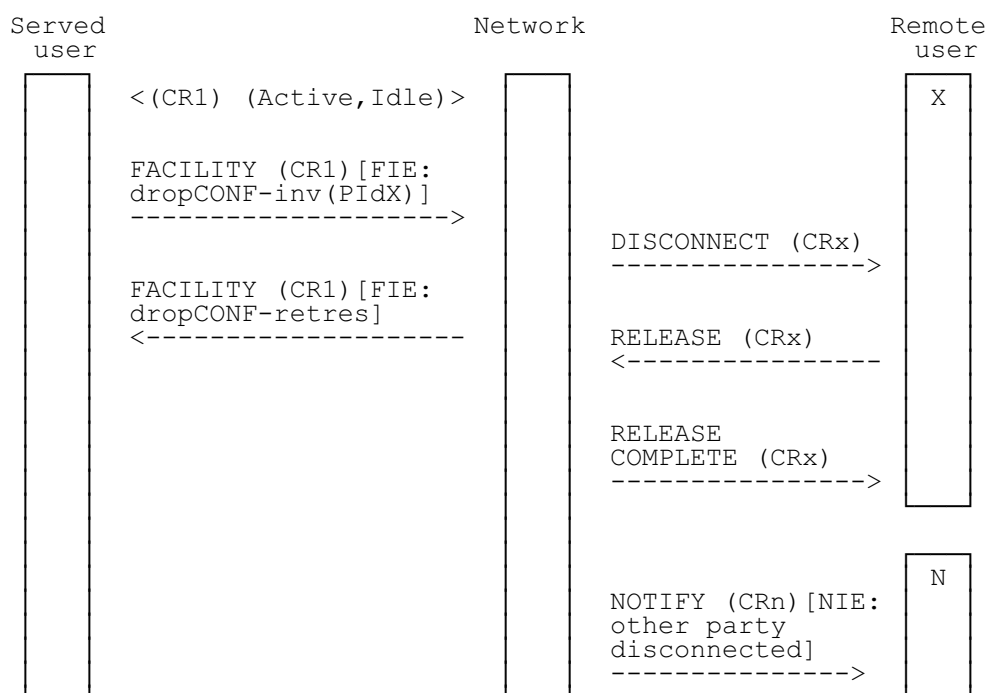

Figure A.10: Disconnect remote user by served user

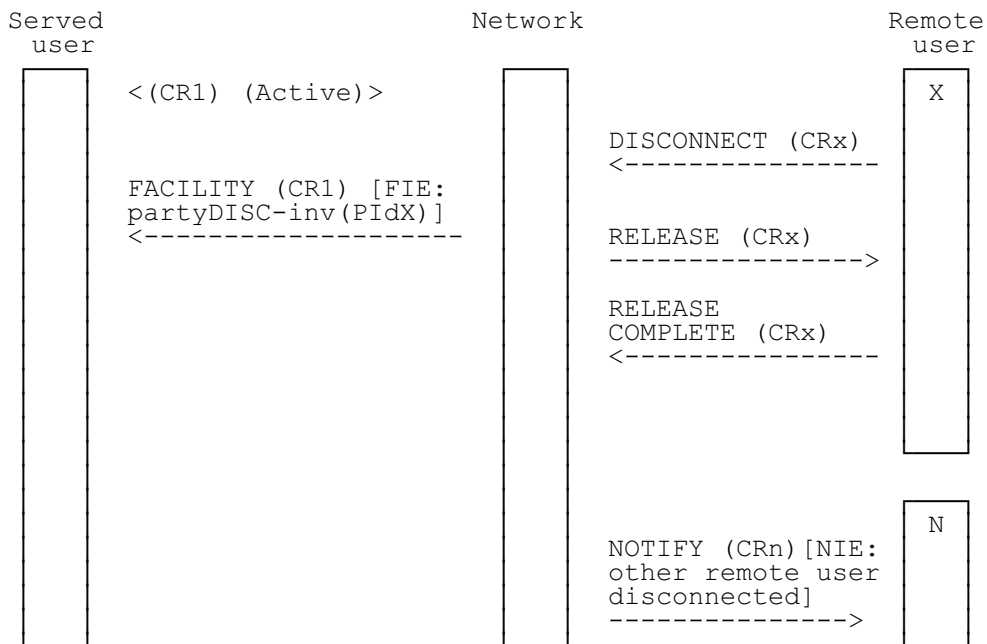

Figure A.11: Disconnect by remote user

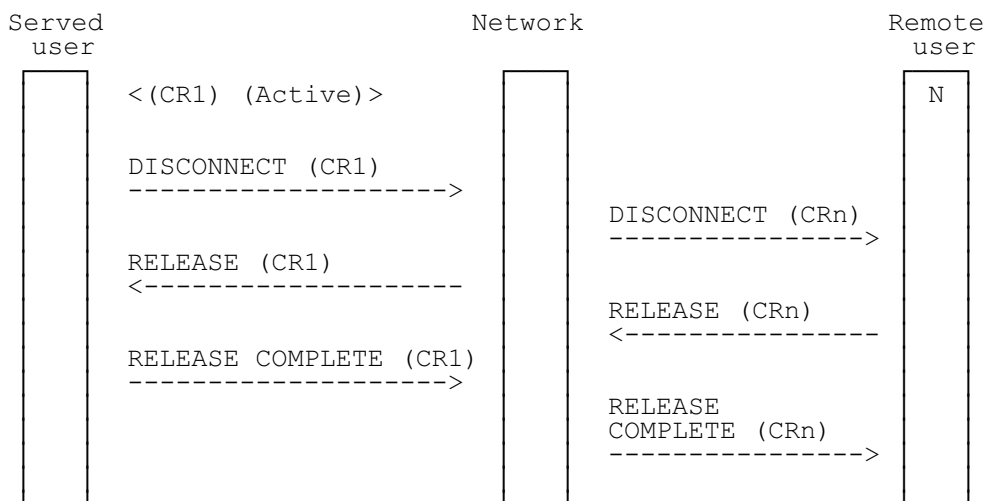

Figure A.12: Clear the conference

Annex B (informative): Changes with respect to the previous ETS 300 185-1

The following changes have been done:

- conversion to EN layout;
- replacement of references to ETS 300 102 with EN 300 403;
- substitution of non-specific references to basic standards where the intention is to refer to the latest version.

History

Document history		
Edition 1	April 1993	Publication as ETS 300 185-1
V1.2.3	February 1998	One-step Approval Procedure OAP 9824: 1998-02-13 to 1998-06-12
V1.2.4	June 1998	Publication