

Final draft **ETSI EN 300 175-6** V2.0.1 (2007-03)

European Standard (Telecommunications series)

**Digital Enhanced Cordless Telecommunications (DECT);
Common Interface (CI);
Part 6: Identities and addressing**



Reference

REN/DECT-000241-6

Keywords

DECT, Radio

ETSI

650 Route des Lucioles
F-06921 Sophia Antipolis Cedex - FRANCE

Tel.: +33 4 92 94 42 00 Fax: +33 4 93 65 47 16

Siret N° 348 623 562 00017 - NAF 742 C
Association à but non lucratif enregistrée à la
Sous-Préfecture de Grasse (06) N° 7803/88

Important notice

Individual copies of the present document can be downloaded from:

<http://www.etsi.org>

The present document may be made available in more than one electronic version or in print. In any case of existing or perceived difference in contents between such versions, the reference version is the Portable Document Format (PDF). In case of dispute, the reference shall be the printing on ETSI printers of the PDF version kept on a specific network drive within ETSI Secretariat.

Users of the present document should be aware that the document may be subject to revision or change of status. Information on the current status of this and other ETSI documents is available at

<http://portal.etsi.org/tb/status/status.asp>

If you find errors in the present document, please send your comment to one of the following services:

http://portal.etsi.org/chaicor/ETSI_support.asp

Copyright Notification

No part may be reproduced except as authorized by written permission.
The copyright and the foregoing restriction extend to reproduction in all media.

© European Telecommunications Standards Institute 2007.
All rights reserved.

DECTTM, **PLUGTESTS**TM and **UMTS**TM are Trade Marks of ETSI registered for the benefit of its Members.
TIPHONTM and the **TIPHON logo** are Trade Marks currently being registered by ETSI for the benefit of its Members.
3GPPTM is a Trade Mark of ETSI registered for the benefit of its Members and of the 3GPP Organizational Partners.

Contents

Intellectual Property Rights	5
Foreword.....	5
1 Scope	6
2 References	7
3 Definitions and abbreviations.....	7
3.1 Definitions	7
3.2 Abbreviations	8
4 General description of FP and PP identities	9
4.1 Combinations of ARIs, PARKs and IPUIs.....	10
5 FP identities.....	10
5.1 ARI class A	13
5.2 ARI class B.....	13
5.3 ARI class C.....	14
5.4 ARI class D	15
5.5 ARI class E.....	16
5.6 SARI list structure	17
5.6.1 ARI list length.....	17
5.6.2 TARIs	17
5.6.3 Black.....	17
5.6.4 ARI	18
5.6.5 Black-ARI.....	18
5.6.6 TARI messages	18
5.6.6.1 Request message from the PP	18
5.6.6.2 Response message from the FP.....	19
6 PP identities.....	20
6.1 PARK	21
6.1.1 PARK A.....	21
6.1.2 PARK B.....	21
6.1.3 PARK C.....	21
6.1.4 PARK D.....	21
6.1.5 PARK E.....	22
6.2 IPUI.....	22
6.2.1 Portable user identity type N (residential/default)	22
6.2.2 Portable user identity type S (PSTN/ISDN)	22
6.2.3 Portable user identity type O (private).....	23
6.2.4 Portable user identity type T (private extended).....	23
6.2.5 Portable user identity type P (public/public access service)	23
6.2.6 Portable user identity type Q (public/general)	24
6.2.7 Portable user identity type U (public/general)	24
6.2.8 Portable user identity type R (public/IMSI).....	24
6.3 Individual and group TPUIs	24
6.3.1 General.....	24
6.3.2 Individual TPUI.....	26
6.3.3 Group TPUIs.....	26
7 Coding of identities	27
7.1 RFPI E-bit	27
7.2 Access rights codes	27
7.3 Portable user identity types	27
7.4 EMC, EIC and POC	28
8 Rules for the usage of FP and PP identities.....	28
8.1 General principles.....	28

8.2	PARI, SARI and TARI usage.....	28
9	Connection related identities	30
9.1	MAC identities	30
9.1.1	FMID	30
9.1.2	PMID	30
9.2	DLC identities	31
9.3	NWK identities.....	31
10	Equipment related identities	31
11	Subscription and registration procedures	31
Annex A (informative): Examples of usage of FP and PP identities.....		32
A.1	Residential ID usage.....	32
A.2	Public ID usage	32
A.2.1	Primary	32
A.2.2	Secondary	33
A.2.3	Tertiary.....	33
A.3	Private ID usage	34
A.3.1	Primary	34
A.3.2	Secondary	34
A.4	Mixed private and public ID usage	34
A.4.1	Public in private environments.....	34
A.4.2	Private in public environments.....	35
A.5	PARI and SARI use for CTM roaming	35
Annex B (normative): Identities and addressing timers.....		37
Annex C (normative): Representation of IPEI as printed text		38
Annex D (informative): Bibliography.....		39
Annex E (informative): Change history		40
History		41

Intellectual Property Rights

IPRs essential or potentially essential to the present document may have been declared to ETSI. The information pertaining to these essential IPRs, if any, is publicly available for **ETSI members and non-members**, and can be found in ETSI SR 000 314: "*Intellectual Property Rights (IPRs); Essential, or potentially Essential, IPRs notified to ETSI in respect of ETSI standards*", which is available from the ETSI Secretariat. Latest updates are available on the ETSI Web server (<http://webapp.etsi.org/IPR/home.asp>).

Pursuant to the ETSI IPR Policy, no investigation, including IPR searches, has been carried out by ETSI. No guarantee can be given as to the existence of other IPRs not referenced in ETSI SR 000 314 (or the updates on the ETSI Web server) which are, or may be, or may become, essential to the present document.

Foreword

This European Standard (Telecommunications series) has been produced by ETSI Project Digital Enhanced Cordless Telecommunications (DECT), and is now submitted for the ETSI standards One-step Approval Procedure.

The present document is part 6 of a multi-part deliverable. Full details of the entire series can be found in part 1 [1].

Further details of the DECT system may be found in TR 101 178 and ETR 043 (see bibliography).

Proposed national transposition dates	
Date of latest announcement of this EN (doa):	3 months after ETSI publication
Date of latest publication of new National Standard or endorsement of this EN (dop/e):	6 months after doa
Date of withdrawal of any conflicting National Standard (dow):	6 months after doa

1 Scope

The present document is one of the parts of the specification of the Digital Enhanced Cordless Telecommunications (DECT) Common Interface (CI).

This part specifies the identities and addressing structure of the Digital Enhanced Cordless Telecommunications (DECT) Common Interface (CI).

There are four categories of identities to be used for identification and addressing in a general DECT environment. These four categories are:

- Fixed Part (FP) identities;
- Portable Part (PP) identities;
- connection-related identities;
- equipment-related identities.

Fixed part identities and portable part identities are used for:

- access information from fixed parts to portable parts;
- access requests from portable parts;
- identification of portable parts;
- identification of fixed parts and radio fixed parts;
- paging;
- billing.

These identities support:

- different environments, such as residential, public or private;
- supply to manufacturers, installers, and operators of globally unique identity elements with a minimum of central administration;
- multiple access rights for the same portable;
- large freedom for manufacturers, installers, and operators to structure the fixed part identities, e.g. to facilitate provision of access rights to groups of DECT systems;
- roaming agreements between DECT networks run by the same or different owners/operators;
- indication of handover domains;
- indication of location areas, i.e. paging area;
- indication of subscription areas of a public service.

The present document also provides for length indicators and other messages that can override the default location and/or paging area and domain indications given by the structure of the identities.

Connection related identities are used to identify the protocol instances associated with a call and are used for peer-to-peer communication.

Equipment related identities are used to identify a stolen PP and to derive a default identity coding for PP emergency call set-up.

Coding of identity information elements for higher layer messages is found in EN 300 175-5 [5], clause 7.7.

User authentication and ciphering need additional key information and is outside the scope of the present document, but is covered in other parts of EN 300 175 [1] to [7], e.g. EN 300 175-7 [6].

The present document includes New Generation DECT, a further development of the DECT standard introducing wideband speech, improved data services, new slot types and other technical enhancements.

2 References

The following documents contain provisions which, through reference in this text, constitute provisions of the present document.

- References are either specific (identified by date of publication and/or edition number or version number) or non-specific.
- For a specific reference, subsequent revisions do not apply.
- For a non-specific reference, the latest version applies.

Referenced documents which are not found to be publicly available in the expected location might be found at <http://docbox.etsi.org/Reference>.

NOTE: While any hyperlinks included in this clause were valid at the time of publication ETSI cannot guarantee their long term validity.

- [1] ETSI EN 300 175-1: "Digital Enhanced Cordless Telecommunications (DECT); Common Interface (CI); Part 1: Overview".
- [2] Void.
- [3] ETSI EN 300 175-3: "Digital Enhanced Cordless Telecommunications (DECT); Common Interface (CI); Part 3: Medium Access Control (MAC) layer".
- [4] ETSI EN 300 175-4: "Digital Enhanced Cordless Telecommunications (DECT); Common Interface (CI); Part 4: Data Link Control (DLC) layer".
- [5] ETSI EN 300 175-5: "Digital Enhanced Cordless Telecommunications (DECT); Common Interface (CI); Part 5: Network (NWK) layer".
- [6] ETSI EN 300 175-7: "Digital Enhanced Cordless Telecommunications (DECT); Common Interface (CI); Part 7: Security features".
- [7] ETSI EN 300 175-8: "Digital Enhanced Cordless Telecommunications (DECT); Common Interface (CI); Part 8: Speech coding and transmission".
- [8] ITU-T Recommendation E.164: "The international public telecommunication numbering plan".
- [9] Void.
- [10] ITU-T Recommendation E.212: "The international identification plan for mobile terminals and mobile users".

3 Definitions and abbreviations

3.1 Definitions

For the purposes of the present document, the terms and definitions given in EN 300 175-1 [1] apply.

3.2 Abbreviations

For the purposes of the present document, the following abbreviations apply:

ARC	Access Rights Class
ARD	Access Rights Details
ARI	Access Rights Identity
BACN	Bank ACcount Number
BCD	Binary Coded Decimal
CBI	Collective Broadcast Identifier
CI	Common Interface
CMD	CoMmanD bit
CTM	Cordless Terminal Mobility
DECT	Digital Enhanced Cordless Telecommunications
DLC	Data Link Control
EIC	Equipment Installer's Code
EMC	Equipment Manufacturer's Code
FIL	FILl bits
FMID	Fixed part MAC Identity
FP	Fixed Part
FPN	Fixed Part Number
FPS	Fixed Part Sub-number
FT	Fixed radio Termination
GOP	GSM OPerator code
GSM	Global System for Mobile
ID	Identification
IMSI	International Mobile Subscriber Identity
IPEI	International Portable Equipment Identity
IPUI	International Portable User Identity
ISDN	Integrated Services Digital Network
LA	Location Area
LAI	Location Area Identification
LAL	Location Area Level
LAN	Local Area Network
lsb	least significant bit
LSIG	Link SIGnature
MAC	Medium Access Control
MCC	Mobile Country Code
msb	most significant bit
N_T	Identities information, one N-channel message
NWK	NetWorK
PABX	Private Automatic Branch eXchange
PARI	Primary Access Rights Identity
PARK	Portable Access Rights Key
PARK{y}	PARK with value y for its park length indicator
PBX	Private Branch eXchange
PHL	PHysical Layer
PLI	Park Length Indicator
PLMN-Id	Public Land Mobile Network Identification
PMID	Portable part MAC IDentity
POC	Public Operator Code
PP	Portable Part
PSN	Portable equipment Serial Number

PSTN	Public Switched Telephone Network
PT	Portable radio Termination
PUN	Portable User Number
PUT	Portable User Type
Q _H	Q field header
Q _T	System information and multiframe marker
RFP	Radio Fixed Part
RFPI	Radio Fixed Part Identity
RPN	Radio fixed Part Number
SARI	Secondary Access Rights Identity
SP-id	Service Provider identity
TARI	Tertiary Access Rights Identity
TPUI	Temporary Portable User Identity
UMTS	Universal Mobile Telecommunication Systems
WRS	Wireless Relay Station

4 General description of FP and PP identities

Every radio FP broadcasts for its purpose a unique identity which contains a globally unique (to a service provider) Access Rights Identity (ARI). Every PP has both a Portable Access Rights Key (PARK) and an International Portable User Identity (IPUI). These operate as a pair. A PP is allowed to access any radio FP which broadcasts an ARI that can be identified by any of the portable access rights keys of that PP.

The IPUI is used to identify the portable in the domain defined by its related ARI. The IPUI can either be locally unique or globally unique.

Figure 4.1 illustrates the identity structure.

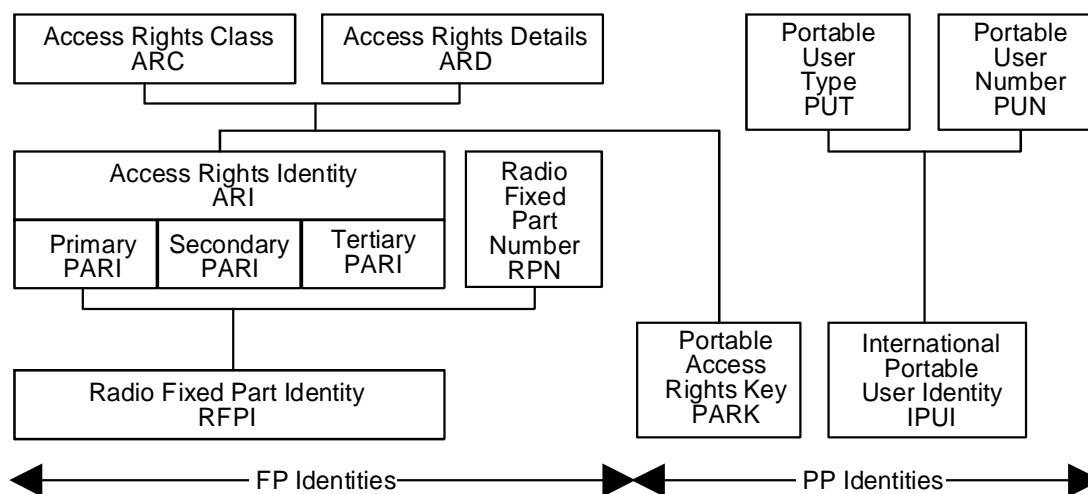

Figure 4.1: General identity structure

The common base for the DECT identity structure is the Access Rights Class (ARC) and Access Rights Details (ARD). These need to be known by both the FP and the PPs. In the FP the ARC and ARD are called Access Rights Identity (ARI), and in the PP they are called Portable Access Rights Key (PARK). The distinction between PARK and ARI is that each PARK can have a group of ARDs allocated, $PARK\{y\}$. "y" is the value of the PARK length indicator given in the PP subscription process.



Figure 4.2: Structure of $PARK\{y\}$

If the ARI is a primary ARI, i.e. PARI, it will form, together with a RFP number, the broadcast identity RFPI. ARIs can also be less frequently broadcast as Secondary Access Rights Identities (SARIs) and may also be available as Tertiary Access Rights Identities (TARIs), which are not broadcast, but are accessible upon request.

The PUT and PUN form the PP user's identity, IPUI. This identity can either be globally unique or locally unique. In addition to IPUIs, shorter temporary identities, TPUIs, may be used for paging.

A PP is identified by its pairs of PARK{y} and IPUI. A PP is only allowed to access a FP if one of its PARKs includes one of the ARIs of the FP, i.e. the PARI, a SARI or a TARI.

4.1 Combinations of ARIs, PARKs and IPUIs

DECT provides a flexible radio access technology for a large variety of private and public networks or systems. This leads to different requirements on e.g. sub-system grouping, distribution and installation of equipment, identity allocations and subscription.

Therefore five access rights classes A to E and a number of IPUIs have been defined to meet the need for a differentiation in the identity structures.

Table 4.1 gives an overview of likely combinations of the main identities. As described in clause 6.2 some flexibility is allowed in combinations of the IPUI types, e.g. IPUI type N could be used by a service provider in combination with any ARC.

Table 4.1: Combinations of identities ARI, PARK and IPUI

ARI class	Environment	SARI/TARI	PARK class	IPUI type
A	Residential and private (PBX) single and small multiple cell systems	No	A	N, S
B	Private (PABXs) multiple cell	Yes	B	O, S, T
C	Public single- and multiple cell systems	Yes	C	P, Q, R, S
D	Public DECT access to a GSM/UMTS operator network	Yes	D	R
E	PP to PP direct communication (private)	Yes	E	N

5 FP identities

FP identities are used to inform PPs about the identity of a DECT FP and the access rights to that DECT FP and thereby reduce the number of access attempts from unauthorized portables.

A DECT FP broadcasts this information on the N_T -channel via all its Radio FPs (RFPs), at least once per multiframe. A PP needs to be able to interpret necessary parts of this broadcast information to detect the access rights to a system or even access rights agreements between system operators, i.e. operators A and B have a bilateral agreement permitting their users to roam between their systems. These agreements can change and cannot therefore be stored in PPs without updating them frequently. Therefore the FP handles access rights information which is embedded in the identity structure.

The DECT identity structure provides solutions for residential, public and private environments. This can also be extended to combinations between these environments, e.g. private groups of users within a public DECT network, and e.g. public users access to private DECT networks.

The base for the identity structure is formed by the ARCs and the ARDs:

ARC: Shows the type of access to a DECT network, such as public, private or residential.

ARD: This number is unique to the service provider or to the equipment (e.g. in the case of residential and business applications this number is assigned by the manufacturer). Its structure depends on the ARC.

The ARC and ARD together form the basic identity, the ARI:

- ARI:** This identity is globally unique to a service provider, and shows the access rights related to this service provider. This identity may be applied to any number of FP installations. There are three categories of ARIs.
- PARI:** Primary ARI has to be broadcast. This is also the most frequently broadcast ARI in order to give a higher grade of service to users with these access rights. The PARI is broadcast over the N_T -channel (see note). The PARI (in conjunction with RPN) also carries information about domains of handover and location areas.
- SARI:** Secondary ARI. SARIs are less frequently broadcast than PARIs. They are sent as a SARI-list on the Q_T -channel. The message used for SARIs (there could be more than one SARI) is described in clause 5.6.
- TARI:** Tertiary ARI. The TARI is not broadcast at all and is only available as a (or in a) "TARI reply" message, which is an answer to a "TARI request" message including the relevant $PARK\{y\}$. See clause 5.6.6 and EN 300 175-3 [3], clauses 7.2.5.10 and 7.3.5.2.

NOTE: Several FPs may apply the same ARI. However, as a PARI it has to be geographically unique.

The classification of primary, secondary and tertiary access rights gives the possibility for operators or system owners to offer their subscribers/users an almost unlimited list of roaming agreements. This classification can be seen as an iceberg with the PARI visible on the top followed by a less visible SARI list and in the depth the invisible TARIs. The PP procedure for handling PARIs, SARIs and TARIs is described in clause 8.2.

Structure of ARI, see figure 5.1.

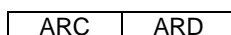

Figure 5.1: Structure of ARI

ARC: 8 available classes named A - H. Only classes A - E are currently defined.

ARD: Details, depends on the ARC.

One ARI together with a radio FP number, forms the RFPI. The ARI embedded in the RFPI is the PARI.

The RFPI has three purposes:

- to carry the PARI;
- to uniquely identify RFPs geographically;
- to show domains for handover and location areas.

The RFPI is frequently transmitted as bits a8 to a47 in the A-field using the N_T -channel and has therefore a limitation of 40 bits. See EN 300 175-3 [3], clause 7.2.2.

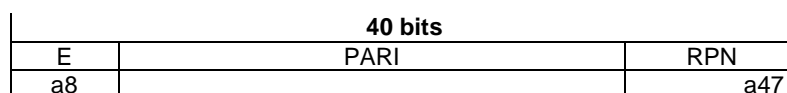

Figure 5.2: Structure of RFPI

E: this field indicates if there are any SARIs available. Value yes or no.

RPN: Radio fixed Part Number used for geographical separation.

Handover domains:

For DECT two handover domains are defined: internal handover (bearer and connection handover) to be within a FP, and external handover to be between FPs. Internal handover is possible between RFPs that have the same PARI in their RFPIs, i.e. only have changes in the RPN. See figure 5.3.

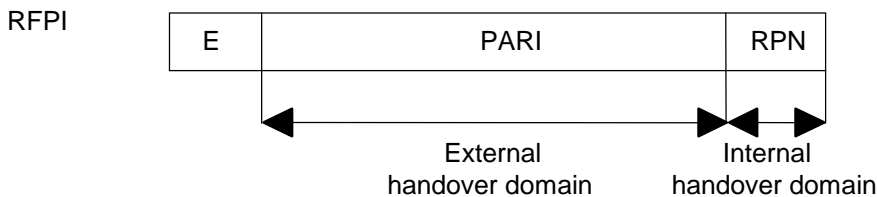

Figure 5.3: Indication of handover domains

The connection handover domain is always identical to the internal handover domain. The cluster size defines the bearer handover domain. A PP regards the cluster size as identical with the internal handover domain, if not else has been indicated by the optional PT "Bearer handover information", see EN 300 175-3 [3], clause 7.2.4.3.7. The RFPI for access rights classes A and C is also used for limited information on handover domains, see clauses 5.1 and 5.3.

External handover provision (by the external network) is indicated using the message defined in EN 300 175-3 [3], clause 7.2.3.4.2 with the coding defined in EN 300 175-5 [5], annex F. A PP can request the FP for information on PARIs of close by FPs to which external handover is supported, see EN 300 175-5 [5], clause 15.7. The information also indicates for each FP if it is synchronized to their own system or not.

External h/o length indicator:

The external handover length indicator is defined as the x bits of the PARI part of the RFPI, see figure 5.4. The PP is allowed to make an external handover based upon the <<ext h/o length indicator>> to FPs with all of the x bits the same.

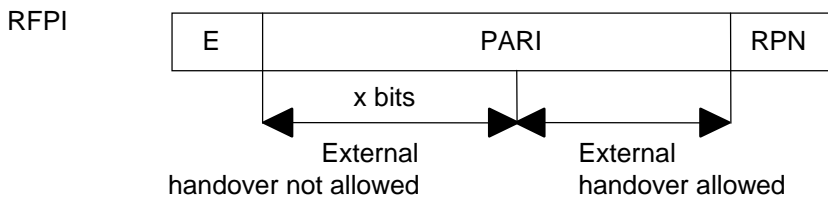

Figure 5.4: External handover length indicator

Location Areas (LAs):

A Location Area (LA) is defined as x bits of the PARI plus RPN part of the RFPI, see figures 5.5 and 5.6. As soon as any of these x bits change the PP has entered into a new LA and should do a location update. The x bits are indicated by the Location Area Level (LAL) indicator.

Location area with LAL = x bits:

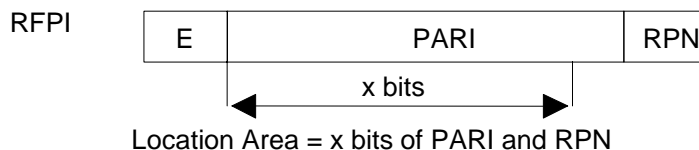

Figure 5.5: Location area with LAL = x bits

Default location area:

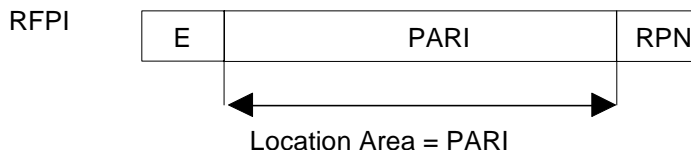

Figure 5.6: Default location area

LAL is submitted to a PP as a result of a successful location registration. See EN 300 175-5 [5]. The PP uses the default location area in the absence of a LAL.

A location registration at a FP can be permanent or temporary. If the location registration indicates "temporary user limit" all location registration data shall be cleared from a PP if the PP leaves the locked state with that FP (fails to receive the PARI) for more than T601 min. If the location registration indicates "temporary user limit 2" all location registration data shall be cleared from a PP if the PP leaves the locked state with that FP (fails to receive the PARI) for more than T603 seconds. See clause 6.3.

Four different ARCs have been defined. The structure and layout of ARIs and RFPIs related to these groups are described in the following clauses.

5.1 ARI class A

This class is intended to be used for small residential and private (PBX) single cell FPs and small multi-cell FPs with a maximum of 7 RFPIs. Equipment belonging to this class will probably be sold by non-expert retailers. Therefore the allocation process of class details needs to be delegated to manufacturers by a common administration.

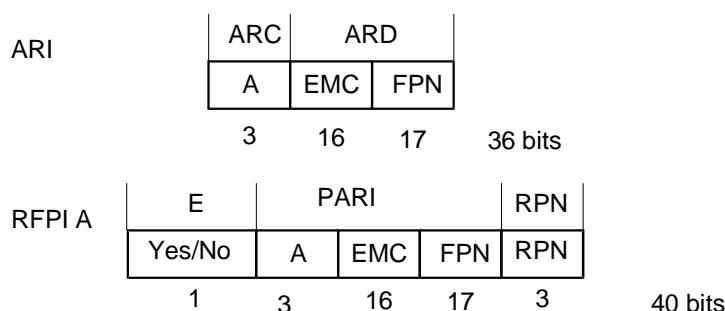

Figure 5.7: Access rights class A, ARI and RFPI

EMC: Equipment Manufacturer's Code is allocated to each manufacturer by ETSI or by a provider authorized by ETSI. Upper limit of EMC is 65 535. EMC = 0 shall not be used. The reason why the EMC has 16 bits is to avoid small manufacturers contending with a long number series. Larger manufacturers could have more than one EMC allocated.

FPN: Fixed Part Number shall be allocated by the manufacturer as a unique number for each EMC. It has an upper limit of 131 071, which gives a total of over 8,5 billion globally unique ARIs. FPN = 0 shall not be used.

RPN: Radio fixed Part Number, this number is allocated by the manufacturer/installer and is used to separate a maximum of 7 different cells from each other. In case of single cell FPs, RPN = 0. This indicates for a PP that this FP does not have intercell handover, since there is only one RFP.

This class provides enough FP identities for single cell FPs and small multi cell FPs. This results in a longer ARI than for all other classes. This ARI is therefore restricted only to be used as a PARI and not as SARI or TARI, see clause 5.6.

The class A DECT FP identity is the ARI part of the RFPI and it shall be globally unique.

NOTE: When adding a WRS to a residential single cell system, the RPN of the FT should change from 0 to a value in range 1 to 7. If the change is not performed, PP's may consider the FT to be a single cell system and not initiate handover to the WRS.

5.2 ARI class B

This access rights class is reserved for more complex private installations such as LANs and various types of multi-cell PABXs. In these environments it is necessary to be able to install new, or replace old, equipment without changing ARIs or RFPIs. This indicates that ARI B is mainly a system identity that follows a system and not a specific equipment.

The RFPIs could be allocated directly by the manufacturer, or by dealers, or installers authorized by the manufacturer.

The manufacturer is responsible for distributing ARIs to authorized dealers/installers.

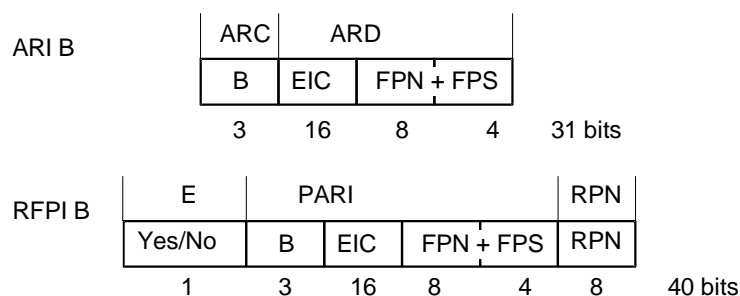

Figure 5.8: Access right class B, ARI, RFPI

EIC: Equipment Installer's Code is allocated by ETSI to each manufacturer, or by a provider authorized by ETSI. Large manufacturers could have more than one EIC allocated. The same can also apply for users, i.e. big companies can have their own EIC codes to be used at their different sites. Upper limit of EIC is 65 535. EIC = 0 shall not be used.

FPN: Fixed Part Number is distributed together with the EIC by the manufacturer to authorized installers. Upper limit of FPN in example shown in figure 5.8 is nominally 255. The value FPN + PS = 0 shall not be used as a part of the RFPI.

FPS: Fixed Part Sub-number is allocated by the system operator or installer. There are nominally 15 numbers available, FPS = 0 is reserved for future use, and shall not be used as a part of the RFPI.

A PP may be given access rights to all FPs with the same FPN, by use of a PARK{y}, where y includes only the FPN, see clause 6. The border between FPN and FPS bits may vary, but the sum shall be 12 bits, and FPN + FPS shall be unique for each EIC.

RPN: Radio fixed Part Number, is allocated by the operator or installer from the range 0 to 255. The number of RFPs per system can be larger than 256 through geographical separation.

The class B DECT FP identity is the ARI part of the RFPI. In most cases, the ARI is globally unique. Within the domain of a network of FPs controlled by one owner/operator, ARIs do not need to be globally unique, but shall be geographically unique, to avoid ambiguity at call set-up and handover.

5.3 ARI class C

This ARC is reserved for public access such as 1- and 2-way public access service or local loop.

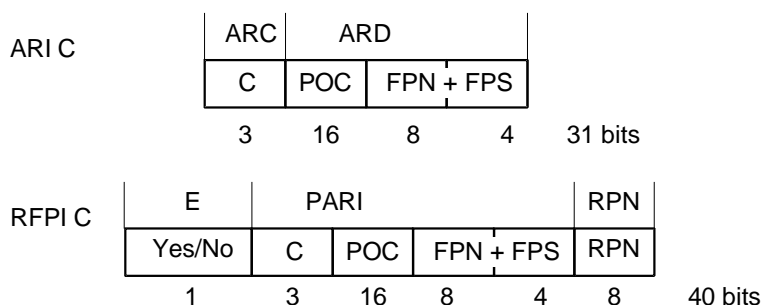

Figure 5.9: Access right class C, ARI, RFPI

POC: Public Operator Code, is allocated by ETSI, authorized by ETSI, or by a provider authorized by ETSI and is assigned to each operator as single codes or, if necessary, in blocks. The upper limit is 65 535. POC = 0 shall not be used. The operator shall provide a means for a PP user to discriminate between a mobile and a fixed FP, using the "non-static FP" broadcast attribute.

- FPN:** Is assigned by the FP operator and can be used to define different areas of subscription. Upper limit of FPN in example shown in figure 5.9 is nominally 255. The value $FPN + FPS = 0$ shall not be used as a part of the RFPI. FPNs can be chosen so that a wanted group of subscription areas is accessed by a PP by one $PARK\{y\}$, see clause 6.
- FPS:** Is allocated by the FP system operator or installer. $FPS = 0$ shall not be used as a part of the RFPI. There are nominally 15 numbers available per subscription area, FPN, for geographical separation of multiple cell FPs. See below on RPN for single cell FPs.
- RPN:** Is allocated by the operator/installer. Single cell RFPIs have the least significant bit = 0, which is used to indicate that intercell handover does not exist in this FP. This gives nominally 15×128 single cell RFPIs for geographical separation per subscription area. Multiple cell RFPIs have the least significant bit = 1. The number of RFPs per FP can be larger than 128 through geographical separation.

The border between FPN and FPS may vary, but the sum shall be 12 bits. If, for example, 31 FPS are wanted for geographical separation of multi cell FPs in an subscription area, a 7 bit FPN is used.

The class C DECT FP identity is the ARI part of the RFPI. Note that the PARK, clause 6.1.3, always is the ARI. Identities controlled by one operator/owner do not need to be globally unique, but shall be geographically unique, to avoid ambiguity at call set-up and handover.

5.4 ARI class D

This class is reserved for public use where the DECT network is directly attached to a 2G or 3G mobile network. The purpose of this class is to enable DECT users with GSM/UMTS subscriptions to access their GSM/UMTS network directly via DECT. PARIs in this class shall only be used in DECT networks owned by a GSM/UMTS operator (control of geographical separation).

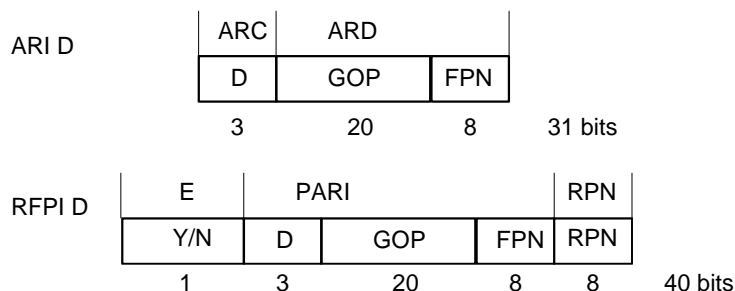

Figure 5.10: Access right class D, ARI, RFPI

- PLMN-Id:** Is Mobile Country Code (MCC) plus Mobile Network Code (MNC), see TS 123 003, clause 12.1 (see bibliography).
- FPN:** Is assigned by the GSM/UMTS operator and shall be used to geographically separate the DECT systems. Upper limit of FPN is 255. The value $FPN = 0$ shall not be used as a part of the RFPI.
- RPN:** Is allocated by the GSM/UMTS operator/installer. Single cell RFPIs have the least significant bit = 0, which is used to indicate that intercell handover does not exist in this FP. Multiple cell RFPIs have the least significant bit = 1. Upper limit is 128 RPNs per ARI. The number of RFPs per FP can be larger than 128 through geographical separation.

The class D DECT FP identity is the ARI part of the RFPI. Identities controlled by one GSM/UMTS operator do not need to be globally unique, but shall be geographically unique.

NOTE 1: GSM/UMTS subscription areas do not need to be indicated by FPN as DECT subscription areas in class C need to be. It is handled in a different way in a GSM/UMTS network. But the GSM/UMTS operator is free to use FPN also for supplementary subscription or access rights information.

NOTE 2: The broadcast "Higher layer attributes", see EN 300 175-5 [5], annex F, indicates whether an FP provides a GSM/UMTS network connection (bit a39) and whether external handover is provided (bit a45).

Required GSM/UMTS location information is available at location registration, as extended system information and as a connectionless MAC message.

5.5 ARI class E

This access rights class is reserved for PP-to-PP direct communication. ARI class E is only used as a PARI, not as a SARI or TARI. The RFPIs may be allocated by the user of the PP by entering 5 digits via the keypad or by other means. Such an allocation may be of a temporary nature in many applications.

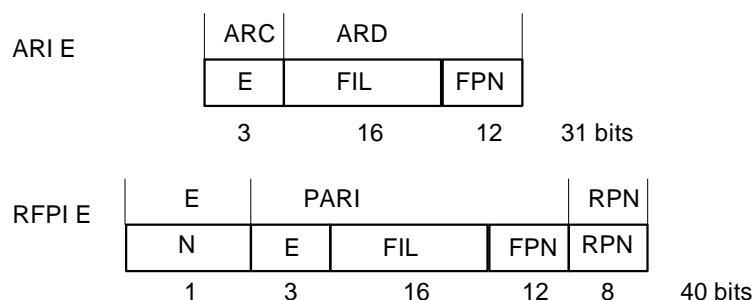

Figure 5.11: Access right class E, ARI, RFPI

FIL: fill bits with fixed 16-bit 0101 pattern.

FPN: is selected as a random number common for the group of PPs intended for mutual communication in direct communication mode. The Fixed Part Number shall be in decimal nibble coded format, so that entering via the keypad is possible, (range of FPN: 001 to 999).

RPN: Radio Fixed Part number used by the PP when it initiates a PP-to-PP call by starting to transmit a dummy bearer. It will also be used as a portable directory number when the PP is paged in a PP-to-PP mode. It is a 2 digit decimal number coded in the same format as FPN and may be entered via the keypad or by other means, (range of RPN: 01 to 99).

The class E DECT FP identity is the ARI part of the RFPI and is not globally unique.

PPs with a PP-to-PP direct communication mode option may be allocated PARIs, PARKs, IPUIs, etc. as for normal non-direct communications. This however requires cumbersome and inflexible subscription procedures. The ARI class E only requires an entry of 5 digits to provide all identity and subscription data required to form a group of PPs for direct communication. The procedure is as follows:

- 1) a random 3 decimal digit group number is selected (FPN);
- 2) the PPs in the group are assigned different 2 decimal digit directory numbers (RPN);
- 3) this defines one 5 digit (20 bits) assigned individual TPUI for each portable part, which may be entered to the PP via the keypad or by other means;
- 4) the PP shall automatically derive the PARK E and the RFPI E from the chosen assigned individual TPUI.

5.6 SARI list structure

The secondary access rights class list is broadcast via the Q_T -channel as system information type $Q_H = 0101$. Bits a12 to a47 shall be used for the SARI message. See EN 300 175-3 [3], clause 7.2.3.6. Every SARI message in the list contains SARI list length, TARI present flag, ARI/black-ARI flag and the ARI or black-ARI. All access right classes except for class A and class E can be SARIs or TARIs.

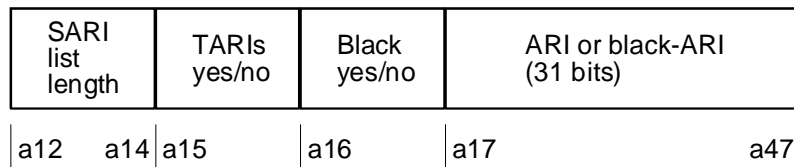

Figure 5.12: SARI message

5.6.1 ARI list length

Table 5.1: ARI list length

a12	a13	a14	Number of frames in the SARI list cycle
0	0	0	2
0	0	1	4
0	1	0	6
0	1	1	8
1	0	0	10
1	0	1	12
1	1	0	14
1	1	1	16

If some SARIs are more frequently transmitted than others it is necessary for a portable to know how many SARI frames there are in the SARI list cycle. This is to prevent the portable from timing out and start looking for a new base before the wanted SARI has been broadcast. A practical limit is around 8 to 10 ARIs. Q_T SARI messages occur every 4th multiframe, thus 10 SARIs require about 6 s cycle time. If there are more ARIs they should be included in the TARI list.

5.6.2 TARIs

Table 5.2: TARIs

a15	TARIs
0	No TARIs available
1	TARIs available

5.6.3 Black

Table 5.3: Black

a16	Black
0	ARI in a17 to a47
1	Black-ARI in a17 to a47

This can be used, e.g. to protect a small operator, that has no agreements with big operators but agreements with other small operators (presence of SARIs and TARIs), from congestion caused by the big operator's users requesting for TARIs.

5.6.4 ARI

Except for class E, any ARI with no more than 31 bits can be used as a SARI. The coding is as for ARIs of ARCs B to D.

5.6.5 Black-ARI

There are two rules:

- Rule a: a PP shall not use a PARK{31} equal to the black-ARI to make a TARI request. Any ARI with 31 bits can be used as a black-ARI. The coding is as for ARIs of ARCs B to D;
- Rule b: a black-ARI can also be coded to exclude classes or groups of PARK{y}s from being allowed to make TARI requests.

The coding:

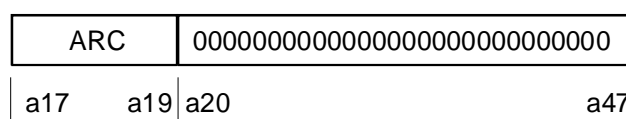

Figure 5.13: Whole ARC exclusion

excludes the PARKs of a whole ARC.

The coding:

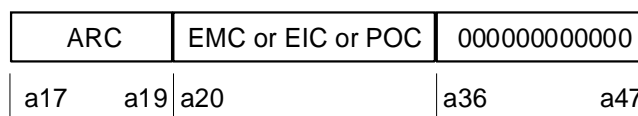

Figure 5.14: Same EMC, EIC or POC exclusion

excludes PARKs with the same EMC or EIC or POC.

The coding:

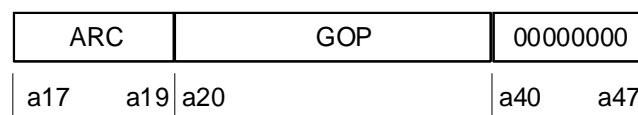

Figure 5.15: Same GOP exclusion

excludes PARKs with the same GOP.

The rule b) makes an exception for PARK{31}s if there is an ARI in the SARI list equal to that PARK{31}.

5.6.6 TARI messages

5.6.6.1 Request message from the PP

FPS that provide a TARI list may receive a PP request to test a particular PARK for its validity. For this purpose the PP sends either a TARI message which shall be carried in the A field (see EN 300 175-3 [3], clause 7.2.5.10) or an extended system information message which shall be carried in the B-field fields (see EN 300 175-3 [3], clause 7.3.5.2).

The PARK may belong to any ARC except class A and class E. The coding of the TARI field in this message is as follows:

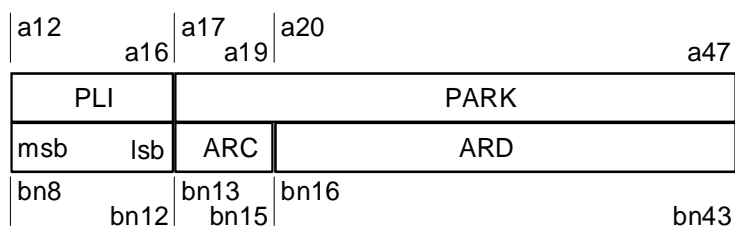

Figure 5.16: TARI PP request message

The Park Length Indicator (PLI) field contains the binary coded PARK length indicator, see clause 6.

5.6.6.2 Response message from the FP

Upon a PP request the FP may test if any ARI for the received PARK exists in its TARI list, and respond with another extended system information message. The TARI field in this message has three fields for a command, an identity and an ARC indication.

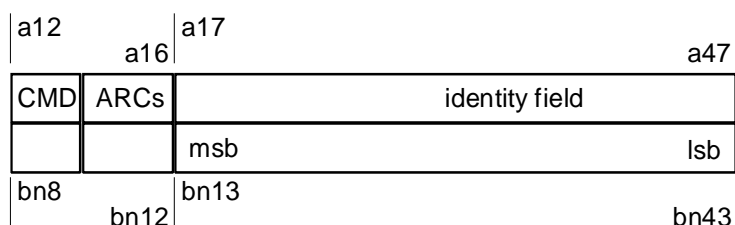

Figure 5.17: TARI FP response message

The command bit (CMD):

This bit reports if a valid ARI for a received PARK exists in the TARI list:

- CMD = 1: valid ARI exists in TARI list;
- CMD = 0: no valid ARI in TARI list.

ARCs:

For each ARC, except for class A and class E, a separate bit indicates if the TARI list contains entries of this class. The bit is set to "1" if the TARI list contains one or more entries of that ARI class. Reserved bits are set to "0".

Table 5.4: ARC classes

a13/bn9	reserved
a14/bn10	class B (ARI B)
a15/bn11	class C (ARI C)
a16/bn12	class D (ARI D)

The identity field:

For CMD = 0, the identity field (a₁₇ to a₄₇ or bn₁₃ to bn₄₃) carries a copy of the same field of the received message, containing the PARK.

For CMD = 1, the identity field contains the valid ARI. The ARI shall belong to the same access rights class as the previously received PARK.

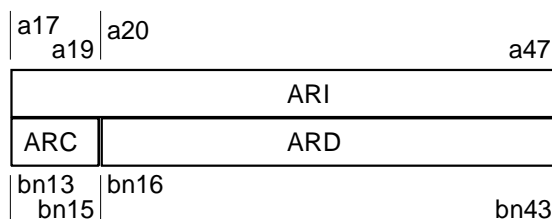

Figure 5.18: Identity field

6 PP identities

PP identities have two main purposes, first to enable a PP to select a valid DECT FP and second to uniquely identify the PP within that DECT FP. For these purposes there are two identities defined.

These identities are the PARK, and the IPUI. A PP shall have at least one PARK{y} and an IPUI.

PARK: The PARK{y} defines the access rights for a PP. "y" is the value of its PLI.

PLI: Associates a group of FP ARIs to the PARK, by indicating how many bits out of the ARC + ARD bits are relevant. The rest of the bits have "don't care" status.

NOTE: The PLI is programmed into a PP as part of the subscription process.

The structure of the PARK is the same as for an ARI.



Figure 6.1: Structure of PARK{y}

ARC: There are 8 available classes named A to H. Only classes A to E are currently defined.

ARD: Depends on the ARC.

IPUI: The IPUI is an identity that uniquely defines one user within the domain defined by his access rights. The IPUI may be locally or globally unique depending on the type of PUT.

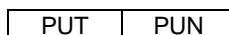

Figure 6.2: Structure of IPUI

PUT: Defines the numbering plan PUN. There are 8 available types named N-U.

PUN: Is a locally or globally unique number within one PUT.

Beside the IPUI it is possible to assign a shorter, temporary identity to a portable, the TPUI. A TPUI is valid within the domain of one location area. The purpose of this is to have an identity suitable for paging. See clause 6.3.

A locally unique IPUI has a validity domain restricted to one particular DECT FP, such as a Private Automatic Branch eXchange (PABX) or a Local Area Network (LAN). This identity is therefore restricted to be used only in that FP.

A globally unique IPUI has no domain restrictions contained in itself. Any restriction for usage of this identity has to do with the access rights (PARK) that are related to the identity. A globally unique IPUI can be used by more than one service provider.

PARKs, IPUIs (both locally and globally unique) and the structure of TPUIs are described in the following clauses.

6.1 PARK

The PP compares its PARK with the FP ARIs. A PP has access rights to a FP if one of its PARKs includes one of the ARIs of that FP, i.e. a PARI, a SARI or a TARI. A portable is fully identified by the chosen ARI and IPUI in that FP.

One PARK{y} can relate to several ARIs of several FPs by a suitable choice of the PLI value "y". This permits a PP to have extended access rights using a low number of PARK{y}s. This will in particular be useful in public environments.

NOTE: When assigning a PARK{y} to include ARIs of other service providers, "y" should not be set to a lower value than is covered by the agreement with these service providers.

6.1.1 PARK A

PARK A is used in relation with ARI class A, see clause 5.1.

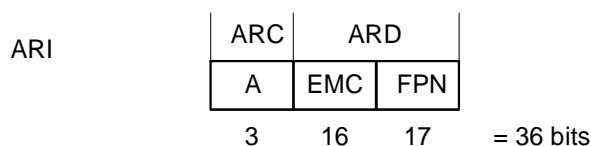

Figure 6.3: PARK A

6.1.2 PARK B

PARK B is used in relation with ARIs class B, see clause 5.2.

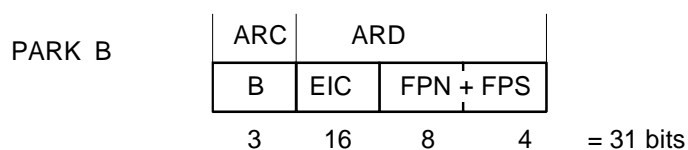

Figure 6.4: PARK B

6.1.3 PARK C

PARK C is related to ARI class C, see clause 5.3.

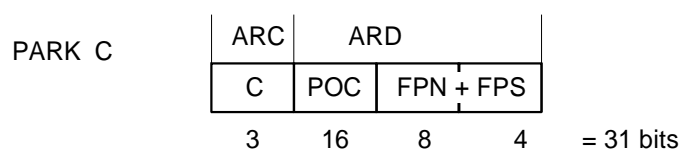

Figure 6.5: PARK C

6.1.4 PARK D

Park D is used in relation with ARI class D, see clause 5.4.

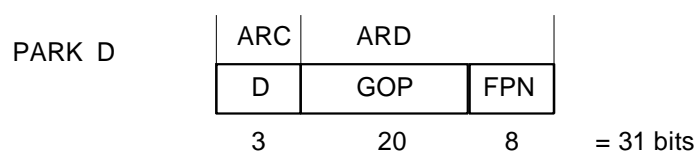

Figure 6.6: PARK D

6.1.5 PARK E

PARK E is used in relation with ARIs class E, see clause 5.5.

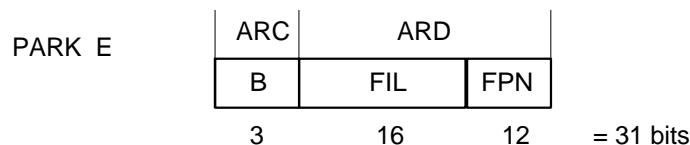

Figure 6.7: PARK E

6.2 IPUI

At the present there are 8 types of IPUIs. A pair of IPUI and PARK{y} provides a service provider with a unique subscription.

The same IPUI can be used in relation to more than one PARK. IPUIs (except class N IPUIs) have a variable length. The number of bits defined for PUN indicates the maximum length for the associated PUN. The portable identity information element of the NWK layer contains a field to indicate the selected length of the IPUI. See EN 300 175-5 [5], clause 7.7.30.

The structure of IPUIs is described in the following clauses.

6.2.1 Portable user identity type N (residential/default)

This identity shall be globally unique and shall be available in each PP. This identity is assigned by the manufacturer.

This identity is primarily intended to be used for simple FPs with an ARI class A, but may also be generally used. This identity may be used for emergency calls.

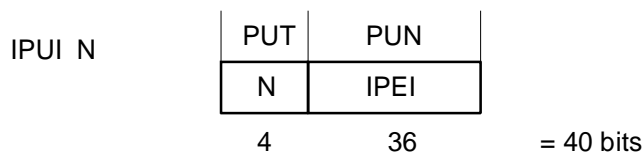

Figure 6.8: IPUI N

IPEI: This is embedded by the manufacturer and is specified in clause 10.

6.2.2 Portable user identity type S (PSTN/ISDN)

This is a global unique identity, which can be used in all environments.

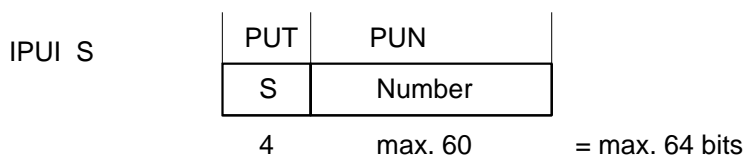

Figure 6.9: IPUI S

Number: This is a Binary Coded Decimal (BCD) coded PSTN or ISDN number with maximum length of 15 BCD digits. See ITU-T Recommendation E.164 [8].

6.2.3 Portable user identity type O (private)

This is a locally unique identity, i.e. it shall be specified by the operator/owner of a DECT FP. Intended to be used for PABX and LANs.

This identity is used in pair with PARK B.

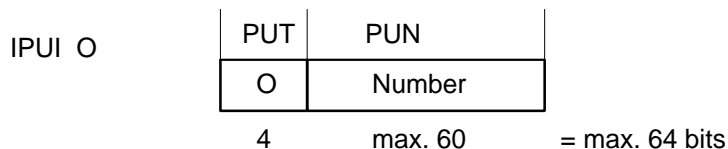

Figure 6.10: IPUI O

Number: This binary coded number shall be allocated by the operator/owner (installer) in any way that results in a locally unique number e.g. in a PABX application it can be the full PSTN number or the extension number of that PP and shall have length of maximum 60 bits.

6.2.4 Portable user identity type T (private extended)

This is a global unique identity which is intended to support roaming between private DECT networks run by the same owner e.g. bigger companies with IPUI O users can support roaming of their portables between different sites in different countries by adding a IPUI T.

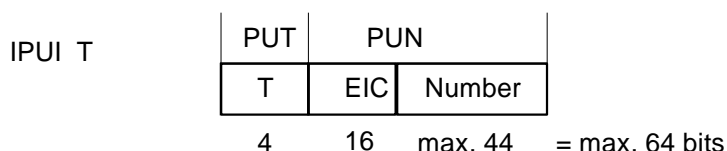

Figure 6.11: IPUI T

EIC: This is allocated by ETSI to each manufacturer. Upper limit of EIC is 65 535. EIC = 0 shall not be used. Large manufacturers could have more than one EIC allocated. The same can also apply for users, i.e. big companies can have their own EIC code to facilitate roaming of PPs between different sites of the company. This is a binary coded number.

Number: This BCD coded number is allocated by the service provider/owner and could be the portables PSTN or ISDN number or a part of the portables IPUI O number, if unique for this use number with maximum length of 11 BCD digits.

6.2.5 Portable user identity type P (public/public access service)

This identity is globally unique and intended to be used in public environments such as 1-way and 2-way public access service or local loop applications. A user with this identity will be charged via e.g. a public access service account number. The size of the account number supports usage of existing public access service account structures.

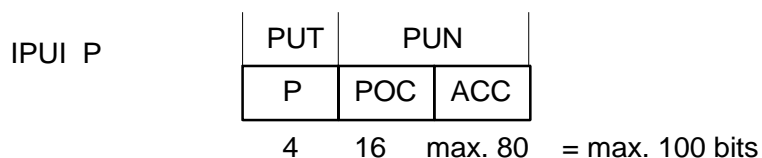

Figure 6.12: IPUI P

POC: This is allocated by ETSI and is assigned to each operator as single codes or if necessary in blocks. The upper limit is 65 535. POC = 0 shall not be used.

ACC: This is a binary coded account number with maximum length of 80 bits. POC + ACC shall be unique to provide a reliable billing mechanism.

6.2.6 Portable user identity type Q (public/general)

This identity shall be globally unique and similar to IPUI P, except for that subscribers will be charged via their bank accounts.

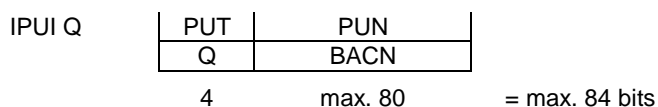

Figure 6.13: IPUI Q

BACN: This is the BCD coded bank account number with maximum length of 20 BCD digits.

6.2.7 Portable user identity type U (public/general)

This identity shall be globally unique and similar to IPUI P, except for that subscribers will be charged via their credit card accounts.

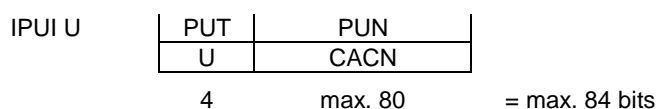

Figure 6.14: IPUI U

CACN: This is the BCD coded credit card account number with maximum length of 20 BCD digits.

6.2.8 Portable user identity type R (public/IMSI)

This identity shall be globally unique and shall contain an IMSI as defined in ITU-T Recommendation E.212 [10].

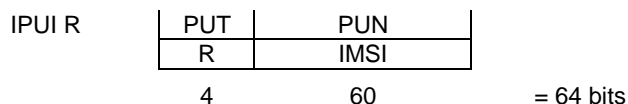

Figure 6.15: IPUI R

IMSI: This is the subscribers identity, maximum 15 BCD coded digits. See ITU-T Recommendation E.212 [10].

6.3 Individual and group TPUIs

6.3.1 General

Each TPUI is a short identity that is used for paging. Each TPUI is associated with one IPUI. There are two different sorts of TPUI - individual TPUI and group TPUIs:

Individual TPUI:

- assigned-individual (only one value);
- default-individual (only one value);
- emergency TPUI (only one value).

Group TPUIs:

- call-group (multiple values);
- connectionless-group (multiple values).

Only one assigned-individual TPUI shall be associated with each valid IPUI (an IPUI that has access rights). This assignment shall only apply within the defined location area.

One or more group TPUIs may also be associated with each valid IPUI. Group TPUIs are assigned, there are no default group TPUI values. The exception is the Connectionless group TPUI value reserved for the collective broadcast identifier (CBI). Each assignment shall only apply within the defined location area, but several group TPUIs may be in use at the same time.

Details of the TPUI assignment procedures are given in EN 300 175-5 [5]. As part of these TPUI assignment procedures a time limit and/or a lock limit may be defined. The relevant TPUI shall be deleted if these defined limits expire.

The time limit may define a maximum valid lifetime of the assigned TPUI in units based on MAC layer multiframes. If a defined time limit is indicated, this time limit starts as soon as the identity is accepted and the PT shall erase the relevant TPUI if the time limit is exceeded. Where the time limit also applies to a location registration, the TPUI may be reused for the purposes of a new location registration to the same location area as described in EN 300 175-5 [5], clause 13.4.1.

NOTE: If the FP broadcasts a multiframe counter, the counter value may be used to manage this time limit.

The lock limit may be used to indicate a "temporary user limit" assignment. When "temporary user limit" is indicated, the assigned TPUI shall be erased if the PP leaves the locked state (fails to receive the PARI) with that FP for more than T601 min.

The lock limit may also be used to indicate a "temporary user limit 2" assignment. When "temporary user limit 2" is indicated, the assigned TPUI shall be erased if the PP leaves the locked state (fails to receive the PARI) with that FP for more than T603 s.

The TPUI is a 20-bit identity. The most significant bits of the TPUI identify the TPUI type. This coding uses one or two hexadecimal digits as in figure 6.16.

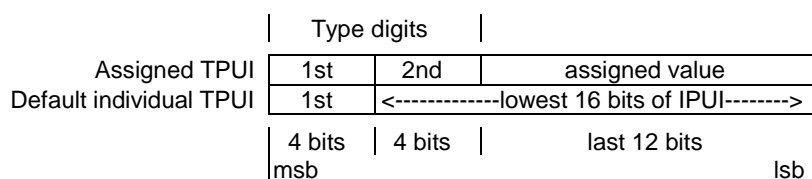

NOTE: msb = most significant bit;
lsb = least significant bit.

Figure 6.16: TPUI identity

Table 6.1: TPUI identity coding

Coding of type digits (Hex)			Allowed paging formats (see note 1)	Clause reference
1st digit	2nd digit			
0 to B	0 to B	Assigned individual TPUI (see note 2)	s,f	6.3.2
C	C	Connectionless group TPUI	s,e	6.3.3
D	D	Call group TPUI	s,f	6.3.3
E	X	Default individual TPUI (see note 3)	s,f	6.3.2
F	0	Not available (see note 4)		
F	1	Emergency TPUI	s,f	6.3.1
F	2 to F	Reserved	s,f	

NOTE 1: The allowed paging format indicates the alternative formats of paging messages that can be used with this type of TPUI. The allowed formats are short format (s), long format (f) and extended format (e). Refer to EN 300 175-5 [5].

NOTE 2: When using assigned individual identities with the short paging format there is a risk of ambiguity if more than one value of type code is used for the 1st digit. If possible, applications should restrict the use of assigned individual TPUIs to a single value of type code for the 1st digit. See also note 2 in clause 6.3.2.

NOTE 3: The 2nd digit of the default individual TPUI is not used for the type code and can take any value (0 to F). The default individual TPUI contains the least significant portion of the IPUI.

NOTE 4: The coding F0F0 is used in the MAC layer Wait message (EN 300 175-3 [3], clause 7.2.5.2.3). The coding type F0 is therefore not used.

The first and second digit of an emergency TPUI shall be "F1" (hex). If a PT wants to make an emergency call, it shall use the emergency TPUI header and the least significant bits from its assigned IPUI or its IPUI-N(IPEI).

6.3.2 Individual TPUI

A PP may be assigned a maximum of one individual TPUI per IPUI-PARK pair by the FP in each location area. This individual assigned TPUI shall be locally unique. This assignment shall only be valid within the Location Area (LA) where it was assigned.

NOTE 1: The assigned value may be the last part of the BCD coded PSTN or ISDN number or the extension number of the PP. The use of type codes "0" through "B" allows 5 digit extension numbers to be coded in BCD format. Digit 0 may be coded as either hexadecimal "0" or hexadecimal "A". When coding a smaller number of digits, the dummy leading digits should be coded with the hexadecimal value "B".

NOTE 2: To avoid ambiguities of assigned TPUIs/PMIDs, assigned TPUIs should be unique within the entire FP rather than within any of the location areas an FP may provide for.

If a new individual TPUI is assigned for a given pairing of IPUI and Location area, this new assignment shall replace the old (existing) assignment as defined in EN 300 175-5 [5].

If a PP does not have a valid value of assigned individual TPUI for its current location area it shall only use the default individual TPUI. The default value of individual TPUI is derived from the IPUI and is always available.

Assigned individual TPUIs for PPs using ARI class E (for PP-to-PP direct communication) may be manually entered via the PP's keypad. There is a defined relation between ARI class E and assigned individual TPUI (see clause 5.5).

6.3.3 Group TPUIs

Two types of group TPUI may be assigned:

- call group;
- connectionless group.

These are defined as group identities because each value may be assigned to more than one PP. Within each PP, these TPUIs are associated to a particular IPUI for the defined Location area. All group assignments shall only be valid within the location area where they were assigned.

The call group TPUI has a similar role to the individual TPUI, except that a paging message containing the group TPUI is intended to generate a response from multiple PPs.

NOTE: The PP response to a group page is the same as the response to an individual page. Both network layer responses contain the full IPUI. Refer to EN 300 175-5 [5].

The connectionless group TPUI has two special roles:

- connectionless paging;
- {CLMS-FIXED} message addressing or Portable Identity information element in {CLMS-VARIABLE}.

The value CFFFH from the set of connectionless group TPUIs shall be reserved in all PPs as the value of the CBI.

Connectionless paging:

A connectionless group TPUI is used for paging messages that point to a connectionless service or to a collective or group ringing service. These paging messages shall always use the short format message in order to allow the MAC layer to append a channel pointer to the message.

A paging message that contains a connectionless group TPUI indicates a receive-only service. This shall not cause a connection establishment: instead the MAC-channel pointer invites the PP to go to the indicated channel to receive the connectionless transmission. Refer to EN 300 175-3 [3].

{CLMS-FIXED} message addressing:

A connectionless group TPUI shall also be used for the address field within {CLMS-FIXED} messages. These messages shall use a special extended format. Refer to EN 300 175-5 [5].

{CLMS-VARIABLE}:

A connectionless group TPUI shall also be used in the Portable Identity information element within {CLMS-VARIABLE} messages. Refer to EN 300 175-5 [5].

7 Coding of identities

The identities have normally a full binary representation (0 - F hex/nibble), with some exceptions for the IPUIs which can be BCD-coded. Coding of FPN, FPS, RPN and PSN is not part of the specification. They are controlled by the manufacturer/service provider. Identities are exchanged as parts of network layer messages coding as defined in EN 300 175-5 [5], clause 7.7.

7.1 RFPI E-bit

Table 7.1: RFPI E-bit

E	capability
0	No SARIs
1	Yes SARI list available

7.2 Access rights codes

Table 7.2: Access rights codes

Binary code	ARC
000	A
001	B
010	C
011	D
100	E
101	F
110	G
111	H

7.3 Portable user identity types

Table 7.3: Portable user identity types

Binary code	IPUI Type
0000	N
0001	O
0010	P
0011	Q
0100	R
0101	S
0110	T
0111	U
1000	} Reserved
to	
1111	

7.4 EMC, EIC and POC

The EMC, EIC and POC codes consist of 16 bits each.

They are received from ETSI as a 4-digit hex (0 to F) number.

8 Rules for the usage of FP and PP identities

8.1 General principles

The general principles for usage of DECT identities are:

- 1) a FP shall broadcast one ARI as a part of the RFPI. This ARI is the PARI. Used channel is the N_T -channel;
- 2) a FP can broadcast other ARIs, these ARIs are called SARIs. Presences of SARIs are indicated in the RFPI by the E-bit. SARIs are broadcast in a separate message at the Q_T -channel;
- 3) a FP can have a set of stored non-broadcast ARIs, these are called TARIs. Presence of TARIs is indicated by the TARI-bit in the broadcast message for SARIs;
- 4) a PP shall have an IPEI;
- 5) a registered PP shall have at least one pair of PARK and IPUI;
- 6) a PP is always allowed to access a FP for emergency calls, or else if one of its $PARK\{y\}$ s includes an ARI equal to the PARI or a SARI;
- 7) if a FP has a TARI list, it is permitted for a PP to access the FP with a TARI request including its chosen $PARK\{y\}$, as long as the chosen $PARK\{y\}$ not is barred by a black ARI;
- 8) a user of a PP is identified by his chosen pair $PARK\{y\}$ and IPUI;
- 9) if a FP notifies via the higher layer capabilities broadcast that "access rights requests supported" is available, a PP is always allowed to access that FP for the purpose of obtaining access rights.

8.2 PARI, SARI and TARI usage

A PP detects a PARI in active unlocked state, but has to be in idle locked state to read a SARI and to make a TARI request.

Before a PP can try to access a FP, it has to have found a suitable ARI and be in the idle lock state. The decision of a PP to stay in the idle lock state could, for example, depend on if the user first wants to investigate other possible access rights.

The route for a PP to find a suitable ARI or not is illustrated by the procedure in figure 8.1.

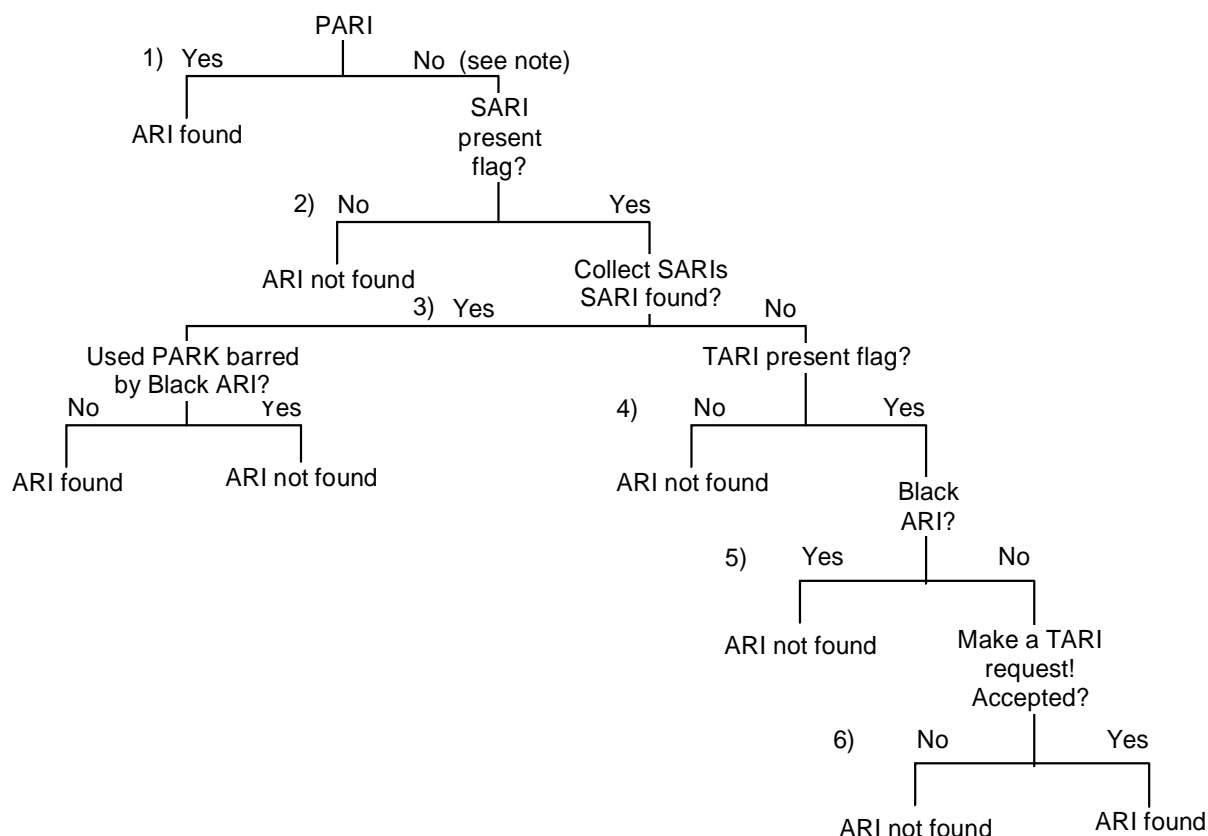

NOTE: In case of an emergency call or for obtaining access rights, by definition an ARI is always found.

Figure 8.1: Procedure for a PP to find a suitable ARI

- 1) An ARI is found if the PARI is included in the PARK{y} of the PP (there could be more than one PARK). Any PARI is acceptable for an emergency call. If the FP is broadcasting "access rights requests supported" as available, any PARI is acceptable for obtaining access rights.
- 2) If an ARI is not found and the RFPI does not contain a SARI present flag, the PP shall remain in the active unlocked state. In this state the PP searches for a new suitable RFPI.

NOTE 1: To avoid a new selection of the previous FP, the PP should store the PARI for a suitable time, e.g. 5 mins.

- 3) If a SARI that is included in the PARK{y} is found, then the PP normally has roamed into a permitted FP and the PP could stay in the idle locked state. The PP shall check that the used PARK{y} is not barred by a black ARI. If it is barred an ARI is not found. See clause 5.6.5, rule b).
- 4) If there is no TARI list, the PP is not permitted to access this FP and shall enter into active unlocked state. See 2).
- 5) If there is a TARI present flag and the used PARK{y} is included by a black ARI, the PP is not permitted to access this FP and should enter into active unlocked state, except if $y = 31$ and an ARI equal to this PARK{31} is in the SARI list. See 3).
- 6) If the used PARK{y} is not included by a black ARI, the PP enters the active locked state and shall send a TARI request including the wanted PARK{y} to the FP. If the answer is "reject" (no valid ARI exists in TARI list) the PP shall enter the active unlocked state and search for a new RFPI. The PP shall not be able to do a new request to the same FP within T602 min.

If the answer is "accept" (valid ARI exists in TARI list) the PP may remain in idle locked state.

The PP shall store information from following the above procedure. If a wanted SARI or TARI is found, the PP may lock to the FP. It then has to store the PARI of the chosen FP, linked with information that the service of the wanted ARI is provided by the FP with this PARI. This PARI is frequently (at least once per multiframe) received by the locked PP. If the PARI is not received within a certain time, e.g. 5 min, the stored information may be cleared from the memory.

NOTE 2: If no wanted SARIs or TARIs are available at the FP, then the PP should store the PARI from this FP, linked with information that the wanted ARI is not provided. If the same PARI is found again the PP will ignore it. If that PARI is not found again within e.g. 5 min, the information may be cleared from the memory.

9 Connection related identities

These identities are associated with the peer-to-peer communication in DECT. That means that every layer-to-layer connection has an identity.

These identities serve the purpose of handshake, protection against co-channel interference (MAC-layer), avoiding loss of a connection during bearer and connection handover, etc.

9.1 MAC identities

See EN 300 175-3 [3], clause 11.7.

A MAC connection is initiated by the PP when it sends an Access_Request, see also EN 300 175-3 [3], clause 10.2.4. This message includes the PP and the RFP MAC identities. These identities are named Portable MAC Identity, PMID, and Fixed MAC IDentity, FMID. These identities have the following structures.

9.1.1 FMID

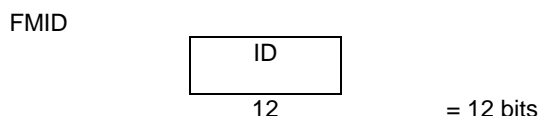

NOTE: ID is the 12 least significant bits of the RFPI.

Figure 9.1: FMID structure

Since the FMID is derived from the RFPI and therefore has the same value for all the bearers within the same cell it is not unique enough to be used as an identification of a call. The main usage of the FMID is to avoid co-channel interference at the initial phase of a call set-up. The FMID is geographically unique for a FP, since the RPN is geographically unique for a FP.

NOTE: If synchronization is provided between two FPs, all FMIDs of the two systems should be geographically unique.

9.1.2 PMID

The purpose of the PMID is to uniquely identify an active PP within one FP.

PMID can have a default value, an assigned value or an emergency value. PMID consists of 20 bits.

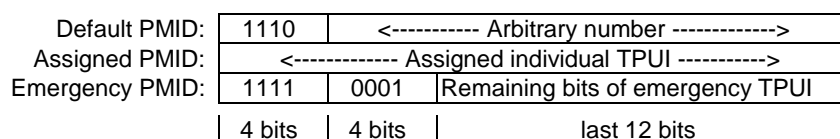

Figure 9.2: PMID structure

Arbitrary number: this number is changed if an access request is not confirmed.

Assigned individual TPUI: this is locally unique and is defined in clause 6.3.2.

Emergency TPUI: the Emergency TPUI shall be used in case of emergency call and is defined in clause 6.3.1. In case of emergency call the Emergency PMID shall be used. Otherwise, if an assigned individual TPUI exists, the assigned PMID shall be used. Otherwise the default PMID shall be used.

9.2 DLC identities

See EN 300 175-4 [4], clause 10.3.1.

The DLC uses the PMID to generate the Link SIGNature (LSIG).

9.3 NWK identities

See EN 300 175-5 [5].

The IPUI, TPUI and ARI are network layer identities. These are used in several processes such as:

- paging (TPUI);
- call control establishment (ARI and IPUI or ARI and TPUI);
- authentication (IPUI, TPUI and ARI).

Network layer messages for identities are defined in EN 300 175-5 [5], clauses 6.3 and 6.4.

10 Equipment related identities

These identities are used to identify the PP equipment, and are called International Portable Part Equipment Identities (IPEIs). They are globally unique and shall be embedded into the PPs by the manufacturer. The IPEI can be requested by a FP for check of stolen equipment.

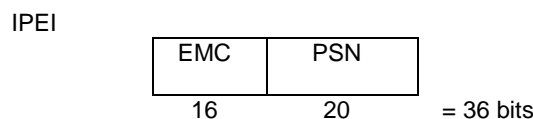

Figure 10.1: IPEI structure

EMC: is allocated to each manufacturer by ETSI. Upper limit of EMC is 65 535. EMC = 0 shall not be used. The reason why the EMC has 16 bits is to avoid that small manufacturers contending with a long number series. Larger manufacturers could have more than one EMC allocated.

PSN: Portable equipment Serial Number, has an upper limit of over 1 million codes. It shall be allocated by the manufacturer as a unique number for each EMC.

NOTE 1: A manufacturer does not need to use different EMCs for ARI A and IPEI.

NOTE 2: For the textual representation of the IPEI see annex C.

11 Subscription and registration procedures

Subscription and registration procedures are mainly decided and administrated by manufacturers and service providers.

For access rights procedures, location procedures and identity procedures, see EN 300 175-5 [5], clause 13.

Annex A (informative): Examples of usage of FP and PP identities

In this annex the flexibility of the identity structure is illustrated by a number of examples. This is done by starting with a simple residential PP and extends permitted environments for this PP by adding necessary pair of identities. This also illustrates that it is possible to use the same PP in a number of networks run by different operators and owners.

A.1 Residential ID usage

The FP in a residential environment only broadcast one ARI as a part of the RFPI and the PP has one PARI stored together with the IPUI. The PP is fully identified by sending its IPUI and selected PARI.

Residential environment (single cell):

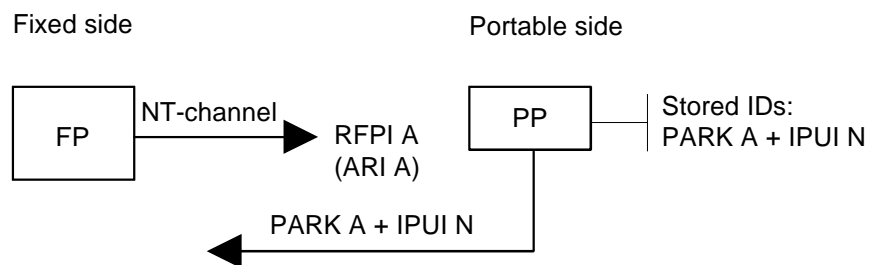

NOTE: For identification in a residential environment, it is possible for the portable to omit the PARI.

Figure A.1: Residential ID usage

A.2 Public ID usage

A.2.1 Primary

Starting with the simplest public case, a public access service where the operator has no agreements with other operators. The FP then only broadcast one ARI as a part of the RFPI. The PP has one PARI stored together with the IPUI. The PP is fully identified by sending its IPUI and selected PARI.

Public environment (primary):

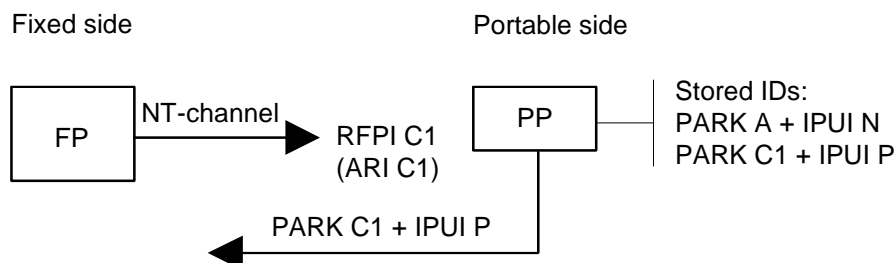

Figure A.2: Public ID usage (primary)

A.2.2 Secondary

If a public access service operator has agreements with other operators, their ARIs will be broadcast on the Q_T -channel as SARIs. A visiting permitted PP will find a SARI that is equal to its PARK. This PP will be fully identified by its IPUI and selected PARK.

Public environment (secondary):

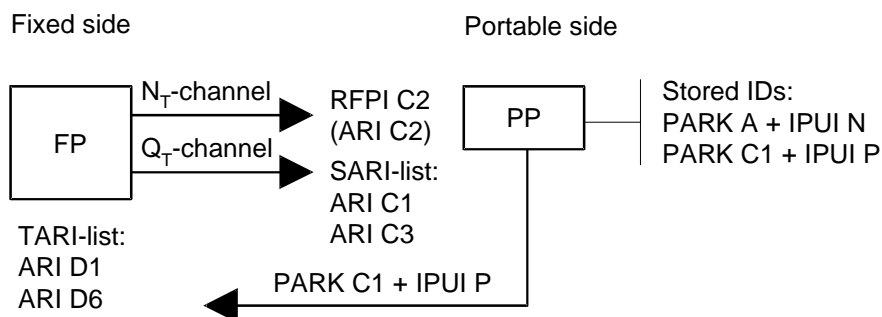

Figure A.3: Public ID usage (secondary)

A.2.3 Tertiary

When the number of SARIs exceeds the limit of capability of the Q_T -channel, infrequently used ARIs can be stored in a TARI list. A PP without PARI or SARI can request permission to access by sending its PARK to the FP, if presence of a TARI list is indicated.

The PP is fully identified by its IPUI and selected PARK.

Public environment (tertiary):

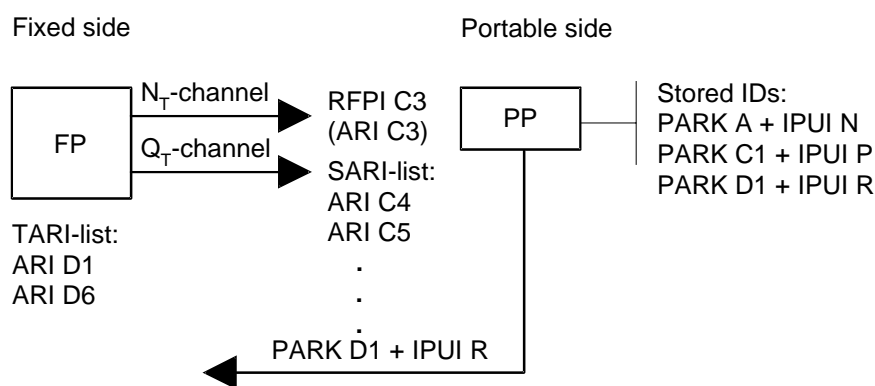

Figure A.4: Public ID usage (tertiary)

A.3 Private ID usage

A.3.1 Primary

An ordinary business system will have a PARI transmitted as a part of the RFPI and the PP has a PARK and an IPUI stored.

The PP is fully identified by its IPUI and selected PARK.

Private environment (primary) (business, large multi-cell):

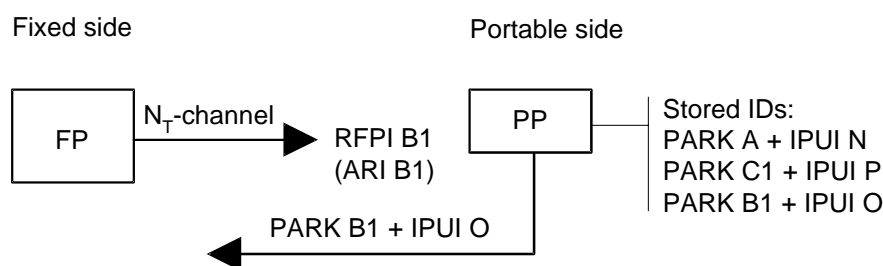

Figure A.5: Private ID usage (primary)

A.3.2 Secondary

Even in this environment it will be possible to have agreements with other operators. A visiting permitted PP will recognize a SARI that is equal to the PP's PARK. The PP will be identified by its IPUI and selected PARK.

Private environment (secondary) (business, large multi-cell):

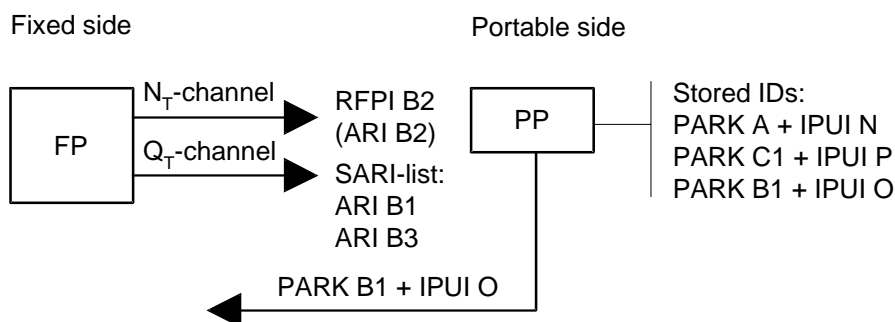

Figure A.6: Private ID usage (secondary)

A.4 Mixed private and public ID usage

A.4.1 Public in private environments

In areas where private and public environments intercept each other it could be possible to let public users have access to a private environment. Users within the private environment do not need to read their ARI often, therefore this ARI could be broadcast as a SARI. This will enable private systems to send a public system's ARI as a PARI and by that give public users a high grade of service. Alternatively, but not required, the ARI of the private system is the PARI and the public ARI is the SARI.

A.4.2 Private in public environments

A public operator can add a large number of local private user groups in his network, e.g. a hospital or companies at an airport. The public operator has to apply for an EIC code and assign the ARIs of his private sub-systems as SARIs in relevant FPs.

NOTE: In case of an emergency call, by definition, an ARI is always found.

A.5 PARI and SARI use for CTM roaming

A CTM user subscribes to the CTM service offered by a CTM service provider. The CTM service provider provides the CTM service using the equipment of one or more network operators. These network operators can be of different nature: public, business and/or residential. The area of mobility provided to the CTM-user depends on the geographical area covered by the totality of equipment of the network operators with whom his service provider has a relationship.

The CTM service provider is identified by one single and globally unique CTM service provider identity, the SP-id.

The network operator equipment is identified by a range of network operator equipment identities, the NO-ids. More than one NO-id can be assigned to the same network operator.

As part of the agreement between CTM service provider and network operators, all involved network operators will administer the SP-id.

Radio base stations of all involved network operators will broadcast the SP-id of the CTM service provider in addition to their own local network equipment's NO-id.

CTM users have a contract with the CTM service provider and as part of the contract they are given the SP-id by means of which they can recognize those parts of the network that take part in the provision of the CTM service for that particular CTM service provider. This SP-id is stored in the user's cordless terminal.

While roaming around, the CTM terminal uses the SP-id to determine whether it has access to local radio base stations (by comparing the broadcast SP-id with its own stored SP-id). If it has access, then the NO-id of the local base station is used as an indication of the location within the network.

NO-ids are structured in such a way that a terminal, while moving within the domain of a SP-id, can determine whether handover or location registration is required (by comparison of the current NO-id with the newly detected NO-id of a neighbouring piece of network operator equipment).

Both the SP-id and the NO-id are mapped to the single DECT concept of "Access Rights Identities" (ARI). However it is important to realize that the application is principally different.

The NO-id is kept in the DECT Fixed Part as the Primary Access Rights Identity (PARI) and is broadcast as part of the Radio Fixed Part Identity (RFPI). Separate PARI values are assigned to each DECT Fixed Part.

The SP-id is kept in the DECT Fixed Part as a Secondary Access Rights Identity (SARI) and is broadcast (but less frequently) by all radio base stations in addition to their RFPI.

In the CTM terminal the SP-id is kept as the user's Portable Access Rights Key (PARK) in association with the user's IPUI.

Figure A.7 gives an illustration.

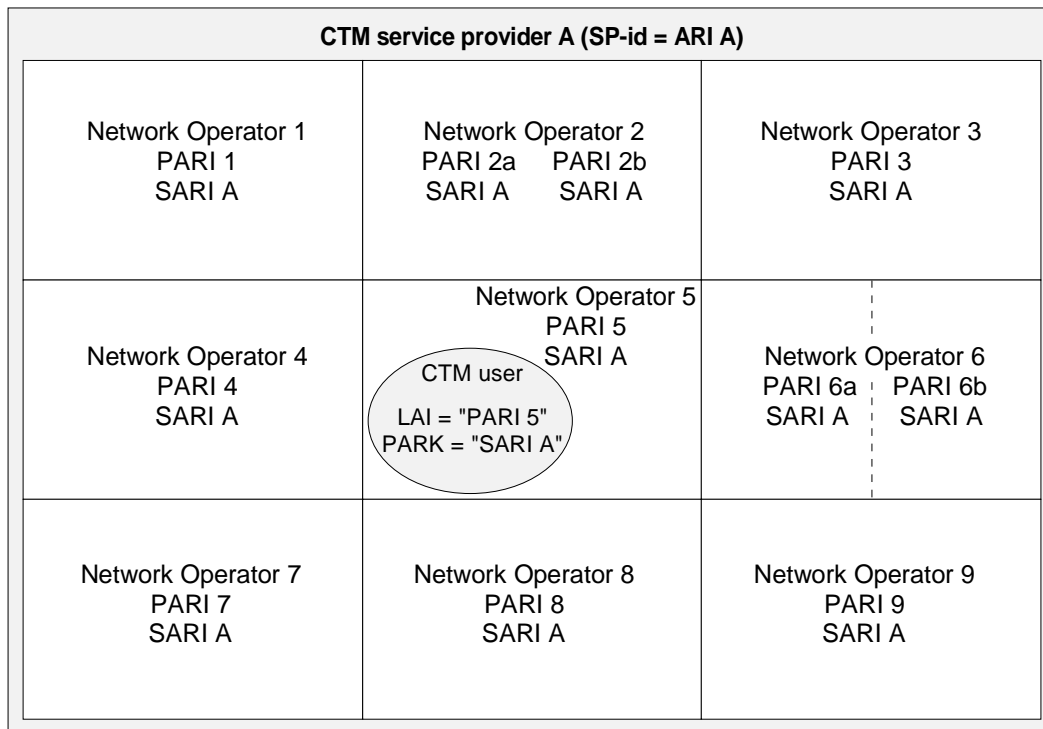

Figure A.7

By comparison of its PARK with the ARI(s) in the SARI-lists of broadcasting radio base stations, the CTM terminal decides whether it has access to that part of the network, and if required starts a location registration. If that is successful, the terminal uses the PARI-value of the current part of the network as a Location Area Identification (LAI). While roaming around, the terminal recognizes other valid network parts by the broadcast SARI. The currently stored LAI, in combination with received PARI-values of local network elements is used by the terminal to decide for handover and/or location registration.

In summary:

- there is a logical and functional difference between the ARI assigned to a network operator and the ARI assigned to a service provider;
- the ARI broadcast as PARI (in RFPI) identifies the network operator and is used to provide the criteria for handover and location registration;
- the ARI broadcast as SARI identifies the service provider and is used by the terminal to determine whether the broadcasting network operator is associated with the CTM service provider, i.e. whether that network operator can give him/her access to subscribed-to CTM service;
- the NO-id's ARI-class (public, business, residential) is independent of the SP-id's ARI-class;
- the SARI glues together all of the network operator equipment into a single domain of a CTM service provider;
- the CTM terminal only needs one subscription. IPUI and PARK are allocated by the service provider and the PARK relates to the ARI of the service provider.

NOTE: If a certain network operator uses its equipment exclusively for CTM and only for one CTM service provider, then the functions of SP-id and NO-id may be combined into the PARI and no SARI would be needed.

Annex B (normative): Identities and addressing timers

- T601 = 5 min location registration data and TPUIs maximum storage time for Temporary user limits, if PP is not locked to FP.
- T602 = 5 min time between TARI requests, clause 8.2.6.
- T603 = 40 s location registration data and TPUIs maximum storage time for Temporary user limits 2, if PP is not locked to FP.

Annex C (normative): Representation of IPEI as printed text

Representation of the IPEI (which uniquely identifies a handset), see clause 10, as a textual string (either on a printed label or displayed on a screen) shall use the following format:

- EEEEE PPPPPP C;

where:

- EEEEE is the decimal representation of the EMC (the first 16 bits of IPEI seen as one unsigned integer in the natural binary code) in a five-digit field with leading zero digits as required;
- PPPPPP is the decimal representation of the PSN (the subsequent 20 bits of IPEI seen as one unsigned integer in the natural binary code) in a seven-digit field with leading zero digits as required;
- C is the check digit. The check character is calculated as the sum of each digit in the string multiplied by its position in the string modulo 11. The check digit lies between 0 and 10 and is represented either as the decimal digit, or as a "*" if equal to 10.

EXAMPLE: An IPEI bit string;

0000 0000 0000 1100 0000 0000 0000 1000 1001;

is represented as 00012 0000137 9;

$0 + 0 + 0 + 4 + 10 + 0 + 0 + 0 + 0 + 0 + 10 + 33 + 84 = 141;$

$141 \text{ modulo } 11 = 9.$

Annex D (informative): Bibliography

- ETSI EN 300 175-2: "Digital Enhanced Cordless Telecommunications (DECT); Common Interface (CI); Part 2: Physical Layer (PHL)".
- ETSI TS 123 003: "Digital cellular telecommunications system (Phase 2+); Universal Mobile Telecommunications System (UMTS); Numbering, addressing and identification (3GPP TS 23.003)".
- ETSI TR 101 178: "Digital Enhanced Cordless Telecommunications (DECT); A High Level Guide to the DECT Standardization".
- ETSI ETR 043: "Digital Enhanced Cordless Telecommunications (DECT); Common Interface (CI); Services and facilities requirements specification".

Annex E (informative): Change history

The following table presents main changes from a published version to the next version (published or to be published).

Subject/Comment	Old	New
The enhancement of the DECT base standard to support higher data rates includes the 16 QAM/64 QAM modulation option and the Channel Coding based on the Turbo Code Principle.	1.6.1	1.7.1
Some minor editorial improvements.	1.7.1	1.8.1
Editorial update	1.8.1	1.9.1
New Generation DECT: A major revision of the DECT base standard introducing wideband speech, improved data services, new slot types and other technical enhancements.	1.9.1	2.0.1

History

Document history		
Edition 1	October 1992	Publication as ETS 300 175-6 (Historical)
Edition 2	September 1996	Publication as ETS 300 175-6 (Historical)
Amendment 1	August 1997	Amendment 1 to 2 nd Edition of ETS 300 175-6 (Historical)
V1.4.2	June 1999	Publication
V1.5.1	February 2001	Publication
V1.6.1	January 2002	Publication
V1.7.1	July 2003	Publication
V1.8.1	November 2004	Publication
V1.9.1	September 2005	Publication
V2.0.1	March 2007	One-step Approval Procedure OAP 20070727: 2007-03-28 to 2007-07-27