



**Digital Enhanced Cordless Telecommunications (DECT);
Common Interface (CI);
Part 4: Data Link Control (DLC) layer**

Reference

REN/DECT-00324

KeywordsDECT, DLC, IMT-2000, mobility, radio, TDD,
TDMA**ETSI**

650 Route des Lucioles
F-06921 Sophia Antipolis Cedex - FRANCE

Tel.: +33 4 92 94 42 00 Fax: +33 4 93 65 47 16

Siret N° 348 623 562 00017 - NAF 742 C
Association à but non lucratif enregistrée à la
Sous-Préfecture de Grasse (06) N° 7803/88

Important notice

The present document can be downloaded from:

<http://www.etsi.org/standards-search>

The present document may be made available in electronic versions and/or in print. The content of any electronic and/or print versions of the present document shall not be modified without the prior written authorization of ETSI. In case of any existing or perceived difference in contents between such versions and/or in print, the prevailing version of an ETSI deliverable is the one made publicly available in PDF format at www.etsi.org/deliver.

Users of the present document should be aware that the document may be subject to revision or change of status.

Information on the current status of this and other ETSI documents is available at

<https://portal.etsi.org/TB/ETSIDeliverableStatus.aspx>

If you find errors in the present document, please send your comment to one of the following services:

<https://portal.etsi.org/People/CommiteeSupportStaff.aspx>

Copyright Notification

No part may be reproduced or utilized in any form or by any means, electronic or mechanical, including photocopying and microfilm except as authorized by written permission of ETSI.

The content of the PDF version shall not be modified without the written authorization of ETSI.

The copyright and the foregoing restriction extend to reproduction in all media.

© ETSI 2019.

All rights reserved.

DECT™, **PLUGTESTS™**, **UMTS™** and the ETSI logo are trademarks of ETSI registered for the benefit of its Members.

3GPP™ and **LTE™** are trademarks of ETSI registered for the benefit of its Members and of the 3GPP Organizational Partners.

oneM2M™ logo is a trademark of ETSI registered for the benefit of its Members and of the oneM2M Partners.

GSM® and the GSM logo are trademarks registered and owned by the GSM Association.

Contents

Intellectual Property Rights	13
Foreword.....	13
Modal verbs terminology	13
1 Scope	14
2 References	14
2.1 Normative references	14
2.2 Informative references	15
3 Definition of terms, symbols and abbreviations.....	16
3.1 Terms	16
3.2 Symbols	16
3.3 Abbreviations.....	17
4 Data Link Control (DLC) layer overview	19
4.1 General.....	19
4.2 C-plane services.....	20
4.3 U-plane services.....	20
4.4 Lower Layer Management Entity (LLME).....	24
4.5 Instantiation in DLC U-plane.....	24
5 C-plane service characteristics	24
5.1 Data link service (LAPC+Lc)	24
5.1.1 General	24
5.1.2 LAPC types of operation.....	25
5.1.3 Establishment of information transfer modes.....	25
5.1.3.1 Data Link Identifier (DLI)	25
5.1.3.2 LAPC states	26
5.2 Broadcast service (Lb).....	26
6 Frame structures for C-plane services	27
6.1 Data link service frame structure	27
6.1.0 Frame format type FA	27
6.1.1 General frame structure	27
6.1.2 Lc frame delimiting and transparency	28
6.1.3 Transmission order.....	28
6.1.4 Routing to logical channels	28
6.1.4.0 General	28
6.1.4.1 C _F /CL _F logical channel	29
6.1.4.2 C _S /CL _S logical channel	29
6.1.5 Invalid frames.....	29
6.2 Broadcast service frame structure	30
6.2.1 Standard frame structure	30
6.2.2 Extended frame structure	30
7 Elements of procedures and formats of fields for C-plane peer-to-peer communication	31
7.1 General.....	31
7.2 Address field formats.....	31
7.3 Address field parameters	31
7.3.1 REServed bit (RES)	31
7.3.2 Command Response (C/R) bit.....	31
7.3.3 SAPI field.....	31
7.3.4 New Link Flag (NLF) bit	32
7.3.5 LLN-field	32
7.3.6 Data Link Identifiers (DLI).....	32
7.4 Control field formats.....	33
7.5 Control field parameters	33

7.5.1	Poll/Final (P/F) bit	33
7.5.2	Multiple frame operation variables and sequence numbers	33
7.5.2.1	Modulus	33
7.5.2.2	Send state Variable V(S)	34
7.5.2.3	Acknowledge state Variable V(A)	34
7.5.2.4	Send sequence Number N(S)	34
7.5.2.5	Receive state Variable V(R)	34
7.5.2.6	Receive sequence Number N(R)	34
7.5.3	Unacknowledged operation variables and sequence numbers	34
7.5.4	Supervisory and Unnumbered function bits S and U	34
7.6	Length indicator field format	34
7.7	Length indicator field parameters	35
7.7.1	Length indicator field extension bit (N)	35
7.7.2	More data bit (M)	35
7.7.3	Length parameter (L _I)	35
7.7.4	Extended length parameter (L _{JJ})	36
7.7.5	Reserved bit (RES)	36
7.8	Fill field format	36
7.9	Checksum field format	36
7.10	Checksum field parameters	37
7.11	Commands and responses	38
7.11.0	General	38
7.11.1	Information (I) command	38
7.11.2	Receive Ready (RR) command/response	38
7.11.3	Receive Not Ready (RNR) command/response	39
7.11.4	REJect (REJ) command/response	39
7.11.5	Set Asynchronous Balanced Mode (SABM) command	39
7.11.6	Disconnect Mode (DM) response	39
7.11.7	Unnumbered Information (UI) command	39
7.11.8	DISConnect (DISC) command	40
7.11.9	Unnumbered ACK (UA) response	40
8	Primitives	40
8.1	Primitive types	40
8.2	Primitives to the MAC layer (lower layer)	40
8.3	Primitives to the NWK layer (higher layer)	41
8.3.0	General	41
8.3.1	Parameter definitions	41
8.3.2	S-SAP primitives	42
8.3.2.0	List of primitives	42
8.3.2.1	DL_ESTABLISH primitive	42
8.3.2.2	DL_RELEASE primitive	43
8.3.2.3	DL_DATA primitive	43
8.3.2.4	DL_UNIT_DATA primitive	43
8.3.2.5	DL_SUSPEND primitive	43
8.3.2.6	DL_RESUME primitive	44
8.3.2.7	DL_ENC_KEY primitive	44
8.3.2.8	DL_ENCRYPT primitive	44
8.3.2.9	DL_SERVICE_MOD primitive	45
8.3.3	B-SAP primitives	45
8.3.3.0	List of primitives	45
8.3.3.1	DL_BROADCAST primitive	45
8.3.3.2	DL_EXPEDITED primitive	45
8.4	Primitives to the interworking unit	46
8.4.0	General	46
8.4.1	Parameter definitions	46
8.4.2	LU _X -SAP primitives	46
8.4.2.0	List of primitives	46
8.4.2.1	DL_U_DATA primitive	46
8.4.2.2	DL_U_UNIT_DATA primitive	47
8.4.2.3	DL_U_ERROR primitive	47

9	C-plane peer-to-peer procedures	47
9.1	General	47
9.2	Point-to-point acknowledged operation.....	48
9.2.1	Procedure for the use of the P/F bit	48
9.2.1.1	Class A acknowledged information transfer	48
9.2.1.2	Class B acknowledged information transfer	48
9.2.2	Use of LLN	48
9.2.2.1	Class A operation	48
9.2.2.2	Class B operation	48
9.2.3	Link establishment and information transfer in class A operation.....	49
9.2.3.1	Establishing class A operation	49
9.2.3.2	Class A acknowledged information transfer	49
9.2.3.3	Transmission of class A I-frames	50
9.2.3.4	Reception of class A I-frames	50
9.2.3.5	Receiving acknowledgements	50
9.2.3.6	Waiting for acknowledgement	51
9.2.3.7	Release of class A operation	51
9.2.3.8	Re-establishment of class A operation	51
9.2.4	Establishing class B multiple frame operation.....	52
9.2.4.1	Overview	52
9.2.4.2	Class B multiple frame establishment procedures.....	52
9.2.4.3	Class B LLN assignment procedures	53
9.2.4.3.0	General	53
9.2.4.3.1	PT establishment	54
9.2.4.3.2	FT establishment	54
9.2.5	Link maintenance and information transfer in class B multiple frame operation	54
9.2.5.0	General	54
9.2.5.1	Transmitting I-frames.....	55
9.2.5.2	Receiving I-frames	55
9.2.5.2.0	General	55
9.2.5.2.1	P bit set to 1	55
9.2.5.2.2	P bit set to 0.....	55
9.2.5.3	Sending and receiving acknowledgements.....	56
9.2.5.3.1	Sending acknowledgements	56
9.2.5.3.2	Receiving acknowledgements	56
9.2.5.4	Receiving REJ-frames.....	56
9.2.5.5	Receiving RNR-frames	57
9.2.5.6	LAPC own receiver busy condition	58
9.2.5.7	Waiting acknowledgement.....	59
9.2.5.8	Appropriate supervisory frame.....	59
9.2.6	Release of class B multiple frame operation.....	59
9.2.7	Link suspension and resumption.....	60
9.2.7.1	Link suspension.....	60
9.2.7.1.0	General	60
9.2.7.1.1	Class B acknowledged suspend.....	60
9.2.7.1.2	Unacknowledged suspend	61
9.2.7.2	Class B link resumption	62
9.2.7.3	Connection handover	63
9.2.7.3.0	General	63
9.2.7.3.1	Class A connection handover	65
9.2.7.3.2	Class B connection handover	65
9.2.7.3.3	Expiry of connection handover timer	66
9.2.8	Re-establishment of class B multi-frame operation	66
9.2.8.1	Criteria for re-establishment.....	66
9.2.8.2	Procedure	66
9.2.9	Exception handling	67
9.2.9.1	General	67
9.2.9.2	Class B exception condition reporting and recovery.....	67
9.2.9.2.0	General	67
9.2.9.2.1	N(S) sequence error	67
9.2.9.2.2	N(R) sequence error	68
9.2.9.2.3	Timer recovery condition	68

9.2.9.2.4	Collision of identical transmitted and received commands	68
9.3	Unacknowledged operation	68
9.3.1	Use of LLN for unacknowledged information transfer	68
9.3.2	Class U link establishment	68
9.3.3	Unacknowledged information transfer	68
9.3.3.1	Transmission of unacknowledged information	68
9.3.3.2	Reception of unacknowledged information	68
9.3.4	Unacknowledged release	69
9.4	Broadcast operation	69
9.4.1	Normal operation	69
9.4.1.1	Procedure in the Fixed radio Termination (FT)	69
9.4.1.2	Procedure in the Portable radio Termination (PT)	69
9.4.2	Expedited operation	69
9.4.2.1	Procedure in the Fixed radio Termination (FT)	69
9.4.2.2	Procedure in the Portable radio Termination (PT)	70
9.5	MAC layer interfaces	70
9.5.1	MC-SAP	70
9.5.1.1	C-plane overview	70
9.5.1.2	C-plane service data procedures	70
9.5.1.3	U-plane service data	71
9.5.2	MB-SAP	71
9.5.2.0	General	71
9.5.2.1	C-plane service data procedures	71
9.5.2.2	U-plane service data	72
9.5.3	MA-SAP	72
9.5.3.1	Overview	72
9.5.3.2	Service data procedures	72
10	Management procedures	72
10.1	Lower Layer Management Entity (LLME)	72
10.2	MAC connection management	73
10.2.0	General	73
10.2.1	MAC connection set-up	73
10.2.2	MAC connection release	73
10.2.3	MAC connection modification	74
10.2.4	MAC connection identifiers	74
10.2.4.1	Overview	74
10.2.4.2	Advanced MAC Connection Identifiers (AMCI)	75
10.2.4.3	Basic MAC Connection Identifiers (BMCI)	75
10.2.4.4	MAC Connection Endpoint Identifier (MCEI)	75
10.2.5	Selection of logical channel (C _S or C _F)	75
10.3	DLC C-plane (LAPC) management	76
10.3.0	General	76
10.3.1	Provision of link signature	76
10.3.2	Routing of connection oriented links	77
10.3.3	Routing of connectionless links	77
10.4	DLC U-plane (LUX) management	77
10.4.0	General	77
10.4.1	U-plane establishment	77
10.4.2	U-plane release	78
10.4.3	U-plane suspend and resume	78
10.5	Connection handover management	78
10.6	Ciphering management	79
10.6.1	Ciphering management in cases where the NWK layer executes the ciphering related MM procedure	79
10.6.1.0	General	79
10.6.1.1	Providing a key to the MAC layer	79
10.6.1.2	Starting and stopping the ciphering	79
10.6.1.3	Connection handover	79
10.6.2	Ciphering management in cases where the NWK layer does not execute the ciphering related MM procedure	80
10.7	Broadband data link management	80

11	U-plane service characteristics	80
11.1	General	80
11.2	LU1 TRansparent UnProtected service (TRUP)	81
11.3	LU2 Frame RELay service (FREL).....	82
11.3.1	General.....	82
11.3.2	Checksum operation	83
11.3.3	Segmentation and transmission class	83
11.3.4	Data transmission.....	84
11.3.4.1	Send side procedure	84
11.3.4.2	Receive side procedure	84
11.4	LU3 Frame SWITching service (FSWI).....	84
11.5	LU4 Forward Error Correction (FEC) service.....	85
11.6	LU5 Basic RATE adaption service (BRAT).....	85
11.6.1	Overview	85
11.6.2	Protected service operation	86
11.6.2.1	General	86
11.6.2.2	Data buffering and initial rate adaptation.....	87
11.6.2.3	Multi-channel set multiplexing	88
11.6.2.4	Segmentation of Multiplexed Data Units (MDU).....	89
11.6.2.5	Frame sequencing and addition of control and fill octets.....	90
11.6.2.6	Frame transmission	91
11.6.3	Unprotected service operation	91
11.6.3.1	General	91
11.6.3.2	Data buffering and initial rate adaption.....	92
11.6.3.3	Multi-channel set multiplexing	92
11.6.3.4	Segmentation of MDUs.....	93
11.6.3.5	Frame transmission	93
11.7	LU6 Secondary RATE adaption (SRAT) service	94
11.7.1	General.....	94
11.8	LU16 ESCape Service (ESC).....	95
11.8.1	General.....	95
11.9	LU7 64 kbit/s data bearer service	95
11.9.1	General.....	95
11.9.2	Physical layer service.....	95
11.9.3	MAC layer service	96
11.9.4	DLC layer service	96
11.9.4.1	Architectural model.....	96
11.9.4.1.0	General	96
11.9.4.1.1	Transmit (Tx) frame buffering	96
11.9.4.1.2	Receive (Rx) frame buffering.....	96
11.9.4.2	Automatic-Repeat-Request (ARQ) and Forward Error Control (FEC).....	97
11.9.4.2.0	General	97
11.9.4.2.1	Control field	98
11.9.4.2.2	Information field.....	100
11.9.4.2.3	ARQ checksum.....	101
11.9.4.3	Procedures for normal operation	101
11.9.4.3.0	General	101
11.9.4.3.1	Establishment and synchronization procedures	101
11.9.4.3.2	Active phase	103
11.9.4.3.3	Release.....	105
11.9.4.4	Exceptional procedures	105
11.9.4.4.0	General	105
11.9.4.4.1	Invalid frame condition	105
11.9.4.4.2	Establishment	105
11.9.4.4.3	Transmitting frames.....	105
11.9.4.4.4	Receiving frames	105
11.9.4.4.5	Sending acknowledgements	105
11.9.4.4.6	Forwarding of received data	105
11.9.4.4.7	N(R) sequence error	106
11.9.4.4.8	N(O) sequence error	106
11.9.4.4.9	N(S) sequence error.....	106
11.9.4.4.10	Format error.....	107

11.9.4.4.11	Abnormal release.....	107
11.9.4.4.12	Implicit reset.....	107
11.9.5	Network layer service	107
11.9.5.1	LCE service.....	107
11.9.5.2	CC service.....	107
11.10	LU8 service	107
11.10.0	General.....	107
11.10.1	Physical layer service.....	107
11.10.2	MAC layer service.....	108
11.10.3	DLC layer service.....	108
11.11	LU9 - Unprotected Rate Adaption for V series Equipment (RAVE) Service	108
11.11.1	Overview	108
11.11.1.0	General.....	108
11.11.1.1	FU9 frame structure	109
11.11.1.1.1	General frame structure	109
11.11.1.1.2	FU9 buffering procedures.....	109
11.11.1.1.3	Connection handover.....	109
11.11.1.1.4	Transmission order.....	109
11.11.2	Alignment signal management	110
11.11.2.1	General.....	110
11.11.2.2	Procedures.....	110
11.11.3	V.24 Signalling.....	111
11.11.3.1	General.....	111
11.11.3.2	Transmitter procedures.....	112
11.11.3.3	Receiver procedures.....	112
11.11.4	Rate Coding	112
11.11.4.1	General.....	112
11.11.4.2	Transmitter procedures.....	113
11.11.4.3	Receiver procedures.....	113
11.11.5	DECT Independent Clocking (DIC).....	114
11.11.5.1	General.....	114
11.11.5.2	Measurement of phase differences.....	114
11.11.5.3	Compensation control rules.....	115
11.11.5.3.1	General.....	115
11.11.5.3.2	Optimizing error resilience.....	115
11.11.6	Information field.....	116
11.11.6.1	General.....	116
11.11.6.2	User data rates.....	116
11.11.6.3	Information field filling rule	116
11.11.7	Primitives.....	117
11.12	LU10 Enhanced Frame RELay (EFREL) service	118
11.12.1	General.....	118
11.12.2	Segmentation and transmission class.....	119
11.12.3	Data transmission.....	119
11.12.3.1	Send side procedures.....	119
11.12.3.1.0	General.....	119
11.12.3.1.1	"Early transmission" option.....	120
11.12.3.2	Receive side procedure	120
11.12.3.2.0	General.....	120
11.12.3.2.1	Standard SDU delivery mode	120
11.12.3.2.2	In-sequence SDU delivery mode.....	120
11.12.3.2.3	PDU-in-sequence delivery mode.....	121
11.12.3.2.4	PDU-as-received delivery mode.....	121
11.12.4	SDU boundaries definition	121
11.12.4.0	General.....	121
11.12.4.1	Infinite SDU mode.....	121
11.12.5	Use over C/L downlink channels.....	122
11.12.5.0	General.....	122
11.12.5.1	Use over C/L downlink channels: unicast mode.....	122
11.12.5.2	Use over C/L downlink channels: multicast mode.....	122
11.12.5.2.0	General.....	122
11.12.5.2.1	DLC acknowledgement in multicast mode.....	122

11.13	LU11 service	122
11.13.0	General.....	122
11.13.1	Physical layer service.....	122
11.13.2	MAC layer service	122
11.13.3	DLC layer service	123
11.14	LU12 UNprotected Framed service (UNF)	123
11.14.1	General.....	123
11.14.2	DLC layer service	123
11.14.2.0	General	123
11.14.2.1	Segmentation.....	124
11.14.2.2	Data transmission.....	125
11.14.2.2.1	Send side procedure.....	125
11.14.2.2.2	Receive side procedure.....	125
11.15	LU13 Enhanced Frame RELay service with CRC (EFREL-CRC)	126
11.15.1	General.....	126
11.15.2	SDU CRC generation.....	126
11.15.3	Use over C/L downlink channels	126
11.15.3.0	General	126
11.15.3.1	Use over C/L downlink channels: unicast mode	127
11.15.3.2	Use over C/L downlink channels: multicast mode	127
11.15.3.2.0	General	127
11.15.3.2.1	DLC acknowledgement in multicast mode.....	127
11.16	LU14 Enhanced Frame RELay service with CCM (EFREL-CCM)	127
11.16.1	General.....	127
11.16.2	LU14 SDU structure	127
11.16.2.0	General	127
11.16.2.1	SDU sizes.....	128
11.16.2.2	Security model	128
11.16.2.3	SDU processing.....	128
11.16.2.4	Limitations	129
11.16.2.5	CCM sequence numbers	129
11.16.2.6	CCM control procedures	129
11.16.3	Use over C/L downlink channels	129
11.16.3.0	General	129
11.16.3.1	Use over C/L downlink channels: unicast mode	129
11.16.3.2	Use over C/L downlink channels: multicast mode	130
11.16.3.2.0	General	130
11.16.3.2.1	DLC acknowledgement in multicast mode.....	130
12	Frame structures for U-plane services	130
12.1	General	130
12.2	FU1 frame structure.....	131
12.2.1	General frame structure	131
12.2.2	FU1 buffering procedures.....	132
12.2.3	Minimum delay (speech) operation	132
12.2.4	Connection handover	133
12.2.5	Transmission order	133
12.3	FU2 frame structure.....	133
12.3.1	General frame structure	133
12.3.2	FU2 buffering procedures.....	134
12.3.3	Connection handover	134
12.3.4	Transmission order	134
12.4	FU3 frame structure.....	134
12.4.1	General frame structure	134
12.4.2	FU3 buffering procedures.....	135
12.4.3	Connection handover	136
12.4.4	Transmission order	136
12.5	FU4 frame structure.....	136
12.5.1	General frame structure	136
12.5.2	FU4 buffering procedures.....	137
12.5.3	Connection handover	137
12.5.4	Transmission order	137

12.6	FU5 frame structure.....	137
12.6.1	General frame structure	137
12.6.2	FU5 buffering procedures.....	138
12.6.3	Connection handover	139
12.6.4	Transmission order	139
12.7	FU6 frame structure.....	139
12.7.1	General frame structure	139
12.7.2	FU6 buffering procedures.....	140
12.7.3	Connection handover.....	140
12.7.4	Transmission order	140
12.8	FU7 frame structure.....	140
12.9	FU8 frame structure.....	140
12.10	FU9 frame structure.....	140
12.11	FU10 frame structure.....	141
12.11.1	General frame structure	141
12.11.1.0	General	141
12.11.1.1	Specific for MAC service I_{PK}	143
12.11.2	Transmission of FU10c and FU10d frames	144
12.11.2.0	General	144
12.11.2.1	Insertion of the FU10c frame in an FU10a frame of the opposite link.....	144
12.11.2.2	Transmission of the F10c frame using the G_F channel.....	144
12.11.2.3	Insertion of the FU10d frame in an FU10a frame of the opposite link	145
12.11.2.4	Transmission of the FU10d frame using the G_{FA} channel.....	145
12.11.3	FU10 buffering procedures	145
12.11.4	Connection handover	145
12.11.5	Transmission order	145
12.12	FU12 frame structure.....	146
12.12.1	General frame structure	146
12.12.2	FU12 buffering procedures	146
12.12.3	Connection handover	147
12.12.4	Transmission order	147
13	Elements of procedures and formats of fields for U-plane peer-to-peer communication	147
13.1	General	147
13.2	Address elements.....	147
13.2.1	Address field format	147
13.2.2	Address field parameters	148
13.3	Length indicator elements	148
13.3.1	Length indicator field format	148
13.3.1.1	Length indicator field format for all services except LU10	148
13.3.1.2	Length indicator field format for service LU10	148
13.3.2	Length indicator field parameters	149
13.3.2.1	Length indicator field parameters for all services except LU10.....	149
13.3.2.2	Length indicator field parameters for LU10 service	150
13.3.2.2.0	General	150
13.3.2.2.1	Meaning of the more (M) bit	152
13.4	Sequence number elements	153
13.4.1	Send sequence number format.....	153
13.4.2	Send sequence number parameters	153
13.4.3	Receive sequence number format	153
13.4.4	Receive sequence number parameters	154
13.5	Fill elements - Fill field format	154
14	U-plane peer-to-peer procedures	154
14.1	General	154
14.2	Frame transmission principles.....	154
14.2.1	Sequence numbering.....	154
14.2.2	Acknowledgements.....	155
14.2.2.1	Sending acknowledgements	155
14.2.2.2	Receiving acknowledgements	155
14.2.3	Transmission classes.....	155
14.2.3.0	General	155

14.2.3.1	Class 0: No LU _X retransmission or sequencing.....	155
14.2.3.2	Class 1: no LU _X retransmission.....	156
14.2.3.2.0	General	156
14.2.3.2.1	Class 1: use over C/L downlink channels.....	156
14.2.3.3	Class 2: variable throughput, limited delay LU _X retransmission.....	156
14.2.3.4	Class 3: fixed throughput LU _X retransmission	157
14.2.4	Operation parameter negotiation.....	157
14.3	Frame transmission procedures	157
14.3.1	General.....	157
14.3.2	Class 0 procedures	157
14.3.2.0	General	157
14.3.2.1	Sending side procedure	158
14.3.2.2	Receiving side procedure	158
14.3.3	Class 1 procedures	158
14.3.3.0	General.....	158
14.3.3.1	Sending side procedure	158
14.3.3.2	Receiving side procedure	159
14.3.4	Class 2 procedures	159
14.3.4.0	General	159
14.3.4.1	Sending side procedure	159
14.3.4.1.0	General	159
14.3.4.1.1	Synchronization message sending side procedure (LU10).....	161
14.3.4.1.2	Tx side end-of-activity rule	161
14.3.4.1.3	Abnormal SDU termination/abort signal (LU10 only).....	162
14.3.4.1.4	Retransmission procedure.....	163
14.3.4.2	Receiving side procedure	163
14.3.4.2.0	General	163
14.3.4.2.1	Acknowledgement procedure	163
14.3.4.2.2	Rx side end-of-activity rule	165
14.3.4.2.3	Retransmission request procedure	165
14.3.4.2.4	SDU delivery procedure	166
14.3.4.2.5	Synchronization message receiver side procedure (LU10).....	166
14.3.4.2.6	Reception of an abnormal SDU termination/abort signal (LU10).....	167
14.3.5	Class 3 procedures	167
14.3.5.0	General	167
14.3.5.1	Sending side procedure	167
14.3.5.2	Receiving side procedure	168
Annex A (normative): System parameters.....		170
A.1	LAPC timer values	170
A.2	U-plane timer values	171
A.3	Constants	171
A.3.1	Retransmission counter (N250).....	171
A.3.2	Maximum number of CHO attempts (N251)	171
Annex B (normative): Checksum algorithms.....		172
B.1	Arithmetic conventions	172
B.2	Coding algorithm.....	172
B.3	Decoding algorithm.....	172
B.4	Some examples.....	173
Annex C (informative): MAC connection states.....		174
Annex D (normative): Mapping of agreed channel rates to MCS sizes		175
D.0	General	175
D.1	Protected class operation	175

D.2	Unprotected class operation	176
Annex E (normative):	LU12 applications	177
E.1	G.729.1 over 32 kbit/s channel.....	177
E.1.0	General	177
E.1.1	G.729.1 payload format.....	177
E.1.1.0	General.....	177
E.1.1.1	G.729.1 payload header coding	178
E.1.2	Operations	180
E.1.2.1	Encoder bit rate.....	180
E.1.2.2	Protection against random errors	180
Annex F (informative):	Bibliography	181
Annex G (informative):	Change history	182
History		183

Intellectual Property Rights

Essential patents

IPRs essential or potentially essential to normative deliverables may have been declared to ETSI. The information pertaining to these essential IPRs, if any, is publicly available for **ETSI members and non-members**, and can be found in ETSI SR 000 314: "*Intellectual Property Rights (IPRs); Essential, or potentially Essential, IPRs notified to ETSI in respect of ETSI standards*", which is available from the ETSI Secretariat. Latest updates are available on the ETSI Web server (<https://ipr.etsi.org/>).

Pursuant to the ETSI IPR Policy, no investigation, including IPR searches, has been carried out by ETSI. No guarantee can be given as to the existence of other IPRs not referenced in ETSI SR 000 314 (or the updates on the ETSI Web server) which are, or may be, or may become, essential to the present document.

Trademarks

The present document may include trademarks and/or tradenames which are asserted and/or registered by their owners. ETSI claims no ownership of these except for any which are indicated as being the property of ETSI, and conveys no right to use or reproduce any trademark and/or tradename. Mention of those trademarks in the present document does not constitute an endorsement by ETSI of products, services or organizations associated with those trademarks.

Foreword

This draft European Standard (EN) has been produced by ETSI Technical Committee Digital Enhanced Cordless Telecommunications (DECT), and is now submitted for the combined Public Enquiry and Vote phase of the ETSI standards EN Approval Procedure.

The present document is part 4 of a multi-part deliverable ([1] to [8]). Full details of the entire series can be found in part 1 [1].

Further details of the DECT system may be found in ETSI TR 101 178 [i.1] and ETSI ETR 043 [i.2].

Proposed national transposition dates	
Date of latest announcement of this EN (doa):	3 months after ETSI publication
Date of latest publication of new National Standard or endorsement of this EN (dop/e):	6 months after doa
Date of withdrawal of any conflicting National Standard (dow):	18 months after doa

Modal verbs terminology

In the present document "**shall**", "**shall not**", "**should**", "**should not**", "**may**", "**need not**", "**will**", "**will not**", "**can**" and "**cannot**" are to be interpreted as described in clause 3.2 of the [ETSI Drafting Rules](#) (Verbal forms for the expression of provisions).

"**must**" and "**must not**" are **NOT** allowed in ETSI deliverables except when used in direct citation.

1 Scope

The present document is one of the parts of the specification of the Digital Enhanced Cordless Telecommunications (DECT) Common Interface (CI).

The present document specifies the Data Link Control (DLC) layer. The DLC layer is part 4 of the DECT CI standard and layer 2b of the DECT protocol stack.

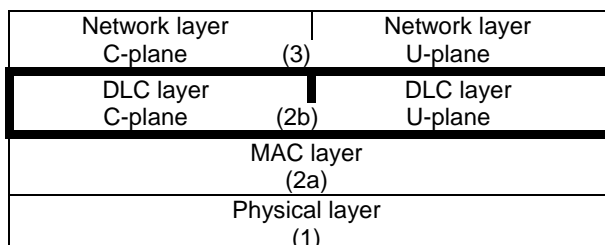

Figure 1.1

Two planes of operation are specified for this DLC (sub)layer. These planes are called the Control plane (C-plane) and the User plane (U-plane).

The C-plane is mostly concerned with the DECT signalling aspects. It provides a reliable point-to-point service that uses a link access protocol to offer error protected transmission of Network (NWK) layer messages. The C-plane also provides a separate point-to-multipoint (broadcast) service (Lb).

The U-plane is only concerned with end-to-end user information. This plane contains most of the application dependent procedures of DECT. Several alternative services (both circuit-mode and packet-mode) are defined as a family of independent entities. Each service provides one or more point-to-point U-plane data links, where the detailed characteristics of those links are determined by the particular needs of each service. The defined services cover a wide range of performance, from "unprotected with low delay" for speech applications to "highly protected with variable delay", for local area network applications.

NOTE: The performance of the DLC services need not be tight to any particular application. For example the "unprotected with low delay" service could also be used for data applications, e.g. if some data protection is provided outside the DECT protocol.

The present document uses the layered model principles and terminology as described in Recommendations ITU-T X.200 [14] and X.210 [15].

The present document includes New Generation DECT, a further development of the DECT standard introducing wideband speech, improved data services, new slot types and other technical enhancements.

2 References

2.1 Normative references

References are either specific (identified by date of publication and/or edition number or version number) or non-specific. For specific references, only the cited version applies. For non-specific references, the latest version of the referenced document (including any amendments) applies.

Referenced documents which are not found to be publicly available in the expected location might be found at <http://docbox.etsi.org/Reference>.

NOTE: While any hyperlinks included in this clause were valid at the time of publication, ETSI cannot guarantee their long term validity.

The following referenced documents are necessary for the application of the present document.

- [1] ETSI EN 300 175-1: "Digital Enhanced Cordless Telecommunications (DECT); Common Interface (CI); Part 1: Overview".
- [2] ETSI EN 300 175-2: "Digital Enhanced Cordless Telecommunications (DECT); Common Interface (CI); Part 2: Physical Layer (PHL)".
- [3] ETSI EN 300 175-3: "Digital Enhanced Cordless Telecommunications (DECT); Common Interface (CI); Part 3: Medium Access Control (MAC) layer".
- [4] Void.
- [5] ETSI EN 300 175-5: "Digital Enhanced Cordless Telecommunications (DECT); Common Interface (CI); Part 5: Network (NWK) layer".
- [6] ETSI EN 300 175-6: "Digital Enhanced Cordless Telecommunications (DECT); Common Interface (CI); Part 6: Identities and addressing".
- [7] ETSI EN 300 175-7: "Digital Enhanced Cordless Telecommunications (DECT); Common Interface (CI); Part 7: Security features".
- [8] ETSI EN 300 175-8: "Digital Enhanced Cordless Telecommunications (DECT); Common Interface (CI); Part 8: Speech and audio coding and transmission".
- [9] ETSI TS 144 006: "Digital cellular telecommunications system (Phase 2+) (GSM); Mobile Station - Base Station System (MS - BSS) interface; Data Link (DL) layer specification (3GPP TS 44.006)".
- [10] Recommendation ITU-T Q.920: "ISDN user-network interface data link layer - General aspects".
- [11] Recommendation ITU-T Q.921: "ISDN user-network interface - Data link layer specification".
- [12] Recommendation ITU-T V.42: "Error-correcting procedures for DCEs using asynchronous-to-synchronous conversion".
- [13] Recommendation ITU-T V.110: "Support by an ISDN of data terminal equipments with V-Series type interfaces".
- [14] Recommendation ITU-T X.200: "Information technology - Open Systems Interconnection - Basic Reference Model: The basic model".
- [15] Recommendation ITU-T X.210: "Information technology - Open Systems Interconnection - Basic Reference Model: Conventions for the definition of OSI services".
- [16] ISO/IEC 8073: "Information technology -- Open Systems Interconnection -- Protocol for providing the connection-mode transport service".
- [17] ETSI EN 301 649: "Digital Enhanced Cordless Telecommunications (DECT); DECT Packet Radio Service (DPRS)".
- [18] National Institute of Standards and Technology (NIST) FIPS Publication 197 (2001): "Advanced Encryption Standard (AES)".
- [19] IETF RFC 3610: "Counter with CBC-MAC (CCM)".

2.2 Informative references

References are either specific (identified by date of publication and/or edition number or version number) or non-specific. For specific references, only the cited version applies. For non-specific references, the latest version of the referenced document (including any amendments) applies.

NOTE: While any hyperlinks included in this clause were valid at the time of publication, ETSI cannot guarantee their long term validity.

The following referenced documents are not necessary for the application of the present document but they assist the user with regard to a particular subject area.

- [i.1] ETSI TR 101 178: "Digital Enhanced Cordless Telecommunications (DECT); A High Level Guide to the DECT Standardization".
- [i.2] ETSI ETR 043: "Digital Enhanced Cordless Telecommunications (DECT); Common Interface (CI); Services and facilities requirements specification".
- [i.3] Recommendation ITU-T I.122: "Framework for frame mode bearer services".
- [i.4] Recommendation ITU-T V.24: "List of definitions for interchange circuits between Data Terminal Equipment (DTE) and data circuit-terminating equipment (DCE)".
- [i.5] IETF RFC 4749: "RTP Payload Format for the G.729.1 Audio Codec".

3 Definition of terms, symbols and abbreviations

3.1 Terms

For the purposes of the present document, the terms given in ETSI EN 300 175-1 [1] apply.

3.2 Symbols

For the purposes of the present document, the following symbols apply:

B_S	A logical channel to the MAC layer
C_F	higher layer signalling Channel (fast)
CL	higher layer ConnectionLess channel (protected; see CL_S and CL_F)
CL_F	higher layer ConnectionLess channel (fast), (logical channel to the MAC layer)
CL_S	higher layer Connectionless channel (slow)
C_S	higher layer signalling Channel (slow)
G_F	higher layer information control channel (fast) (a logical channel to the MAC layer)
G_{FA}	higher layer information control channel (slow) (a logical channel to the MAC layer)
I_N	higher layer Information channel (unprotected), (logical channels to the MAC layer)
I_{NA}	higher layer Information channel (unprotected), minimum delay operation
I_{NB}	higher layer Information channel (unprotected), normal delay operation
I_P	higher layer Information channel (protected), (logical channels to the MAC layer)
I_{PF}	higher layer Information channel (protected) transported multiplexed with signalling in the E+U type slots
I_{PK}	higher layer Information channel protected, with constant-size subfield format
I_{PKR}	higher layer Information channel protected, with constant-size subfield format and error correction
I_{PM}	higher layer Information channel (protected) with multi subfield format
I_{PMR}	higher layer Information channel (protected) with multi subfield format, with error correction using MOD-2 retransmission mechanism
I_{PQ}	higher layer Information channel (protected) with single subfield format
I_{PQR}	higher layer Information channel (protected) with single subfield format, with error correction using MOD-2 retransmission mechanism
I_{PX}	higher layer Information channel, encodec protected, minimum delay operation
SI_N	higher layer connectionless channel (Unprotected)
SI_P	higher layer connectionless channel (Protected)
SI_{PF}	higher layer connectionless channel (protected) transported multiplexed with signalling in the E+U type slots

3.3 Abbreviations

For the purposes of the present document, the following abbreviations apply:

AAL	ATM Adaptation Layers
ACK	ACKnowledgement
ADU	Adapted Data Unit
AES	Advanced Encryption Standard
ALI	Assigned Link Identifier
AMCI	Advanced MAC Connection Identifier
ARI	Access Rights Identity
ARQ	Automatic Repeat reQuest
ASM	Assigned link identifier with Synchronous Mode
ATM	Asynchronous Transfer Mode
BCH	Bose-Chaudhuri-Hochquenghem
BER	Bit Error Ratio
BFI	Bad Frame Indicator
BMCI	Basic MAC Connection Identifier
BRAT	Basic RATE adaption service
C/R	Command/Response bit
CBC-MAC	Cipher Block Chaining Message Authentication Code
CC	Call Control
CCM	Counter with CBC-MAC
CHO	Connection HandOver
CHP	Connection Handover Pending
CI	Common Interface
C-plane	Control plane
CRC	Cyclic Redundancy Check
CTS	Clear To Send (see Recommendation ITU-T V.24 [i.4])
DCD	Data Carrier Detect (see Recommendation ITU-T V.24 [i.4])
DECT	Digital Enhanced Cordless Telecommunications
DIC	DECT Independent Clocking
DISC	DISConnect
DLC	Data Link Control
DLEI	Data Link Endpoint Identifier (DLC layer)
DLI	Data Link Identifier (DLC layer)
DM	Disconnect Mode
DPRS	DECT Packet Radio Service
E+U type	B-field multiplexer mode when the slot carries U-plane data (channel I _{PF}) AND signalling (channels G _F and M)
ECN	Exchanged Connection Number (DLC/MAC layer)
EFREL	Enhanced Frame RELay
ESC	ESCape
EXOR	EXclusive OR
FB _N	Frame Buffer (Unprotected)
FB _P	Frame Buffer (Protected)
FB _x	Frame Buffer x
FCS	Frame Check Sequence
FEC	Forward Error Correction service
FIFO	First-In-First-Out
FLEN	Frame LENgth
FP	Fixed Part
FREL	Frame RELay service
FSWI	Frame SWItching service
FT	Fixed radio Termination
FU	DECT DLC U-Plane Frame format
GBN	Go Back N
GSM	Global System for Mobile communications
HLM	High Level Modulation
HOV	HandOver flag

IE	Information Element
IP	Internet Protocol
ISDN	Integrated Services Digital Network
IV	Initialization Vector
IWF	InterWorking Function
IWU	InterWorking Unit
LAN	Local Area Network
LAPC	DLC layer C-plane upper protocol entity
LAPD	Link Access Procedure on the D-channel
LAPM	Link Access Procedure for Modems (see Recommendation ITU-T V.42 [12])
LAPU	Link Access Protocol User
Lb	DLC layer C-plane protocol entity for broadcast service
LBN	Logical Bearer Number
Lc	DLC layer C-plane lower protocol entity
LCE	Link Control Entity
LCN	Logical Connection Number (DLC/MAC layer)
LI	Length Indicator
LLME	Lower Layer Management Entity
LLN	Logical Link Number (DLC layer)
lsb	least significant bit
LSIG	Link SIGNature
LU	DECT DLC U-Plane Service
LU _x	LAP-U service x
MAC (CCM)	Message Authentication Code
MAC	Medium Access Control
MBS	Maximum Bit rate (LU12)
MCEI	MAC Connection Endpoint Identification
MCI	MAC Connection Identifier
MCS	Multi-Channel Set
MDU	Multiplexed Data Unit
ME	Management Entity
MIC	Message Integrity Code
MM	Mobility Management
MOS	Mean Opinion Score
msb	most significant bit
N(S)	Send sequence number
NACK	Negative ACKnowledgement
NLF	New Link Flag
NWK	NetWorK
PA	PArity
PAD	Packet Assembler/Disassembler
PDU	Protocol Data Unit
PH	Parity Header
PMID	Portable part MAC IDentity (MAC layer)
PP	Portable Part
PSTN	Public Switched Telephone Network
PT	Portable radio Termination
RA	Rate Adaptation
RAVE	Rate Adaption for V. series Equipment
REJ	REJect
RES	REServed
RFP	Radio Fixed Part
RFPI	Radio Fixed Part Identity
RN	Receive sequence Numbers
RNR	Receive Not Ready
RR	Receive Ready
RS	Receive Sequence
RSN	Receive Sequence Number
SABM	Set Async Bal Mode
SAP	Service Access Point
SAPI	Service Access Point Identifier
SCBO	Synchronous Continuous Bitstream Oriented

SDU	Service Data Unit
SEL	SElective
SN	Sequence Numbers
SRAT	Secondary RATE adaption service
TAF	Terminal Adaptation Function
TCP	Transmission Control Protocol
TDMA	Time Division Multiple Access
TPUI	Temporary Portable User Identity
TRUP	TRansparent UnProtected service
UA	Unnumbered Ack
UCN	U-plane Channel Number
UI	Unnumbered Information
ULEI	U-plane Link Endpoint Identifier
ULI	Unassigned Link Identifier
ULN	U-plane Link Number
UNF	UNprotected Framed service
U-plane	User plane
V(R)	Receive state variable
V(S)	Send state variable

4 Data Link Control (DLC) layer overview

4.1 General

The DLC layer shall contain two independent planes of protocol as shown in figures 4.2.1 and 4.3.1:

- the C-plane; and
- the U-plane.

C-plane (see figure 4.2.1): the C-plane is the control plane of the DECT protocol stacks, which shall contain all of the internal DECT protocol control, but may also include some external user information (and user control).

The DLC C-plane shall provide two independent services:

- the data link service (LAPC+Lc); and
- the broadcast service (Lb).

Each of these services shall be completely independent and they shall be accessed through independent SAPs.

U-plane (see figure 4.3.1): the U-plane is the user plane of the DECT protocol stacks. This plane shall contain most of the end-to-end (external) user information (and user control).

The DLC U-plane shall allow for a family of alternative U-plane services. These services are collectively named LUX, with the individual family members being named LU1, LU2, LU3, etc. Each of these services shall operate completely independently, and they shall be accessed through independent SAPs.

Depending on the higher layers service requirements data links provided by DLC may use a single or multiple MAC connections. Data links that use multiple MAC connections are called Broadband data links whereas those that use single MAC connections are referred through the text of the present document as "normal" or just as "data links".

From the point of view of DLC the number of connections associated with a broadband data connections are seen as a single logical connection identified by the identities related to the first established connection. The usage of the term connection throughout the text in the present document, unless otherwise stated, shall be understood as valid for both, a single physical connection and/or a logical connection.

This statement is not valid in the case of connection handover where all requirements are valid for physical connections only and not for logical connections.

4.2 C-plane services

The C-plane data link service shall be provided by three protocol entities: the paired LAPC and Lc and the Lb. The former two protocol entities separate the link access protocol functions from the lower link control functions. Multiple instances of these entities may exist, each instance corresponding to an independent data link; there is only one Lb entity.

LAPC entity: the upper LAPC entity uses a protocol derived from the ISDN LAPD protocol (Recommendations ITU-T Q.920 [10] and Q.921 [11]). However, LAPC differs from LAPD in several respects:

- frame delimiting uses a length indicator field, as used in GSM, ETSI TS 144 006 [9] (LAPD_M);
- frame lengths are limited to discrete values, using fill fields when necessary;
- LAPC always uses independent lower layer resources (MAC connections) for the DLC data links to each PT;
- LAPC does not support a broadcast type of operation. In the present document, the broadcast operation is provided by the parallel Lb entity.

Lc entity: the lower Lc entity buffers and fragments complete LAPC frames (LAPC protocol data units) to/from the MAC layer.

The C-plane broadcast protocol shall contain only one instance of a lower entity called Lb.

Lb entity: the Lb entity shall provide a restricted broadcast service in the direction FP to PP. It shall operate on simple fixed length frames, and shall use the dedicated MAC layer broadcast service, which duplicates the broadcast information in all active radio transmissions.

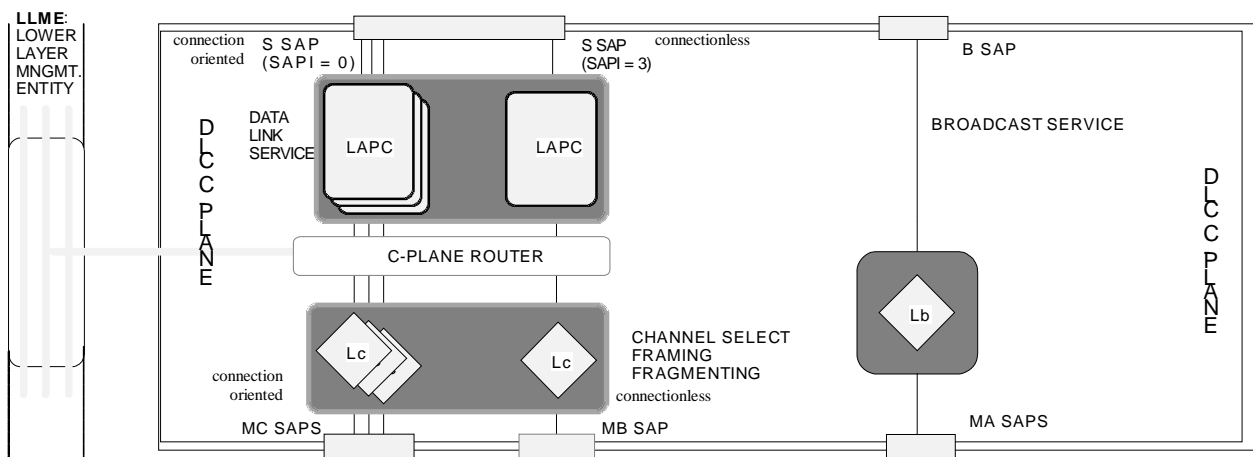

NOTE: There is one set of lower SAPs (one MA, one MB and one MC) for each instance of MAC cluster control functions (see ETSI EN 300 175-3 [3]).

Figure 4.2.1: C-plane model

4.3 U-plane services

The U-plane services are all optional, in the sense that each service corresponds to a particular requirement, and for any given application only selected services may be implemented.

Each U-plane service shall be divided into two entities:

- an upper (LU_x) entity; and
- a lower (FB_x) entity.

The upper (LU_x) entity shall contain all of the service dependent functions, and therefore shall define the majority of the procedures. The lower (FB_x) entity shall buffer and fragment the complete U-plane frames (LU_x protocol data units) to/from the MAC layer.

Several different LUX family members (including multiple instances of each member) may exist in complex DLC implementations. The following family members have been defined:

- LU1: TRansparent UnProtected service (TRUP);
- LU2: FRame RELay service (FREL);
- LU3: FRame SWItching service (FSWD);
- LU4: Forward Error Correction service (FEC);
- LU5: Basic RATE adaption service (BRAT);
- LU6: Secondary RATE adaption service (SRAT);
- LU7: 64 kbit/s data bearer service with ARQ mechanism;
- LU8: 64 kbit/s data bearer service without ARQ mechanism;
- LU9: Unprotected Rate Adaption for V-series Equipment (RAVE) service;
- LU10: Enhanced Frame RELay (EFREL) service;
- LU11: 64 kbit/s data bearer service when A and B field are both modulated at 4 level;
- LU12: UNprotected Framed service (UNF);
- LU13: LU13 Enhanced Frame RELay service with CRC (EFREL-CRC);
- LU14: LU14 Enhanced Frame RELay service with CCM (EFREL-CCM);
- LU15: Reserved for standard family member;
- LU16: ESCape for non-standard family (ESC).

There shall be provision for three additional standard family members to be added to future versions of the present document. There shall also be provision for one non-standard family member; this is provided by means of a general purpose "escape" route that can be used for implementation specific protocols.

NOTE 1: The LU4 services are for further study.

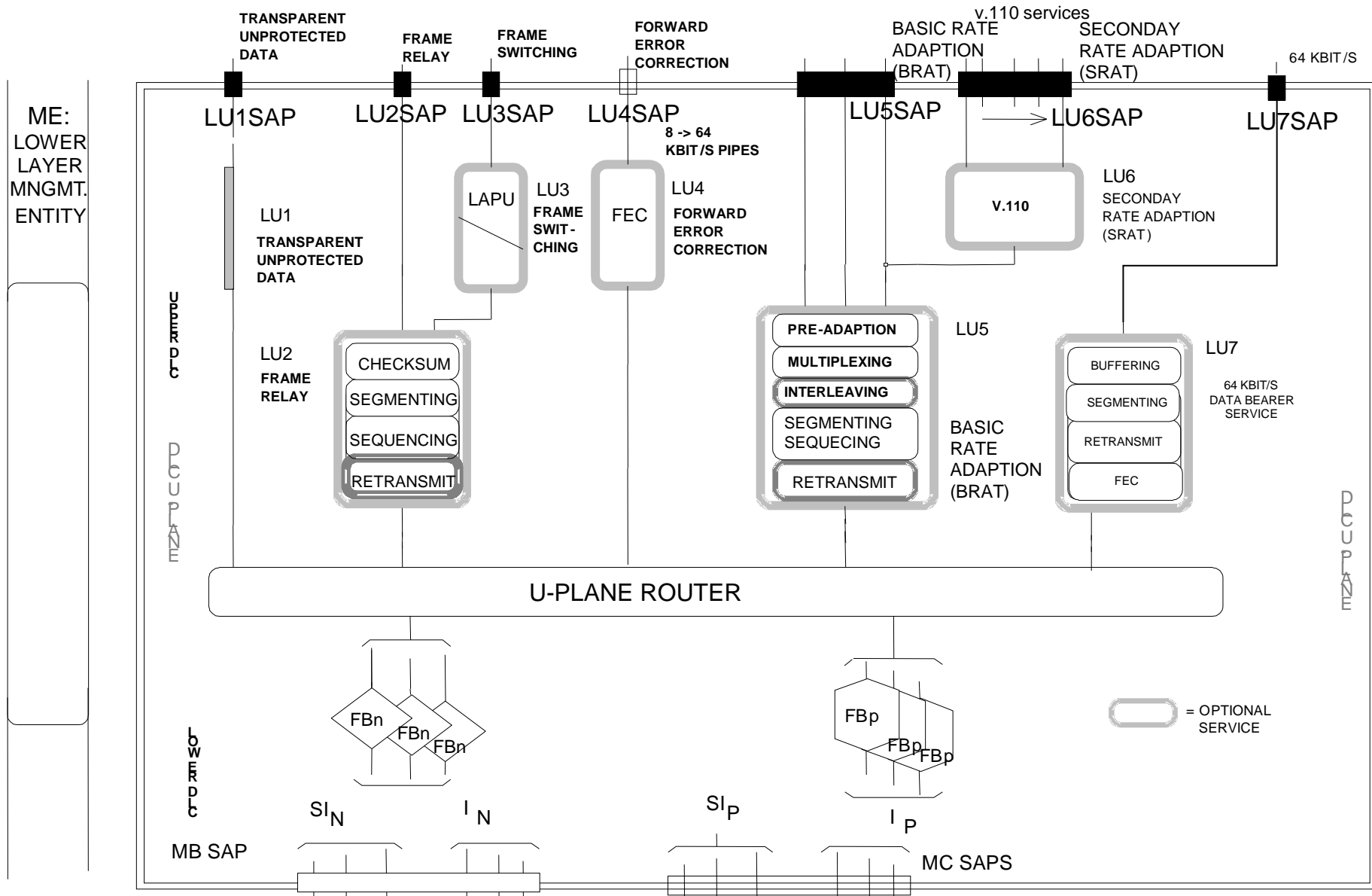

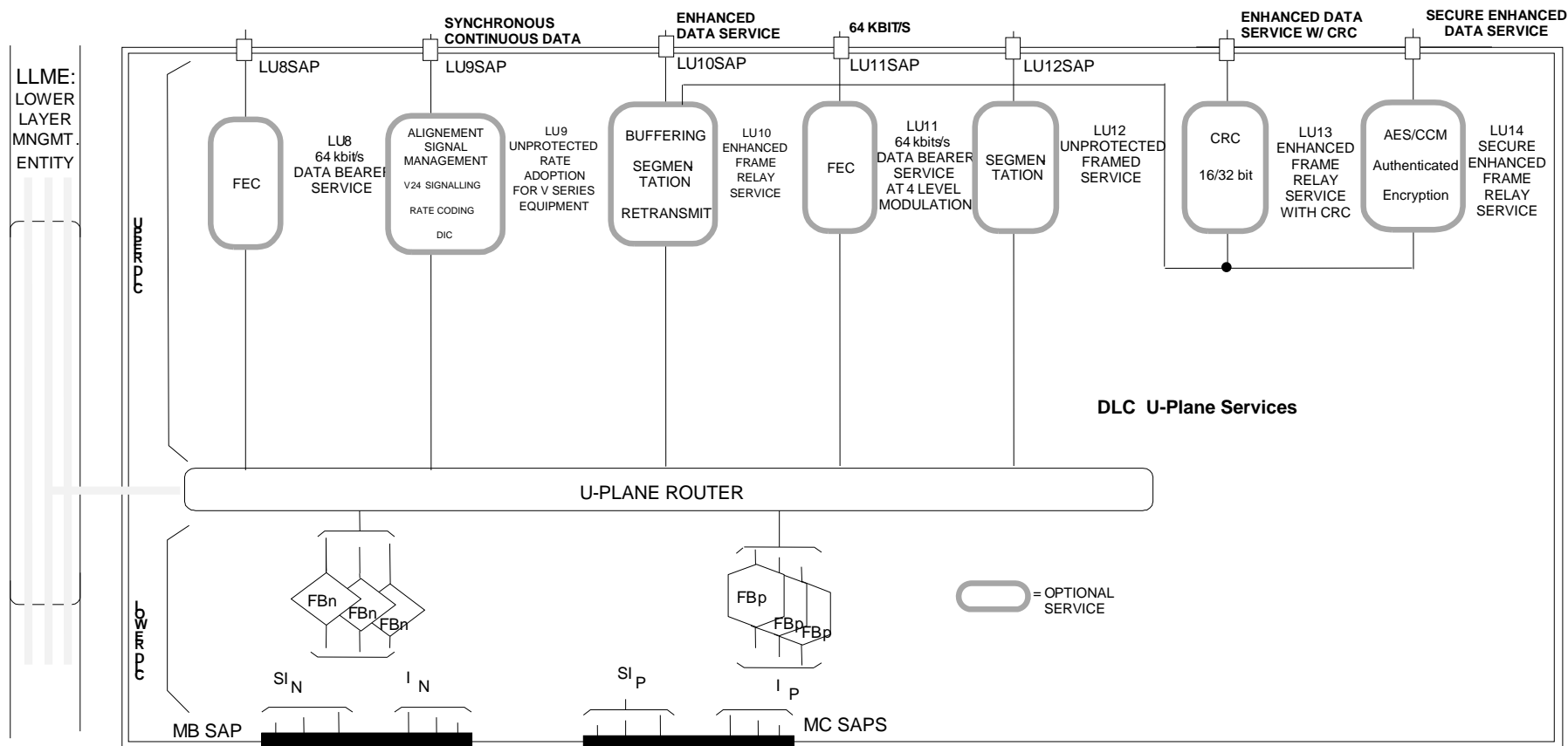

Figure 4.3.1: U-plane model

NOTE 2: Each service is defined by the upper entity. These upper entities use one of two lower (framing) entities - FB_N and FB_P. Independent instances of these lower entities are used for each service as shown in figure 4.3.1.

NOTE 3: There is one set of lower SAPs (one MA, one MB and one MC) for each instance of MAC cluster control functions (see ETSI EN 300 175-3 [3]).

4.4 Lower Layer Management Entity (LLME)

The LLME shall provide co-ordination and control for these independent C-plane and U-plane processes. In particular the LLME shall control the routing of the C-plane and U-plane frames to and from the available MAC connections, and shall control the opening and closing (and handover) of the MAC connections in response to service demands. The LLME operations are defined in general terms in order to allow for different implementations.

4.5 Instantiation in DLC U-plane

Multiple instances of DLC LU services may exist in a FT-PT pair and in a given call. Up to 8 LU instances with separate end-points may be created. The 8 instances may be of the same LU service, different LU services or any combination of them. For each instance it is also possible defining separate LU types for the two transmission directions.

The creation of DLC LU instances is made by means of the NWK layer <<CALL-ATTRIBUTES>> Information Element (see ETSI EN 300 175-5 [5] clause 7.7.5).

U-plane traffic from/to MAC is routed to the different LU instances by means of specific settings in the NWK later IE <<CONNECTION-ATTRIBUTES>> (see ETSI EN 300 175-5 [5] clause 7.7.11). A combination of the fields slot type and service type in MAC control messages is used as identifier allowing the distribution of traffic to/from different LU instances with bearer granularity. Such identifiers are transmitted in MAC Attributes, Channel List and B-field setup messages.

5 C-plane service characteristics

5.1 Data link service (LAPC+Lc)

5.1.1 General

The data link service (LAPC+Lc) shall be accessed via the S SAP. Three classes of service are defined:

- Class U: an unacknowledged service.
- Class A: a (single frame) acknowledged service.
- Class B: a (multiple frame) acknowledged service.

Each LAPC instance shall only support one class of operation to provide a single data link between one FT and one PT.

NOTE 1: Class U may provide a data link to more than one PT when using connectionless MAC services.

Class B multiple frame operation shall require both sides to support three phases of additional procedures:

- 1) establishment of class B multi-frame operation;
- 2) maintenance of class B multi-frame operation (including acknowledged information transfer);
- 3) release of class B multi-frame operation.

The complete service for one data link shall be provided by a pair of protocol entities called LAPC and Lc, using a single MAC connection. These two protocol entities separate the more conventional upper functions (LAPC) from the more unusual lower functions (Lc).

Multiple instances of LAPC and of Lc entities may exist in the FT, but typically only one LAPC and one Lc entity will exist in each PT. Each instance in the FT shall be connected to only one peer instance in one PT.

Multiple (independent) MAC connections may exist to a single PT, but each instance of Lc shall only use the services of one MAC connection.

NOTE 2: A PT may contain multiple instances of LAPC+Lc. However, in many cases a PT may only require the services of one LAPC and one Lc instance. These single instances may support more than one NWK layer call.

When serving a broadband data link the LAPC+Lc may use any of the connections (identified by their ECN) belonging to the logical connection associated with the link.

LAPC shall provide functions for:

- a) the provision and control of one data link;
- b) segmentation of long layer 3 information fields;
- c) error detection (timeout or protocol);
- d) error recovery;
- e) flow control;
- f) suspend/resume.

Lc shall provide functions for:

- a) the provision of one or more data link;
- b) frame delimiting;
- c) checksum generation/checking;
- d) fragmentation of DLC frames (channel dependent);
- e) routing of frames to/from logical channels;
- f) connection handover.

5.1.2 LAPC types of operation

The three defined classes of operation (class U, class A and class B) all support the transfer of higher layer information but they are subject to different rules. Class A and class B operation shall only be used for point-to-point links. Only class U may be used for either point-to-point or point-to-multipoint (connectionless) links.

Class U unacknowledged transfer: information shall be transmitted in unnumbered frames (UI). At the DLC layer these frames shall not be acknowledged. Some error detection may occur but no error recovery shall be defined. A maximum of one class U point-to-point link shall be allowed between a PT and a specific FT.

Class A acknowledged transfer: information shall be transmitted in numbered frames (I) that shall be acknowledged at the DLC layer. Error recovery based on retransmission of unacknowledged frames shall be defined. A maximum of one class A link shall be allowed between a PT and a specific FT.

NOTE 1: Class A is a subset of class B operation.

Class B acknowledged transfer: information shall be transmitted in numbered frames (I) that shall be acknowledged at the DLC layer. Error recovery based on retransmission of unacknowledged frames shall be defined. Multiple class B links shall be allowed between a PT and a specific FT.

NOTE 2: Class B is similar to the multiple frame operation of LAPD in Recommendation ITU-T Q.921 [11].

5.1.3 Establishment of information transfer modes

5.1.3.1 Data Link Identifier (DLI)

Every separate instance of a LAPC entity shall be uniquely identified within one FT by its DLI. This identifier shall remain constant for the complete duration of the data link, including any bearer or connection handovers.

Class U and class A operation should use reserved values of DLI as defined in clause 7.3.5. Class B operation requires an additional DLI to be assigned by the PT; this DLI assignment procedure is part of the class B establishment procedure.

5.1.3.2 LAPC states

Each instance of LAPC shall exist in one of three operational states:

- unassigned link identifier state;
- assigned link identifier/multiple frame state;
- assigned link identifier state.

The initial state of each new instance of LAPC shall be the ULI state. Class U link operation and class A link operation shall use this state using the reserved values of DLI.

Class B links shall only operate in the ASM state using an assigned value of DLI; this value shall be assigned as part of class B establishment. Class B links may also exist in the Assigned Link Identifier (ALI) state, where the assigned DLI value and the class B state variables are preserved, but all data transfer is suspended.

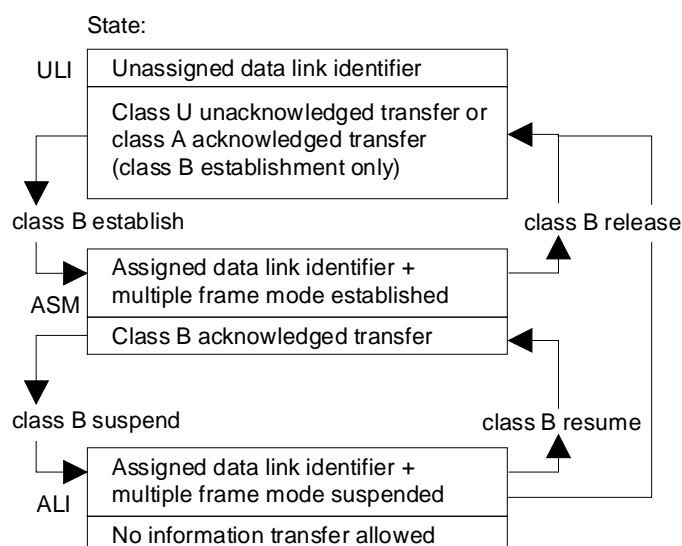

NOTE: The class B release procedures may cause a combined state transition that goes straight from state ALI to state ULI.

Figure 5.1.3.2.1: LAPC states

Class A and class B data link operation shall be established and released using the procedures defined in clause 9.

5.2 Broadcast service (Lb)

The broadcast service shall be accessed via the B SAP. This service shall provide an unacknowledged connectionless service from the FT to one or more PTs.

The service shall be provided by a single entity called Lb. Lb shall provide functions for:

- buffering and forwarding of NWK layer messages to/from the MAC layer;
- distributing transmitted messages over different clusters;
- collation and filtering of received messages from different clusters.

NOTE: One application of this service is to broadcast (request-paging) messages to all PTs during incoming call establishment. Broadcast messages can also support other network layer services.

6 Frame structures for C-plane services

6.1 Data link service frame structure

6.1.0 Frame format type FA

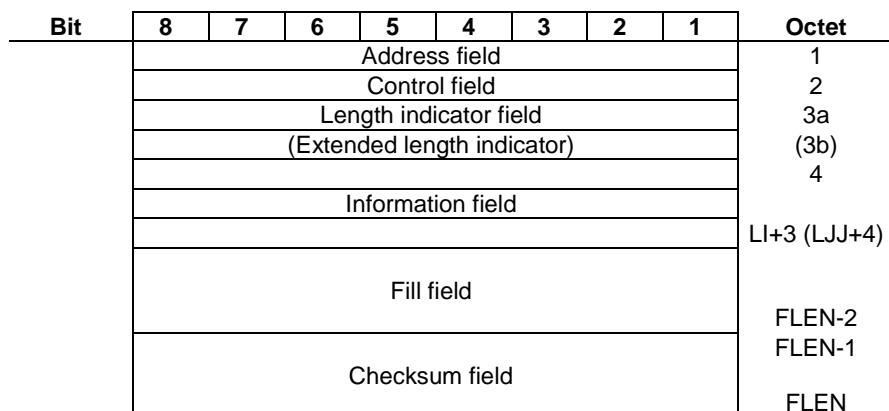

Figure 6.1.0.1: Frame format type FA

6.1.1 General frame structure

A type FA frame shall contain the following fields:

- an address field of 1 octet;
- a control field of 1 octet;
- a length indicator field of 1 octet;
- an optional extended length indicator field of 1 octet;
- a variable length information field of 0 octet to 63 octets;
- a variable length fill field of 0 octet to 7 octets;
- a checksum field of 2 octets.

The fill field shall be used to adjust the total frame length such that it shall always align to an integral number of fragments of the selected logical channel (C_F/CL_F or C_S/CL_S).

For the C_F/CL_F logical channel the frame length shall only vary in steps of 8 octets (i.e. $FLEN \bmod 8 = 0$).

For the C_S/CL_S logical channel the frame length shall only vary in steps of 5 octets (i.e. $FLEN \bmod 5 = 0$).

Table 6.1.1.1: Channel specific frame parameters (with single octet length indicator)

Parameter	C_F CHAN	C_S CHAN
1) Fragment size (octets)	8	5
2) Steps between allowed FLEN values (octets)	8	5
3) Maximum FLEN (octets)	72	70
4) Minimum FLEN (octets)	8	5
5) Maximum information (octets)	63	63
6) Maximum Fill (octets)	7	4

All frames shall only include the smallest possible number of fill octets. This allows one length indicator to define both the information field length and the total frame length.

NOTE: During idle periods, the LAPC should not generate null frames (i.e. frames with no control purpose and with zero length information fields). This avoids causing the MAC layer to waste connection resources.

For details of the length indicator refer to clause 7.6.

6.1.2 Lc frame delimiting and transparency

Frame delimiting shall be provided by a combination of the MAC layer and the DLC layer Lc entity. The MAC layer shall always align Lc fragments to physical slot boundaries. This is described in ETSI EN 300 175-2 [2] and this timing shall always be preserved.

A DLC frame shall only start on a fragment boundary. The end of a multi-fragment frame should be identified by examining the length indicator field. Therefore the Lc should process all frames in the order they are received (in sequence).

NOTE 1: This delimiting technique avoids the need for flag octets, and there are no restrictions on the allowable bit sequences in any of the fields.

NOTE 2: The MAC layer is expected to provide a reliable connection-orientated service, with a residual fragment error rate better than 10^{-4} .

The Lc entity shall use the following procedure to establish frame synchronization (i.e. locate the start of the first frame) and to maintain frame synchronization.

Frame synchronization: in order to establish frame synchronization, an unsynchronized Lc (receive) entity shall treat each fragment as the first fragment of a frame, treating octets 3a (and 3b) as a length indicator field to determine the frame length. Successful frame synchronization shall be identified by checksum success. Any checksum failure on a subsequent frame shall cause the Lc entity to repeat this procedure until frame synchronization is re-established.

When possible, a single fragment frame (i.e. the shortest possible frame) should be used by both entities for their first transmission or at link resumption.

6.1.3 Transmission order

The physical transmission order shall be controlled by the MAC layer as defined in ETSI EN 300 175-3 [3]. This MAC layer ordering shall use the octet numbering and bit numbering as shown on figure 6.1.0.1.

The operations across the DLC layer/MAC layer boundary shall be such that the DLC entity sending a frame can assume this temporal order of the frame, and that the entity receiving the frame can reconstruct it with its assumed temporal order.

6.1.4 Routing to logical channels

6.1.4.0 General

Each Lc frame shall only be sent in one of two logical channels, C_F or C_S (CL_F or CL_S in the case for connectionless service). These channels are independent.

A frame retransmitted by LAPC, shall be regarded as a different frame by Lc. No duplication of frames by the Lc entity is allowed.

The selection of the logical channel shall be controlled by the LLME (see clause 10.2.5).

6.1.4.1 C_F/CL_F logical channel

The complete frame shall be fragmented into 8 octet fragments. One or more fragments may be sent in each MAC_CO_DATA-req primitive and received in each MAC_CO_DATA-ind primitive. Sequence numbers shall not be added because the MAC is expected to always preserve the order of transmission; fragments shall be delivered in the order that they were transmitted.

NOTE: The checksum is added to support frame synchronization and to protect against slot theft and other residual errors.

Fragmentation into SAP primitives is shown in figure 6.1.4.1.1.

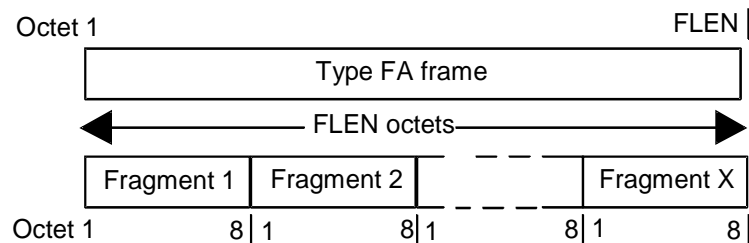

Figure 6.1.4.1.1: C_F/CL_F logical channel fragmentation

Fragments shall be sent in ascending numerical order.

6.1.4.2 C_S/CL_S logical channel

The complete frame shall be fragmented into 5 octet fragments. One fragment may be sent in each MAC_CO_DATA-req primitive and received in each MAC_CO_DATA-ind primitive. Sequence numbers shall not be added because the MAC is expected to always preserve the order of transmission: fragments shall be delivered in the order that they were transmitted.

NOTE: The checksum is added to support frame synchronization and to protect against slot theft and other residual errors.

Fragmentation into SAP primitives is shown in figure 6.1.4.2.1.

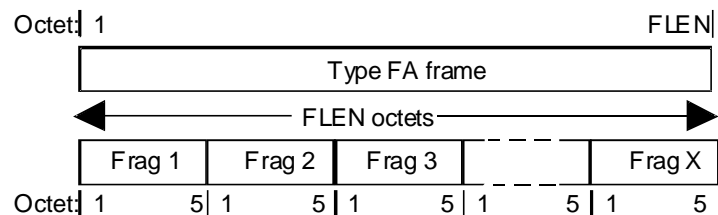

Figure 6.1.4.2.1: C_S/CL_S logical channel fragmentation

Fragments shall be sent in ascending numerical order.

6.1.5 Invalid frames

An invalid data link frame shall be a frame that contains one or more of the following faults:

- contains a checksum error;
- contains an unassigned assignable LLN (see clause 7.3.5);
- contains a DLI (see clause 7.3.6) that is not supported;
- contains an undefined control field (see clause 7.11);
- contains an invalid length indicator (see clause 7.7.3).

Invalid frames shall be discarded without notification to the sender. No other action shall be taken as a result of these frames.

6.2 Broadcast service frame structure

6.2.1 Standard frame structure

The standard broadcast service shall use a fixed length frame structure of 3 octets or 5 octets.

Bit	8	7	6	5	4	3	2	1	Octet
	Higher layer info								1
	Higher layer info								2
	Higher layer info								3

Figure 6.2.1.1: Short frame format (3 octets)

Bit	8	7	6	5	4	3	2	1	Octet
	Higher layer info								1
	Higher layer info								2
	Higher layer info								3
	Higher layer info								4
	Higher layer info								5

Figure 6.2.1.2: Long frame format (5 octets)

Each frame format shall contain an integral number of octets as shown above. The frame format in use should be indicated by the "message unit length" parameter in the DL_BROADCAST or DL_EXPEDITED primitive.

In all cases the DLC layer shall operate with complete frames (complete octets), and shall preserve the order and content of all octets.

The mapping of the higher layer information into this frame is defined in ETSI EN 300 175-5 [5].

NOTE: The most significant octet may only contain 4 bits of valid information for certain NWK layer messages (see ETSI EN 300 175-5 [5]). However, the DLC always processes the complete octet.

The physical transmission order shall be controlled by the MAC layer as defined in ETSI EN 300 175-3 [3]. This MAC layer ordering shall use the octet numbering and bit numbering shown above.

The operations across the DLC layer/MAC layer boundary shall be such that the DLC entity sending a frame can assume this temporal order of the frame, and that the entity receiving the frame can reconstruct it with its assumed temporal order.

6.2.2 Extended frame structure

Extended length frames shall provide a family of optional longer frame formats. Extended frames shall contain one or more 5 octet sections, concatenated into one extended frame. Each section of an extended frame is similar to a standard long frame of 5-octets. The possible sizes of extended length frames shall be as follows:

- 5 octets, 10 octets, 15 octets, 20 octets, 25 octets or 30 octets.

The use of an extended frame format shall be indicated by the "long message flag" parameter, and the length of the frame shall be indicated by the "message unit length" parameter in the DL_BROADCAST or DL_EXPEDITED primitive.

7 Elements of procedures and formats of fields for C-plane peer-to-peer communication

7.1 General

The "elements of procedure" define the commands and responses that shall be used to provide a single C-plane data link. Multiple instances of C-plane data links may exist at the same time, but these instances shall operate independently. The elements of procedure (and the related procedures described in clause 9) shall only consider the operation of a single data link instance.

The "formats of fields" define the detailed coding of bits within each field of a type FA frame. Unless otherwise stated, all fields shall be coded according to the natural binary code. The resulting value shall be arranged with the most significant bit (msb) in the highest numbered bit position.

Bit	7	6	5
	BIT2 (msb)	BIT1	BIT0 (lsb)

Figure 7.1.1: Normal internal field format

7.2 Address field formats

Bit	8	7	6	5	4	3	2	1
	NLF	LLN		SAPI		C/R	RES	

Where:

C/R: Command/Response bit;
 SAPI: Service Access Point Identifier;
 NLF: New Link Flag;
 LLN: Logical Link Number;
 RES: REserved.

Figure 7.2.1: Address field format

7.3 Address field parameters

7.3.1 REserved bit (RES)

This bit shall be set to "1".

This bit shall be reserved for possible use as an extended address bit. Refer to Recommendation ITU-T Q.921 [11].

7.3.2 Command Response (C/R) bit

The C/R bit shall identify a frame as either a command or a response. The PT side shall send commands with C/R set to "0" and responses with C/R set to "1". The FT side shall do the opposite. Refer to Recommendation ITU-T Q.921 [11].

7.3.3 SAPI field

The SAPI shall identify the higher layer SAP that is associated with each frame. There shall be a 1-to-1 correspondence between the SAP identities at both ends of the link for each peer-to-peer data link:

- SAPI = "0": connection oriented signalling;
- SAPI = "3": connectionless signalling;
- All other values reserved.

7.3.4 New Link Flag (NLF) bit

In both directions this bit shall have the same meaning:

- NLF = "1": flag set;
- NLF = "0": flag cleared.

7.3.5 LLN-field

The LLN shall identify the LAPC entity that is associated with each frame. There shall be a 1-to-1 correspondence between LLNs at both ends of the link.

NOTE 1: The LLN only identifies the different LAPC entities of one PT. LAPC entities to different PTs may use the same value of LLN (see clause 7.3.6).

The assignable LLN values shall be assigned by the PT during establishment of class B multiple frame operation.

The LLN unassigned value shall be reserved for use by the FT during FT initiated establishment of multiple frame operation.

Table 7.3.5.1: LLN values

LLN Value	Meaning
0	Class U operation
1	Class A operation
2 to 6	Assignable LLN (class B operation)
7	LLN unassigned (class B operation)

NOTE 2: A single data link (one value of LLN) may be used to provide a service for more than one higher layer entity. There may not be a 1-to-1 correspondence between higher layer entities and DLC data links (LLN).

7.3.6 Data Link Identifiers (DLI)

DLI: the DLI shall uniquely identify each LAPC instance within the FT and within the PT. The DLI shall be formed by the combination of two components:

$$DLI = LLN + MCI$$

Data Link Endpoint Identifier (DLEI): the DLEI shall uniquely identify the endpoint within one of the MAC layer MC-SAPs. This shall be a local matter, and different DLEIs may be used in the PT and the FT. The DLEI should be formed by the combination of three components:

$$DLEI = SAPI + LLN + MCI$$

Where:

- LLN: Logical Link Number (see clause 7.3.5);
- MCI: MAC Connection Identifier (see clause 10.2.4);
- SAPI: SAP Identifier (see clause 7.3.3).

Broadband data links may use more than one MAC connection combined in one logical connection. The MCI used for the DLI (and the DLEI) shall be the MCI for the first connection setup (see clause 10.7 for more information).

7.4 Control field formats

There shall be three different control field formats:

- I-format: numbered information;
- S-format: supervisory functions;
- U-format: unnumbered information.

Bit	8	7	6	5	4	3	2	1
I Format	N(R)			P	N(S)			0
S Format	N(R)			P/F	S	S	0	1
U Format	U	U	U	P/F	U	U	1	1

Where:

- N(S): Send sequence Number;
 N(R): Receive sequence Number;
 S: Supervisory function bits;
 U: Unnumbered function bits;
 P/F: Poll/Final bit;
 Poll when issued as a command;
 Final when issued as a response.

Figure 7.4.1: Control field formats

7.5 Control field parameters

7.5.1 Poll/Final (P/F) bit

All frames shall contain a P/F bit. The P/F bit shall only be used in class B operation, where it shall serve a different function in command frames and response frames.

Command frames: the P/F bit has a poll (P) function. Here, P/F = "1" shall be used to request (poll) a response from the peer LAPC entity.

Response frames: the P/F bit shall have a response (F) function. Here, P/F = "1" shall be used to indicate a response frame from the LAPC entity (i.e. a reply to a command frame that contained P/F = "1").

The use of the P/F bit is described in clause 9.2.1.

7.5.2 Multiple frame operation variables and sequence numbers

7.5.2.1 Modulus

Each I-frame shall be sequentially numbered and this number shall have the value 0 to 7.

For class A operation, the modulus equals 2 and the sequence numbers shall only cycle through part of the range, 0 to 1.

For class B operation, the modulus equals 8 and the sequence numbers shall cycle through the entire range, 0 to 7.

NOTE: All arithmetic operations on state variables and sequence numbers contained in the present document will be affected by the modulus operation. The allowed values of all state variables for a given class of operation will always be defined by the modulus operation, not by the maximum values given in the following clauses.

7.5.2.2 Send state Variable V(S)

Each point-to-point data link shall have an associated V(S) when using I-frame commands. V(S) denotes the sequence number of the next I-frame to be transmitted. V(S) may take on the value 0 to 7. The value of V(S) shall be incremented by 1 with each successive I-frame transmission, and shall not exceed V(A) by more than the maximum number of outstanding frames, k.

For class A operation, the value of k is fixed to 1.

For class B operation, the value of k is fixed to 3.

NOTE: The parameter k is referred to as the "window size" elsewhere in the present document.

7.5.2.3 Acknowledge state Variable V(A)

Each point-to-point data link endpoint shall have an associated V(A) when using I-frame commands and supervisory frame commands or responses. V(A) identifies the last I-frame that has been acknowledged by its peer: V(A)-1 equals the N(S) of the last acknowledged I-frame. V(A) may take on the value 0 to 7. The value of V(A) shall be updated by the valid N(R) values received from its peer (see clause 7.5.2.6).

A valid N(R) shall be one that lies in the range $V(A) \leq N(R) \leq V(S)$.

7.5.2.4 Send sequence Number N(S)

Only I-frames shall contain N(S), the send sequence number of transmitted I-frames. At the time that an in-sequence I-frame is designated for transmission, the value of N(S) shall be set equal to V(S).

7.5.2.5 Receive state Variable V(R)

Each point-to-point data link endpoint shall have an associated V(R) when using I-frame commands and supervisory frame commands or responses. V(R) denotes the sequence number of the next-in-sequence I-frame expected to be received. V(R) can take on the value 0 to 7. The value of V(R) shall be incremented by 1 following the receipt of an error-free, in-sequence I-frame whose N(S) equals V(R).

7.5.2.6 Receive sequence Number N(R)

All I-frames and S-frames shall contain N(R), the expected send sequence number of the next received I-frame. At the time that an I-frame or S-frame is designated for transmission, the value of N(R) shall be set equal to the current value of V(R). N(R) shall indicate that the data link entity transmitting the N(R) has correctly received all I-frames up to and including N(R)-1.

7.5.3 Unacknowledged operation variables and sequence numbers

No variables or sequence numbers shall be defined for unacknowledged operation.

7.5.4 Supervisory and Unnumbered function bits S and U

These bits shall encode the different types of Supervisory (S) frame and Unnumbered (U) frame. Not all possible encodings shall be used (see clause 7.11).

7.6 Length indicator field format

Bit	8	7	6	5	4	3	2	1
LI	L6	L5	L4	L3	L2	L1	M	N = 1

Figure 7.6.1: Length indicator field format

Bit	8	7	6	5	4	3	2	1
LJJ	L06	L05	L04	L03	L02	L01	M	N = 0
...	L12	L11	L10	L09	L08	L07	RES	N = 1

Figure 7.6.2: Extended length indicator field format

Where:

- RES: REServed;
- N: Extended length indicator bit;
- M: More data bit;
- LI: $I \in \{6..1\}$ Length of Information field (octets);
- LJJ: $JJ \in \{12..01\}$ Length of extended information field (octets).

7.7 Length indicator field parameters

7.7.1 Length indicator field extension bit (N)

A "1" in this position shall signify the last octet of the length indicator field.

7.7.2 More data bit (M)

The More data bit, M, shall be used to indicate segmentation of network layer (layer 3) messages into DLC frames.

M = "1" shall indicate that the information field only contains part of a NWK layer message - there is more to follow.

M = "0" shall indicate one of two things:

- that the information field contains a complete NWK layer message, provided that the M bit of the previous numbered information (I) frame was also set to "0";
- that the information field contains the last segment of a NWK layer message, provided that the M bit of the previous numbered information (I) frame was set to "1".

When the M bit is set to "1", the information field should contain the maximum number of octets.

NOTE 1: This rule only recommends that each frame contains the maximum amount of layer 3 information. The LI field always defines the actual length.

In all frames other than numbered information frames the M bit shall be set to "0".

NOTE 2: This rule means that NWK messages cannot be segmented if they are carried in Unnumbered Information (UI) frames.

7.7.3 Length parameter (L_I)

The length parameter L_I shall consist of 6 bits (L1 to L6) and shall define the length of the information field in all frames. Allowable values shall be:

- 0 to 63 for frames routed via the C_F logical channel;
- 0 to 63 for frames routed via the C_S logical channel.

$L_I = "0"$ shall be used for all frames that contain no higher layer information.

The total frame length FLEN should be calculated by adding the length of the address field, the control field, the length indicator field and the checksum field, to the value given by L_I , and then rounding the result up to the nearest allowable value.

NOTE 1: This calculation may be done with a look-up table.

EXAMPLE: Let $L_I = 22$.

Then Minimum frame length = $22 + 1 + 1 + 1 + 2 = 27$ (with non-extended length indicator field).

For C_F routed frames, FLEN = 32.

For C_S routed frames, FLEN = 30.

Allowable values for total Frame LENgth (FLEN).

C_F routed frames:

$FLEN \in \{8; 16; 24; 32; 40; 48; 56; 64; 72\}$.

C_S routed frames:

$FLEN \in \{5; 10; 15; 20; 25; 30; 35; 40; 45; 50; 55; 60; 65; 70\}$.

NOTE 2: These limits apply to frames without an extended length indicator. The upper limit follows from a maximum information field of 63 octets (L_I is 6 bits).

7.7.4 Extended length parameter (L_{JJ})

For further study.

7.7.5 Reserved bit (RES)

This bit shall be set to "0".

The use of this bit is for further study.

7.8 Fill field format

Bit	8	7	6	5	4	3	2	1
	1	1	1	1	0	0	0	0

Figure 7.8.1: Fill field format

Fill field octets shall be filled with balanced data.

7.9 Checksum field format

Bit	8	7	6	5	4	3	2	1	Octet
Checksum Octet X									
X8	X7	X6	X5	X4	X3	X2	X1		FLEN-1
Y8 Y7 Y6 Y5 Y4 Y3 Y2 Y1									FLEN

Figure 7.9.1: Checksum field format

7.10 Checksum field parameters

The checksum octets shall contain two elements:

- a Link SIGnature (LSIG);
- an underlying checksum.

These elements shall be combined using a binary exclusive or (EXOR) operation.

Checksum setting:

- the underlying checksum octets shall be calculated such that checksum formulae <1> and <2> (see below) hold, and this intermediate result shall be placed into the checksum octets X" and Y";
- the intermediate result shall be combined with the link signature by setting:
 - $X = X'' \text{ EXOR LSIGX}$;
 - $Y = Y'' \text{ EXOR LSIGY}$.

Checksum testing:

- the link signature shall be removed by setting:
 - $X'' = X \text{ EXOR LSIGX}$;
 - $Y'' = Y \text{ EXOR LSIGY}$;
- the intermediate result shall be tested to see if the checksum formulae <1> and <2> hold.

Link signature: the link signature shall be incorporated into the checksum field to protect against slot theft. The signature shall be a 16 bit number that shall be unique for all links to a given PT within the domain of one FT.

The value for this signature shall be defined at LAPC+Lc invocation. The current value shall always be available at both sides (via the lower layer management entity) without any negotiation. The precise definition of link signature is given in clause 10.3.1.

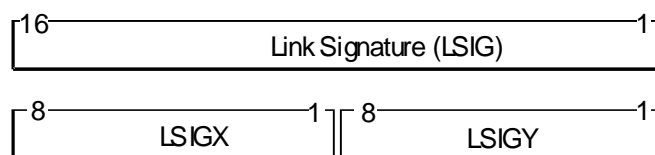

Figure 7.10.1: Link signature

Underlying checksum: the underlying checksum calculation shall be based on the checksum proposed in ISO/IEC 8073 [16].

The sending Lc entity shall transmit frames with the underlying checksum field set such that the following formulae are satisfied:

- $\Sigma \{ \text{Octet } (n) \} = 0 \text{ (modulo 255) } \langle 1 \rangle$;
- $\Sigma \{ n \times \text{Octet } (n) \} = 0 \text{ (modulo 255) } \langle 2 \rangle$;
- Both Σ operate from $n = 1$ to $n = \text{FLEN}$.

NOTE: This algorithm may be easily implemented as two additions per octet (see annex B).

7.11 Commands and responses

7.11.0 General

All of the following commands and responses may be used by either the PT or the FT side of the link. Each data link shall support the set of commands and responses that are necessary for its desired operation, as defined in clause 9.1.

Table 7.11.0.1: Commands and responses

Format	Command	Response	8	7	6	5	4	3	2	1
I	I Numbered information		N(R)			P	N(S)			0
	RR Receive ready	RR Receive ready	N(R)			P/F	0	0	0	1
S	RNR Receive not ready	RNR Receive not ready	N(R)			P/F	0	1	0	1
	REJ Reject	REJ Reject	N(R)			P/F	1	0	0	1
	SABM Set Async Bal Mode		0	0	1	P	1	1	1	1
U		DM Disconnect mode	0	0	0	F	1	1	1	1
	UI Unnumbered information		0	0	0	P	0	0	1	1
	DISC Disconnect		0	1	0	P	0	0	1	1
		UA Unnumbered ack	0	1	1	F	0	0	1	1
NOTE: Any undefined encodings of the S bits and the U bits are "invalid" and are handled using the procedures defined in clause 9.2.9.										

7.11.1 Information (I) command

The information (I) command shall be used to transfer sequentially numbered frames that contain layer 3 information fields, across one DLC LAPC link. The I command shall only be used in acknowledged (class A or class B) operation.

The I command shall also be used to:

- place a receiving LAPC entity into the class B (multiple frame) mode of operation (see clause 9.2.4);
- acknowledge previously received I-frames up to and including N(R)-1, as defined in clause 9.

7.11.2 Receive Ready (RR) command/response

The RR frame shall be used by a LAPC entity to:

- indicate it is ready to receive an I-frame;
- acknowledge previously received I-frames up to and including N(R)-1, as defined in clause 9;
- clear a possible busy condition that was indicated by an earlier RNR frame between the same LAPC entities.

In addition to indicating the status of a LAPC entity, the RR command may be used by a class B entity to ask for the status of its peer entity by setting the P bit to "1".

7.11.3 Receive Not Ready (RNR) command/response

The RNR frame shall be used by a LAPC entity to:

- a) indicate a busy condition, that is, a temporary inability to accept additional I-frames;
- b) acknowledge previously received I-frames up to and including $N(R)-1$, as defined in clause 9.

In addition to indicating the status of a LAPC entity, the RNR command may be used by a class B entity to ask for the status of its peer entity by setting the P bit to "1".

7.11.4 REJect (REJ) command/response

The REJ frame shall be used by a LAPC entity to set an exception condition that requests retransmission of I-frames starting with the frame numbered $N(R)$. The REJ frame shall acknowledge I-frames numbered up to and including $N(R)-1$. The retransmitted frames shall be transmitted before any new I-frames (I-frames pending initial transmission) are transmitted.

Only one REJ exception condition shall be established at a time for a given direction of information transfer. A REJ exception condition shall be cleared upon receipt of an I-frame with an $N(S)$ equal to the $N(R)$ of the REJ frame.

The transmission of an REJ frame shall also indicate the clearance of any busy condition in the sending LAPC entity that was reported by the earlier transmission of an RNR frame by the same LAPC entity.

In addition to indicating the status of a LAPC entity, the REJ command may be used by a LAPC entity to ask for the status of its peer entity by setting the P bit to "1".

No information field shall be permitted in a REJ frame.

7.11.5 Set Asynchronous Balanced Mode (SABM) command

The SABM command shall be used to re-establish class B multiple frame acknowledged operation.

The receiving LAPC entity shall confirm acceptance of the SABM command by transmitting a UA response at the first opportunity. Upon accepting the SABM command, the entity shall set the variables $V(S)$, $V(A)$, $V(R)$ and the retransmission counter to 0.

Transmission of a SABM command shall indicate the clearance of a busy condition that was reported by the earlier transmission of an RNR frame by that same LAPC entity.

Previously transmitted I-frames that are unacknowledged when the SABM command is performed shall remain unacknowledged, and shall be discarded. It is the responsibility of the higher layer (layer 3) or the management entity to recover from this possible loss of I-frames.

No information field shall be allowed as part of a SABM frame.

7.11.6 Disconnect Mode (DM) response

The DM response shall be used by a LAPC entity to report to its peer entity that it is in a state such that multiple frame re-establishment cannot be performed. A LAPC entity shall transmit a DM response whenever a valid command is received which it cannot action.

No information field shall be permitted in a DM response.

7.11.7 Unnumbered Information (UI) command

The UI command shall be used to transfer unacknowledged (and unnumbered) frames that contain layer 3 information fields, across one DLC LAPC link. A UI-command frame shall only be used if requested by the layer 3 entity, and UI-frames may be lost without notification to the layer 3 entity if a data link exception occurs during the transmission of the frame.

Only UI-frames shall be used when providing a connectionless service (SAPI = "3") using the procedures defined in clause 9.3.

7.11.8 DISConnect (DISC) command

The DISC command shall be used to terminate class B multiple frame operation.

Prior to performing the command, the LAPC entity receiving the command shall confirm acceptance of the command by transmitting a UA response. The LAPC entity sending the DISC command shall terminate multiple frame operation when it receives the acknowledging UA or DM response.

No information field shall be permitted in a DISC command.

7.11.9 Unnumbered ACK (UA) response

The UA response shall be used by a DLC entity to acknowledge the receipt and acceptance of the mode setting commands (SABM and DISC). These received mode setting commands shall not be performed until the UA response is transmitted.

The transmission of a UA response shall also indicate the clearance of a busy condition that was reported by the earlier transmission of an RNR frame by that same LAPC entity.

No information field shall be permitted in a UA response.

8 Primitives

8.1 Primitive types

Four primitive types may be used:

- req (request):** for a higher layer to request service from a lower layer;
- cfm (confirm):** for the layer providing the service to confirm that the activity has been completed;
- ind (indication):** for a layer providing a service to notify the next higher layer of any specific service related activity;
- res (response):** for a layer to acknowledge receipt of an indication primitive from the next lower layer.

The defined types for each category of primitive are shown as a list in curly brackets.

EXAMPLE: DL_RELEASE -{req, cfm, ind}.

In this example the defined types are request, confirm and indicate (but not response).

NOTE: These primitives are defined only for the purpose of describing layer-to-layer interaction. The primitives are defined as an abstract list of parameters, and their concrete realization may vary between implementations. No formal testing of primitives is intended.

8.2 Primitives to the MAC layer (lower layer)

The primitives used for communication to the MAC layer are described in ETSI EN 300 175-3 [3].

8.3 Primitives to the NWK layer (higher layer)

8.3.0 General

This clause summarizes the primitives between the DLC layer and the NWK layer together with the list of associated parameters.

8.3.1 Parameter definitions

Data Link Endpoint Identifier (DLEI):

Refer to clause 7.3.6.

Establish mode: this defines the mode of link establishment:

Class U: unacknowledged information transfer only;

Class A: acknowledged information transfer only;

Class B: acknowledged information transfer only.

Release mode: this defines the mode of link release:

Normal: (acknowledged release);

Abnormal: (unacknowledged release).

Resume mode: this indicates the mode of link resumption:

SABM-frame: (resume with SABM-frame);

I-frame: (resume with I-frame).

Suspend mode: this indicates whether a suspension is accepted:

Accept: (suspension is accepted);

Reject: (suspension is rejected).

Cluster address list: this shall provide a list of cluster addresses. These shall be SAP addresses that shall identify all of the associated MAC instances (downward SAPs), to define either the distribution of the associated message unit(-req primitive), or the origin(s) of the associated message unit (-ind primitive).

Message unit: this shall define any higher layer (peer-to-peer) information that is included in the primitive.

The operations across the NWK layer/DLC layer boundary shall be such that a layer sending a message can assume a temporal order of the bits within the message unit, and that the layer receiving the primitive can reconstruct the message with its assumed temporal order.

Message unit length: for primitives associated with both the S-SAP and the B-SAP, the length of the message unit shall be defined by an additional parameter in the primitive. This parameter shall be used in all primitives that contain a Message Unit parameter. The coding and use of this length indicator shall be a local matter, and is not defined in the present document.

Radio fixed part number: when using "fast set-up", this parameter shall be included in the DL_ESTABLISH-ind primitive (associated with the S-SAP). The parameter shall specify only one RFP within one cluster. The coding of this parameter shall be a local matter, and is not defined in the present document.

Extended message flag: for DL_BROADCAST primitives (associated with the B-SAP) this parameter indicates that a message shall use the extended frame format (see clause 6.2.2). This parameter shall correspond to the "long" flag in the relevant MAC_Page primitives.

Error flag: for DL_BROADCAST-ind and DL_EXPEDITED-ind primitives (associated with the B-SAP) the SDU data may contain errors. This parameter shall be set according to the "CRC result" parameter in the relevant MAC_PAGE-ind primitive.

Connection identities: for DL_ENC_KEY and DL_ENCRYPT primitives (associated with the S-SAP) this parameter shall specify a list of all relevant MAC connections. The coding of this parameter shall be a local matter, and is not defined in the present document.

Encryption key: for DL_ENC_KEY primitives (associated with the S-SAP) this parameter shall be a SDU containing the encryption key and the identification of the encryption algorithm (when several supported).

Encryption command and Encryption status: for DL_ENCRYPT primitives (associated with the S-SAP) this parameter shall indicate the cipher status:

Clear: encryption disabled;

Crypted: encryption enabled.

Broadband data link flag: this parameter shall identify whether the link will be a normal or a broadband link - broadband links may utilize more than one MAC connection, for the definition see ETSI EN 300 175-1 [1].

8.3.2 S-SAP primitives

8.3.2.0 List of primitives

The following primitives are used:

- 1) DL_ESTABLISH- {req, cfm, ind, res};
- 2) DL_RELEASE- {req, cfm, ind};
- 3) DL_DATA- {req, ind};
- 4) DL_UNIT_DATA- {req, ind};
- 5) DL_SUSPEND- {req, cfm, ind, res};
- 6) DL_RESUME- {req, cfm, ind, res};
- 7) DL_ENC_KEY {req};
- 8) DL_ENCRYPT {req, cfm, ind};
- 9) DL_SERVICE_MOD- {req, cfm, ind}.

8.3.2.1 DL_ESTABLISH primitive

Table 8.3.2.1.1: DL_ESTABLISH primitive

Parameter	REQ	CFM	IND	RES
Data Link Endpoint Identifier (DLEI)	A	A	A	A
Establish mode	A	N	A	N
Radio Fixed Part (RFP) number (see note 1)	O	N	O	N
Message unit	O	N	O	N
Message unit length	O	N	O	N
Broadband data link flag (see note 2)	O	N	O	N
A: Always;				
O: Optional;				
N: Not allowed.				
NOTE 1: RFP number is only required for "fast set-up".				
NOTE 2: The Broadband data link flag is only required for Broadband data links setup.				

8.3.2.2 DL_RELEASE primitive

Table 8.3.2.2.1: DL_RELEASE primitive

Parameter	REQ	CFM	IND	RES
Data Link Endpoint Identifier (DLEI)	A	A	A	N/A
Release mode	A	A	A	N/A
A: Always; O: Optional; N: Not allowed; N/A: Primitive type is not defined.				

8.3.2.3 DL_DATA primitive

Table 8.3.2.3.1: DL_DATA primitive

Parameter	REQ	CFM	IND	RES
Data Link Endpoint Identifier (DLEI)	A	N/A	A	N/A
Message unit	A	N/A	A	N/A
Message unit length	A	N/A	A	N/A
A: Always; O: Optional; N: Not allowed; N/A: Primitive type is not defined.				

8.3.2.4 DL_UNIT_DATA primitive

Table 8.3.2.4.1: DL_UNIT_DATA primitive

Parameter	REQ	CFM	IND	RES
Data Link Endpoint Identifier (DLEI)	A	N/A	A	N/A
Message unit	A	N/A	A	N/A
Message unit length	A	N/A	A	N/A
A: Always; O: Optional; N: Not allowed; N/A: Primitive type is not defined.				

8.3.2.5 DL_SUSPEND primitive

Table 8.3.2.5.1: DL_SUSPEND primitive

Parameter	REQ	CFM	IND	RES
Data Link Endpoint Identifier (DLEI)	A	A	A	A
Suspend mode	N	A	N	A
A: Always; O: Optional; N: Not allowed.				

8.3.2.6 DL_RESUME primitive

Table 8.3.2.6.1: DL_RESUME primitive

Parameter	REQ	CFM	IND	RES
Data Link Endpoint Identifier (DLEI)	A	A	A	A
Resume mode	A	A	A	N
Message unit	O	N	O	N
Message unit length	O	N	O	N
A: Always; O: Optional; N: Not allowed.				

8.3.2.7 DL_ENC_KEY primitive

Table 8.3.2.7.1: DL_ENC_KEY primitive

Parameter	REQ	CFM	IND	RES
Data Link Endpoint Identifier (DLEI)	A	N/A	N/A	N/A
Connection identities	A	N/A	N/A	N/A
Encryption key	A	N/A	N/A	N/A
Code of the algorithm to be used in the KSG	O	N/A	N/A	N/A
A: Always; O: Optional; N: Not allowed; N/A: Primitive type is not defined.				

8.3.2.8 DL_ENCRYPT primitive

Table 8.3.2.8.1: DL_ENCRYPT primitive

Parameter	REQ	CFM	IND	RES
Data Link Endpoint Identifier (DLEI)	A	A	A	N/A
Connection identities	A	N	A	N/A
Encryption command	A	N	N	N/A
Encryption status	N	A	A	N/A
A: Always; O: Optional; N: Not allowed; N/A: Primitive type is not defined.				

8.3.2.9 DL_SERVICE_MOD primitive

Table 8.3.2.9.1: DL_SERVICE_MOD primitive

Parameter	REQ	CFM	IND	RES
Data Link Endpoint Identifier (DLEI)	A	A	A	N/A
Slot type	A	O	O	N/A
Switching	A	O	O	N/A
Service type	A	O	O	N/A
Max lifetime	A	O	O	N/A
Target number of uplink simplex bearers	A	O	O	N/A
Target number of downlink simplex bearers	A	O	O	N/A
Minimum acceptable uplink simplex bearers	A	O	O	N/A
Maximum acceptable uplink simplex bearers	A	O	O	N/A
Result	N	A	A	N/A
A: Always; O: Optional; N: Not allowed; N/A: Primitive type is not defined.				

8.3.3 B-SAP primitives

8.3.3.0 List of primitives

The following primitives are used:

- 1) DL_BROADCAST- {req, ind};
- 2) DL_EXPEDITED- {req, ind}.

8.3.3.1 DL_BROADCAST primitive

Table 8.3.3.1.1: DL_BROADCAST primitive

Parameter	REQ	CFM	IND	RES
Cluster address list	A	N/A	A	N/A
Message unit	A	N/A	A	N/A
Message unit length	A	N/A	A	N/A
Extended message flag	A	N/A	A	N/A
Error flag	N	N/A	A	N/A
A: Always; O: Optional; N: Not allowed; N/A: Primitive type is not defined.				

8.3.3.2 DL_EXPEDITED primitive

Table 8.3.3.2.1: DL_EXPEDITED primitive

Parameter	REQ	CFM	IND	RES
Cluster address list	A	N/A	A	N/A
Message unit	A	N/A	A	N/A
Message unit length	A	N/A	A	N/A
Error flag	N	N/A	A	N/A
A: Always; O: Optional; N: Not allowed; N/A: Primitive type is not defined.				

8.4 Primitives to the interworking unit

8.4.0 General

This clause summarizes the primitives between the DLC layer U-plane and the Interworking Unit (IWU) together with the list of associated parameters.

8.4.1 Parameter definitions

U-plane Link Endpoint Identifier (ULEI): a unique ULEI shall be assigned by the IWU for each service instance. This value shall be preserved for the duration of the call.

Cluster address list: this shall provide a list of cluster addresses. These shall be SAP addresses that shall identify all of the associated MAC instances (downward SAPs), to define either the distribution of the associated message unit (-req primitive), or the origin(s) of the associated message unit (-ind primitive).

Message unit: this shall be any higher layer (peer-to-peer) information that shall be included in the primitive.

The operations across the IWU/DLC layer boundary shall be such that a layer sending a message can assume a temporal order of the bits within the message unit, and that the layer receiving the primitive can reconstruct the message with its assumed temporal order.

Message unit length: for primitives associated with any of the LUX SAPs, the length of the message unit may be defined by an additional parameter in the primitive. This parameter should be used in all primitives that contain a message unit parameter.

The coding and use of this length indicator shall be a local matter, and is not defined in the present document.

Error flag: for DL_U_DATA-ind and DL_U_UNIT-DATA-ind primitives (associated with the S-SAP) messages may contain errors. This parameter shall be set according to the relevant data transmission procedures (see clause 14.3).

8.4.2 LUX-SAP primitives

8.4.2.0 List of primitives

The following primitives are used:

- 1) DL_U_DATA- {req, ind };
- 2) DL_U_UNIT_DATA- {req, ind };
- 3) DL_U_ERROR- {ind }.

8.4.2.1 DL_U_DATA primitive

Table 8.4.2.1.1: DL_U_DATA primitive

Parameter	REQ	CFM	IND	RES
U-plane Link Endpoint Identifier (ULEI)	A	N/A	A	N/A
Message unit	A	N/A	A	N/A
Message unit length	A	N/A	A	N/A
Error flag	N	N/A	O	N/A
A: Always; O: Optional; N: Not allowed; N/A: Primitive type is not defined.				

8.4.2.2 DL_U_UNIT_DATA primitive

Table 8.4.2.2.1: DL_U_UNIT_DATA primitive

Parameter	REQ	CFM	IND	RES
Cluster address list	A	N/A	A	N/A
Message unit	A	N/A	A	N/A
Message unit length	A	N/A	A	N/A
Error flag	N	N/A	O	N/A
A: Always; O: Optional; N: Not allowed; N/A: Primitive type is not defined.				

8.4.2.3 DL_U_ERROR primitive

Table 8.4.2.3.1: DL_U_ERROR primitive

Parameter	REQ	CFM	IND	RES
U-plane Link Endpoint Identifier (ULEI)	N/A	N/A	A	N/A
Error flag	N/A	N/A	O	N/A
A: Always; O: Optional; N: Not allowed; N/A: Primitive type is not defined.				

9 C-plane peer-to-peer procedures

9.1 General

The elements of procedure which shall apply are:

- for class U unacknowledged transfer:
 - UI command;
- for class A acknowledged transfer:
 - I command;
 - R response;
- for class B acknowledged transfer:
 - SABM command;
 - UA response;
 - DM response;
 - DISC command;
 - RR command or response;
 - RNR command or response;
 - REJ command or response;
 - I command.

Class U unacknowledged transfer is described in clause 9.3. Class U is the only class that may be used for a connectionless service (i.e. for transmissions associated to a connectionless MAC service). Class U frames may also be used on the same connection oriented service (MAC connections) as class A or class B frames.

Class A acknowledged transfer is the default operating class for connection oriented links. This class shall be immediately supported whenever a connection oriented link is instanced. Class A only supports single frame operation - meaning a window size of 1.

Class B acknowledged transfer is an optional operating class for connection oriented links. Support of this class by both peers is required for class B operation, and this negotiation is incorporated into the class B establishment procedures. Following successful establishment, class B can support multiple frame operation - meaning a window size larger than 1.

Class A and class B operation are described in clause 9.2. Any of these classes may be used with a Broadband data link.

9.2 Point-to-point acknowledged operation

9.2.1 Procedure for the use of the P/F bit

9.2.1.1 Class A acknowledged information transfer

For class A acknowledged information transfer, the P/F bit is not used and shall be set to "0" in all transmitted frames. Class A entities should ignore the P/F bit on all received frames.

9.2.1.2 Class B acknowledged information transfer

In class B operation, a LAPC entity receiving a SABM, DISC, RR, RNR, REJ or I-frame with the P bit set to "1" shall set the F bit to "1" in the next response frame that it transmits, as defined in table 9.2.1.2.1.

Table 9.2.1.2.1: Immediate response operation of P/F bit

Command received with P bit = "1"	Response transmitted with F bit = "1"
SABM, DISC	UA, DM
I, RR, RNR, REJ	RR, RNR, REJ, DM

9.2.2 Use of LLN

9.2.2.1 Class A operation

The reserved LLN value "class A operation" shall always be used for class A operation. This value shall not be used for class B operation.

The NLF flag shall be set for the first frame from each LAPC entity, and shall be cleared for all subsequent frames.

EXCEPTION: If a request for class B operation is refused, the I-frame requesting class B operation may be treated as though it was a class A frame (see clause 9.2.4.3).

9.2.2.2 Class B operation

Any assignable LLN value shall be used for class B operation.

The use of any assignable LLN in a PT originated frame shall be interpreted as a request for class B operation. In addition, the use of the reserved LLN value "LLN unassigned" in a FT originated frame shall be interpreted as a request for class B operation.

In both cases the responding entity may refuse the class B request by using the reserved LLN value "class A operation" in its reply. In this event only class A operation shall be used for all future frames.

The NLF flag shall be set for the class B establish and release frames from each LAPC entity, and shall be cleared for all other frames (see clauses 9.2.4 to 9.2.8).

Refer to clause 9.2.4 for details of establishment of class B multi-frame operation.

9.2.3 Link establishment and information transfer in class A operation

9.2.3.1 Establishing class A operation

A class A LAPC entity shall be instantiated by the receipt of a DL_ESTABLISH-req primitive specifying class A operation. When a class A entity is instantiated, the class A sequence variables V(S), V(R) and V(A) shall be set to "0", and the entity shall be associated to an "Open" MAC connection. The class A entity shall then transmit a class A I-frame using this associated MAC connection. The NLF bit shall be set for this first frame.

All existing exception conditions shall be cleared, the retransmission counter shall be reset and timer <DL.07> shall be started.

At the peer side, a Lc entity plus class A LAPC shall be instantiated by the receipt of this first I-frame. The receiving entity shall set the class A sequence variables V(S) and V(A) to "0", the class A sequence variable V(R) to "1", and shall return a RR response frame to the initiating entity. The NLF bit shall be set in this response frame, but shall be cleared for all future frames. The receiving entity shall clear all existing exception conditions and reset the retransmission counter. It shall then issue a DL_ESTABLISH-ind primitive to the NWK layer indicating class A operation, and shall enter the class A established state.

Upon receipt of the RR response frame with the NLF bit set the initiating entity shall stop timer <DL.07>, shall issue a DL_ESTABLISH-cfm primitive to the NWK layer, and shall mark the link as established. The NLF bit shall be cleared for all future frames.

NOTE 1: Usually a new MAC connection will have to be opened. In this case, the DL_ESTABLISH-cfm reports on a successful opening as well as successful link establishment.

If timer <DL.07> expires before a RR response with the NLF bit set to "1" is received, the LAPC entity shall:

- a) if the value of the retransmission counter is less than N250:
 - retransmit the I command as above;
 - add one to the retransmission counter;
 - restart timer <DL.07>;
- b) if the value of the retransmission counter is equal to N250:
 - report establishment failure to the NWK layer with a DL_RELEASE-ind primitive. It shall then discard all relevant DL_DATA-req primitives and all outstanding I-frames, and remain in the ULI state.

NOTE 2: A class A entity should be instantiated by the failure of class B establishment, provided that a class A entity does not already exist (see clause 9.2.4).

9.2.3.2 Class A acknowledged information transfer

Class A information transfer is similar to class B, but it is restricted to the use of a fixed window size of 1 and the modulus is set to 2.

Acknowledged information is passed to the DLC layer by the NWK layer using the DL_DATA-req primitive. The complete message unit of this primitive shall be segmented (if necessary) and the segments shall be sequentially transmitted in a series of one or more I-frames.

At the destination LAPC entity, a complete message shall be reassembled from this series of I-frames, and when complete it shall be delivered to the NWK layer in a DL_DATA-ind primitive.

The procedures which apply to the transmission and reception of each I-frame are defined below (see clauses 9.2.3.3 and 9.2.3.4).

NOTE: The term "transmission of an I-frame" refers to the delivery of a complete I-frame to the MAC layer. The term "reception of an I-frame" refers to the receipt of a complete I-frame from the MAC layer.

In the case of Broadband data link, after the data link has been established (including the first connection) and resource negotiation has taken place (in the NWK layer) multiple MAC connections may be associated with the data link. Reception and/or transmission of LAPC+Lc data (frames) can occur on any of those connections.

9.2.3.3 Transmission of class A I-frames

For each I-frame, the control field parameters N(S) and N(R) shall be assigned the values of V(S) and V(R) respectively. V(S) shall be incremented by 1 at the end of the transmission of the I-frame.

Timer <DL.04> shall be started at the time of transmission of each I-frame. If timer <DL.04> expires, the procedures defined in clause 9.2.3.6 shall be followed.

A subsequent I-frame shall only be transmitted when a positive acknowledgement has been received for the previous I-frame. This acknowledgement can be contained in the receive sequence number N(R) of either a RR response frame, or an I-command frame.

Any DL_DATA-req primitives received whilst in the timer-retransmit condition shall be queued.

9.2.3.4 Reception of class A I-frames

Independent of a timer-retransmit condition, when a LAPC entity is not in an own receiver busy condition and receives a valid I-frame it shall proceed as follows:

- a) If the N(S) of the I-frame is equal to the current V(R), the LAPC entity shall:
 - append the information field of the frame to any existing unfinished message (segment reassemble);
 - if the more data bit value is "0" (indicating that this is the last segment of the message) it shall pass the complete message to the NWK layer using the DL_DATA-ind primitive;
 - increment by 1 its V(R) and send an immediate acknowledgement using either a RR response frame or I-command frame containing an updated receive sequence number, $N(R) = V(R)$.
- b) If the N(S) of the I-frame is not equal to the current V(R), the LAPC entity shall:
 - send an immediate acknowledgement using either a RR response frame or I-command frame containing the current value (not updated) of receive sequence number, N(R).

NOTE: Only one value of LLN is valid for class A operation. The receiving entity may also have one or more assigned LLNs (i.e. it may have concurrent class B operation).

Any invalid class A I-frame shall be discarded, and no further action shall be taken.

9.2.3.5 Receiving acknowledgements

On receipt of a valid I-frame or RR response frame, the LAPC entity shall treat the N(R) contained in this frame as an acknowledgement for the I-frame containing the N(S) value of N(R)-1. It shall proceed according to the N(R) value as follows:

- a) if the N(R) value corresponds to the expected value (i.e. $N(R) = N(S) + 1$, where N(S) is the most recently sent value of N(S)) the LAPC entity shall set V(A) equal to N(R), and shall reset timer <DL.04>;
- b) if the N(R) value does not correspond to the expected value, but is in the range $V(A) \leq N(R) \leq V(S)$, V(A) shall not be updated. Timer <DL.04> shall continue to run;
- c) if the N(R) value is invalid, the LAPC entity shall immediately initiate a link re-establishment using the normal link establishment procedures defined in clause 9.2.3.1 or release the connection.

NOTE 1: In the event of a lost or erroneous acknowledgement, retransmission only occurs when timer <DL.04> expires as described in clause 9.2.3.6.

NOTE 2: Case b) should only occur if I-frames cross in transit; it does not indicate a transmission error. For example, a lost, errored or erroneous I-frame should generate no peer response, and a lost, errored or erroneous acknowledgement will generate an (unwanted) retransmission followed by case a) acknowledge. Therefore, case b) may be used to indicate proper connection operation, but will not generate any (re)transmission actions.

9.2.3.6 Waiting for acknowledgement

The LAPC entity shall maintain an internal retransmission count variable. If timer <DL.04> expires, the LAPC entity shall:

- if it is not yet in the timer-retransmit condition, enter the timer-retransmit condition and reset the retransmission count variable; or
- if it is already in the timer-retransmit condition, add one to its retransmission count variable.

The LAPC entity shall then:

- if the value of the retransmission count variable is less than N250, restart timer <DL.04>; and retransmit the last transmitted I-frame (V(S)-1); or
- if the value of the retransmission count variable is equal to N250, release the link, by issuing a MAC_DIS-req primitive to the MAC layer, and shall report this release to the NWK layer using a DL_RELEASE-ind primitive, with the "release mode" parameter set to "abnormal".

The timer-retransmit condition is cleared when the LAPC entity receives a valid RR response frame or I-command frame containing the expected value of N(R). It shall then set its V(A) to the value of the received N(R). Timer <DL.04> shall be reset, and then the LAPC entity shall resume with I-frame transmission.

9.2.3.7 Release of class A operation

Release of class A operation, involves the release of all the LAPC resources. The following procedure only applies if the LAPC entity is in the ULI state.

The class A release process is initiated by a DL_RELEASE-req primitive from the NWK layer.

If this primitive indicates the release mode as "normal" the LAPC entity shall attempt to complete transmission of all outstanding I-frames and of all outstanding DL_DATA-req primitives before releasing the link. The LAPC shall only initiate link release as described in the following clauses if all of this outstanding data has been successfully acknowledged.

If there is no outstanding data, or if the DL_RELEASE-req primitive indicates "abnormal" release mode, the LAPC shall initiate an immediate link release. In this event, the LAPC entity shall return a DL_RELEASE-cfm primitive to the NWK layer, and shall then cease operation. All further frames shall be ignored and any outstanding DL_DATA-req primitives and all outstanding I-frames shall be discarded. The DL_RELEASE-cfm primitive shall indicate "normal" release mode only if there was no outstanding data. If any DL_DATA-req or I-frames are discarded or are unacknowledged, the DL_RELEASE-cfm primitive shall indicate "abnormal" release mode.

Following a release of the link, and if no other links are using the associated MAC connection, the LLME shall immediately release that connection as described in clause 10.2.2.

The peer DLC entity, upon receiving an upward release as a result of this release procedure, shall proceed according to the procedures defined in clause 9.2.7.

9.2.3.8 Re-establishment of class A operation

A class A link may be re-established at any time using the normal link establishment procedures defined in clause 9.2.3.1. All outstanding DL_DATA primitives and I-frames shall be discarded, and all link variables shall be reset.

9.2.4 Establishing class B multiple frame operation

9.2.4.1 Overview

Only one FT initiated class B establishment procedure shall be active to one specific PT at any one time.

This clause describes the C-plane establishment procedures, whereby a single point-to-point LAPC link suitable for class B multiple frame operation is established between two peer entities.

NOTE: Refer to clause 10.4 for details of U-plane installation and establishment procedures.

During establishment of class B multiple frame operation, the maximum number of outstanding I-frames (the window size) shall be set to "1" for both directions. Once in the ASM state, the maximum number of outstanding I-frames shall be set to the class B value given in clause 7.5.2.2.

The establishment of class B multiple frame operation shall always include assignment of a valid LLN, and this assignment shall be made by the PT in all cases.

All NWK layer initiated establishment procedures also imply the discarding of all outstanding DL_DATA-req primitives and all queued I-frames.

A subsequent class B re-establishment procedure is allowed at any time using a SABM frame that contains an assigned LLN and with the NLF bit set. Successful re-establishment causes the sequence numbers to be re-initialized at both ends. This procedure is described in clause 9.2.8.

9.2.4.2 Class B multiple frame establishment procedures

Normal establishment is initiated by a LAPC entity, upon receipt of a DL_ESTABLISH-req primitive from the NWK layer requesting class B operation. This primitive shall define the DLEI to be used. The primitive may optionally contain a message unit containing higher layer information.

The LAPC entity shall initiate a request for class B multiple frame operation by setting the sequence variables V(S), V(R) and V(A) to "0" and transmitting an I-command frame, with the P bit set to "1".

All existing exception conditions shall be cleared, the retransmission counter shall be reset and timer <DL.02> shall be started.

If the responding LAPC entity is able to accept the request, it shall respond to the receipt of the I-frame by issuing a DL_ESTABLISH-ind primitive to the NWK layer indicating class B operation. Upon receipt of a DL_ESTABLISH-res primitive containing the same DLEI, it shall:

- set the sequence variables V(S) and V(A) to "0";
- set the sequence variable V(R) to "1"; and
- transmit a RR response frame with the F bit set to the same binary value as the P bit in the I-frame, using a class B accept value of LLN as defined in clause 9.2.4.3.

It shall clear all existing exception conditions, and the retransmission counter shall be reset. It shall then enter the "ASM" state.

If the responding LAPC entity is unable to accept the request for class B operation, it shall respond to the receipt of the I-frame by transmitting a RR response frame with the F bit set to the fixed class A value (see clause 9.2.1.1) and using the appropriate class B reject value of LLN as defined in clause 9.2.4.3.

If a class A link does not already exist, a rejection of class B operation shall instance a class A LAPC entity. In this event, the LAPC entity shall remain in the "ULI" state and shall inform the NWK layer by issuing a DL_ESTABLISH-ind primitive to the NWK layer indicating class A operation.

If a class A link already exists, a rejection of class B operation shall cause no further action.

NOTE: When refusing class B operation and defaulting to class A operation, the responding entity may accept the I-frame according to the class A procedures (see clause 9.2.3.4). This optional procedure is described in clause 9.2.4.3.

Upon receipt of the RR response with the F bit set to "1" and containing a class B accepting value of LLN, the originator of the I command shall:

- reset timer <DL.02>;
- enter the "ASM" state;
- inform the NWK layer using a DL_ESTABLISH-cfm primitive, indicating class B operation.

Upon receipt of a RR response with a rejecting value of LLN, the originator of the I command shall:

- reset timer <DL.02>;
- remain in the "ULI" state;
- retransmit the I-frame if necessary (see clause 9.2.4.3);
- if defaulting to class A operation, it shall inform the NWK layer using a DL_ESTABLISH-cfm primitive, indicating class A operation;
- if not defaulting to class A operation, it shall inform the NWK layer using a DL_RELEASE-ind primitive, indicating "normal" release of class B operation.

When class B operation is refused and is defaulted to class A operation, the requesting I-frame should be accepted as though it was a class A frame. This default operation should occur if a class A link does not already exist between the PT and the FT (i.e. provided that no previous class A I-frames have been transmitted). In all cases, the NLF bit shall indicate if the initial I-frame has been accepted as though it was a class A frame:

- the NLF bit shall be set if the frame is accepted;
- the NLF bit shall be cleared if the frame is not accepted.

If class B operation is refused, and if the I-frame is not accepted by the receiving entity, the I-frame shall be submitted to the class A transmission queue.

An RR response with the F bit set to "0" shall be ignored.

A DL_RELEASE-req primitive that is received during this establishment procedure shall be queued, and shall be serviced immediately on completion of the establishment procedure.

If timer <DL.02> expires before a RR response with the F bit set to "1" is received, the LAPC entity shall:

- a) if the value of the retransmission counter is less than N250:
 - retransmit the I command as above;
 - add one to the retransmission counter;
 - restart timer <DL.02>;
- b) if the value of the retransmission counter is equal to N250:
 - report establishment failure to the NWK layer with a DL_RELEASE-ind primitive. It shall then discard all relevant DL_DATA-req primitives and all outstanding I-frames, and remain in the ULI state.

9.2.4.3 Class B LLN assignment procedures

9.2.4.3.0 General

Class B assignable values of LLN are always chosen by the PT. In all cases this PT choice of LLN defines a new assignment for that value of LLN. If the FT has existing records of an LLN (e.g. from a previously suspended link) the new assignment shall completely replace the old record.

9.2.4.3.1 PT establishment

For PT initiated establishment, a chosen value of assignable LLN shall be contained in the first I-frame. The NLF bit is set in this first frame to identify a new link establishment.

The responding FT entity shall reply as follows:

- a) if it wishes to accept the class B establishment, the RR response shall also use the chosen assignable value of LLN. The NLF bit shall be set in this accepting RR frame;
- b) if it wishes to refuse the class B establishment and is defaulting to class A operation, the RR response shall use the reserved LLN value "class A operation";
- c) if it wishes to refuse the class B establishment and is unable to default to class A operation the RR response shall use the reserved LLN value "LLN unassigned".

If class B establishment is accepted, the chosen value of LLN shall be used for all subsequent class B frames on this link. The NLF bit shall be clear in all subsequent frames (except for "link release" frames).

Following a refusal of class B operation, the PT may either proceed to operate in class A, or may release the link using the class A release procedures defined in clause 9.2.3.7.

9.2.4.3.2 FT establishment

For FT initiated establishment, the first I-frame shall use the reserved LLN value "LLN unassigned". The NLF bit is set in this first frame, to indicate a new link establishment.

The responding PT entity shall reply as follows:

- a) if it wishes to accept the class B establishment, the RR response shall use a valid assignable LLN value. The NLF bit shall be set in this frame;
- b) if it wishes to refuse the class B establishment and is defaulting to class A operation, the RR response shall use the reserved LLN value "class A operation";
- c) if it wishes to refuse the class B establishment and is unable to default to class A operation the RR response shall use the reserved LLN value "LLN unassigned".

If class B establishment is accepted, the chosen value of LLN shall then be used for all subsequent class B frames on this link. The NLF bit shall be clear in all subsequent frames (except for "link release" frames).

Following a refusal of class B operation, the FT may either proceed to operate in class A, or may release the link using the class A release procedures defined in clause 9.2.3.7.

9.2.5 Link maintenance and information transfer in class B multiple frame operation

9.2.5.0 General

When a LAPC entity has entered the ASM state, as a result of successful class B establishment, I-frames and S-frames may be transmitted according to the procedures described in this clause.

NOTE 1: If a class B link re-establishment occurs, this may cause duplication or loss of layer 3 messages, since the procedure ignores the possible existence of unacknowledged I-frames.

Information received by the LAPC entity from layer 3 by means of DL_DATA-req primitive shall be segmented (if necessary) and the resulting segments shall be transmitted in a series of one or more I-frames.

At the destination LAPC entity, a complete message shall be reassembled from a series of received I-frames, and the complete message shall be delivered to the NWK layer in DL_DATA-ind primitive.

The procedures which apply to the transmission and reception of each I-frame are defined below.

NOTE 2: The term "transmission of an I-frame" refers to the delivery of a complete I-frame to the MAC layer. The term "reception of an I-frame" refers to the receipt of an I-frame by the LAPC from the MAC layer.

In the case of Broadband data link, after the data link has been established (including the first connection) and resource negotiation has taken place (in the NWK layer) multiple MAC connections may be associated with the data link. Reception and/or transmission of LAPC+Lc data (frames) can occur on any of those connections.

9.2.5.1 Transmitting I-frames

For each I-frame, the control field parameters N(S) and N(R) shall be assigned the values of V(S) and V(R), respectively. V(S) shall be incremented by 1 at the end of the transmission of the I-frame.

If timer <DL.04> is not running at the time of transmission of an I-frame, it shall be started. If timer <DL.04> expires, the procedures defined in clause 9.2.5.7 shall be followed.

If V(S) is equal to V(A) plus k (where k is the maximum number of outstanding I-frames - see clause 9.2.4.1), the LAPC entity shall not transmit any new I-frames, but may retransmit an I-frame as a result of the error recovery procedures as described in clauses 9.2.5.4 and 9.2.5.7.

When the NWK side or user side is in the own receiver busy condition, it may still transmit I-frames, provided that a peer receiver busy condition does not exist.

Any DL_DATA-req primitives received whilst in the timer recovery condition shall be queued.

9.2.5.2 Receiving I-frames

9.2.5.2.0 General

Independent of a timer recovery condition, when a LAPC entity is not in an own receiver busy condition and receives a valid I-frame whose N(S) is equal to the current V(R), the LAPC entity shall:

- append the information field of the frame to any existing unfinished message (segment assembly);
- if the more data bit value is "0" (indicating that this is the last segment of a message) it shall pass the complete message to the layer 3 using the DL_DATA-ind primitive;
- increment by 1 its V(R) and depending on the P bit setting, act as indicated in clauses 9.2.5.2.1 and 9.2.5.2.2.

9.2.5.2.1 P bit set to 1

If the P bit of the received I-frame was set to 1, the LAPC entity shall respond to its peer in one of the following ways:

- if the LAPC entity receiving the I-frame is still not in an own receiver busy condition, it shall send an RR response with the F bit set to 1;
- if the LAPC entity receiving the I-frame enters the own receiver busy condition upon receipt of the I-frame, it shall send an RNR response with the F bit set to 1.

9.2.5.2.2 P bit set to 0

If the P bit of the received I-frame was set to 0 and:

- a) if the LAPC entity is still not in an own receiver busy condition:
 - if no I-frame is available for transmission or if an I-frame is available for transmission but a peer receiver busy condition exists, the LAPC entity shall transmit an RR response with the F bit set to 0; or
 - if an I-frame is available for transmission and no peer receiver busy condition exists, the LAPC entity shall transmit the I-frame with the value of N(R) set to the current value of V(R) as defined in clause 9.2.5.1; or

- b) if, on receipt of this I-frame, the LAPC entity is now in an own receiver busy condition it shall:
- transmit an RNR response with the F bit set to 0.

When the data link entity is in an own receiver busy condition, it shall process any received I-frame according to clause 9.2.5.6.

9.2.5.3 Sending and receiving acknowledgements

9.2.5.3.1 Sending acknowledgements

Whenever a LAPC entity transmits an I-frame or a supervisory frame, N(R) shall be set equal to V(R).

9.2.5.3.2 Receiving acknowledgements

On receipt of a valid I-frame or supervisory frame (RR, RNR or REJ), even if in the own receiver busy or timer recovery conditions, the LAPC entity shall treat the N(R) contained in this frame as an acknowledgement for all the I-frames it has transmitted with an N(S) up to and including the received N(R)-1. V(A) shall be set to N(R). The LAPC entity shall reset the timer <DL.04> on receipt of a valid I-frame or supervisory frame with the N(R) higher than V(A) (i.e. when the N(R) actually acknowledges some I-frames), or an REJ-frame with an N(R) equal to V(A).

If a supervisory frame with the P bit set to 1 has been transmitted and not acknowledged, timer <DL.04> shall not be reset.

Upon receipt of a valid I-frame, timer <DL.04> shall not be reset if the data link entity is in the peer receiver busy condition.

If timer <DL.04> has been reset by the receipt of an I, RR or RNR-frame, and if there are outstanding I-frames still unacknowledged, the LAPC entity shall restart timer <DL.04>. If timer <DL.04> then expires, the LAPC entity shall follow the recovery procedure as defined in clause 9.2.5.7 with respect to the unacknowledged I-frames.

If timer <DL.04> has been reset by the receipt of an REJ-frame, the LAPC entity shall follow the retransmission procedures in clause 9.2.5.4.

9.2.5.4 Receiving REJ-frames

On receipt of a valid REJ-frame, the LAPC entity shall act as follows:

- a) if it is not in the timer recovery condition:
- clear an existing peer receiver busy condition;
 - set its V(S) and its V(A) to the value of the N(R) contained in the REJ-frame control field;
 - stop timer <DL.04>;
 - if it was a REJ-command frame with the P bit set to 1, transmit an appropriate supervisory response frame (see clause 9.2.5.8) with the F bit set to 1;
 - transmit the corresponding I-frame as soon as possible, as defined in clause 9.2.5.1, taking into account the items 1) to 3) below and the clause following items 1) to 3);
 - notify a protocol violation to the LLME if it was a REJ-response frame with the F bit set to 1. The REJ response frame with bit = 1 shall be ignored. The FT LLME may log the error. The PT LLME action will be implementation dependent;
- b) if it in the timer recovery condition and it was a REJ-response frame with the F bit set to 1:
- clear an existing peer receiving busy condition;
 - set its V(S) and its V(A) to the value N(R) contained in the REJ-frame control field;
 - stop timer <DL.04>;

- enter the ULI or ASM state as appropriate, according to the associated value of LLN; and
 - transmit the corresponding I-frame as soon as possible, as defined in clause 9.2.5.1, taking into account the items 1) to 3) below and the clause following items 1) to 3);
- c) if it is in the timer recovery condition and it was a REJ-frame other than a REJ-response frame with the F bit set to 1:
- clear an existing peer receiver busy condition;
 - set its V(A) to the value of the N(R) contained in the REJ-frame control field; and
 - if it was a REJ-command frame with the P bit set to 1, transmit an appropriate supervisory response frame with the F bit set to 1.

Transmission of I-frames shall take account of the following:

- 1) if the LAPC entity is transmitting a supervisory frame when it receives the REJ-frame, it shall complete that transmission before commencing transmission of the requested I-frame;
- 2) if the LAPC entity is transmitting a SABM command, a DISC command, a UA response or a DM response when it receives the REJ-frame, it shall ignore the request for retransmission; and
- 3) if the LAPC entity is not transmitting a frame when the REJ is received, it shall immediately commence (re)transmission of the requested I-frame.

All outstanding unacknowledged I-frames, commencing with the I-frame identified in the received REJ-frame, shall be retransmitted. Other I-frames not yet transmitted may be transmitted following these retransmitted I-frames.

9.2.5.5 Receiving RNR-frames

After receiving a valid RNR command or response, if the LAPC entity is not engaged in a mode-setting operation, it shall set a peer receiver busy condition and then:

- if it was an RNR command with the P bit set to 1, it shall respond with either a RR response with the F bit set to 1 (if the LAPC entity is not in an own receiver busy condition) or shall respond with a RNR response with the F bit set to 1 (if the LAPC entity is in an own receiver busy condition); and
- if it was an RNR response with the F bit set to 1, any existing timer recovery condition shall be cleared and the N(R) contained in this RNR response shall be used to update V(S).

The LAPC entity shall take note of the peer receiver busy condition and not transmit any I-frames to the peer which has indicated the busy condition.

The N(R) in any RR- or RNR-command frame (irrespective of the setting of the P bit) shall not be used to update the V(S).

The LAPC entity shall then:

- treat the N(R) contained in the received RNR-frame as an acknowledgement for all the I-frames that have been (re)transmitted with an N(S) up to and including N(R)-1, and set its V(A) to the value of the N(R) contained in the RNR-frame; and
- restart timer <DL.04> unless a supervisory response frame with the F bit set to 1 is still expected.

If timer <DL.04> expires, the LAPC entity shall:

- if it is not yet in a timer recovery condition, enter the timer recovery condition and reset the retransmission count variable; or
- if it is already in a timer recovery condition, add one to its retransmission count variable.

The LAPC entity shall then:

- a) if the value of the retransmission count variable is less than N250:
 - transmit an appropriate supervisory command (see clause 9.2.5.8) with a P bit set to 1;
 - restart timer <DL.04>; and
- b) if the value of the retransmission count variable is equal to N250:
 - initiate a re-establishment procedure as defined in clause 9.2.8, and indicate this to the LLME.

The LAPC entity receiving the supervisory frame with the P bit set to 1 shall respond, at the earliest opportunity, with a supervisory response frame (see clause 9.2.5.8) with the F bit set to 1, to indicate whether or not its own receiver busy condition still exists.

Upon receipt of the supervisory response with the F bit set to 1, the LAPC entity shall reset timer <DL.04>, and:

- if the response is a RR or REJ response, the peer receiver busy condition is cleared and the LAPC entity may transmit new I-frames or retransmit I-frames as defined in clauses 9.2.5.1 or 9.2.5.4, respectively; or
- if the response is a RNR response, the LAPC entity receiving the response shall proceed as specified earlier in this clause.

If a supervisory command (RR, RNR or REJ) with the P bit set to 0 or 1, or a supervisory response frame (RR, RNR or REJ) with the F bit set to 0 is received during the enquiry process, the LAPC entity shall:

- if the supervisory frame is a RR- or REJ-command frame or a RR- or REJ-response frame with the F bit set to 0, clear the peer receiver busy condition and if the supervisory frame received was a command with the P bit set to 1, transmit the appropriate supervisory response frame (see clause 9.2.5.8) with the F bit set to 1. However, the transmission or retransmission of I-frames shall not be undertaken until the appropriate supervisory response frame with the F bit set to 1 is received or until expiry of timer <DL.04>; or
- if the supervisory frame is a RNR command frame or a RNR-response frame with the F bit set to 0, retain the peer receiver busy condition and if the supervisory frame received was an RNR command with P bit set to 1, transmit the appropriate supervisory response frame (see clause 9.2.5.8) with the F bit set to 1.

Upon receipt of an SABM command, the LAPC entity shall clear the peer receiver busy condition.

9.2.5.6 LAPC own receiver busy condition

When a LAPC entity enters an own receiver busy condition, it shall transmit a RNR-frame at the earliest opportunity. The RNR-frame may be either:

- a RNR response with the F bit set to 0; or
- if this condition is entered on receiving a command frame with the P bit set to 1, a RNR response with the F bit set to 1; or
- if this condition is entered on expiring of timer <DL.04>, a RNR command with the P bit set to 1.

All received I-frames with the P bit set to 0 shall be discarded, after updating V(A).

All received supervisory frames with the P/F bit set to 0 shall be processed, including updating V(A).

All received I-frames with the P bit set to 1 shall be discarded, after updating V(A). However, a RNR-response frame with the F bit set to 1 shall be transmitted.

All received supervisory frames with the P bit set to 1 shall be processed including updating V(A). A RNR response with the F bit set to 1 shall be transmitted.

To indicate to their peer LAPC entity the clearance of the own receiver busy condition, the LAPC entity shall transmit a RR-frame or, if a previously detected N(S) sequence error has not yet been reported, a REJ-frame with the N(R) set to the current value of V(R).

The transmission of an SABM command or a UA response (in reply to an SABM command) also indicates to the peer LAPC entity the clearance of the own receiver busy condition.

NOTE: In class A operation, the LAPC entity takes no action as a result of entering an own receiver busy condition. The busy condition can only be inferred by the peer entity from an absence of any responses.

9.2.5.7 Waiting acknowledgement

The LAPC entity shall maintain an internal retransmission count variable. If timer <DL.04> expires, the LAPC entity shall:

- if it is not yet in the timer recovery condition, enter the timer recovery condition and reset the retransmission count variable; or
- if it is already in the timer recovery condition, add one to its retransmission count variable.

The LAPC entity shall then:

- a) if the value of the retransmission count variable is less than N250:
 - restart timer <DL.04>; and
 - either transmit an appropriate supervisory command (see clause 9.2.5.8) with the P bit set to 1; or
 - retransmit the last transmitted I-frame (V(S)-1) with the P bit set to 1; or
- b) if the value of the retransmission count variable is equal to N250:
 - initiate a re-establishment procedure as defined in clause 9.2.8 and indicate this to the LLME.

The timer recovery condition is cleared when the LAPC entity receives a valid supervisory frame response with the F bit set to 1. If the received supervisory frame N(R) is within the range from its current V(A) to its current V(S) inclusive, it shall set its V(S) to the value of the received N(R). Timer <DL.04> shall be reset if the received supervisory frame response is a RR or REJ response, and then the LAPC entity shall resume with I-frame transmission or retransmission, as appropriate. Timer <DL.04> shall be reset and restarted if the received supervisory response is a RNR response, to proceed with the enquiry process according to clause 9.2.5.5.

9.2.5.8 Appropriate supervisory frame

If the LAPC entity is not in an own receiver busy condition and is in a Reject exception condition (that is, an N(S) sequence error has been received and a REJ-frame has been transmitted, but the requested I-frame has not been received), the appropriate supervisory frame is the RR-frame.

If the LAPC entity is not in an own receiver busy condition but is in an N(S) sequence error exception condition (that is, an N(S) sequence error has been received but a REJ-frame has not been transmitted), the appropriate supervisory frame is the REJ-frame.

If the LAPC entity is in its own receiver busy condition, the appropriate supervisory frame is the RNR-frame.

Otherwise, the appropriate supervisory frame is the RR-frame.

9.2.6 Release of class B multiple frame operation

Class B multiple frame operation is only released in response to a layer 3 request contained in a DL_RELEASE-req primitive. This request can appear at either end of the link (i.e. from either layer 3 entity) without warning.

If this primitive indicates the release mode as "normal" the LAPC entity shall first attempt to complete transmission of all outstanding I-frames and of all outstanding DL_DATA-req primitives before releasing the link. The LAPC shall only initiate link release as described in the following clauses if all of this outstanding data has been successfully acknowledged.

If there is no outstanding data, or if the DL_RELEASE-req primitive indicates "abnormal" release mode, the LAPC shall initiate an immediate link release. As soon as these release procedures have been initiated, all received frames shall be ignored. All outstanding DL_DATA-req primitives and all queued I-frames shall be discarded.

To initiate a link release, the initiating LAPC entity, transmits the disconnect command, with the P bit set to "1", and containing the LLN value of the link to be released. The NLF bit is set. Timer <DL.00> is started, and the retransmission counter is reset.

The LAPC entity receiving the DISC command with the NLF bit set, while in the ASM state, shall transmit a UA response with the F bit set to the same binary value as the P bit in the DISC command, shall immediately delete the LLN assignment, and shall enter the "ULI" state.

The LAPC entity receiving the DISC command with the NLF bit set, while in the ALI or ULI state, shall transmit a DM response with the F bit set to the same binary value as the P bit in the DISC command, and shall immediately delete the LLN assignment and shall (re)enter the ULI state.

The originator of the DISC command receives either:

- a UA response with the F bit set to "1";
- a DM response with the F bit set to "1".

NOTE: The DM response indicates that the peer LAPC entity was already in the "ULI" or "ALI" state.

If timer <DL.00> expires before a UA or DM response with the F bit set to "1" is received, the LAPC entity shall report "abnormal" release to the NWK layer with a DL_RELEASE-ind primitive and shall immediately enter the ULI state.

If no other links are using the associated MAC connection, the LLME shall immediately release that connection as described in clause 10.2.2.

A class B entity, upon receiving an unexpected upward release shall proceed according to the procedures defined in clause 9.2.7.

9.2.7 Link suspension and resumption

9.2.7.1 Link suspension

9.2.7.1.0 General

A data link may be suspended in two ways:

- acknowledged suspend; and
- unacknowledged suspend.

The acknowledged suspend procedure can only be invoked by a layer 3 request, and shall only be used for a class B link. This request can appear at either end of the link without any warning.

NOTE: Acknowledged suspend of a class A link is not supported. An equivalent function is available using "normal" release of the class A link.

The unacknowledged suspend procedure is invoked by an (unexpected) loss of service from the MAC layer. This event should normally invoke an immediate connection handover.

9.2.7.1.1 Class B acknowledged suspend

The acknowledged suspend procedure can be initiated by either the PT or the FT in response to a DL_SUSPEND-req primitive from the NWK layer. Acknowledged suspend only applies to class B links. If the class B LAPC entity is in the ULI or ALI state, no action is required in response to this DL_SUSPEND-req primitive. The following procedures will only be followed when the entity is in the ASM state.

NOTE: For a class A entity, information transfer is allowed in the ULI state, and the acknowledged suspend procedure is not supported. In the ULI state, the radio resources can only be released by a DL_RELEASE-req primitive, which also releases the LAPC resources.

The acknowledged suspend procedure is similar to the class B release procedure, and the two procedures are only distinguished by the use of the NLF bit (see below). During the acknowledged suspend procedure, all (class B) frames shall be ignored.

Upon receipt of a DL_SUSPEND-req primitive, the LAPC entity shall first attempt to complete transmission of all outstanding I-frames and of all outstanding DL_DATA-req primitives before suspending the link. The LAPC shall only initiate link release as described in the following clauses when all of this outstanding data has been successfully acknowledged.

As soon as there is no outstanding data, the initiating LAPC entity, transmits the disconnect command, with the P bit set to "1", and containing the LLN value of the link to be released. The NLF bit shall be cleared, to distinguish this from a normal disconnect. Timer <DL.01> shall be started.

The peer LAPC entity shall only accept the link suspension if it is in the ASM state, and if it has no outstanding I-frames or DL_DATA-req primitives.

The LAPC shall automatically refuse the suspension if these conditions are not fulfilled. But even if LAPC accepts the suspension, it may still be refused by the NWK layer.

If the LAPC entity receiving the DISC command with the NLF bit cleared is in the ASM state and is able to accept the suspension, it shall issue a DL_SUSPEND-ind primitive to the NWK layer, and shall await a DL_SUSPEND-res primitive in response. If the DL_SUSPEND-res primitive indicates "accept", the receiving LAPC shall transmit a UA response with the F bit set to the same binary value as the P bit in the DISC command, and with the NLF bit cleared. The receiving LAPC entity shall then enter the "ALI" state. The value of the retransmission counter, the variables V(S) V(R) and V(A) and the suspended value of LLN shall all be preserved.

If a LAPC entity receives a DISC command with the NLF bit cleared, when it is not in the ASM state, or when is not able to accept the suspension, it shall respond with a UA-frame with the NLF bit set. No primitives shall be issued to the NWK layer. This procedure shall also be followed if the NWK layer indicates "reject" in the DL_SUSPEND-res primitive. In both cases, the LAPC may immediately continue with normal frame transmission procedures.

Upon receipt of the UA response with the NLF bit cleared, the initiating LAPC entity shall enter the "ALI" state and shall inform the NWK layer using a DL_SUSPEND-cfm primitive indicating "accept". The value of the retransmission counter, the variable V(S) V(R) and V(A) and the suspended value of LLN shall all be preserved. Timer <DL.01> shall be reset.

Upon receipt of the UA response with the NLF bit set, the initiating LAPC entity shall remain in the "ASM" state and shall inform the NWK layer using a DL_SUSPEND-cfm primitive indicating "reject".

If the suspend is accepted, and if no other links are using the associated MAC connections, the LLME shall immediately release that connections as described in clause 10.2.2.

A DLC entity, upon receiving an unexpected upward release shall proceed according to the procedures defined in clause 9.2.7.1.2.

9.2.7.1.2 Unacknowledged suspend

9.2.7.1.2.0 General

The unacknowledged suspend procedure is invoked by an unexpected upward release, as reported with a MAC_DIS-ind primitive. This primitive shall distinguish between an abnormal release (unexpected MAC failure) and a normal release (release ordered by peer DLC entity).

Upon receiving this upward release, the LAPC entity shall respond according to the class of operation.

9.2.7.1.2.1 Class A

- Case 1:** abnormal release: enter the connection handover pending condition, and immediately initiate the connection handover procedures. Timer <DL.05> shall be started. For the relevant (class A only) link, the retransmission counter shall be reset and the DL.04 timer is stopped, and the values of the variables V(S), V(R) and V(A) shall be preserved. DL.04 timer shall be restarted when this connection handover is successful;

Case 2: normal release: release the link, and issue a DL_RELEASE-ind primitive indicating "normal" to the NWK layer.

9.2.7.1.2.2 Class B

Case 1: abnormal release: enter the connection handover pending condition, and immediately initiate the connection handover procedures. Timer <DL.05> shall be started. For all relevant (class B) links, the retransmission counter shall be reset and the DL.04 timer is stopped, and the values of the variables V(S), V(R) and V(A), and the suspended value(s) of LLN shall be preserved. DL.04 timer shall be restarted when this connection handover is successful;

Case 2: normal release: enter the "ALI" state and inform the NWK layer using a DL_SUSPEND-ind primitive. For all relevant (class B only) links, the retransmission counter shall be reset, and the values of the variables V(S) V(R) and V(A), and the suspended value(s) of LLN shall be preserved.

9.2.7.1.2.3 Class U

No action required.

9.2.7.2 Class B link resumption

Class B operation of a data link is normally resumed in response to a NWK layer request contained in a DL_RESUME-req primitive. This request can appear at either side of a suspended link.

In the case of an unacknowledged release, a link shall be immediately resumed in response to either:

- the existence of outstanding I-frames;
- connection handover request from the LLME.

Class B link resumption requires the initiating LAPC entity to be in the ALI or ASM state. If the entity is in the ULI state, it shall immediately respond with a DL_RELEASE-ind primitive.

The link resumption procedure uses either a SABM- or an I-command frame as requested by the DL_RESUME-req primitive.

If a SABM-frame resumption is requested, the procedures given in clause 9.2.8 shall be followed.

If an I-frame resumption is requested, this first resumption command frame shall contain the LLN of the link to be resumed, the P bit shall be set to "1", and the NLF bit shall be cleared.

Upon receiving a resume I-frame whilst in the "ALI" state, the receiving LAPC entity shall issue a DL_RESUME-ind primitive to the NWK layer. The NWK layer may either accept the resumption by returning a DL_RESUME-res primitive, or may refuse the resumption and request a link release by returning a DL_RELEASE-req primitive. The LAPC shall then proceed according to the NWK layer response as follows.

Table 9.2.7.2.1: Immediate response to resume command frame

Resume command frame P bit = "1"	Accept response frame F bit = "1"	Refuse response frame F bit = "1"
SABM	UA	DM
I	RR, RNR, REJ	DM

If an I-frame resumption is accepted, the LAPC entity shall enter the "ASM" state, and follow the normal I-frame procedures given in clause 9.2.5. The NLF flag shall be cleared in the response frame and in all subsequent frames, The following primitives are used to report to the NWK layer.

Table 9.2.7.2.2: Primitives used during I-frame link resumption

Receiving entity response	Response frame	Initiating entity
Accept: DL_RESUME-res	RR, RNR, REJ	DL_RESUME-cfm
Reject: DL_RELEASE-req	DM	DL_RELEASE-ind

NOTE 1: If the re-establish (SABM) procedure is used for link resumption, there may be duplication or loss of layer 3 messages, since the re-establish procedure ignores the possible existence of unacknowledged I-frames. This problem is avoided if the I-frame procedure is used.

NOTE 2: The I-frame resumption procedure is the recommended procedure following an unacknowledged suspension. It is designed to be identical to the normal I-frame transmission procedure such that, if the receiving entity has not detected an unacknowledged suspension, there is no loss of information (the receiving entity simply issues no DL_RESUME primitives).

NOTE 3: A LLN is not lost if the link is never resumed. The PT can reuse the LLN at any time by simply establishing a new link that re-uses the LLN.

If a resume command frame is received after sending a resume command frame, the DLC shall respond with an accept response frame as indicated in table 9.2.7.2.1.

9.2.7.3 Connection handover

9.2.7.3.0 General

Connection handover involves the replacement of an old MAC connection, with a new MAC connection bearing a new connection identity. All C-plane entities (and all U-plane entities) that were using the old connection shall be associated (reconnected) to the new connection. Connection handover may arise as a result of two events:

Involuntary handover: a loss of service from the MAC layer, resulting in an "abnormal" upward release (see clause 9.2.7.1.2). Timer <DL.05> shall be started as part of the unacknowledged suspend procedure defined in clause 9.2.7.1.2.

Voluntary handover: a LLME request, normally as a result of continued poor quality of service from the MAC layer (see clause 10.5).

In both cases, the establishment of a new MAC connection shall be initiated by the LLME at the PT side using the procedures described in clause 10.2. See clauses 9.2.7.3.1 and 9.2.7.3.2.

In the case of voluntary handover, the release of the old MAC connection shall also be initiated by the PT using the procedures described in clause 10.2.2. The release shall normally follow immediately after receipt of a MAC_CON-cfm primitive (or MAC_MOD-cfm primitive) for the new connection (plus any necessary link associations).

The new MAC connection shall be identified as being a connection handover in the MAC_CON-ind primitive. Two cases exist: basic connection handover and advanced connection handover. Refer to ETSI EN 300 175-3 [3] for definitions of basic and advanced connections.

Basic connection handover: handover of a basic connection shall result in a new basic connection. The new basic connection can be unambiguously related to one old basic connection because only one basic connection shall exist (except during handover) for any given PT. At the FT, the parallel voluntary connection handover shall if supported, be handled as follows.

At the FT, receipt of the MAC_CON-ind primitive from the new connection shall cause all links associated to the old connection to be immediately associated to the new connection and the FT may then terminate the old connection if it is in "CLEAR" mode. If the old connection is in "ENCRYPTED" mode, the FT shall await the reception of the MAC_ENC_EKS-ind before associating the link to the new connection.

NOTE 1: "Terminate" means that all associations to the old connection may be immediately removed, without requiring the connection to be released. The old MAC connection will only be released by a PT initiated release (or by a MAC layer timeout).

At the FT, the serial voluntary and the involuntary connection handover shall if supported be handled as follows.

A receipt of a MAC_DIS-ind primitive which was caused by a RFPI handshake error in the MAC layer shall result in a release of the link. Upon the receipt of a MAC_DIS-ind primitive caused by another reason, the DLC enters the "connection handover pending" state and timer DL.05 shall be started. In the "connection handover pending" state the FT shall distinguish between a MAC_CON-ind primitive with Connection-Handover flag = "on" and a MAC_CON-ind primitive signalling Connection-Handover flag = "off". If the MAC_CON-ind primitive from the new connection indicates Connection-Handover flag = "on" this shall cause all links associated to the old connection to be immediately associated to the new connection. If the old connection was in "CLEAR" mode transmission on the new connection shall be started immediately. If the old connection was in "ENCRYPTED" mode, the FT shall await the reception of the MAC_ENC_EKS-ind before starting transmission on the new connection. The "connection handover pending" state shall be left and timer DL.05 shall be stopped.

If the MAC_CON-ind primitive from the new connection indicates Connection-Handover flag = "off" this shall cause all links associated to the old connection to be removed and timer DL.05 shall be stopped. This release of the link shall be reported to the NWK layer using a DL_RELEASE-ind primitive with the release mode parameter set to abnormal. The connection shall be associated to a new data link following the link establishment procedure described in clause 9.2.3.1. When the timer DL.05 expires the link shall be released.

At the PT, upon receipt of the MAC_DIS-ind primitive which was not caused by a RFPI handshake error in the MAC layer, the DLC releases the data link. The receipt of a MAC_CON-cfm primitive shall cause all links associated with the old connection to be immediately associated to the new connection and the PT shall then immediately release the old connection if it is in "CLEAR" mode. If the old connection is in "ENCRYPTED" mode, the PT shall issue a MAC_ENC_EKS-req to the MAC layer for starting encryption and wait for the MAC_ENC_EKS-cfm before associating the link to the new connection.

Advanced connection handover: handover of an advanced connection shall result in a new advanced connection. multiple advanced connections may exist within one PT, and in this case the MAC_CON-ind primitive shall supply an ECN containing the LCN of the old connection (see clause 10.2.4). The value of LCN is the same for the old and the new connections, and may therefore be used to identify the relevant old (advanced) connection.

At the FT, receipt of a MAC_CON-ind or MAC_MOD-ind primitive indicating completion of connection establishment shall cause all links associated to the old connection to be immediately associated to the new connection and the FT may then terminate the old connection.

NOTE 2: "Terminate" means that all associations to the old connection may be immediately removed, without requiring the connection to be released. The old MAC connection will only be released by a PT initiated release (or by a MAC layer timeout).

At the PT, receipt of a MAC_CON-cfm or MAC_MOD-cfm primitive indicating completion of connection establishment shall cause all links associated to the old connection to be immediately associated to the new connection and the PT shall immediately release the old connection.

The relevant primitive for completion of an advanced connection establishment shall be either:

- a MAC_CON primitive indicating a known connection type; or
- a MAC_MOD primitive in the event that the MAC_CON primitive indicates connection type "unknown" (see clause 10.2).

Refer to ETSI EN 300 175-3 [3] for details of Medium Access Control (MAC) Layer connections.

The quality of the connection handover (in particular the duration of any service interruption) is a function of both the PP and the FP.

These procedures are primarily designed to support handover of a call-in-progress in response to changing (radio) propagation conditions.

NOTE 3: Similar procedures can also be activated to transfer a DLC data link (C-plane only) between pre-existing MAC connections. This is also initiated by a request from the LLME.

9.2.7.3.1 Class A connection handover

Voluntary handover: voluntary connection handover uses the following procedures to establish a new MAC connection, and to associate the old link to the new connection.

LLME procedures (see clause 10.2):

- a) establishment of a new MAC connection by the PT;
- b) normal release of the old MAC connection by the PT.

Procedures a) and b) may be managed serially or in parallel. In the case of serial operation, where the old connection is released before the new MAC connection is established, there will usually be a short interruption to the offered service. In the case of fully parallel operation, where the new MAC connection is fully established before the old connection is released, the handover may give no interruption to the offered service. This results in the so-called "seamless" connection handover.

Involuntary handover: involuntary connection handover uses the following procedures to establish a new MAC connection, following an abnormal release of the old connection.

LLME procedures (see clause 10.2):

- establishment of a new MAC connection by the PT.

NOTE: Involuntary handover is not expected to provide "seamless" operation.

9.2.7.3.2 Class B connection handover

Voluntary handover: voluntary class B connection handover uses the link suspension and resumption procedures, with the additional requirement that the link resumption is transmitted using a new connection. Voluntary connection handover involves the co-ordinated use of both LLME and LAPC procedures as follows:

LAPC procedures (see clause 9.2.7):

- a) suspension of all links by the PT (acknowledged suspension or unacknowledged suspension);
- b) resumption of the link(s) by the PT using the new connection.

LLME procedures (see clause 10.2):

- c) establishment of a new MAC connection by the PT;
- d) release of the old MAC connection by the PT (acknowledged suspension only).

These groups of procedures may be managed serially or in parallel. In the case of serial operation, where the link(s) are suspended before the new MAC connection is established, there will usually be a short interruption to the offered service. In the case of fully parallel operation, where the new MAC connection is fully established before the links are suspended (and before the old MAC connection is released), the handover may give no interruption to the offered service. This results in the so-called "seamless" connection handover.

Involuntary handover: involuntary connection handover uses the following LAPC and LLME procedures to establish a new MAC connection, following an abnormal release of the old connection.

LAPC+Lc procedures (see clause 9.2.7):

- a) unacknowledged suspension of all links;
- b) resumption of the link(s) by the PT using the new connection.

LLME procedures (see clause 10.2):

- c) establishment of a new MAC connection by the PT.

Involuntary handover is not expected to provide "seamless" operation.

9.2.7.3.3 Expiry of connection handover timer

If the connection handover timer, <DL.05>, expires whilst in the connection handover pending condition, all of the links shall be immediately released and the NWK layer shall be informed for each link using a DL_RELEASE-ind primitive with the release mode parameter set to "abnormal".

The associated connection shall also be released using the procedures defined in clause 10.2.2.

9.2.8 Re-establishment of class B multi-frame operation

9.2.8.1 Criteria for re-establishment

The normal criteria for re-establishing the multiple frame mode of operation are defined in this clause by the following conditions:

- the receipt, while in the class B multiple-frame mode of operation, of a SABM-frame;
- the receipt of a DL_ESTABLISH-req primitive from the NWK layer, specifying class B operation;
- the occurrence of N250 retransmission failures while in the timer-recovery condition (see clause 9.2.5.7);
- the receipt, while in class B multiple-frame operation, of an unsolicited DM response with the F bit set to 0;
- the receipt, while in the timer-recovery condition, of a DM response with the F bit set to 1;
- the receipt of a N(R) sequence error (see clause 9.2.9.2.2).

The link resumption criteria for re-establishing the multi-frame mode of operation are given by the following conditions:

- the receipt of a DL_RESUME-req primitive indicating that a SABM-frame should be used to resume a class B link.

9.2.8.2 Procedure

In all re-establishment situations, the LAPC entity shall follow the procedures defined below. All locally generated conditions for re-establishment will cause the transmission of the SABM.

The initiating LAPC, shall transmit a SABM-command frame, with the P bit set to "1". All existing exception conditions shall be cleared, the retransmission counter shall be reset and timer <DL.02> shall be started. The NLF bit shall be set in this SABM-command frame.

If the responding LAPC entity is able to accept the request, it shall respond to the receipt of the SABM-frame by issuing a DL_ESTABLISH-ind primitive to the NWK layer. Upon receipt of a DL_ESTABLISH-res primitive containing the same DLEI, it shall transmit a UA-response frame with the F bit set to the same binary value as the P bit in the SABM-frame. It shall clear all existing exception conditions, and the retransmission counter shall be reset. The NLF bit shall be set in this UA-response frame. The NLF bit shall then be cleared in all subsequent frames.

It shall then (re)enter the "ASM" state.

If the responding LAPC entity is unable to accept the request, it shall respond to the receipt of the SABM-frame by transmitting a DM-response frame with the F bit set to the same binary value as the P bit in the SABM-frame. The NLF bit shall be set in this DM-response frame.

Upon receipt of the UA response with the F bit set to "1", the originator of the SABM command shall:

- reset timer <DL.02>;
- set the sequence variables V(S) V(R) and V(A) to "0";
- (re)enter the "ASM" state;
- inform the NWK layer using a DL_ESTABLISH-cfm primitive.

Upon receipt of a DM response with the F bit set to "1", the originator of the SABM command shall indicate this to the NWK layer by means of the DL_RELEASE-ind primitive and reset timer <DL.02>. DM responses with the F bit set to "0" shall be ignored.

A DL_RELEASE-req primitive that is received during this re-establishment procedure shall be queued, and shall be serviced immediately on completion of the re-establishment procedure.

In the case of LAPC and peer initiated re-establishment, the initiating LAPC entity shall also:

- issue an indication to the lower layer management entity (LLME); and
- if $V(S) > V(A)$ prior to re-establishment, issue a DL_ESTABLISH-ind primitive to the NWK layer, and discard all I queues.

In case of a NWK layer initiated re-establishment; or if a DL_ESTABLISH-req primitive occurs whilst re-establishment is pending, the DL_ESTABLISH-cfm primitive shall be used.

9.2.9 Exception handling

9.2.9.1 General

All unexpected or unknown frames shall be discarded. The meaning of "unknown frames" depends on the PT (or FT) capability. All frames that are not used for the relevant class of operation (class B acknowledged, class A acknowledged) are defined to be "unknown frames". The relevant frames for each class are defined in clause 7.11.

9.2.9.2 Class B exception condition reporting and recovery

9.2.9.2.0 General

Exception conditions may occur as the result of MAC layer errors or LAPC procedural errors. The following error recovery procedures are available to perform recovery following the detection of an exception condition at the LAPC when operating in class B.

9.2.9.2.1 N(S) sequence error

An N(S) sequence error exception condition occurs in the receiver when a valid I-frame is received which contains an N(S) value which is not equal to the V(R) at the receiver. The information field of all I-frames whose N(S) does not equal V(R) shall be discarded.

The receiver shall not acknowledge (nor increment its V(R)) as a result of the I-frame causing the sequence error, nor any I-frames which may follow, until an I-frame with the correct N(S) is received.

A LAPC entity which receives one or more I-frames having sequence errors but otherwise error-free, or subsequent supervisory frames (RR, RNR and REJ), shall use the control field information contained in the N(R) field and the P or F bit to perform LAPC control functions, for example, to receive acknowledgement of previously transmitted I-frames and to cause the LAPC entity to respond if the P bit is set to 1. Therefore, the retransmitted I-frame may contain an N(R) field value and P bit that are updated from and therefore different from, the ones contained in the originally transmitted I-frame.

The REJ-frame is used by a receiving LAPC entity to initiate an exception condition recovery (retransmission) following the detection of an N(S) sequence error.

Only one REJ exception condition for a given direction of information transfer shall be established at a time.

A LAPC entity receiving an REJ-command or response shall initiate sequential transmission (retransmission) of I-frames starting with the I-frame indicated by the N(R) contained in the REJ-frame.

A REJ exception condition is cleared when the requested I-frame is received or when an SABM or DISC command is received.

9.2.9.2.2 N(R) sequence error

A N(R) sequence error exception condition occurs in the transmitter when a valid supervisory frame or I-frame is received which contains an invalid N(R) value. A valid N(R) is one that is in the range $V(A) \leq N(R) \leq V(S)$.

Upon detection of a N(R) sequence error, the LAPC entity shall immediately initiate the link re-establishment procedures according to clause 9.2.8.

The information field contained in an I-frame which is correct in both sequence and format may still be delivered to layer 3 by means of the DL_DATA-ind primitive.

9.2.9.2.3 Timer recovery condition

If a DLC entity, due to a transmission error, does not receive a single I-frame or the last I-frame(s) in a sequence of I-frames, it will not detect an out-of-sequence exception condition and therefore will not transmit a REJ-frame.

The LAPC entity which transmitted the unacknowledged I-frame(s) shall take appropriate recovery action as defined in clause 9.2.5.7 to determine at which I-frame retransmission needs to begin.

9.2.9.2.4 Collision of identical transmitted and received commands

If the transmitted and received unnumbered commands (SABM or DISC) are the same, the DLC entity shall send the UA response at the earliest possible opportunity. The indicated state shall be entered after receiving the UA response. The DLC entity shall notify the NWK layer by means of the appropriate confirm primitive.

9.3 Unacknowledged operation

9.3.1 Use of LLN for unacknowledged information transfer

No LLN assignment is required if the link will only be used for unacknowledged (unnumbered) information transfer.

All unacknowledged frames (UI) shall use the reserved "class U operation" value of LLN.

9.3.2 Class U link establishment

Upon receipt of a DL_ESTABLISH-req primitive indicating class U operation, the link shall be associated to an "Open" MAC connection, and if this association is successful a DL_ESTABLISH-cfm primitive shall be returned to the NWK layer. If the association is unsuccessful a DL_RELEASE-ind primitive shall be returned indicating "abnormal" release.

At the receiving side, the receipt of the first UI-frame shall result in a DL_ESTABLISH-ind primitive indicating class U operation.

9.3.3 Unacknowledged information transfer

9.3.3.1 Transmission of unacknowledged information

Unacknowledged information is passed to the DLC layer by the NWK layer using the DL_UNIT_DATA-req primitive. The complete message unit of this primitive shall be transmitted in a single UI-frame. No DLC layer error recovery procedures are defined for UI-frames (in particular, there is no retransmission of UI-frames).

The P bit shall be set to "0" and the NLF bit shall be cleared in all UI-frames.

In the event of a MAC layer failure, as indicated with a MAC_DIS-ind primitive, all UI transmission queues shall be discarded.

9.3.3.2 Reception of unacknowledged information

On receipt of a UI-command frame with a valid SAPI and LLN, the contents of the information field shall be passed to the NWK layer using the DL_UNIT-DATA-ind primitive.

Frames shall only be accepted if they contain the reserved value of LLN ("class U operation"). The P bit and the NLF flag should be ignored, and frames should be accepted with errors in either or both of these bits. All valid frames shall be immediately delivered to the NWK layer via the S-SAP.

Otherwise the UI-frame shall be discarded, and no further action shall be taken.

9.3.4 Unacknowledged release

Release of a class U link shall use the class A procedures described in clause 9.2.3.7, except that the link shall be released immediately in both the "normal" release and "abnormal" release cases. All outstanding UI-frames and all queued DL_UNIT_DATA-req primitives shall be discarded.

9.4 Broadcast operation

9.4.1 Normal operation

9.4.1.1 Procedure in the Fixed radio Termination (FT)

The normal broadcast procedure shall be initiated by the NWK layer by sending a DL_BROADCAST-req primitive. The Lb entity in the FT shall receive the complete broadcast information in a DL_BROADCAST-req primitive via the B-SAP. This primitive should also contain a list of one or more cluster addresses.

The DLC layer shall pass each complete frame to the MAC layer via the MA-SAP in a single MAC_PAGE-req primitive, with the page type parameter set to "normal". If several MAC layer SAPs are addressed (corresponding to different clusters), this primitive shall be duplicated and sent separately to each SAP.

Each primitive shall specify the length of the information (the length of the broadcast frame); this value shall only define one of the standard values listed in clause 6.2.1.

Alternatively, when an extended message is indicated, the extended frame format shall be used, and the message length shall define one of the extended values listed in clause 6.2.2.

9.4.1.2 Procedure in the Portable radio Termination (PT)

Upon receipt of a MAC_PAGE-ind primitive with the page type parameter set to "normal", via the MA-SAP, the Lb entity in the PT shall pass this information immediately to the NWK layer as a DL_BROADCAST-ind primitive via the B-SAP.

Each primitive shall specify the length of the information (the length of the broadcast frame); this value shall only define one of the standard values listed in clause 6.2.1. If a CRC error is indicated in the MAC_PAGE-ind primitive the error flag shall be set in the relevant DL_BROADCAST-ind primitive.

If the MAC_PAGE-ind primitive indicates a "long" message, the extended frame format shall be used, and the message length shall indicate one of the extended values listed in clause 6.2.2.

9.4.2 Expedited operation

9.4.2.1 Procedure in the Fixed radio Termination (FT)

Expedited operation shall be indicated when the Lb entity receives the broadcast information in a DL_EXPEDITED-req primitive. The Lb entity shall treat such messages as priority messages and shall process them before any queued DL_BROADCAST-req primitives. This primitive shall also contain a list of one or more cluster addresses.

The DLC layer shall pass each complete frame to the MAC layer via the MA-SAP in a single MAC_PAGE-req primitive, with the page type parameter set to "fast". If several SAPs are addressed (corresponding to different clusters), this primitive shall be duplicated and sent separately to each SAP.

Each primitive shall specify the length of the information (the length of the broadcast frame); this value shall only define one of the standard values listed in clause 6.2.1.

NOTE: Extended frames do not use the expedited procedure.

9.4.2.2 Procedure in the Portable radio Termination (PT)

Upon receipt of a MAC_PAGE-ind primitive with the page type parameter set to "fast", via the MA-SAP, the Lb entity in the PT shall pass this information immediately to the NWK layer as a DL_EXPEDITED-ind primitive via the B-SAP. Expedited information shall be processed before any queued normal broadcast information.

Each primitive shall specify the length of the information (the length of the broadcast frame); this value shall only define one of the standard values listed in clause 6.2.1. If a CRC error is indicated in the MAC_PAGE-ind primitive the error flag shall be set in the relevant DL_EXPEDITED-ind primitive.

9.5 MAC layer interfaces

9.5.1 MC-SAP

9.5.1.1 C-plane overview

All C-plane connection oriented (point-to-point) services shall interface with the MAC layer via the MC-SAP. The MC-SAP shall also be used to manage the underlying MAC connections, as described in clause 10.2.

Every instance of connection oriented FT LAPC+Lc (implicitly for one given PT) shall be associated to one, physical or logical, MAC connection via the MAC Connection Identifier (MCI) as defined in clause 10.2.4. Each Lc fragment shall then be transmitted to the MAC layer using one or more of the procedures (and associated primitives) described in clause 9.5.1.2. The procedure shall be selected according to the state of the associated MAC connection using the following rules:

- 1) if the associated MAC connection is in the "open" state, the Lc fragments shall be sent according to procedure A;
- 2) if the associated connection is in the "closed" state when data is scheduled for transmission, the connection shall be (re-) opened using the procedure defined in clause 10.2.1. During connection establishment, the service data shall be queued until the connection is in the "open" or "open-pending" state; as soon as the connection is in the "open" state, all queued data shall be transferred in the order of its arrival, according to procedure A. Queued data may also be sent during the "open-pending" state using procedure B;
- 3) if the associated MAC connection is in the "open-pending" state, the Lc fragments may be sent using procedure B.

Refer to annex C for an overview of MAC connection states as viewed by the DLC layer.

9.5.1.2 C-plane service data procedures

There are two alternative procedures for service data transfer via the MC-SAP. The procedure shall depend on the connection state as follows:

Procedure A: normal data transfer: C-plane service data may be submitted to the C_S and C_F logical channel of any MAC connection that is in the "open" state, using the MAC_CO_DATA-req primitive in response to a MAC_CO_DTR-ind primitive.

NOTE: This mechanism provides flow control. Each MAC_CO_DTR-ind primitive specifies the available capacity, and the responding MAC_CO_DATA-req primitive may supply a number of fragments equal to or less than this capacity.

Procedure B: early data transfer: service data may be transferred during the "open-pending" state (see annex C), by responding to possible MAC_CO_DTR-ind primitives as defined for procedure A. However, any data transferred during the "open-pending" state shall be assumed to be lost if the connection set-up fails.

If a connection set-up fails, an automatic MAC layer re-attempt may be indicated by the arrival of a MAC_RES_DLC-ind primitive. In this event all early data that has been submitted to the connection should be resubmitted as part of the new set-up attempt.

In all cases (procedure A and procedure B), the DLC shall respond to all MAC_CO_DTR-ind primitives with a MAC_CO_DATA-req primitive indicating the number of bearers that shall be used for C_S and C_F data transfer in the next TDMA frame. This response is required even if the DLC has no data scheduled for transmission. Three conditions are noted:

- 1) the MAC indicates that no capacity is available due to an earlier transmission failure. In this case the DLC response is required to indicate the bandwidth that shall be used for retransmission of the failed data;
- 2) the MAC indicates that some capacity is available, and the DLC has some data to send. In this case the DLC response indicates the bandwidth to be used for new transmission. The DLC may supply a number of C_F or C_S data fragments equal to or less than the indicated capacity. If the DLC supplies fewer fragments than the available capacity, the MAC will nonetheless reserve all of the indicated bandwidth and will automatically generate "fill" messages to occupy any unused bandwidth;
- 3) the MAC indicates that some capacity is available, but the DLC has no data to send. In this case the DLC may indicate zero bandwidth, in which case the MAC is expected to use the bandwidth for U-plane data (thereby altering the U-plane bandwidth). Alternatively, the DLC may continue to reserve C-plane bandwidth by indicating a fixed bandwidth in each MAC_CO_DATA-req primitive, even though it also indicates that there are no data fragments available for transmission. This procedure shall be used to provide a dedicated C_F bearer (or bearers) and/or to maintain a constant U-plane bandwidth.

Refer also to clause 8.4.3 in ETSI EN 300 175-3 [3].

9.5.1.3 U-plane service data

The DLC is responsible for delivering U-plane data to the MAC layer MC-SAP in response to MAC layer requests.

The exact procedure is dependent on the frame type, and is defined in clause 12 for each permissible frame type.

U-plane service data may be supplied to a single MAC connection from more than one U-plane entities, provided that all the frame types are compatible with the given MAC service.

9.5.2 MB-SAP

9.5.2.0 General

All connectionless services, C-plane and U-plane shall interface with the MAC via the MB-SAP. The MB-SAP shall not be used to manage the underlying MAC connectionless services and shall be independent of the possible state of the underlying service.

9.5.2.1 C-plane service data procedures

Procedure A1: downlink data transfer: C-plane service data shall be duplicated (if necessary) and shall be submitted to the CL_S and/or CL_F logical channel, using MAC_DOWN_CON-req primitives (one per frame). For CL_F services the DLC may submit at most the maximum number of CL_F segments that can be transmitted on one CL bearer in one frame. In addition the DLC may deliver one segment of CL_S data every second frame.

NOTE 1: This mechanism provides no flow control. The number of DLC frame fragments is indicated in each MAC_DOWN_CON primitive using the "number of segments" parameter.

NOTE 2: The method of providing TDMA frame synchronization between MAC and DLC is not specified.

Procedure A2: uplink data transfer: C-plane service data shall be submitted to the CL_S and/or CL_F logical channel of the MB-SAP, indicated in the MAC_UP_CON primitive using the "SDU length".

NOTE 3: This mechanism provides no flow control. The number of DLC frame fragments is indicated in the MAC_UP_CON primitive using the "SDU length".

9.5.2.2 U-plane service data

Connectionless service data may be supplied by any LU service defined in clause 11 as appropriate. For the fragmentation any suitable FUa fragmentation frame structure may be used, see clause 12.

NOTE 1: As the connectionless services do not provide any retransmission schemes, whenever it is possible sequencing should be provided to allow for some limited error detection at the receiving side.

Dependent on the downlink service the DLC may deliver SI_N or SI_P data with a MAC_DOWN_CON-req primitive. During SI_N services the DLC shall submit one segment of SI_N channel data per frame. During SI_P services the DLC shall submit the maximum number of SI_P segments that can be transmitted on one CL bearer in one frame.

NOTE 2: This mechanism provides no flow control. The number of DLC frame fragments is indicated in each MAC_DOWN_CON primitive using the "number of segments" parameter.

NOTE 3: The method of providing TDMA frame synchronization between MAC and DLC is not specified.

At the receiving side, all connectionless data per frame together with the CRC results will be received by the DLC in a MAC_DOWN_CON-ind primitive. If the B-field received was with data type set to "unknown" the DLC shall assume that the A-field was received with errors.

9.5.3 MA-SAP

9.5.3.1 Overview

All C-plane broadcast services shall interface with the MAC via the MA-SAP. The MA-SAP shall not be used to manage the underlying MAC broadcast service.

Every instance of Lb (irrespective of the PP addressed) is associated to one or more MA SAPs. Each Lb frame is then transmitted to the MAC layer using the procedure (and associated primitives) described in clause 9.4.

9.5.3.2 Service data procedures

Service data transfer via the MA-SAP shall be independent of the possible state of the underlying service.

Procedure A: normal data transfer: C-plane service data shall be duplicated (if necessary) and shall be submitted to the B_S logical channel of all indicated MA-SAPs, using MAC_PAGE-req primitives.

NOTE: There is no flow control mechanism. Excess MAC_PAGE-req primitives may be discarded by the MAC layer.

10 Management procedures

10.1 Lower Layer Management Entity (LLME)

The LLME shall contain the following groups of procedures that are relevant to the operation of the DLC layer:

MAC connection management: set-up, release and modification of MAC connections. Choice of C_S or C_F logical channel for data transfer.

DLC C-plane management: installing and controlling the DLC C-plane resources.

DLC U-plane management: installing and controlling the DLC U-plane resources (LUx) in response to service demands from the higher layer LLME.

Connection handover management: co-ordination of connection handover functions between the C-plane and the U-plane.

Broadband data link management: set-up, release, modification and association of multiple MAC connections to one broadband data link.

Negotiation of acceptable U-plane services shall be performed by the NWK layer during the call control call establishment phase, and the agreed service demands shall be delivered directly to the DLC layer via the LLME management entity. The LLME shall then install the required service using a combination of MAC connection management (the set-up of a new connection, and/or modification of an old connection), Broadband data link management (the set-up of new connections, association with the data link and/or modification of an old connection) plus DLC U-plane management (the instancing of an LUX entity) followed by an association between the U-plane link and the MAC connection(s).

10.2 MAC connection management

10.2.0 General

All the MAC connections shall be managed and co-ordinated within the LLME. This clause shall only describe co-ordination of the MAC connections to a single PP. Any broader co-ordination (such as may be required in complex FPs) is not described.

10.2.1 MAC connection set-up

MAC connection set-up shall be invoked by the LLME in response to service demands using the MAC_CON-req primitive. This primitive shall specify the following parameters:

- an MCEI for the new connection;
- the Connection HandOver (CHO) flag, (if the connection is required for connection handover);
- the MCEI of the old connection (only when requesting connection handover);
- the basic connection flag, (indicating if a basic connection is acceptable);
- a list of the required connection attributes (service type, slot type, etc.).

NOTE 1: The service type for advanced (non-basic) connections, may specify "U-plane unknown". In this case the attributes follow in a subsequent MAC_MOD-req primitive (see clause 10.2.3).

If the request is successful the MAC shall respond with a MAC_CON-cfm primitive to the initiating side and a MAC_CON-ind primitive to the destination side. These replies shall confirm the actual (achieved) connection attributes, and shall indicate whether a "basic" or "advanced" connection has been established. The MAC_CON-ind primitive shall also indicate connection handover (when appropriate) by using the CHO flag. For "advanced" connections, this primitive shall contain an exchanged connection number which shall define a logical connection number for the connection (see clause 10.2.4). These parameters shall be reported to the respective LLMEs at both sides.

If a connection establishment attempt fails, the MAC layer may initiate an automatic re-attempt, and shall indicate this re-attempt with a MAC_RES_DLC-ind primitive. Upon receipt of this primitive the LLME shall cause all associated DLC entities to resubmit all overlapped set-up data as described in clause 9.5.1.2.

If the connection establishment fails, the MAC shall respond with a MAC_DIS-ind primitive. This event shall be reported to the LLME, and the LLME shall invoke any appropriate recovery action. Such recovery is not specified in the present document.

NOTE 2: Suitable LLME actions include a reattempt of connection set-up, a release of the link, or a re-routing of the link to an established connection.

10.2.2 MAC connection release

MAC connections shall be released by the LLME if the NWK layer indicates that the connection is no longer required. The LLME shall first remove all link associations (such that no further data transfer is allowed). MAC connection release shall then be invoked using the MAC_DIS-req primitive. The release request shall be unacknowledged.

10.2.3 MAC connection modification

MAC connection modification is invoked using the MAC_MOD-req primitive. This primitive shall specify the following parameters:

- the MCEI for the connection;
- a list of the required connection attributes (service type, numbers of bearers, etc.).

MAC connection modification may be used in two ways:

- Case A: To define the connection attributes of an advanced connection of service type "unknown".
- Case B: To modify the type of the connection from basic to advanced or to modify the connection attributes of an advanced connection of known service type (service type, number of bearers, modulation type).

Case A shall be used during the establishment of advanced connections, whenever the MAC_CON-req primitive has specified a multi-bearer connection or the connection type as "unknown". The MAC_MOD-req primitive may be sent immediately after the MAC_CON-req on request from the LLME, but may also be delayed until a DL-SERVICE_MOD-req primitive is received from the NWK layer in order to allow some higher layer exchanges to occur using a C_S/C_F only MAC service. These higher layer exchanges may be used to agree the wanted service, which shall then be invoked at the MAC layer using the MAC_MOD primitives. Case A may also be used during connection handover.

Case B shall be used after the establishment of the connection. This case may be used by the LLME to optimize the use of the resources by changing the bandwidth (including the complete reversal of unidirectional connections, MAC suspend and MAC resume procedures). In addition it may be used in response to a NWK layer request for changing the connection attributes (i.e. slot type, service type, modulation scheme). Case B service modifications shall observe the following restriction:

- C_S and C_F service data integrity shall always be preserved during connection modification, but changes to connection bandwidth, modulation scheme, service type and slot type may result in data sequencing errors and/or erasures for the I_N or I_P logical channels.

If the "minimum bearers" parameter is changed to a value greater than the actual bandwidth, the connection will be released if the MAC cannot achieve the new requirement.

10.2.4 MAC connection identifiers

10.2.4.1 Overview

Each independently invoked MAC connection shall be uniquely identified by a MAC connection identifier (MCI). Two types of MCI are defined, corresponding to the two types of MAC connection:

- Advanced MAC Connection Identifier (AMCI) for advanced MAC connections.
- Basic MAC Connection Identifier (BMCI) for basic MAC connections.

All references to MCI shall be understood to refer to AMCI or BMCI as appropriate.

The MCI is defined to be constant for the life of the connection. In particular, it is not altered by the connection handover procedure.

During connection handover two separate connections may exist simultaneously that have the same MCI. All procedures that refer to the MCI shall be understood to refer to both connections.

NOTE: During connection handover advanced connections can be distinguished by their different advanced MAC Connection Identifiers (MCI). Basic connections cannot be distinguished.

10.2.4.2 Advanced MAC Connection Identifiers (AMCI)

Every "advanced" MAC connection to every portable radio termination is identified by an advanced MAC connection identifier:

$$\text{AMCI} = \text{ARI} + \text{PMID} + \text{LCN}$$

Where:

LCN is the constant portion of the Exchanged Connection Number (ECN) as defined below.

ECN = Exchanged Connection Number:

The ECN shall be chosen by the initiating LLME at connection set-up. Some of the ECNs chosen for connections used by Broadband links may have been allocated beforehand via NWK layer lower resources negotiation during call setup. This exchanged (common) identifier does not exist for basic connections. The ECN shall contain two fields:

Bit	-	msb	-	lsb
	HOV	LCN		

Where:

msb: most significant bit (highest numbered bit position);

lsb: least significant bit (lowest numbered bit position).

NOTE: These bits are mapped into MAC messages according to the rules in ETSI EN 300 175-3 [3].

Figure 10.2.4.2.1: ECN format

LCN = Logical Connection Number:

The LCN shall be preserved for the life of the "advanced" connection. This value shall be constant during connection handover and should be used to route all U-plane links.

HOV = HandOver flag:

The HOV bit shall be variable, and shall have a different value for the two simultaneous connections that may exist during connection handover.

10.2.4.3 Basic MAC Connection Identifiers (BMCI)

Only one "basic" connection shall exist between a given PT and a given FT. This "basic" connection is identified by the basic MAC connection identifier.

$$\text{BMCI} = \text{ARI} + \text{PMID}$$

Portable Part Identifier (PMID): the PMID is an identifier that uniquely identifies any active portable part within the domain of one FT.

NOTE: The PMID is only required at the FT to distinguish between MAC connections to different PPs. PMID, as defined in ETSI EN 300 175-6 [6] is proposed as a suitable identifier. Individual implementations have the freedom to use any alternative identifier that provides an equivalent function.

10.2.4.4 MAC Connection Endpoint Identifier (MCEI)

Within each PT and each FT a connection is referenced using a local (layer-to-layer) identity - the MAC Connection Endpoint Identifier (MCEI). The assignment and management of these identifiers is a local matter.

10.2.5 Selection of logical channel (C_S or C_F)

The LLME selects the logical channel for Lc operation on a frame-by-frame basis, based on the following management information:

- PT and FT capability (see note 1);
- overall call state(s);

- C-plane message queues (see note 2).

NOTE 1: C_S only operation is allowed. This capability may be notified by FT broadcasts, and may be negotiated by the NWK layer during call establishment.

NOTE 2: If C_F channel capability is available, the LLME has the option to use the C_F channel at any time, either on an existing connection (by accepting an interruption to the associated U-plane service) or by creating a new MAC connection.

NOTE 3: These rules also apply to any re-routing caused by connection handover.

Logical channel selection shall operate independently in each direction. The detailed procedure for logical channel selection is not specified as part of the present document. The selection procedure should be defined by the implementer subject to the following rules:

- 1) the capabilities of the peer shall be observed;
- 2) the C_S channel should be used whenever possible;
- 3) there shall be no more than 1 unacknowledged I-frame when the logical channel is switched;
- 4) the channel shall only be switched at a frame boundary;
- 5) a single link (single LAPC instance) shall not use more than 1 logical channel at the same time (except during connection handover).

Rules 4) and 5) shall be understood to mean that the logical channel may only be switched when there are no outstanding (non-transmitted) fragments (see transmission notes in clauses 9.2.3.2 and 9.2.5). This ensures that the order of arrival of complete LAPC frames at the peer LAPC entity shall always be the same as the order of transmission.

10.3 DLC C-plane (LAPC) management

10.3.0 General

All the DLC data links are managed and co-ordinated within the LLME. This clause only considers co-ordination of the data links to a single PP. Any broader co-ordination (such as may be required in complex FPs) is not described.

10.3.1 Provision of link signature

The link signature is derived from the MAC layer PT identity as follows:

- a) if the PT has an assigned PMID for the relevant FT and the link is associated to a connection oriented MAC service:

$$\text{LSIG} = \text{lower 16 bits of PMID}$$

- b) if the PT does not have an assigned PMID or the link is associated to a connectionless MAC service:

$$\text{LSIG} = 0000 \text{ Hex}$$

LSIG shall be supplied by the LLME for all connection oriented services at link establishment, and shall not change even if the assignment state of PMID changes during the lifetime of the link.

An established link may be (re-)associated to any open MAC connection, but the value of LSIG shall not change as a result of a new association.

NOTE: Although a default PMID is available for connection oriented services (when an assigned PMID is not available) the default case has been defined to allow a simpler implementation for systems that do not use assigned identities.

10.3.2 Routing of connection oriented links

Each connection oriented C-plane link may be routed to any suitable MAC connection, subject to the following rules:

- 1) the link shall be in the "open" or "open-pending" state;
- 2) MAC connection resources should be used in the following order of priority:
 - a) resources that are permanently reserved for C-plane operation (see clause 9.5.1.2);
 - b) the same connection as the associated U-plane service;
 - c) any other existing resource.

10.3.3 Routing of connectionless links

A connectionless C-plane link shall be routed to one or more connectionless MAC services, via the MB-SAPs, using the data transfer procedures described in clause 9.5.2.

10.4 DLC U-plane (LUX) management

10.4.0 General

The DLC U-plane service instances shall be established, initialized and released by the LLME in response to service demands from the NWK layer LLME. Existing U-plane entities may also be suspended and resumed by the LLME.

10.4.1 U-plane establishment

The U-plane service description shall be passed to the U-plane management procedures by the NWK layer management at link establishment. The LLME shall map this description into a specific DLC entity and shall associate the DLC entity to a suitable open MAC connection.

If a suitable MAC connection is already available this may be used. Alternatively, a new connection shall be opened or an existing connection shall be modified to provide the required MAC service type, using the procedures in clause 10.2. Following a successful association, the relevant connection identity (BMCI or AMCI) shall be reported to the LLME.

NOTE 1: The connection identity should be communicated to the peer entity by the NWK layer using the procedures defined in ETSI EN 300 175-5 [5].

The achieved grade of service from the MAC layer may be different from that requested. In particular, the offered bandwidth may be less than the target bandwidth requested.

If the offered service achieves the minimum requested service, the DLC shall accept the service. In the event that this minimum service is not equal to the target service, the DLC may either leave the original target unchanged or may alter the target. Whenever the target is higher than the actual, the MAC layer may attempt to upgrade the service to the target value at any time without warning.

NOTE 2: The minimum service may also be changed. If the minimum is changed to a value higher than the value achieved, the MAC may release the connection.

If the offered service does not achieve the minimum requested service, the DLC shall reject the service, shall immediately release the connection, and shall report this release to the LLME.

In the case of broadband data link the DLC entity is associated with one logical MAC connection which may comprise multiple open MAC connections. In the time of the DLC entity establishment there may be only one physical MAC connection established. If the U-plane service description and transmission rate needs require additional connections to be opened these shall be done. The rules in regard to MAC service offers described in this clause in the case of single connection links apply also for the case of a multiple connections broadband data link.

10.4.2 U-plane release

U-plane links shall be released by the LLME if the NWK layer indicates that the service is no longer required. The LLME shall first remove all associations to MAC connections (such that no further data transfer is allowed). The release shall be unacknowledged.

10.4.3 U-plane suspend and resume

When a U-plane link is temporarily not required it may be suspended by the LLME in response to a suspend demand from the NWK layer LLME. The LLME shall first remove all link associations (such that no further data transfer is allowed). All DLC resources shall be preserved, but any lower layer resources (MAC connections) shall be immediately disassociated.

NOTE: The disassociated MAC connections may be released or may be re-associated to another U-plane service.

A suspended link may be resumed by the LLME at any time in response to a resume demand from the NWK layer LLME procedures. U-plane resumption shall use the procedures described in clause 10.4.1.

10.5 Connection handover management

The invocation of an involuntary connection handover, and the decision to perform a voluntary connection handover shall always be taken by the PT. The management procedure for connection handover is not specified as part of the present document, and shall be defined by the implementer subject to the following rules:

- 1) if bearer handover is also provided, any control timers shall be arranged such that single bearer failures shall result in at least one bearer handover attempt, when bearer handover is possible;
- 2) a basic connection shall only be handed over to a (new) basic connection, and an advanced connection shall only be handed over to a (new) advanced connection;
- 3) a connection modification may be combined with a connection handover. This shall allow the service type of the new connection to differ from the service type of the old connection within the limits defined for connection modification;
- 4) following a successful connection handover attempt, a subsequent voluntary connection handover shall not be attempted for that same connection within the following <DL.06> seconds;
- 5) following a failed connection handover attempt, a second attempt may be made immediately. This process may be repeated for the same connection for up to N251 attempts. Thereafter, there shall be no more attempts for this connection within the following <DL.06> seconds;
- 6) during connection handover any retransmissions of C-plane frames (LAPC) shall only be handled using the standard retransmission protocols according to the chosen class of operation;
- 7) during connection handover additional retransmissions of U-plane frames may be scheduled, subject to complying with all the retransmission rules of the chosen class of operation;

NOTE: See clause 9.2.7.3 for details of the peer-to-peer procedures.

- 8) the rules given in clause 10.2.5 shall also apply: C-plane transmission on the new connection shall start at a frame boundary.

In the case of logical connections, each physical connection associated with the logical connection and the broadband data link shall be treated separately.

10.6 Ciphering management

10.6.1 Ciphering management in cases where the NWK layer executes the ciphering related MM procedure

10.6.1.0 General

The NWK layer ciphering related procedure assumes the presence of a DLC C-plane connection.

10.6.1.1 Providing a key to the MAC layer

Upon receipt of a DL_ENC_KEY-req primitive from the NWK layer the DLC shall request the LLME for the relevant connection identities. The LLME shall respond by commanding the DLC layer to issue a MAC_ENC_KEY-req primitive to all relevant connections (all applicable values of MCEI). The LLME shall also store the MCI(s) and the encryption key to be available for a possible later connection handover or new connections associated with the same broadband data link. Any earlier stored cipher key for the same MCI shall be overwritten.

NOTE: The MCI(s) are derived from the connection identities listed in the DL_ENC_KEY primitive.

In the case of broadband data links, the provision of the MCI of the first established connection (i.e. the MCI used for the DLI) shall be understood as that MAC_ENC_KEY-req primitive shall be issued to all connections associated with that broadband data link.

10.6.1.2 Starting and stopping the ciphering

Upon receipt of a DL_ENCRYPT-req primitive from the NWK layer the DLC shall request the LLME for the relevant connection identities. The LLME shall respond by commanding the DLC layer to issue a MAC_ENC_EKS-req primitive to all relevant MAC connections indicating "Crypted" or "Clear" as appropriate. The LLME shall also store the MCI(s) and the "Encrypt"/"Clear" status to be available for a possible later connection handover or new connections associated with the same broadband data link. Any earlier stored status for the same MCI shall be overwritten.

NOTE 1: The MCI(s) are derived from the connection identities listed in the DL_ENCRYPT primitive.

In the case of broadband data links, the provision of the MCI of the first established connection (i.e. the MCI used for the DLI) shall be understood as that MAC_ENC_EKS-req primitive shall be issued to all connections associated with that broadband data link.

All MAC_ENC_EKS primitives received from the MAC layer shall be reported to the LLME. Upon receipt of a MAC_ENC_EKS-ind (or MAC_ENC_EKS-cfm) primitive from all relevant connections the LLME shall command the DLC layer to issue a DL_ENCRYPT-ind (or DL_ENCRYPT-cfm) primitive to the NWK layer indicating the achieved status as "Encrypted" or "Clear" as appropriate. The LLME shall then store this actual "Encrypted"/"Clear" status to be available for a possible later connection handover. Any earlier stored status for the same MCI shall be overwritten.

In the case of broadband data links, the DLC shall report to NWK layer the achieved status of all established at the moment connections associated with the broadband data link. For connections established after this no report shall be issued.

NOTE 2: All connections associated with one broadband data link are assumed to have the same mode status as described in ETSI EN 300 175-3 [3].

10.6.1.3 Connection handover

During a connection handover the new connection shall always be established in clear (encryption disabled). If the status of the old connection was "crypted" then the LLME at the PT side shall command the DLC layer to enable ciphering on the new connection as soon as it is established by issuing a MAC_ENC_KEY-req primitive to the MAC layer (to provide the cipher key) followed by a MAC_ENC_EKS-req primitive with the flag set to "Go crypted".

Notification of successful encryption of the new connection shall be indicated by receipt of a MAC_ENC_EKS-cfm at the initiating side and a MAC_ENC_EKS-ind at the peer side. In this event no indication shall be issued to the NWK layer.

10.6.2 Cipherring management in cases where the NWK layer does not execute the cipherring related MM procedure

If the DLC detects a MAC_CON-ind or MAC-CON-cfm primitive indicating that a new MAC connection has been established, it shall request to the LLME whether encryption is required. If the answer is positive, the LLME provides the encryption key to the DLC. Thereafter the DLC acts as follows:

- it issues a MAC_ENC_KEY-req primitive. In the PT, this primitive is followed by a MAC_ENC-EKS req primitive;
- the DLC shall not send any data before a MAC_ENC_EKS-cfm or MAC_ENC_EKS-ind has been received.

If the answer is negative, no encryption is started and data over the MAC connection will be transferred in clear mode.

10.7 Broadband data link management

Broadband data links shall be managed and co-ordinated within the LLME. This clause describes the co-ordination of the MAC connections associated with a single Broadband data link between one FT and one PT.

Broadband links may use up to three advanced MAC connections identified by their ECNs. For the management of each connection the rules specified in clause 10.2 shall apply with the additions/modifications specified in this clause.

NOTE: The use of only up to 3 advanced connections per a Broadband link is imposed in regard to the requirements for coexistence and capacity of DECT terminals in one and the same frequency band as specified in ETSI EN 300 175-3 [3] clause 11.6. The calculations are made on the assumption of 10 carriers used, which implies that if a wider band is in use the number of connections may be increased.

The physical connections used by a broadband data link shall be seen as a single logical connection.

The ECN for the first connection may be chosen random by the LLME, whereas the LBN for any additional connection associated with the same Broadband link shall be allocated during the NWK layer lower resources negotiation/allocation procedure at call setup time.

The assessment as how many connections will be needed for the provision of the desired service shall be based on the assessment of the agreed (again during NWK layer procedures) maximum number of UP- and DOWN-link simplex bearers. A maximum of 15 logical bearers can be associated with each connection. Each of these bearers may comprise a different number of simplex bearers depending on the bearer's type; each connection shall maintain one pilot bearer (see ETSI EN 300 175-3 [3] for details on bearer types).

After the LLME has established the required number of connections and their ECNs have been allocated by the NWK layer, the LLME shall request the connection setup of as many additional connections as needed.

The values chosen for the number of UP- and DOWN-link bearers required for each connection should respect the overall numbers agreed in the NWK layer for the particular broadband data link. The sum of the "min" UP- and DOWN-link bearers requested on all established connections shall equal the overall "min" number agreed at NWK layer. The sum of the "max" UP- and DOWN-link bearers requested on all established connections should equal the overall "max" number agreed at NWK layer. In any case, following the connections establishment, it is the MAC layer responsibility to dynamically manage suspension and resumption of these connections depending on agreed minimum bearers values and data transmission demands (see ETSI EN 300 175-3 [3] for details).

11 U-plane service characteristics

11.1 General

The U-plane of the DLC layer provides for a family of alternative U-plane services as listed in clause 4.4. These services are collectively named LUX, with the individual family members being named LU1, LU2, LU3, etc. Each of these separate services is completely independent, and they are all accessed through independent LU SAPs.

Each service shall route complete Protocol Data Units (PDUs) to the MAC layer, via one of the two lower frame buffering entities, FB_N or FB_P . These two buffer entities correspond to the MAC layer I_N unprotected services and I_P protected services respectively.

Several different LU_X family members (including multiple instances of each member) may exist in complex DLC implementations.

Every LU_X entity shall use a fixed length frame format, where the frame type (and the associated frame buffering entity) shall correspond to the MAC layer service used. Certain LU_X services provide two (or more) alternative classes of service and a different frame type (of the same fixed length) may be associated with these different classes of service.

The different frame types are defined in clause 12. The associated elements of procedure are described in clause 13, and the peer-to-peer procedures are described in clause 14.

11.2 LU1 TRansparent UnProtected service (TRUP)

The LU1 service is the simplest service. It is designed to meet the special demands of speech transmission, but may also be used for non-speech applications.

The higher TRUP functions are null, and under normal conditions data is passed from the higher layer LU1 SAP to the lower FB_N frame buffering function with no data alterations or additions.

LU1 shall use one of the following classes of transmission.

Table 11.2.1: Transmission classes for LU1 operation

Transmission class	PDU Structure
class 0/min_delay	FU1 frame
class 0	FU1 frame

Speech transmission shall only use the class 0/min_delay operation over a single bearer MAC connection. This class of operation requires a special arrangement of the buffering as described in clause 12.2.3.

Data integrity is not guaranteed. No error protection is applied, and octets may be lost, erroneous or duplicated.

NOTE 1: There are several possible sources of errors, including radio channel errors, handover errors and clock slips (e.g. small differences in clock speeds).

The (lower) frame buffering functions are provided by FB_N ; this shall provide synchronized fragmentation of the continuous higher layer data into I_N logical channel fragments for delivery to the I_N channel in the transmit direction, and recombination of the I_N fragments into a continuous higher layer data flow in the receive direction.

The overall LU1 is a Synchronized Continuous Bitstream Oriented (SCBO) service, where octet synchronization is maintained from the lower MC SAP to the upper LU1 SAP.

NOTE 2: Octet synchronization provides 4 kHz integrity when a full slot MAC bearer is used. The IWU may interpolate 8 kHz integrity by dividing each octet in half.

LU1 is used for the following applications:

- speech;
- unprotected transparent data.

In the case of the 16-level or 64-level modulation option (see ETSI EN 300 175-2 [2]) the LU1 service may be used.

11.3 LU2 Frame RELay service (FREL)

11.3.1 General

The LU2 service is a frame relay service that is accessed through the LU2 SAP.

NOTE 1: Frame Relay service offered by LU2 is similar to the one defined in Recommendation ITU-T I.122 [i.3].

The LU2 shall operate on a generic field of user data that shall be transferred into and out of the DLC U-plane as a single SDU. This SDU is assumed to contain one external frame, but the operation of LU2 shall be independent of the actual contents of the SDU.

LU2 shall not provide the following frame relay functions:

- flag recognition, deletion and recreation;
- zero-insertion recognition, deletion and recreation;
- FCS checking, deletion and recreation;
- address translation;
- recognition and discarding of invalid frames.

If required, these functions are assumed to be provided by the user of LU2 entity.

LU2 shall provide mechanisms that offer reliable transport of the generic SDUs, and that preserve the SDU boundaries. The LU2 service shall preserve the order of SDUs, transmitted at one LU2 SAP, when they are delivered at the other end.

NOTE 2: The SAP means the entry to the LU2 entity even at the internal of DLC, refer to clause 11.1 of the present document.

Three main procedures shall be provided:

- 1) the addition of a checksum to each SDU;
- 2) segmentation of the resulting SDU+checksum data field;
- 3) peer-to-peer transmission of these segments using (small) internal frames.

To avoid possible confusion between external and internal frames the following words are used in this clause from here onwards:

- "SDU" shall refer to the user data;
- "Checksum" shall refer to the added checksum data;
- "PDU" shall refer to the internal frames;
- "Segment" shall refer to the information content of one "PDU".

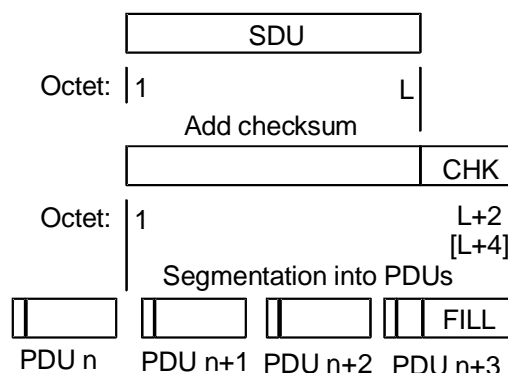

Figure 11.3.1.1: LU2 SDU procedures

11.3.2 Checksum operation

The checksum shall provide an error detection capability for the reassembled segments (at the peer side) but there shall be no mechanism for the retransmission of a SDU that is found to be in error.

NOTE: The user should provide an external retransmission protocol, to protect against these infrequent erasures.

Two alternative checksum are defined: a 16-bit checksum and a 32-bit checksum.

The 16-bit checksum used shall be identical to that used in the C-plane (see clauses 7.9 and 7.10) where the checksum shall be calculated over the complete SDU + checksum data field.

The 32-bit checksum is for further study.

11.3.3 Segmentation and transmission class

The SDU + checksum shall be segmented into fixed length segments, where the segment length shall depend on the PDU structure chosen. The alternative PDUs structures shall correspond to one of the internal frame types defined in clause 12, where the type depends on the chosen class of service. LU2 may use any one of the following combinations of transmission class and PDU structure.

Table 11.3.3.1: Transmission classes for LU2 operation

Transmission class	PDU Structure
class 0/bi-directional or uni-directional	FU5 frame
class 0/bi-directional	FU4 frame (see note 1)
class 0/uni-directional	FU6 frame (see note 2)
class 1/bi-directional or uni-directional	FU5 frame
class 1/bi-directional	FU4 frame (see note 1)
class 1/uni-directional	FU6 frame (see note 2)
class 2/bi-directional or uni-directional	FU5 frame
class 2/bi-directional	FU4 frame (see note 1)
class 2/uni-directional	FU6 frame (see note 2)
NOTE 1: Frame type FU5 should be used in all cases. Frame type FU4 may be used for bidirectional links if only one channel and one link is required.	
NOTE 2: Frame type FU5 should be used in all cases. Frame type FU6 may be used for unidirectional links if only one channel and one link is required.	

NOTE: Each instance of LU2 only uses a single class of service and a single frame type for all data transmissions, and this is defined at service establishment.

In all cases the original SDU boundaries shall be preserved (i.e. service data integrity shall be maintained) by use of a length indicator and More flag within each PDU, as defined in clause 13.3.

11.3.4 Data transmission

11.3.4.1 Send side procedure

At the transmitting side a complete SDU shall be received in a DL_U_DATA-req primitive. The SDU shall be passed to the checksum function, where the checksum shall be calculated and appended to the end of the SDU.

The resulting SDU+checksum shall be passed to the segmenting function and segmented into an integral number of segments. The last segment shall be filled with fill octets if necessary. The information content of each PDU shall be marked using the length indicator as described in clause 13.3, and sequence numbers shall be added using the rules defined in clauses 14.2 and 14.3.

The resulting PDUs shall be transmitted in ascending order of sequence number (i.e. the lowest numbered segment shall be transmitted first), using the procedures defined in clause 14.3 for the agreed class of operation.

Several PDUs may be submitted once to the MAC layer in a single MAC_CO_DATA-req primitive in response to each MAC_CO_DTR-ind primitive. The number of PDUs shall be less than or equal to the maximum number requested in the MAC_CO_DTR-ind primitive.

11.3.4.2 Receive side procedure

Several PDUs may be received from the MAC layer in a single MAC_CO_DATA-ind primitive.

The receive side shall re-order the PDUs using the send sequence numbers as defined in clauses 14.2 and 14.3 according to the agreed class of operation. The receive side shall then search for SDU boundaries using the More data bit as defined in clause 13.3.

A complete SDU shall be assumed to exist, and shall be passed to the checksum function when the following conditions are satisfied:

- 1) two successive boundaries have been identified using the More data bit (i.e. there are no intermediate boundaries);
- 2) PDUs have been successfully received for all of the sequence numbers that lie between those boundaries.

At the receiving side the checksum shall be tested on each reassembled SDU+checksum. If the checksum passes, the data shall be passed to the IWU using a DL_U_DATA-ind primitive. If the checksum fails, the data shall be discarded, and the IWU shall be notified using a DL_U_ERROR-ind primitive.

11.4 LU3 Frame SWItching service (FSWI)

The LU3 service is a frame switching service that is accessed through the LU3 SAP. The higher functions are dependent on the frame type, in order to provide a detailed interaction. LU3 shall provide an internal peer-to-peer protocol called Link Access Protocol User (LAPU) which shall provide for acknowledged exchange of user data and control.

LAPU shall provide the following functions:

- management of P(S), frames sent;
- buffering of I-frames awaiting ACK;
- management of P(R), frames received;
- check received N(S) against V(R);
- acknowledge received I-frames;
- management of the V(S), V(R) state variable(s);
- detect out of sequence packets;
- generate and act upon REJ-frames;

- generate and act upon RNR- and RR-frames;
- multiplex logical channels.

The higher LAPU entity shall use the services provided by an independent instance of the LU2 entity to manage its own (LAPU) frames over the radio link.

NOTE: The LU3 service may operate on the same external (application) frame types as LU2. However, this time the external data link (layer 2) protocol is completely replaced with the LAPU protocol over the air. The translation between the external data link protocol and the LAPU protocol is assumed to be managed by the IWU. This has the advantage of requiring no modification to the external protocol timers.

LAPU shall be closely based on the LAPM procedures. These are the error control functions contained in Recommendation ITU-T V.42 [12].

The detailed specification of LU3 is defined in profile.

11.5 LU4 Forward Error Correction (FEC) service

LU4 may provide a FEC service comprising FEC coding/decoding, interleaving and possibly an ARQ process.

NOTE: It may be preferable to define this service so that application specific FEC can be added external to the DECT protocol. If a de-facto FEC standard then emerges, this could be added to the DECT standard.

The following standard FEC is suggested:

- use the I_N logical channel, giving 40 octet PDUs;
- use a fixed bandwidth MAC connection so that segment sequence is preserved;
- use bit-wise interleave over 1, 2, 4 or 8 TDMA frames;
- use a BCH(64,48) code, giving 30 octets of service data for each PDU;
- an optional higher frame structure of $N \times 30$ octets can then provide ARQ if required.

The LU4 service is for further study.

11.6 LU5 Basic RATE adaption service (BRAT)

11.6.1 Overview

The BRAT service provides for the transparent transport of synchronous continuous data at the following basic rates:

- 64 kbit/s;
- 32 kbit/s;
- 16 kbit/s;
- 8 kbit/s.

NOTE 1: These rates allow for transparent interworking of all ISDN "B" and "D" channels. "Transparent" means that the BRAT service does not perform any flag removal or any interpretation of the data.

Two alternative classes of operation shall be defined for the BRAT service:

- Class P: protected service;
- Class N: unprotected service.

NOTE 2: These classes of service correspond to operation over either a protected MAC service (I_P service) or an unprotected MAC service (I_N service) respectively. The basic functions are similar, but the detailed operation of these two classes is different to reflect the different bandwidths of the MAC services.

The protected service should be used to provide a more reliable rate adaptation service. The protected service shall always provide notification of any errors at the receiving side. It may also offer some correction of radio path errors, although the requirement for constant (continuous) data throughput means that errors cannot always be corrected.

The unprotected service offers no error correction, and no notification of errors. This is provided as a simpler service for applications where a higher level of bit errors can be accepted.

NOTE 3: In all cases the actual error rates will depend on the radio path at the time of use. When operating with short radio paths, the unprotected service can give acceptable performance for data transmission. However, in all cases (even when using the protected class of operation) an additional higher level error protection should be used as part of any critical applications.

The maximum number of channels that can be transported by each instance of LU5 shall depend on the maximum rates selected for each channel as defined in clause 11.6.2.3 (protected operation) or clause 11.6.3.3 (unprotected operation). Multiple independent instances of LU5 may be used to provide a complete service (a complete call) to the InterWorking Unit (IWU).

Each instance of LU5 shall be distinguished by a use of a different U-plane link number (ULN) or Logical Connection Number (LCN).

NOTE 4: Each instance of LU5 can only transport one full rate (64 kbit/s) channel. Transport of several full rate (64 kbit/s) channels therefore requires the use of multiple instances of LU5.

A maximum rate shall be defined for each channel at link establishment. This rate may only be changed by re-establishing the link using the (in-call) service change procedures defined in ETSI EN 300 175-5 [5].

These maximum rates shall be agreed using the normal CC set-up procedures, based on the parameters defined in the dedicated <<rate-parameters>> information element. Refer to ETSI EN 300 175-5 [5].

11.6.2 Protected service operation

11.6.2.1 General

In protected mode, each instance of LU5 shall provide mechanisms for reliable transport of 1, 2 or 3 independent channels, with each channel providing a Synchronous Continuous Bitstream Oriented (SCBO) service. Only a restricted set of channel rate combinations is provided, corresponding to efficient multiplexing arrangements.

NOTE 1: Other combinations of channel rates may be provided by use of multiple instances of LU5.

The multiplex arrangement shall be defined at service establishment using the mapping table defined in annex D. The multiplex arrangement for each multi-channel set is uniquely defined by the (maximum) data rates of the input channels. During normal operation, each input channel may subsequently operate at any actual rate that is less than or equal to this defined maximum. All of the data from one Multi-Channel Set (MCS) (i.e. one set of multiplexed channels) shall be transmitted over a single MAC connection.

Multiplexing is used to increase the efficiency of the air interface. Channel multiplexing shall be used whenever possible to combine lower rate channels into a single "Multi-Channel Set" (MCS).

Each MCS produces an output of one Multiplexed Data Unit (MDU) each TDMA frame, containing a multiplexed set of SDUs. These MDUs are then segmented into FU5 frames, and one control octet (plus any necessary filling data) is added to each frame.

NOTE 2: The control octet contains an independent channel control information for each input channel.

The resulting FU5 frames may optionally be multiplexed with frames from other MCS (other instances of LU5) before submission to a class 0 or class 3 transmission engine. Every frame contains the U-plane Link Number (ULN) of the appropriate MCS in order to provide direct routing of received frames at the receiving side.

The complete operation of the protected LU5 service shall be as described in the following clauses:

- data buffering and optional (upward) rate adaption, operating on each channel individually;
- multiplexing of data channels into Multi-Channel Sets (MCSs), with optional interleaving;
- segmentation of multi-channel sets into frames;
- frame sequencing and addition of control and filling octets;
- frame transmission, using class 0 or class 3 procedures.

11.6.2.2 Data buffering and initial rate adaptation

The defined rate for each input to a MCS only defines the maximum rate of the input channels. The actual input may be switched to a lower rate at any time. Whenever a lower rate input is used, it shall be individually rate adapted from the (actual) lower rate up to the (defined) maximum rate using bit repetition as described in the following clauses.

The raw data from each input channel shall be supplied to the LU5 as one service data unit each 1 TDMA frame. This shall produce service data units with the following sizes.

Table 11.6.2.2.1: SDU sizes

Channel rate	SDU size
8 kbit/s	10 octets
16 kbit/s	20 octets
32 kbit/s	40 octets
64 kbit/s	80 octets

The IWU or user application shall always provide SDUs that contain the correct number of octets.

If the SDU provided is less than the maximum rate reserved for that channel (i.e. less than the expected input to the MCS multiplexer) the SDU shall be repeated (replicated) 2, 4 or 8 times as appropriate to yield an Adapted Data Unit (ADU) of the correct size.

EXAMPLE: Adapting a raw input channel of 8 kbit/s to a MCS input rate of 32 kbit/s:

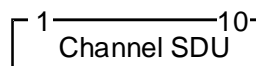

Figure 11.6.2.2.1: 8 kbit/s SDU

SDU shall be repeated 4 times:

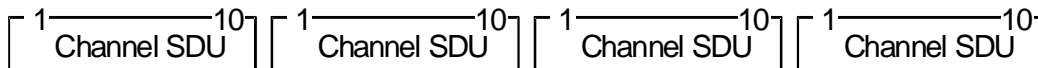

Figure 11.6.2.2.2: Repeated SDUs

Repetition shall be concatenated into one ADU:



Figure 11.6.2.2.3: Repeated SDUs concatenated into one ADU

Input channels may also be temporarily switched off by not supplying a SDU at the correct time. If no SDU is supplied, the channel shall be filled with by repeating the latest ADU. Each filling ADU shall be individually reported using the reserved parameter "00 kbit/s (channel off)" in the MCS control octet (see clause 11.6.2.5). The filling ADU should be discarded at the receive side, and no SDU should be issued at the appropriate time.

11.6.2.3 Multi-channel set multiplexing

Each protected Multi-Channel Set (MCS) shall define a fixed multiplex of 1, 2 or all 3 channels, depending on the maximum rates selected. This MCS multiplex shall define the maximum data rates for each channel: these maximum rates may only be changed by establishing a new MCS.

NOTE 1: The MCS size should be chosen to exactly match the maximum channel rates required. Use of a higher rate MCS will degrade performance when using class 3 transmission, due to the transmission of redundant information.

The following Multi-Channel Set (MCS) multiplex sizes are defined:

Table 11.6.2.3.1: MDU sizes

MCS Size	MDU size
Size P1	20 octets
Size P2	50 octets
Size P3	80 octets

MCS Size P1: this multiplex produces 1 output frame per TDMA frame. It shall support the following channel multiplexes:

Table 11.6.2.3.2: MCS Size P1; Maximum channel rates

MCS Ref	Channel 1 rate	Channel 2 rate	Channel 3 rate
P1/16	16 kbit/s	none	none
P1/08	8 kbit/s	8 kbit/s	none

MCS Size P2: this multiplex produces 2 output frames per TDMA frame. It shall support the following channel multiplexes:

Table 11.6.2.3.3: MCS Size P2; Maximum channel rates

MCS Ref	Channel 1 rate	Channel 2 rate	Channel 3 rate
P2/32	32 kbit/s	8 kbit/s	none
P2/16	16 kbit/s	16 kbit/s	8 kbit/s

MCS Size P3: this multiplex produces 3 output frames per TDMA frame. It shall support the following channel multiplexes:

Table 11.6.2.3.4: MCS Size P3; Maximum channel rates

MCS Ref	Channel 1 rate	Channel 2 rate	Channel 3 rate
P3/64	64 kbit/s	none	none
P3/32	32 kbit/s	32 kbit/s	none
P3/16	32 kbit/s	16 kbit/s	16 kbit/s

In all cases, the minimum connection bandwidth (in bearers) shall be equal to the number of output frames.

The minimum connection bandwidth shall be used when using class 0 transmission. Additional bandwidth should be provided when using class 3 transmission, to provide excess capacity for retransmissions.

Each protected MCS multiplex shall combine the adapted data units from all of the relevant input channels using either non-interleaved or interleaved packing to produce a Multiplexed Data Unit (MDU). Non-interleaved packing shall always be supported. This shall concatenate ADU in order of ascending channel number as shown in figure 11.6.2.3.1.

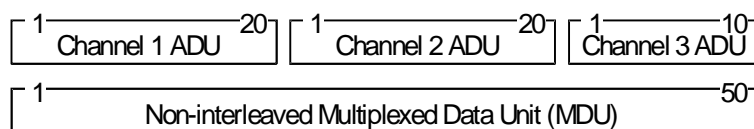

Figure 11.6.2.3.1: Example of non-interleaved packing (MCS Ref: P2/16)

Interleaved operation is optional. If provided, the interleaving shall operate with whole octets using a fixed interleave pattern with an interval of 10 octets. Channels shall be interleaved in order of ascending channel number.

NOTE 2: Interleaved operation may be used on all sizes of MCS.

For example, the order of octets in an interleaved MDU for the example given above, shall be as follows:

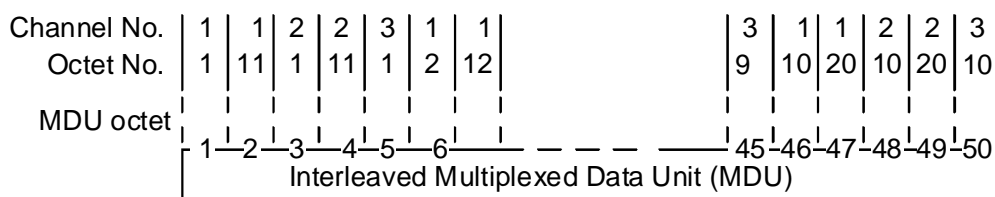

Figure 11.6.2.3.2: Example of interleaved packing (MCS Ref: P2/16)

11.6.2.4 Segmentation of Multiplexed Data Units (MDU)

Each multiplexed data unit shall be segmented into 27 octet segments that are suitable for insertion into FU5 frames. In all cases, the last segments shall be smaller than 27 octets, and further filling octets shall be added to this last segment to fill the last frame. One octet of each FU5 frame is reserved for additional LU5 control information.

Segmentation is a function of the size of the MCS.

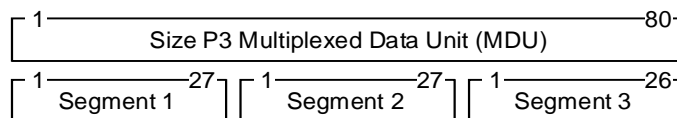

Figure 11.6.2.4.1: Segmentation of Size P3 MDU

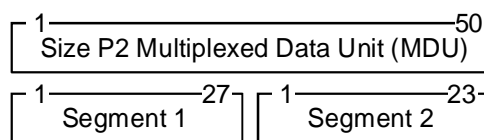

Figure 11.6.2.4.2: Segmentation of Size P2 MDU

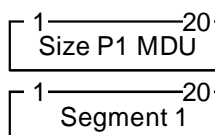

Figure 11.6.2.4.3: Segmentation of Size P1 MDU

11.6.2.5 Frame sequencing and addition of control and fill octets

The resulting segments shall be treated as independent U-plane channels by the framing engine, and each frame shall carry a U-plane channel number in the address field that shall correspond to the segment number.

Table 11.6.2.5.1: UCN allocation

Segment Number	U-plane channel No.			
	Bit	4	3	2
1		0	0	1
2		0	1	0
3		0	1	1

The U-plane link number shall be allocated using the standard CC procedures. If multiple instances of LU5 exist as part of one call these shall be allocated different U-plane Link Numbers (ULN).

The segments shall be submitted in order of ascending segment number (ascending UCN number) to the transmission engine. If multiple instances of LU5 (independent MCS outputs) are multiplexed into one transmission engine, the frames shall be delivered in order of ascending U-plane Link Number (ULN).

The transmission engine shall add the send sequence numbers to frames in their order of arrival. The send sequence numbers shall always be allocated sequentially, using the procedures given in clause 14.2.1.

Octet 5 of each frame shall then be reserved for the LU5 control octet (described below). This shall be used to indicate the instantaneous (actual) rate of all input channels. These rates may be changed for each new MDU, and the result shall be duplicated in octet 5 of all FU5 frames.

NOTE: The duplication of this control octet provides redundancy when operating with MCS size 2 or 3.

Bit	8	7	6	5	4	3	2	1	Octet
	0	Ch 1 rate			C2 rate		C3 rate		5

Figure 11.6.2.5.1: Control octet format

Table 11.6.2.5.2: Channel rate codings

Channel 1 rate coding			
7	6	5	Meaning
0	0	0	00 kbit/s (channel off)
0	0	1	8 kbit/s
0	1	0	16 kbit/s
0	1	1	32 kbit/s
1	0	0	64 kbit/s
Channel 2 rate coding			
	4	3	Meaning
	0	0	00 kbit/s (channel off)
	0	1	8 kbit/s
	1	0	16 kbit/s
	1	1	32 kbit/s
Channel 3 rate coding			
	2	1	Meaning
	0	0	00 kbit/s (channel off)
	0	1	8 kbit/s
	1	0	16 kbit/s
	1	1	32 kbit/s

Following the addition of the control octet in octet 5, the segmented MDU data shall be inserted in order of ascending octet number. Any remaining octets in each frame shall then be filled using the standard fill procedure (see clause 13.3).

11.6.2.6 Frame transmission

The resulting stream of frames shall be handled by a class 0 or class 3 transmission engine using the procedures defined in clause 14.3.2.

Class 3 transmission should only be used if the associated MAC connection provides excess capacity. In this case, transmission in each TDMA frame shall be scheduled by giving priority to recent frames for first transmissions and for retransmissions. This gives the following order of priority:

- 1) new frames, not yet transmitted;
- 2) retransmitted frames from last TDMA frame;
- 3) retransmitted frames from last-but-one TDMA frame, etc.

This means that the minimum connection bandwidth shall always be used for first transmissions. Excess bandwidth shall initially be used for immediate retransmissions.

If the control information indicates that a segment contains only fill data (i.e. because a higher bandwidth channel is operating at a lower rate or is idle), this relevant frame should not be scheduled for retransmission, even if a NACK is received for that frame.

NOTE: This procedure is recommended to avoid unnecessary retransmissions.

At the receiving side an immediate acknowledgement (ACK or NACK) shall be returned for all frames that are received with an error free sequence number.

The control octet from all U-plane channels of each link shall be combined to produce channel control information. If this information indicates that a segment contain only fill data (i.e. because a higher bandwidth channel is operating at a lower rate or is idle), then a false ACK shall be returned for the relevant frame(s).

Any uncorrected errors in the data that is delivered at the receive side shall be notified using DL_U_ERROR-ind primitives. Erroneous data should only be issued if it remains uncorrected at the last possible delivery time (see clause 14.3.5.2).

11.6.3 Unprotected service operation

11.6.3.1 General

Unprotected mode operation is similar to protected mode in many respects. The main differences are:

- 1) the use of FU1 type frames and the (corresponding) use of unprotected MAC service (I_N channel);
- 2) no support for variable channel rates.

Each instance of LU5 shall still provide the mechanisms for the transport of 1, 2 or 3 independent channels, where each channel shall provide a synchronous continuous bitstream oriented service. However, the allowable MCS arrangements are different to those uses for protected operation. This is done to re-optimize the efficiency of the multiplexing.

Each unprotected MCS also produces an output of one MDU each TDMA frame, containing a multiplexed set of SDUs. These unprotected MDUs are then segmented into FU1 frames, and no control or filling shall be added to these FU1 frames.

The resulting FU1 frames shall always be transmitted over an independent fixed bandwidth MAC connection using class 0 transmission. They shall not be multiplexed with frames from any other service instance (including other instances of LU5). Sequencing of the FU1 frames shall be provided automatically by the MAC layer as a result of using a fixed bandwidth MAC connection.

The complete operation of the unprotected LU5 service shall be described in the following clauses:

- data buffering and optional (upward) rate adaption, operating on each channel individually;
- multiplexing of data channels into unprotected multi-channel sets, with optional interleaving;

- segmentation of multi-channel sets into frames;
- frame transmission, using class 0.

11.6.3.2 Data buffering and initial rate adaption

A maximum rate shall be defined for each channel at link establishment. This rate may only be changed by re-establishing the link using the service change procedures defined in ETSI EN 300 175-5 [5].

The maximum rate only defines the input rate to the MCS and each channel may be individually rate adapted from a lower rate up to this maximum rate using bit repetition. This shall use the same adaption method (i.e. SDU repetition) as for the protected operation, as described in clause 11.6.2.2. However, any such adaption shall be fixed; in unprotected mode the input channel rates shall be fixed at the rates agreed at service establishment. Frame-by-frame alterations shall not be supported.

11.6.3.3 Multi-channel set multiplexing

Each unprotected multi-channel set shall define a fixed multiplex of 1, 2 or all 3 channels, depending on the maximum rates selected. This MCS multiplex shall define the maximum data rates for each channel; these maximum rates may only be changed by establishing a new MCS.

NOTE 1: The MCS size should be chosen to exactly match the maximum channel rates required.

The following multi-channel set multiplex sizes are defined.

Table 11.6.3.3.1: Unprotected MDU sizes

MCS Size	MDU size
Size N1	40 octets
Size N2	80 octets

MCS Size N1: this multiplex produces 1 output frame per TDMA frame. It shall support the following channel multiplexes.

Table 11.6.3.3.2: MCS Size N1, Maximum channel rates

MCS Ref	Channel 1 rate	Channel 2 rate	Channel 3 rate
N1/32	32 kbit/s	none	none
N1/16	16 kbit/s	16 kbit/s	none
N1/08	16 kbit/s	8 kbit/s	8 kbit/s

MCS Size N2: this multiplex produces 2 output frames per TDMA frame. It shall support the following channel multiplexes.

Table 11.6.3.3.3: MCS Size N2, Maximum channel rates

MCS Ref	Channel 1 rate	Channel 2 rate	Channel 3 rate
N2/64	64 kbit/s	none	none
N2/32	32 kbit/s	32 kbit/s	none

In all cases, a fixed bandwidth connection shall be used with a bandwidth (in bearers) equal to the number of output frames.

Each MCS multiplex shall combine the adapted data units from all of the relevant input channels using either non-interleaved or interleaved packing to produce a multiplexed data unit. Non-interleaved packing shall always be supported. This shall concatenate ADUs in order of ascending channel number as shown in figure 11.6.3.3.1.

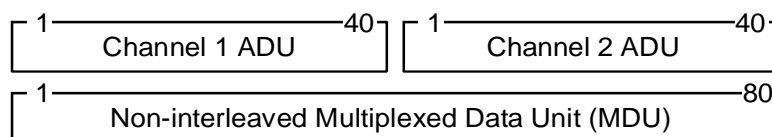

Figure 11.6.3.3.1: Example of non-interleaved packing (MCS Ref: N2/32)

Interleaved operation is optional. If used, the interleaving shall operate with whole octets using a fixed interleave pattern with an interval of 10 octets. Channels shall be interleaved in order of ascending channel number.

NOTE 2: Interleaved operation may be used on all sizes of MCS.

For example, the order of octets in an Interleaved MDU for the example given above, shall be as in figure 11.6.3.3.2.

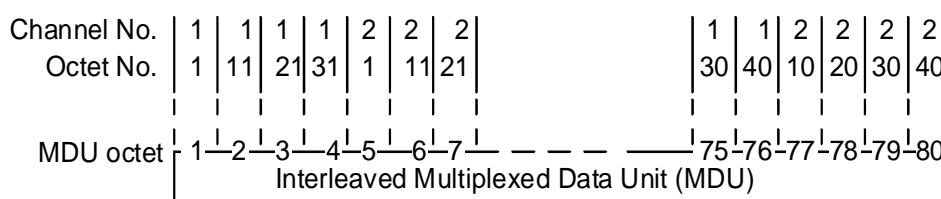

Figure 11.6.3.3.2: Example of interleaved packing (MCS Ref: N2/32)

11.6.3.4 Segmentation of MDUs

Each MDU shall be segmented into 40 octet segments that are suitable for insertion into FU1 frames. Segmentation is a function of the size of the MCS.

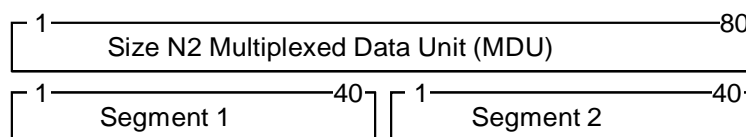

Figure 11.6.3.4.1: Segmentation of Size N2 MDU



Figure 11.6.3.4.2: Segmentation of Size N1 MDU

The segmented MDU data shall be inserted into FU1 frames in order of ascending octet number. The frames shall be submitted to the transmission engine in order of ascending segment number.

11.6.3.5 Frame transmission

The resulting stream of frames shall be handled by a class 0 transmission engine using the procedures defined in clause 14.3.2.

The associated MAC connection shall be required to provide a fixed bandwidth of 1 or 2 bearers (as appropriate).

At the receiving side an indication shall be issued to the interworking unit for all frames that are received with errors.

NOTE: This indication is less reliable than the indication available from the protected class of operation. This indication is based on the X-field CRC (refer to ETSI EN 300 175-3 [3]).

11.7 LU6 Secondary RATE adaption (SRAT) service

11.7.1 General

The LU6 service is a SRAT service that is accessed through the LU6 SAP. It is a "secondary" rate adaption service because it can only operate in conjunction with the BRAT service (LU5). It offers a family of procedures that enable rate adapt data terminal equipment with V-series interfaces to be interfaced to one of the input rates provided by the BRAT service (LU5).

The SRAT service shall use the primary rate conversion procedures defined in Recommendation ITU-T V.110 [13]. In particular, the following Recommendation ITU-T V.110 [13] procedures shall apply:

- Rate Adaption (RA) of asynchronous lower rates, including start and stop bit manipulation (RA0);
- Rate Adaption (RA) of synchronous lower rates to an intermediate rate (RA1);
- direct rate adaption of synchronous rates of 48 kbit/s and 56 kbit/s to 64 kbit/s.

In all cases the output of LU6 shall use one Rp input channel of one independent instance of LU5. The Rp input channel shall be configured at the intermediate rate or at 64 kbit/s as given in tables 11.7.1.1 and 11.7.1.2.

Table 11.7.1.1: Asynchronous operation: LU6 input and output rates

Input Rates Data signalling rate (bit/s)	Output Rates			
	Intermediate rate			
	8 kbit/s	16 kbit/s	32 kbit/s	64 kbit/s
RA0 conversion procedures				
50	x			
75	x			
110	x			
150	x			
200	x			
300	x			
600	x			
1 200	x			
2 400	x			
3 600	x			
4 800	x			
7 200		x		
9 600		x		
12 000			x	
14 400			x	
19 200			x	

NOTE: All of the rates indicated should be provided as the minimum set by a universal implementation.

Table 11.7.1.2: Synchronous operation: LU6 input and output rates

Input Rates Data signalling rate (bit/s)	Output Rates			
	Intermediate rate			
	8 kbit/s	16 kbit/s	32 kbit/s	64 kbit/s
RA1 conversion procedures				
600	X			
1 200	X			
24 400	X			
4 800	X			
7 200		X		
9 600		X		
12 000			X	
14 400			X	
19 200			X	
Direct conversion procedures				
48 000				X
56 000				X

11.8 LU16 ESCape Service (ESC)

11.8.1 General

The LU16 service provide an ESC service, that allows for an implementation specific U-plane. The use of LU16 coding shall indicate a non-standard service and interoperability will only be achieved by local agreements. This coding shall not be used to provide a service that is identical to one of the standard services.

LU16 may use any frame type and any transmission class, with the exact choice being indicated in the <<Call Attributes>> message. In all cases LU16 shall use a protected MAC service (I_{PQ} -error-detect, I_{PQ} -error-correct, I_P error_detect or I_P error_correct).

NOTE: The unprotected MAC service (I_N) can be accessed through the LU1 service. This (unprotected) escape is restricted to use of the FU1 frame.

The most general (protected) ESC service is provided by the use of FU1 frame. The frames defined in clause 12 should be used in preference to locally defined frames, if one of these frames provides suitable functions.

In all cases, the LU16 service shall maintain SDU integrity. However, SDU sequencing and/or error control is undefined in the present document. At the receiving side an indication shall be issued to the IWU for all frames that are received with errors. This indication shall be based on the CRC result supplied by the MAC layer.

11.9 LU7 64 kbit/s data bearer service

11.9.1 General

This clause describes the 64 kbit/s data bearer service specified for the DECT radio interface. The LU7 service supports a full-duplex synchronous data bearer service with 64 kbit/s. The service provides an improved residual error rate. The resultant improvement of the error rate at the ISDN interface is, due to the nature of radio wave propagation, dependent on the specific environment of the configuration. The service is realized on the basis of using a combination of FEC and ARQ. The service introduces an additional fixed delay of 80 ms in order to provide time for a limited re-transmission capability.

11.9.2 Physical layer service

The used physical packet is the double slot (packet P80).

11.9.3 MAC layer service

The duplex unprotected normal delay MAC service with the B-field multiplex U80a offering a data rate of 80 kbit/s, shall be used. A symmetric single-bearer MAC-connection shall be used. Advanced MAC connection control (A-field or B-field) shall be used.

For paging, the full paging format shall be used. This allows the network layer to indicate the MAC service in the Link Control Entity (LCE) request paging message.

During connection handover it is allowed that 2 bearers are serviced by independent LU7 entities on both sides.

11.9.4 DLC layer service

11.9.4.1 Architectural model

11.9.4.1.0 General

In order to provide a limited ARQ capability and still maintain the 64 kbit/s data rate, a transmit buffer, receive buffer and an increased data transfer rate of 72 kbit/s are utilized (see figure 11.9.4.1.0.1). The transmit buffer provides a limited duration storage facility for previously sent frames and therefore allows for the possible re-transmission of these previously sent frames. The receive buffer delays the forwarding of the received frames to the application layer in order to allow a period where erroneous frames may be replaced. The increased data transfer rate of 72 kbit/s is used to compensate for any re-transmission attempts that may occur.

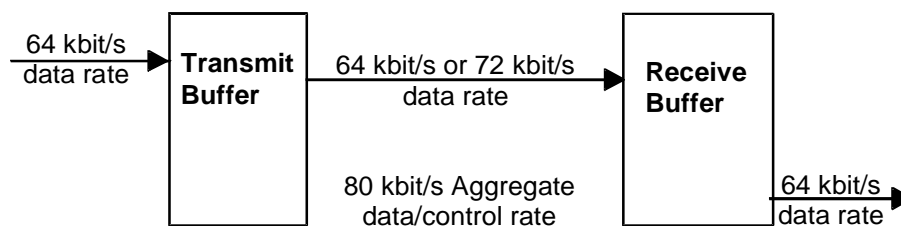

Figure 11.9.4.1.0.1

11.9.4.1.1 Transmit (Tx) frame buffering

Each LU7 service endpoint shall have an associated Tx frame buffer. The transmit frame buffer capable of buffering the data from 8 ARQ frames shall be used to buffer the newly arriving frames coming from the application. During normal operation, each frame that is transmitted is also saved in the Tx frame buffer for possible re-transmission. The format of the first time transmitted frame shall thereby be preserved. Each frame will therefore be available for re-transmission until it is overwritten, 8 DECT frame times later ($8 \times 10 \text{ ms} = 80 \text{ ms}$). When re-transmitting a previously sent frame, the newly arriving frames are saved in Tx frame buffers until transmission is possible.

11.9.4.1.2 Receive (Rx) frame buffering

Each LU7 service endpoint shall have an associated Rx frame buffer. A First-In-First-Out (FIFO) frame buffer structure of fixed size shall be used to buffer the newly arriving frames coming over the CI from the source LU7 service endpoint. The Rx buffer provides a fixed delay period between the reception of a frame from the source LU7 endpoint and the forwarding of the frame. This delay period allows for the ARQ procedures to occur without disruption of the outbound 64 kbit/s synchronous data stream.

11.9.4.2 Automatic-Repeat-Request (ARQ) and Forward Error Control (FEC)

11.9.4.2.0 General

The Forward Error Control shall provide Reed-Solomon error control coding of the data to correct a number of errors occurring over the radio interface. In the transmit direction, FEC shall add the parity symbols and shall pass the code-word to the MAC layer. In the receive direction, FEC shall check and remove the parity symbols.

An FEC frame shall consist of a 800-bit Reed-Solomon code-word. The Reed-Solomon code-word shall comprise 100 eight-bit symbols, k of which shall carry control information and user data, and $100-k$ of which shall be parity symbols. The 800-bit frame shall fully occupy the B field of one double slot transmit burst. The bits in an FEC code-word shall be transmitted from left to right (parity symbols last).

Bits	$8 \times K$	$8 \times (100-k)$
	Reed Solomon Message Symbols	Reed Solomon Parity Symbols

Figure 11.9.4.2.0.1: FEC Frame Structure

Systematic shortened Reed-Solomon block codes $(100,k)$ with 8-bit symbols shall be used for FEC.

A Reed-Solomon code is described as a (N,K) code, where N is the number of m -bit symbols in a code-word and K is the number of message symbols. In this case, $m = 8$ and $N = 2^m - 1 = 255$ symbols per code-word. The code is shortened to a (n,k) code where $n = N-i$ and $k = K-i$ by setting the i most significant code-words to zero. The Reed-Solomon decoder can correct up to the (the integer part of) $(n-k)/2$ symbols. In this case $n = 100$ and $i = 155$ symbols (i.e. 1 240 bits).

The Reed-Solomon codes use polynomials in the Galois Field $GF(256)$, which is an extension field of $GF(2)$ constructed with the primitive polynomial:

$$g(X) = 1 + X^2 + X^3 + X^4 + X^8$$

Since a code-word containing all zeroes is a valid code-word, the parity symbols of a code-word shall be inverted (one's-complement).

The LU-7 service is used to protect the transmission signal by an RS $(255,249)$ code which may be used to correct up to 3 errors within a double slot connection. The generator polynomial to encode and decode the information has 6th degree:

$$p(X) = \prod_{i=0}^5 (X + \alpha^i)$$

where α is a root of the binary primitive polynomial:

$$g(X) = X^8 + X^4 + X^3 + X^2 + 1$$

A data byte:

$$(d_7, d_6, d_5, d_4, d_3, d_2, d_1, d_0)$$

is identified with the element:

$$d_7\alpha^7 + d_6\alpha^6 + d_5\alpha^5 + d_4\alpha^4 + d_3\alpha^3 + d_2\alpha^2 + d_1\alpha^1 + d_0\alpha^0$$

in $GF(256)$, the finite field with 256 elements.

The FEC shall check the parity symbol by computing a syndrome over the code-word. If the syndrome is zero, the code-word contains no detectable errors. If the parity symbols indicate that the code-word is in error (i.e. it has a non-zero syndrome), FEC may apply the error correction algorithm to the code-word.

In addition to the FEC, an ARQ facility shall be provided. The ARQ frames shall be carried in the FEC message symbols, one ARQ frame per FEC code-word. The ARQ frame consists of three fields, starting at the beginning of the FEC code-word, these shall be:

- control field: 2 octets;
- information field: 90 octets;
- contains in the case of format 64 kbit/s 10 fill-octets at the end;
- checksum field: 2 octets (16 bits).

Figure 11.9.4.2.0.2 shows the frame structure. The bits in an FEC code-word shall be transmitted from left to right (control field first, parity symbols last).

Bits	16	$8 \times (k-4)$	16	$8 \times (n-K)$
	Control	Information	Checksum	RS Parity Symbols

Figure 11.9.4.2.0.2: Frame Structure

The checksum shall indicate erroneous frames. The maximum number of bits in an ARQ frame is $8k$, where k is the number of message symbols in the Reed-Solomon code-word. 32 of these bits are for the control field and checksum field and the remaining information bits shall make a multiple of eight. The number of octets in the information field is 90. In the case of format 64 kbit/s there are 10 fill octets at the end of the information field. The corresponding data rates are 64 kbit/s and 72 kbit/s. The FU7 frame structure is shown in table 11.9.4.2.0.1.

Table 11.9.4.2.0.1: FU7 frame structure

	FU7 Format	
Reed-Solomon-Code (n,k)	(100,94)	
Control field	16 bits	2 bytes
Information field	720 bits	90 bytes
Checksum field	16 bits	2 bytes
RS parity symbol field	48 bits	6 bytes
total	800 bits	100 bytes

The fields within the ARQ-frame structure are described in clause 11.9.4.2.1. The coding of the bits within these fields is such that the lowest numbered bit within the field is the least significant bit.

11.9.4.2.1 Control field

11.9.4.2.1.0 General

The control field format is shown in figure 11.9.4.2.1.0.1. The control field is two octets long. The control field identifies the format of the frame (Format-control parameter), the ARQ operation of the frame (ARQ-control parameter), and the sequence numbers (N(S), N(R) and N(O) parameters).

The parameters within the control field and the state variables associated with the control field are described in this clause. The coding of the bits within these parameters is such that the lowest numbered bit within the parameter field is the least significant bit.

Bit	8	7	6	5	4	3	2	1	Octet
	Format-1		N(O)						Octet 1
	Format-2		N(R)			N(S)			Octet 2

Figure 11.9.4.2.1.0.1: Control field format

11.9.4.2.1.1 Format control parameter coding

The Format control parameter indicates the type of frame being used for the transmit direction (format 64 kbit/s or format 72 kbit/s) and whether re-transmission is requested for the receive direction.

Format-control coding in octet 1 and octet 2:

Octet 1		Octet 2		Meaning
8	7	8	7	
0	0	0	0	format 64 kbit/s
0	0	0	1	format 64 kbit/s, re-transmit request
0	1	0	0	format 72 kbit/s
0	1	0	1	format 72 kbit/s, re-transmit request
all other values reserved				

11.9.4.2.1.2 Offset variable $V(O)$

Each point-to-point LU7 service endpoint shall have an associated offset variable $V(O)$ which can take on the value 0 to 56. The offset variable indicates the time delay caused by re-transmissions and the format to be used.

For each re-transmission $V(O)$ shall be incremented by 8. A re-transmission is only allowed if $V(O) \leq 48$. If $V(O) > 48$, then a re-transmit request shall be ignored and a new frame shall be transmitted.

If $V(O) > 0$, then for the first time transmission of a frame the format 72 kbit/s shall be used. For each first time transmission of a frame with format 72 kbit/s $V(O)$ shall be decremented by 1.

If $V(O) = 0$, then for the first time transmission of a frame the format 64 kbit/s shall be used. For each first time transmission of a frame with format 64 kbit/s $V(O)$ shall not be changed.

11.9.4.2.1.3 Time variables $V_n(T)$

Each point-to-point LU7 service endpoint shall have 8 time variables $V_n(T)$ with $n = 0, 1, \dots, 7$, which are associated to the last frames already transmitted and saved in the transmit buffer. The time variables indicate the age (re-transmit delay) of the last 8 transmitted frames and the hypothetical position of that frame in the receive buffer. The position of a frame in the buffers is defined by the position of its first (leading) octet of the info field. They can take on the value 0 to 56.

For the first time transmission of a frame a variable $V_n(T)$ is associated with this frame and set equal to $V(O)$. With each transmission (or re-transmission) of any frame all time variables $V_n(T)$ shall be incremented by 8. This means that after the first time transmission of a frame the value of the corresponding $V_n(T)$ is equal to $V(O) + 8$ and is further incremented by 8 with each subsequent transmission of a frame (every 10 ms). Frames with $V_n(T) > 56$ shall not be retransmitted.

NOTE: For the association of $V_n(T)$ with a frame the relation $n = N(S)$ can be used, where $N(S)$ is the send sequence number of the relevant frame.

11.9.4.2.1.4 Offset number $N(O)$

The offset number $N(O)$ defines the time delay of a transmitted frame, compared to the normal transmit time of this frame across the air interface and thus the actual position for that frame in the receive buffer of the receiver. The normal transmit time of a frame is the transmit time, when there has not been any re-transmission of any frame before. Without any re-transmissions a frame is transmitted almost immediately (with "normal delay") across the air interface. $N(O)$ defines the offset in multiples of 10 bytes. $N(O)$ can take on the value 0 to 56. The actual position of a frame is defined by the position of the first octet of its info field.

In the case of a first time transmission of a frame, $N(O)$ is set equal to $V(O)$.

In the case of a re-transmission of a frame, $N(O)$ is set equal to that $V_n(T)$, which corresponds to the frame that is going to be retransmitted.

Offset number $N(O)$ in octet 1:

- 6 bit binary coded number.

11.9.4.2.1.5 Send state variable V(S)

Each point-to-point LU7 service endpoint shall have an associated V(S) state variable. V(S) denotes the sequence number of the next frame to be transmitted. V(S) can take on the value 0 to 7. The modulus of V(S) equals 8. The value of V(S) shall be incremented by 1 with each first time transmission of a frame.

NOTE: In case of a re-transmission V(S) is not incremented.

11.9.4.2.1.6 Acknowledge state variable V(A)

Each point-to-point LU7 service endpoint shall have an associated V(A) state variable. V(A) identifies the last frame that has been acknowledged by its peer (V(A) - 1 equals the N(S) of the last acknowledged frame, see clause 11.9.4.2.1.7). V(A) can take on the value 0 to 7. The modulus of V(A) equals 8. The value of the acknowledge state variable shall be updated by the valid N(R) values received from its peer (see clause 11.9.4.2.1.9). A valid N(R) value is one that is in the range $V(A) \leq N(R) \leq V(S)$.

11.9.4.2.1.7 Send sequence number N(S)

N(S) is the send sequence number of transmitted frames. In the case of a first time transmission of a frame, N(S) is set equal to V(S). In the case of a re-transmission, N(S) is set equal to V(A).

Sending sequence number N(S) in octet 2:

- 3 bit binary coded number.

11.9.4.2.1.8 Receive state variable V(R)

Each point-to-point LU7 service endpoint shall have an associated V(R) state variable. V(R) denotes the sequence number of the next in-sequence frame expected to be received. V(R) can take on the value 0 to 7. The modulus of V(R) equals 8. Upon receipt of an error free frame whose N(S) equals V(R), the value of V(R) shall be incremented by 1 and then additionally by 1 for each subsequent error free frame in the Rx buffer.

11.9.4.2.1.9 Receive sequence number N(R)

At the time that a frame is designated for transmission, the value of N(R) is set equal to V(R). N(R) indicates that the LU7 service entity transmitting the N(R) has correctly received all frames numbered up to and including N(R)-1.

N(R) indicates the sequence number of the frame that is to be transmitted or re-transmitted.

Receiving sequence number N(R) in octet 2:

- 3 bit binary coded number.

11.9.4.2.2 Information field

The information field of a frame follows the control field and precedes the frame checksum (see clause 11.9.4.2.3). The number of octets in the information field is 90. In the case of format 64 kbit/s the information field contains 10 fill octets at the end. The fill octets shall be set to zero, if present.

NOTE: The fill octets may in future contain further service information such as whether additional formats are supported by the sending side.

11.9.4.2.3 ARQ checksum

The ARQ checksum shall be a sixteen-bit sequence. It shall be the ones complement of the sum (modulo 2) of:

- a) the remainder of $x^k(x^{15}+x^{14}+x^{13}+x^{12}+x^{11}+x^{10}+x^9+x^8+x^7+x^6+x^5+x^4+x^3+x^2+x^1+1)$ divided (modulo 2) by the generator polynomial $x^{16}+x^{12}+x^5+1$, where k is the number of bits of the control field (see clause 11.9.4.2.1) and information field (see clause 11.9.4.2.2) in the FU7 frame; and
- b) the remainder of the division (modulo 2) by the generator polynomial $x^{16}+x^{12}+x^5+1$, of the product of x^{16} by the content of the control field and information field in the FU7 frame.

As a typical implementation at the transmitter, the initial content of the register of the device computing the remainder of the division is pre-set to all 1s and is then modified by division by the generator polynomial (as described above) on the address, control, and information fields; the ones complement of the resulting remainder is transmitted as the sixteen-bit checksum.

As a typical implementation at the receiver, the initial content of the register of the device computing the remainder is pre-set to all 1s. The final remainder after multiplication by x^{16} and then division (modulo 2) by the generator polynomial $x^{16}+x^{12}+x^5+1$ of the serial incoming protected bits and the checksum, will be "0001 1101 0000 1111" (x^{15} to x^0 , respectively) in the absence of transmission errors.

11.9.4.3 Procedures for normal operation

11.9.4.3.0 General

The normal operation procedures for use by the LU7 service entity are specified in the following clauses.

11.9.4.3.1 Establishment and synchronization procedures

Upon establishment of the MAC layer connection, each LU7 service entity shall set V(S), V(R), V(A) and V(O) to 0.

Following the establishment of the MAC layer both service entities shall start transmitting valid frames e.g. if they have detected a LU7 service request in the {CC-SETUP} message received from the adjacent entity.

The information field of these frames shall be set to all "1" if the B-channel is allocated and connected.

Starting with the transmission of the first frame operations upon N(S), N(R), N(O) shall follow the normal procedures.

N(S) shall continuously be incremented while N(R) and N(O) are "0".

The entities having started the transmission shall analyse received information for a first correct frame being valid (correct CRC after FEC operation) with correct sequence numbering.

NOTE: A MAC layer B-Field set to all "0" will result in a MAC layer checksum error.

The entities shall start the timer <DLU.02> with the transmission of the first frame. The timer is stopped upon the reception of a first valid frame.

<DLU.02>	LU7 timer
FT value:	5 s
PT value:	5 s
Start:	first transmission of valid LU7 frame
Stop:	a valid LU7 frame is received

The received information of the valid frames is stored in the receive buffer.

Commencing in that cycle carrying the first valid frame the receiver shall start forwarding dummy information (containing all "1") at its output interface for 8 consecutive cycles.

Then the service is established and the receiver takes subsequent frames to be forwarded from the information queue in its receive buffer.

Starting in the cycle following the event of the reception of the first valid frame the exceptional procedures according to clause 11.9.4.4 apply.

Concerning U-plane handling see clauses 11.9.4.1 and 11.9.4.2.

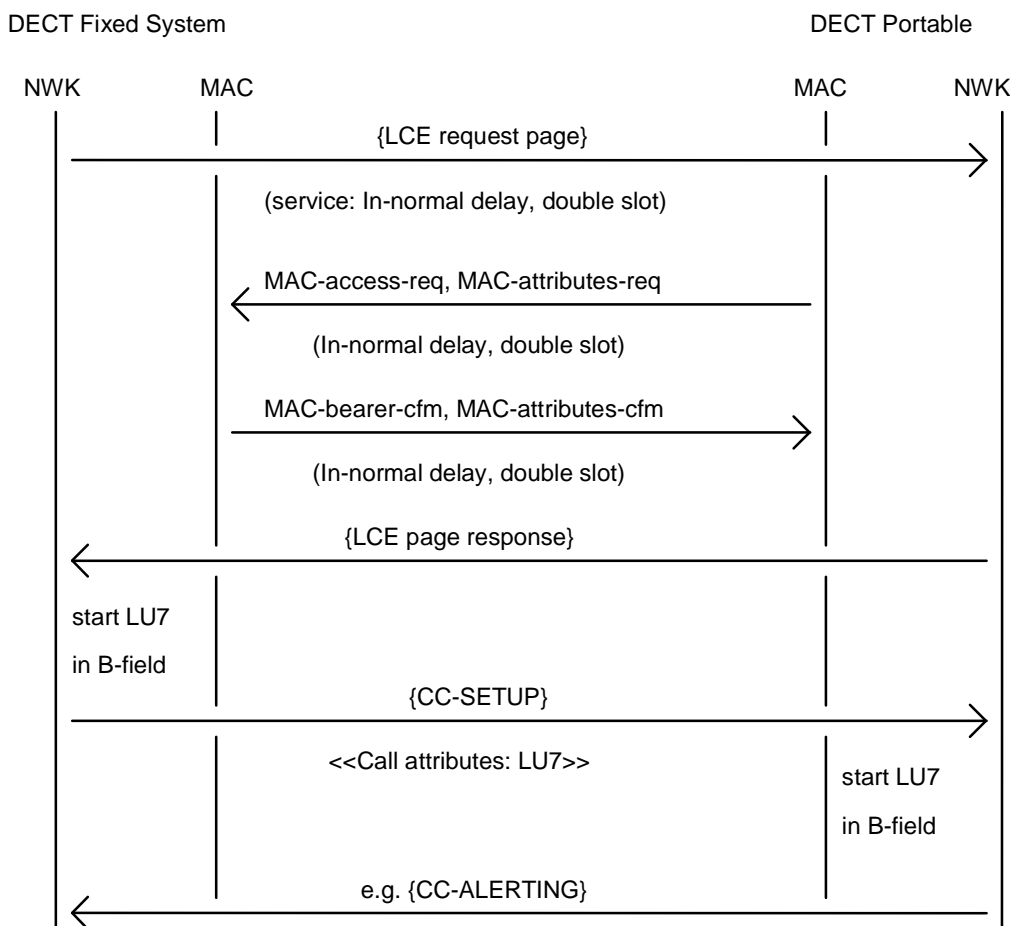

Figure 11.9.4.3.1.1: FT initiated call establishment with LU7

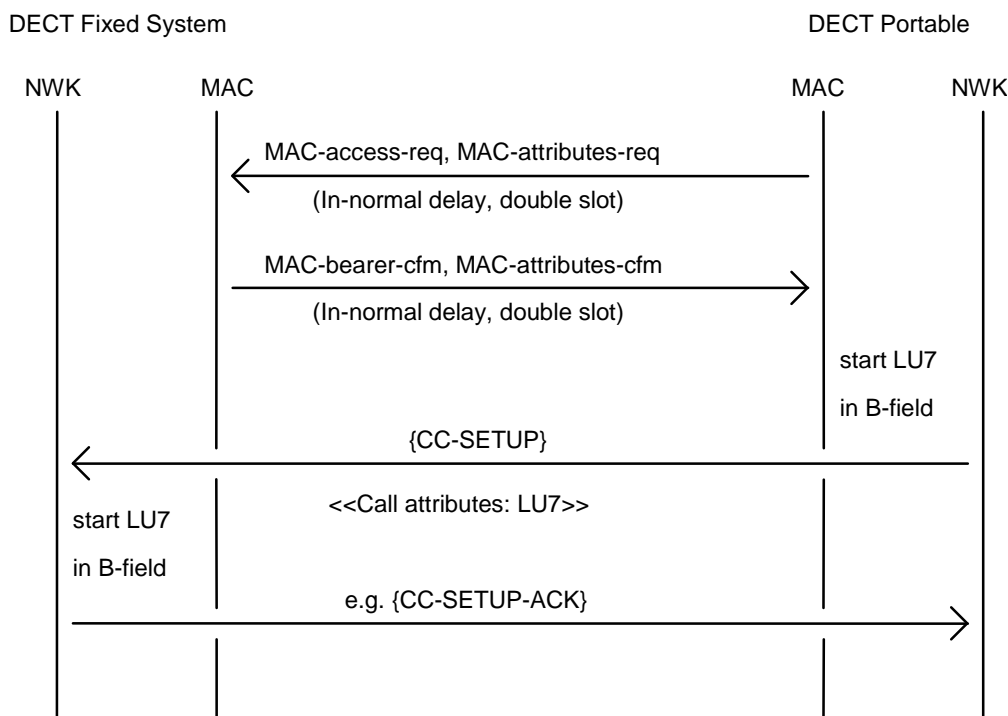

Figure 11.9.4.3.1.2: PT initiated call establishment with LU7

11.9.4.3.2 Active phase

11.9.4.3.2.1 Transmitting frames (first time transmission)

The transmitter performs first time transmission of a frame if:

- a frame with incorrect checksum has been received (after possibly having applied FEC); or
- no re-transmit request has been received; or
- an invalid $N(R)$ has been received (valid $N(R)$ means $V(A) \leq N(R) \leq V(S)$); or
- the time variable $V_n(T)$ of the frame for which re-transmission has been requested has the value > 56 ; or
- $V(O) > 48$.

The control field parameters $N(S)$, $N(R)$ and $N(O)$ shall be assigned the values $V(S)$, $V(R)$ and $V(O)$, respectively.

If the time offset variable $V(O) = 0$ then a "format 64 kbit/s" frame shall be transmitted. Otherwise, a "format 72 kbit/s" frame shall be transmitted.

$V(S)$ shall be incremented by 1 and all $V_n(T)$ with $0 \leq V_n(T) \leq 56$ shall be incremented by 8 at the end of the transmission of the frame. If a "format 72 kbit/s" frame has been transmitted, then $V(O)$ shall be decremented by 1 at the end of the transmission of the frame.

11.9.4.3.2.2 Re-transmitting frames

The re-transmission of a frame is requested when:

- a frame is received containing a format control field indicating a re-transmit request for frame $N(R)$; and
- a valid $N(R)$ has been received (valid $N(R)$ means $V(A) \leq N(R) \leq V(S)$); and
- the time variable $V_n(T)$ of the frame $N(R)$ for which re-transmission has been requested is in the range $0 \leq V_n(T) \leq 56$; and

- d) $V(O) \leq 48$.

The control field parameter $N(S)$ shall be set to the requested re-transmission sequence number, $N(R)$. The control field parameter $N(R)$ shall be set to the current value of $V(R)$. The control field parameter $N(O)$ shall be set to the current value of that $V_n(T)$, which is associated to the requested frame $N(S)$. The format, indicated by the format-control parameter coding (format 64 kbit/s or format 72 kbit/s), of the re-transmitted frame shall not be changed from the format used for the initial sending of the frame.

$V(O)$ and all $V_n(T)$ with $0 \leq V_n(T) \leq 56$ shall be incremented by 8 at the end of the transmission of the frame.

11.9.4.3.2.3 Receiving frames

When an LU7 service entity receives a valid frame whose $N(S)$ is equal to the current $V(R)$, then the LU7 service entity shall:

- store the frame in the LU7 entity's receive buffer, the position of the frame in the receive buffer is defined by the received offset number $N(O)$;
- update $V(A)$ with the value of $N(R)$;
- $V(R)$ shall be incremented by 1 and then additionally by 1 for each subsequent error free frame in the Rx buffer;
- if the format control field indicates a re-transmit request for frame $N(R)$ and the associated time variable $V_n(T)$ is in the range $0 \leq V_n(T) \leq 56$ and $V(O) \leq 48$ then the requested frame shall be re-transmitted as described in clause 11.9.4.3.2.2. Otherwise the next un-transmitted frame in the Tx buffer shall be transmitted as described in clause 11.9.4.3.2.1.

When the LU7 service entity receives a valid frame whose $N(S)$ is greater than $V(R)$ then the LU7 service entity shall:

- store the frame in the LU7 entity's receive buffer, the position of the frame in the receive buffer is defined by the received offset number $N(O)$;
- update $V(A)$ with the value of $N(R)$;
- if the transmission of data to the line interface contained in the originally expected frame $V(R)$ should start before a next frame can be received from the air interface, then $V(R)$ shall be incremented by 1 and then additionally by 1 for each subsequent error free frame in the Rx buffer;
- if the format control field indicates a re-transmit request for frame $N(R)$ and the associated time variable $V_n(T)$ is in the range $0 \leq V_n(T) \leq 56$ and $V(O) \leq 48$ then the requested frame shall be re-transmitted as described in clause 11.9.4.3.2.2. Otherwise the next un-transmitted frame in the Tx buffer shall be transmitted as described in clause 11.9.4.3.2.1.

$N(O)$ defines the position of a frame in the receive buffer. The value $N(O) = 0$ means, that the transmitted frame has not been delayed because of any previous re-transmissions. A value of $N(O) \neq 0$ defines the delay of the frame caused by previous re-transmissions of this or other frames. $N(O)$ defines the delay in multiples of 10 octets, which corresponds to multiples of 1,25 ms. Therefore the time interval between the reception of a frame over the air interface and starting to forward the data to the line interface can be calculated as:

$$\text{Time_interval} = \text{Fixed_delay} - N(O) \times 1,25 \text{ ms}$$

where the Fixed_delay is 80 ms.

11.9.4.3.2.4 Sending acknowledgements

Whenever an LU7 service entity transmits a frame, $N(R)$ shall be set equal to $V(R)$, indicating acknowledgement of all previously received frames up to $N(R) - 1$. Thus, if no transmission errors have occurred a transmitting entity acknowledges the frames it has received in the TDMA half cycle just before. An entity shall not request re-transmission for purposes other than recovery from transmission errors.

11.9.4.3.2.5 Receiving acknowledgements

Upon receipt of an error free frame, the LU7 service entity shall treat the N(R) value contained in this frame as an acknowledgement for all the frames it has transmitted with an N(S) up to and including the received N(R) - 1 and V(A) shall be set to N(R).

11.9.4.3.3 Release

A normal release is initiated by the service primitives from the upper layer. The release of the LU7 service is combined with the MAC layer release. Therefore no additional procedure is necessary.

11.9.4.4 Exceptional procedures

11.9.4.4.0 General

Exception conditions may occur as the result of physical layer errors, MAC errors, or LU7 service entity procedural errors.

The error recovery procedures which are available to perform recovery following the detection of an exception condition at the LU7 service entity are defined in this clause.

11.9.4.4.1 Invalid frame condition

A frame shall be detected as invalid if it contains a frame checksum error. The frame may be stored in the Rx buffer and marked as invalid. If an invalid frame is stored in the Rx buffer no valid data shall be overwritten.

11.9.4.4.2 Establishment

The LU7 service is started by transmitting LU7 frames. The service has been established with the reception of a correct frame and the installation of the delay. The reception of a correct frame is supervised by the timer <DLU.02>. If the timer <DLU.02> expires before a first correct frame has been received the network layer shall be informed and the entire connection shall be released.

11.9.4.4.3 Transmitting frames

First time transmission according to clause 11.9.4.3.2.1 shall continue if no valid frame has been received before.

11.9.4.4.4 Receiving frames

Handling of invalid frames that cannot be recovered in time is left to the implementation. The objective is to achieve a low residual BER.

NOTE: If an invalid frame has been received its contents may be stored in the receive buffer to have best choice data available to be forwarded if that frame cannot be recovered in time. The format just now being in use may be assumed.

A received valid frame which was previously requested for re-transmission shall override a possibly stored invalid frame in the receive buffer.

11.9.4.4.5 Sending acknowledgements

Retransmission of a frame shall be requested as long as a value $N(0) \leq 56$ can be expected for the retransmitted frame assumed being valid.

The receiver shall otherwise acknowledge that frame according to clause 11.9.4.3.2.1.

11.9.4.4.6 Forwarding of received data

If a frame in the receive buffer cannot be recovered in time this produces a residual frame error. The bit sequence forwarded in this case is left to the implementation (see also clause 11.9.4.4.4).

11.9.4.4.7 N(R) sequence error

Unless the condition stated in clause 11.9.4.4.12 is true, the following applies.

An N(R) sequence error exception condition occurs when a frame is received which contains an invalid N(R) value.

A valid N(R) is one that is in the range $V(A) \leq N(R) \leq V(S)$.

An invalid N(R) shall be ignored and normal operation upon sequencing of N(S) shall be continued.

11.9.4.4.8 N(O) sequence error

Unless the condition stated in clause 11.9.4.4.12 is true, the following applies.

An N(O) sequence error exception condition occurs when:

- a) a frame is received which contains an N(O) value indicating a frame position in the RX-buffer that would overwrite already correctly received data, which has not yet been forwarded to the line interface or application; or
- b) frame is received which contains an N(O) value indicating a frame position in the RX-buffer that would partly provide needed data and partly overwrite already correctly received data, which have not yet been forwarded to the line interface or application; or
- c) frame is received which contains an N(O) value indicating a frame position in the RX-buffer that would leave gaps in the RX-buffer, which cannot be filled up with allowed frames without causing overlapping data; or
- d) frame is received which contains an N(O) value indicating a frame position in the RX-buffer that would leave an unexpected large gap in the RX-buffer.

In case a) the received frame should be ignored. Only if the old data was marked with "position-error", then the new frame should be used.

In case b) the received frame may be ignored. Those parts which are not overwriting correct and still valid data may be used. If the old data was marked with "position-error", then the new frame should be used.

In case c) the received data should be stored and marked with "position-error".

In case d) the received data should be stored and marked with "position-error".

NOTE: The N(O) sequence error should be supervised. If the error condition continues, then the link should be released.

11.9.4.4.9 N(S) sequence error

Unless the condition stated in clause 11.9.4.4.12 is true, the following applies.

An N(S) sequence error exception condition occurs when:

- a) a frame is received which contains a different N(S) value for an already correctly received frame; or
- b) a frame is received which contains a N(S) value which has not been incremented by one compared with the preceding neighbourhood frame.

In case a) the received frame should be ignored.

In case b) the received frame should be stored and marked with "sequence-error".

NOTE: The N(S) sequence error should be supervised. If the error condition continues, then the link should be released.

11.9.4.4.10 Format error

Unless the condition stated in clause 11.9.4.4.12 is true, the following applies.

A format error condition occurs upon the receipt of a frame with an undefined format-control parameter in the control field.

The frame should be stored, if the control variable N(O) and N(S) are valid. If the format cannot be estimated unambiguously the frame should be marked with "format-error".

NOTE: The format error should be supervised. If the error condition continues, then the link should be released.

11.9.4.4.11 Abnormal release

If the MAC layer indicates abnormal release, then the LU7 service shall be released and the abnormal release shall be indicated to the higher layer.

11.9.4.4.12 Implicit reset

The unexpected receipt of a frame with both N(O), N(S) and N(R) equal to 0 by the PT entity, after a connection handover has been performed shall be considered as an implicit reset. The receiving entity shall then act according to the following procedures:

- the PT LU7 service entity shall set V(S), V(R), V(A) and V(O) to 0;
- starting with the transmission of the next frame, operations upon N(S), N(R), N(O) shall follow the normal procedures.

11.9.5 Network layer service

11.9.5.1 LCE service

LCE service shall be as specified in the DECT network layer specification ETSI EN 300 175-5 [5]. For paging the long format message with the TPUI address structure shall be supported. The "LCE Header" shall indicate the U-plane MAC service type "I_N-normal-delay". The "Attributes" coding shall be set to "double slot". The "Target bearers" field shall be set to "1". The "MAC packet life" shall be set to "Not applicable".

NOTE: If no TPUI has been assigned, then the default TPUI is used.

11.9.5.2 CC service

CC service shall be as specified in the DECT network layer specification ETSI EN 300 175-5 [5]. In the {CC-SETUP} message the <<CAL-ATTRIBUTES>> information element shall indicate "U-plane symmetry" = "Symmetric", "LU identification" = "LU7", "U-plane class" = "Class 0 normal_delay" and "U-plane frame type" = "FU7".

11.10 LU8 service

11.10.0 General

This clause defines the LU8 64 kbit/s speech and data service specified for the DECT radio interface.

11.10.1 Physical layer service

The used physical packet is the double slot (Packet P80).

11.10.2 MAC layer service

The duplex unprotected normal delay MAC service with the B-field multiplex U80a shall be used. A symmetric single bearer MAC connection shall be used.

11.10.3 DLC layer service

The Forward Error Control (FEC) defined in clause 11.9.4.2 shall be used.

The frame format FU8 used in the LU8 service is defined in figure 11.10.3.1.

2 bytes	80 bytes	10 bytes	2 bytes	6 bytes
spare bits	user data	spare bits	spare bits	RS Parity Symbol (FEC)

NOTE: The coding of the spare bits shall be 0.

Figure 11.10.3.1: FU8 frame structure

This framing format is directly derived from the FU7 framing format removing the ARQ bytes and maintaining the FEC bytes.

The RS (255, 249) code provided by the FEC, may be used to correct up to 3 errors within a double slot connection and uses the generator polynomial defined in clause 11.9.4.2.

If the error correction algorithm cannot correct the errors in a double slot, the LU8 service should transmit the received user data to the IWU with a FEC error indication.

11.11 LU9 - Unprotected Rate Adaption for V series Equipment (RAVE) Service

11.11.1 Overview

11.11.1.0 General

The LU9 service provides for the transparent transport of synchronous continuous data at rates suitable for data terminal equipment with V-series interfaces. Specific support for low speed ATM AAL-1 rates is also provided.

The service offers no error correction of user data and no notification of errors. It therefore offers a simple, easily implemented service for applications where a higher level of bit errors can be accepted. The unprotected service shall use U-DLC transmission class 0.

The protected service is left for further study.

LU9 shall provide mechanisms that offer unprotected reliable transport of isochronous data and control signalling. Five main functions shall be defined:

- 1) filtering period indication;
- 2) transfer of V.24 signalling;
- 3) rate indication;
- 4) DECT Independent Clocking (DIC);
- 5) user data transfer.

Each instance of LU9 shall be distinguished by the use of a different Logical Connection Number (LCN).

NOTE: The protected service is for further study.

11.11.1.1 FU9 frame structure

11.11.1.1.1 General frame structure

The FU9 frame is a fixed length fragmentation.

Bit	8	7	6	5	4	3	2	1	Octet
	Alignment signal field			V.24 signalling field		Rate			1
	DIC Control field			Reserved					2
	Reserved								3
	DIC data field								4
	Information field								5
	...								
	Information field								N-1
	Information field								FU9N

Figure 11.11.1.1.1: Frame Format Type FU9

FU9 is a function of the underlying connection type.

Table 11.11.1.1.1: FU9 connection types

Connection Type	Slot Type	FU9
I _N /normal delay	Full slot	40 octets

NOTE: Other connection types are for further study.

11.11.1.1.2 FU9 buffering procedures

The FU9 entity shall be used to provide a data buffering function between the service user and the MAC layer. It shall be required to supply data to the MAC layer (at the transmit side) or accept data from the MAC layer (at the receive side) on demand and with minimum delay.

NOTE: Normal data delivery will be periodic, with frames demanded and delivered at the TDMA frame rate.

Transmit side: on receipt of a MAC_CO_DTR-ind primitive, one complete frame of data shall be submitted to the MAC layer in a MAC_CO_DATA-req primitive.

Receive side: each MAC_CO_DATA-ind primitive shall contain one complete frame of data from the MAC layer.

Data overflow or underflow due to slight clock differences shall be handled by the DECT Independent Clocking procedures described in clause 11.11.5.

11.11.1.1.3 Connection handover

During connection handover, FU9 frames may be sent simultaneously to both the old and the new connections. The receive path is then switched to the new connection as soon as the new connection is indicated to be in the "open" state.

NOTE: Dependent upon the exact implementation of both FT and PT, seamless connection handover should be possible.

11.11.1.1.4 Transmission order

The physical transmission order shall be controlled by the MAC layer as defined in ETSI EN 300 175-3 [3], clause 5.4.5.

The same bit ordering shall be maintained at the interface between the DECT DLC U-plane and the IWF in the FP. The same bit ordering shall be maintained at the interface between the DECT DLC U-plane and the TAF in the PP.

NOTE: The Terminal Adaptation Functions (TAF) integral to a Portable Part (PP) and the InterWorking Functions (IWF) integral to a Fixed Part (FP) enable the attachment of synchronous serial data applications to a PP and the attachment of isochronous connection-oriented serial data transmission network services to an FP.

The operations across the DLC layer/MAC layer boundary shall be such that the DLC entity sending a frame can assume this temporal order of the frame, and that the entity receiving the frame can reconstruct it with its assumed temporal order.

In all cases, the order of arrival of the higher layer information shall be preserved, and this shall be identical to the order of transmission.

11.11.2 Alignment signal management

11.11.2.1 General

For the information carried in the V.24 signalling field, in the Rate field, in the DIC Control and in the DIC data field, a "filtering period" equal to 10 successive FU9 frames is defined.

The filtering period duration is associated to the transmission of a special codeword, called alignment signal, in the bit 1 and bit 2 in octet 1.

The alignment signals shall be continuously transmitted: in this way, the last frame of filtering period numbered N and the first frame of filtering period numbered N+1 shall be consecutive.

To reduce errors due to the hostile nature of the radio channel, the same DIC information shall be maintained constant at least in one filtering period. The V.24 signalling and Rate information shall be maintained constant at least in two consecutive filtering periods.

Furthermore, changes of values shall be possible only at the beginning of a filtering period. At the receiver side, these variations shall be considered valid only if the receiver is in the locked state.

For the alignment signal management, the procedures described in clause 11.11.2.2 shall apply.

NOTE: The alignment signal emulates a "square wave" signal. The filtering period is equivalent to the period of the "square wave".

11.11.2.2 Procedures

Transmitter side: the transmitter shall set bit 1 and bit 2 in octet 1 in the FU9 frames constituting the alignment signal in accordance with table 11.11.2.2.1.

Table 11.11.2.2.1: Alignment field coding

Frame number	bit 1 octet 1	bit 2 octet 1
N	1	1
N+1	1	1
N+2	1	1
N+3	1	1
N+4	1	1
N+5	0	0
N+6	0	0
N+7	0	0
N+8	0	0
N+9	0	0

The first frame of the filtering period in table 11.11.2.2.1 is frame number N. The last frame of the filtering period in table 11.11.2.2.1 is frame number N+9. The possible new value in the V.24 signalling field, in the Rate field, in the DIC Control field and in the DIC data field shall be inserted starting from frame N.

Receiver side: the receiver shall operate in one of two possible states: the "unlocked" state and the "locked" state, see figure 11.11.2.2.1.

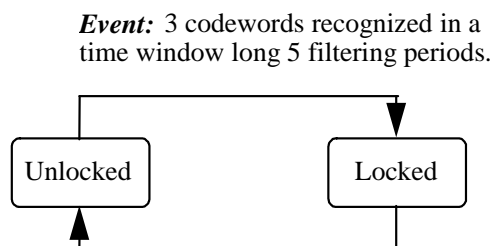

Event: at least 5 codewords not recognized in a time window long 10 filtering periods.

Figure 11.11.2.2.1: Receiver side states

In the unlocked state, the receiver shall continuously monitor the status of bit 1 and bit 2 in octet 1 in consecutive received FU9 frames, trying to recognize the alignment signal bit pattern. The receiver shall enter the locked state only if it shall be able to recognize at least 3 alignment signals in a time window of 5 filtering periods (equal to 50 FU9 frames).

In the locked state, the receiver shall continuously monitor the status of bit 1 and bit 2 in consecutive received FU9 frames, trying to recognize the alignment signal bit pattern. The receiver shall enter the unlocked state only if it shall not be able to recognize at least 5 alignment signals in a time window of 10 filtering periods (equal to 100 FU9 frames).

The initial state at the receiver side shall be the unlocked state.

11.11.3 V.24 Signalling

11.11.3.1 General

Bits 5 and 6 of octet 1 in FU9 frame shall be used for V.24 signalling transfer, in the FP⇒PP direction only. In the opposite direction (PP⇒FP), these bits shall be permanently set to 1.

Bit	8	7	6	5	4	3	2	1	Octet
			CTS	DCD					1

Figure 11.11.3.1.1: CTS and DCD bits

Bit 5 and bit 6 of octet 1 shall be coded as follows:

CTS (octet 1):

Bits	6	Meaning
	0	CTS line (circuit 106) OFF
	1	CTS line (circuit 106) ON

DCD (octet 1):

Bits	5	Meaning
	0	DCD line (circuit 109) OFF
	1	DCD line (circuit 109) ON

11.11.3.2 Transmitter procedures

The IWF in the FP shall transfer the status of circuit 106 (CTS) and 109 (DCD) from the V-series interface (Recommendation ITU-T V.24 [i.4]) to the TAF in the PP in the octet 1 of an FU9 frame. The individual current status of each circuit shall be maintained for all the FU9 frames of at least two consecutive filtering periods (see clause 11.11.2). Individual status transitions of each circuit shall be transferred only from the first frame of a filtering period.

11.11.3.3 Receiver procedures

The TAF in the PP shall determine the status of circuit 106 (CTS) and 109 (DCD) by integration of the relevant bits of FU9 frames belonging to two consecutive filtering periods. The following integration rules shall apply:

- a) in a filtering period, the result of the integration shall be the value chosen with majority (at least 6 repetitions on the 10 possible ones); In the event that an equal number (5) of each value is detected the current value shall be maintained;
- b) a new status shall be considered valid only if two consecutive filtering periods present the same integration result and the receiver state is "locked" (see clause 11.11.2).

11.11.4 Rate Coding

11.11.4.1 General

Bits 1 to 4 of octet 1 in FU9 frame shall be used to signal user data rate. This indication should be complementary to the user data rate indication transferred in the C-plane, indicating minimum and maximum rate. The in-band indication can be used for dynamic in-band, in-call rate changes between the indicated C-plane minimum and maximum rates. The in-band rate indication also facilitates the synchronization of the rate indication change with the corresponding change in the number of user data octets in the LU9 information field, see clauses 11.11.4.2, 11.11.4.3 and 11.11.6.

Bit	8	7	6	5	4	3	2	1	Octet
	Rate								1

Figure 11.11.4.1.1: User data rate indication

The user data rate resolution shall be " $n \times 2,4 \text{ kbit/s}$ " or " $n \times 4 \text{ kbit/s}$ ".

NOTE: The user data rate resolution should be indicated using the C-plane <<IWU-ATTRIBUTES>> IE (ETSI EN 300 175-5 [5], clause 7.7.21) in all the cases that the LU9 is used. For example, in the data profile D.2 - phase 1, the user data rate resolution is defined in bits 3 to 4, octet 6 of the <<IWU-ATTRIBUTES>> IE.

Valid codings of bits 1 to 4 of octet 1 in FU9 frames shall be the following:

If the user data rate resolution is " $n \times 2,4$ kbit/s" then:

Rate (octet 1):

Bits	4	3	2	1	Meaning
	0	0	0	0	0 kbit/s
	0	0	0	1	2,4 kbit/s
	0	0	1	0	4,8 kbit/s
	0	0	1	1	7,2 kbit/s
	0	1	0	0	9,6 kbit/s
	0	1	0	1	12 kbit/s
	0	1	1	0	14,4 kbit/s
	0	1	1	1	16,8 kbit/s
	1	0	0	0	19,2 kbit/s
	1	0	0	1	21,6 kbit/s
	1	0	1	0	24 kbit/s
	1	0	1	1	26,4 kbit/s
	1	1	0	0	28,8 kbit/s
	All other values reserved				

If the user data rate is " $n \times 4$ kbit/s" then:

Rate (octet 1):

Bits	4	3	2	1	Meaning
	0	0	0	0	0 kbit/s
	0	0	0	1	4 kbit/s
	0	0	1	0	8 kbit/s
	0	0	1	1	12 kbit/s
	0	1	0	0	16 kbit/s
	0	1	0	1	20 kbit/s
	0	1	1	0	24 kbit/s
	0	1	1	1	28 kbit/s
	All other values reserved				

11.11.4.2 Transmitter procedures

The IWF in the FP shall submit a DLU-LU9_RATE.req (containing the new data rate) to the LU9 entity in the FP side. The LU9 entity shall set the Rate field accordingly. The Rate field status shall be maintained for all the FU9 frames of two filtering periods at least (see clause 11.11.2). Rate field status changes shall be possible only at the beginning of the same filtering period at which an OFF to ON status transition for the CTS signal takes place (see clause 11.11.3).

The new user data rate shall only take effect (according to the information field specification of clause 11.11.6) from the first frame after the first 2 filtering periods which signalled the change.

11.11.4.3 Receiver procedures

The LU9 entity in the PP shall determine the data rate value by integration of bits 1 to 4 of octet 1 of FU9 frames belonging to two consecutive filtering periods. The following integration rules shall apply:

- a) in a filtering period, the result of the integration shall be the value chosen with majority (at least 6 repetitions on the 10 possible ones) otherwise the current value is maintained;
- b) the status shall be considered valid only if two consecutive filtering periods present the same integration result and the receiver state is "locked" (see clause 11.11.2).

If condition a) and b) are matched, a DL-LU9_RATE.ind primitive, containing the data rate value, shall be submitted to the upper layer by the LU9 entity in the PP. The information field from the first frame of next filtering period shall be interpreted according to the new user data rate and as specified in clause 11.11.6.

11.11.5 DECT Independent Clocking (DIC)

11.11.5.1 General

In cases where isochronous data streams at user rates up to and including 28,8 kbit/s are received from a remote data source, the data will usually not be synchronized with the DECT clock. For example, the data may be received through an interworking unit from voice-band modems on the analogue PSTN where the transmit data from the remote modem is synchronized to the modem clock. The frequency tolerance of such modems is generally 100 ppm. Another example is the case where a stream of data octets is received from the ISDN and the DECT clock is not synchronized with the ISDN clock.

The following method shall be used to enable transfer of those data signals and the corresponding (octet) timing information across the DECT air interface.

11.11.5.2 Measurement of phase differences

The user data is treated as a stream of octets. If the data source provides octet timing, octet integrity is preserved. If the data source does not provide octet timing, received bits are still treated as octets by grouping them together in 8 bit groups.

The phase difference between the following two frequencies will be measured:

- $R1$ = user data rate in octets/s synchronized with the DECT clock;
- $R2$ = user data rate in octets/s synchronized with the data source clock (e.g. modem).

Figure 11.11.5.2.1 shows the phase diagram for this phase difference ($\text{phase}(R2) - \text{phase}(R1)$). Table 11.11.5.2.1 shows the related bit coding of the DIC Control field.

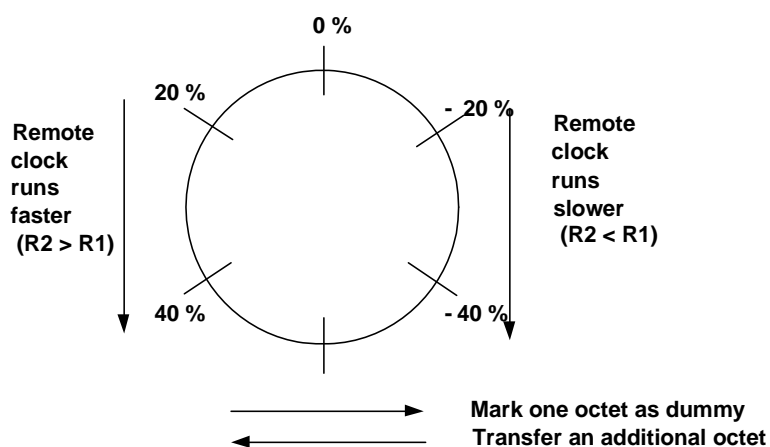

Figure 11.11.5.2.1: Phases diagram

Table 11.11.5.2.1: Phase differences coding

Displacement	Coding DIC Control field (octet 2)		
	bit 8	bit 7	bit 6
0 %	1	0	0
+20 %	0	1	1
+40 %	0	0	0
-40 %	1	1	1
-20 %	0	1	0

11.11.5.3 Compensation control rules

11.11.5.3.1 General

The initial state at both transmitting and receiving state is 0 %. Without compensation, the number of conveyed user data octets per frame is N.

Positive compensation:

On transition from +40 % to -40 %, one frame will convey N+1 user data octets.

(Details: see clause 11.11.5.3.2.)

Negative compensation:

On transition from -40 % to +40 % one frame will convey N-1 user data octets.

(Details: see clause 11.11.5.3.2.)

Hysteresis:

To avoid continuous jitter between neighbouring displacement positions, the displacement code shall be changed only when the measured phase difference is 15 % more or less than the difference indicated by the existing displacement code.

EXAMPLE: Bit combination 011 indicates a phase difference of nominally 20 %. This bit combination will be changed into 000 when the measured phase difference is 35 % or more, and into 100 when the measured phase difference is 5 % or less.

11.11.5.3.2 Optimizing error resilience

11.11.5.3.2.0 General

Transmission errors may hit the DIC Control field and may therefore cause malfunctioning of the DIC mechanism. In order to optimize resilience against transmission errors the additional rules described in clauses 11.11.5.3.2.1 and 11.11.5.3.2.2 shall apply.

11.11.5.3.2.1 Procedure for conveying state changes

Transmitter rules:

Within one filtering period, the DIC Control fields of all frames shall indicate the same displacement value. As a consequence state changes can only occur once per filtering period.

Only state changes between adjacent states are allowed.

Receiver rules:

At the end of any received filtering period, the receiver shall examine the contents of the DIC Control fields of all frames within that filtering period:

- if at least 6 of the 10 frames included in a filtering period contain the same DIC Control field value, that value is accepted. Otherwise the old state value is maintained;
- if the accepted DIC Control field value indicates a state change to a non adjacent state, the state is chosen which is adjacent and located in the appropriate direction.

11.11.5.3.2.2 Procedure for executing positive and negative compensation

Positive compensation:

The first frame of a filtering period, directly following a filtering period indicating a state change from +40 % to -40 %, shall convey N+1 user data octets, i.e. one octet in the DIC data field, followed by N octets in the user data field.

Negative compensation:

The first frame of a filtering period, directly following a filtering period indicating a state change from -40 % to +40 %, shall convey N-1 user data octets in the user data field.

The value of N is specified in table 11.11.6.2.1 relative to the user data rate.

NOTE 1: The present document is based on a similar (but not identical) mechanism specified in Recommendation ITU-T V.110 [13].

NOTE 2: It is assumed that for DIC management, each frame carries two fields: a DIC control field of 3 bits and a DIC data field of 8 bits. In the FU9 frame, these are, respectively, octet 2, bits 8, 7 and 6 and octet 4.

11.11.6 Information field**11.11.6.1 General**

Octets 5 to 40 in FU9 frame shall be used for user data transfer.

The rules regarding the in-band signalling of the user data rate, and in particular when the rate changes take effect with respect to the filtering periods, shall apply as specified in clause 11.11.4.

11.11.6.2 User data rates

Different data rates are allowed, from 2,4 kbit/s up to 28,8 kbit/s, by steps of 2,4 kbit/s or 4 kbit/s. The user data rate values and the number of octets required in a FU9 frame are listed in table 11.11.6.2.1.

Table 11.11.6.2.1: Octets required in the Information field

User data rates	Octets required
0 kbit/s	0
2,4 kbit/s	3
4,8 kbit/s	6
7,2 kbit/s	9
9,6 kbit/s	12
12 kbit/s	15
14,4 kbit/s	18
16,8 kbit/s	21
19,2 kbit/s	24
21,4 kbit/s	27
24 kbit/s	30
26,4 kbit/s	33
28,8 kbit/s	36
4 kbit/s	5
8 kbit/s	10
12 kbit/s	15
16 kbit/s	20
20 kbit/s	25
24 kbit/s	30
28 kbit/s	35

11.11.6.3 Information field filling rule

At the transmission side, user data shall be submitted to the LU9 transmitting entity with a DL-U_DATA-req (see clause 8.4.2.1). User data shall occupy part or all of the Information field, depending on the user data rate defined in the Rate field (see clause 11.11.4).

To map the user data in the Information field, the following rules shall apply:

- a) the first user data octet shall be octet 5, unless bullet e) of this clause applies;
- b) the following transmitted user data octets shall occupy the following successive octets;
- c) the number of occupied octets (indicated as M) shall respect the values listed in table 11.11.6.2.1, with the exception of cases d) and e);
- d) if a DIC negative compensation (see clause 11.11.5.3.2.2) is required, octet 5 shall be filled with "0" Hex. Only in this case, the first user data octet shall be octet 6. The M-1 octets used to carry the user data shall be octets 6 to octet M+4 included;
- e) if a DIC positive compensation (see clause 11.11.5.3.2.1) is required, octet 4 shall be filled with the first transmitted user data octet. Only in this case, the first user data octet shall be octet 4. The M-1 octets used to carry the user data shall be octets 4 to octet M+4 included;
- f) if the user data rate is less or equal to 9,6 kbit/s, the first M octets group (starting at octet 5) shall be repeated in the remaining Information field octets, respecting the octet order; otherwise
- g) if the user data rate is greater than 9,6 kbit/s, the remaining octets shall be filled with "0" Hex.

NOTE: Condition f) may be used, at the receiving side, in the TAF (PP side) or the IWF (FP side) to correct the errors introduced by the radio transmission.

11.11.7 Primitives

User data shall be transferred between LU9 and the LU9-SAP using the DL-U_DATA primitive defined in clause 8.4.2.1. In addition, the following primitives have been defined for LU9 operation:

DLU-LU9_RATE{req,ind}

Table 11.11.7.1

Parameter	REQ	CFM	IND	RES
U-plane Link Endpoint Identifier (ULEI)	A/N		A/N	
Rate indication	A/N		A/N	
A: Always;				
O: Optional;				
N: Not allowed.				

NOTE 1: The DLU-LU9_RATE-req primitive is used only in the FP.
The DLU-LU9_RATE-ind primitive is used only in the PP.

DLU-LU9_CTRL{req,ind}

Table 11.11.7.2

Parameter	REQ	CFM	IND	RES
U-plane Link Endpoint Identifier (ULEI)	A/N		A/N	
V.24 Data not ready				
V.24 control octet	A/N		A/N	
A: Always;				
O: Optional;				
N: Not allowed.				

NOTE 2: The DLU-LU9_CTRL-req primitive is used only in the FP.
The DLU-LU9_CTRL-ind primitive is used only in the PP.

NOTE 3: These primitives are defined only for the purpose of describing layer-to-layer interactions. The primitives are defined as an abstract list of parameters, and their concrete realization may vary between implementations. No formal testing of primitives is intended.

11.12 LU10 Enhanced Frame RELay (EFREL) service

11.12.1 General

The LU10 is a general data transmission service for medium data rates, high error correction performance and low complexity. LU10 provides a peer-to-peer connection protocol for an acknowledged exchange of user data within the DLC_U-Layer.

LU10 service is a frame relay service that is accessed through the LU10 SAP.

NOTE 1: Frame Relay service offered by LU10 is similar to the one defined in Recommendation ITU-T I.122 [i.3].

In the case of the 16-level or 64-level modulation option (see ETSI EN 300 175-2 [2]) the LU10 service may be used.

The LU10 shall operate on a generic field of user data that shall be transferred into and out of the DLC U-plane as a single SDU. This SDU is assumed to contain one external frame, but the operation of LU10 shall be independent of the actual contents of the SDU.

LU10 may operate using any one of the combinations of transmission class and PDU structure described in table 11.12.2.1. For Class 2 transmission the use of ARQ-type SEL is recommended. Go_Back_N is also allowed.

LU10 shall provide the following functions:

- peer-to-peer transmission of user data (SDUs);
- segmentation of SDUs into PDUs;
- management of the V(S), V(R) state variables(s) and handling of N(s) and N(R) according to the transmission class used;
- multiple SDU transfer, which means that more than one SDU (or only a part of it) can be inserted in one PDU.

LU10 shall not provide the following functions:

- add neither additional header nor checksum to SDUs.

If required, these functions are assumed to be provided by the user of LU10 entity.

LU10 shall provide mechanisms that offer reliable transport of the generic SDUs, and that preserve the SDU boundaries. Depending on the SDU delivery mode, the LU10 service may or may not preserve the order of SDUs, transmitted at one LU10 SAP, when they are delivered at the other end.

NOTE 2: The SAP means the entry to the LU10 entity, refer to clause 11.1.

Two main procedures shall be provided:

- 1) segmentation of the SDU at the transmitting side, reassembly to SDUs at the receiving side;
- 2) peer-to-peer transmission of these segments using (small) internal frames.

To avoid possible confusion between external and internal frames the following words are used in this clause from here onwards:

- "SDU" shall refer to the user data;
- "PDU" shall refer to the internal frames;
- "Segment" shall refer to the information content of one "PDU";
- "sub-segment" or "info field" shall refer to the sub-segment of information immediately following a Length indicator octet and with the number of bytes indicated by such indicator.

11.12.2 Segmentation and transmission class

The SDU shall be segmented into fixed length segments, where the segment length shall depend on the PDU structure chosen. The alternative PDU structures shall correspond to one of the internal frame types defined in clause 12, where the type depends on the chosen class of service. LU10 may use any one of the following combinations of transmission class and PDU structure:

Table 11.12.2.1: Transmission classes for LU10 operation

Transmission class	PDU structure
Class 1 unidirectional	FU10a/FU10c
Class 1 unidirectional	FU10a/FU10d
Class 1 bi-directional	FU10b
Class 2 unidirectional	FU10a/FU10c
Class 2 unidirectional	FU10a/FU10d
Class 2 bi-directional	FU10b
Class 3 unidirectional	FU10a/FU10c
Class 3 unidirectional	FU10a/FU10d
Class 3 bi-directional	FU10b
NOTE 1: Other PDU structures/transmission classes are for further study.	
NOTE 2: Each Instance of LU10 only uses a single class of service and a single frame type for all data transmission, and this is defined at service establishment.	
NOTE 3: A bi-directional link can always be implemented using two unidirectional links.	
NOTE 4: For Class 2 transmission, the use of ARQ-type SEL is recommended. Go_Back_N is also allowed.	

Frames FU10a/FU10c or FU10a/FU10d are used to implement unidirectional links. Bi-directional links can be implemented in all cases using two unidirectional links, or alternatively, and only if the link is symmetric, using FU10b frame.

NOTE 1: Frame FU10b is only to be used with bi-directional symmetric links carrying permanently the same bandwidth in both directions. If the link is asymmetric or variable (can change from symmetric to asymmetric), then it should be implemented using two unidirectional links with frames FU10a/FU10c.

NOTE 2: The use of frames FU10a/FU10c or FU10a/FU10d is also recommendable for packet mode services where transmission in one direction does not imply simultaneous transmission in the opposite one.

Frame FU10a may also be used to implement uni-directional links transported over C/L downlink channels.

In all cases, the original SDU boundaries shall be preserved (i.e. service integrity shall be maintained) by use of a length indicator and extended More bit as defined in clause 13.3.

11.12.3 Data transmission

11.12.3.1 Send side procedures

11.12.3.1.0 General

At the transmitting side a complete SDU shall be received in a DL_U_DATA-req primitive. The SDU shall be passed to the segmenting function and segmented into an integral number of segments. The last segment shall be filled with fill octets if necessary. The information content of each PDU shall be marked using the length indicator as described in clause 13.3, and sequence numbers shall be added using the rules defined in clause 13.4.

The resulting PDUs shall be transmitted in ascending order of sequence number (i.e. the lowest numbered segment shall be transmitted first), using the procedures defined in clause 14.3 for the agreed class of operation.

It is possible to insert several SDUs (or parts of them) in one PDU. For detailed information see clause 13.3.2.

Several PDUs may be submitted at once to the MAC layer in a single MAC_CO_DATA-req primitive in response to each MAC_CO_DTR-ind primitive. The number of PDUs shall be less than or equal to the maximum number requested in the MAC_CO_DTR-ind primitive.

11.12.3.1.1 "Early transmission" option

This option shall be specifically invoked in the interworking definition or in an application profile.

If this option is invoked, then the user entity does not need to hold a complete SDU before passing data to the DLC. Instead of that, it may pass segments of SDU (or segments of a data stream in the infinite SDU case). The segmentation and transmission of PDUs may start without waiting for the SDU end boundary.

Operation with infinite size SDUs is allowed in this mode.

11.12.3.2 Receive side procedure

11.12.3.2.0 General

Several PDUs may be received from the MAC layer in a single MAC_CO_DATA-ind primitive. The receive side shall re-order the PDUs using the send sequence numbers as defined in clauses 14.2 and 14.3 according to the agreed class of operation. The receive side shall then search for SDU boundaries using the extended more bit as defined in clause 13.3.

A complete SDU shall be assumed to exist when the following conditions are satisfied:

- 1) two successive boundaries have been identified using the extended More bit (i.e. there are no intermediate boundaries);
- 2) PDUs have been successfully received for all of the sequence numbers that lie between those boundaries.

Depending on the delivery mode and the state of the sequence of received PDUs, the identified SDU may:

- be immediately passed to the IWU using a DL_U_DATA-ind primitive;
- wait for the possible completion and passing of previous SDUs in the sequence before being passed to the IWU.

The following delivery modes are supported by LU10.

11.12.3.2.1 Standard SDU delivery mode

This is the default mode and shall be used unless any of the others is specifically invoked in the interworking definition or in an application profile.

As soon as a complete SDU is identified as described in clause 11.12.3.2, it shall be passed to the user entity (typically the IWU) using a DL_U_DATA-ind primitive.

The complete SDU identified may be either, in the "In-sequence PDUs pending for delivery" or in the "out-of-sequence PDUs". See clause 14.3.4.2 for definitions.

NOTE: The standard delivery mode may not ensure the order of SDUs transmitted at one LU10 SAP, when they are delivered at the other end. This happens, for instance, with transmission Class 2, when there is one SDU with missing PDUs and the following SDU is completely received before the retransmission of the missing PDU comes. This behaviour is convenient for Internet and LAN Protocols where the possible violation of sequence is irrelevant. If the guarantee of sequence is necessary, the in-sequence SDU delivery mode may be used, or the sequence may be enforced by the Interworking layer. See for instance, DPRS (ETSI EN 301 649 [17], clause B.8).

11.12.3.2.2 In-sequence SDU delivery mode

This mode shall be specifically invoked in the interworking definition or in an application profile.

Only the complete SDUs identified in the "In-sequence PDUs pending for delivery" are immediately delivered to the user entity. SDUs identified in the "out-of-sequence" part of the window shall wait for possible reception of previous SDU before delivering. SDUs shall be always delivered in ascending order.

Complete SDU identified in "out-of-sequence" parts of the receiver window may become in-sequence, either by reception of missing PDUs, or by advancing of the window due to timing out (reception of a synchronization message).

NOTE 1: In the last case, there may be an interruption in the SDU sequence, but never a jump back.

NOTE 2: When there is an interruption in the SDU sequence, it is possible to identify a break in sequence, but it is not possible to determine how many SDUs are missing. If a complete control of the sequence is needed, then it is recommended the addition of sequence numbers by the IWU. See for instance DPRS (ETSI EN 301 649 [17], clause B.8).

In the case when several complete SDUs are created in the receiver at the same time (in the "In-sequence PDUs pending for delivery"), they shall be delivered in sequence.

NOTE 3: This case may happen by the reception of a retransmitted PDU binding together existing "out-of-sequence" SDUs with the "In-sequence PDUs pending for delivery".

11.12.3.2.3 PDU-in-sequence delivery mode

This mode shall be specifically invoked in the interworking definition or in an application profile.

In this mode, in-sequence received PDU are immediately delivered to the user entity without waiting for SDU boundaries. This mode is required when infinite size SDUs are used and is advisable with very large size SDUs.

In addition to the data delivery, the DLC shall provide information to the user entity on position of SDU boundaries, and on possible abnormal termination of SDUs. It is up to the user entity how to use these signals.

NOTE: The abnormal termination of SDU may happen either, due to incomplete reception of SDUs, and due to the reception of the abnormal termination signal. See clause 14.3.4.2.6.

11.12.3.2.4 PDU-as-received delivery mode

This mode shall be specifically invoked in the interworking definition or in an application profile.

In this mode, any received PDU is immediately delivered to the user entity without waiting for SDU boundaries, and independently on if the PDU is in or out of sequence.

This mode is compatible with infinite size and very large SDUs.

The DLC shall provide to the user entity information on position of SDU boundaries, on possible abnormal termination of SDUs, and on PDU sequence numbers. In this mode, LU10 is only in charge of the transmission procedure (including acknowledgements and retransmission requests), while the assembling of the SDU has to be performed by the user entity.

11.12.4 SDU boundaries definition

11.12.4.0 General

The SDU is intended to be equal to the packets supplied by the user entity of the DLC LU10 service. In most cases the user entity is a protocol Interworking layer (see ETSI EN 301 649 [17], annexes B and C). The SDU boundaries shall be placed as indicated in the interworking unit definition.

NOTE: The interworking unit may define SDU boundaries aligned with the higher layer protocol frames, datagrams or packets, may define a segmentation layer, or may add a PAD function.

If no special provision is given in the interworking unit definition, it shall be assumed that the SDU boundaries are aligned with the packet (frame, datagram, message, etc.) boundaries of the protocol transported over LU10.

11.12.4.1 Infinite SDU mode

This mode shall be specifically invoked in the interworking definition or in an application profile. Otherwise it is not allowed.

In this mode, it is possible the operation without SDU boundaries at all (as if the data to be transmitted were a continuous stream). The following specific provisions apply:

- All "M" bits are set to "1".

- The "PDU-in-sequence" (clause 11.12.3.2.3) or the "PDU-as-received" (clause 11.12.3.2.4) delivery modes shall be used.

NOTE: Length indicators will generally be coded with the maximum allowed size of the PDU. However, this is not required, and shorted values may be used in order to synchronize transmission. The insertion of the LI with LI="0", M="1" may be used as filling pattern, if needed.

11.12.5 Use over C/L downlink channels

11.12.5.0 General

Service LU10 may be used over C/L downlink channels in either unicast or multicast modes. The following provisions shall apply.

11.12.5.1 Use over C/L downlink channels: unicast mode

Unicast mode is defined as a service addressed to a single PT.

Unicast transmission using LU10 over C/L downlink channels is for further study.

11.12.5.2 Use over C/L downlink channels: multicast mode

11.12.5.2.0 General

Multicast mode is defined as a service addressed to a group of PT (including, as a particular case, to all registered PTs).

The following provisions shall apply:

- The instances of the LU10 service transported over C/L downlink channels shall be accessible by SAPs different from the SAPs used for the C/O service.
- There may be multiple instances of the service in a system (in general representing different groups of PTs) and a single PT may be subscribed to several instances.
- The same addressing defined at MAC layer (see ETSI EN 300 175-3 [3], clause 9.1.4.7.3) based on "X" and "Y" identifiers shall be used.
- A single uni-directional link using FU10a frame shall be used for each instance of the service.

11.12.5.2.1 DLC acknowledgement in multicast mode

DLC acknowledgement in multicast mode is for further study.

11.13 LU11 service

11.13.0 General

This clause defines the LU11 64 kbit/s bearer service specified for the DECT radio interface, when A and B field are both modulated at 4 level.

11.13.1 Physical layer service

The used physical packet is the full slot (Packet P64 with configuration 4a).

11.13.2 MAC layer service

The duplex unprotected normal delay MAC service with the B-field multiplex U64a shall be used. A symmetric single bearer MAC connection shall be used.

11.13.3 DLC layer service

LU11 provides a Forward Error Control (FEC) service. The BCH (700, 640) code shortened from BCH (1 023, 963) shall be used.

The frame format FU11 used in the LU11 service is defined in figure 11.13.3.1.

80 bytes	8 bytes
user data	(FEC)

Figure 11.13.3.1: FU11 frame structure

The BCH (700, 640) code provided by the FEC, may be used to correct errors within a 4 level full slot connection. The probability of erroneous block will be decreased to less than 10^{-5} with a BER of 10^{-3} .

If the error correction algorithm cannot correct the errors in a full slot, the LU11 service should transmit the received user data to the IWU with a FEC error indication.

11.14 LU12 UNprotected Framed service (UNF)

11.14.1 General

The LU12 service is a UNF service that is accessed through the LU12 SAP. It is designed to meet the special demands of speech transmission using a codec with a frame size greater than 10 ms. However, it can be also used for a non audio service requiring a segmentation with a fixed number of segments.

An unprotected MAC service (I_N service) shall be used with a symmetric single bearer MAC connection. Data integrity is not guaranteed. No error protection is applied, and octets may be lost, erroneous or duplicated.

11.14.2 DLC layer service

11.14.2.0 General

The LU12 shall operate on a generic field of user data that shall be transferred into and out of the DLC U-plane as a single SDU (Service Data Unit). In case of speech transmission, this SDU will be assumed to contain one external audio frame.

LU12 shall provide the following functions:

- segmentation of SDU into a fixed number of frames;
- frame transmission, using class 0.

To avoid possible confusion between external and internal frames the following wording is used in this clause from here onwards:

- "SDU" shall refer to the user data unit;
- "Code word" shall refer to the added code word data at the PDU head;
- "PDU" shall refer to the internal frames;
- "Segment" shall refer to the information content of one "PDU".

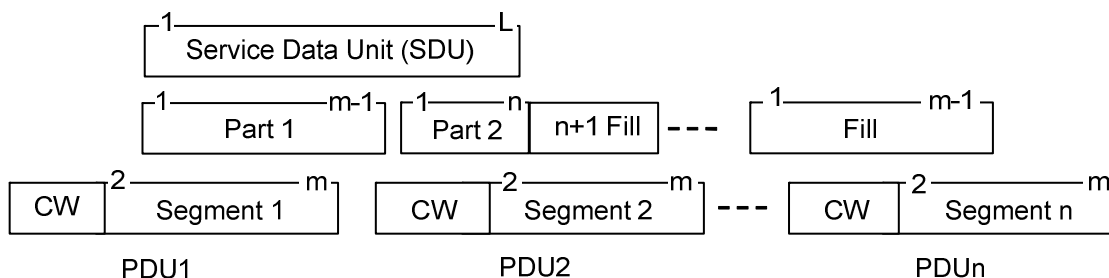

Figure 11.14.2.0.1: LU12 procedures

11.14.2.1 Segmentation

Segmentation is function of the size of the first SDU. The first SDU shall be segmented into n bits segments that are suitable for insertion into FU12 frames. If the last segment is smaller than a FU12 frame, further filling octets shall be added to this last segment to fill the last frame. The first segmentation fixes the number of segments that will be used during this connection.

In case of SDU with a variable size (e.g. speech transmission using a codec with a variable bit rate), the SDU shall be segmented into the same number of segments. Therefore, several segments can be filled with filling octets in case of variable SDU size (see figure 11.14.2.0.1).

The first octet of each FU12 frame is used to number the segments.

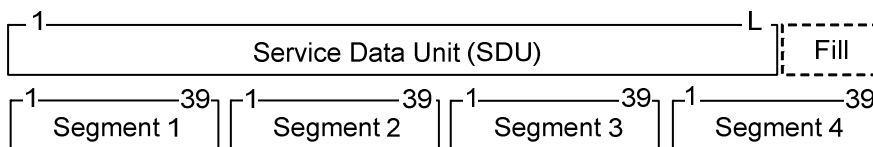

Figure 11.14.2.1.1: Example of segmentation in four full slot segments

The first octet of each PDU, also called Code word parameter, shall indicate the segment number of the SDU transported in the PDU and the SDU validity.

Bit	8	7	6	5	4	3	2	1	Octet
	PA	reserved		SN				BFI	1

Figure 11.14.2.1.2: Code word coding

Code word shall be coded as follows:

Bad Frame Indicator, BFI field (octet 1):

Table 11.14.2.1.1: Values of the Bad Frame Indicator (BFI) field

Bits	1	Meaning
	0	The user frame is valid
	1	The user frame is not valid

This bit indicates whether the current user frame is valid or not. In case of speech transmission, it may be set to 1 if an IP packet loss is detected in the FP, or if any other transmission problem has occurred which damages the integrity of the frame. It is not recommended to use it in the PP to FP direction.

Segment Number, SN field (octet 1):

Table 11.14.2.1.2: Values of the Segment Number (SN) field

Bits	5	4	3	2	Meaning
	0	0	0	0	1 st segment
	0	0	0	1	2 nd segment
	0	0	1	0	3 rd segment
	0	0	1	1	4 th segment
	0	1	0	0	5 th segment
	0	1	0	1	6 th segment
	0	1	1	0	7 th segment
	0	1	1	1	8 th segment
	1	0	0	0	9 th segment
	1	0	0	1	10 th segment
	1	0	1	0	11 th segment
	1	0	1	1	12 th segment
	1	1	0	0	13 th segment
	1	1	0	1	14 th segment
	1	1	1	0	15 th segment
	1	1	1	1	16 th segment

This field shall be used to signal which segment number is transported in the PDU.

PArity, PA field (octet 1):

The parity bit is used to protect the 5 bits of the SN and BFI fields of the code word. This bit shall be set to 1 if the number of ones in the 5 bits to protect is odd, otherwise it shall be set to 0. This always makes the total number of ones, including the parity bit, even.

11.14.2.2 Data transmission

11.14.2.2.1 Send side procedure

At the transmitting side a complete SDU shall be received in a DL_U_DATA-req primitive. The received SDU shall be passed to the segmenting function and segmented into a fixed number of segments according to the size of the first user frame. Segment shall be filled with fill octets if necessary to fit into FU12 frames. The remaining number of segments shall be marked using the code word as described in clause 11.14.2.1.

If the SDU is not valid at the application level, an indication shall be sent from the inter-working unit. This indication shall be used to set the Bad frame indicator and to fill all segments with fill octets.

The parity bit shall be then calculated. The parity bit provide an error detection capability for the Code word at the peer side but there shall be no mechanism for the retransmission of a PDU that is found with a Code word in error.

The resulting PDUs shall be transmitted in ascending order of sequence number (i.e. the lowest numbered segment shall be transmitted first), using the procedures defined in clause 14.3.2 for a class 0 transmission.

11.14.2.2.2 Receive side procedure

At the receiving side the parity bit shall be tested on each received PDU. If the parity bit passes, the receive side shall re-assemble the PDUs using the remaining segment information as defined in clause 11.14.2.1. The complete SDU shall be passed to the IWU using a DL_U_DATA-ind primitive.

An indication shall be issued to the inter-working unit for all PDUs that are received with a parity bit error or a Bad frame indicator set.

11.15 LU13 Enhanced Frame RELay service with CRC (EFREL-CRC)

11.15.1 General

The LU13 service is defined as a variant of the LU10 service with the addition of a 16 or 32 bit CRC at SDU level, providing additional residual error detection capability. All provisions, features and options defined for LU10 are applicable, with the exception of the infinite SDU mode as defined in clause 11.12.4.1 that is not possible.

LU13 service may operate in either transmission class 1 or class 2, in the late case with retransmission capability at PDU level.

LU13 provides only error detection at SDU level. No retransmission mechanisms at SDU level are provided.

The SDU format and procedures of LU13 are described in figure 11.15.1.1. The option of starting a new SDU in the same PDU that transports the final section of the previous one is not shown; however it is possible as defined for LU10.

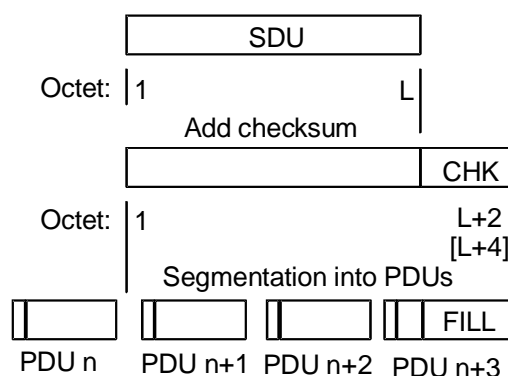

Figure 11.15.1.1: LU13 SDU procedures

11.15.2 SDU CRC generation

The CRC shall provide an error detection capability for the reassembled SDU (at the peer side) but there shall be no mechanism for the retransmission of a SDU that is found to be in error.

NOTE: The user should provide an external retransmission protocol, to protect against these infrequent erasures.

Two alternatives CRC are defined: a 16-bit checksum and a 32-bit CRC:

- The 16-bit checksum used shall be identical to the checksum used for the C-plane and defined in clauses 7.9 and 7.10 of the present document.
- The 32-bit CRC shall be identical to the B-CRC defined in ETSI EN 300 175-3 [3], clause 6.2.5.5.

Indication of which type of CRC is used, is done by means of the frame type and options field in the IE <<Call-Attributes>> (see ETSI EN 300 175-5 [5], clause 7.7.5).

11.15.3 Use over C/L downlink channels

11.15.3.0 General

Service LU13 may be used over C/L downlink channels in either unicast or multicast modes. The following provisions shall apply.

11.15.3.1 Use over C/L downlink channels: unicast mode

Unicast mode is defined as a service addressed to a single PT.

Unicast transmission using LU13 over C/L downlink channels is for further study.

11.15.3.2 Use over C/L downlink channels: multicast mode

11.15.3.2.0 General

Multicast mode is defined as a service addressed to a group of PT (including, as a particular case, to all registered PTs).

The following provisions shall apply:

- The instances of the LU13 service transported over C/L downlink channels shall be accessible by SAPs different from the SAPs used for the C/O service.
- There may be multiple instances of the service in a system (in general representing different groups of PTs) and a single PT may be subscribed to several instances.
- The same addressing defined at MAC layer (see ETSI EN 300 175-3 [3], clause 9.1.4.7.3) based on "X" and "Y" identifiers shall be used.
- A single uni-directional link using FU10a frame shall be used for each instance of the service.

11.15.3.2.1 DLC acknowledgement in multicast mode

DLC acknowledgement in multicast mode is for further study.

11.16 LU14 Enhanced Frame RELay service with CCM (EFREL-CCM)

11.16.1 General

The LU14 service is defined as a variant of the LU10 service with the addition of a security layer based on CCM (Counter with CBC-MAC), as defined by ETSI EN 300 175-7 [7] and based on IETF RFC 3610 [19].

The CCM layer provides encryption and packet authentication. The DECT implementation of CCM is fully compliant with IETF RFC 3610 [19], and uses Advanced Encryption Standard (AES) [18] as block cipher with block size 128 bits.

All provisions, features and options of LU10 are applicable, with the exception of the limitations given in clause 11.16.2.4.

11.16.2 LU14 SDU structure

11.16.2.0 General

The LU14 SDU structure and format are described in figure 11.16.2.0.1.

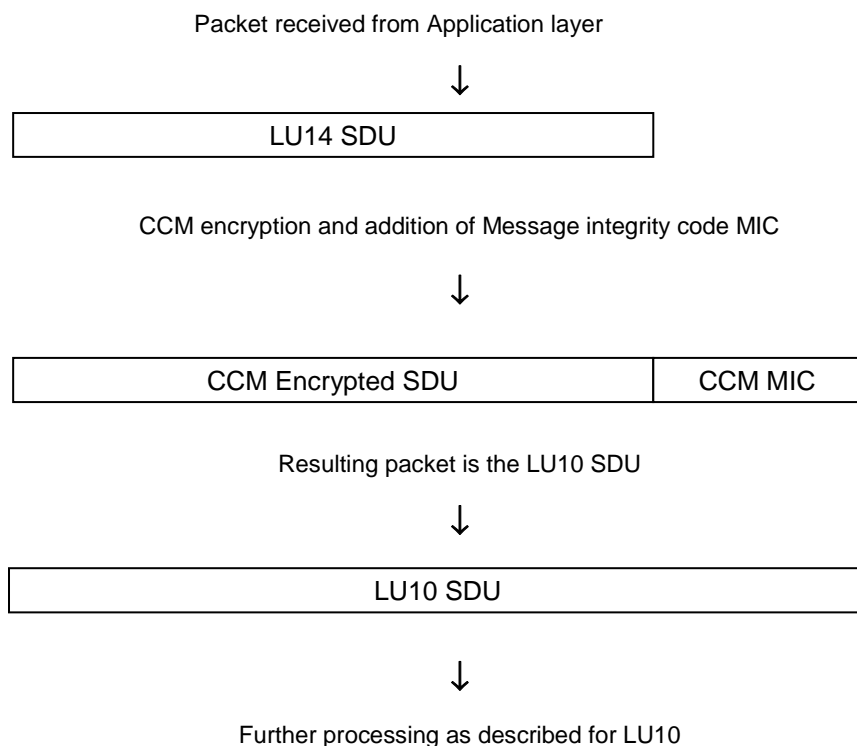

Figure 11.16.2.0.1: LU14 SDU procedures

11.16.2.1 SDU sizes

The minimum size for a LU14 SDU is 1 byte. The maximum SDU size is $2^{16} - 1$ bytes = 65 535 bytes. SDU size should be a multiple of 8 bits.

The added MIC (Message integrity code) has 32 bits.

11.16.2.2 Security model

The cryptographic model of LU14 are defined in ETSI EN 300 175-7 [7] clause 6.6. The detailed algorithm is provided in ETSI EN 300 175-7 [7] annex N.

For the purposes of the present document, the security model of CCM can be summarized as described in figure 11.16.2.2.1.

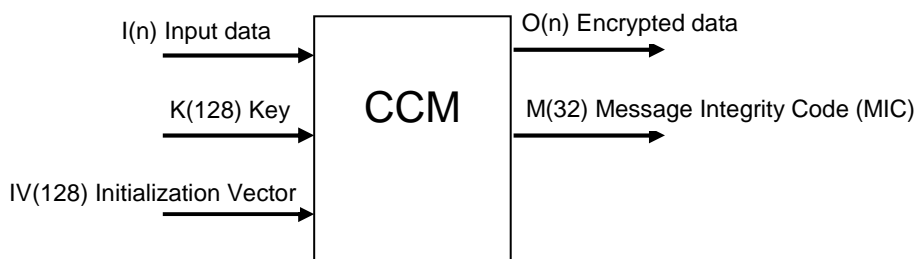

Figure 11.16.2.2.1: LU14 Security model

All security specifications, such as the composition and generation of the IV (Initialization Vector) and the Key management are also described in ETSI EN 300 175-7 [7] clause 6.6 and others.

11.16.2.3 SDU processing

The packet received from higher layers is the LU14 SDU. LU14 SDU is encrypted using the CCM process as described in ETSI EN 300 175-7 [7] (clause 6.6 and others). The 32 bit MIC is generated by the same process and shall be added at the end of the encrypted SDU. The whole structure is sent to the LU10 SAP for further processing.

The size of the LU10 SDU is equal to size of the LU14 SDU plus 32 bits.

All other properties and options of LU10 apply, except the limitations described in the next clause 11.16.2.4.

At the receiver side, the LU14 SDU shall be CCM decoded as described in ETSI EN 300 175-7 [7] (clause 6.6 and annex N). The MIC shall be computed from the decoded message, IV and Key using the CCM process and the resulting value shall be compared with the MIC received at the end of the LU10 SDU. Only if the MIC is correct, the LU14 SDU shall be delivered to higher layers. If the MIC is incorrect, the LU14 SDU shall be discarded and an error notification may be sent to higher layers.

11.16.2.4 Limitations

The following limitations compared to LU10 apply:

- It is not possible the operation with infinite size SDUs. Maximum SDU size shall be as described in clause 11.16.2.1.

By cryptographic reasons the following additional limitations apply:

- Standard delivery mode shall be used.
- If the MIC part of the message is not decoded and checked without errors, then the unencrypted LU14 SDU should not be revealed.
- Only one SDU may start in the same PDU. The maximum number of SDUs that may be carried in a PDU is two, and this is only possible if the first SDU has started in a previous PDU.
- The Key used by CCM should be changed if the CCM sequence number (see clause 11.16.2.5) is re-started.
- LU14 requires the existence of a NWK layer C-plane with at least MM entity in order to properly generate the CCM Keys.
- The operation of multiple instances of LU14 is for further study.

11.16.2.5 CCM sequence numbers

The CCM uses a 48 bit sequence number that reuses, as least significant bits, the Sending Sequence Number used by the DLC transmission protocol (DLC SN). This is explained in ETSI EN 300 175-7 [7], clause 6.6.2.4. The number of bits that are transmitted depends of the DLC service and frame type. The remaining bits are implicit, not transmitted, and should be known by both peers. The implicit part of the CCM sequence number is increased every time the DLC SN overflows.

When a LU14 service instance is created (link creation), both the CCM and the DLC sequence numbers are set to "0".

The CCM sequence number is used in the computation of the CCM Initialization Vector (see ETSI EN 300 175-7 [7], clause 6.6.2.3).

11.16.2.6 CCM control procedures

The CCM control procedures are described in ETSI EN 300 175-7 [7]. Such procedures are based on DECT NWK layer MM and CC and MAC layer control procedures.

11.16.3 Use over C/L downlink channels

11.16.3.0 General

Service LU14 may be used over C/L downlink channels in either unicast or multicast modes. The following provisions shall apply.

11.16.3.1 Use over C/L downlink channels: unicast mode

Unicast mode is defined as a service addressed to a single PT.

Unicast transmission using LU14 over C/L downlink channels is for further study.

11.16.3.2 Use over C/L downlink channels: multicast mode

11.16.3.2.0 General

Multicast mode is defined as a service addressed to a group of PT (including, as a particular case, to all registered PTs).

The following provisions shall apply:

- The instances of the LU14 service transported over C/L downlink channels shall be accessible by SAPs different from the SAPs used for the C/O service.
- There may be multiple instances of the service in a system (in general representing different groups of PTs) and a single PT may be subscribed to several instances.
- The same addressing defined at MAC layer (see ETSI EN 300 175-3 [3], clause 9.1.4.7.3) based on "X" and "Y" identifiers shall be used.
- A single uni-directional link using FU10a frame shall be used for each instance of the service.
- CCM encryption of the multicast link shall be used. The cryptographic procedures given in ETSI EN 300 175-7 [7], clause 6.6.2.7 shall be used for the CCM encryption of multicast channels.

11.16.3.2.1 DLC acknowledgement in multicast mode

DLC acknowledgement in multicast mode is for further study.

12 Frame structures for U-plane services

12.1 General

The following frame structures are defined for the U-plane services in this clause.

Table 12.1.1: U-plane frame structures

Frame	Link Arrangement	Address	Length	Sequencing
FU1	Bi/unidirectional	No	No	No
FU2	Bi/unidirectional	Yes	Yes	No
FU3	Bi/unidirectional	No	No	Yes
FU4	Bi/unidirectional	No	Yes	Yes
FU5	Bi/unidirectional	Yes	Yes	Yes
FU6	Unidirectional only	No	Yes	Yes
FU10	Bi/unidirectional	No	Yes	Yes

The FU1 frame is designed to meet the special requirements of speech, in particular the capability for introducing minimum delay between the higher layers and the MAC layer. FU1 can also be used for more general data use. In all cases, the actual delay is defined by the MAC layer.

The FU2 frame provides observable frame delimiting that can be used to preserve frame boundaries in the data. FU2 also provides addressing to allow for multiple independent links.

The FU3 frame provides send and receive sequence numbering for error protection and flow control.

The FU4 frame provides observable frame delimiting plus send and receive sequence numbering for error protection. This provides higher efficiency than FU5 when addressing is not required.

The FU5 frame provides observable frame delimiting plus send and receive sequence numbering for error protection and flow control. FU5 also provides addressing.

The FU6 frame provides observable frame delimiting plus send sequence numbers for error protection and flow control. This is designed to offer higher efficiency with unidirectional links.

The FU10a frame provides observable frame delimiting plus send sequence numbers for error protection and flow control. This frame is used jointly with frame types FU10c or FU10d in the reverse link. FU10a is designed to offer higher efficiency with unidirectional links.

The FU10b frame provides observable frame delimiting plus send and receive sequence numbering for error protection. This is designed to offer higher efficiency with symmetric bi-directional links.

12.2 FU1 frame structure

12.2.1 General frame structure

The FU1 frame is a fixed length fragmentation.

Bit	8	7	6	5	4	3	2	1	Octet
	Higher layer info								1
	Higher layer info								2
	Higher layer info								3

	Higher layer info								FU1N-1
	Higher layer info								FU1N

Figure 12.2.1.1: Frame Format Type FU1

FU1N is a function of the underlying connection type.

Table 12.2.1.1: FU1 connection types

Connection Type	Slot Type	FU1N				
		2 level	4 level	8 level	16 level	64 level
I_{NA} min delay	half slot (j=80)	10 octets	20 octets	30 octets	40 octets	60 octets
I_{NB} normal delay	half slot (j=80)	10 octets	20 octets	30 octets	40 octets	60 octets
I_{PM} error detect	half slot (j=80)	8 octets	16 octets	24 octets	32 octets	48 octets
I_{PMR} error correct	half slot (j=80)	8 octets	16 octets	24 octets	32 octets	48 octets
I_{PX} encoded protected (see note)	half slot (j=80)	$(10 \times r)$ octets	$(20 \times r)$ octets	$(30 \times r)$ octets	$(40 \times r)$ octets	$(60 \times r)$ octets
I_{NA} min delay	Long slot (j=640)	80 octets	160 octets	240 octets	320 octets	480 octets
I_{NB} normal delay	Long slot (j=640)	80 octets	160 octets	240 octets	320 octets	480 octets
I_{PM} error detect	Long slot (j=640/672)	64 octets	128 octets	192 octets	256 octets	384 octets
I_{PMR} error correct	Long slot (j=640/672)	64 octets	128 octets	192 octets	256 octets	384 octets
I_{PQ} error detect	Long slot (j=640)	76 octets	156 octets	236 octets	316 octets	476 octets
I_{PQR} error correct	Long slot (j=640)	76 octets	156 octets	236 octets	316 octets	476 octets
I_{PK} error detect	Long slot (j=640)	76 octets	152 octets	228 octets	304 octets	456 octets
I_{PKR} error correct	Long slot (j=640)	76 octets	152 octets	228 octets	304 octets	456 octets
I_{PX} encoded protected (see note)	Long slot (j=640)	$(80 \times r)$ octets	$(160 \times r)$ octets	$(240 \times r)$ octets	$(320 \times r)$ octets	$(480 \times r)$ octets
I_{NA} min delay	Long slot (j=672)	84 octets	168 octets	252 octets	336 octets	504 octets
I_{NB} normal delay	Long slot (j=672)	84 octets	168 octets	252 octets	336 octets	504 octets
I_{PQ} error detect	Long slot (j=672)	80 octets	164 octets	248 octets	332 octets	500 octets

Connection Type	Slot Type	FU1N				
		2 level	4 level	8 level	16 level	64 level
I_{PQR} error correct	Long slot (j=672)	80 octets	164 octets	248 octets	332 octets	500 octets
I_{PK} error detect	Long slot (j=672)	80 octets	160 octets	240 octets	320 octets	480 octets
I_{PKR} error correct	Long slot (j=672)	80 octets	160 octets	240 octets	320 octets	480 octets
I_{NA} min delay	Full slot	40 octets	80 octets	120 octets	160 octets	240 octets
I_{NB} normal delay	Full slot	40 octets	80 octets	120 octets	160 octets	240 octets
I_{PM} error detect	Full slot	32 octets	64 octets	96 octets	128 octets	192 octets
I_{PMR} error correct	Full slot	32 octets	64 octets	96 octets	128 octets	192 octets
I_{PQ} error detect	Full slot	38 octets	76 octets	116 octets	156 octets	236 octets
I_{PQR} error correct	Full slot	38 octets	76 octets	116 octets	156 octets	236 octets
I_{PK} error detect	Full slot	38 octets	76 octets	114 octets	152 octets	228 octets
I_{PKR} error correct	Full slot	38 octets	76 octets	114 octets	152 octets	228 octets
I_{PX} encoded protected (see note)	Full slot	$(40 \times r)$ octets	$(80 \times r)$ octets	$(120 \times r)$ octets	$(160 \times r)$ octets	$(240 \times r)$ octets
I_{NA} min delay	Double slot	100 octets	200 octets	300 octets	400 octets	600 octets
I_{NB} normal delay	Double slot	100 octets	200 octets	300 octets	400 octets	600 octets
I_{PM} error detect	Double slot	80 octets	160 octets	240 octets	320 octets	480 octets
I_{PMR} error correct	Double slot	80 octets	160 octets	240 octets	320 octets	480 octets
I_{PQ} error detect	Double slot	96 octets	196 octets	296 octets	396 octets	596 octets
I_{PQR} error correct	Double slot	96 octets	196 octets	296 octets	396 octets	596 octets
I_{PK} error detect	Double slot	96 octets	192 octets	288 octets	384 octets	576 octets
I_{PKR} error correct	Double slot	96 octets	192 octets	288 octets	384 octets	576 octets
I_{PX} encoded protected (see note)	Double slot	$(100 \times r)$ octets	$(200 \times r)$ octets	$(300 \times r)$ octets	$(400 \times r)$ octets	$(600 \times r)$ octets

NOTE: The encoded protected format is defined in ETSI EN 300 175-3 [3]. The adaptive code rate r is negotiated at the MAC layer and send to the DLC via the MAC_MOD primitive.

Other connection types are for further study.

12.2.2 FU1 buffering procedures

The FB_N or FB_P entity shall be used to provide a data buffering function between the service user and the MAC layer. It shall be required to supply data to the MAC layer (at the transmit side) or accept data from the MAC layer (at the receive side) on demand and with minimum delay.

NOTE 1: Normal data delivery will be periodic, with frames demanded and delivered at the TDMA frame rate.

Transmit side: on receipt of a MAC_CO_DTR-ind primitive, one complete frame of data shall be submitted to the MAC layer in a MAC_CO_DATA-req primitive.

Receive side: each MAC_CO_DATA-ind primitive shall contain one complete frame of data from the MAC layer.

Data overflow: in the event of data overflow, octets should be deleted, starting with the oldest non-transmitted octet.

Data underflow: in the event of data underflow, selected octets should be repeated in a manner that preserves the data order.

NOTE 2: This overwriting/underfilling function is added to cover the case of slight clock differences. For most applications, where the PT bit clock is fully synchronized to the FT clock and is sufficiently stable, there should be no duplication or loss of data within the DECT network.

12.2.3 Minimum delay (speech) operation

For speech services, each FU1 frames should deliver the most recent data to the MAC layer so that the speech delay requirements specified in ETSI EN 300 175-8 [8] can be met. The transmitted contents of each frame are therefore dependant the exact time that the data is needed by the MAC layer (i.e. on the slot position in use by the MAC layer).

NOTE: One possible speech implementation would be to use a rotating buffer to contain the FU1 frame. A single pointer then serves to mark the start of the frame. New input data is added above this pointer, and the (en-bloc) frame output to the MAC layer is taken below the pointer.

12.2.4 Connection handover

During connection handover, FU1 frames may be sent simultaneously to both the old and the new connections. The receive path is then switched to the new connection as soon as the new connection is indicated to be in the "open" state.

NOTE: In general the FU1 frames on the old and new connections will have different contents, due to the different slot positions used by these connections. Dependent upon the exact implementation of both FT and PT, seamless connection handover should still be possible.

12.2.5 Transmission order

The physical transmission order shall be controlled by the MAC layer as defined in ETSI EN 300 175-3 [3]. This MAC layer ordering shall use the octet numbering and bit numbering shown above.

The operations across the DLC layer/MAC layer boundary shall be such that the DLC entity sending a frame can assume this temporal order of the frame, and that the entity receiving the frame can reconstruct it with its assumed temporal order.

In all cases, the order of arrival of the higher layer information shall be preserved, and this shall be identical to the order of transmission.

12.3 FU2 frame structure

12.3.1 General frame structure

FU2 is a fixed length frame. The total frame length shall always be equal to the segment size of the I_p logical channel.

Bit	8	7	6	5	4	3	2	1	Octet
Address field									1
Length indicator field									2
Length indicator field (additional byte)									(2a)
									3 (4)
...								
Information field								
									LI + 2 (LI + 3)
									LI + 3 (LI + 4)
Fill field								
									FU2N

Figure 12.3.1.1: Frame Format Type FU2

For D160 and D240 slot formats, the length indicator is 2 bytes long. Octet 2a shall only be used for these slot formats.

FU2N is a function of the underlying connection type.

Table 12.3.1.1: FU2 connection types

Connection Type	Slot Type	FU2N		
		2 level	4 level	8 level
I_{PM} error detect	half slot (j=80)	8 octets	16 octets	24 octets
I_{PMR} error correct	half slot (j=80)	8 octets	16 octets	24 octets
I_{PM} error detect	Long slot (j=640/672)	64 octets	128 octets	192 octets
I_{PMR} error correct	Long slot (j=640/672)	64 octets	128 octets	192 octets
I_{PM} error detect	Full slot	32 octets	64 octets	96 octets
I_{PMR} error correct	Full slot	32 octets	64 octets	96 octets
I_{PM} error detect	Double slot	80 octets	160 octets	240 octets
I_{PMR} error correct	Double slot	80 octets	160 octets	240 octets

Other connection types are for further study.

12.3.2 FU2 buffering procedures

The FB_p -frame buffering entity shall be used to provide the data buffering function, and is required to supply data (at the transmit side) or accept data (at the receive side) on demand and with minimum delay.

Transmit side: on receipt of a MAC_CO_DTR-ind primitive, one complete frame of data shall be submitted to the MAC layer in a MAC_CO_DATA-req primitive.

Receive side: each MAC_CO_DATA-ind primitive shall contain one complete frame of data from the MAC layer.

In all cases, the order of arrival of the higher layer information shall be preserved, and this shall be identical to the order of transmission.

12.3.3 Connection handover

During connection handover, FU2 frames should be duplicated and sent simultaneously to both the old and the new connections. The receive path is then switched to the new connection as soon as the new connection is fully established.

NOTE: Duplicate FU2 frames on the old and new connections will have identical contents.

12.3.4 Transmission order

The physical transmission order is controlled by the MAC layer as defined in ETSI EN 300 175-3 [3]. This MAC layer ordering shall use the octet numbering and bit numbering shown above.

The operations across the DLC layer/MAC layer boundary shall be such that the DLC entity sending a frame can assume this temporal order of the frame, and that the entity receiving the frame can reconstruct it with its assumed temporal order.

12.4 FU3 frame structure

12.4.1 General frame structure

FU3 defines two fixed length frames. The total frame length shall always be equal to the segment size of the appropriate logical channel, as detailed in figures 12.4.1.1 and 12.4.1.2.

Bit	8	7	6	5	4	3	2	1	Octet
	Send sequence number								1
	Receive sequence number								2
									3
	Information field								
									FU3N

Figure 12.4.1.1: Frame format type FU3a

Bit	8	7	6	5	4	3	2	1	Octet
	#1 Receive sequence number								1
	#2 Receive sequence number								2

	#7 Receive sequence number								7

Figure 12.4.1.2: Frame format type FU3b

Frame type FU3a is used for bidirectional links, and for the forward path of unidirectional links. It uses the I_p logical channel, with segment sizes as given below.

Frame type FU3b is used for the backward (control) path of unidirectional links. Type FU3b contains a list of receive sequence numbers for the forward link. It uses the G_F logical channel, with a fixed fragment size of 7 octets.

FU3N is a function of the underlying connection type.

Table 12.4.1.1: FU3 connection types

Connection Type	Slot Type	FU3N		
		2 level	4 level	8 level
I_{PM} error detect	half slot ($j=80$)	8 octets	16 octets	24 octets
I_{PMR} error correct	half slot ($j=80$)	8 octets	16 octets	24 octets
I_{PM} error detect	Long slot ($j=640/672$)	64 octets	128 octets	192 octets
I_{PMR} error correct	Long slot ($j=640/672$)	64 octets	128 octets	192 octets
I_{PM} error detect	Full slot	32 octets	64 octets	96 octets
I_{PMR} error correct	Full slot	32 octets	64 octets	96 octets
I_{PM} error detect	Double slot	80 octets	160 octets	240 octets
I_{PMR} error correct	Double slot	80 octets	160 octets	240 octets

Other connection types are for further study.

12.4.2 FU3 buffering procedures

The FB_p -frame buffering entity shall be used to provide a data buffering function, and is required to supply data (at the transmit side) or accept data (at the receive side) on demand and with minimum delay.

Transmit side: on receipt of a MAC_CO_DTR -ind primitive, one complete frame of data shall be submitted to the MAC layer in a MAC_CO_DATA -req primitive.

Receive side: each MAC_CO_DATA -ind primitive shall contain one complete frame of data from the MAC layer.

In all cases, the order of arrival of the higher layer information shall be preserved, and this shall be identical to the order of transmission.

12.4.3 Connection handover

During connection handover, FU3a frames shall be sent simultaneously to both the old and the new connections. The receive path is then switched to the new connection as soon as the new connection is fully established.

NOTE: Duplicate FU3a frames on the old and new connections will have identical contents.

12.4.4 Transmission order

The physical transmission order is controlled by the MAC layer as defined in ETSI EN 300 175-3 [3]. This MAC layer ordering shall use the octet numbering and bit numbering shown above.

The operations across the DLC layer/MAC layer boundary shall be such that the DLC entity sending a frame can assume this temporal order of the frame, and that the entity receiving the frame can reconstruct it with its assumed temporal order.

12.5 FU4 frame structure

12.5.1 General frame structure

FU4 defines two fixed length frames. The total frame length shall always be equal to the segment size of the appropriate logical channel as detailed in figures 12.5.1.1 and 12.5.1.2.

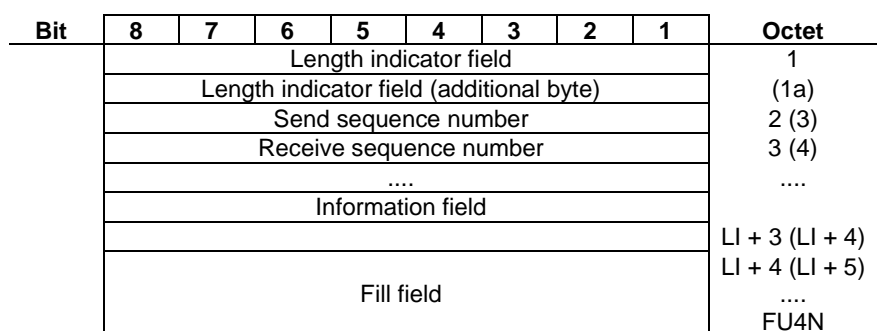

Figure 12.5.1.1: Frame format type FU4a

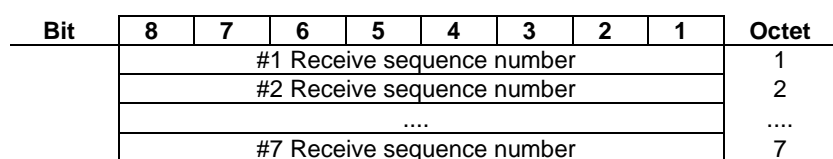

Figure 12.5.1.2: Frame format type FU4b

Frame type FU4a is used for bi-directional links, and for the forward path of unidirectional links. It shall use the I_p logical channel, with segment sizes as given in table 12.5.1.1.

Frame type FU4b is used for the backward (control) path of unidirectional links. Type FU4b contains a list of receive sequence numbers for all of the forward links. It shall use the G_F logical channel, with a fixed fragment size of 7 octets.

For D160 and D240 slot formats, the length indicator is 2 bytes long. Octet 1a shall only be used for these slot formats.

FU4N is a function of the underlying connection type.

Table 12.5.1.1: FU4 connection types

Connection Type	Slot Type	FU4N		
		2 level	4 level	8 level
I_{PM} error detect	half slot (j=80)	8 octets	16 octets	24 octets
I_{PMR} error correct	half slot (j=80)	8 octets	16 octets	24 octets
I_{PM} error detect	Long slot (j=640/672)	64 octets	128 octets	192 octets
I_{PMR} error correct	Long slot (j=640/672)	64 octets	128 octets	192 octets
I_{PM} error detect	Full slot	32 octets	64 octets	96 octets
I_{PMR} error correct	Full slot	32 octets	64 octets	96 octets
I_{PM} error detect	Double slot	80 octets	160 octets	240 octets
I_{PMR} error correct	Double slot	80 octets	160 octets	240 octets

Other connection types are for further study.

12.5.2 FU4 buffering procedures

The FB_p -frame buffering entity shall be used to provide a data buffering function, and is required to supply data (at the transmit side) or accept data (at the receive side) on demand and with minimum delay.

Transmit side: on receipt of a MAC_CO_DTR -ind primitive, one complete frame of data shall be submitted to the MAC layer in a MAC_CO_DATA -req primitive.

Receive side: each MAC_CO_DATA -ind primitive shall contain one complete frame of data from the MAC layer.

In all cases, the order of arrival of the higher layer information shall be preserved, and this shall be identical to the order of transmission.

12.5.3 Connection handover

During connection handover, FU4a frames should be sent simultaneously to both the old and the new connections. The receive path is then switched to the new connection as soon as the new connection is fully established.

NOTE: Duplicate FU4a frames on the old and new connections will have identical contents.

12.5.4 Transmission order

The physical transmission order is controlled by the MAC layer as defined in ETSI EN 300 175-3 [3]. This MAC layer ordering shall use the octet numbering and bit numbering shown above.

The operations across the DLC layer/MAC layer boundary shall be such that the DLC entity sending a frame can assume this temporal order of the frame, and that the entity receiving the frame can reconstruct it with its assumed temporal order.

12.6 FU5 frame structure

12.6.1 General frame structure

FU5 defines two fixed length frames. The total frame length shall always be equal to the segment size of the appropriate logical channel as detailed in figures 12.6.1.1 and 12.6.1.2.

Bit	8	7	6	5	4	3	2	1	Octet
Address field									1
Length indicator field									2
Length indicator field (additional byte)									(2a)
Send sequence number									3 (4)
Receive sequence number									4 (5)
									5 (6)
Information field								
									LI + 4 (LI + 5)
Fill field									LI + 5 (LI + 5)
								
									FU5N

Figure 12.6.1.1: Frame format type FU5a

Bit	8	7	6	5	4	3	2	1	Octet
Address field									1
#1 Receive sequence number									2
#2 Receive sequence number									3
....								
#6 Receive sequence number									7

Figure 12.6.1.2: Frame format type FU5b

Frame type FU5a is used for bi-directional links, and for the forward path of unidirectional links. It shall use the I_p logical channel, with segment sizes as given in table 12.6.1.1.

Frame type FU5b is used for the backward (control) path of unidirectional links. Type FU5b contains a list of receive sequence numbers for all of the forward links. It shall use the G_F logical channel, with a fixed fragment size of 7 octets.

For D160 and D240 slot formats, the length indicator is 2 bytes long. Octet 2a shall only be used for these slot formats.

FU5N is a function of the underlying connection type.

Table 12.6.1.1: FU5 connection types

Connection Type	Slot Type	FU5N		
		2 level	4 level	8 level
I_{PM} error detect	half slot ($j=80$)	8 octets	16 octets	24 octets
I_{PMR} error correct	half slot ($j=80$)	8 octets	16 octets	24 octets
I_{PM} error detect	Long slot ($j=640/672$)	64 octets	128 octets	192 octets
I_{PMR} error correct	Long slot ($j=640/672$)	64 octets	128 octets	192 octets
I_{PM} error detect	Full slot	32 octets	64 octets	96 octets
I_{PMR} error correct	Full slot	32 octets	64 octets	96 octets
I_{PM} error detect	Double slot	80 octets	160 octets	240 octets
I_{PMR} error correct	Double slot	80 octets	160 octets	240 octets

Other connection types are for further study.

12.6.2 FU5 buffering procedures

The FB_p -frame buffering entity shall be used to provide a data buffering function, and is required to supply data (at the transmit side) or accept data (at the receive side) on demand and with minimum delay.

Transmit side: on receipt of a MAC_CO_DTR-ind primitive, one complete frame of data shall be submitted to the MAC layer in a MAC_CO_DATA-req primitive.

Receive side: each MAC_CO_DATA-ind primitive shall contain one complete frame of data from the MAC layer.

In all cases, the order of arrival of the higher layer information shall be preserved, and this shall be identical to the order of transmission.

12.6.3 Connection handover

During connection handover, FU5a frames should be sent simultaneously to both the old and the new connections. The receive path is then switched to the new connection as soon as the new connection is fully established.

NOTE: Duplicate FU5a frames on the old and new connections will have identical contents.

12.6.4 Transmission order

The physical transmission order is controlled by the MAC layer as defined in ETSI EN 300 175-3 [3]. This MAC layer ordering shall use the octet numbering and bit numbering shown above.

The operations across the DLC layer/MAC layer boundary shall be such that the DLC entity sending a frame can assume this temporal order of the frame, and that the entity receiving the frame can reconstruct it with its assumed temporal order.

12.7 FU6 frame structure

12.7.1 General frame structure

FU6 defines two fixed length frames. The total frame length shall always be equal to the segment size of the appropriate logical channel as detailed in figures 12.7.1.1 and 12.7.1.2.

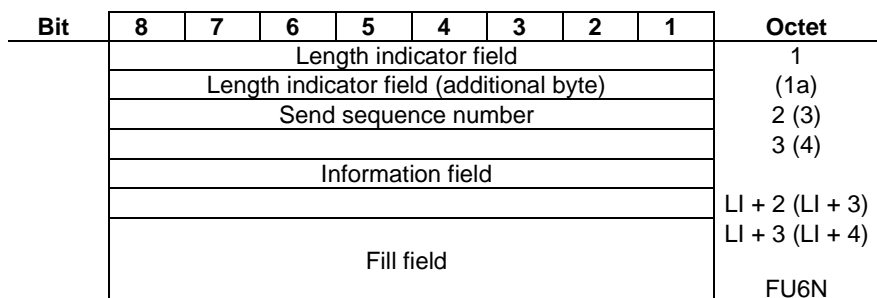

Figure 12.7.1.1: Frame format type FU6a

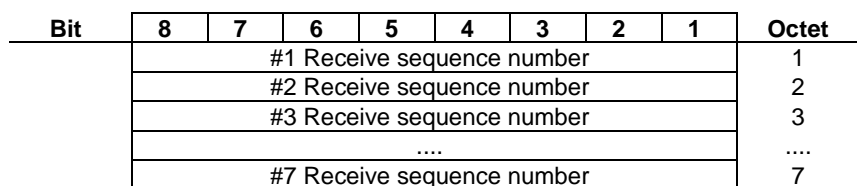

Figure 12.7.1.2: Frame format type FU6b

Frame type FU6a is used for the forward path of unidirectional links. It shall use the I_P logical channel, with segment sizes as given in table 12.7.1.1.

Frame type FU6b is used for the backward (control) path of unidirectional links. Type FU6b contains a list of receive sequence numbers for the forward link. It shall use the G_F logical channel, with a fixed fragment size of 7 octets.

For D160 and D240 slot formats, the length indicator is 2 bytes long. Octet 2a shall only be used for these slot formats.

FU6N is a function of the underlying connection type.

Table 12.7.1.1: FU6 connection types

Connection Type	Slot Type	FU6N		
		2 level	4 level	8 level
I _{PM} error detect	half slot (j=80)	8 octets	16 octets	24 octets
I _{PMR} error correct	half slot (j=80)	8 octets	16 octets	24 octets
I _{PM} error detect	Long slot (j=640/672)	64 octets	128 octets	192 octets
I _{PMR} error correct	Long slot (j=640/672)	64 octets	128 octets	192 octets
I _{PM} error detect	Full slot	32 octets	64 octets	96 octets
I _{PMR} error correct	Full slot	32 octets	64 octets	96 octets
I _{PM} error detect	Double slot	80 octets	160 octets	240 octets
I _{PMR} error correct	Double slot	80 octets	160 octets	240 octets

Other connection types are for further study.

12.7.2 FU6 buffering procedures

The FB_p-frame buffering entity shall be used to provide a data buffering function, and is required to supply data (at the transmit side) or accept data (at the receive side) on demand and with minimum delay.

Transmit side: on receipt of a MAC_CO_DTR-ind primitive, one complete frame of data shall be submitted to the MAC layer in a MAC_CO_DATA-req primitive.

Receive side: each MAC_CO_DATA-ind primitive shall contain one complete frame of data from the MAC layer.

In all cases, the order of arrival of the higher layer information shall be preserved, and this shall be identical to the order of transmission.

12.7.3 Connection handover

During connection handover, FU6a frames should be sent simultaneously to both the old and the new connections. The receive path is then switched to the new connection as soon as the new connection is fully established.

NOTE: Duplicate FU6a frames on the old and new connections will have identical contents.

12.7.4 Transmission order

The physical transmission order is controlled by the MAC layer as defined in ETSI EN 300 175-3 [3]. This MAC layer ordering shall use the octet numbering and bit numbering shown above.

The operations across the DLC layer/MAC layer boundary shall be such that the DLC entity sending a frame can assume this temporal order of the frame, and that the entity receiving the frame can reconstruct it with its assumed temporal order.

12.8 FU7 frame structure

The FU7 frame structure is specified in clause 11.9.

12.9 FU8 frame structure

The FU8 frame structure is specified in clause 11.10.

12.10 FU9 frame structure

The FU9 frame structure is specified in clause 11.11.

12.11 FU10 frame structure

12.11.1 General frame structure

12.11.1.0 General

FU10 defines three fixed length frames. The total frame length shall always be equal to the segment size of the appropriate logical channel as detailed in figures 12.11.1.0.1 to 12.11.1.0.3.

Bit	8	7	6	5	4	3	2	1	Octet
	Send Sequence number, bits ES8 – ES1								1
	ES9	1st Length of information field						M	2
	1 st Information field								
	2 nd Length indicator octet								L1 + 3
	2 nd Information field								L1 + 4
	...								
	i th Length indicator octet								
	i th Information field								
	(i th + 1) Length indicator octet (Length = 0, M = 0)								
	Fill								

Figure 12.11.1.0.1: Frame format type FU10a

Bit	8	7	6	5	4	3	2	1	Octet
	Send Sequence number								1
	Receive Sequence number								2
	ACK/N ACK	1st Length of information field						M	3
	1 st Information field								
	2 nd Length indicator octet								L1 + 3
	2 nd Information field								L1 + 5
	...								
	i th Length indicator octet								
	i th Information field								
	(i th + 1) Length indicator octet (Length = 0, M = 0)								
	Fill								

Figure 12.11.1.0.2: Frame format type FU10b

Bit	8	7	6	5	4	3	2	1	Octet
	RSN # 1, ER8 - ER1								1
	RSN # 2, ER8 - ER1								2
	RSN # 3, ER8 - ER1								3
	RSN # 4, ER8 - ER1								4
	RSN # 5, ER8 - ER1								5
	RSN # 6, ER8 - ER1								6
	NA1	NA2	RSN #6, ER9	RSN #5 ER9	RSN #4 ER9	RSN #3 ER9	RSN #2 ER9	RSN #1 ER9	7

Figure 12.11.1.0.3: Frame format type FU10c

Bit	8	7	6	5	4	3	2	1	Octet
	RSN, ER8 - ER1								1
	RSN ER9	ACK/ NACK	spare						2

Figure 12.11.1.0.4: Frame format type FU10d, full format

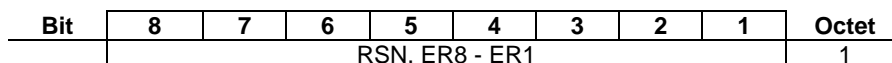

Figure 12.11.1.0.5: Frame format type FU10d, shortened format

NOTE: For meaning of the NA1 and NA2 bits in frame type FU10c: see clause 14.3.4.2.

Frame type FU10a is used for uni-directional links. It shall use the I_P logical channel, with segment sizes as given in table 12.11.1.0.1.

Two uni-directional links using FU10a may be combined to create a bi-directional link. A single uni-directional link may also be used over C/L downlink channels.

Frame type FU10b is used for bi-directional links, and for the forward path of unidirectional links. It shall use the I_P logical channel, with segment sizes as given in table 12.11.1.0.1.

Frame type FU10c is used for the backward (control) path of unidirectional links. Type FU10c contains a list of receive sequence numbers for all of the forward links. Frame FU10c can be transmitted either, by insertion in an FU10a frame of the opposite link (clause 10.11.2.1), or using the G_F logical channel. Frame FU10c has a fixed fragment size of 7 octets.

Frame type FU10d is used for the backward (control) path of unidirectional links. Type FU10d contains a single receive sequence numbers for the forward links, that can be a positive or a negative acknowledge. Frame FU10d can be transmitted either, by insertion in a FU10a frame of the opposite link (clause 10.11.2.1), or using the G_{FA} logical channel. Frame FU10d may have 10 bits (full format) or 8 bits (shortened format).

Coding and meaning of bit ACK/NACK in frame type FU10d (full format) is identical to the coding of similar bit in frame type FU10b and in both cases is coded as defined in clause 13.4.4: the bit coded to "1" indicates that the RSN is a positive acknowledge (ACK); the bit coded to "0" indicates that the RSN is a negative acknowledge (NACK).

When the shortened format of Frame FU10d is used, it shall be assumed that the command is a positive acknowledge. Frame FU10d shortened shall only carry 8 bits. Therefore it may only be used when the window size is lower than 255 or 128 is Class 2 SEL is used.

The use of one or other frame system (for instance FU10a/FU10c vs. FU10a/FU10d) is indicated by the NWK layer IE <<Connection Attributes>> (frame type and options). When FU10d is in use, the use of the full or shortened formats is deducted by the transport mechanism (i.e. the A-field message that carries the frame).

FU10N is the size in octets of the DLC PDU, and is a function of the underlying connection type.

Table 12.11.1.0.1: FU10 connection types

Connection Type	Slot Type	FU10N				
		2 level	4 level	8 level	16 level	64 level
I_{PM} error detect	half slot (j=80)	8 octets	16 octets	24 octets	32 octets	48 octets
I_{PMR} error correct	half slot (j=80)	8 octets	16 octets	24 octets	32 octets	48 octets
I_{PX} encoded protected (see note 1)	half slot (j=80)	(10 × r) octets	(20 × r) octets	(30 × r) octets	(40 × r) octets	(60 × r) octets
I_{PM} error detect	Long slot (j=640/672)	64 octets	128 octets	192 octets	256 octets	384 octets
I_{PMR} error correct	Long slot (j=640/672)	64 octets	128 octets	192 octets	256 octets	384 octets
I_{PQ} error detect	Long slot (j=640)	76 octets	156 octets	236 octets	316 octets	476 octets
I_{PQR} error correct	Long slot (j=640)	76 octets	156 octets	236 octets	316 octets	476 octets
I_{PK} error detect	Long slot (j=640)	76 octets	2 × 76 octets	3 × 76 octets	4 × 76 octets	6 × 76 octets
I_{PKR} error correct	Long slot (j=640)	76 octets	2 × 76 octets	3 × 76 octets	4 × 76 octets	6 × 76 octets
I_{PX} encoded protected (see note 1)	Long slot (j=640)	(80 × r) octets	(160 × r) octets	(240 × r) octets	(320 × r) octets	(480 × r) octets
I_{PQ} error detect	Long slot (j=672)	80 octets	164 octets	248 octets	332 octets	500 octets
I_{PQR} error correct	Long slot (j=672)	80 octets	164 octets	248 octets	332 octets	500 octets

Connection Type	Slot Type	FU10N				
		2 level	4 level	8 level	16 level	64 level
I_{PK} error detect	Long slot ($j=672$)	80 octets	2 x 80 octets	3 x 80 octets	4 x 80 octets	6 x 80 octets
I_{PKR} error correct	Long slot ($j=672$)	80 octets	2 x 80 octets	3 x 80 octets	4 x 80 octets	6 x 80 octets
I_{PM} error detect	Full slot	32 octets	64 octets	96 octets	128 octets	192 octets
I_{PMR} error correct	Full slot	32 octets	64 octets	96 octets	128 octets	192 octets
I_{PQ} error detect	Full slot	38 octets	76 octets	116 octets	156 octets	236 octets
I_{PQR} error correct	Full slot	38 octets	76 octets	116 octets	156 octets	236 octets
I_{PK} error detect	Full slot	38 octets	2 x 38 octets	3 x 38 octets	4 x 38 octets	6 x 38 octets
I_{PKR} error correct	Full slot	38 octets	2 x 38 octets	3 x 38 octets	4 x 38 octets	6 x 38 octets
I_{PX} encoded protected (see note 1)	Full slot	$(40 \times r)$ octets	$(80 \times r)$ octets	$(120 \times r)$ octets	$(160 \times r)$ octets	$(240 \times r)$ octets
I_{PM} error detect	Double slot	80 octets	160 octets	240 octets	320 octets	480 octets
I_{PMR} error correct	Double slot	80 octets	160 octets	240 octets	320 octets	480 octets
I_{PQ} error detect	Double slot	96 octets	196 octets	296 octets	396 octets	596 octets
I_{PQR} error correct	Double slot	96 octets	196 octets	296 octets	396 octets	596 octets
I_{PK} error detect	Double slot	96 octets	2 x 96 octets	3 x 96 octets	4 x 96 octets	6 x 96 octets
I_{PKR} error correct	Double slot	96 octets	2 x 96 octets	3 x 96 octets	4 x 96 octets	6 x 96 octets
I_{PX} encoded protected (see note)	Double slot	$(100 \times r)$ octets	$(200 \times r)$ octets	$(300 \times r)$ octets	$(400 \times r)$ octets	$(600 \times r)$ octets

NOTE 1: The encoded protected format is defined in ETSI EN 300 175-3 [3]. The adaptive code rate r is negotiated at the MAC layer and send to the DLC via the MAC_MOD primitive.

NOTE 2: I_{PK} and I_{PKR} modes provide a constant PDU size irrespective of the modulation mode. In HLM modes, several PDUs are transported by each MAC bearer as noted.

Other connection types are for further study.

12.11.1.1 Specific for MAC service I_{PK}

When using FU10 over the MAC service I_{PK} (or I_{PKR}) in combination with HLM, several segments, and therefore DLC frames, are carried by each MAC bearer.

If the number of available frames is lower than the transport capacity, filling frames shall be used to complete the MAC bearer capacity. Such filling frames shall be coded as follows:

- With Length Indicator = 0, and M bit = 0 for the general case when the filling frame is placed in between SDUs. Filling frames shall be padded with the filling pattern.
- With Length Indicator = 0, and M bit = 1, repeated until the end of the frame, for the less usual case when the filling frame is placed in the middle of a SDU.

NOTE 1: The last case is believed to happen only due to limitations in implementation capacity to process the data flow, or to special modes such as "early transmission" option (see clause 11.12.3.1.1) combined with slow arrival of data.

- In both cases, there exists the option of inserting frames FU10c in the filling frames using the general mechanism described in clause 12.11.2.1.

NOTE 2: When using FU10 over the MAC service I_{PKR} (error correction variant of I_{PK}) in combination with HLM, a MAC retransmission may produce unnecessary retransmission of correctly received DLC PDUs.

12.11.2 Transmission of FU10c and FU10d frames

12.11.2.0 General

When using two LU10 unidirectional links (frames FU10a/FU10c or FU10a/FU10d) in order to implement a bi-directional service, there is the possibility to send the FU10c or FU10d frames either, via the dedicated G_F (or G_{FA}) channel, or inserting them in a forward FU10a frame of the opposite link.

NOTE 1: It is a decision of the FU10c (or FU10d) sending side the way of transmission of the frame. The decision can be taken dynamically according to E/U mux selection or free space in FU10a frames.

NOTE 2: However, not both transmission methods need to be supported in all cases. A profile may define if one of the mechanisms or both are supported.

In both cases, the format of the FU10c frame is identical and is composed of 7 octets as defined in figure 12.11.1.0.3.

For the format of FU10d frame see figures 12.11.1.0.4 and 12.11.1.0.5.

12.11.2.1 Insertion of the FU10c frame in an FU10a frame of the opposite link

One or several FU10c frames can be transmitted at the beginning of an FU10a frame of the opposite link using the following mechanism:

- The first length indicator of the FU10a frame shall contain the special code LI = "63" and M = "1".
- One FU10c frame of seven octets shall be inserted immediately after the length indicator.
- In the following octet there shall be a new Length Indicator. This new Length Indicator could be:
 - The same special LI = "63" and M = "1" code indicating that a new FU10c packet is inserted.
 - A valid value of LI and M bits indicating the insertion of user data in the FU10a forward channel according to the general FU10a rules.
 - The value LI = "0" and M = "0" indicating that there is nothing more in the frame.

NOTE 1: The FU10c frame will be always filled to 7 bytes according to the general FU10c rules.

NOTE 2: After a second insertion of an FU10c, there will be a new length indicator with the same three possibilities. The process can be repeated until the limit indicated in note 3.

NOTE 3: The maximum number of FU10c packets that can be inserted in an FU10a frame is limited to x due to flow control reasons, where x is equal to the number of subfields of the I_{PM} protected format for the slot size and modulation level in use.

12.11.2.2 Transmission of the FU10c frame using the G_F channel

The FU10c frames can be transmitted at any time via the G_F channel.

NOTE 1: It is a decision of the FU10c sending side the way of transmission of the frame.

NOTE 2: It is possible to combine both transmission mechanisms. In such a case the receiver of the FU10c frame will process them in order of reception.

NOTE 3: In case of asymmetric connections, it is advisable to use the insertion mechanism for the FU10c frames sent in the mainstream direction (acknowledging for data sent in reverse direction).

12.11.2.3 Insertion of the FU10d frame in an FU10a frame of the opposite link

The same coding defined for FU10c (clause 12.11.2.1) shall be used.

- The first length indicator of the FU10a frame shall contain the special code LI = "63" and M = "1".

Full FU10d format shall always be used (as defined by figure 12.11.1.0.4).

- One FU10d frame, full format, of two octets coded as figure 12.11.1.0.4 shall be inserted immediately after the length indicator.
- Spare bits shall be coded to "0".

In the following octet there shall be a new Length Indicator. The same possibilities described in clause 12.11.2.1 for FU10c exist. All other provisions described in clause 12.11.2.1 shall apply.

NOTE: The possible insertion of multiple FU10d frames has only sense in transmission Class 2. It should not be used with Class 1.

12.11.2.4 Transmission of the FU10d frame using the G_{FA} channel

The FU10d frames can be transmitted at any time via the G_{FA} channel.

Depending on the message that carries the frame, the FU10d full format or the FU10d shortened shall be used. Refer to ETSI EN 300 175-3 [3] for details.

When the shortened format of Frame FU10d is used, it shall be assumed that the command is a positive acknowledge.

NOTE: Frame FU10d, shortened format, only carries 8 bits. Therefore it may only be used when the window size is lower than 255 or 128 is Class 2 SEL is used.

12.11.3 FU10 buffering procedures

The FB_p-frame buffering entity shall be used to provide a data buffering function, and is required to supply data (at the transmit side) or accept data (at the receive side) on demand and with minimum delay.

Transmit side: on receipt of a MAC_CO_DTR-ind primitive, one complete frame of data shall be submitted to the MAC layer in a MAC_CO_DATA-req primitive.

Receive side: each MAC_CO_DATA-ind primitive shall contain one complete frame of data from the MAC layer.

In all cases, the order of arrival of the higher layer information shall be preserved, and this shall be identical to the order of transmission.

12.11.4 Connection handover

During connection handover, FU10a/FU10b frames should be sent simultaneously to both the old and the new connections. The receive path is then switched to the new connection as soon as the new connection is fully established.

NOTE: Duplicate FU10a/FU10b frames on the old and new connections will have identical contents.

12.11.5 Transmission order

The physical transmission order is controlled by the MAC layer as defined in ETSI EN 300 175-3 [3]. This MAC layer ordering shall use the octet numbering and bit numbering shown above.

The operations across the DLC layer/MAC layer boundary shall be such that the DLC entity sending a frame can assume this temporal order of the frame, and that the entity receiving the frame can reconstruct it with its assumed temporal order.

12.12 FU12 frame structure

12.12.1 General frame structure

FU12 is a fixed length frame. The total frame length shall always be equal to the segment size of the I_N logical channel.

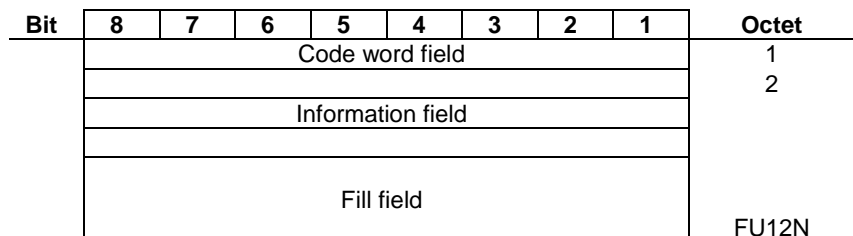

Figure 12.12.1.1: Frame Format Type FU12

FU12N is the size in octets of the DLC PDU, and is a function of the underlying connection type.

Table 12.12.1.1: FU12 connection types

Connection Type	Slot Type	FU12N				
		2 level	4 level	8 level	16 level	64 level
I_N minimum delay (I_{NA}) or I_N normal delay (I_{NB})	half slot ($j=80$)	10 octets	20 octets	30 octets	40 octets	60 octets
I_N minimum delay (I_{NA}) or I_N normal delay (I_{NB})	Long slot ($j=640$)	80 octets	160 octets	240 octets	320 octets	480 octets
I_N minimum delay (I_{NA}) or I_N normal delay (I_{NB})	Long slot ($j=672$)	84 octets	168 octets	252 octets	336 octets	504 octets
I_N minimum delay (I_{NA}) or I_N normal delay (I_{NB})	Full slot	40 octets	80 octets	120 octets	160 octets	240 octets
I_N minimum delay (I_{NA}) or I_N normal delay (I_{NB})	Double slot	100 octets	200 octets	300 octets	400 octets	600 octets

Other connection types are for further study.

12.12.2 FU12 buffering procedures

The FB_N entity shall be used to provide a data buffering function between the service user and the MAC layer. It shall be required to supply data to the MAC layer (at the transmit side) or accept data from the MAC layer (at the receive side) on demand.

NOTE: Normal data delivery will be periodic, with frames demanded and delivered at the TDMA frame rate.

Transmit side: on receipt of a MAC_CO_DTR-ind primitive, one complete frame of data shall be submitted to the MAC layer in a MAC_CO_DATA-req primitive.

Receive side: each MAC_CO_DATA-ind primitive shall contain one complete frame of data from the MAC layer.

In all cases, the order of arrival of the higher layer information shall be preserved, and this shall be identical to the order of transmission.

12.12.3 Connection handover

During connection handover, FU12 frames may be sent simultaneously to both the old and the new connections. The receive path is then switched to the new connection as soon as the new connection is indicated to be in the "open" state.

NOTE: When using I_{N_normal} delay service, duplicate FU12 frames on the old and new connections have identical contents. However when using $I_{N_minimum_delay}$ service, the FU12 frames on the old and new connections may have different contents depending on the slot positions used in both connections and the synchronization of the data source (i.e. codec). Seamless connection handover may still be possible depending on the implementation of FT and PT.

12.12.4 Transmission order

The physical transmission order shall be controlled by the MAC layer as defined in ETSI EN 300 175-3 [3]. This MAC layer ordering shall use the octet numbering and bit numbering shown above.

The operations across the DLC layer/MAC layer boundary shall be such that the DLC entity sending a frame can assume this temporal order of the frame, and that the entity receiving the frame can reconstruct it with its assumed temporal order.

In all cases, the order of arrival of the higher layer information shall be preserved, and this shall be identical to the order of transmission.

13 Elements of procedures and formats of fields for U-plane peer-to-peer communication

13.1 General

The "elements of procedure" define the commands and responses that are used to provide a single U-plane data link. Multiple instances of U-plane data links may exist at the same time, but these instances are assumed to operate independently. The elements of procedure and their related procedures only consider the operation of a single data link instance.

The "formats of fields" define the detailed coding of bits within each field of type FU frames. Unless otherwise stated, all fields are coded according to the natural binary code. The resulting value is arranged with the most significant bit (msb) in the highest numbered bit position.

Bit	7	6	5
	BIT2 (msb)	BIT1	BIT0 (lsb)

Figure 13.1.1: Normal internal field format

13.2 Address elements

13.2.1 Address field format

Bit	8	7	6	5	4	3	2	1
	G	ULN			UCN			1

Figure 13.2.1.1: Address field format

Where:

G: flaG;

ULN: U-plane Link Number;

UCN: U-plane Channel Number.

13.2.2 Address field parameters

Flag (G)

G = 0 for frame from link originator;

G = 1 for frame from link destination.

U-plane Link Number (ULN)

0 0 0 } Valid U-plane link number

to

1 1 0 }

1 1 1 Reserved value.

U-plane Channel Number (UCN)

0 0 0 } Valid U-plane channel number

to

1 1 0 }

1 1 1 Reserved value.

13.3 Length indicator elements

13.3.1 Length indicator field format

13.3.1.1 Length indicator field format for all services except LU10

The following length indicator formats are applicable to all frames, except frames FU10a and FU10b.

Bit	8	7	6	5	4	3	2	1
	L7	L6	L5	L4	L3	L2	L1	M

M: More data bit;

L_i: $i \in \{7..1\}$ Length of Information field (octets).

Figure 13.3.1.1.1: Length indicator field format

For D160 and D240 slot formats, the length indicator is 2 bytes long. The format of the additional byte is as follows:

Bit	8	7	6	5	4	3	2	1
	L15	L14	L13	L12	L11	L10	L9	L8

Figure 13.3.1.1.2: Length indicator field additional byte format

In case of D160 and D240 slot formats the following applies for the length indicator L_I:

L_I: $I \in \{15..1\}$ Length of Information field for D160 and D240 slot format (octets).

13.3.1.2 Length indicator field format for service LU10

For frame type FU10a and FU10b the first length indicator shall be as follows, instead of the description of clause 13.3.1.1.

Bit	8	7	6	5	4	3	2	1
	ES9	L6	L5	L4	L3	L2	L1	M

Figure 13.3.1.2.1: FU10a First length indicator format

Bit	8	7	6	5	4	3	2	1
	ACK/ NACK	L6	L5	L4	L3	L2	L1	M

Figure 13.3.1.2.2: FU10b First length indicator format

Bit	8	7	6	5	4	3	2	1
	spare	L6	L5	L4	L3	L2	L1	M

Figure 13.3.1.2.3: FU10a and FU10b Format for length indicators other than the first

In case of frame type FU10a and FU10b the following applies for the length indicator L_I :

L_I : $I \in \{6..1\}$ Length of Information field for FU10a and FU10b frame type.

In case of the first length indicator of frame type FU10a the following applies:

- the Send sequence number of the PDU is extended with bitES9 of the 1st length indicator field.

In case of the first length indicator of frame type FU10b the following applies:

- bit 8 of the 1st length indicator field is used to indicate ACK/NACK relative to the received sequence number field.

In case of length indicator other than the first one, the following applies:

- the bit 8 (MSB) shall be ignored by the receiver. It shall be coded by the transmitter with "0".

NOTE: The possible coding of this bit to "1" is reserved for further evolution of the standard.

13.3.2 Length indicator field parameters

13.3.2.1 Length indicator field parameters for all services except LU10

The following specific conventions shall apply for all frame types except FU10a and FU10b. Extended more data bit M: the extended more data bit, M, is used to indicate segmentation of messages into FUX frames.

M = "1" indicates that the information field only contains part of a message - there is more to follow.

M = "0" indicates one of two things:

- that the information field contains a complete message, provided that the M bit of the previous frame was also set to "0";
- that the information field contains the last segment of a message, provided that the M bit of the previous frame was set to "1".

When the M bit is set to "1", the information field should contain the maximum number of octets.

NOTE 1: This rule only recommends that each frame contains the maximum amount of information. However, the L_I field always defines the actual length.

Length parameter L_I : the length parameter L_I consists of 7 bits for all slot formats except for D160 and D240 and except the FU10 frame format. For D160 and D240 slot formats, the length parameter L_I consists of 15 bits. For FU10 the length parameter consists of 6 bits. The length parameter L_I defines the length of the information field in all frames.

Allowable values for 2 level modulated full slot formats are:

- 0 to 30 for frame types FU2, and FU6a;
- 0 to 29 for frame type FU4a;
- 0 to 28 for frame types FU5a.

NOTE 2: Maximum value for full slot is 30 octets. 7 bits are allowed for possible double slot D80 operation - 100 octets. For D160 and D240 operation, 7 bits are not enough and hence 2 octets are required for the Length Indicator field.

$L_1 = "0"$ is used for all frames that contain no higher layer information.

NOTE 3: Frames that contain no higher layer information should not be transmitted.

Remaining (unused) octets shall be filled with the standard fill octet defined in clause 13.5.

13.3.2.2 Length indicator field parameters for LU10 service

13.3.2.2.0 General

For frame type FU10a and FU10b only, the following specific conventions shall apply.

The length of Information field, - L_I ; $I \in \{6..1\}$ - of the length indicator shall be understood as follows:

LI = 63	The meaning depends on the value of the more (M) bit (bit 1 in the same octet). IF M = 0 means that the frame is a synchronization frame for transmission Class 2, as defined in clause 14.3.4.1.1. This combination can only be used in the first length indicator octet. IF M = 1 means insertion of a FU10c or FU10d frame for the opposite channel as defined in clause 12.11.2.1. This only applies to FU10a frames.
LI = 62	means that the length indicator byte is followed by a segment of payload of length equal to the maximum payload size that can be transported by the remaining number of octets of the FU10 frame. This code shall not be used if the value of the maximum payload size is lower than 62. In such a case LI shall show the real value of the payload size.

NOTE 1: If the Length indicator octet is the first one, then the number of octets of the payload is as indicated in table 13.3.2.2.0.1.

LI = 0	The meaning depends on the value of the more (M) bit (bit 1 in the same octet). IF M = 0 means that there is nothing more in the rest of the PDU that shall be filled with the fill pattern (defined in clause 13.5). The Rx side does not need to continue processing the PDU. A new SDU will begin at the next Length indicator with $1 \leq LI \leq 62$ at the next PDU. If the previous Length indicator preceding an info field had the M bit = 1, then this Length indicator signals an abnormal termination of an SDU. See clause 14.3.4.1.3. If the previous Length indicator preceding an info field had the M bit set to "0", the previous SDU terminated normally at the end of the info field, and the special code in the following Length indicator does not have any special meaning regarding last SDU.
--------	--

NOTE 2: "Previous length indicator preceding an info field" refers to the previous length indicator with $1 \leq LI \leq 62$ in the PDU sequence. It has not necessarily had to happen in the same PDU.

NOTE 3: Length indicator with the special codes (LI=63, M=1) and (LI=0, M=1) may be in between and are irrelevant for this rule:

IF M = 1 means that there will be a further Length indicator octet in the following byte. This pattern may be repeated as times as needed.

Any other value of LI ($0 \leq LI \leq 61$) means that the length indicator byte is followed by a segment of payload of the length indicated by the length indicator.

If a segment of information of length lower than the maximum payload size and larger than 61 octets needs to be inserted in a PDU, it shall be split in two or more segments of length lower than 61 inserting length indicators bytes between them. The bit "M" shall be set to "1" in all length indicators except the last one, that shall be set to "0".

If a segment of information of length equal to the maximum payload size is to be inserted in a PDU, the bit "M" may be set to "0" or "1" depending on if it is the last field of an SDU, or if the SDU continues in next PDU. This applies either if the Length information field (LI) has been coded with the special value 62 or with the real information field length, but equal to the remaining octets of the PDU.

NOTE 4: The value of the maximum payload size that can be transported by the frame depends of the slot type, MAC service and modulation type. The value of the maximum payload size for frame FU10a is indicated in table 13.3.2.2.0.1.

Table 13.3.2.2.0.1: Maximum payload size for frame FU10a

Connection Type	Slot Type	Maximum payload size				
		2 level	4 level	8 level	16 level	64 level
I_{PM} error detect	half slot (j=80)	06 octets	14 octets	22 octets	30 octets	46 octets
I_{PMR} error correct	half slot (j=80)	06 octets	14 octets	22 octets	30 octets	46 octets
I_{PX} encoded protected (see note 1)	half slot (j=80)	$(10 \times r - 2)$ octets	$(20 \times r - 2)$ octets	$(30 \times r - 2)$ octets	$(40 \times r - 2)$ octets	$(60 \times r - 2)$ octets
I_{PM} error detect	Long slot (j=640/672)	62 octets	126 octets	190 octets	254 octets	382 octets
I_{PMR} error correct	Long slot (j=640/672)	62 octets	126 octets	190 octets	254 octets	382 octets
I_{PQ} error detect	Long slot (j=640)	74 octets	154 octets	234 octets	314 octets	474 octets
I_{PQR} error correct	Long slot (j=640)	74 octets	154 octets	234 octets	314 octets	474 octets
I_{PK} error detect	Long slot (j=640)	74 octets	74 octets	74 octets	74 octets	74 octets
I_{PKR} error correct	Long slot (j=640)	74 octets	74 octets	74 octets	74 octets	74 octets
I_{PX} encoded protected (see note 1)	Long slot (j=640)	$(80 \times r - 2)$ octets	$(160 \times r - 2)$ octets	$(240 \times r - 2)$ octets	$(320 \times r - 2)$ octets	$(480 \times r - 2)$ octets
I_{PQ} error detect	Long slot (j=672)	78 octets	162 octets	246 octets	330 octets	498 octets
I_{PQR} error correct	Long slot (j=672)	78 octets	162 octets	246 octets	330 octets	498 octets
I_{PK} error detect	Long slot (j=672)	78 octets	78 octets	78 octets	78 octets	78 octets
I_{PKR} error correct	Long slot (j=672)	78 octets	78 octets	78 octets	78 octets	78 octets
I_{PM} error detect	Full slot	30 octets	62 octets	94 octets	126 octets	190 octets
I_{PMR} error correct	Full slot	30 octets	62 octets	94 octets	126 octets	190 octets
I_{PQ} error detect	Full slot	36 octets	74 octets	114 octets	154 octets	234 octets
I_{PQR} error correct	Full slot	36 octets	74 octets	114 octets	154 octets	234 octets
I_{PK} error detect	Full slot	36 octets	36 octets	36 octets	36 octets	36 octets
I_{PKR} error correct	Full slot	36 octets	36 octets	36 octets	36 octets	36 octets
I_{PX} encoded protected (see note 1)	Full slot	$(40 \times r - 2)$ octets	$(80 \times r - 2)$ octets	$(120 \times r - 2)$ octets	$(160 \times r - 2)$ octets	$(240 \times r - 2)$ octets
I_{PM} error detect	Double slot	78 octets	158 octets	238 octets	318 octets	478 octets
I_{PMR} error correct	Double slot	78 octets	158 octets	238 octets	318 octets	478 octets
I_{PQ} error detect	Double slot	94 octets	194 octets	294 octets	394 octets	594 octets
I_{PQR} error correct	Double slot	94 octets	194 octets	294 octets	394 octets	594 octets
I_{PK} error detect	Double slot	94 octets	94 octets	94 octets	94 octets	94 octets

Connection Type	Slot Type	Maximum payload size				
		2 level	4 level	8 level	16 level	64 level
I_{PKR} error correct	Double slot	94 octets	94 octets	94 octets	94 octets	94 octets
I_{PX} encoded protected (see note 1)	Double slot	$(100 \times r - 2)$ octets	$(200 \times r - 2)$ octets	$(300 \times r - 2)$ octets	$(400 \times r - 2)$ octets	$(600 \times r - 2)$ octets
NOTE 1: The encoded protected format is defined in ETSI EN 300 175-3 [3]. The adaptive code rate r is negotiated at the MAC layer and send to the DLC via the MAC_MOD primitive.						
NOTE 2: I_{PK} and I_{PKR} modes provide a constant PDU size irrespective of the modulation mode. In HLM modes, several PDUs are transported by each MAC segment.						

For frame FU10b, the value of the maximum payload size is the indicated in table 13.3.2.2.0.1 minus 1 byte.

13.3.2.2.1 Meaning of the more (M) bit

When using frame type FU10a or FU10b, the meaning of the More (M) bit shall be understood as follows:

- 1) $M = "1"$ and a value of the length of Information field equal to the remaining number of octets till the end of the PDU indicates that the information field only contains part of a SDU. There is more to follow in the next PDU.

NOTE 1: The value of the length of Information field equal to the remaining number of octets till the end of the PDU may be coded with the special value 62 or with the real length depending on the case.

- 2) $M = "1"$ and a value of the length of Information field lower than the remaining number of octets till the end of the PDU indicates that the information field only contains part of a SDU, and that there will be a new length indicator byte immediately after the information field. The content of the SDU shall continue after the new length indicator.

NOTE 2: $M = "1"$ and the value of the length indicator equal to zero indicate that there is a new length indicator immediately after the current one.

- 3) $M = "0"$ and a value of the length of Information field different from zero or from 63, indicates one of two things:
 - a) that the information field contains a complete SDU, provided that the M bit of the previous length indicator was also set to "0";
 - b) that the information field contains the last segment of a SDU, provided that the M bit of the previous length indicator was set to "1".

In addition to that, the "M" bit set to "0" and a value of the length of Information field different from zero and lower than the remaining number of octets till the end of the PDU means additionally, that there is a new length indicator byte immediately following the information field. The bit M in such length indicator has to be examined, to check if more data of a further SDU follows in this PDU.

- 4) $M = "0"$ and a value of the length of Information field equal to zero indicates end of SDU and end of PDU content. There is no information field after this length indicator and the remaining part of the PDU shall be discarded. A new SDU will generally begin at next PDU (however, it is allowed not transmitting any payload in next PDU by using the LI="0", M="0" indicator). Depending on the value of the M bit in previous length indicator, it may signal abnormal termination of an SDU. See clause 14.3.4.1.3.

For frame type FU10a only:

- 5) If Length Indicator (LI) = 63, and $M = "1"$ means insertion of FU10c or FU10d frame as defined in clause 12.11.2.1, and $M = "0"$ means that frame is a synchronization frame for transmission Class 2, as defined in clause 14.3.4.

13.4 Sequence number elements

13.4.1 Send sequence number format

Bit	8	7	6	5	4	3	2	1
	I/R	ES7	ES6	ES5	ES4	ES3	ES2	ES1

Figure 13.4.1.1: Send sequence number field format

ES_I = Send Sequence Number (7-bits); $I \in \{7..1\}$;

I/R = Initial/Retransmission bit.

For frame format FU10a and FU10b the following Send sequence number format shall be used.

Bit	8	7	6	5	4	3	2	1
	ES8	ES7	ES6	ES5	ES4	ES3	ES2	ES1

Figure 13.4.1.2: Send sequence number field format for FU10

For FU10a the ES9 bits from the length indicator shall be added to the 8 bits shown above (clause 13.3.1).

ES_I = Send Sequence Number (9-bits); $I \in \{9..1\}$.

13.4.2 Send sequence number parameters

At the time that an in-sequence frame is designated for transmission, the value of ES_I is set equal to the value of the send state variable SN according to the selected transmission class. Refer to clauses 14.2 and 14.3.

The I/R bit shall define the meaning of the send sequence number contained in the same octet, using the following coding:

I/R = "1" First transmission (of this frame);

I/R = "0" Retransmission (of this frame).

13.4.3 Receive sequence number format

Bit	8	7	6	5	4	3	2	1
	A/N	ER7	ER6	ER5	ER4	ER3	ER2	ER1

Figure 13.4.3.1: Receive sequence number field format

ER_I = Receive sequence number (7-bits); $I \in \{7..1\}$;

A/N = ACK/NACK bit.

For frame type FU10b the following receive sequence number format shall be used.

Bit	8	7	6	5	4	3	2	1
	ER8	ER7	ER6	ER5	ER4	ER3	ER2	ER1

Figure 13.4.3.2: Receive sequence number field format for FU10b

ER_I = Receive sequence number (8-bits); $I \in \{8..1\}$;

NOTE: The A/N = ACK/NACK bit is contained in the length indicator octet (octet 3) (clause 13.3.1).

13.4.4 Receive sequence number parameters

At the time that a frame is designated for transmission, the value of ER_1 is set according to the selected transmission class. Refer to clauses 14.2 and 14.3.

The A/N bit shall define the meaning of the Receive sequence number contained in the same octet, using the following coding:

A/N = "1" Positive acknowledge;

A/N = "0" Negative acknowledge.

13.5 Fill elements - Fill field format

Bit	8	7	6	5	4	3	2	1
	1	1	1	1	0	0	0	0

Figure 13.5.1: Fill field format

NOTE: Fill field octets are filled with balanced data.

14 U-plane peer-to-peer procedures

14.1 General

Multiple instances of U-plane entities may exist within one PT and within one FT. These instances are assumed to operate completely independently, and the operation of only a single instance is considered here.

Each of these procedures shall only be used to provide a single point-to-point (U-plane) link between one FT and one PT. Class 0 can also be used for connectionless multicast transmission of U-plane data from an FT to PTs.

The procedures in this clause are generic in the sense that each procedure may be applicable to more than one of the LU services. The procedures are written in a modular manner, by referencing them to the elements of procedure defined in clause 13. Each modular procedure shall apply to any of the (internal) frames defined in clause 12 that contain the relevant element(s) of that procedure.

NOTE: Certain U-plane services provide for the transport of external user data that contains an (external) frame structure. In this clause, the word "frame" only refers to the (internal) frames defined in clause 12.

14.2 Frame transmission principles

14.2.1 Sequence numbering

Frame types FU3, FU4, FU5, FU6 and FU10 contain one or two octets containing sequence numbers. These are used for error control and flow control information. All of these frame types shall contain a send sequence number, and frame types FU3, FU4, FU5 and FU10 shall also contain a receive sequence number.

If a connection oriented MAC service is used (see ETSI EN 300 175-3 [3], clause 5.6), then the send sequence number shall be set to zero at the start of the MAC connection, and this value shall be used for the first transmitted frame over that MAC connection. The send sequence numbers of successive frames shall be contiguous (modulo 2^n , with n equal to the number of sequence number bits) during the lifetime of that MAC connection (including logical connections).

If a connectionless MAC service is used (see ETSI EN 300 175-3 [3], clauses 5.7 and 9.1.2.2), then the send sequence number of the first segment of a DLC SDU may be arbitrarily chosen. The send sequence numbers of successive frames shall be contiguous (modulo 128) within one DLC SDU.

The receive sequence number shall be set to 0 at service establishment, and this sequence number shall be updated according to the transmission procedures given in clause 14.3.

14.2.2 Acknowledgements

14.2.2.1 Sending acknowledgements

The receiving entity shall send continuous acknowledgement data to the sending entity using the single receive sequence number or list of receive sequence numbers as appropriate. All such acknowledgement data shall be always updated at the time it is transmitted.

NOTE 1: Continuous does not necessarily means in every frame. See receive side procedure descriptions for details.

NOTE 2: The sending of acknowledgement data stops when there is no data transmission (see clause 14.3.4.2.2).

14.2.2.2 Receiving acknowledgements

Positive ACKnowledgement information (ACKs) shall only be accepted if it is received within error free frames (see note 1). Negative ACKnowledgement information (NACKs) shall be accepted if it is received within error free frames, but may also be accepted if it is contained in erroneous frames.

Frames that contain multiple acknowledgement octets (multiple RNs) shall contain at least one valid RN. Valid RNs shall be placed in the lowest numbered octets. No RN shall be duplicated. Exception to the previous requirement shall apply to all unused octets that shall be filled with an exact duplicate of the highest RN.

NOTE 1: In unidirectional links, frames that contain multiple acknowledgement octets (e.g. FU6b frames) are transmitted via the G_F channel using single B-subfield (see ETSI EN 300 175-3 [3]). These frames are to be considered correctly received (i.e. error free frames) if the single B-subfield does not contain errors.

NOTE 2: At the receiving side, the octets in these frames should be processed in ascending order. The remaining octets may then be discarded if a duplication is discovered.

14.2.3 Transmission classes

14.2.3.0 General

Four transmission classes are defined:

- class 0: no LUX retransmission or sequencing;
- class 1: no LUX retransmission (sequencing only);
- class 2: variable throughput, limited delay LUX retransmission;
- class 3: fixed throughput LUX retransmission.

14.2.3.1 Class 0: No LUX retransmission or sequencing

This service provides a fixed throughput service, with the notification of MAC detected errors. Sequencing shall be provided by the MAC layer, and this shall only be guaranteed if a fixed bandwidth (fixed number of MAC bearers) can be maintained.

This shall use the following MAC I channel operation mode:

- I_N : minimum_delay;
- I_N : normal_delay;
- I_P : error-correct/single bearer only;
- I_P : error-detect.

NOTE: I_P error-correct and I_P error-detect services can be used in the multi-subfield (I_{PM} or I_{PMR}) or in the single-subfield (I_{PQ} or I_{PQR}) variants.

All error detection uses the normal MAC error detection procedures (see ETSI EN 300 175-3 [3]).

14.2.3.2 Class 1: no LU_x retransmission

14.2.3.2.0 General

This service provides a variable throughput service, with removal or notification of all errors detected at the MAC layer. The correct frames are always resequenced at the receiver. If a MAC retransmission failure is reported at the sending side (e.g. if the maximum MAC retransmit count is reached) or if a sequence error is detected at the receiving side, the link may be released by the upper layer. In all cases a notification shall be issued to the higher layer whenever an error is detected.

This shall use the following MAC I channel operation mode:

I_P : error-correct.

NOTE: I_P error-correct service can be used in the multi-subfield (I_{PMR}) or in the single-subfield (I_{PQR}) variants.

All error detection uses the normal MAC error detection procedures (see ETSI EN 300 175-3 [3]).

14.2.3.2.1 Class 1: use over C/L downlink channels

14.2.3.2.1.0 General

Class 1 may be used over C/L downlink channels. Operation may be acknowledged or unacknowledged. Only unacknowledged operation is currently supported.

14.2.3.2.1.1 Class 1 over C/L downlink channels: unacknowledged mode

In this mode only sequence numbering is provided by the transmitter. The receiving side will provide error detection and detection of missing packets in the sequence, and may perform re-sequencing. There is no flow control provided by the DLC in this mode.

14.2.3.2.1.2 Class 1 over C/L downlink channels: acknowledged mode

Acknowledgement of Class 1 transmission over C/L downlink channels is for further study.

14.2.3.3 Class 2: variable throughput, limited delay LU_x retransmission

This service is characterized by the demands of variable throughput with controlled maximum delay. Each frame is retransmitted until acknowledged, or until a timer expired. The DLC retransmission may operate in Go_Back_N or in SElective (SEL) retransmission protocol.

This may use the following MAC I channel operation modes:

I_P : error-correct;

I_P : error-detect.

NOTE 1: I_P error-correct and I_P error-detect services can be used in the multi-subfield (I_{PM} or I_{PMR}) or in the single-subfield (I_{PQ} or I_{PQR}) variants.

All error detection uses the normal MAC error detection procedures (see ETSI EN 300 175-3 [3]).

NOTE 2: Care is needed to ensure that the application does not retransmit faster than the DLC retransmission; this could cause the offered throughput to decrease catastrophically.

14.2.3.4 Class 3: fixed throughput LU_x retransmission

This service is characterized by the demands of a fixed throughput. Limited error correction based on the retransmission scheme is applied, but data throughput is maintained even in the presence of errors.

This shall use the following MAC I channel operation mode:

I_p : error-detect only.

NOTE: I_p error-detect service can be used in the multi-subfield (I_{PM}) or in the single-subfield (I_{PQ}) variants.

The potential level of correction is defined by the service attributes, giving a nominal fixed delay, and the excess connection bandwidth available from the MAC layer.

In the event that a frame cannot be delivered correctly within the time limits of the service, both sides of the link shall act independently to clear the old frame.

At the transmitter, any frame that exceeds the specified lifetime (i.e. more than N ms old) is discarded without notification and shall not be retransmitted any more.

The receiver shall independently generate a replacement frame to the output, and shall mark the interruption. The receiver should then proceed as though the frame had been received correctly, including sending positive acknowledgement(s) as appropriate.

14.2.4 Operation parameter negotiation

Certain operating parameters may be negotiated at call establishment, as defined in ETSI EN 300 175-5 [5]. This negotiation shall be optional. The following parameters may be negotiated:

- window sizes;
- transit delay.

Window size negotiation: if negotiation is adopted, the negotiated values shall be used to define the maximum values. If negotiation is not used, the maximum values defined in clause 14.3 shall be used.

Transit delay negotiation: transit delay negotiation shall only be used for class 2 and class 3 operation. If negotiation is adopted, the negotiated values shall be used to define the maximum values for the DLC elements of the delay. If negotiation is not used, the maximum values defined in clause 14.3.5 shall be used.

14.3 Frame transmission procedures

14.3.1 General

The term "SN" shall refer to send Sequence Numbers. The term "RN" shall refer to Receive Sequence numbers.

All operations shall be understood to be Modulo 2^n , with n equal to the number of sequence number bits, for both send sequence numbers and receive sequence numbers. The term "modulus" shall refer to this value.

The procedures shall be described for only one direction of operation, and each procedure shall apply to both bi-directional or unidirectional operation unless otherwise stated. Bi-directional operation shall be assumed to be based on two independent instances of a given procedure; one for each direction.

14.3.2 Class 0 procedures

14.3.2.0 General

Class 0 operation does not use any sequence numbers (SN and RN are not used). Class 0 provides a transparent interface to the MAC layer. The MAC layer service should normally provide sequencing (by invoking a constant bandwidth connection) and may optionally provide error protection.

14.3.2.1 Sending side procedure

The sending entity shall submit frames to the MAC layer in the order of arrival. No sequence numbers shall be added, and no retransmission shall be used.

For minimum delay operation (frame type FU1 only) the special buffering procedures described in clause 12.2.3 shall be used.

14.3.2.2 Receiving side procedure

Normal operation: the receiving entity shall deliver frames in the order they are received from the MAC layer. Packets marked as type "unknown" should be discarded. The remaining packets shall be assumed to contain valid frames, and shall be processed in their order of arrival. Frames containing errors (as indicated by the MAC layer) shall nonetheless be delivered to the higher entity, together with the error indication.

Minimum delay (speech) operation: the receiving entity shall immediately deliver frames in the order they are received from the MAC layer. All packets shall be assumed to contain valid frames, and shall be processed in their order of arrival. Frames indicated as type "unknown" or containing errors (i.e. errors indicated by the MAC layer) shall nonetheless be delivered to the higher entity, together with the error indication.

14.3.3 Class 1 procedures

14.3.3.0 General

Class 1 operation uses both SNs and RNs. If this class is used over a point-to-point link, then both SNs and RNs are used. The RNs then only provide window flow control to avoid possible sequence errors, and shall not invoke any DLC retransmission. Hence, the RNs shall only transport positive acknowledgements (ACKs), denoted by the A/N bit set to 1 (see clause 13.4.3).

If this class is used for connectionless downlink multicast transmission from a FT to PTs, then only SNs are used.

All statements made below in this clause with respect to the use of RNs and windowing only apply to point-to-point links, and are not applicable to connectionless downlink multicast transmission.

14.3.3.1 Sending side procedure

The sending entity shall add SNs to all frames in the order specified by that entity. The I/R bit shall be set to "1".

The resulting frames shall be submitted to the MAC layer in the order of ascending SN.

The sending entity shall maintain a maximum window size between the SN and the last received RN-1. This maximum window size shall be no greater than (modulus-1). A smaller maximum value may be negotiated at call establishment (see clause 14.2.4). A smaller operating window size may be unilaterally adopted by the sending entity at any time.

Due to the modulus operation, each SN may be re-used several times during the life of the link. The minimum interval between re-use shall meet the following requirements:

- 1) a SN shall not exceed the maximum window size;
- 2) a SN shall not be re-used within L(S) TDMA frames of the most recent previous use of that number.

The value of L(S) shall be determined by the MAC service used. L(S) shall be equal to the maximum packet lifetime (as defined at service establishment).

Received RNs with the A/N bit set to "1" shall be treated as an acknowledgement for all frames up to and including the frame number RN-1.

Whenever the window size limit is reached further transmissions shall be halted and timer <DLU-01> shall be started. This timer shall be reset whenever a valid RN is received (i.e. an RN that acknowledges one or more outstanding frames). In this case, further transmissions shall be allowed. If timer <DLU-01> expires the link shall be immediately released.

14.3.3.2 Receiving side procedure

The receiving entity shall accept data packets from the MAC layer in any order. Packets marked as type "unknown" and any packets containing errors in the first portion (i.e. errors in the MAC B0 subfield) shall be discarded. The remaining packets shall be assumed to contain valid frames, and shall be processed in their order of arrival.

In-sequence frames are defined as a series of one or more frames that contain no errors and that contain SNs that together form a continuous series of SNs when considered together with other received but undelivered frames. All in-sequence frames shall be immediately delivered to the higher functions.

Out-of-sequence frames are defined as all other frames (i.e. a sequence of one or more frames that do not form a continuous series of SNs or contain some errors). These frames may only be delivered after they have been buffered for at least L(R) TDMA frames after their arrival. During this buffering period, out-of-sequence frames may become in-sequence frames due to the arrival of one or more missing frames. In this event, the frames shall be immediately delivered to the higher layer.

NOTE 1: Out of sequence frames may be discarded before this time limit, in order to limit buffer sizes.

The value of L(R) shall be determined by the MAC service used. For the I_p -error-correct services, L(R) shall be equal to or greater than the maximum packet lifetime (as defined at service establishment) and less than $\langle DLU-01 \rangle \text{ DIV } 2$. Hence, for this service, infinite values for the maximum packet lifetime at the MAC layer are not allowed.

NOTE 2: The recommended value for L(R) is equal to the maximum packet lifetime.

During the buffering period frames may arrive that are duplicates of one or more of the buffered frames. If the original buffered frame was correct, these duplicates shall be discarded. If the original buffered frame contained errors, the duplicate may be used to correct those errors, using selective replacement of erroneous portions (replacement of MAC BN subfields).

NOTE 3: Selective replacement is only performed for frames with the same SN. This requires error free reception of the B0 subfield (i.e. the subfield containing the SN).

If after buffering for L(R) TDMA frames, out-of-sequence frames remain out-of-sequence, the frames shall nonetheless be delivered to higher functions, together with an indication reporting the missing frames. The receiving entity shall then act as though the frames had been received in sequence. In particular, the RN shall be updated to acknowledge acceptance of these frames.

Whenever frames are delivered to the higher functions, the RN shall be set equal to the highest delivered SN + 1.

14.3.4 Class 2 procedures

14.3.4.0 General

Class 2 operation uses both SNs and RNs. The RNs provide both window control to avoid possible sequencing errors, and also invoke automatic DLC retransmission. The DLC retransmission may operate in Go_Back_N or in SElective (SEL)retransmission protocol.

14.3.4.1 Sending side procedure

14.3.4.1.0 General

The sending entity shall add SNs to all PDUs to be transmitted in frames in the order specified by that entity.

The PDUs shall be submitted to the MAC layer in the order of ascending SN, taking into account the modulus operation of the sequence numbering.

NOTE 1: Sequence number 0 is higher than sequence number (modulus-1).

NOTE 2: This rule means that retransmissions always have priority relative to first transmissions.

The sending entity shall maintain a maximum window size between the SN and the last received RN. The maximum window size shall be:

- (Modulus-1) when using GbN;
- (Modulus div 2) when using SEL.

A lower maximum value may be negotiated at call establishment (see clause 14.2.4). A smaller operating window size may be unilaterally adopted by the sending entity at any time.

Due to the modulo operation, each SN may be re-used several times during the life of the link. The minimum interval between reuse shall meet the following requirement:

- an SN shall not be reused within L(S) TDMA frames of the most previous use of that number.

The value of L(S) shall be determined by the protocol used:

- using I_p-error-correction, L(S) shall be equal to the MAC packet lifetime+1 (as defined at service establishment);
- using I_p-error-detection, L(S) shall be equal to 2.

Whenever the window size limit is reached (thereby halting further transmissions) the sending side shall commence retransmission of all outstanding PDUs not already expired, starting from the oldest unacknowledged PDU. This automatic retransmission shall be stopped whenever a usable RN is received (i.e. a RN that acknowledges one or more outstanding PDUs), and normal transmission or retransmission procedures will be resumed.

Received RN with the A/N bit set to "1" or with NA bits indicating an acknowledge, shall be treated as a positive acknowledgement for all PDUs up to and including the PDU number RN - 1. This positive acknowledgement shall cause an immediate stop to any redundant (unnecessary) retransmissions that may have been scheduled as a result of previously received negative acknowledgements.

Received RNs with the A/N bit set to "0" shall be treated as a negative acknowledgement for the single PDU number RN. Receipt of a NACK shall cause a retransmission of the indicated PDU(s) using the agreed retransmission protocol (selective or GO_Back_N as appropriate).

If the maximum window size is reached, no new PDUs will be inserted in the window.

As soon as a SDU is delivered from the upper layer to the DLC, a timer shall be associated with it. The SDU lifetime shall be equal to T(R) TDMA frames. Whenever a timer reaches the T(R) value, the respective SDU shall be considered expired and not (re)transmitted anymore.

The transmitting window shall not shift due to the expiry of those PDUs belonging to the expired SDU.

NOTE 3: In order to shift the window, the transmitter should wait for the reception of the Acknowledge to the synchronization message.

If a PDU contains (parts of) more than one SDU, the lifetime is associated to the lifetime of the last SDU in this PDU.

The lifetime limit should be defined at call establishment by means of the Information Element <<Transit Delay>>. If the lifetime limit is not specified at call establishment the following value shall apply:

- T(R) = infinite TDMA frames.

NOTE 4: When a PDU is about to be discarded due to lifetime expiry then the transmitter may re-transmit this PDU in an attempt to prevent data loss.

NOTE 5: The value T(R) should normally be negotiated with the <<transit-delay>> element during call establishment (see ETSI EN 300 175-5 [5] and ETSI EN 301 649 [17]), and may be also changed using Service Change operation (see ETSI EN 301 649 [17]).

During the lifetime the transmitter may retransmit the PDU. Retransmissions shall be stopped when the PDU, or a PDU with highest SN, is acknowledged.

14.3.4.1.1 Synchronization message sending side procedure (LU10)

A synchronization message shall be sent after data has timed out at the transmitter. The synchronization message contains no data (PDU) but it shall be treated by the sending entity as if it were a PDU.

The synchronization frame shall have the following structure.

Bit	8	7	6	5	4	3	2	1	Octet
	S8	S7	S6	S5	S4	S3	S2	S1	1
	S9	1	1	1	1	1	1	0	2
	Payload								3
									:
									:
									:
									:
									:
									:
									:
									:
									:
	:	FUxN							

Figure 14.3.4.1.1.1: Synchronization message frame

Where:

- the length indicator is filled with 6 bits as the value "63" is used to indicate a synchronization frame;
- the send sequence number field contains the send sequence number of the last expired PDU;
- the M bit is set to 0;
- the content of the payload is irrelevant and shall be discarded.

NOTE 1: The recommended practice at Tx is filling the payload with the fill field pattern defined in clause 13.5.

NOTE 2: Length indicator value 63 combined with M bit set to 1 is used for insertion of FU10c or FU10d frame. See clause 12.11.2.1.

When one or more PDUs expire, then the last expired PDU shall be replaced by the synchronization message. The synchronization message shall contain the sequence number of this PDU.

NOTE 3: Expiry of all PDUs in the transmit window will cause a re-transmit of the synchronization message only, until acknowledge. Then the transmit window can advance and take new PDUs.

Acknowledge of the synchronization message shall use a special synchronization acknowledge to indicate the correct reception of the synchronization message. When the transmitter receives this acknowledge, it knows the receiver has re-synchronized its window and the transmitter is also allowed to move the transmit window forward, accepting new PDUs for transmission.

14.3.4.1.2 Tx side end-of-activity rule

Applicability

This rule applies and is mandatory to support when the following conditions are met:

- the DPRS system operates with ME Class 1, 2, 3 or 4 (see ETSI EN 301 649 [17]);

NOTE 1: For ME Classes supporting suspend/resume (ME Class 1, 2 or 3, see ETSI EN 301 649 [17]), *end of activity* is a sufficient pre-condition for suspending the link. For ME Class 4, end of activity prevents an endless loop of acknowledgements (with no data).

- AND the DLC U-plane service (LUx) is using transmission Class 2 (clause 14.3.4);
- AND the DLC U-plane service (LUx) is using any of the frames that may carry embedded acknowledgement messages (such as FU10b or FU10a with insertion of FU10c or FU10d).

Rule

When the following situation is reached:

- there is only one PDU in the transmitter window (all previous PDUs have already been sent and acknowledged);
- AND this PDU has been sent once (and only once);

NOTE 2: As a result of Rx side end of activity rule (see clause 14.3.4.2.2) this PDU should not have been acknowledged. However, the rule still applies if it has been acknowledged (which results in the transmitter window becoming empty).

- AND this PDU contains only a positive Acknowledgement command (ACK) OR an Acknowledgement command to a Synchronization message.

THEN, the following shall apply:

- this PDU shall never expire;
- AND this PDU shall not be retransmitted.

NOTE 3: Therefore, a synchronization message will not be sent, as long as such PDU is the only one in transmitter window.

NOTE 4: If further data is received for transmission, then new PDUs will have a maximum lifetime associated with each of them and this may cause the sending of a synchronization message as described in clause 14.3.4.1.1.

NOTE 5: This rule, in combination with the Rx rule (see clause 14.3.4.2.2), are in charge of stopping the DLC exchange when there is no user data to be transmitted. The resulting state (one PDU in transmitter window containing only an Acknowledgement message) is one of the two possible stationary states after end of data activity (the other possible state is no PDU in transmitter window).

14.3.4.1.3 Abnormal SDU termination/abort signal (LU10 only)

In a normal transmission of an SDU, the last information sub-segment should be preceded by a Length indicator octet coded with a length of information different from zero and the M bit equal to zero.

The insertion of a Length indicator octet with the codes "Length of information" equal to "0" and M bit equal to "0", when there is an SDU that has not been completely transmitted (previous Length indicator preceding info field transmission had the M bit equal to "1") shall be understood as abnormal termination of the SDU.

The signal means that the transmission of the SDU ends (therefore a new SDU will start after the next Length indicator with $1 \leq LI \leq 62$, in the next PDU), and that such SDU is incomplete or corrupted.

The general properties of the LI = "0", M="0" code also apply here. Therefore, the rest of the PDU shall be discarded and the next SDU shall start in the next PDU carrying payload (generally the next PDU, however it is possible to leave it blank by using again the (LI="0", M="0") code.

The PDU boundaries, or the inclusion of Length indicators without info field, or FU10c frames in between the last SDU sub-segment and the abort signal may happen and do not modify the signal meaning.

NOTE 1: The Length indicator octet with the codes "Length of information" equal to "0" and M bit equal to "0" may be in the same PDU transporting the last info field of the SDU, or in the next one. In the second case, there may be one or several insertions of FU10c/FU10d frames (with the special code LI = 63, M=1) before the transmission of Length indicator with the SDU abort signal (LI=0, M=0). In both cases there may be Length indicators with LI=0 and M=1.

NOTE 2: The utility of the abort signal is relevant in the cases when similar signals may be received by the sending side by external data links, or when the early transmission option (see clause 11.12.3.1.1) is used and there is a mistake in an SDU partially transmitted. The abort signal may be used to prevent the receiver side from assembling an incomplete or corrupted SDU.

14.3.4.1.4 Retransmission procedure

At the first transmission of a PDU, the Tx shall start timer <DLU.02> (see clause A.2).

Tx shall not re-transmit the PDU before <DLU.02> expiry. The Tx shall retransmit the PDU after <DLU.02> expiry if it was not received in the meantime.

NOTE: The primary purpose of this timeout is to give a delay to the Rx for sending the ACK to the Tx without the PDU being already re-transmitted.

14.3.4.2 Receiving side procedure

14.3.4.2.0 General

The receiving entity shall accept data packets from the MAC layer in any order. Packets marked as type "unknown" and any packets that are indicated to contain errors shall be discarded. The remaining packets shall be assumed to contain valid PDUs, and shall be processed in their order of arrival. PDUs with sequence number outside the receive window shall be discarded. Only a synchronization message shall be accepted always, even if the sequence number is outside the receive window. Duplicate PDUs shall also be discarded.

NOTE 1: If a valid PDU was discarded due to duplication, the last acknowledge should be retransmitted.

"In-sequence PDUs" are defined as a series of one or more received PDUs that contain no errors and that contain SN(s) that together form a continuous series of SNs starting from the beginning of the receiver window.

"In-sequence PDUs pending for delivery" are the in-sequence series of PDUs ending at the highest in-sequence SN, but starting with the SN of the first PDU that has not been already completely delivered to higher layers.

NOTE 2: The "In-sequence PDUs pending for delivery" will be taken into account for the SDU delivery process only.

NOTE 3: The beginning point of the "in-sequence PDUs" and the "In-sequence PDUs pending for delivery" may differ due to two factors:

- 1) the delivery of data to highest layers combined with some delay in sending ACKs may cause momentarily the advance of the lowest SN in the "In-sequence PDUs pending for delivery" faster than in the "In-sequence PDUs";
- 2) in case of sending ACK to a correctly received in-sequence PDU that does not contain an SDU boundary, the reception window shifts at the receiver, but the "In-sequence PDUs pending for delivery" remains starting at the same point that now is older than the start of the Rx window.

NOTE 4: The data in the "In-sequence PDUs pending for delivery" older than the beginning of the reception window is data completely received and acknowledged from Class 2 procedures point of view. The PDU SNs information is no longer relevant. This data may be pre-assembled and moved to a different buffer starting with the initial SDU boundary (the buffered data should be always the beginning part of an SDU). In case of large SDU, the buffered data may be even larger than the reception window.

"Out-of-sequence PDUs" are defined as all other PDUs (i.e. set of sequences of one or more correctly received PDUs) that do not form a continuous series with the in-sequence part.

14.3.4.2.1 Acknowledgement procedure

Received PDUs that are the "in-sequence" part of the window, or that allow to complete the in-sequence part, shall be acknowledged to the Tx side within a reasonable time of its reception even if no further PDUs are received. More specifically:

- The acknowledge message shall carry as RN the highest SN of the received "in-sequence PDUs", plus one. The value of SN shall be always updated at the time the message is sent.
- **For multi-bearer connections:** the algorithm for deciding when and how often the acknowledgements have to be sent is free to the implementer, however the end of activity rule described in clause 14.3.4.2.2 shall be fulfilled.

- **For single bearer connections:** Rx shall acknowledge in-sequence PDUs every k PDUs received, with k between 1 and 8 (unless end of activity rule on Rx side applies, see clause 14.3.4.2.2):
 - The value of k should remain above 4 in normal transmission conditions.

For applying this rule, the counting of received PDUs shall include:

- all types of PDUs, i.e. whether they contain data, ACKs and possibly NACKs (i.e. if FU10c frames are sent as PDUs of the reverse channel);
- first time transmitted PDUs, as well as retransmitted PDUs.

EXAMPLE 1: In a single-bearer connection, if Tx can send PDUs in each of the 10 ms frames, then in 80 ms time, Tx can send 8 PDUs. If $k=4$, then Rx will send 2 ACKs for all these PDUs. But there could be some transmission conditions where the Tx cannot load each frame with a PDU (due for instance to application layer delays), then the k value should be chosen accordingly (i.e. reduced).

EXAMPLE 2: In a single-bearer connection, consider the use case where *Tx only is sending data* (so Rx only sends FU10c frames). In addition to sending data, Tx also needs to acknowledge FU10c frames from Rx. Assume also that Rx and Tx both use a fixed value of $k=4$. Tx thus sends an acknowledgment every 4 FU10c frames received from Rx. More specifically, if $n=1+16k+i$, with $k \geq 0$ and $i \in [0..15]$:
 - PDU(n) from Tx is a data PDU if $k=0$ and $i \in [0..15]$ and if $k \geq 1$ and $i \in [1..15]$
 - PDU(n) from Tx is an FU10c frame acknowledging FU10c frames from Rx in all other cases ($k \geq 1$ and $i=0$).

```

PT ===== PDU(1)[data]====> FT   PT ===== PDU(17)ACK 5 ====> FT   PT ===== PDU(33)ACK 9 ====> FT
PT ===== PDU(2)[data]====> FT   PT ===== PDU(18)[data]====> FT   PT ===== PDU(34)[data]====> FT
PT ===== PDU(3)[data]====> FT   PT ===== PDU(19)[data]====> FT   PT ===== PDU(35)[data]====> FT
PT ===== PDU(4)[data]====> FT   PT ===== PDU(20)[data]====> FT   PT ===== PDU(36)[data]====> FT
PT <==== PDU(1) ACK 5 ===== FT   PT <==== PDU(5) ACK 21 ===== FT   PT <==== PDU(9) ACK 37 ===== FT
PT ===== PDU(5)[data]====> FT   PT ===== PDU(21)[data]====> FT   PT ===== PDU(37)[data]====> FT
PT ===== PDU(6)[data]====> FT   PT ===== PDU(22)[data]====> FT   PT ===== PDU(38)[data]====> FT
PT ===== PDU(7)[data]====> FT   PT ===== PDU(23)[data]====> FT   PT ===== PDU(39)[data]====> FT
PT ===== PDU(8)[data]====> FT   PT ===== PDU(24)[data]====> FT   PT ===== PDU(40)[data]====> FT
PT <==== PDU(2) ACK 9 ===== FT   PT <==== PDU(6) ACK 25 ===== FT   PT <==== PDU(10) ACK 41 ===== FT
PT ===== PDU(9)[data]====> FT   PT ===== PDU(25)[data]====> FT   PT ===== PDU(41)[data]====> FT
PT ===== PDU(10)[data]====> FT   PT ===== PDU(26)[data]====> FT   PT ===== PDU(42)[data]====> FT
PT ===== PDU(11)[data]====> FT   PT ===== PDU(27)[data]====> FT   PT ===== PDU(43)[data]====> FT
PT ===== PDU(12)[data]====> FT   PT ===== PDU(28)[data]====> FT   PT ===== PDU(44)[data]====> FT
PT <==== PDU(3) ACK 13 ===== FT   PT <==== PDU(7) ACK 29 ===== FT   PT <==== PDU(11) ACK 45 ===== FT
PT ===== PDU(13)[data]====> FT   PT ===== PDU(29)[data]====> FT   PT ===== PDU(45)[data]====> FT
PT ===== PDU(14)[data]====> FT   PT ===== PDU(30)[data]====> FT   PT ===== PDU(46)[data]====> FT
PT ===== PDU(15)[data]====> FT   PT ===== PDU(31)[data]====> FT   PT ===== PDU(47)[data]====> FT
PT ===== PDU(16)[data]====> FT   PT ===== PDU(32)[data]====> FT   PT ===== PDU(48)[data]====> FT
PT <==== PDU(4) ACK 17 ===== FT   PT <==== PDU(8) ACK 33 ===== FT   PT <==== PDU(12) ACK 49 ===== FT

```

etc.

NOTE 1: When the end of a column is reached, the exchange continues on the next column.

NOTE 2: The pattern of the first column is special. The pattern of the 2nd column is repeated indefinitely (first repetition is shown on the 3rd column).

NOTE 3: In this ideal situation where there is no retransmission, Tx uses 15/16 of the bandwidth sending data, and 1/16 of the bandwidth sending FU10c frames (except for the first column of exchanges). This is only true when one of the sides (here FT) does not send any data. In the case of a symmetric exchange (both sides sending data), the remaining bandwidth for data drops to 3/4 in both directions as said in the next note.

Figure 14.3.4.2.1.1: Example with PT only sending data in the ideal situation with no retransmission (Illustration of the example 2)

NOTE 1: The allowed range of values for k for *single-bearer* connections is related to Tx window max size of 32: it is chosen so that $k \geq 1$ remains smaller or equal to 1/4th of the max Tx window size (i.e. 8). Similarly, the value of k in normal transmission conditions should be greater or equal to 1/8th of the max Tx window size (i.e. 4).

NOTE 2: A large value of k (say '8' for *single-bearer* connections) maximizes the use of bandwidth. However, due to interference, if one of the PDUs did not reach the Rx, then the Rx should not keep waiting for the PDUs (a large value of k could cause this).

NOTE 3: For both, *single-bearer* and *multi-bearer* connections, a correct adjustment of the value of 'k' with respect to the transmission conditions and to the value of <DLU.02> defined in clause A.2 (see also clause 14.3.4.1.4) is therefore crucial for an optimized use of the bandwidth.

NOTE 4: In example 2, Rx does not need to specifically acknowledge FU10c frames from Tx (i.e. does not need to send specific acks for Tx acks of Rx acks), because ACKs are cumulative. Acks from Rx acknowledge all types of Tx PDUs, whatever their content (either data or FU10c frames).

NOTE 5: For both, *single-bearer* and *multi-bearer* connections, a trade-off should be made by the implementer between acknowledge speed and throughput of the return channel. Sending an acknowledge for every received in-sequence PDU can block the return channel if only one return bearer is available, so this is inefficient and can cause data timeout on the return channel, but delivers the lowest round-trip delay. When an acknowledge is sent very seldom, the throughput of the return channel is optimal, but round-trip delay suffers or even the forward channel may get filled with re-transmits of packets that are regarded as timed-out by the transmitter. An example: when in-sequence PDUs are acknowledged every 4 frames, this takes only 25 % of the capacity of one return bearer.

14.3.4.2.2 Rx side end-of-activity rule

Applicability

This rule applies and is mandatory to support when the following conditions are met:

- the DPRS system operates with ME Class 1, 2, 3 or 4 (see ETSI EN 301 649 [17]);

NOTE 1: For ME Classes supporting suspend/resume (ME Class 1, 2 or 3, see ETSI EN 301 649 [17]), *end of activity* is a sufficient pre-condition for suspending the link. For ME Class 4, end of activity prevents an endless loop of acknowledgements (with no data).

- AND the DLC U-plane service (LUx) is using transmission Class 2 (clause 14.3.4);
- AND the DLC U-plane service (LUx) is using any of the frames that may carry embedded acknowledgement messages (such as FU10b or FU10a with insertion of FU10c/FU10d).

Rule

When the following situation is reached:

- there is only one PDU in the receiver window; AND
- this PDU only contains a positive Acknowledgement command (ACK) OR an Acknowledgement command to a Synchronization message.

THEN, the receiver SHALL NOT send any ACK for this PDU.

NOTE 2: The receiver will however re-start the sending of ACKs if further PDUs are received.

NOTE 3: This rule, in combination with the Tx rule (see clause 14.3.4.1.2) are in charge of stopping the DLC exchange when there is no user data to be transmitted. The resulting state (one PDU in receiver window containing only an Acknowledgement message) is one of the two possible stationary states after end of data of activity (the other possible state is no PDU in receiver window).

14.3.4.2.3 Retransmission request procedure

If after buffering for L(R) TDMA frames, out-of-sequence remains out-of-sequence, the receiving entity should return a composed NACK message.

After that, as long as the out-of-sequence PDUs remain out-of-sequence, they shall continue to be buffered and at most one composed NACK message may be sent in any period of L(R) TDMA frames.

Out-of-sequence PDUs may become in-sequence PDUs due to the arrival of one or more of the missing PDUs.

For the GBN protocol a NACK shall carry a single value of RN, set equal to the lowest numbered missing PDU. For the SEL protocol, multiple RN values shall be returned; one for each missing PDU.

NOTE: In GBN, out of sequence PDUs may be discarded during this buffer period, in order to limit buffer sizes.

The value of L(R), shall be determined by the service used:

- when using the I_p-error-correction protocol:
 - L(R) = (MAC packet lifetime+1).
- when using the I_p-error-detection protocol:
 - L(R) = 1 TDMA frames.

14.3.4.2.4 SDU delivery procedure

Both, the "In-sequence PDUs pending for delivery" and the "out-of-sequence PDUs", may be used for delivering data to higher layers, according to the specific rules given for each LUX service. For the LU10 service, see clause 11.12.3.2 for the different delivery modes.

14.3.4.2.5 Synchronization message receiver side procedure (LU10)

As soon as a synchronization message has been received, the RN shall be set to one higher than the value of the SN contained in the synchronization message and all the buffered PDUs with an SN lower than or equal to the received one should be discarded.

This operation also clears the data pending for delivery older than previous beginning of the window. Therefore, the initial point of both "in-sequence PDUs" and "In-sequence PDUs pending for delivery" is now the same and set to the SN sent in the synchronization message plus one.

NOTE 1: Discarding these PDUs guarantees the maximum lifetime. Synchronization indicates their lifetime has expired.

The re-synchronization shall be sent to higher functions to indicate a discontinuity in PDU numbering.

NOTE 2: Actual numbering might be continuous due to the modulo numbering scheme.

The synchronization message shall always be acknowledged using a special synchronization acknowledge, in order to indicate that the transmitter can advance its link. The synchronization acknowledge can have three formats, depending on the frame format used in the link:

- a) links using FU10b frame format shall use the same format as the synchronization message for the synchronization acknowledge: the Length Indicator has value 63 and the sequence number of the synchronization message is returned;
- b) links using frame formats FU10a/FU10c shall use the FU10c ACK/NACK message with a special coding for NA1 and NA2 bits = 0,0 as shown in figure 14.3.4.2.5.1. This message can be transmitted either by the G_F channel or by insertion in the FU10a frame of the opposite channel;

Bit	8	7	6	5	4	3	2	1	Octet
	RSN # 1, ER8 – ER1								1
	RSN # 2, ER8 – ER1								2
	RSN # 3, ER8 – ER1								3
	RSN # 4, ER8 – ER1								4
	RSN # 5, ER8 – ER1								5
	RSN # 6, ER8 – ER1								6
	NA1	NA2	RSN #6, ER9	RSN #5, ER9	RSN #4, ER9	RSN #3, ER9	RSN #2, ER9	RSN #1, ER9	7

Figure 14.3.4.2.5.1: Frame FU10c, 9 Bit sequence numbering

- c) links using frame formats FU10a/FU10d shall use the FU10d full format with bit ACK/NACK set to "1" (ACK) and the sequence number of the synchronization message as RSN. This message shall be transmitted either by the G_{FA} channel or by insertion in the FU10a frame of the opposite channel.

The interpretation of the RSNs as either ACKs or NACKs is indicated by bits NA1 and NA2.

Bit	NA1	NA2	Meaning
	0	0	This frame contains an Ack of a synchronization message in RSN#1, no NACKs
	0	1	This frame contains only one ACK message in RSN#1, no NACKs
	1	0	This frame contains one ACK message in RSN#1 plus five NACK messages in RSN#2-RSN#6
	1	1	This frame contains six NACK messages

14.3.4.2.6 Reception of an abnormal SDU termination/abort signal (LU10)

In the event of receiving an abnormal SDU termination / abort signal, as defined in clause 14.3.4.1.3, the receiving entity shall discard the abnormally terminated SDU and shall not pass it to higher layers. In implementations when delivering of SDU to higher layers is allowed before SDU termination (i.e. PDU delivery mode), then an "abort" signal shall be passed and the receiving entity shall be in charge of handling the abnormal condition.

NOTE 1: In most cases, it means discarding the whole SDU. In some cases, for instance, when part of the SDU was released out of the DECT system, by a data link (i.e. by a TCP connection), it means the transmission of an equivalent "abort" signal by such connection. If there is no way to do that, then the DECT system should not release externally parts of the SDU before the complete reception of it.

NOTE 2: In some special cases, for instance, when the transported payload is an application protocol, the destination application layer entity may handle the abnormal case in its own way.

14.3.5 Class 3 procedures

14.3.5.0 General

Class 3 operation uses both SNs and RNs. The RNs provide both window control to avoid possible sequencing errors, and also invoke automatic DLC retransmission. The DLC retransmission shall operate a selective retransmission protocol, combined with a lifetime limit on all packets to provide a guaranteed throughput.

14.3.5.1 Sending side procedure

The sending entity shall add SNs to all frames in the order specified by that entity. The I/R bit shall be set to "1" for the first transmission and to "0" for all retransmissions.

The resulting frames shall be submitted to the MAC layer in the order of ascending SN.

NOTE 1: This rule means that retransmissions always have priority relative to first transmissions.

The sending entity shall maintain a maximum window size between the SN and the last received RN. The maximum window size shall be equal to the (Modulus) of the SN used. A lower maximum value may be negotiated at call establishment (see clause 14.2.4). A smaller operating window size may be unilaterally adopted by the sending entity at any time.

Due to the modulus operation, each SN may be re-used several times during the life of the link. The minimum interval between re-use shall meet the following requirements:

- 1) a SN shall not exceed the maximum window size;
- 2) a SN shall not be re-used within L(S) TDMA frames of the most recent previous use of that number.

The value of L(S) shall be equal to 2.

The maximum lifetime of each frame shall be limited to T(R) TDMA frames. This lifetime limit should be defined at call establishment, and shall not be subsequently changed. When this limit is exceeded for a given frame, the frame shall not be retransmitted (or transmitted) and the data should be discarded. If the lifetime limit is not specified at call establishment the following value shall apply:

- T(R) default value shall be 15 TDMA frames.

NOTE 2: The value T(R) should normally be negotiated with the <<transit-delay>> element during call establishment (see ETSI EN 300 175-5 [5]).

The discarding of a frame shall not be treated as equivalent to acknowledgement of the SN. In all cases, the SN of that frame shall not be reused until the SN has been acknowledged by the peer. The peer entity maintains a corresponding lifetime limit, and should normally issue a (false) acknowledgement for expired frames when their lifetime limit is reached.

Whenever the window size limit is reached (thereby halting further transmissions) the sending side shall commence retransmission of all unexpired but outstanding frames, starting from the oldest unacknowledged frame. This automatic retransmission shall be stopped whenever a usable RN is received (i.e. an RN that acknowledges one or more outstanding frames), and normal transmission or retransmission procedures will be resumed.

Received RNs with the A/N bit set to "1" shall be treated as a positive acknowledgement for all frames up to an including the frame number RN - 1. This positive acknowledgement shall cause an immediate stop to any redundant (unnecessary) retransmissions that may have been scheduled as a result of previously received negative acknowledgements.

Received RNs with the A/N bit set to "0" shall be treated as a negative acknowledgement for the single frame number RN. Receipt of a NACK shall cause a selective retransmission of the indicated frame(s).

14.3.5.2 Receiving side procedure

The receiving entity shall accept data packets from the MAC layer in any order. Packets marked as type "unknown" and any packets that are indicated to contain errors in the first portion (MAC subfield B0) shall be discarded. The remaining packets are assumed to contain valid frames, and shall be processed in their order of arrival.

In-sequence frames are defined as a series of one or more frames that contain no errors and that contain SN(s) that together form a continuous series of SNs when considered together with other received but undelivered frames. All in-sequence frames shall be immediately delivered to the higher functions.

NOTE 1: Most higher function users of class 3 retransmission are expected to provide frame buffering such that a continuous flow of data is produced. The buffer size should be greater than the product of connection bandwidth and maximum frame lifetime.

Out-of-sequence frames are defined as all other frames (i.e. a sequence of one or more frames that do not form a continuous series of SNs or contain some errors). These frames may only be delivered after they have been buffered for T(R) TDMA frames after their arrival. During this buffering period, out-of-sequence frames may become in-sequence frames due to the arrival of one or more missing frames. In this event, the frames shall be immediately delivered to the higher layer.

As soon as an out-of-sequence frame is detected the receiving entity shall return an immediate negative acknowledgement, by returning at least one frame containing the missing RNs and the A/N bit set to "0". If necessary, multiple RN values shall be returned; one for each missing frame.

NOTE 2: Out of sequence frames may be discarded before this time limit, in order to limit buffer sizes.

The value of T(R) shall be equal to the maximum frame lifetime. This lifetime limit should be defined at call establishment, and shall not be subsequently changed. If the lifetime limit is not specified at call establishment the following value shall apply:

- T(R) default value shall be 15 TDMA frames.

NOTE 3: The value T(R) should normally be negotiated with the <<transit-delay>> element during call establishment (see ETSI EN 300 175-5 [5]).

During the total buffering period $T(R)$ a frame may arrive that is a duplicate of one of the buffered frames. If the original buffered frame was correct, any such duplicates shall be discarded. If the original buffered frame contained errors, the duplicate may be used to correct those errors, using selective replacement of erroneous portions (replacement of MAC BN subfields).

NOTE 4: Selective replacement is only performed for frames with the same SN. This requires error free reception of the B0 subfield (i.e. the subfield containing the SN).

If after buffering for $T(R)$ TDMA frames, out-of-sequence frames remain out-of-sequence, all of the valid frames shall nonetheless be delivered to higher functions, together with an indication for all missing frames. The receiving entity shall then act as though the frames had been received in sequence. In particular, the RN shall be updated to acknowledge acceptance of these frames.

Whenever frames are delivered to the higher functions, the RN for all positive acknowledgements shall be set equal to the highest delivered SN + 1.

Annex A (normative): System parameters

A.1 LAPC timer values

Table A.1.1

<DL.00>	Link release timer	
FT value:	2 s	
PT value:	2 s	
Start:	DISC command frame is transmitted	
Stop:	UA response frame is received	
<DL.01>	Link suspend timer	
FT value:	2 s	
PT value:	2 s	
Start:	DISC command frame is transmitted	
Stop:	UA response frame is received	
<DL.02>	Class B establish timer	
FT value:	2 s	
PT value:	2 s	
Start:	Class B request frame is transmitted	
Stop:	Class B accept or reject frame is received	
<DL.03>	Link resume timer	
FT value:	2 s	
PT value:	2 s	
Start:	SABM or I-command frame is transmitted	
Stop:	resume accept frame is received	
<DL.04>	Retransmission timer	
	C_F routed frames	C_S routed frames
FT value:	2 s	2 s
PT value:	2 s	2 s
Start:	an I-frame is transmitted	
Stop:	an acknowledgement is received for that frame	
<DL.05>	Connection handover timer	
FT value:	10 s	
PT value:	10 s	
Start:	the involuntary CHP condition is entered	
Stop:	connection handover successfully completed	
<DL.06>	Connection handover interval timer	
FT value:	4 s	
PT value:	4 s	
Start:	after N251 successive connection handover attempts without success or after a CHO is successfully completed	
Stop:	normal release	
<DL.07>	Class A establish timer	
FT value:	2 s	
PT value:	2 s	
Start:	a class A establish I-frame is transmitted	
Stop:	a class A RR-frame is received	

Additional LAPC timers are for further study.

A.2 U-plane timer values

Table A.2.1

<DLU.01>	Transmission class 1 timer
FT value:	2 s
PT value:	2 s
Start:	the window size limit is reached
Stop:	a valid acknowledge is received
<DLU.02>	Transmission class 2 timer on transmitter side for retransmitting last SN (see note)
FT value:	80 ms
PT value:	80 ms
Start:	After SN is transmitted
Stop:	ACK(RN) acknowledging that SN is received
NOTE:	SN is only retransmitted <i>after</i> timer expiry and only if the timer is not stopped before expiry.

Additional U-plane timers are for further study.

A.3 Constants

A.3.1 Retransmission counter (N250)

The maximum number of retransmissions of a frame, N250, is a system parameter. The default value shall be 3.

A.3.2 Maximum number of CHO attempts (N251)

The maximum number of successive connection handover attempts, N251, without success is 3.

NOTE: Implementers may adopt a lower value.

Annex B (normative): Checksum algorithms

B.1 Arithmetic conventions

Addition is performed in one of the two following modes:

- a) modulo 255 arithmetic;
- b) ones complement arithmetic in which if any of the variables has the value minus zero (i.e. 255) it is treated as plus zero.

B.2 Coding algorithm

- a) set Octet(FLEN) and Octet(FLEN-1) to zero;
- b) set the variables C0 and C1 to zero;
- c) for n: = 1 to FLEN do:

```

BEGIN;
C0:= C0 + Octet(n);
C1:= C1 + C0;
END.
```

The resulting C0 and C1 have the values:

- $C0 = \sum \{ \text{Octet}(n) \};$
- $C1 = \sum \{ (\text{FLEN} + 1 - n) \times \text{Octet}(n) \};$

where both summations run from $n = 1$ to $n = \text{FLEN}$.

NOTE: To the calculation of C1: multiplying checksum formula <1> of clause 7.10 with a factor (FLEN+1) and subtracting checksum formula <2> of clause 7.10 from this product leads to the relation:

$$\sum \{ (\text{FLEN} + 1 - n) \times \text{Octet}(n) \} = 0 \text{ <3>;}$$

where the summation runs from $n = 1$ to $n = \text{FLEN}$.

Therefore if the formulae <1> and <2> are both zero also formula <3> is satisfied, or: if formulae <1> and <3> are zero formula <2> is also satisfied.

- d) Octet(FLEN-1):= C0 - C1;
Octet(FLEN):= - 2 × C0 + C1.

B.3 Decoding algorithm

Perform steps b) and c) of the coding algorithm. Finally, if one or both of the parameters C0 and C1 do not have the value zero, the checksum formulae defined in clause 7.10 have not been satisfied.

B.4 Some examples

To verify correct implementation of the checksum calculation, two examples are given (hexadecimal notation):

EXAMPLE 1: Two octets of data: FE02 Calculated checksum FE00.

EXAMPLE 2: Three octets of data: 910001 Calculated checksum B7B5.

Annex C (informative): MAC connection states

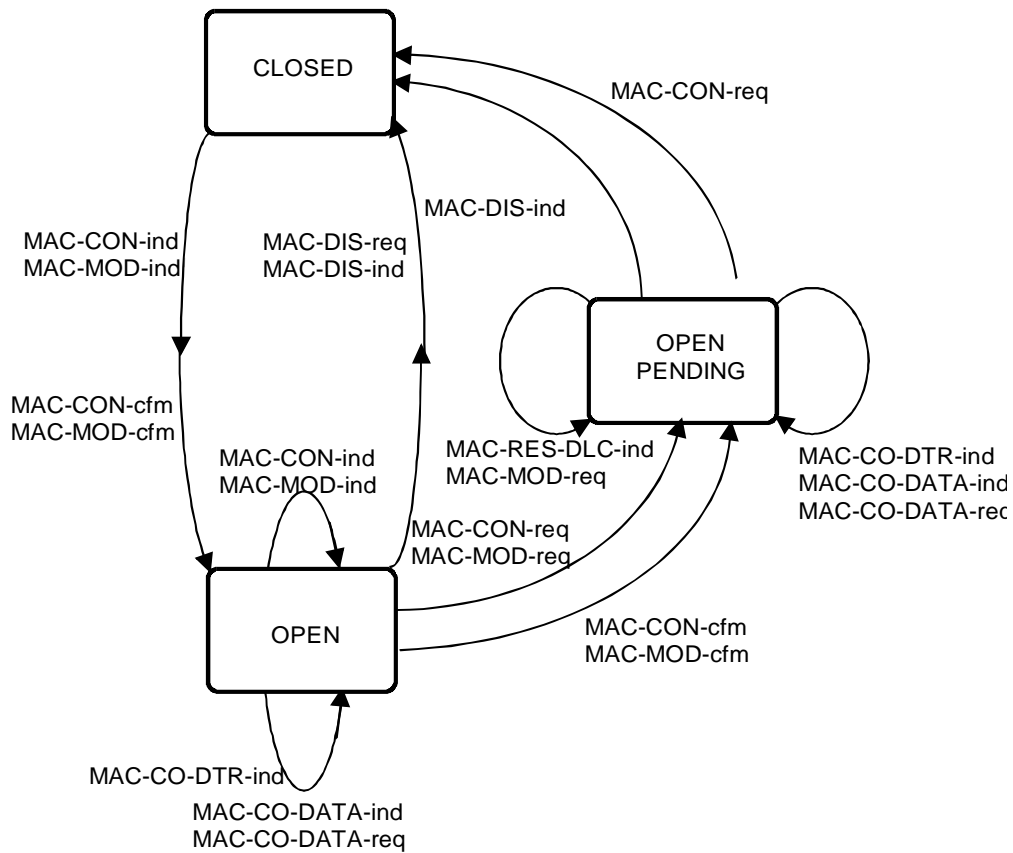

Figure C.1: MAC connection states as viewed by the DLC

Annex D (normative): Mapping of agreed channel rates to MCS sizes

D.0 General

The following tables show the service mappings that shall be used when implementing the LU5 basic rate adoption service. These tables show the mapping of all possible input channel rates onto 1, 2 or 3 multi-channel sets. Two tables are defined: one for class P (Protected) operation, and one for class N (unProtected) operation.

Alternative mappings shall not be used.

D.1 Protected class operation

Table D.1.1: Protected class MCS mapping

Ch 1 rate	Ch 2 rate	Ch 3 rate	MCS #1	MCS #2	MCS #3
64 kbit/s	64 kbit/s	64 kbit/s	P3/64	P3/64	P3/64
64 kbit/s	64 kbit/s	32 kbit/s	P3/64	P3/64	P2/32 a
64 kbit/s	64 kbit/s	16 kbit/s	P3/64	P3/64	P1/16
64 kbit/s	64 kbit/s	8 kbit/s	P3/64	P3/64	P1/16
64 kbit/s	64 kbit/s	none	P3/64	P3/64	none
64 kbit/s	32 kbit/s	32 kbit/s	P3/64	P3/32	none
64 kbit/s	32 kbit/s	16 kbit/s	P3/64	P3/32	none
64 kbit/s	32 kbit/s	8 kbit/s	P3/64	P3/32	none
64 kbit/s	32 kbit/s	none	P3/64	P3/32 a	none
64 kbit/s	16 kbit/s	16 kbit/s	P3/64	P2/16 b	none
64 kbit/s	16 kbit/s	8 kbit/s	P3/64	P2/16 b	none
64 kbit/s	16 kbit/s	none	P3/64	P1/16	none
64 kbit/s	8 kbit/s	8 kbit/s	P3/64	P1/8	none
64 kbit/s	8 kbit/s	none	P3/64	P1/8 a	none
64 kbit/s	none	none	P3/64	none	none
32 kbit/s	32 kbit/s	32 kbit/s	P3/32	P3/32 a	none
32 kbit/s	32 kbit/s	16 kbit/s	P3/32	P1/16	none
32 kbit/s	32 kbit/s	8 kbit/s	P3/32	P1/16	none
32 kbit/s	32 kbit/s	none	P3/32	none	none
32 kbit/s	16 kbit/s	16 kbit/s	P3/16	none	none
32 kbit/s	16 kbit/s	8 kbit/s	P3/16	none	none
32 kbit/s	16 kbit/s	none	P2/32	P1/16	none
32 kbit/s	8 kbit/s	8 kbit/s	P2/32	P1/16	none
32 kbit/s	8 kbit/s	none	P2/32	none	none
32 kbit/s	none	none	P2/32 a	none	none
16 kbit/s	16 kbit/s	16 kbit/s	P2/16 b	P1/16	none
16 kbit/s	16 kbit/s	8 kbit/s	P2/16	none	none
16 kbit/s	16 kbit/s	none	P2/16 b	none	none
16 kbit/s	8 kbit/s	8 kbit/s	P2/16	none	none
16 kbit/s	8 kbit/s	none	P2/16 b	none	none
16 kbit/s	none	none	P1/16 a	none	none
8 kbit/s	8 kbit/s	8 kbit/s	P2/16	none	none
8 kbit/s	8 kbit/s	8 kbit/s	P1/8	none	none
8 kbit/s	none	none	P1/16	none	none
a:	channel 2 not used;				
b:	channel 3 not used.				

D.2 Unprotected class operation

Table D.2.1: Unprotected class MCS mapping

Ch 1 rate	Ch 2 rate	Ch 3 rate	MCS #1	MCS #2	MCS #3
64 kbit/s	64 kbit/s	64 kbit/s	N2/64	N2/64	N2/64
64 kbit/s	64 kbit/s	32 kbit/s	N2/64	N2/64	N1/32
64 kbit/s	64 kbit/s	16 kbit/s	N2/64	N2/64	N1/32
64 kbit/s	64 kbit/s	8 kbit/s	N2/64	N2/64	N1/32
64 kbit/s	64 kbit/s	none	N2/64	N2/64	none
64 kbit/s	32 kbit/s	32 kbit/s	N2/64	N2/32	none
64 kbit/s	32 kbit/s	16 kbit/s	N2/64	N2/32	none
64 kbit/s	32 kbit/s	8 kbit/s	N2/64	N2/32	none
64 kbit/s	32 kbit/s	none	N2/64	N1/32	none
64 kbit/s	16 kbit/s	16 kbit/s	N2/64	N1/16	none
64 kbit/s	16 kbit/s	8 kbit/s	N2/64	N1/16	none
64 kbit/s	16 kbit/s	none	N2/64	N1/16 a	none
64 kbit/s	8 kbit/s	8 kbit/s	N2/64	N1/16	none
64 kbit/s	8 kbit/s	none	N2/64	N1/16 a	none
64 kbit/s	none	none	N2/64	none	none
32 kbit/s	32 kbit/s	32 kbit/s	N2/32	N1/32	none
32 kbit/s	32 kbit/s	16 kbit/s	N2/32	N1/32	none
32 kbit/s	32 kbit/s	8 kbit/s	N2/32	N1/32	none
32 kbit/s	32 kbit/s	none	N2/32	none	none
32 kbit/s	16 kbit/s	16 kbit/s	N1/32	N1/16	none
32 kbit/s	16 kbit/s	8 kbit/s	N1/32	N1/16	none
32 kbit/s	16 kbit/s	none	N1/32	N1/16 a	none
32 kbit/s	8 kbit/s	8 kbit/s	N1/32	N1/16	none
32 kbit/s	8 kbit/s	none	N1/32	N1/16 a	none
32 kbit/s	none	none	N1/32	none	none
16 kbit/s	16 kbit/s	16 kbit/s	N1/16	N1/16 a	none
16 kbit/s	16 kbit/s	8 kbit/s	N1/16	N1/16 a	none
16 kbit/s	16 kbit/s	none	N1/16	none	none
16 kbit/s	8 kbit/s	8 kbit/s	N1/8	none	none
16 kbit/s	8 kbit/s	none	N1/8 b	none	none
16 kbit/s	none	none	N1/8ab	none	none
8 kbit/s	8 kbit/s	8 kbit/s	N1/8	none	none
8 kbit/s	8 kbit/s	none	N1/8 b	none	none
8 kbit/s	none	none	N1/8ab	none	none

a: channel 2 not used;
b: channel 3 not used.

Annex E (normative): LU12 applications

E.1 G.729.1 over 32 kbit/s channel

E.1.0 General

The wideband 7 kHz G.729.1 codec 32 kbit/s voice service shall use the LU12 UNprotected Framed service (UNF, as defined by clause 11.14) over a single bearer MAC connection with a full slot.

Each 20 ms audio frame shall be segmented in two PDUs before transmission.

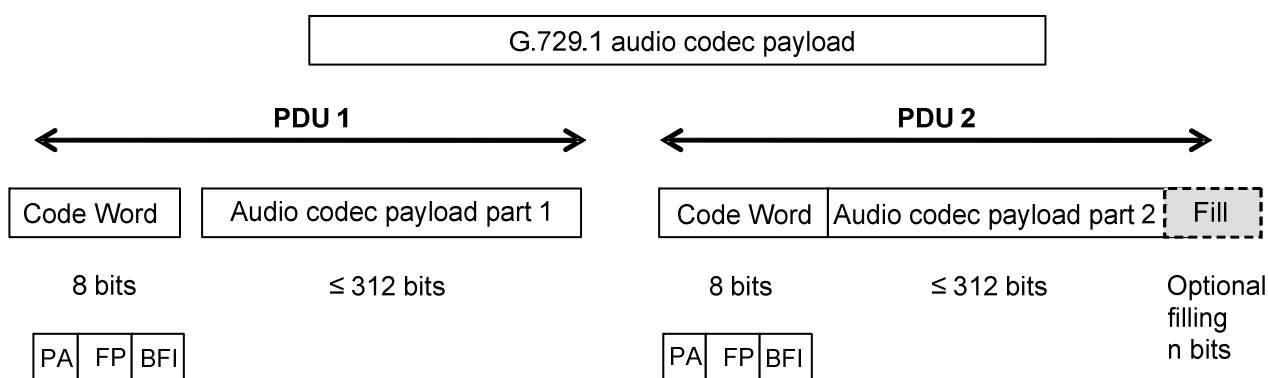

Figure E.1.0.1: Segmentation of 20 ms G.729.1 audio frame

At the receiving side, audio codec payload part 1 and 2 are simply concatenated to obtain the complete audio payload format described in clause E.1.1.

E.1.1 G.729.1 payload format

E.1.1.0 General

A coding similar to IETF RFC 4749 [i.5] is used.

G.729.1 is used at the maximum bit rate of 30 kbit/s in order to fit into the full slot FU12 PDU size (i.e. 312 bits) without filling octets. The audio codec frame is defined as in RFC.

G.729.1 payload format: 24 bits header + 600 bits max (case 30 kbits/s)

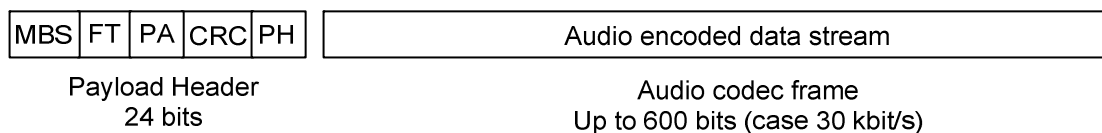

Figure E.1.1.0.1: G.729.1 SDU

E.1.1.1 G.729.1 payload header coding

The Payload header shall be coded as follows.

Bit	8	7	6	5	4	3	2	1	Octet
	MBS				FT				1
	PA				CRC				2
	PH				Reserved				3

Figure E.1.1.1.1: Payload header coding

Frame Type, FT field (octet 1):

FT field is the Frame type of the audio encoded data. The value of the FT field is set according to table E.1.1.1.1.

Table E.1.1.1.1: Values of the Frame Type (FT) field

Bits	4	3	2	1	Decimal	Meaning	Payload size
0	0	0	0	0	0	8 kbit/s	20 octets
0	0	0	1	1	1	12 kbit/s	30 octets
0	0	1	0	0	2	14 kbit/s	35 octets
0	0	1	1	1	3	16 kbit/s	40 octets
0	1	0	0	0	4	18 kbit/s	45 octets
0	1	0	1	1	5	20 kbit/s	50 octets
0	1	1	0	0	6	22 kbit/s	55 octets
0	1	1	1	1	7	24 kbit/s	60 octets
1	0	0	0	0	8	26 kbit/s	65 octets
1	0	0	1	1	9	28 kbit/s	70 octets
1	0	1	0	0	10	30 kbit/s	75 octets
1	0	1	1	1	11	32 kbit/s	80 octets
1	1	0	0	0	12	reserved	
1	1	0	1	1	13	reserved	
1	1	1	0	0	14	reserved	
1	1	1	1	1	15	NO_DATA	0 octet

The FT value 10 (i.e. 30 kbit/s) is the recommended value for G.729.1.

The FT value 11 (i.e. 32 kbit/s) is not possible on a DECT link using a full slot.

The FT value 15 (i.e. NO_DATA) indicates that there is no audio data in the payload. This MAY be used to update the MBS value when there is no audio frame to transmit. The payload will then be reduced to the payload header.

A payload with a reserved FT value shall be ignored.

Maximum Bit rate, MBS field (octet 1):

MBS field indicates the maximum bit rate to the encoder at the receiving side of this payload. The MBS is used to tell the peer side the maximum bit rate it can receive. The encoder SHALL exceed the sending rate indicated by the received MBS. Note that, due to the embedded property of the coding scheme, the encoder can send frames at the MBS rate or any lower rate. As long as it does not exceed the MBS, the encoder can change its bit rate at any time without previous notice.

The value of the MBS field is set according to table E.1.1.1.2.

Table E.1.1.1.2: Values of the Maximum Bit rate (MBS) field

Bits	8	7	6	5	Decimal	Meaning
0	0	0	0	0	0	8 kbit/s
0	0	0	1	1	1	12 kbit/s
0	0	1	0	2	2	14 kbit/s
0	0	1	1	3	3	16 kbit/s
0	1	0	0	4	4	18 kbit/s
0	1	0	1	5	5	20 kbit/s
0	1	1	0	6	6	22 kbit/s
0	1	1	1	7	7	24 kbit/s
1	0	0	0	8	8	26 kbit/s
1	0	0	1	9	9	28 kbit/s
1	0	1	0	10	10	30 kbit/s
1	0	1	1	11	11	32 kbit/s
1	1	0	0	12	12	reserved
1	1	0	1	13	13	reserved
1	1	1	0	14	14	reserved
1	1	1	1	15	15	NO_MBS

The MBS value 10 (i.e. 30 kbit/s) is the recommended value for G.729.1.

The MBS value 11 (i.e. 32 kbit/s) is not possible on a DECT link using a full slot.

Cyclic Redundancy Codes, CRC field (octet 2):

Table E.1.1.1.3: Values of the Parity bit protection (PA) field

Bits	7	6	5	4	3	2	1
	C0	C1	C2	C3	C4	C5	C6

The CRC field is a 7 bits Cyclic Redundancy Codes protection (bits 7 to 1) against random bit errors in the data block formed by the bits in position 285 to 340 (first bit is bit 0) in the audio encoded data stream. Therefore the data block length is 56 bits.

CRC generation: the 56 data bits shall be considered to be the coefficients of a polynomial having terms from x^{62} down to x^7 . The polynomial is built as:

$$b_{285} \times x^{62} + b_{286} \times x^{61} + \dots + b_{340} \times x^7$$

This polynomial is divided by the generating polynomial:

$$g(x) = x^7 + x^5 + x^4 + x^2 + x^1 + 1 = 0xB7 \text{ (Hex)}$$

The 7 check bits shall be the coefficients of the terms from x^6 to x^0 in the remainder polynomial, found at the completion of the division. The remainder polynomial has the form:

$$c_0 \times x^6 + c_1 \times x^5 + \dots + c_6 \times x^0$$

The coefficients c_0 to c_6 form the 7 check bits and are mapped in the CRC field as described in table E.1.1.1.3.

In the resulting $m = n + 7$ bit codeword, the leading n bits correspond to the original data bits.

Error detection at receiving side: it has to be ensured that the received m -bit codeword is a valid codeword. Again the m bits can be considered to be the coefficients of a polynomial having terms from x^{m-1} down to x^0 . If the m bits of the protected field are received in ascending order (r_0, r_1, \dots, r_{m-1}) the polynomial is built as:

$$r_0 \times x^{m-1} + r_1 \times x^{m-2} + \dots + r_{m-1} \times x^0$$

The generator polynomial $g(x)$ divides all valid codewords.

PARity bit protection, PA field (octet 2):

The PARity bit is used to protect the encoded audio data bits 240 to 244. Bit shall be set to 1 if the number of ones in the bits 240 to 244 of audio encoded data stream is odd, otherwise it shall be set to 0. This always makes the total number of ones, including the parity bit, even.

Parity Header bit, PH field (octet 3):

The Parity Header bit is used to protect the 16 first bits of the payload header. Bit shall be set to 1 if the number of ones in the 16 bits to protect is odd, otherwise it shall be set to 0. This always makes the total number of ones, including the parity bit, even.

E.1.2 Operations

E.1.2.1 Encoder bit rate

In the direction FP to PP, the default recommended value for MBS and FT is 10 (i.e. 30 kbit/s). In the direction FP to PP of course MBS and FT are dependent of what is really received from the distant but SHALL NOT be set to 11 which is a non authorized value on DECT link.

For FT below 10 (i.e. bit rate below 30 kbit/s) filling bits are used as necessary in PDUs.

24 kbit/s use case: a FT of 7 corresponds to a complete G.729.1 payload format frame of 24 (header) + 480 (audio frame) = 504 bits. PDU1 is then composed of a code word of value "00" Hex followed by the first 312 bits of G.729.1 payload format. PDU2 is composed of a code word of value "82" Hex followed by last 192 bits G.729.1 payload format, followed by 120 fill bits.

12 kbit/s use case: a FT of 1 corresponds to a complete G.729.1 payload format frame of 24 (header) + 240 (audio frame) = 264 bits. PDU1 is then composed of a code word of value "00" Hex followed by the full 264 bits of G.729.1 payload format, followed by 48 fill bits. PDU2 is composed of a code word of value "82" Hex followed by 312 fill bits.

In case of a bad indication frame (indicated with BFI = 1 in Code Word field), the G.729.1 payload format should be adapted with a FT of 15 (NO_DATA), a MBS of 15 (NO MBS) and a complete PDU of fill bits.

E.1.2.2 Protection against random errors

A one byte redundancy information is included in the payload header. It is composed of two parts:

- A 7 bit CRC is used to verify 56 bits in positions 285-340 in the audio codec frame (first position is the position 0). The used generator polynomial is "B7" Hex. This polynomial can detect 100 % 1, 2, 3, 5, 7, ... bit errors and more than 98 % of 4 and 6 bit errors. This CRC shall be calculated on a 600 bits audio frame. For bit rate below 30 kbit/s, audio payload frame shall be padded with "0" bits before CRC calculation.
- One parity bit used to verify 5 bits in positions 240-244 in the audio codec frame.

The redundancy information covers the only sensitive part of the G.729.1 bitstream to bit errors. It offers very strong benefit in terms of MOS score in case of random bit errors in the concerned bits. Other parts of the bitstream are very robust to random bit errors.

This dedicated CRC shall be inserted from FP to PP and from PP to FP directions and should replace the use of the original X-CRC as it is not codec optimized. Insertion on the FP side may be done upper in the network.

Annex F (informative): Bibliography

ETSI EN 300 176 (all parts): "Digital Enhanced Cordless Telecommunications (DECT); Test specification".

Annex G (informative): Change history

The following table presents main changes from a published version to the next version (published or to be published).

Subject/Comment	Old	New
The enhancement of the DECT base standard to support higher data rates includes the 16 QAM/64 QAM modulation option and the Channel Coding based on the Turbo Code Principle.	1.6.1	1.7.1
The enhancement of the DECT base standard to support DECT Broadband service and some minor editorial improvements.	1.7.1	1.8.1
Some editorial improvements.	1.8.1	1.9.1
New Generation DECT: A major revision of the DECT base standard introducing wideband speech, improved data services, new slot types and other technical enhancements.	1.9.1	2.1.1
Creation of DLC service LU12 and annex for codec G.729.1; Update of symbols and abbreviations list; Clarification in the use of synchronization acknowledge messages in Class 2 procedures; Editorial review.	2.1.1	2.2.1
Made figures 11.14.2.1, 11.14.2.1.1, E.1.1 and E.1.1.1, visible.	2.2.1	2.2.2
Re-edition due to format error in some figures. No technical changes.	2.2.2	2.2.3
Complete review of LU10 procedures.	2.2.3	2.3.1
New MAC services I_{PK} and I_{PKR} . Editorial review.	2.3.1	2.4.1
New LU Services LU13 and LU14; Introduction of CCM authenticated encryption; New channel G_{FA} and new frame type FU10d.	2.4.1	2.5.1
New C/L downlink multicast channel supporting CCM authenticated encryption; review of end-of-activity rule in Transmission Class 2.	2.5.1	2.6.1
No changes.	2.6.1	2.7.1
New Modulation and Coding Schemes. Support of multiple instances of DLC LU entities	2.7.1	2.8.1

History

Document history		
Edition 1	October 1992	Publication as ETSI ETS 300 175-4 (Historical)
Edition 2	September 1996	Publication as ETSI ETS 300 175-4 (Historical)
V1.4.2	June 1999	Publication
V1.5.1	February 2001	Publication
V1.6.1	February 2002	Publication
V1.7.1	July 2003	Publication
V1.8.1	November 2004	Publication
V1.9.1	September 2005	Publication
V2.1.1	August 2007	Publication
V2.2.1	November 2008	Publication
V2.2.2	February 2009	Publication
V2.3.1	June 2010	Publication
V2.4.1	April 2012	Publication
V2.5.1	August 2013	Publication
V2.6.1	July 2015	Publication
V2.7.1	November 2017	Publication
V2.7.6	August 2019	EN Approval Procedure AP 20191128: 2019-08-30 to 2019-11-28