

ETSI EN 300 175-3 V1.5.1 (2001-02)

European Standard (Telecommunications series)

Digital Enhanced Cordless Telecommunications (DECT); Common Interface (CI); Part 3: Medium Access Control (MAC) layer



Reference

REN/DECT-000157-3

Keywords

DECT, MAC, radio

ETSI

650 Route des Lucioles
F-06921 Sophia Antipolis Cedex - FRANCE

Tel.: +33 4 92 94 42 00 Fax: +33 4 93 65 47 16

Siret N° 348 623 562 00017 - NAF 742 C
Association à but non lucratif enregistrée à la
Sous-Préfecture de Grasse (06) N° 7803/88

Important notice

Individual copies of the present document can be downloaded from:

<http://www.etsi.org>

The present document may be made available in more than one electronic version or in print. In any case of existing or perceived difference in contents between such versions, the reference version is the Portable Document Format (PDF). In case of dispute, the reference shall be the printing on ETSI printers of the PDF version kept on a specific network drive within ETSI Secretariat.

Users of the present document should be aware that the document may be subject to revision or change of status. Information on the current status of this and other ETSI documents is available at <http://www.etsi.org/tb/status/>

If you find errors in the present document, send your comment to:
editor@etsi.fr

Copyright Notification

No part may be reproduced except as authorized by written permission.
The copyright and the foregoing restriction extend to reproduction in all media.

© European Telecommunications Standards Institute 2001.
All rights reserved.

Contents

Intellectual Property Rights	11
Foreword.....	11
1 Scope.....	12
2 References.....	12
3 Definitions and abbreviations.....	13
3.1 Definitions	13
3.2 Abbreviations.....	14
4 Description of the MAC layer	16
4.1 MAC layer reference model.....	16
4.1.1 General.....	17
4.1.2 Cluster Control Function (CCF)	17
4.1.3 Cell Site Functions (CSF).....	17
4.1.4 Relationship to physical layer elements	17
4.2 Frame and multiframe structures.....	18
4.2.1 General.....	18
4.2.2 Frame structure	19
4.2.3 Multiframe structure	20
4.3 State definitions.....	20
4.3.1 PP states	20
4.3.2 RFP states.....	21
5 Overview of MAC layer services	22
5.1 General	22
5.1.1 Broadcast Message Control (BMC).....	22
5.1.2 Connectionless Message Control (CMC).....	22
5.1.3 Multi-Bearer Control.....	22
5.2 Service descriptions.....	23
5.2.1 Common functions.....	23
5.2.2 BMC service.....	23
5.2.3 CMC service.....	23
5.2.4 MBC services	23
5.3 Logical channels.....	24
5.3.1 MBC connection endpoints (MC-SAP logical channels)	24
5.3.1.1 The higher layer C-plane channels, C.....	24
5.3.1.2 The higher layer U-Plane channels, I.....	25
5.3.1.3 The higher layer U-Plane control channel, G _F	25
5.3.2 CMC endpoints (MB-SAP logical channels).....	25
5.3.2.1 The connectionless C-Plane channels, C _L	25
5.3.2.2 The connectionless U-Plane channels, SI _N and SI _P	25
5.3.3 BMC endpoint (MA-SAP logical channel).....	26
5.3.3.1 The slow broadcast channel, BS.....	26
5.3.4 Internal MAC control channels.....	26
5.3.4.1 The system information channel, Q.....	26
5.3.4.2 Identities channel, N.....	26
5.3.4.3 The MAC control channel, M	26
5.3.4.4 MAC paging channel, P.....	27
5.4 SAP definitions	27
5.4.1 MA SAP	27
5.4.2 MB SAP	27
5.4.3 MC SAP	28
5.4.4 ME SAP	28
5.4.5 Order of transmission.....	28
5.5 Bearers.....	28

5.5.1	Bearer types	29
5.5.2	Bearer operation.....	29
5.6	Connection oriented services	29
5.6.1	Connection types.....	30
5.6.1.1	Basic connections	30
5.6.1.2	Advanced connections	30
5.6.1.3	Connection identifiers.....	30
5.6.1.4	Complementary connections	31
5.6.2	Symmetric and asymmetric connections	31
5.6.2.1	Symmetric connections.....	31
5.6.2.2	Asymmetric connections.....	34
5.7	Broadcast and connectionless services	38
5.7.1	The broadcast services	38
5.7.1.1	The continuous broadcast service	38
5.7.1.2	The non-continuous broadcast service	39
5.7.2	The connectionless services.....	39
5.7.2.1	Connectionless downlink services	39
5.7.2.2	Connectionless uplink services.....	39
6	Multiplexing	40
6.1	CCF multiplexing functions.....	40
6.2	CSF multiplexing functions	40
6.2.1	Bit Mappings (MAP).....	45
6.2.1.1	D-field Mapping (D-MAP)	45
6.2.1.2	A-field Mapping (A-MAP)	48
6.2.1.3	B-field Mapping (B-MAP).....	49
6.2.2	Time multiplexers	60
6.2.2.1	Tail MULTipleXer (T-MUX)	60
6.2.2.1.1	T-MUX algorithm for RFP transmissions	61
6.2.2.1.2	T-MUX algorithm for PT transmissions.....	62
6.2.2.2	B-field control multiplexer (E/U-MUX)	62
6.2.2.3	B-field mode multiplexer (C-MUX)	64
6.2.2.3.1	Double slot full slot, D16 and D24 half slot modes.....	64
6.2.2.3.2	Half slot modes for 2 level modulation	69
6.2.3	Encryption	70
6.2.4	Scrambling	71
6.2.5	Error control	72
6.2.5.1	R-CRC overview	72
6.2.5.2	R-CRC generation and checking	73
6.2.5.3	X-CRC overview	73
6.2.5.4	X-CRC generation and checking.....	74
6.2.5.5	B-CRC generation and checking for I _{PQ} services	79
6.2.6	Broadcast controller	79
7	Medium access layer messages	79
7.1	Header field	80
7.1.1	Overview/formatting	80
7.1.2	Tail identification, TA, bits a ₀ to a ₂	80
7.1.3	The "Q1 / BCK" bit, bit a ₃	81
7.1.4	B-field identification, BA, bits a ₄ to a ₆	81
7.1.5	The "Q2" bit, bit a ₇	82
7.2	Messages in the tail field	82
7.2.1	Overview	82
7.2.2	Identities information (N _T)	82
7.2.3	System information and multiframe marker (Q _T).....	83
7.2.3.1	General.....	83
7.2.3.2	Static system information.....	84
7.2.3.2.1	General, Q _H = 0, 1 (hex).....	84
7.2.3.2.2	Q _H and Normal-Reverse (NR)	84
7.2.3.2.3	Slot Number (SN)	84

7.2.3.2.4	Start Position (SP).....	85
7.2.3.2.5	ESCAPE bit (ESC).....	85
7.2.3.2.6	Number of transceivers.....	85
7.2.3.2.7	Extended RF carrier information available (Mc).....	85
7.2.3.2.8	RF carriers available (RF-cars).....	86
7.2.3.2.9	Spare bits (SPR).....	86
7.2.3.2.10	Carrier number.....	86
7.2.3.2.11	Spare bits (SPR).....	86
7.2.3.2.12	Primary receiver Scan Carrier Number (PSCN).....	87
7.2.3.3	Extended RF carrier information.....	87
7.2.3.3.1	General, $Q_H = 2$ (hex).....	87
7.2.3.3.2	Number of RF carriers.....	87
7.2.3.4	Fixed part capabilities.....	88
7.2.3.4.1	General, $Q_H = 3$ (hex).....	88
7.2.3.4.2	Standard capabilities.....	88
7.2.3.5	Extended fixed part capabilities.....	89
7.2.3.5.1	General, $Q_H = 4$ (hex).....	89
7.2.3.5.2	Extended Physical and MAC layer capabilities.....	90
7.2.3.5.2.1	Wireless relay stations.....	90
7.2.3.5.2.2	Synchronization field options.....	90
7.2.3.5.2.3	MAC suspend and resume.....	90
7.2.3.5.2.4	MAC service I_{PQ} supported.....	91
7.2.3.5.3	Extended higher layer capabilities.....	91
7.2.3.6	Secondary access rights identities.....	91
7.2.3.6.1	General, $Q_H = 5$ (hex).....	91
7.2.3.6.2	SARI message.....	91
7.2.3.7	Multiframe number.....	91
7.2.3.7.1	General, $Q_H = 6$ (hex).....	91
7.2.3.7.2	Multiframe number.....	91
7.2.3.8	Escape.....	92
7.2.3.8.1	General, $Q_H = 7$ (hex).....	92
7.2.3.8.2	Escape information.....	92
7.2.4	Paging Tail (P_T).....	92
7.2.4.1	General format.....	92
7.2.4.1.1	P_T format for full and long page messages.....	92
7.2.4.1.2	P_T format for short page messages.....	92
7.2.4.1.3	P_T format for zero length page messages.....	92
7.2.4.1.4	P_T format for MAC_resume page message.....	92
7.2.4.2	P_T header format.....	93
7.2.4.2.1	General format.....	93
7.2.4.2.2	Bit a_8 is the extend flag.....	93
7.2.4.2.3	BS SDU length indication.....	93
7.2.4.3	MAC layer information for PT.....	94
7.2.4.3.1	Information type.....	94
7.2.4.3.2	Fill bits.....	94
7.2.4.3.3	Blind full slot information.....	94
7.2.4.3.4	Bearer description.....	95
7.2.4.3.5	Escape.....	95
7.2.4.3.6	Dummy or connectionless downlink bearer marker.....	95
7.2.4.3.7	Bearer handover/replacement information.....	96
7.2.4.3.8	RFP status and modulation types.....	96
7.2.4.3.9	Active carriers.....	97
7.2.4.3.10	RFP power level.....	98
7.2.4.3.11	Blind double slot / RFP-FP interface resource information.....	98
7.2.5	MAC control (M_T).....	100
7.2.5.1	General format and contents.....	100
7.2.5.2	Basic connection control.....	100
7.2.5.2.1	General.....	100

7.2.5.2.2	Format for most messages	100
7.2.5.2.3	WAIT	101
7.2.5.2.4	ATTRIBUTES_T_{Req;Cfm}	101
7.2.5.3	Advanced connection control	102
7.2.5.3.1	General	102
7.2.5.3.2	ACCESS_REQUEST	102
7.2.5.3.3	BEARER_HANDOVER_REQUEST	102
7.2.5.3.4	CONNECTION_HANDOVER_REQUEST	102
7.2.5.3.5	UNCONFIRMED_ACCESS_REQUEST	103
7.2.5.3.6	BEARER_CONFIRM	103
7.2.5.3.7	WAIT	103
7.2.5.3.8	ATTRIBUTES_T_{Req;Cfm}	103
7.2.5.3.9	BANDWIDTH_T_{Req;Cfm}	105
7.2.5.3.10	Channel_list	105
7.2.5.3.11	Unconfirmed_dummy	106
7.2.5.3.12	Unconfirmed_handover	106
7.2.5.3.13	RELEASE	106
7.2.5.4	MAC layer test messages	107
7.2.5.4.1	Basic format	107
7.2.5.4.2	FORCE_TRANSMIT	107
7.2.5.4.3	LOOPBACK_DATA	108
7.2.5.4.4	DEFEAT_ANTENNA_DIVERSITY	108
7.2.5.4.5	ESCAPE	109
7.2.5.4.6	NETWORK_TEST	109
7.2.5.4.7	CLEAR_TEST_MODES	109
7.2.5.4.8	CHANGE_MODULATION_SCHEME	110
7.2.5.5	Quality control	110
7.2.5.5.1	Prolonged preamble diversity	112
7.2.5.5.1.1	Procedure for prolonged preamble diversity in RFP	112
7.2.5.5.1.2	Procedure for prolonged preamble diversity in PP	112
7.2.5.6	Broadcast and connectionless services	112
7.2.5.7	Encryption control	113
7.2.5.8	B-field setup, first PT transmission	114
7.2.5.9	Escape	114
7.2.5.10	TARI message	114
7.2.5.11	REP connection control	114
7.2.5.11.1	General	114
7.2.5.11.2	Format for most messages	114
7.2.5.11.3	REP CHANNEL MAP REQUEST	115
7.2.5.11.4	REP CHANNEL MAP CONFIRM	115
7.3	Messages in the B-field	115
7.3.1	Overview	115
7.3.2	Advanced connection control	116
7.3.2.1	General format	116
7.3.2.2	BEARER_REQUEST	117
7.3.2.3	BEARER_CONFIRM	117
7.3.2.4	WAIT	118
7.3.2.5	ATTRIBUTES_B_{Req;Cfm}	118
7.3.2.6	BANDWIDTH_B_{Req;Cfm}	118
7.3.2.7	CHANNEL_LIST	118
7.3.2.8	UNCONFIRMED_DUMMY	119
7.3.2.9	UNCONFIRMED_HANDOVER	119
7.3.2.10	RELEASE	119
7.3.3	Null	120
7.3.4	Quality control	120
7.3.4.1	General format	120
7.3.4.2	Bearer and connection control	120
7.3.4.3	RESET	122
7.3.4.4	Bearer quality in an asymmetric connection	122
7.3.5	Extended system information	123
7.3.5.1	General format	123
7.3.5.2	TARI messages	123

7.3.6	G _F -channel data packet.....	123
7.3.7	Escape.....	124
8	Medium access layer primitives	124
8.1	Connection oriented service primitives	125
8.1.1	Connection setup: MAC_CON {req;ind;cfm}.....	125
8.1.2	Connection modification: MAC_MOD {req;ind;cfm}.....	126
8.1.3	CO data transmit ready: MAC_CO_DTR {ind}.....	127
8.1.4	CO data transfer: MAC_CO_DATA {req;ind}.....	127
8.1.5	Restart DLC: MAC_RES_DLC {ind}.....	128
8.1.6	Connection release: MAC_DIS {req;ind}.....	128
8.1.7	MAC bandwidth: MAC_BW {ind;res}.....	128
8.1.8	Encryption.....	129
8.1.8.1	Load encryption key: MAC_ENC_KEY {req}.....	129
8.1.8.2	Enable/disable encryption: MAC_ENC_EKS {req;ind;cfm}.....	129
8.1.9	C-plane switching procedure.....	129
8.1.9.1	C-plane switching procedure: MAC_C _S -C _F {req, cfm, ind, res}.....	129
8.1.9.2	C-plane switching procedure: MAC_CSCF_END {ind}.....	130
8.2	Connectionless and broadcast service primitives	130
8.2.1	Paging: MAC_PAGE {req;ind}.....	130
8.2.2	Downlink connectionless: MAC_DOWN_CON {req;ind}.....	131
8.2.3	Uplink connectionless: MAC_UP_CON {req;ind;cfm}.....	131
8.3	Management primitives	131
8.3.1	Connection control.....	131
8.3.1.1	Connection setup: MAC_ME_CON {ind}.....	131
8.3.1.2	Connection setup allowed: MAC_ME_CON_ALL {req}.....	132
8.3.1.3	Bearer release: MAC_ME_REL {req}.....	132
8.3.1.4	MBC release report: MAC_ME_REL_REP {ind}.....	132
8.3.2	System information and identities.....	132
8.3.2.1	FP information preloading: MAC_ME_RFP_PRELOAD {req}.....	132
8.3.2.2	PT information preloading: MAC_ME_PT_PRELOAD {req}.....	132
8.3.2.3	System information output: MAC_ME_INFO {ind;res}.....	132
8.3.2.4	Extended system info: MAC_ME_EXT. {req;ind;res;cfm}.....	133
8.3.3	Channel map: MAC_ME_CHANMAP {ind;res}.....	133
8.3.4	Status reports: MAC_ME_STATUS {req;ind;res;cfm}.....	133
8.3.5	Error reports: MAC_ME_ERROR {ind;res}.....	133
8.4	Flow control.....	133
8.4.1	MA SAP flow control.....	133
8.4.2	MB SAP flow control.....	133
8.4.3	MC SAP flow control.....	134
9	Broadcast and connectionless procedures	135
9.1	Downlink broadcast and connectionless procedures	135
9.1.1	Downlink broadcast procedure.....	135
9.1.1.1	Broadcast information.....	135
9.1.1.2	Channel selection for downlink broadcast services.....	136
9.1.1.3	Downlink broadcast procedure description.....	137
9.1.2	Downlink connectionless procedure.....	137
9.1.2.1	Channel selection at the RFP.....	137
9.1.2.2	Downlink connectionless procedure description.....	138
9.1.3	Paging broadcast procedure.....	138
9.1.3.1	RFP paging broadcasts.....	138
9.1.3.2	PP paging procedures.....	140
9.1.3.2.1	PP paging detection.....	140
9.1.3.2.2	PP paging processing.....	141
9.2	Uplink connectionless procedures.....	141
9.2.1	General.....	141
9.2.2	Bearer selection for the connectionless uplink.....	141
9.2.3	Procedure for the connectionless uplink.....	142
9.2.3.1	Predicates.....	142
9.2.3.2	PT D-field construction.....	142
9.2.3.3	PT transmission sequence.....	142

9.2.3.4	FT procedure	143
9.3	Non-continuous broadcast procedure	143
9.3.1	Request for specific Q-channel information	143
9.3.1.1	A-field procedure.....	144
9.3.1.2	B-field procedure.....	144
9.3.2	Request for a new dummy bearer.....	145
10	Connection oriented service procedures	145
10.1	Overview	145
10.2	C/O connection setup	145
10.2.1	General.....	146
10.2.2	Initiation of a basic and a normal connection setup	146
10.2.3	Initiation of a fast connection setup	146
10.2.4	Connection setup procedure description.....	146
10.2.4.1	Creation of MBCs.....	146
10.2.4.2	Establishment of a single bearer duplex connection of a known service type	148
10.2.4.3	Establishment of multi-bearer connections and connections needing service negotiation	149
10.2.4.3.1	Symmetric connection	151
10.2.4.3.2	Asymmetric uplink connection	151
10.2.4.3.3	Asymmetric downlink connection.....	152
10.2.4.3.4	Connection established.....	152
10.3	C/O connection modification	152
10.3.1	Advanced connection: bandwidth modification.....	152
10.3.1.1	Suspend and Resume	154
10.3.1.2	MAC resume paging.....	154
10.3.2	Advanced connection: service type or slot type modification.....	154
10.3.3	Connection type modification.....	157
10.3.4	Modulation type modification	158
10.4	C/O connection release.....	159
10.4.1	General.....	159
10.4.2	Procedure description.....	160
10.5	C/O bearer setup.....	160
10.5.1	Single bearer setup procedures	160
10.5.1.1	Basic bearer setup procedure.....	160
10.5.1.2	A-field advanced single bearer setup procedure	163
10.5.1.2.1	PT initiated	163
10.5.1.2.2	FT initiated	166
10.5.1.3	B-field single bearer setup procedure	167
10.5.1.3.1	PT initiated	167
10.5.1.3.2	FT initiated	169
10.5.1.4	Double simplex setup procedure	170
10.5.1.5	Complementary connection bearer setup	174
10.5.1.6	Double duplex bearer setup procedure: Mapping procedure.....	174
10.5.2	Channel list procedures	175
10.5.2.1	Scope	175
10.5.2.2	Description of the channel list messages.....	176
10.5.2.3	Usage of the channel list messages.....	176
10.6	C/O bearer handover.....	177
10.6.1	General.....	177
10.6.2	Duplex bearer handover procedure	178
10.6.3	Double simplex bearer handover	179
10.6.4	Bearer replacement	179
10.6.4.1	General bearer replacement.....	179
10.6.4.2	Frequency replacement	179
10.7	C/O bearer release	181
10.7.1	General.....	181
10.7.2	Bearer release procedure description	181
10.7.2.1	Unacknowledged release procedure	181
10.7.2.2	Acknowledged release procedure	182
10.7.2.3	Fast release procedure.....	182
10.7.2.4	REP relayed bearer release.....	183
10.8	C/O data transfer	183

10.8.1	Higher layer associated signalling (C)	183
10.8.1.1	C _S -channel data	183
10.8.1.1.1	Transmission principle	183
10.8.1.1.2	Numbering principle.....	184
10.8.1.2	C _F -channel data	184
10.8.1.2.1	Transmission principle	184
10.8.1.2.2	Numbering principle.....	184
10.8.1.3	Q1 and Q2 bit settings for I _N and I _P _error detection services	184
10.8.1.3.1	Q2 bit settings	185
10.8.1.3.2	Q1 bit settings	186
10.8.2	MOD-2 protected I-channel operation (I _P).....	187
10.8.2.1	General.....	187
10.8.2.2	Limiting the lifetime of packets.....	187
10.8.2.3	A-field shall always be correct	187
10.8.2.4	Use of the acknowledge bits.....	187
10.8.2.4.1	Q2 and ACK bit setting for I _P _error_correction services	188
10.8.2.4.2	BCK bit setting	188
10.8.2.5	Data jump procedures	188
10.8.2.5.1	Bearer replacement.....	188
10.8.2.5.2	Unilateral jump	189
10.8.2.5.3	MAC I _P bearer reset.....	190
10.8.3	Higher layer unprotected information (I _N) and MAC error detection services (I _P).....	191
10.8.3.1	I _N _minimum_delay service	191
10.8.3.2	I _N _normal_delay and I _P _error_detection services	191
10.9	C/O procedures for FT connections with CRFP.....	191
10.9.1	Dual C/O bearer setup.....	191
10.9.2	C/O connection release of connection with CRFP.....	191
10.9.3	C/O connection suspend and resume.....	192
11	Medium access layer management procedures	192
11.1	Broadcasting	192
11.1.1	RFP transmission	192
11.1.2	PP reception.....	192
11.2	Extended system information.....	192
11.2.1	PP requests	192
11.2.2	RFP response.....	193
11.3	PP states and state transitions.....	193
11.3.1	Actions in Idle_Unlocked and Active_Unlocked states	193
11.3.2	Entry into the Idle_Locked state	193
11.3.3	Actions in the Idle_Locked state.....	193
11.3.3.1	Page detection in Idle_Locked state	194
11.3.3.2	Setup detection in Idle_Locked state	194
11.3.4	Idle_Locked and Active_Locked state transitions	194
11.4	Physical channel selection	194
11.4.1	The channel selection lists.....	195
11.4.2	Physical channel and RFP selection at the PP	197
11.4.3	Physical channel selection at the RFP.....	198
11.4.4	Hand over criteria due to in-connection base identification	200
11.4.5	Handover criteria due to interference.....	200
11.5	In-connection quality control	200
11.5.1	RFPI handshake.....	200
11.5.2	Frequency control	200
11.5.2.1	RFP measurement of frequency error	200
11.5.2.2	PT frequency correction.....	201
11.6	Maximum allowed system load at RFPs.....	201
11.7	PMID and FMID definitions.....	201
11.7.1	FMID definition.....	201
11.7.2	PMID definition.....	201
11.8	RFP idle receiver scan sequence	201
11.9	PT receiver scan sequence	202

12	Medium access layer test message procedure	202
12.1	Introduction.....	202
12.2	General	203
12.2.1	Portable part testing	204
12.2.2	Fixed part testing	204
12.2.3	Applicability of test messages	205
12.3	FORCE_TRANSMIT.....	205
12.3.1	Portable part	205
12.3.2	Fixed part	206
12.4	LOOPBACK_DATA	206
12.4.1	Portable part	206
12.4.2	Fixed Part	206
12.4.2.1	IUTs implementing the DECT scrambler	206
12.4.2.2	IUTs implementing a proprietary scrambler.....	207
12.5	DEFEAT_ANTENNA_DIVERSITY.....	207
12.6	NETWORK_TEST	207
12.7	ESCAPE.....	207
12.8	CLEAR_TEST_MODES.....	207
12.9	CHANGE_MODULATION_SCHEME.....	207
Annex A (normative): MAC layer timers and constants.....		208
A.1	Timers and Time Windows	208
A.2	Constants.....	208
Annex B (informative): Construction of the CRC polynomial and error detecting performance.....		209
Annex C (informative): MAC relationship to other layers.....		210
Annex D (informative): Synchronization		211
Annex E (informative): Scrambling patterns.....		212
Annex F (informative): Seamless handover operation		213
F.1	I-Channel data flow for I_N _minimum_delay service	213
Annex G (normative): Requirements for PPs with direct PP to PP communication mode.....		214
G.1	Description of operation in direct PP to PP communication mode	214
G.2	Requirements.....	214
G.2.1	Setting the PP in direct communications mode.....	215
G.2.2	Specific Alternative 1 requirements	215
G.2.2.1	When the PP has not initiated a call.....	215
G.2.2.2	When the PP initiates a call	215
G.2.3	Specific Alternative 2 Requirements	216
Annex H (informative): Bibliography.....		217
History		218

Intellectual Property Rights

IPRs essential or potentially essential to the present document may have been declared to ETSI. The information pertaining to these essential IPRs, if any, is publicly available for **ETSI members and non-members**, and can be found in ETSI SR 000 314: "*Intellectual Property Rights (IPRs); Essential, or potentially Essential, IPRs notified to ETSI in respect of ETSI standards*", which is available from the ETSI Secretariat. Latest updates are available on the ETSI Web server (<http://www.etsi.org/ipr>).

Pursuant to the ETSI IPR Policy, no investigation, including IPR searches, has been carried out by ETSI. No guarantee can be given as to the existence of other IPRs not referenced in ETSI SR 000 314 (or the updates on the ETSI Web server) which are, or may be, or may become, essential to the present document.

Foreword

This European Standard (Telecommunications series) has been produced by ETSI Project Digital Enhanced Cordless Telecommunications (DECT).

The present document is part 3 of a multi-part EN covering the Common Interface (CI) for the Digital Enhanced Cordless Telecommunications (DECT), as identified below:

- Part 1: "Overview";
- Part 2: "Physical Layer (PHL)";
- Part 3: "Medium Access Control (MAC) layer";**
- Part 4: "Data Link Control (DLC) layer";
- Part 5: "Network (NWK) layer";
- Part 6: "Identities and addressing";
- Part 7: "Security features";
- Part 8: "Speech coding and transmission".

Further details of the DECT system may be found in TR 101 178 [9], ETR 043 [10].

National transposition dates	
Date of adoption of this EN:	16 February 2001
Date of latest announcement of this EN (doa):	31 May 2001
Date of latest publication of new National Standard or endorsement of this EN (dop/e):	30 November 2001
Date of withdrawal of any conflicting National Standard (dow):	30 November 2001

1 Scope

The present document gives an introduction and overview of the complete Digital Enhanced Cordless Telecommunications (DECT) Common Interface (CI).

The present document of the DECT CI specifies the Medium Access Control (MAC) layer. The MAC layer is part 3 of the DECT Common Interface standard and layer 2a of the DECT protocol stack.

It specifies three groups of MAC services:

- the broadcast message control service;
- the connectionless message control service; and
- the multi-bearer control service.

It also specifies the logical channels that are used by the above-mentioned services, and how they are multiplexed and mapped into the Service Data Units (SDUs) that are exchanged with the Physical Layer (PHL).

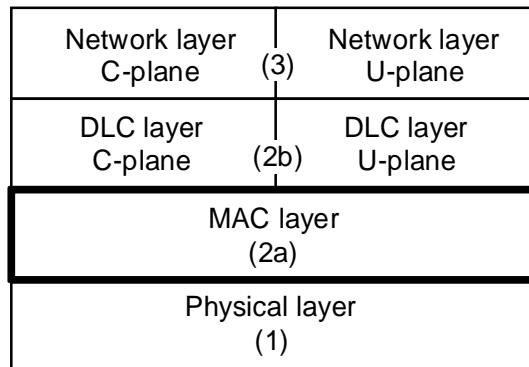

Figure 1: The DECT protocol stack

2 References

The following documents contain provisions which, through reference in this text, constitute provisions of the present document.

- References are either specific (identified by date of publication, edition number, version number, etc.) or non-specific.
- For a specific reference, subsequent revisions do not apply.
- For a non-specific reference, the latest version applies.

- [1] ETSI EN 300 175-1: "Digital Enhanced Cordless Telecommunications (DECT); Common Interface (CI); Part 1: Overview".
- [2] ETSI EN 300 175-2: "Digital Enhanced Cordless Telecommunications (DECT); Common Interface (CI); Part 2: Physical Layer (PHL)".
- [3] ETSI EN 300 175-4: "Digital Enhanced Cordless Telecommunications (DECT); Common Interface (CI); Part 4: Data Link Control (DLC) layer".
- [4] ETSI EN 300 175-5: "Digital Enhanced Cordless Telecommunications (DECT); Common Interface (CI); Part 5: Network (NWK) layer".
- [5] ETSI EN 300 175-6: "Digital Enhanced Cordless Telecommunications (DECT); Common Interface (CI); Part 6: Identities and addressing".

- [6] ETSI EN 300 175-7: "Digital Enhanced Cordless Telecommunications (DECT); Common Interface (CI); Part 7: Security features".
- [7] ETSI EN 300 175-8: "Digital Enhanced Cordless Telecommunications (DECT); Common Interface (CI); Part 8: Speech coding and transmission".
- [8] ETSI EN 300 176: "Digital Enhanced Cordless Telecommunications (DECT); Approval test specification".
- [9] ETSI TR 101 178: "Digital Enhanced Cordless Telecommunications (DECT); A High Level Guide to the DECT Standardization".
- [10] ETSI ETR 043: "Digital Enhanced Cordless Telecommunications (DECT); Common Interface (CI); Services and facilities requirements specification".

3 Definitions and abbreviations

Most definitions and abbreviations are defined in part 1 of EN 300 175. A few abbreviations that are specific to the present document appear in clause 3.2.

3.1 Definitions

For the purposes of the present document, the following terms and definitions apply:

antenna diversity: see EN 300 175-1 [1].

bearer handover: see EN 300 175-1 [1].

broadcast: see EN 300 175-1 [1].

C-plane: see EN 300 175-1 [1].

cell: see EN 300 175-1 [1].

Central Control Fixed Part (CCFP): see EN 300 175-1 [1].

cluster: see EN 300 175-1 [1].

connection handover: see EN 300 175-1 [1].

Connectionless mode (C/L): see EN 300 175-1 [1].

Connection Oriented mode (C/O): see EN 300 175-1 [1].

Cordless Radio Fixed Part (CRFP): see EN 300 175-1 [1].

double duplex bearer: see EN 300 175-1 [1].

double simplex bearer: see EN 300 175-1 [1].

duplex bearer: see EN 300 175-1 [1].

Extended MAC control messages: see EN 300 175-1 [1].

field: see EN 300 175-1 [1].

Fixed Part (DECT Fixed Part) (FP): see EN 300 175-1 [1].

Fixed radio Termination (FT): see EN 300 175-1 [1].

full slot (slot): see EN 300 175-1 [1].

half slot: see EN 300 175-1 [1].

incoming call: see EN 300 175-1 [1].

inter-cell handover: see EN 300 175-1 [1].

logical channel: see EN 300 175-1 [1].

logical connection: see EN 300 175-1 [1].

Lower Layer Management Entity (LLME): see EN 300 175-1 [1].

Lower Tester (LT): see EN 300 175-1 [1].

MAC bearer (bearer): see EN 300 175-1 [1].

MAC connection (connection): see EN 300 175-1 [1].

multiframe: see EN 300 175-1 [1].

outgoing call: see EN 300 175-1 [1].

paging: see EN 300 175-1 [1].

phase: see EN 300 175-1 [1].

Physical channel (channel): see EN 300 175-1 [1].

Portable Part (DECT Portable Part) (PP): see EN 300 175-1 [1].

Portable radio Termination (PT): see EN 300 175-1 [1].

Radio Fixed Part (RFP): see EN 300 175-1 [1].

Repeater Part (REP): see EN 300 175-1 [1].

segment: see EN 300 175-1 [1].

segmentation: see EN 300 175-1 [1].

simplex bearer: see EN 300 175-1 [1].

TDMA frame: see EN 300 175-1 [1].

U-plane: see EN 300 175-1 [1].

Wireless Relay Station (WRS): see EN 300 175-1 [1].

3.2 Abbreviations

For the purposes of the present document, the following abbreviations apply:

A-MAP	A-field MAP
B-MAP	B-field MAP
BMC	Broadcast Message Control
BS	slow Broadcast channel
C	higher layer control Channel (see C _S and C _F)
CI	Common Interface (standard)
C/L	Connectionless
C/O	Connection Oriented
C _F	higher layer signalling Channel (fast)
CBC	Connectionless Bearer Control
CL	higher layer Connectionless channel (protected; see CL _S and CL _F)
CL _F	higher layer Connectionless channel (fast)
CL _S	higher layer Connectionless channel (slow)
CMC	Connectionless Message Control
CRFP	Cordless Radio Fixed Part

C _S	higher layer signalling Channel (slow)
D-MAP	D-field MAP
DBC	Dummy Bearer Control
IUT	Implementation Under Test
E/U-MUX	Switch between E-type and U-type Multiplexes
ECN	Exchanged Connection Number
FMID	Fixed part MAC Identity
GAP	Generic Access Profile
G _F	higher layer information control channel
I	higher layer Information channel (see I _N and I _P)
I _N	higher layer Information channel (unprotected)
I _P	higher layer Information channel (protected)
IRC	Idle Receiver Control
LBN	Logical Bearer Number
LSB	Least Significant Bit
LT	Lower Tester
M	MAC control channel
MAP	bit Mappings
MBC	Multi-Bearer Control
MCEI	MAC Connection Endpoint Identification
MSB	Most Significant Bit
MUX	time Multiplexors
N	identities channel
P	Paging channel
PMID	Portable part MAC IDentity
Q	system information channel
REP	Repeater Part
RPN	Radio fixed Part Number
SI _N	higher layer connectionless channel (Unprotected)
SI _P	higher layer connectionless channel (Protected)
T-MUX	Tail MUX
TBC	Traffic Bearer Control
WRS	Wireless Relay Station

4 Description of the MAC layer

4.1 MAC layer reference model

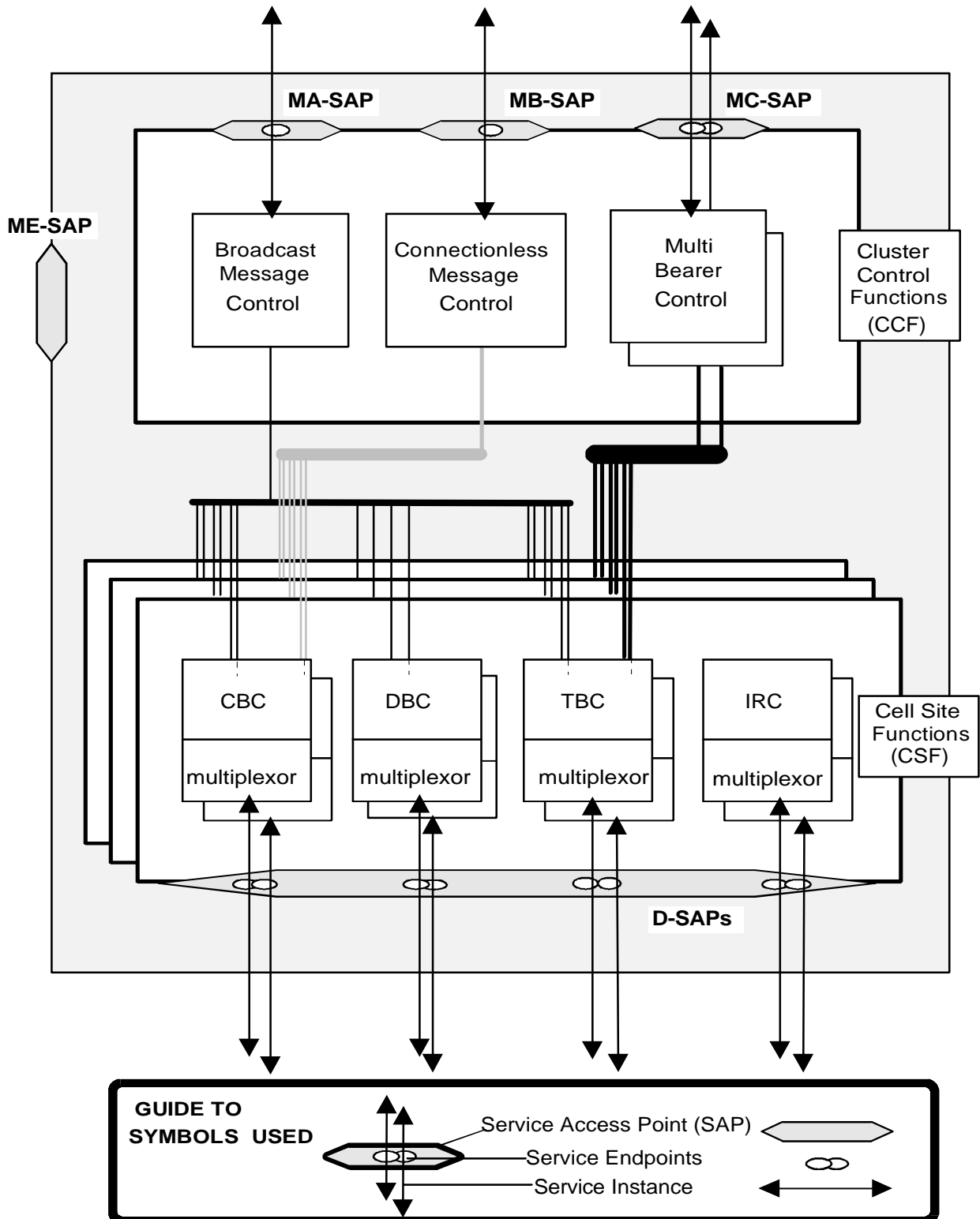

NOTE: MA, MB, MC and D are Service Access Points (SAPs) between the adjacent layers. Each line through these SAPs represents an independent service instance. ME is a SAP to the management entity.

Figure 4.1: MAC reference model

4.1.1 General

As far as possible, the present document avoids defining specific physical architectures, and uses the MAC reference model shown in figure 4.1. This reference model architecture applies equally to both the FT and the PT.

There is always a single instance of cluster control function that controls all instances of the cell site functions. In the FT, multiple cells would require multiple instances of CSFs (one per cell). Each of these instances connects to an independent physical layer via an independent D-SAP.

The multiplexor shown at the bottom of all CSFs is described in clause 6.

4.1.2 Cluster Control Function (CCF)

This includes all the MAC functions that are used to control more than one cell. A cluster contains only one CCF. The CCF contains the following functional elements:

- **BMC (Broadcast Message Control):** the functions that control and distribute the cluster's broadcast information to/from all CBCs, TBCs and DBCs. There is only one BMC per CCF;
- **CMC (Connectionless Message Control):** the functions that control and distribute the information of all connectionless services to one or more CBCs (see clause 5.7 for a description of connectionless services). There is at most one CMC per CCF;
- **MBC (Multi-Bearer Control):** the functions that control the multiplexing and management of all the data directly associated with a MAC connection between one FT and one PT. For single bearer connections (when not performing bearer handover) an MBC only manages one TBC, for multi-bearer connections an MBC will manage several TBCs. There is always only one MBC per connection, and therefore a CCF can contain multiple instances of MBCs (see clauses 5.5 and 5.6 for a description of bearers and connections).

4.1.3 Cell Site Functions (CSF)

This includes all the functions that are concerned with only one cell. Each CSF contains the following functional elements:

- **Connectionless Bearer Control (CBC):** the functions that control a connectionless bearer. Each CSF may contain multiple instances of CBC (see clauses 5.7 and 5.7.2.1);
- **Dummy Bearer Control (DBC):** the functions that control one dummy bearer. There is a maximum of two DBCs per CSF (see clause 5.7);
- **Traffic Bearer Control (TBC):** the functions that control one traffic bearer. Each CSF may contain multiple instances of TBC;
- **Idle Receiver Control (IRC):** the functions that control the receiver when not involved with a bearer. Each CSF may contain multiple instances of IRC, one per transceiver.

Refer to clause 5.5.2 for descriptions of dummy bearer, traffic bearer, and connectionless bearer.

4.1.4 Relationship to physical layer elements

A TBC controls one duplex bearer or one double simplex bearer. It, therefore, controls two physical channels.

A DBC controls one simplex bearer and, therefore, controls one physical channel.

A CBC controls either a simplex or a duplex bearer and, therefore, may control one or two physical channels.

The IRC controls all of the radio transceivers (for one cell) on any of the available physical channels that are not being used by the other entities (TBC, DBC or CBC). This provides various scanning functions defined in clauses 11.3.2, 11.4.1 and 11.8.

Each instance of the cell site functions relates to one physical cell, and thereby to a single PHL instance, as shown in figure 4.2.

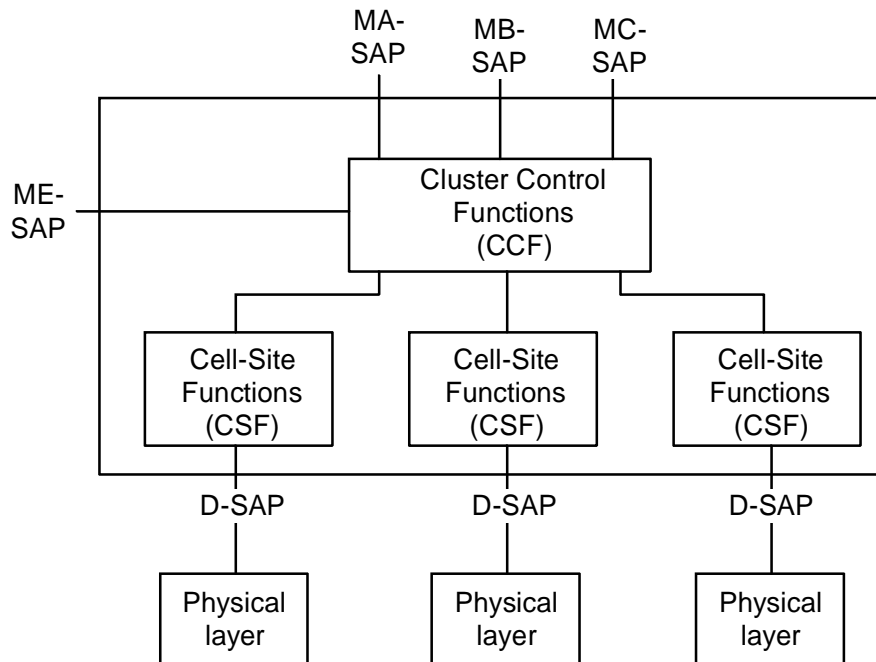

Figure 4.2: One MAC cluster

This expanded architecture is only significant for the FT. However, the physical groupings of any particular FT implementation may not correspond to these functional groupings, and the MAC architecture is arranged to allow many alternative implementations. For example, manufacturers may choose to implement a single cluster or multiple clusters. In both cases they may choose to distribute everything, to centralize just the cluster control functions or to centralize both the CCF and the CSF. Intermediate physical groupings may be possible for some implementations.

4.2 Frame and multiframe structures

4.2.1 General

There are two hierarchical levels of time division multiplexing:

frame: a time division multiplex of slots;

multiframe: a time division multiplex of frames.

Timing is defined by the FP transmissions, and the PP is required to slave all of its transmissions to these timings.

Detailed frame timing is defined by the PHL, but slot numbering is defined by the MAC layer.

Multiframe timing is wholly defined by the MAC layer.

4.2.2 Frame structure

A regular Time Division Multiple Access (TDMA) structure is created by the PHL (see to EN 300 175-2 [2]). This frame defines 24 full-slot positions. Alternatively, each full-slot may be further divided into two half-slots, or two consecutive full slots may be used together as a double slot (see figures 4.3, 4.4, and 4.5).

The MAC layer controls the transmission and/or reception of data for every double, full or half slot, by issuing primitives to the PHL. Each primitive specifies the operation for one slot position. Continuous operation on a given physical channel requires a regular series of primitives.

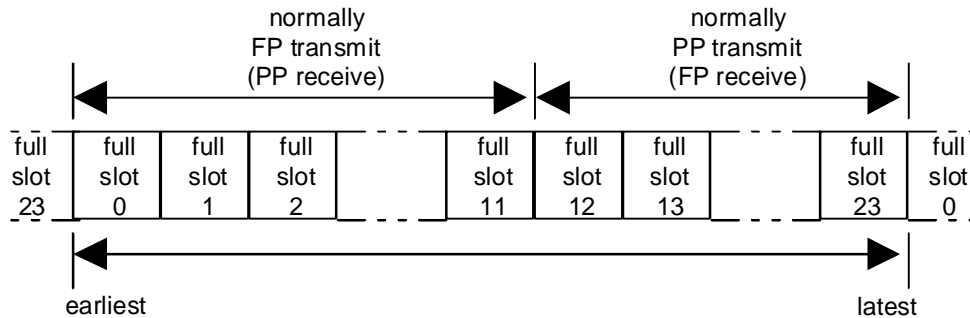

Figure 4.3: Full Slots

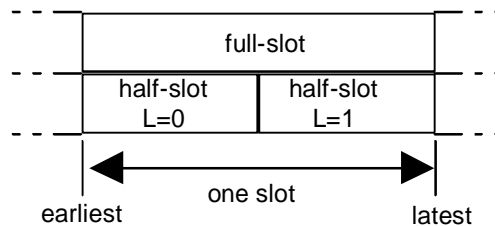

Figure 4.4: Half Slots

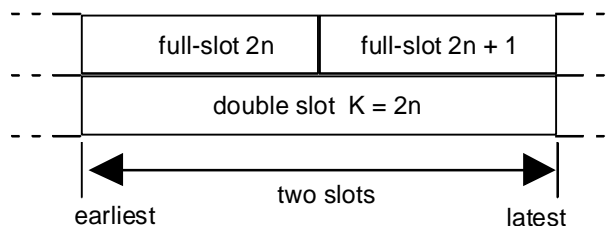

Figure 4.5: Double Slots

Full-slots are numbered from $K = 0$ to 23, and half-slots are numbered $L = 0$ or 1, where half-slot 0 occurs earlier than half-slot 1. Double slots are numbered from $K = 0$ to 22, where K is an even number, i.e. $K \text{ MOD } 2 = 0$.

Normally slots $K = 0$ to 11 are used in the FP to PP direction, and slots $K = 12$ to 23 in the PP to FP direction.

Slot numbers (frame timing) are not included in every slot transmission. Slot numbers are only defined in a special (Q-channel) message that is transmitted at a low rate by all FPs. This message defines the actual slot number for that transmission (see clause 7.2.3).

This also applies to a PP acting as the RFP in PP-to-PP direct communication mode.

4.2.3 Multiframe structure

The MAC layer superimposes a multiframe structure on the TDMA frame structure. This is a Time Division Multiplex (TDM) of 16 frames. The multiframe starts and ends on a frame boundary, as shown in figure 4.6.

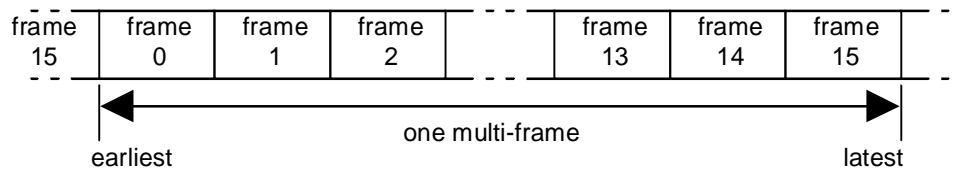

Figure 4.6: Multiframe

The multiframe numbering is defined in the same way for the FP and the PP. A multiframe normally starts with FP transmissions (first half of frame 0) and ends with PP transmissions (last half of frame 15).

Frame numbers (multi-frame timing) are never included in a transmission. Frame numbers shall be interpolated from the multiframe marker that is included in all FP transmissions. This marker appears once per multiframe (in frame 8) (see clauses 6.2.2.1 and 7.2.3).

When encryption is provided, an explicit multiframe number is also defined using a similar technique to slot numbering:

- a special (Q-channel) message is transmitted at a low rate by the FP. This message defines the actual multiframe number for that transmission (see clause 7.2.3).

4.3 State definitions

4.3.1 PP states

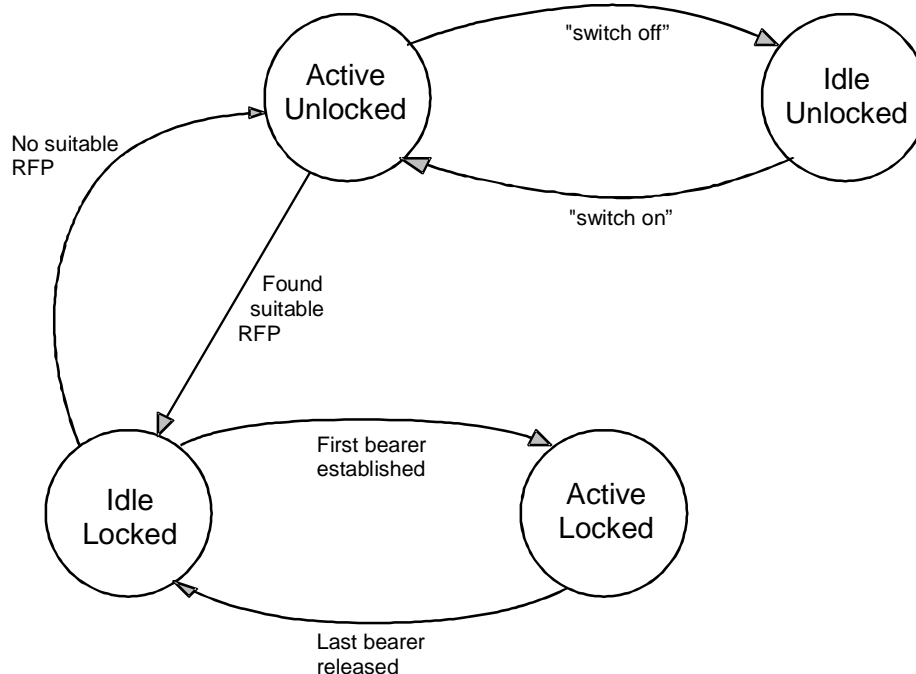

Figure 4.7: PP state diagram

A PP can exist in one of four major states at the MAC layer:

- 1) **Active_Locked:** where the PP is synchronized to at least one RFP transmission and has one or more connections in progress.
- 2) **Idle_Locked:** where the PP is synchronized to at least one RFP transmission. It is able to make or receive connections, but has no connections in progress.
- 3) **Active_Unlocked:** where the PP is not synchronized to any RFP transmissions, and is unable to make or receive connections. The PP makes occasional attempts to detect a suitable RFP and enter the Idle_Locked state.
- 4) **Idle_Unlocked:** the PP is not synchronized to any RFP and does not attempt to detect RFPs.

Several different modes of operation exist in the Idle_Locked state:

- a) **scanning mode:** where the PP's receiver scan sequence is synchronized with that of the RFP;
- b) **high duty cycle Idle_Locked mode:** where the PP receives 6 times per multiframe;
- c) **normal Idle_Locked mode:** where the PP typically receives once per multiframe;
- d) **low duty cycle Idle_Locked mode:** where the PP typically receives less than once per multiframe.

4.3.2 RFP states

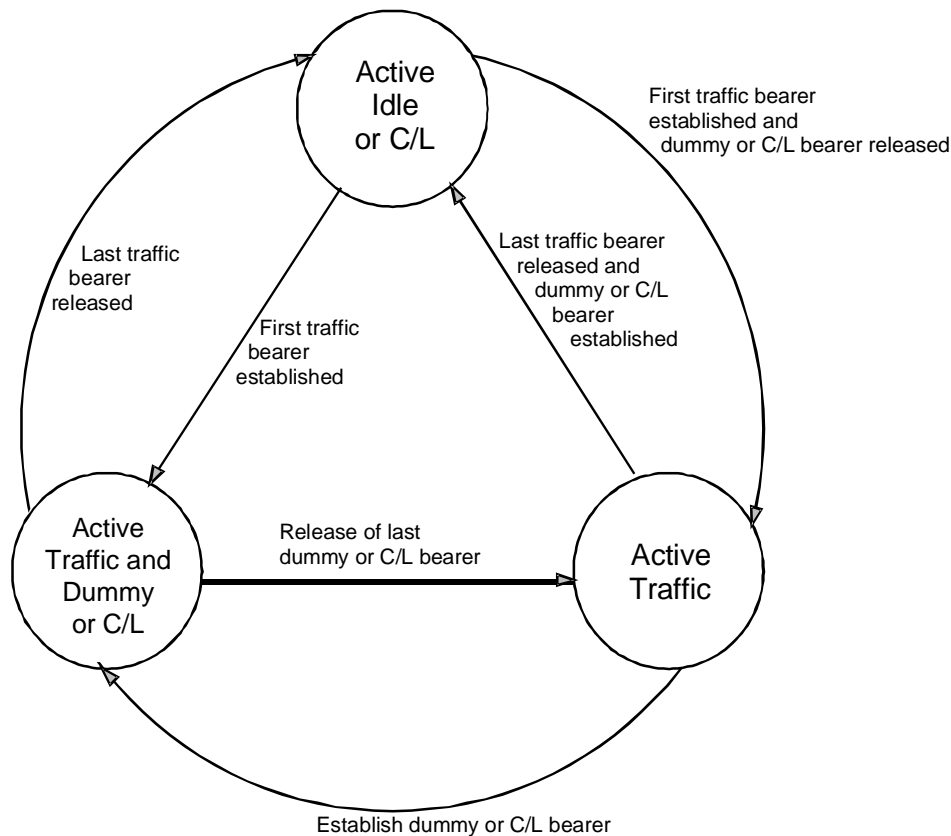

Figure 4.8: RFP state diagram

An RFP can exist in one of four major states at the MAC layer:

1) **Inactive:** where the RFP is not receiving or transmitting;

NOTE: The inactive state is not shown in the state diagram of figure 4.8.

2) **Active_Idle or C/L:** where the RFP has either at least one dummy bearer or at least one connectionless downlink bearer, and a receiver that is scanning the physical channels in a known sequence;

3) **Active_Traffic:** where the RFP has at least one traffic bearer, but does not have a dummy or a connectionless downlink bearer;

4) **Active_Traffic_and_Dummy or C/L:** where the RFP has at least one traffic bearer and is also maintaining one dummy or connectionless downlink bearer.

5 Overview of MAC layer services

5.1 General

The MAC layer offers three groups of services to the upper layers and to the management entity. These service groupings are related to the functional groupings in the cluster control functions:

- broadcast message control;
- connectionless message control;
- multi-bearer control.

Each individual service is accessed via an independent service endpoint, and these endpoints are grouped into three Service Access Points (SAPs). Each service endpoint contains one or more logical channels. A fourth group of logical channels is provided for internal (peer-to-peer) MAC control information. The logical channels are described in clause 5.3 and the SAPs are described in clause 5.4.

5.1.1 Broadcast Message Control (BMC)

The BMC provides a set of continuous point-to-multipoint connectionless services. These are used to carry internal logical channels, and are also offered to the higher layers via the MA-SAP. These services operate in the direction FT to PT, and are available to all PTs within range.

The BMC services operate on all bearers, with each bearer carrying similar (equivalent) messages. The BMC services may appear alone, but they also appear combined with both of the other services, thereby producing bearers that contain data from two services (i.e. a single physical packet contains fields from both services).

5.1.2 Connectionless Message Control (CMC)

The CMC provides connectionless point-to-point or point-to-multipoint services to the higher layers via the MB-SAP. These services may operate in both directions between one specific FT and one or more PTs.

5.1.3 Multi-Bearer Control

Each instance of MBC provides one of a set of connection oriented point-to-point services to the higher layers via the MC-SAP. These services may operate in both directions or in one direction between one specific FT and one specific PT. Each service instance provides a connection (a connection oriented service) between one FT and one PT.

An MBC service may use more than one bearer to provide a single service. In this event, these multiple bearers may be used to carry duplicated data (to provide redundancy) and/or distributed data (to provide increased bandwidth).

5.2 Service descriptions

5.2.1 Common functions

All services shall only operate between one FT and one or more PTs.

All the services provide the following functions:

- a) the means to monitor signal quality;
- b) the means to provide error control for some data.

5.2.2 BMC service

The BMC service provides two types of broadcast information in the direction FT to PT:

- permanent broadcasts containing the two MAC control channels, Q and N (see clauses 5.3.4.1 and 5.3.4.2);
- transient broadcasts containing the MAC paging channel, BS (see clause 5.3.3.1).

The BMC service provides the following additional functions to the PT:

- a) the means to acquire and maintain frame and multiframe synchronism between transmitters and receivers;
- b) the means to obtain primary and secondary access right identities;
- c) the means to supply paging messages to the higher layers.

5.2.3 CMC service

The CMC service provides two alternative services:

- higher layer connectionless C-plane information, using the CL_S and CL_F channels (see clause 5.3.2.1);
- higher layer connectionless U-plane information, using the SI_N and the SI_P channels (see clause 5.3.2.2).

A single CCF may contain one single CMC instance. This CMC instance cannot be combined with an MBC connection service.

The CMC service provides the following additional function:

- the means to multiplex more than one logical channel onto each MAC bearer of the broadcast, with defined priorities.

5.2.4 MBC services

Each MBC instance can provide two separate connection oriented services to the higher layer:

- higher layer C-plane information, contained in the C-channels (see clause 5.3.1.1);
- higher layer U-plane information contained in the I and G_F channels (see clauses 5.3.1.2 and 5.3.1.3).

These two services are independent, and may be provided in combination or separately as part of a given MBC service. The overall service may be bi-directional, or unidirectional (in either direction). The chosen service type(s), and the service directions are defined during MBC connection establishment.

Each MBC service provides the following additional functions:

- a) the means to set up, maintain and clear down a variety of different connections using one or more bearers (duplex bearers and/or double simplex bearers);
- b) the ability to preserve connection quality by performing individual "bearer handover" or "bearer replacement" of any duplex or double simplex bearers;
- c) the means to multiplex more than one logical channel onto each MAC bearer of the connection, with defined priorities;
- d) the means to encrypt optionally all higher layer data.

5.3 Logical channels

The following logical channels are defined:

- a) MBC connection endpoints (MC-SAP logical channels):

C-channels: C_S and C_F ;

I channels: I_N and I_P ;

G_F channel;

- b) CMC service endpoint (MB-SAP logical channels):

CL channels: CL_S and CL_F ;

SI_N channel and SI_P channel;

- c) BMC broadcast endpoint (MA-SAP logical channel):

BS channel;

- d) Internal MAC control channels:

Q-channel;

N-channel;

M-channel;

P-channel.

5.3.1 MBC connection endpoints (MC-SAP logical channels)

5.3.1.1 The higher layer C-plane channels, C

Higher layer information from the DLC C-plane uses the C-channels, these are two independent channels, the C_S channel and the C_F channel.

The C_S channel is a slow duplex channel for higher layer information. It offers a low capacity which can be used by the higher layers with virtually no restriction. The transmission of C_S channel data reduces the throughput of the logical N-channel.

The C_F channel is a fast duplex channel for higher layer information with a higher capacity than the C_S channel. Transmissions of C_F channel data may reduce the throughput of, or interrupt, the logical I channel.

All C-channel information is protected by MAC layer error control which uses error correction based on an Automatic Repeat reQuest (ARQ).

5.3.1.2 The higher layer U-Plane channels, I

Higher layer information from the DLC U-plane uses the I channels. These are the I_N channel and the I_P channel, and they have different MAC layer protection schemes. The higher layers choose one of the two channels, the I_N and I_P channels shall not be used in parallel for the same connection.

The I_N information is protected by limited MAC layer error detection (X-field) and may include a minimum delay mode for coded speech transmission. Depending on the physical packet size the MAC layer processes I_N channel data in fields of different length.

The I_P information is protected by MAC layer procedures, either error correction based on a modulo 2 retransmission scheme or just error detection based on 16 or 32 bit CRCs. Two B-field formats for I_P channel data are available: One format defines multiple subfields of 10 octets including 8 octets data, each subfield protected by one 16-bit CRC. The other format defines a single data subfield protected by a 16 bit or 32-bit CRC, depending on the packet size. The DLC layer requests a service type, maximum allowed transmission time, and target and minimum acceptable numbers of uplink and downlink bearers which the MAC layer tries to provide.

5.3.1.3 The higher layer U-Plane control channel, G_F

Higher layer U-plane control from the DLC uses the G_F channel.

The G_F channel is a fast simplex channel that is used to provide control of U-plane entities. For example, it is used to carry acknowledgements for asymmetric connections.

All G_F channel information is protected by a MAC layer error control which allows error detection.

5.3.2 CMC endpoints (MB-SAP logical channels)

5.3.2.1 The connectionless C-Plane channels, C_L

Higher layer connectionless information from the DLC C-plane uses the C_L channels, these are two independent channels, the C_{L_S} channel and the C_{L_F} channel.

The C_{L_S} channel is a slow simplex channel for higher layer information. It offers a low capacity which can be used by the higher layers with virtually no restriction. The transmission of C_{L_S} channel data reduces the throughput of the logical N-channel.

The C_{L_F} channel is a fast simplex channel for higher layer information with a higher capacity than the C_{L_S} channel.

All C_L channel information is protected by MAC layer error control which allows error detection.

5.3.2.2 The connectionless U-Plane channels, SI_N and SI_P

Higher layer connectionless information from the DLC U-plane uses the SI_N and SI_P channels.

The SI_N information is protected by limited MAC layer error detection (X-field) and can be used for coded speech transmission. Depending on the physical packet size the MAC layer processes SI_N channel data in fields of different length.

The SI_P information is protected by MAC layer error detection procedures based on 16 bit CRCs.

5.3.3 BMC endpoint (MA-SAP logical channel)

5.3.3.1 The slow broadcast channel, BS

The slow broadcast channel, BS, is a simplex data channel in the direction FT to PTs. It is used to broadcast transient information from RFPs to all PTs that are listening. BS channel data is transmitted by RFPs on traffic, connectionless, and dummy bearers. BS channel information is available to Idle_Locked and Active_Locked PTs.

The transmission of BS channel data reduces the throughput of the logical N-channel.

All BS channel information is protected by MAC layer error control which allows error detection.

NOTE: A typical use for the BS channel is to broadcast call set up requests; however, other uses are allowed.

5.3.4 Internal MAC control channels

5.3.4.1 The system information channel, Q

The system information channel, Q, is a simplex data channel used to supply PTs with information about the DECT FP. Most Q-channel data is transmitted as repeated broadcasts on traffic, connectionless and dummy bearers. Q-channel data may also be transmitted on request.

Some Q-channel information is needed by a PT to change from the Active_Unlocked state to the Idle_Locked state.

All Q-channel information is protected by MAC layer error control which allows error detection.

5.3.4.2 Identities channel, N

The identities channel, N, is used for repeated transmissions of a system identity. N-channel data is transmitted by RFPs on traffic, connectionless and dummy bearers, and by PTs on traffic bearers.

The identities channel N has two purposes:

- for Active_Unlocked PPs the N-channel has a similar function as the Q-channel. Here the N-channel can be considered as a simplex channel in the RFP to PP direction. The broadcast identity helps active unlocked PPs to find a system which offers the desired service and to which they have access rights;
- for Active_Locked PPs the N-channel is received on all FP to PP bearers and echoed on all PP to FP bearers to provide a MAC layer handshake.

All N-channel information is protected by MAC layer error control which allows error detection.

5.3.4.3 The MAC control channel, M

The M channel is used to carry MAC layer information. This information appears in three different positions:

- MAC control in all header fields (see clause 6.2.1.2);
- MAC control in a tail field (see clause 6.2.2.1);
- MAC control in any B-subfield (see clause 6.2.2.3).

MAC control forms an integral part of all three services. When used on a duplex bearer (as part of the MBC service) it conveys point-to-point MAC control. On all services it is also used to broadcast MAC layer status information.

All M channel information is protected by MAC layer error control which allows error detection.

5.3.4.4 MAC paging channel, P

The P-channel is used to carry paging messages. Each of these messages may contain one segment of data from the BS logical channel.

The P-channel appears as a part of all bearers transmitting in the direction FT to PT. The P-channel is normally the only channel that is received by an PT in the Idle_Locked state.

All P-channel information is protected by a MAC layer error control which allows error detection.

5.4 SAP definitions

The MAC layer communicates with the DLC layer through 3 SAPs. These SAPs are the MA SAP, the MB SAP and the MC SAP.

The MAC layer communicates with the management entity through the ME SAP.

The MAC layer communicates with each PHL instance through an independent D SAP. The D SAP is defined in EN 300 175-2 [2].

5.4.1 MA SAP

This is a SAP between the MAC and DLC layers. The SAP contains a single broadcast endpoint, containing one logical channel, the BS channel. The primitives passed through the MA SAP are used to:

- carry BS channel data; and
- control the data flow of the BS channel data.

The BS channel provides a connectionless simplex (broadcast) service in the direction FT to PT.

The permitted SDU lengths in primitives carrying BS channel data are 0, 20, 36, 72, 108, 144, 180 or 216 bits.

5.4.2 MB SAP

This is a SAP between the MAC and the DLC layer. The MB SAP contains one service endpoint with four logical channels, the CL_F, CL_S, SI_N and SI_P channels.

The CL_S and CL_F channels provide connectionless services in both directions, FT to PT and PT to FT. In direction FT to PTs the connectionless service is continuous, in direction PT to FT the service is discontinuous.

The permitted SDU length in primitives containing CL_S channel data is 40 bits (= 1 CL_S segment).

The permitted SDU length in primitives containing CL_F channel data is an integer multiple of the CL_F data segment length, which is 64 bits.

The SI_N channel offers one unprotected simplex service to the higher layers (FT to PT only).

The SI_P channel offers one protected simplex service to the higher layers (FT to PT only).

For the SI_N service the SDU length corresponds to the size of the SI_N data fields in the U-type multiplexes (see clause 6.2.2.2).

For the SI_P service, the SDU length corresponds to the size of the SI_P data fields in the U-type multiplexes (see clause 6.2.2.2).

5.4.3 MC SAP

This is a SAP between the MAC and DLC layers. The SAP may contain multiple connection endpoints, and five logical channels are associated with each endpoint; C_S , C_F , G_F , I_N , and I_P channels. Primitives transferred through this SAP are used to:

- control the MAC processes to establish, maintain and release connections;
- carry C_S , C_F , G_F , I_N and I_P channel data; and
- control the data flow of the C_S , C_F , G_F , I_N and I_P channel data.

The C_S and the C_F channel offer two independent connection-oriented duplex services.

For one connection the maximum throughput of C_S channel data is 2 kbps. The SDU length of primitives carrying C_S channel data is equal to the C_S data segment length of 40 bits.

The maximum throughput of C_F channel data is 6,4 kbit/s for half slot connections, 25,6 kbit/s for full slot connections, and 64 kbit/s for double slot connections. For C_F channel data the SDU length is an integer multiple of the C_F data segment length, which is 64 bits.

The I_P and I_N channels offer two independent connection orientated duplex services to the higher layers. One service uses either the logical I_N or the logical I_P channel.

For all data services the SDU length is an integer multiple of the I channel data segment length. The segment length need not be the same for every service and corresponds to the size of the I_N and I_P data fields in the U-type multiplexes (see clause 6.2.2.2).

The G_F channel offers a connection oriented simplex service. The G_F SDU length is 56 bits.

5.4.4 ME SAP

This is a SAP between the MAC layer and the management entity. There is no formal definition for this interface, i.e. no endpoints and no logical channels are defined.

The following information is transferred:

- control of certain MAC processes (e.g. encryption);
- transfer of certain broadcast data (e.g. FP identities).

5.4.5 Order of transmission

Certain primitives exchanged between the MAC layer and the DLC layer may have a SDU containing peer-to-peer messages. The SDU data is arranged as a list of octets or part octets, starting with octet 1. The bits within one octet are numbered from 1 to 8 where the most significant bit has number 8. The MAC layer transmits these octets in ascending order, starting with octet 1. Valid bits within one octet are transmitted in descending order.

5.5 Bearers

MAC bearers are the elements that are created by each cell site function. Each bearer corresponds to a single service instance to one PHL. Duplex and double-simplex bearers may be combined by the MBC to provide complete MAC connections to provide a co-ordinated connection oriented service (see clause 5.6).

5.5.1 Bearer types

Four types of bearer are defined:

- 1) **Simplex bearer:** a simplex bearer is created by allocating one physical channel for transmissions in one direction. Two types of simplex bearers exist, short and long simplex bearers. The short simplex bearers only contain the A-field whereas long simplex bearers contain the A-field and the B-field (see clause 6.2.1). One simplex bearer is created by one dummy bearer controller or by one connectionless bearer controller. A DBC shall always control a short simplex bearer.
- 2) **Duplex bearer:** a duplex bearer is created by a pair of simplex bearers, operating in opposite directions on two physical channels. These pairs of channels shall always use the same RF carrier and shall always use evenly spaced time slots (i.e. the starting points of the time slots are separated by 0,5 frame). One duplex bearer is created by one traffic bearer controller or one connectionless bearer controller. A duplex bearer controlled by a TBC always contains the A-field and the B-field in both directions (see clause 6.2.1).
- 3) **Double simplex:** a double simplex bearer is created by a pair of long simplex bearers operating in the same direction on two physical channels. These pairs of channels shall always use the same RF carrier and shall always use evenly spaced time slots (i.e. the starting points of the time slots are separated by 0,5 frame). Double simplex bearers shall only exist as part of a multi-bearer connection. One double simplex bearer is created by one traffic bearer controller.
- 4) **Double duplex bearer:** a double duplex bearer is composed by a pair of duplex bearers referring to the same MAC connection. Each duplex bearer is created by one TBC and the pair is controlled by the same MBC. The duplex bearers share their simplex bearers for the information flow.

Transmission on a bearer uses the PL_TX primitive, where the SDU in each PL_TX-req primitive contains the data for one slot (for one transmission).

Reception on a bearer uses the PL_RX primitive, where the SDU in each PL_RX-cfm primitive contains the data for one slot (for one reception).

5.5.2 Bearer operation

A bearer can exist in one of three operational states:

- 1) **Dummy bearer:** where there are normally continuous transmissions (i.e. one transmission in every frame, refer to clause 5.7). These transmissions never contain data related to the MC or the MB SAP. A dummy bearer only supports BMC services. A dummy bearer is a short simplex bearer.
- 2) **Traffic bearer:** where there are continuous point-to-point transmissions that usually contain MC SAP data but never contain data related to the MB SAP. A traffic bearer supports both, BMC and MBC services. A traffic bearer is a duplex bearer or a double simplex bearer or a double duplex bearer.
- 3) **Connectionless bearer:** where there are transmissions that may contain MB SAP data but never contain data related to the MC SAP. A connectionless bearer supports both BMC and CMC services. In the direction FT to PTs a connectionless bearer is either duplex if the RFP also supports the connectionless uplink service, or simplex if it does not support the connectionless uplink service. For a PT, a connectionless bearer is either a simplex or a duplex bearer.

"Logical bearer" defines the effective service available from one traffic bearer. During bearer handover two identical duplex or double simplex bearers may exist to provide the service of one logical bearer. At all other times each logical bearer corresponds to one duplex or double simplex bearer.

5.6 Connection oriented services

Each MBC instance creates one MAC connection, and provides an independent service to the higher (DLC) layer. A MAC connection is wholly contained within one cluster, using the services of one or more TBCs within that cluster.

Each MAC connection may use the services of one or more bearers. A single-bearer connection shall use a single duplex bearer. A multi-bearer connection shall use one duplex bearer plus one or more additional duplex and/or double simplex bearers.

5.6.1 Connection types

The MAC provides C-channel and I-channel services to the DLC layer by setting up and maintaining MAC connections.

All RFPs of a cluster shall provide the same capabilities to transmit higher layer control (in particular, the C_F and G_F channel capabilities shall be the same).

Three type of connections are defined:

- basic connections;
- advanced connections;
- complementary connections.

5.6.1.1 Basic connections

Basic connections have no common connection number (common is defined to mean the same connection number is known at both PT and FT). Therefore, only one basic connection may exist between a PT (identified by its PMID) and one particular FT (identified by the ARI).

Exception: During connection handover two basic connections may exist, serving the same DLC link.

Basic connections only provide one full slot duplex bearer for the I_N _minimum_delay service. Suspension from B-field transmission can be allowed (i.e. the use of short bearers) in the direction PT to FT, once the bearer has been established. The use of a short bearer shall be signalled by the no B-field BA bits code (see clause 7.1.4); in this case, if the connection is ciphered, the two key stream segments of the D.32 field still apply of which only the first 40 bits are used (see EN 300 175-7 [6], clause 6.4.2).

Because basic connections are always single bearer connections no Logical Bearer Number (LBN) is assigned to the bearer for these connections.

Basic connections shall not support C_F , G_F and I_P channels and shall not send MAC extended control in the B-field.

5.6.1.2 Advanced connections

Advanced connections have a common connection number, called Exchanged Connection Number (ECN) which is assigned by the LLME. Therefore, more than one advanced connection may exist between a PT and one FT. Advanced connections may provide any service listed in clauses 5.6.2.1 and 5.6.2.2.

Bearers of advanced connections are labelled by the MAC with LBNs (common parameters). The LBN enables the MAC to distinguish between different bearers in the same connection.

Advanced connections may support the C_F channel.

5.6.1.3 Connection identifiers

Locally each connection (each instance of an MBC) is always identified by a MAC Connection Endpoint Identification (MCEI). This MCEI allows the DLC to select one particular connection. In the PT the MCEI is assigned by the LLME and is unique within that PT. In the FT the MCEI is assigned by the LLME and is unique within that FT identified by its ARI. In general the MCEIs will be different in the PT and the FT for any given connection.

For advanced connections, a further common identifier, the ECN, is transmitted between PT and FT. The full identifier consists of ARI + PMID + ECN. PMID and ARI identify the PT and the FT. The ECN allows different advanced connections between the same PT and FT to be distinguished. The DLC and MAC at both ends know this common identifier.

5.6.1.4 Complementary connections

Complementary connections only provide one duplex bearer without referring to a particular service.

Complementary connections do not require the opening of a DLC link and can be identified at the MAC layer by the PMID.

A duplex bearer of a complementary connection can be linked to a duplex bearer of a basic or an advanced connection by a mapping procedure (see clause 10.5.1.6); after the mapping, it shall acquire the same properties of the linked channel and shall be referred to the same connection. The two linked bearers constitute a double duplex bearer.

5.6.2 Symmetric and asymmetric connections

The different connection oriented service types are divided into two categories, symmetric and asymmetric connections:

- **Symmetric connections** will always have the same number of simplex bearers in both transmission directions. Moreover the service characteristics (see clause 5.6.2.1) and their bandwidths are the same for both directions.
- **Asymmetric connections** have a different number of logical simplex bearers for both transmission directions. Typically, there are only one or two bearers in the "reverse" direction. Although the services in both directions have the same characteristics the bandwidth of the services will differ.
- **Multibearer connections** exist only in full slot and double slot transmission mode. This means that multibearer asymmetric and symmetric connections are not permitted in half slot transmission mode. All bearers of a multibearer connection shall be from the same slot type, i.e. either full slot or double slot.

In all connections, the DLC gives the MAC a "target number of bearers" and a "minimum acceptable number of bearers" to establish. When the connection has been established (or set up has failed), the MAC tells the DLC the "actual number of bearers" that have been established. In many cases the "target number of bearers" equals the "minimum acceptable number of bearers".

5.6.2.1 Symmetric connections

The four symmetric service types are distinguished by their I channel data protection and their throughput:

- type 1: I_N _minimum_delay: limited error protection, minimum delay, fixed throughput;
- type 2: I_N _normal_delay: limited error protection, normal delay, fixed throughput;
- type 3: I_P _error_detection: error detection capability, fixed throughput; and
- type 4: I_P _error_correction: error correction, variable throughput.

NOTE 1: Service type 1 (I_N _minimum_delay) exists only as single bearer service. I_N _minimum_delay and I_N _normal_delay services have different I channel flow control (see clause 8.4).

NOTE 2: The throughput of service types 2 and 3 can vary if the MAC layer changes the number of bearers assigned to that connection.

Service type 3 using the single subfield protected B-field format is called I_{PQ} _error_detection; service types 4 using the single subfield protected B-field format is called I_{PQ} _error_correction.

The most important parameters of the four symmetric services are listed in tables 5.1 and 5.2.

Table 5.1: Symmetric services (2 level modulation)

ST	I channel capacity (kbit/s)	B-field multiplex schemes	NP	err det.	err corr.	max. C _F	dly (ms)
1d2	80	(U80a,E80)	I _N	no	no	64,0	≈ 10
1f2	32	(U32a,E32)	I _N	no	no	25,6	≈ 10
1h2	8 + j/10	(U08a,E08)	I _N	no	no	6,4	≈ 10
2d2	k x 80	(U80a,E80)	I _N	no	no	64,0	15
2f2	k x 32	(U32a,E32)	I _N	no	no	25,6	15
2h2	8 + j/10	(U08a,E08)	I _N	no	no	6,4	15
3d2	k x 64,0	(U80b,E80)	I _P	yes	no	64,0	15
3f2	k x 25,6	(U32b,E32)	I _P	yes	no	25,6	15
3h2	6,4	(U08b,E08)	I _P	yes	no	6,4	15
4d2	≤ k x 64,0	(U80b,E80)	I _P	yes	yes	64,0	var
4f2	≤ k x 25,6	(U32b,E32)	I _P	yes	yes	25,6	var
4h2	≤ 6,4	(U08b,E08)	I _P	yes	yes	6,4	var
3d2ssub	k x 76,8	U80c	I _P	Yes	no	-	15
3f2ssub	k x 30,4	U32c	I _P	Yes	no	-	15
4d2ssub	≤ k x 76,8	U80c	I _P	Yes	yes	-	var
4f2ssub	≤ k x 30,4	U32c	I _P	Yes	yes	-	var
ST:	Service Type, xdy = type x double slot, modulation y levels; xfy = type x full slot, modulation y levels; xhy = type x half slot, modulation y levels; ssub = single subfield protected B-field format.						
NP:	I _N channel or I _P channel						
err. det.:	error detection capability						
err. corr.:	error correction possibility						
max. C _F :	maximum C _F channel throughput						
dly:	approximate delay incurred by I channel data in ms. "var" is variable						
t:	the target number of duplex bearers; w ≤ t						
k:	the actual number of duplex bearers; w ≤ k ≤ t						
NOTE:	Refer to clause 6.2.2.2 for details of B-field multiplex schemes.						

Table 5.2: Symmetric services (4 and 8 level modulation)

ST	I channel capacity (kbit/s)	B-field multiplex schemes	NP	Err det.	Err corr.	max. C _F	dly (ms)
1d4	160 + f/10	(U160a, E160)	I _N	No	No	128	≈10
1d8	240 + f/10	(U240a, E240)	I _N	No	No	192	≈10
1f4	64 + f/10	(U64a, E64)	I _N	No	No	51,2	≈10
1f8	96 + f/10	(U96a, E96)	I _N	No	No	76,8	≈10
1h4	16 + (j + f)/10	(U16a, E16)	I _N	No	No	12,8	≈10
1h8	24 + (j + f)/10	(U24a, E24)	I _N	No	No	19,2	≈10
2d4	K x (160 + f/10)	(U160a, E160)	I _N	No	No	128	15
2d8	K x (240 + f/10)	(U240a, E240)	I _N	No	No	192	15
2f4	K x (64 + f/10)	(U64a, E64)	I _N	No	No	51,2	15
2f8	K x (96 + f/10)	(U96a, E96)	I _N	No	No	76,8	15
2h4	16 + (j + f)/10	(U16a, E16)	I _N	No	No	12,8	15
2h8	24 + (j + f)/10	(U24a, E24)	I _N	No	No	19,2	15
3d4	K x 128	(U160b, E160)	I _P	Yes	No	128	15
3d8	K x 192	(U240b, E240)	I _P	Yes	No	192	15
3f4	K x 51,2	(U64b, E64)	I _P	Yes	No	51,2	15
3f8	K x 76,8	(U96b, E96)	I _P	Yes	No	76,8	15
3h4	12,8	(U16b, E16)	I _P	Yes	No	12,8	15
3h8	19,2	(U24b, E24)	I _P	Yes	No	19,2	15
4d4	≤ k x 128	(U160b, E160)	I _P	Yes	Yes	128	Var
4d8	≤ k x 192	(U240b, E240)	I _P	Yes	Yes	192	Var
4f4	≤ k x 51,2	(U64b, E64)	I _P	Yes	Yes	51,2	Var
4f8	≤ k x 76,8	(U96b, E96)	I _P	Yes	Yes	76,8	Var
4h4	≤ 12,8	(U16b, E16)	I _P	Yes	Yes	12,8	Var
4h8	≤ 19,2	(U24b, E24)	I _P	Yes	Yes	19,2	Var
3d4ssub	K x (156,8 + f/10)	U160c	I _P	Yes	No	-	15
3d8ssub	K x (238,6 + f/10)	U240c	I _P	Yes	No	-	15
3f4ssub	K x (60,8 + f/10)	U64c	I _P	Yes	No	-	15
3f8ssub	K x (92,8 + f/10)	U96c	I _P	Yes	No	-	15
4d4ssub	≤ k x (156,8 + f/10)	U160c	I _P	Yes	Yes	-	Var
4d8ssub	≤ k x (236,8 + f/10)	U240c	I _P	Yes	Yes	-	Var
4f4ssub	≤ k x (60,8 + f/10)	U64c	I _P	Yes	Yes	-	Var
4f8ssub	≤ k x (92,8 + f/10)	U96c	I _P	Yes	Yes	-	Var
ST:	Service Type, xdy = type x double slot, modulation y levels; xfy = type x full slot, modulation y levels; xhy = type x half slot, modulation y levels. f = 0 for 2 level modulation in A field, f = 64 for 4 level modulation in A field, f = 128 for 8 level modulation in A field; ssub = single subfield protected B-field format.						
NP:	I _N channel or I _P channel.						
Err. det.:	error detection capability.						
Err. corr.:	error correction possibility.						
max. C _F :	maximum C _F channel throughput.						
dly:	approximate delay incurred by I channel data in ms. "var" is variable.						
t:	the target number of duplex bearers; w ≤ t.						
k:	the actual number of duplex bearers; w ≤ k ≤ t.						
NOTE:	Refer to clause 6.2.2.2 for details of B-field multiplex schemes.						

5.6.2.2 Asymmetric connections

General principles:

- a) simplex bearers are always allocated in pairs;
- b) pairs of simplex bearers are one half TDMA frame apart;
- c) there exists $(k + m + n)$ simplex bearers where $k \geq m + n \geq 1$.
k bearers are in the main, "forward" data direction and $m + n$ bearers are in the opposite, "reverse" direction;
- d) all the k bearers in the forward direction have the same format;
- e) the n bearers in the reverse direction are called "special" bearers. Depending on the slot type these bearers have the E32 or the E80 format. They may be used to report reception quality on the double simplex bearers in the forward data direction and carry G_F channel data. These special bearers shall not carry I channel data;
- f) the m data bearers in the reverse direction have the same format as the k bearers in the forward direction;
- g) the n special bearers shall be at least 1.

The three asymmetric service types are distinguished by their I channel data protection and their throughput:

- type 5: $I_{N_normal_delay}$: limited error protection, normal delay, fixed throughput;
- type 6: $I_{P_error_detection}$: error detection capability, fixed throughput;
- type 7: $I_{P_error_correction}$: error correction, variable throughput.

Service type 6 using the single subfield protected B-field format is called $I_{PQ_error_detection}$; service types 7 using the single subfield protected B-field format is called $I_{PQ_error_correction}$.

Tables 5.3 and 5.4 show the most important parameters for asymmetric connections. The first line in each description defines the forward data direction. The second and third line describe the reverse direction. The same abbreviations are used as in tables 5.1 and 5.2.

Table 5.3: Asymmetric services (2 level modulation)

ST	I channel capacity	B-field multiplex schemes	NP	err det.	e rr corr.	max. C _F
5d2	k x 80	(U80a,E80)	I _N	no	no	64,0
	m x 80	(U80a,E80)	I _N	no	no	64,0
	n x 0	(E80)	-	yes	no	64,0
5f2	k x 32	(U32a,E32)	I _N	no	no	25,6
	m x 32	(U32a,E32)	I _N	no	no	25,6
	n x 0	(E32)	-	yes	no	25,6
6d2	k x 64	(U80b,E80)	I _P	yes	no	64,0
	m x 64	(U80b,E80)	I _P	yes	no	64,0
	n x 0	(E80)	-	yes	no	64,0
6f2	k x 25,6	(U32b,E32)	I _P	yes	no	25,6
	m x 25,6	(U32b,E32)	I _P	yes	no	25,6
	n x 0	(E32)	-	yes	no	25,6
6d2ssub	k x 76,8	(U80c)	I _P	yes	no	-
	m x 76,8	(U80c)	I _P	yes	no	-
	n x 0	(E80)	-	yes	no	64,0
6f2ssub	k x 30,4	(U32c)	I _P	yes	no	-
	m x 30,4	(U32c)	I _P	yes	no	-
	n x 0	(E32)	-	yes	no	25,6
7d2	≤ k x 64	(U80b,E80)	I _P	yes	yes	64,0
	≤ m x 64	(U80b,E80)	I _P	yes	yes	64,0
	n x 0	(E80)	-	yes	no	57,6*
7f2	≤ k x 25,6	(U32b,E32)	I _P	yes	yes	25,6
	≤ m x 25,6	(U32b,E32)	I _P	yes	yes	25,6
	n x 0	(E32)	-	yes	no	19,2*
7d2ssub	≤ k x 76,8	(U80c)	I _P	yes	yes	-
	≤ m x 76,8	(U80c)	I _P	yes	yes	-
	n x 0	(E80)	-	yes	no	57,6*
7f2ssub	≤ k x 30,4	(U32c)	I _P	yes	yes	-
	≤ m x 30,4	(U32c)	I _P	yes	yes	-
	n x 0	(E32)	-	yes	no	19,2*
ST:	Service Type.					
xdy:	type x double slot, y levels modulation.					
xfy:	type x full slot, y levels modulation.					
xh:	type x half slot, where x = the Service Type.					
ssub	singlesubfield protected B-field format.					
NP:	IN channel or IP channel.					
err.det.:	error detection capability.					
err.corr.:	error correction possibility.					
max.C _F :	maximum C _F channel throughput.					
k:	the actual number of simplex bearers in the forward direction.					
m:	the actual number of simplex data bearers in the reverse direction.					
n:	the actual number of simplex special bearers in the reverse direction.					
*:	it is expected that the "MAC-Mod2-ACKs" message is normally sent on this bearer, reducing the C _F capacity by 6,4 kbit/s.					
NOTE:	Refer to clause 6.2.2.2 for details of B-field multiplex schemes.					

For type 5, fixed throughput service without error correction, $(k + m + n) \text{ MOD } 2$ shall equal 0, n shall be increased by 1 if necessary.

For type 6, fixed throughput service without error correction, $(k + m + n) \text{ MOD } 2$ shall equal 0, either k, m or n may be increased by 1.

NOTE 1: The throughput of service types 5 and 6 can vary if the MAC layer changes the number of bearers assigned to that connection.

For type 7, variable throughput, variable delay with modulo 2 based retransmission scheme, $(k + m + n) \text{ MOD } 2$ shall equal 0, either k, m or n may be increased by 1.

Table 5.4: Asymmetric services (4,8 level modulation)

ST	I channel capacity	B-field multiplex schemes	NP	err det.	err corr.	max. C _F
5d4	k x (160+f/10)	(U160a,E160)	I _N	no	No	128,0
	m x (160+f/10)	(U160a,E160)	I _N	no	No	128,0
	n x 0	(E160)	-	yes	No	128,0
5d8	k x (240+f/10)	(U240a,E240)	I _N	no	No	192,0
	m x (240+f/10)	(U240a,E240)	I _N	no	No	192,0
	n x 0	(E240)	-	yes	No	192,0
5f4	k x (64+f/10)	(U64a,E64)	I _N	no	No	51,2
	m x (64+f/10)	(U64a,E64)	I _N	no	No	51,2
	n x 0	(E64)	-	yes	No	51,2
5f8	k x (96+f/10)	(U96a,E96)	I _N	no	No	76,8
	m x (96+f/10)	(U96a,E96)	I _N	no	No	76,8
	n x 0	(E96)	-	yes	No	76,8
6d4	k x 128	(U160b,E160)	I _P	yes	No	128,0
	m x 128	(U160b,E160)	I _P	yes	No	128,0
	n x 0	(E160)	-	yes	No	128,0
6d8	k x 192	(U240b,E240)	I _P	yes	No	192,0
	m x 192	(U240b,E240)	I _P	yes	No	192,0
	n x 0	(E240)	-	yes	No	192,0
6f4	k x 51,2	(U64b,E64)	I _P	yes	No	51,2
	m x 51,2	(U64b,E64)	I _P	yes	No	51,2
	n x 0	(E64)	-	yes	No	51,2
6f8	k x 76,8	(U96b,E96)	I _P	yes	No	76,8
	m x 76,8	(U96b,E96)	I _P	yes	No	76,8
	n x 0	(E96)	-	yes	No	76,8
6d4ssub	k x (156,8 + f/10)	(U160c)	I _P	yes	No	-
	m x (156,8 + f/10)	(U160c)	I _P	yes	No	-
	n x 0	(E160)	-	yes	No	128,0
6d8ssub	K x (238,6 + f/10)	(U240c)	I _P	yes	No	-
	M x (238,6 + f/10)	(U240c)	I _P	yes	No	-
	n x 0	(E240)	-	yes	No	192,0
6f4ssub	K x (60,8 + f/10)	(U64c)	I _P	yes	No	-
	M x (60,8 + f/10)	(U64c)	I _P	yes	No	-
	n x 0	(E64)	-	yes	No	51,2
6f8ssub	K x (92,8 + f/10)	(U96c)	I _P	yes	No	-
	M x (92,8 + f/10)	(U96c)	I _P	yes	No	-
	n x 0	(E96)	-	yes	No	76,8
7d4	≤ k x 128	(U160b,E160)	I _P	yes	Yes	128,0
	≤ m x 128	(U160b,E160)	I _P	yes	Yes	128,0
	n x 0	(E160)	-	yes	No	121,6*
7d8	≤ k x 192	(U240b,E240)	I _P	yes	Yes	192,0
	≤ m x 192	(U240b,E240)	I _P	yes	Yes	192,0
	n x 0	(E240)	-	yes	No	185,4*
7f4	≤ k x 51,2	(U64b,E64)	I _P	yes	Yes	51,2
	≤ m x 51,2	(U64b,E64)	I _P	yes	Yes	51,2
	n x 0	(E64)	-	yes	No	44,8*
7f8	≤ k x 76,8	(U96b,E96)	I _P	yes	Yes	76,8
	≤ m x 76,8	(U96b,E96)	I _P	yes	Yes	76,8
	n x 0	(E96)	-	yes	No	70,4*

ST	I channel capacity	B-field multiplex schemes	NP	err det.	err corr.	max. C _F
6d4ssub	$\leq k \times (156,8 + f/10)$	(U160c)	I _P	yes	No	-
	$\leq m \times (156,8 + f/10)$	(U160c)	I _P	yes	No	-
	$n \times 0$	(E160)	-	yes	No	128,0
6d8ssub	$\leq k \times (238,6 + f/10)$	(U240c)	I _P	yes	No	-
	$\leq m \times (238,6 + f/10)$	(U240c)	I _P	yes	No	-
	$n \times 0$	(E240)	-	yes	No	192,0
6f4ssub	$\leq k \times (60,8 + f/10)$	(U64c)	I _P	yes	No	-
	$\leq m \times (60,8 + f/10)$	(U64c)	I _P	yes	No	-
	$n \times 0$	(E64)	-	yes	No	51,2
6f8ssub	$\leq k \times (92,8 + f/10)$	(U96c)	I _P	yes	No	-
	$\leq m \times (92,8 + f/10)$	(U96c)	I _P	yes	No	-
	$n \times 0$	(E96)	-	yes	No	76,8
ST:	Service Type					
xdy:	type x double slot, y levels modulation.					
xfy:	type x full slot, y levels modulation.					
	F = 0 for 2 level modulation in A-field, f = 64 for 4 level modulation in A field, f = 128 for 8 level modulation in A field.					
ssub	singlesubfield protected B-field format.					
NP:	I _N channel or I _P channel					
err.det.:	error detection capability					
err.corr.:	error correction possibility					
max.C _F :	maximum C _F channel throughput					
k:	the actual number of simplex bearers in the forward direction					
m:	the actual number of simplex data bearers in the reverse direction					
n:	the actual number of simplex special bearers in the reverse direction					
*:	it is expected that the "MAC-Mod2-ACKs" message is normally sent on this bearer, reducing the C _F capacity by 6,4 kbit/s.					
NOTE:	Refer to clause 6.2.2.2 for details of B-field multiplex schemes.					

For type 5, fixed throughput service without error correction, $(k + m + n) \text{ MOD } 2$ shall equal 0, n shall be increased by 1 if necessary.

For type 6, fixed throughput service without error correction, $(k + m + n) \text{ MOD } 2$ shall equal 0, either k, m or n may be increased by 1.

NOTE 2: The throughput of service types 5 and 6 can vary if the MAC layer changes the number of bearers assigned to that connection.

For type 7, variable throughput, variable delay with modulo 2 based retransmission scheme, $(k + m + n) \text{ MOD } 2$ shall equal 0, either k, m or n may be increased by 1.

5.7 Broadcast and connectionless services

Most of the broadcast and connectionless services shall be continuous in the downlink direction, i.e. from FT to PT, and non-existent or non-continuous in the uplink direction.

To provide the continuous downlink services a CSF may install one or two bearers which either supports only the broadcast service, i.e. dummy bearers, or which supports the broadcast and the connectionless services, i.e. connectionless bearers.

If two bearers are installed both bearers shall support the same services. The maximum of two bearers for one CSF is only allowed when:

- a) no traffic bearer with downlink transmissions exists at the CSF; and
- b) the FP has multiple RFPs with different FMIDs (see clause 11.7), and provides inter-cell handover capability.

If a CSF uses two bearers for this service, the CSF shall stop transmissions on one of these bearers, (i.e. release the bearer), within 4 multiframe after establishment of the first traffic bearer with downlink transmissions.

The only exception to the above rule applies when the CSF decides to change the physical channel(s) for one of these particular bearers. In this case the CSF may maintain one additional bearer to provide the continuous downlink services for a duration of up to 4 multiframe. At most one bearer for this continuous downlink service may change the physical channel(s) at the time. The number of physical channel changes for this exception shall not exceed 5 changes per any one-minute interval.

If a DBC or CBC is selected for the continuous downlink service this bearer shall normally transmit once per frame in downlink direction. The only allowed exception applies for quality control purposes of the chosen physical channel, e.g. RSSI measurements. A DBC or CBC may miss at most one downlink transmission in any one second interval, provided that:

- a) CMC services are not affected (CBC only);
- b) the BMC paging service (see clause 9.1.3) is not affected.

It is further not allowed to miss transmissions in frames 0,8 and 14 of a multiframe (see clause 6.2.2.1.1).

NOTE: If no CMC service is provided, the broadcast service may be offered by a traffic bearer of an ongoing connection. The exception of missing one frame's transmission does not apply for the TBC controlling this traffic bearer.

PT attempts to setup a traffic bearer using the same physical channel(s) as used for a connectionless downlink service shall be ignored by the CSF. With the system capabilities message the FT tells the PT whether or not a bearer setup attempt on dummy bearer(s) is allowed. If setup is prohibited a CSF shall ignore attempts to setup a bearer using the same physical channel as a dummy bearer.

5.7.1 The broadcast services

Two broadcast services are defined, a continuous and a non-continuous broadcast service.

5.7.1.1 The continuous broadcast service

The continuous broadcast service is a simplex service in the direction FT to PT, and is controlled by the BMC.

This service allows PTs to lock on to an FT and to acquire access rights and service related information (see clause 5.2.2). The service is available on all bearers with continuous transmissions in direction FT to PT. This can be a dummy bearer, a traffic bearer or a connectionless bearer.

Each RFP of an FP shall maintain at least one bearer with continuous broadcast transmissions. If an RFP maintains neither a traffic bearer nor a connectionless bearer with continuous transmissions the RFP shall install at least one dummy bearer to provide the broadcast service. Dummy bearers exist only in the downlink direction, i.e. FT to PT.

Data of the continuous broadcast service are always transmitted in the A-field (see clause 6.2.1). The functionality of the service is determined by the rules to distribute data from all broadcast channels into the A-field of consecutive frames within one multiframe (see clause 6.2.2).

5.7.1.2 The non-continuous broadcast service

The non-continuous broadcast service allows the PTs to obtain extended system information on request. This service is controlled by the BMC and works on a transient duplex bearer. The service needs a limited number of transmissions in both directions.

The request and the reply data are transmitted either in the A-field or in the B-field (see clause 6.2.1). The non-continuous broadcast service uses a unique A-field coding for the first transmission in either direction (see clause 7.2.5.6). This is in order to distinguish transmissions of this service from transmissions of other connectionless services.

5.7.2 The connectionless services

The connectionless services allow multicast transmission of higher layer C-plane and U-plane data from an FT to PTs, and point-to-point transmission of higher layer C-plane data from a PT to one FT. These services are controlled by the CMC. The FT to PTs connectionless service may be continuous (i.e. one transmission in every frame). In the direction PT to FT, transmission is limited to a maximum of two slots in two successive frames.

5.7.2.1 Connectionless downlink services

The connectionless downlink service offers a continuous simplex service to the DLC. Only one CMC downlink service may exist within each cluster.

Connectionless bearers used for a downlink service are marked by a special header code and may also be announced by using the BMC service.

A connectionless downlink service shall use CBCs controlling a duplex bearer or, if the CMC does not provide an uplink service, CBCs controlling a simplex bearer. If two CBCs are installed at a CSF to provide the connectionless downlink service all data of this service shall be duplicated on both CBCs.

NOTE 1: The number of allowed CBCs per CSF for connectionless downlink services is restricted (see clause 5.7).

NOTE 2: Connectionless downlink and uplink services are independent.

NOTE 3: A connectionless uplink service may choose another bearer than the duplex bearer which is used for the downlink service.

Four types of continuous connectionless simplex services exist. They are distinguished by the logical channels supported:

- a) only CL_S channel;
- b) CL_S and CL_F channels;
- c) CL_S and SI_N channels;
- d) CL_S and SI_P channels.

Service a) shall always use a short simplex bearer for the downlink. The services b) c) and d) use a long simplex bearer.

5.7.2.2 Connectionless uplink services

This service uses a CBC controlled bearer. Provided that the CBC controls both, the connectionless downlink and uplink service, this bearer is a duplex bearer. Otherwise the CBC controls a simplex bearer. The connectionless uplink service consists of one or two transmissions from the PT to the FT.

The following simplex services are offered to the DLC:

- a) CL_S -channel only, one CL_S segment;
- b) CL_F -channel only; and
- c) no SDU (only PMID passed to the FT's DLC).

Services a) and c) may use either a short simplex bearer or a long simplex bearer for the uplink. Service b) always uses a long simplex bearer for the uplink. All services may work together with either a short simplex bearer or a long simplex bearer for the downlink.

The PT uses A-field messages to address the RFP and to identify itself.

6 Multiplexing

To allocate DECT D-channel capacity to carry data from all logical channels defined in clause 5.3, several controllers, multiplex algorithms and mapping schemes are used. Figures 6.1 to 6.4 show the four possible MAC layer multiplexing structures, corresponding to the four bearer arrangements.

6.1 CCF multiplexing functions

The MBC establishes and maintains a connection and controls the data flow of the I and C-channels. For these purposes the MBC uses MAC control.

In the transmission direction the MBC distributes the data received through the MC SAP to all the TBCs in one connection. This includes the routing of C-channel data to one TBC or duplication of this data to more than one TBC and the careful management of data from all channels to two TBCs during seamless bearer handover.

In the receiving direction the MBC collects data from all TBCs. For C-channel data the receiving traffic controller removes duplicate data and performs resequencing.

For I-channel services the MBC is either responsible for resequencing the data or it applies a retransmission scheme to correct transmission errors (see clause 10.8).

Each MBC may contain a key stream generator. This element produces a cipher stream to encrypt or decrypt all I, GF and C-channel data.

The BMC manages and distributes N, Q and BS-channel data.

6.2 CSF multiplexing functions

Every TBC or CBC or DBC multiplexes data received from BMC, from CMC and from MBC onto D-fields for delivery to the physical layer. The following functions are defined:

MAC control: MAC control is needed to setup, maintain and release bearers, and to enable/disable encryption.

Bit MAPPings (MAP): MAPs are spatial multiplexers, that combine two or more fields into a single (larger) field. Three MAPs are defined: A-MAP, B-MAP and D-MAP.

Time MULTipleXers (MUX): MUXs are used to switch between alternative fields on a frame-by-frame basis. They operate synchronously to the applied frame and multiframe timing. Three MUXs are defined: C-MUX, T-MUX and E/U MUX.

Scrambler: scrambling is used to modify specific data fields every frame according to a standard (predefined) pattern (see clause 6.2.4).

Encryption: encryption is used to modify specific data fields according to a secret pattern denoted KSG in figure 6.1 (see clause 6.2.3). The use of encryption is optional.

Error control (CRC): the error control modules generate extra error control bits (redundancy bits) according to standard cyclic generation algorithms (see clause 6.2.5).

Broadcast control: this is used to merge MAC information with higher layer information as part of the BMC service.

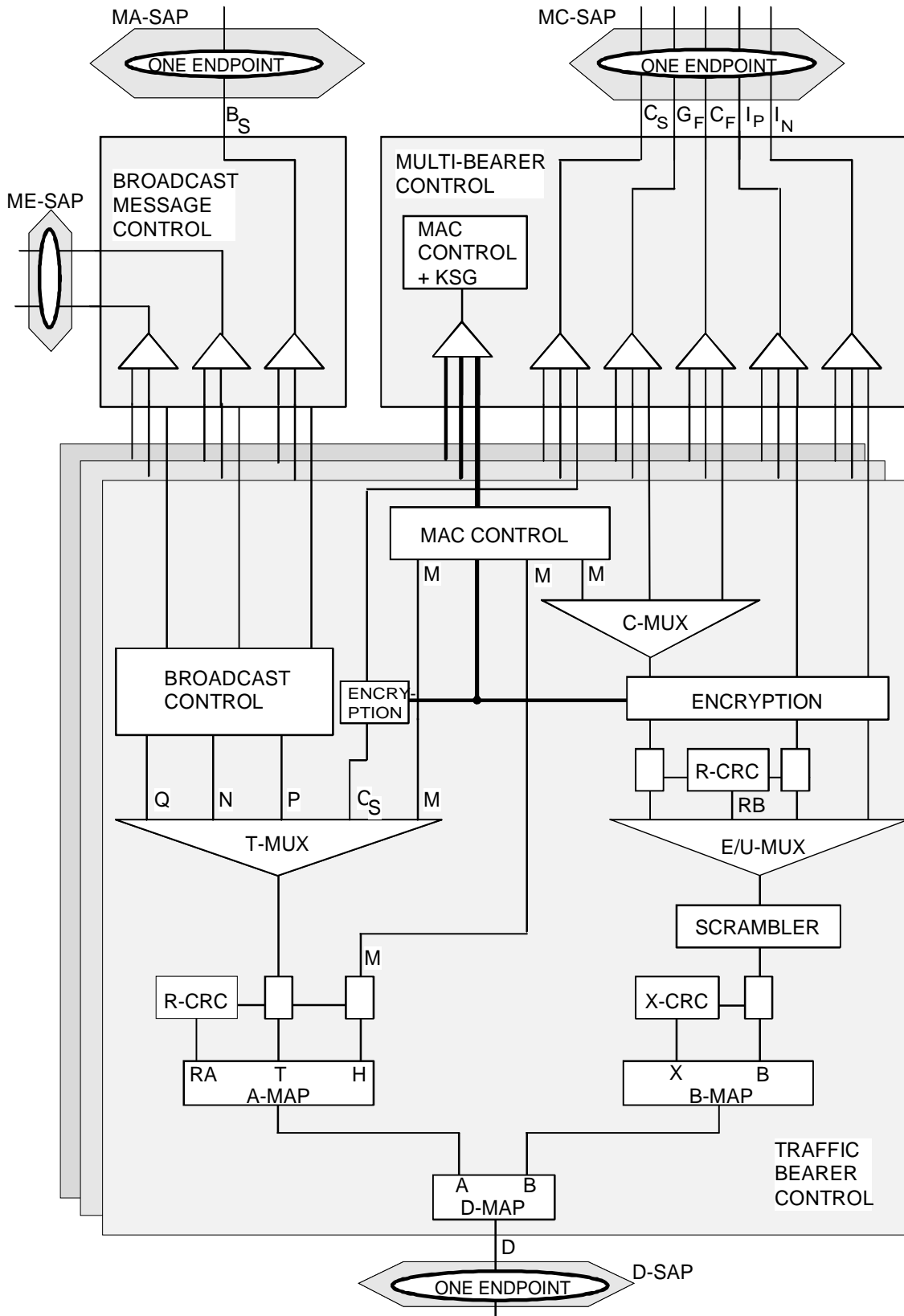

Figure 6.1: TBC multiplexing

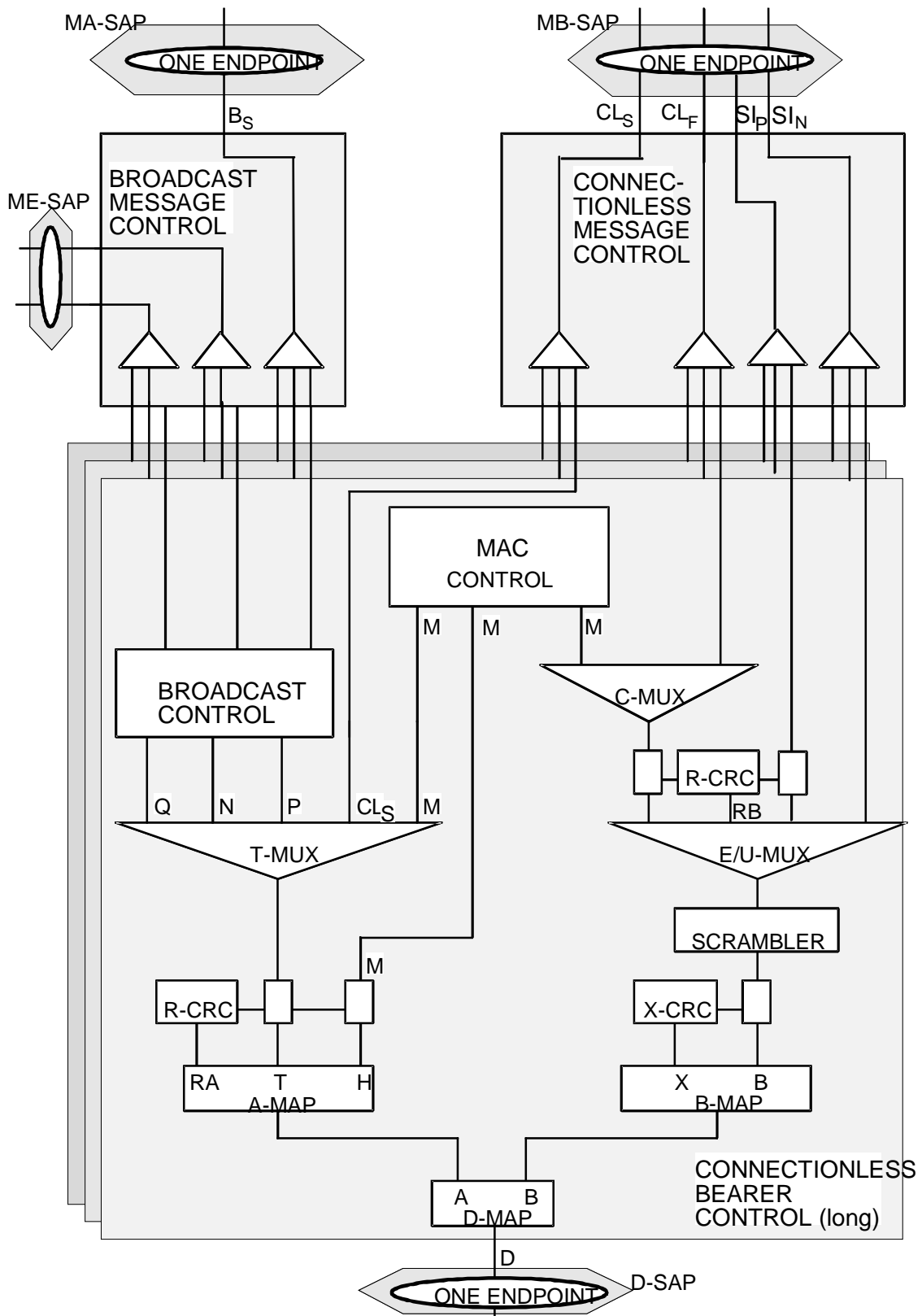

Figure 6.2: CBC multiplexing (long)

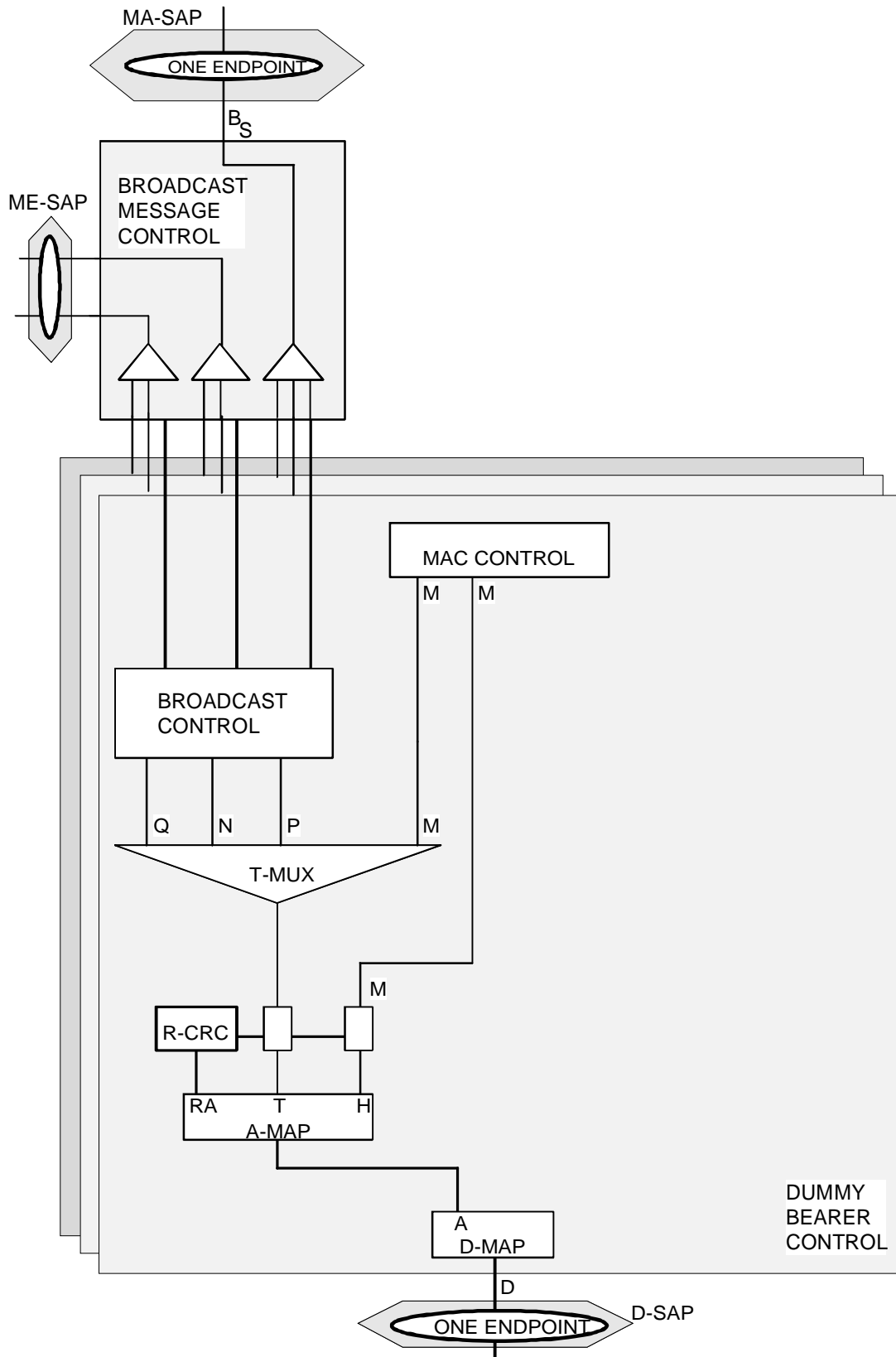

Figure 6.3: DBC multiplexing

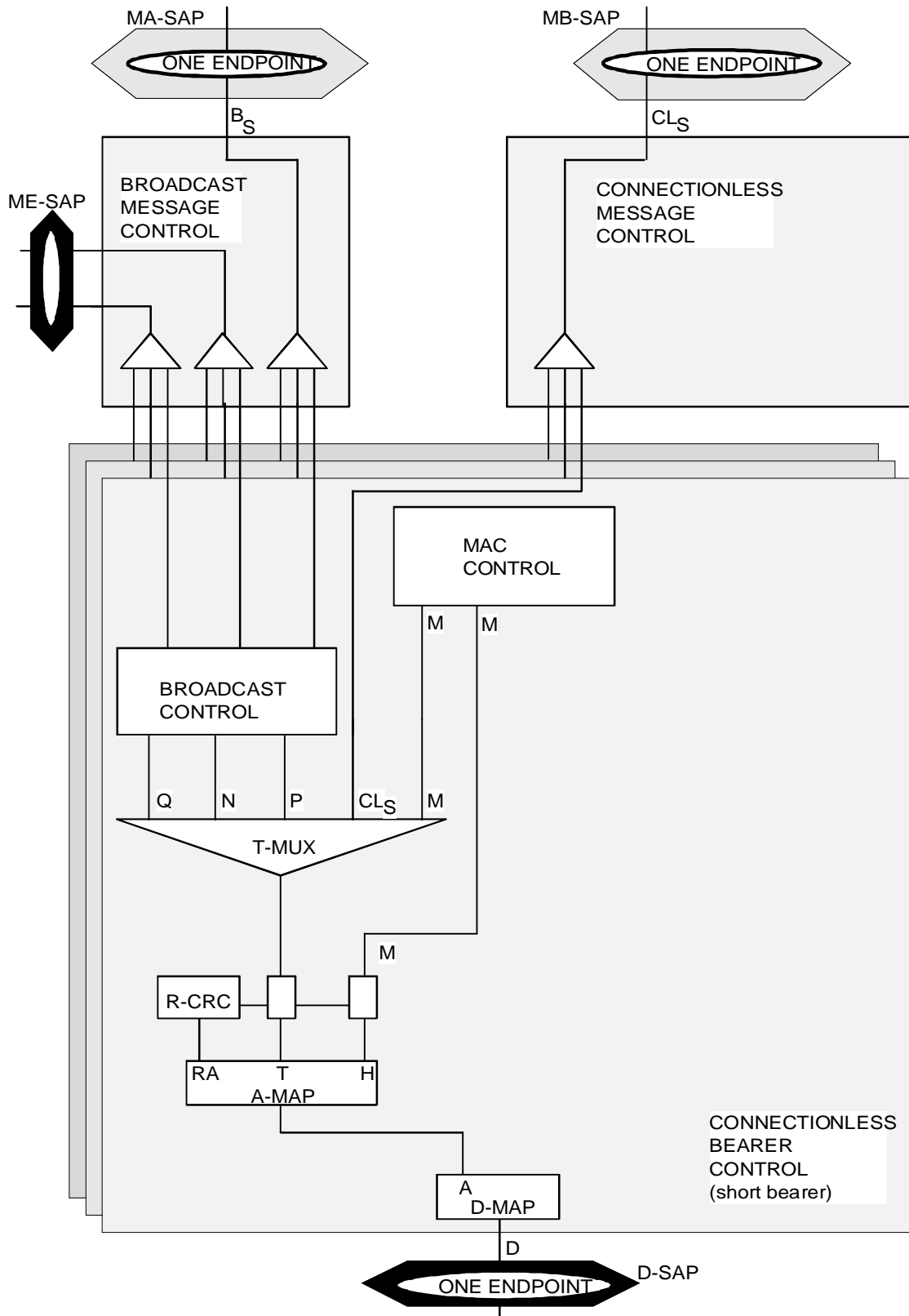

Figure 6.4: CBC multiplexing (short)

6.2.1 Bit Mappings (MAP)

All of the mappings follow fixed schemes. The A-MAP builds the A-field with the header and tail bits. The mapping rule is described in clause 6.2.1.2. The D-MAP forms the DECT D-field data burst with the A- and B-fields.

The size of the B-field depends upon the physical packet size. Ten sizes of D-field are defined, corresponding to these physical packets:

D80 field;	for double slot operation;
D32 field;	for full slot operation;
D08 field;	for half slot operation;
D00 field;	for short slot operation;
D160 field;	for double slot with 4 level modulation;
D64 field;	for full slot with 4 level modulation;
D16 field;	for half slot with 4 level modulation;
D240 field;	for double slot with 8 level modulation;
D96 field;	for full slot with 8 level modulation;
D24 field;	for half slot with 8 level modulation.

6.2.1.1 D-field Mapping (D-MAP)

All D-fields except D00 are divided into two fields:

- the A-field; and
- the B-field.

Field A contains 64 bits numbered from a_0 to a_{63} where a_0 occurs earlier than a_1 . The B-field occupies the rest of the D-field and varies in size between double slots, full slots and half slots and the various modulation levels.

In the D80 field the B-field contains 804 bits which are numbered from b_0 to b_{803} where b_0 occurs earlier than b_1 .

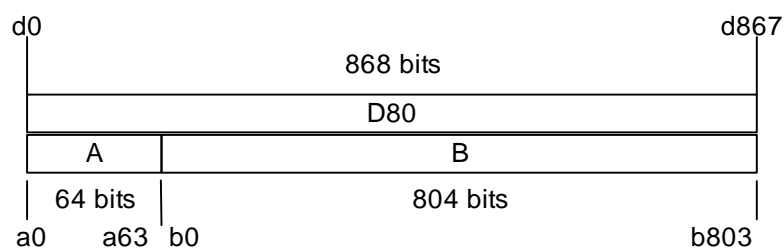

Figure 6.5: A-field and B-field in the D80 field (double slot, 2 level modulation)

In the D160 field the B-field contains $1\ 608+f$ bits which are numbered from b_0 to $b_{1\ 607+f}$ where b_0 occurs earlier than b_1 .

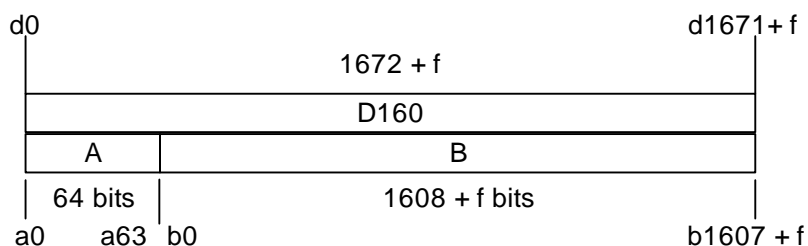

Figure 6.6: A-field and B-field in the D160 field (double slot, 4 level modulation)

In the D240 field the B-field contains 2412+f bits which are numbered from $b0$ to $b2411+f$ where $b0$ occurs earlier than $b1$.

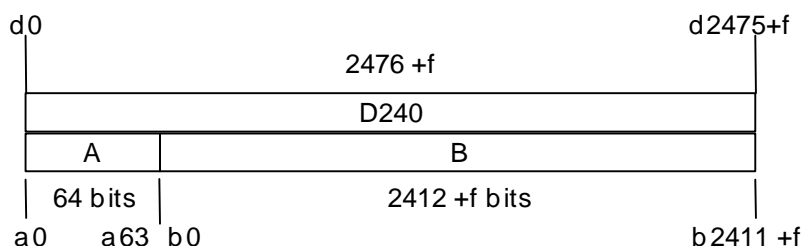

Figure 6.7: A-field and B-field in the D240 field (double slot, 8 level modulation)

In the D32 field the B-field contains 324 bits which are numbered from $b0$ to $b323$ where $b0$ occurs earlier than $b1$.

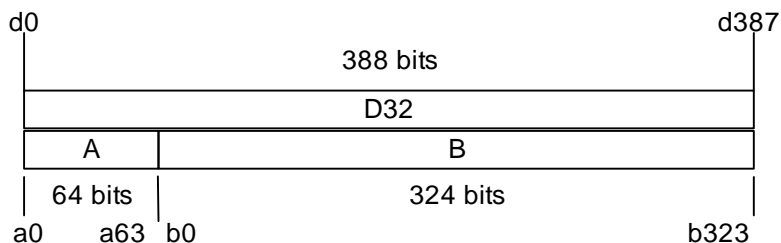

Figure 6.8: A-field and B-field in the D32 field (full slot, 2 level modulation)

In the D64 field the B-field contains 648+f bits which are numbered from $b0$ to $b647$ where $b0$ occurs earlier than $b1$.

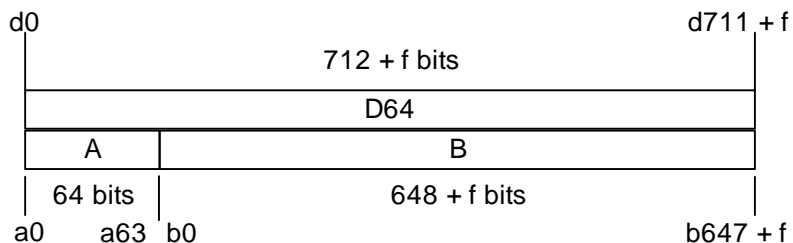

Figure 6.9: A-field and B-field in the D64 field (full slot, 4 level modulation)

In the D96 field the B-field contains 972+f bits which are numbered from $b0$ to $b971$ where $b0$ occurs earlier than $b1$.

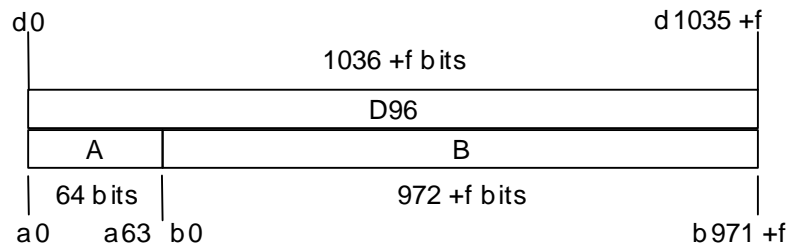

Figure 6.10: A-field and B-field in the D96 field (full slot, 8 level modulation)

In the D08 field the B-field contains $84+j$ bits which are numbered from b_0 to b_{83+j} where b_0 occurs earlier than b_1 .

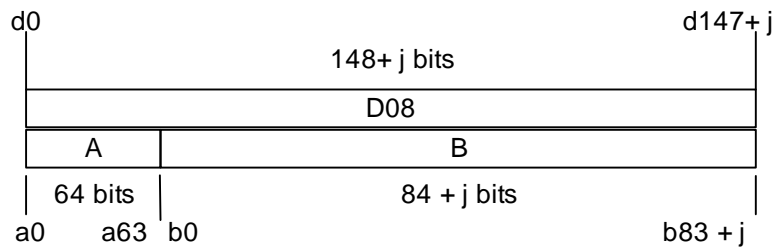

Figure 6.11: A-field and B-field in the D08 field (half slot, 2 level modulation)

In the D16 field the B-field contains $168+2j+f$ bits which are numbered from b_0 to $b_{167+2j+f}$ where b_0 occurs earlier than b_1 .

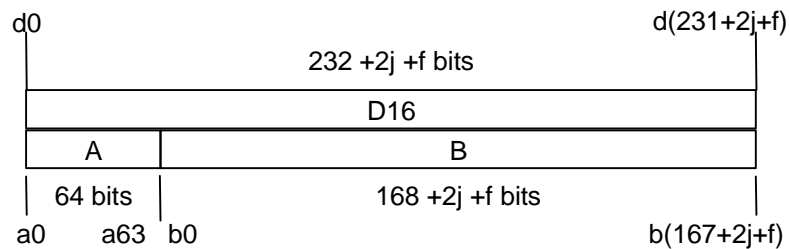

Figure 6.12: A-field and B-field in the D16 field (half slot, 4 level modulation)

In the D24 field the B-field contains $252+3j+f$ bits which are numbered from b_0 to $b_{251+3j+f}$ where b_0 occurs earlier than b_1 .

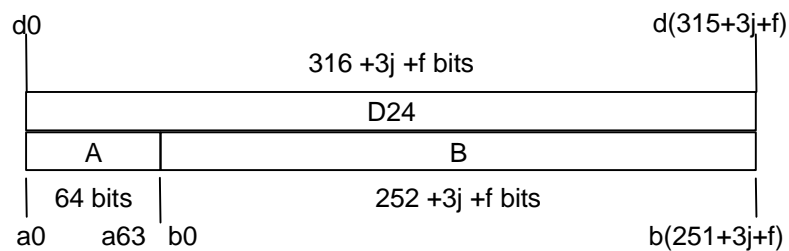

Figure 6.13: A-field and B-field in the D24 field (half slot, 8 level modulation)

NOTE 1: $f = 0$ in slots with 2 level modulation in A field, $f = 64$ in slots with 4 level modulation in A field and $f = 128$ in slots with 8 level modulation in A field.

NOTE 2: With $j = 0$ the guard space is the same for half slots as for full slots (see EN 300 175-2 [2]). The ability to set j provides flexibility for future low rate speech codec applications.

NOTE 3: j can only be selected from one of the values defined in the present document. Currently the only defined value for j is $j = 0$. Other values of j are subject to future standardization.

The default value of j for the D08, D16 and D24 field shall be 0.

The D-field D00 for short slot operation only contains the A-field. The time duration of a D00 field varies with modulation type. The duration of D00 with 4 level modulation is reduced by a factor 2, compared to the duration of D00 with 2 level modulation. The duration of D00 with 8 level modulation is reduced by a factor 3, compared to the duration of D00 with 2 level modulation.

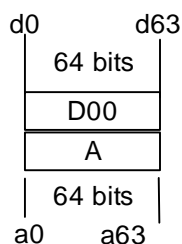

Figure 6.14: The D00 field containing the A-field

6.2.1.2 A-field Mapping (A-MAP)

The division of the A-field into Header (H), Tail (T), and Redundancy (RA) bits, is the same for all mappings and shown in figure 6.15.

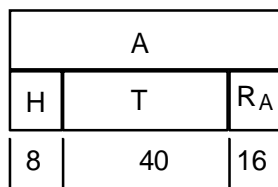

Figure 6.15: A-field mapping

The header, H, is located in bits a_0 to a_7 and contains the 8 bit MAC layer permanent control data field.

The tail, T, contains 40 bits and is located in bit positions a_8 to a_{47} .

The remaining 16 bits a_{48} to a_{63} are redundancy bits, R_A , to provide error control on all the A-field data. See clause 6.2.5.2 for the calculation of the value of these bits.

By definition the header field always contains the MAC control information.

The tail carries data from several logical channels, using the T-MUX algorithm defined in clause 6.2.2.1.

6.2.1.3 B-field Mapping (B-MAP)

For the B-field three mappings exist, a protected format with multiple subfields, a protected format with one subfield and an unprotected format. With the unprotected format the X-field at the end of the B-field contains the only redundancy bits in the B-field. The X-field contains 4 bits for 2 level modulation, 8 bits for 4 level modulation and 12 bits for 8 level modulation.

Unprotected formats: in the unprotected double slot format the mapping of the A-field and B-field onto the D240, D160 and D80-field of physical packets P240, P160 and P80 is shown in next figures and described as:

$$d_i = a_i \quad : \quad 0 \leq i \leq 63$$

$$b_{i-64} \quad : \quad 64 \leq i \leq 863$$

$$x_{i-864} \quad : \quad 864 \leq i \leq 867$$

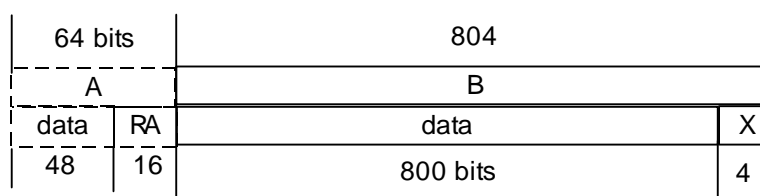

Figure 6.16: Unprotected D80 B-field format (double slot, 2 level modulation)

$$d_i = a_i \quad : \quad 0 \leq i \leq 63$$

$$b_{i-64} \quad : \quad 64 \leq i \leq 1663+f$$

$$x_{i-(1663+f)} \quad : \quad 1664+f \leq i \leq 1671+f$$

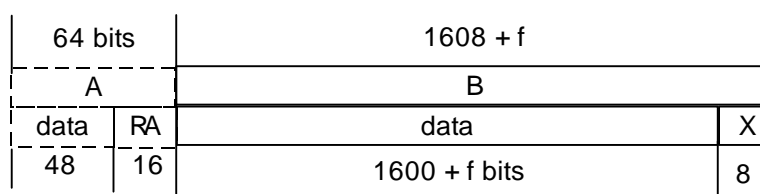

Figure 6.17: Unprotected D160 B-field format (double slot, 4 level modulation)

$$d_i = a_i \quad : \quad 0 \leq i \leq 63$$

$$b_{i-64} \quad : \quad 64 \leq i \leq 2463+f$$

$$x_{i-(2464+f)} \quad : \quad 2464+f \leq i \leq 2475+f$$

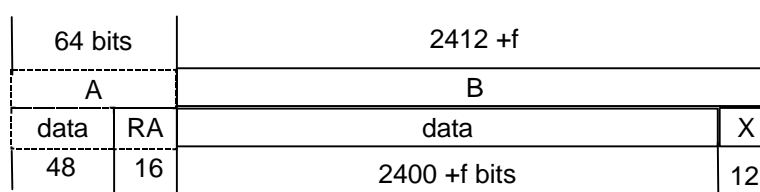

Figure 6.18: Unprotected D240 B-field format (double slot, 8 level modulation)

In the unprotected full slot format the fields A and B are mapped onto the D96, D64 and D32-field of physical packets P96, P64 and P32 as follows:

$$d_i = a_i \quad : \quad 0 \leq i \leq 63$$

$$b_i - 64 \quad : \quad 64 \leq i \leq 383$$

$$x_i - 384 \quad : \quad 384 \leq i \leq 387$$

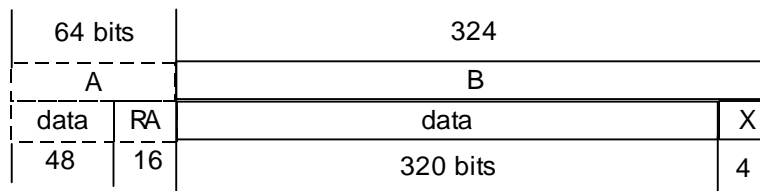

Figure 6.19: Unprotected D32 B-field format (full slot, 2 level modulation)

$$d_i = a_i \quad : \quad 0 \leq i \leq 63$$

$$b_i - 64 \quad : \quad 64 \leq i \leq 703+f$$

$$x_{i-(704+f)} \quad : \quad 704+f \leq i \leq 711+f$$

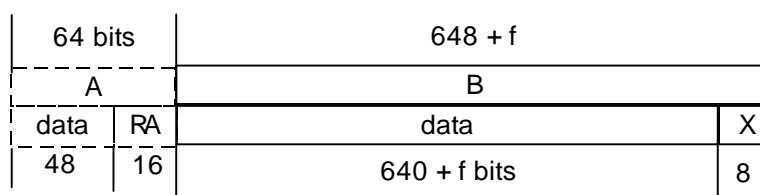

Figure 6.20: Unprotected D64 B-field format (full slot, 4 level modulation)

$$d_i = a_i \quad : \quad 0 \leq i \leq 63$$

$$b_i - 64 \quad : \quad 64 \leq i \leq 1023+f$$

$$x_i - (1024+f) \quad : \quad 1024+f \leq i \leq 1035+f$$

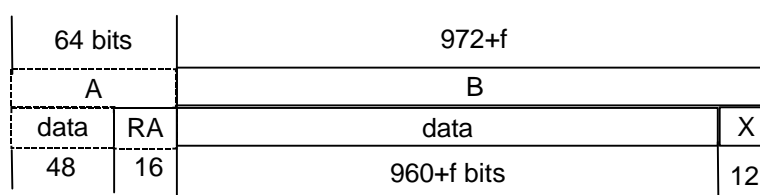

Figure 6.21: Unprotected D96-field format (full slot, 8 level modulation)

In the unprotected half slot format the mapping of the A-field and B-field onto the D24, D16 and D08-field of physical packets P24, P16 and P08 is shown in next figures and described as:

$$d_i = a_i \quad : \quad 0 \leq i \leq 63$$

$$b_i - 64+j \quad : \quad 64 \leq i \leq 143+j$$

$$x_i - 144+j \quad : \quad 144+j \leq i \leq 147+j$$

64 bits		84 + j	
A		B	
data	RA	data	X
48	16	80 + j bits	4

Figure 6.22: Unprotected D08 B-field format (half slot, 2 level modulation)

$$d_i = a_i \quad : \quad 0 \leq i \leq 63$$

$$b_i - 64 + 2j \quad : \quad 64 \leq i \leq 223 + 2j + f$$

$$x_i - (224 + 2j + f) : \quad 224 + 2j + f \leq i \leq 231 + 2j + f$$

64 bits		168 + 2j + f	
A		B	
data	RA	data	X
48	16	160 + 2j + f bits	8

Figure 6.23: Unprotected D16 B-field format (half slot, 4 level modulation)

$$d_i = a_i \quad : \quad 0 \leq i \leq 63$$

$$b_i - 64 + 3j \quad : \quad 64 \leq i \leq 303 + 3j + f$$

$$x_i - (304 + 3j + f) : \quad 304 + 3j + f \leq i \leq 315 + 3j + f$$

64 bits		252 + 3j + f	
A		B	
data	RA	data	X
48	16	240 + 3j + f bits	12

Figure 6.24: Unprotected D24 B-field format (half slot, 8 level modulation)

Multisubfield protected formats: the multisubfield protected formats divide the B-field into subfields. The last 4, 8 or 12 bits are always the X-field (last 4 bits for 2 level modulation, last 8 bits for 4 level modulation, last 12 bits for 8 level modulation). The other bits are divided into subfields of 80-bit length, where the first subfield starts with the first bit in the B-field. The subfields are numbered B0, B1, B2 etc. The last subfield before the X-field may have a smaller length than 80 bits. The bit b_{ki} from the B_k subfield corresponds to the bit $b_{(80k+i)}$ of the B-field.

All 80-bit subfields consist of a 64-bit data block followed by 16 CRC bits (RBj-fields). In all multisubfield protected formats the 80-bit subfield B0 is placed in the same relative position to the synchronization word and starts with the 65th bit of the physical channel's D-field.

With $f = 64$ and $f = 128$, one, respectively two additional 64 bits B subfields exist. The use of these fields is undefined. Keeping these fields allows the unprotected and the protected format to have the same size. Therefore, for a chosen value of f the X-field is in the same position in both formats. This allows the same X-field procedure to be used for measuring the performance of the physical channel in both protected and unprotected slot formats.

The following figures show the multisubfield protected double slot format, which is described as:

- $$d_i = a_i \quad : \quad 0 \leq i \leq 63$$
- $$b0_{i-64} \quad : \quad 64 \leq i \leq 143$$
- $$b1_{i-144} \quad : \quad 144 \leq i \leq 223$$
- $$b2_{i-224} \quad : \quad 224 \leq i \leq 303$$
- $$b3_{i-304} \quad : \quad 304 \leq i \leq 383$$
- $$b4_{i-384} \quad : \quad 384 \leq i \leq 463$$
- $$b5_{i-464} \quad : \quad 464 \leq i \leq 543$$
- $$b6_{i-544} \quad : \quad 544 \leq i \leq 623$$
- $$b7_{i-624} \quad : \quad 624 \leq i \leq 703$$
- $$b8_{i-704} \quad : \quad 704 \leq i \leq 783$$
- $$b9_{i-784} \quad : \quad 784 \leq i \leq 863$$
- $$x_{i-864} \quad : \quad 864 \leq i \leq 867$$

64				804																			
A				B																			
		B0		B1		B2		B3		B4		B5		B6		B7		B8		B9		X	
data	R	data	R	Dat	R	data	R	data	R	Dat	R	Dat	R	data	R	data	R	data	R	data	R	X	
A		B0		a	B1	B2		B3		a	B4	a	B5	B6		B7		B8		B9			
48	16	64	16	64	16	64	16	64	16	64	16	64	16	64	16	64	16	64	16	64	16	4	

Figure 6.25: Multisubfield protected B-field format D80 (double slot, 2 level modulation)

- $$d_i = a_i \quad : \quad 0 \leq i \leq 63$$
- $$b0_{i-64} \quad : \quad 64 \leq i \leq 143$$
- $$b1_{i-144} \quad : \quad 144 \leq i \leq 223$$
- $$b2_{i-224} \quad : \quad 224 \leq i \leq 303$$
- $$b3_{i-304} \quad : \quad 304 \leq i \leq 383$$
- $$b4_{i-384} \quad : \quad 384 \leq i \leq 463$$
- $$b5_{i-464} \quad : \quad 464 \leq i \leq 543$$
- $$b6_{i-544} \quad : \quad 544 \leq i \leq 623$$
- $$b7_{i-624} \quad : \quad 624 \leq i \leq 703$$
- $$b8_{i-704} \quad : \quad 704 \leq i \leq 783$$
- $$b9_{i-784} \quad : \quad 784 \leq i \leq 863$$
- $$b10_{i-864} \quad : \quad 864 \leq i \leq 943$$

- $b11_{i-944} : 944 \leq i \leq 1023$
 $b12_{i-1024} : 1024 \leq i \leq 1103$
 $b13_{i-1104} : 1104 \leq i \leq 1183$
 $b14_{i-1184} : 1184 \leq i \leq 1263$
 $b15_{i-1264} : 1264 \leq i \leq 1343$
 $b16_{i-1344} : 1344 \leq i \leq 1423$
 $b17_{i-1424} : 1424 \leq i \leq 1503$
 $b18_{i-1504} : 1504 \leq i \leq 1583$
 $b19_{i-1584} : 1584 \leq i \leq 1663$
 $(b20_{i-1664} : 1664 \leq i \leq 1663 + f; f = 64)$
 $x_{i-(1664+f)} : 1664 + f \leq i \leq 1671 + f$

64		1608 + f																			
A		B																			
		B0		B1		B2		B3		-----		-----		B17		B18		B19		B20	X
dat	R	Dat	R	Dat	R	Dat	R	dat	R	Dat	R	Dat	R	dat	R	dat	R	dat	R	—	X
a	A	a	B0	a	B1	a	B2	a	B3	a	bi	a	Bi+1	a	B17	a	B18	a	B19	—	
48	16	64	16	64	16	64	16	64	16	64	16	64	16	64	16	64	16	64	16	f	8

Figure 6.26: Multisubfield protected B-field format D160 (double slot, 4 level modulation)

- $d_i = a_i : 0 \leq i \leq 63$
 $b0_{i-64} : 64 \leq i \leq 143$
 $b1_{i-144} : 144 \leq i \leq 223$
 $b2_{i-224} : 224 \leq i \leq 303$
 $b3_{i-304} : 304 \leq i \leq 383$
 $b4_{i-384} : 384 \leq i \leq 463$
 $b5_{i-464} : 464 \leq i \leq 543$
 $b6_{i-544} : 544 \leq i \leq 623$
 $b7_{i-624} : 624 \leq i \leq 703$
 $b8_{i-704} : 704 \leq i \leq 783$
 $b9_{i-784} : 784 \leq i \leq 863$

- $b10_{i-864} : 864 \leq i \leq 943$
 $b11_{i-944} : 944 \leq i \leq 1023$
 $b12_{i-1024} : 1024 \leq i \leq 1103$
 $b13_{i-1104} : 1104 \leq i \leq 1183$
 $b14_{i-1184} : 1184 \leq i \leq 1263$
 $b15_{i-1264} : 1264 \leq i \leq 1343$
 $b16_{i-1344} : 1344 \leq i \leq 1423$
 $b17_{i-1424} : 1424 \leq i \leq 1453$
 $b18_{i-1504} : 1504 \leq i \leq 1583$
 $b19_{i-1584} : 1584 \leq i \leq 1663$
 $b20_{i-1664} : 1664 \leq i \leq 1743$
 $b21_{i-1744} : 1744 \leq i \leq 1823$
 $b22_{i-1824} : 1824 \leq i \leq 1903$
 $b23_{i-1904} : 1904 \leq i \leq 1983$
 $b24_{i-1984} : 1984 \leq i \leq 2063$
 $b25_{i-2064} : 2064 \leq i \leq 2143$
 $b26_{i-2144} : 2144 \leq i \leq 2223$
 $b27_{i-2224} : 2224 \leq i \leq 2303$
 $b28_{i-2304} : 2304 \leq i \leq 2383$
 $b29_{i-2384} : 2384 \leq i \leq 2463$
 $(b30_{i-2464} : 2464 \leq i \leq 2463 + f ; f = 128)$
 $x_{i(2464+f)} : 2464 + f \leq i \leq 2475 + f$

64		2412 + f																					
A		B																					
		B0		B1		B2		B3		-----		-----		B27		B28		B29		B30		X	
data	RA	Dat	RB	Dat	RB	data	RB	data	RB	Dat	RB	Dat	RB	data	RB	Dat	RB	data	RB	_____	_____	X	
		a	0	a	1		2		3	a	i	a	i+1		27	a	28		29				
48	16	64	16	64	16	64	16	64	16	64	16	64	16	64	16	64	16	64	16	64	16	F	12

Figure 6.27: Multisubfield protected B-field format D240 (double slot, 8 level modulation)

For the multisubfield protected full slot format a more detailed mapping is shown in next figures and described as follows:

$$d_i = a_i \quad : \quad 0 \leq i \leq 63$$

$$b0_{i-64} \quad : \quad 64 \leq i \leq 143$$

$$b1_{i-144} \quad : \quad 144 \leq i \leq 223$$

$$b2_{i-224} \quad : \quad 224 \leq i \leq 303$$

$$b3_{i-304} \quad : \quad 304 \leq i \leq 383$$

$$x_{i-384} \quad : \quad 384 \leq i \leq 387$$

64		324									
A		B									
		B0		B1		B2		B3		X	
Dat	RA	data	RB	data	RB	Dat	RB	Dat	RB	X	
a			0		1	a	2	a	3		
48	16	64	16	64	16	64	16	64	16	4	

Figure 6.28: Multisubfield protected B-field format D32 (full slot, 2 level modulation)

$$d_i = a_i \quad : \quad 0 \leq i \leq 63$$

$$b0_{i-64} \quad : \quad 64 \leq i \leq 143$$

$$b1_{i-144} \quad : \quad 144 \leq i \leq 223$$

$$b2_{i-224} \quad : \quad 224 \leq i \leq 303$$

$$b3_{i-304} \quad : \quad 304 \leq i \leq 383$$

$$b4_{i-384} \quad : \quad 384 \leq i \leq 463$$

$$b5_{i-464} \quad : \quad 464 \leq i \leq 543$$

$$b6_{i-544} \quad : \quad 544 \leq i \leq 623$$

$$b7_{i-624} \quad : \quad 624 \leq i \leq 703$$

$$(b8_{i-704} \quad : \quad 704 \leq i \leq 703 + f : f = 64)$$

$$x_{i(704+f)} \quad : \quad 704 + f \leq i \leq 711 + f$$

64		648 +f																		
A		B																		
		B0		B1		B2		B3		B4		B5		B6		B7		B8		X
dat	R	Dat	R	Dat	R	Dat	R	dat	R	Dat	R	dat	R	Dat	R	dat	R	—	—	X
a	A	a	B	a	B	a	B	a	B	a	B	a	B	a	B	a	B	—	—	
48	1	64	1	64	1	64	1	64	1	64	1	64	1	64	1	64	1	f	8	
	6		6		6		6		6		6		6		6		6			

Figure 6.29: Multisubfield protected B-field format D64 (full slot, 4 level modulation)

- $d_i = a_i : 0 \leq i \leq 63$
 $b0_{i-64} : 64 \leq i \leq 143$
 $b1_{i-144} : 144 \leq i \leq 223$
 $b2_{i-224} : 224 \leq i \leq 303$
 $b3_{i-304} : 304 \leq i \leq 383$
 $b4_{i-384} : 384 \leq i \leq 463$
 $b5_{i-464} : 464 \leq i \leq 543$
 $b6_{i-544} : 544 \leq i \leq 623$
 $b7_{i-624} : 624 \leq i \leq 703$
 $b8_{i-704} : 704 \leq i \leq 783$
 $b9_{i-784} : 784 \leq i \leq 863$
 $b10_{i-864} : 864 \leq i \leq 943$
 $b11_{i-944} : 944 \leq i \leq 1023$
 $(b_{12i-1024} : 1024 \leq i \leq 1023 + f : f = 128)$
 $x_{i(1024+f)} : 1024 + f \leq i \leq 1035 + f$

64		972 +f																	
A		B																	
		B0		B1		B2		B3		---		---		B10		B11		B12	X
dat	R	Dat	R	Dat	R	Dat	R	dat	R	Dat	R	dat	R	Dat	R	dat	R	—	X
a	A	a	B0	a	B1	a	B2	a	B3	a	B	a	B	a	B10	a	B11	—	
48	16	64	16	64	16	64	16	64	16	64	16	64	16	64	16	64	16	F	12

Figure 6.30: Multisubfield protected B-field format D128 (full slot, 8level modulation)

With a B-field length of $84+j$ or $168+f + 2j$ bits in half slot mode 2- and 4-level modulation, a subfield B1 only exists for $j > 0$. The use of this field in the protected half slot format is undefined. Keeping this field allows the unprotected and the protected format to have the same size. Therefore, for a chosen j the X-field is in the same position in both formats. This allows the same X-field procedure to be used for measuring the performance of the physical channel in both protected and unprotected half slot formats.

Next figures show the multisubfield protected half slot format, which is described as:

$$d_i = a_i \quad : \quad 0 \leq i \leq 63$$

$$b0_{i-64} \quad : \quad 64 \leq i \leq 143$$

$$(b1_{i-144} \quad : \quad 144 \leq i \leq 143 + j; j > 0)$$

$$xi(144+j) : \quad 144 + j \leq i \leq 147 + j$$

64		84 + j			
A		B			
		B0		B1	X
Dat	R	dat	R	—	X
a	A	a	B	—	
		0			
48	16	64	16	j	4

Figure 6.31: Multisubfield protected B-field format D08 (half slot, 2 level modulation)

$$d_i = a_i \quad : \quad 0 \leq i \leq 63$$

$$b0_{i-64} \quad : \quad 64 \leq i \leq 143$$

$$b1_{i-144} \quad : \quad 144 \leq i \leq 223$$

$$(b2_{i-224} \quad : \quad 224 \leq i \leq 287 + f; f = 64)$$

$$(b3_{i-288-f} \quad : \quad 288+f \leq i \leq 287 + f+2j; j>0)$$

$$xi - (288+f+2j) : \quad 288+f+2j \leq i \leq 295 + f+2j$$

64		232 + f + 2j						
A		B						
		B0		B1		B2	B3	X
Dat	R	dat	R	Dat	R	—	—	X
a	A	a	B	a	B	—	—	
		0		1				
48	16	64	16	64	16	f	2j	8

Figure 6.32: Multisubfield protected B-field format D16 (half slot, 4 level modulation)

$$d_i = a_i \quad : \quad 0 \leq i \leq 63$$

$$b0_{i-64} \quad : \quad 64 \leq i \leq 143$$

$$b1_{i-144} \quad : \quad 144 \leq i \leq 223$$

$$b2_{i-224} \quad : \quad 224 \leq i \leq 303$$

$$(b3_{i-304} \quad : \quad 304 \leq i \leq 303 + f; f = 128)$$

$$(b4_{i-(304+f)} \quad : \quad 304+f \leq i \leq 303 + f + 3j; j > 0)$$

$$x_{i-(304+f+3j)} \quad : \quad 304+f+3j + f \leq i \leq 315 + f + 3j$$

64		252 + f + 3j								
A		B								
		B0		B1		B2		B3	B4	X
data	RA	Data	RB0	Data	RB1	Data	RB2	_____	_____	X
48	16	64	16	64	16	64	16	f	3j	12

Figure 6.33: Multisubfield protected B-field format D24 (half slot, 8 level modulation)

Singlesubfield protected formats: The singlesubfield protected formats use the B-field for one subfield numbered B0. This single subfield consists of one data block of various lengths depending on the modulation type and slot format used. This single subfield is protected by one CRC field RB0. This single CRC field consists of 16 bits for 2 level modulation in full slot format and 32 bit for 4 and 8 level modulation and 2 level modulation in double slot format.

The last 4, 8 or 12 bits of the B field are always the X-field (last 4 bits for 2 level modulation, last 8 bits for 4 level modulation, last 12 bits for 8 level modulation).

The following figures show the singlesubfield protected double slot format, which is described as:

$$d_i = a_i \quad : \quad 0 \leq i \leq 63$$

$$b0_{i-64} \quad : \quad 64 \leq i \leq 863$$

$$x_{i-864} \quad : \quad 864 \leq i \leq 867$$

64		804							
A		B							
		B0							X
Data	RA	data					RB0	X	
48	16	768					32	4	

Figure 6.34: Singlesubfield protected B-field format D80 (double slot, 2 level modulation)

$$d_i = a_i \quad : \quad 0 \leq i \leq 63$$

$$b_i - 64 \quad : \quad 64 \leq i \leq 1663+f$$

$$x_i - (1664+f) \quad : \quad 1664+f \leq i \leq 1671+f$$

64		1608 + f			
A		B			
		B0			X
Data	RA	Data		RB0	X
48	16	1568 + f		32	8

Figure 6.35: Singlesubfield protected B-field format D160 (double slot, 4 level modulation)

$$d_i = a_i : 0 \leq i \leq 63$$

$$b_i - 64 : 64 \leq i \leq 2463+f$$

$$x_i - (2464+f): 2464+f \leq i \leq 2475+f$$

64		2412 + f			
A		B			
		B0			X
Data	RA	data		RB0	X
48	16	2368 + f		32	12

Figure 6.36: Singlesubfield protected B-field format D240 (double slot, 8 level modulation)

For the singlesubfield protected full slot format a more detailed mapping is shown in next figures and described as follows: (NOTE that D32 is the only format with 16 bit CRC RB0).

$$d_i = a_i : 0 \leq i \leq 63$$

$$b_i - 64 : 64 \leq i \leq 383$$

$$x_i - 384 : 384 \leq i \leq 387$$

64		324			
A		B			
		B0			X
Data	RA	Data		RB0	X
48	16	304		16	4

Figure 6.37: Singlesubfield protected B-field format D32 (full slot, 2 level modulation)

$$d_i = a_i : 0 \leq i \leq 63$$

$$b_i - 64 : 64 \leq i \leq 703+f$$

$$x_i - (704+f): 704+f \leq i \leq 711+f$$

64		648 + f			
A		B			
		B0			X
Data	RA	Data		RB0	X
48	16	608 + f		32	8

Figure 6.38: Singlesubfield protected B-field format D64 (full slot, 4 level modulation)

$d_i = a_i$: $0 \leq i \leq 63$
 $b_i - 64$: $64 \leq i \leq 1023+f$
 $x_i - (1024+f)$: $1024+f \leq i \leq 1035+f$

64		972 + f		
A		B		
		B0		X
Data	RA	Data	RB0	X
48	16	928 + f	32	12

Figure 6.39: Singlesubfield protected B-field format D128 (full slot, 8 level modulation)

The B-field format is controlled by the E/U MUX. This is described in clause 6.2.2.2.

In the unprotected format, the single data field must only carry data from the I_N or SI_N logical channels.

The singlesubfield protected format must only carry data from the I_p logical channels.

In the multisubfield protected format, the data fields may carry data from different logical channels. The contents are defined by the E/U MUX (clause 6.2.2.2) and the C-MUX (clause 6.2.2.3).

Any operation of the E/U MUX shall not alter the value of j for half slot operation. The value of j and f shall be agreed at connection set up and shall not be changed during the connection unless an appropriate MAC_MOD primitive is received.

6.2.2 Time multiplexers

A T-MUX (tail-multiplex) changes the tail T , which can be one of the tail types, P_T , Q_T , N_T , C_T and M_T . A E/U-MUX selects between E-type and U-type. The C-MUX controls the mode of the B-field, distributing the flow of MAC control information, M , G_F , C_F , and CL_F data into the B-field.

T-MUX algorithms are different for RFPs and PTs because PTs do not transmit P and Q-channels. C-MUX and E/U-MUX algorithms are the same for both equipments.

6.2.2.1 Tail MULTipleXer (T-MUX)

The tail, T , contains 40 bits. The logical channels carried in the tail depend upon the tail type. This is detailed in table 6.1.

Table 6.1: T-MUX

C_T	one C_S or CL_S -channel segment
M_T	one M-channel message
N_T	one N-channel message
P_T	one P-channel message (see clause 7.2.4 and clause 9.1.3)
Q_T	one Q-channel message
NOTE:	These tail types are multiplexed on a frame-by-frame basis.

6.2.2.1.1 T-MUX algorithm for RFP transmissions

The DECT RFPs support a multiframe structure of 16 frames duration. Both frame and multiframe timing shall be synchronized for all RFPs of one DECT FP.

The 16 frames in one multiframe are numbered from frame 0 to frame 15. Once every multiframe, a special tail identification is sent in the header, H, to mark frame number 8 of the multiframe.

In all odd frames the tail contains either M_T , C_T or N_T . The applied " M_T , C_T , N_T " priority scheme means:

- M_T type tails have priority over;
- C_T type tails which have priority over the;
- N_T type tails.

In frames {0,2,4,6,10,12} a " P_T , N_T " priority scheme is used:

- P_T type tails have priority over the N_T type tails.

The tail of frame 14 is reserved for N_T (" N_T " priority scheme) and the tail of frame 8 is reserved for Q_T information (" Q_T " scheme).

The resulting algorithm is given in table 6.2.

Table 6.2: T-MUX algorithm

Frame	Priority scheme	Frame	Priority scheme
0	P_T , N_T	1	M_T , C_T , N_T
2	P_T , N_T	3	M_T , C_T , N_T
4	P_T , N_T	5	M_T , C_T , N_T
6	P_T , N_T	7	M_T , C_T , N_T
8	Q_T	9	M_T , C_T , N_T
10	P_T , N_T	11	M_T , C_T , N_T
12	P_T , N_T	13	M_T , C_T , N_T
14	N_T	15	M_T , C_T , N_T

Exceptions: When responding to a "bearer request" message or during bearer release, the F_T may insert an M_T tail in an even numbered frame.

The following throughput capacities are achieved:

(fpmf = frames per multiframe):

C_T : higher layer control	0 - 2 kbit/s	0 - 8 fpmf;
M_T : MAC layer control	0 - 2 kbit/s	0 - 8 fpmf;
N_T : identities information	0,25 - 3,75 kbit/s	1 - 15 fpmf;
lower limit, excluding exceptions as above	0,25 kbit/s	1 fpmf;
P_T : paging	0 - 1,5 kbit/s	0 - 6 fpmf;
Q_T : system information, excluding exceptions as above	0,25 kbit/s	1 fpmf.

Reply to a request for a BMC service (non continuous broadcast) always starts with an M_T message (see clause 7.2.5.6) which may be placed in any frame. For reply to a request for a BMC service a second transmission may occur in the next TDMA frame. This second transmission uses an M_T tail.

6.2.2.1.2 T-MUX algorithm for PT transmissions

The algorithm shown in table 6.3 is used by PTs for all traffic bearers in connection oriented services:

Table 6.3: T-MUX algorithm for PT transmissions

Frame	Priority scheme	Frame	Priority scheme
0	M_T, C_T, N_T	1	N_T
2	M_T, C_T, N_T	3	N_T
4	M_T, C_T, N_T	5	N_T
6	M_T, C_T, N_T	7	N_T
8	M_T, C_T, N_T	9	N_T
10	M_T, C_T, N_T	11	N_T
12	M_T, C_T, N_T	13	N_T
14	M_T, C_T, N_T	15	N_T

Exceptions: The transmission of a "bearer request" or a "bearer release" from a PT uses an M_T tail and this may be placed in any frame (see clauses 10.5 and 10.7).

The following throughput capacities are achieved (fpmf = frames per multi-frame):

C_T : higher layer control	0 - 2 kbit/s	0 - 8 fpmf;
M_T : MAC layer control	0 - 2 kbit/s	0 - 8 fpmf;
N_T : identities information	2 - 4 kbit/s	8 - 16 fpmf;
lower limit, excluding exceptions as above	2 kbit/s	8 fpmf.

Connectionless uplink services and requests for a BMC service (non continuous broadcast) always start with a M_T message in the first P_T transmission (see clause 7.2.5.6) which may be placed in any frame. For connectionless uplink services and requests for a BMC service a second transmission may occur in the next TDMA frame. This second transmission uses a C_T tail when a CL_S segment is carried and a M_T tail otherwise.

6.2.2.2 B-field control multiplexer (E/U-MUX)

The E/U MUX switches the B-field between two types of multiplex, the E-type and the U-type.

1) E-type:

- for traffic bearers the B-field is used to carry M-channel data and/or C_F -channel data and/or G_F -channel data. For connectionless bearers the B-field is used to carry M-channel data and/or CL_F -channel data.

2) U-type:

- the B-field is used to carry either I_N -channel data or I_P -channel data, or SI_N or SI_P -channel data.

The E/U MUX operates on a frame-by-frame basis in response to immediate traffic demands. The chosen multiplex for each frame is indicated with the BA bits in the A-field header. E-type multiplex has priority over U-type multiplex.

The B-field multiplexes are defined in tables 6.4 to 6.6.

Table 6.4: B-field multiplexes (2-level)

B-field multiplex for 2 level modulation			E/U	B-field format	Logical channel
D80-field	D32-field	D08-field			
E80	E32		E	Multisubfield Protected	C-MUX
U80a	U32a	U08a	U	Unprotected	I_N or SIN
U80b	U32b	U08b	U	Multisubfield Protected	I_P or SIP
U80c	U32c		U	Singlesubfield Protected	I_p

Table 6.5: B-field multiplexes (4-level)

B-field multiplex for 4 level modulation			E/U	B-field format	Logical channel
D160-field	D64-field	D16-field			
E160	E64		E	Multisubfield Protected	C-MUX
U160a	U64a	U16a	U	Unprotected	I_N or SIN
U160b	U64b	U16b	U	Multisubfield Protected	I_P or SIP
U160c	U64c		U	Singlesubfield Protected	I_p

Table 6.6: B-field multiplexes (8-level)

B-field multiplex for 8 level modulation			E/U	B-field Format	Logical Channel
D240-field	D96-field	D24-field			
E240	E96		E	Multisubfield Protected	C-MUX
U240a	U96a	U24a	U	Unprotected	I_N or SIN
U240b	U96b	U24b	U	Multisubfield Protected	I_P or SIP
U240c	U96c		U	Singlesubfield Protected	I_p

The E-type multiplex always uses the multisubfield protected B-field format. The possible modes of the E-type multiplex are defined by the C-MUX (see clause 6.2.2.3).

The U-type multiplex in connection oriented services may use either a protected B-field format or the unprotected B-field format. This choice is defined at connection establishment for all bearers belonging to that connection, and it corresponds to the logical channel required for the chosen service, I_N or I_P . The chosen format is maintained until it is re-negotiated or the connection ends.

6.2.2.3 B-field mode multiplexer (C-MUX)

6.2.2.3.1 Double slot full slot, D16 and D24 half slot modes

For double slot and full slot mode and half slot mode in case of 4/8 level modulation all B-subfields are used for control. The following types of information have to be multiplexed:

- higher layer control from the C_F or CL_F logical channel;
- MAC layer connection related signalling;
- higher layer information from the G_F logical channel; and
- MAC layer control to describe the contents of the subfields.

All extended MAC control and GF segments carried in the B-subfields have a header with a bit indicating if the next subfield in the same databurst contains an extended MAC control or G_F segment, or whether it contains higher layer control.

For D80 double slot operation (2 level modulation) the modes are given in the following table.

Table 6.7: D80 double slot 2-level modes

Subfield	B0	B1	B2	B3	B4	B5	B6	B7	B8	B9
Mode 0	C/O	C_F	C_F	C_F	C_F	C_F	C_F	C_F	C_F	C_F
	C/L	CL_F	CL_F	CL_F	CL_F	CL_F	CL_F	CL_F	CL_F	CL_F
Mode 1	C/O	M/M+ G_F	C_F	C_F	C_F	C_F	C_F	C_F	C_F	C_F
	C/L	M	CL_F	CL_F	CL_F	CL_F	CL_F	CL_F	CL_F	CL_F
Mode 2	C/O	M/M+ G_F	M/M+ G_F	C_F	C_F	C_F	C_F	C_F	C_F	C_F
	C/L	M	M	CL_F	CL_F	CL_F	CL_F	CL_F	CL_F	CL_F
Mode 3	C/O	M/M+ G_F	M/M+ G_F	M/M+ G_F	C_F	C_F	C_F	C_F	C_F	C_F
	C/L	M	M	M	CL_F	CL_F	CL_F	CL_F	CL_F	CL_F
Mode 4	C/O	M/M+ G_F	M/M+ G_F	M/M+ G_F	M/M+ G_F	C_F	C_F	C_F	C_F	C_F
	C/L	M	M	M	M	CL_F	CL_F	CL_F	CL_F	CL_F
Mode 5	C/O	M/M+ G_F	M/M+ G_F	M/M+ G_F	M/M+ G_F	M/M+ G_F	C_F	C_F	C_F	C_F
	C/L	M	M	M	M	M	CL_F	CL_F	CL_F	CL_F
Mode 6	C/O	M/M+ G_F	M/M+ G_F	M/M+ G_F	M/M+ G_F	M/M+ G_F	M/M+ G_F	C_F	C_F	C_F
	C/L	M	M	M	M	M	M	CL_F	CL_F	CL_F
Mode 7	C/O	M/M+ G_F	M/M+ G_F	M/M+ G_F	M/M+ G_F	M/M+ G_F	M/M+ G_F	M/M+ G_F	C_F	C_F
	C/L	M	M	M	M	M	M	M	CL_F	CL_F
Mode 8	C/O	M/M+ G_F	M/M+ G_F	M/M+ G_F	M/M+ G_F	M/M+ G_F	M/M+ G_F	M/M+ G_F	M/M+ G_F	C_F
	C/L	M	M	M	M	M	M	M	M	CL_F
Mode 9	C/O	M/M+ G_F	M/M+ G_F	M/M+ G_F	M/M+ G_F	M/M+ G_F	M/M+ G_F	M/M+ G_F	M/M+ G_F	M/M+ G_F
	C/L	M	M	M	M	M	M	M	M	M
Mode 10	C/O	M/M+ G_F	M/M+ G_F	M/M+ G_F	M/M+ G_F	M/M+ G_F	M/M+ G_F	M/M+ G_F	M/M+ G_F	M/M+ G_F
	C/L	M	M	M	M	M	M	M	M	M

For double slot operation the A-field header coding (BA bits) shall distinguish between:

- E-type, mode 0;
- E-type, modes 1 - 9; and
- E-type, mode 10.

For D160 double slot operation (4 level modulation) the modes are given in the following table:

Table 6.8: D160 double slot 4-level modes

Subfield		B0	B1	i-1	i	i+1	...	B17	B18	B19
Mode 0	C/O	C _F	C _F	C _F	C _F	C _F	C _F	C _F	C _F
	C/L	CL _F	CL _F		CL _F	CL _F	CL _F		CL _F	CL _F	CL _F
Mode 1	C/O	M/M+G _F	C _F	C _F	C _F	C _F	C _F	C _F	C _F
	C/L	M	CL _F		CL _F	CL _F	CL _F		CL _F	CL _F	CL _F
.....	C/O
	C/L										
Mode i	C/O	M/M+G _F	M/M+G _F	M/M+G _F	C _F	C _F	C _F	C _F	C _F
	C/L	M	M		M	CL _F	CL _F		CL _F	CL _F	CL _F
Mode i+1	C/O	M/M+G _F	M/M+G _F	M/M+G _F	M/M+G _F	C _F	C _F	C _F	C _F
	C/L	M	M		M	M	CL _F		CL _F	CL _F	CL _F
....	C/O
	C/L										
Mode 19	C/O	M/M+G _F	M/M+G _F	M/M+G _F	M/M+G _F	M/M+G _F	M/M+G _F	M/M+G _F	C _F
	C/L	M	M		M	M	M		M	M	CL _F
Mode 20	C/O	M/M+G _F	M/M+G _F	M/M+G _F	M/M+G _F	M/M+G _F	M/M+G _F	M/M+G _F	M/M+G _F
	C/L	M	M		M	M	M		M	M	M

For D160 double slot operation the A-field header coding (BA bits) shall distinguish between:

- E-type, mode 0;
- E-type, modes 1 - 19; and
- E-type, mode 20.

For D240 double slot operation (8 level modulation) the modes are given in next table:

Table 6.9: D240 double slot 8-level modes

Subfield		B0	B1	...	i-1	i	i+1	...	B27	B28	B29
Mode 0	C/O	C _F	C _F	...	C _F	C _F	C _F	...	C _F	C _F	C _F
	C/L	CL _F	CL _F	...	CL _F	CL _F	CL _F	...	CL _F	CL _F	CL _F
Mode 1	C/O	M/M+G _F	C _F	...	C _F	C _F	C _F	...	C _F	C _F	C _F
	C/L	M	CL _F	...	CL _F	CL _F	CL _F	...	CL _F	CL _F	CL _F
.....	C/O
	C/L
Mode i	C/O	M/M+G _F	M/M+G _F	...	M/M+G _F	C _F	C _F	...	C _F	C _F	C _F
	C/L	M	M	...	M	CL _F	CL _F	...	CL _F	CL _F	CL _F
Mode i+1	C/O	M/M+G _F	M/M+G _F	...	M/M+G _F	M/M+G _F	C _F	...	C _F	C _F	C _F
	C/L	M	M	...	M	M	CL _F	...	CL _F	CL _F	CL _F
....	C/O
	C/L
Mode 29	C/O	M/M+G _F	M/M+G _F	...	M/M+G _F	M/M+G _F	M/M+G _F	...	M/M+G _F	M/M+G _F	C _F
	C/L	M	M	...	M	M	M	...	M	M	CL _F
Mode 30	C/O	M/M+G _F	M/M+G _F	...	M/M+G _F	M/M+G _F	M/M+G _F	...	M/M+G _F	M/M+G _F	M/M+G _F
	C/L	M	M	...	M	M	M	...	M	M	M

For D240 double slot operation the A-field header coding (BA bits) shall distinguish between:

- E-type, mode 0;
- E-type, modes 1 - 29; and
- E-type, mode 30.

For D32 full slot operation (2 level modulation) the modes given in the following table are allowed.

Table 6.10: D32 full slot 2-level modes

Subfield		B0	B1	B2	B3
Mode 0	C/O	C _F	C _F	C _F	C _F
	C/L	CL _F	CL _F	CL _F	CL _F
Mode 1	C/O	M/M+G _F	C _F	C _F	C _F
	C/L	M	CL _F	CL _F	CL _F
Mode 2	C/O	M/M+G _F	M/M+G _F	C _F	C _F
	C/L	M	M	CL _F	CL _F
Mode 3	C/O	M/M+G _F	M/M+G _F	M/M+G _F	C _F
	C/L	M	M	M	CL _F
Mode 4	C/O	M/M+G _F	M/M+G _F	M/M+G _F	M/M+G _F
	C/L	M	M	M	M

For D32 full slot operation the A-field header coding (BA bits) will distinguish between:

- E-type, mode 0;
- E-type, modes 1 - 3; and
- E-type, mode 4.

For D64 full slot operation (4 level modulation) the modes given in next table are allowed:

Table 6.11: D64 full slot 4-level modes

Subfield	B0	B1	B2	B3	B4	B5	B6	B7
Mode 0	C/O	C _F	C _F	C _F	C _F	C _F	C _F	C _F
	C/L	CL _F	CL _F	CL _F	CL _F	CL _F	CL _F	CL _F
Mode 1	C/O	M/M+G F	C _F	C _F	C _F	C _F	C _F	C _F
	C/L	M	CL _F	CL _F	CL _F	CL _F	CL _F	CL _F
Mode 2	C/O	M/M+G F	M/M+G F	C _F	C _F	C _F	C _F	C _F
	C/L	M	M	CL _F	CL _F	CL _F	CL _F	CL _F
Mode 3	C/O	M/M+G F	M/M+G F	M/M+G F	C _F	C _F	C _F	C _F
	C/L	M	M	M	CL _F	CL _F	CL _F	CL _F
Mode 4	C/O	M/M+G F	M/M+G F	M/M+G F	M/M+G F	C _F	C _F	C _F
	C/L	M	M	M	M	CL _F	CL _F	CL _F
Mode 5	C/O	M/M+G F	M/M+G F	M/M+G F	M/M+G F	M/M+G F	C _F	C _F
	C/L	M	M	M	M	M	CL _F	CL _F
Mode 6	C/O	M/M+G F	M/M+G F	M/M+G F	M/M+G F	M/M+G F	M/M+G F	C _F
	C/L	M	M	M	M	M	M	CL _F
Mode 7	C/O	M/M+G F	M/M+G F	M/M+G F	M/M+G F	M/M+G F	M/M+G F	M/M+G F
	C/L	M	M	M	M	M	M	M
Mode 8	C/O	M/M+G F	M/M+G F	M/M+G F	M/M+G F	M/M+G F	M/M+G F	M/M+G F
	C/L	M	M	M	M	M	M	M

For D64 full slot operation the A-field header coding (BA bits) will distinguish between:

- E-type, mode 0;
- E-type, modes 1 - 7; and
- E-type, mode 8.

For D96 full slot operation (8 level modulation) the modes are given in next table:

Table 6.12: D96 full slot 8-level modes

Subfield	B0	B1	...	i-1	I	i+1	...	B09	B10	B11	
Mode 0	C/O	C _F	C _F	C _F	C _F	C _F	C _F	C _F	C _F
	C/L	CL _F	CL _F	CL _F	CL _F	CL _F	CL _F	CL _F	CL _F
Mode 1	C/O	M/M+G F	C _F	C _F	C _F	C _F	C _F	C _F	C _F
	C/L	M	CL _F	CL _F	CL _F	CL _F	CL _F	CL _F	CL _F
.....	C/O	
	C/L	
Mode i	C/O	M/M+G F	M/M+G F	M/M+G F	C _F	C _F	C _F	C _F	C _F
	C/L	M	M	M	CL _F	CL _F	CL _F	CL _F	CL _F
Mode i+1	C/O	M/M+G F	M/M+G F	M/M+G F	M/M+G F	C _F	C _F	C _F	C _F
	C/L	M	M	M	M	CL _F	CL _F	CL _F	CL _F
....	C/O	
	C/L	
Mode 11	C/O	M/M+G F	M/M+G F	M/M+G F	M/M+G F	M/M+G F	M/M+G F	M/M+G F	C _F
	C/L	M	M	M	M	M	M	M	CL _F
Mode 12	C/O	M/M+G F	M/M+G F	M/M+G F	M/M+G F	M/M+G F	M/M+G F	M/M+G F	M/M+G F
	C/L	M	M	M	M	M	M	M	M

For D960 full slot operation the A-field header coding (BA bits) shall distinguish between:

- E-type, mode 0;
- E-type, modes 1 - 11; and
- E-type, mode 12.

For D16 half slot operation (4 level modulation) the modes given in the following table are allowed.

Table 6.13: D16 half slot 4-level modes

Subfield	B0	B1	
Mode 0	C/O	C _F	C _F
	C/L	CL _F	CL _F
Mode 1	C/O	M/M+G _F	C _F
	C/L	M	CL _F
Mode 2	C/O	M/M+G _F	M/M+G _F
	C/L	M	M

For D16 half slot operation the A-field header coding (BA bits) will distinguish between:

- E-type, mode 0;
- E-type, modes 1; and
- E-type, mode 2.

For D24 half slot operation (8 level modulation) the modes given in the following table are allowed.

Table 6.14: D-24 half slot 8-level modes

Subfield		B0	B1	B2
Mode 0	C/O	C _F	C _F	C _F
	C/L	CL _F	CL _F	CL _F
Mode 1	C/O	M/M+G _F	C _F	C _F
	C/L	M	CL _F	CL _F
Mode 2	C/O	M/M+G _F	M/M+G _F	C _F
	C/L	M	M	CL _F
Mode 3	C/O	M/M+G _F	M/M+G _F	M/M+G _F
	C/L	M	M	M

For D24 half slot operation the A-field header coding (BA bits) will distinguish between:

- E-type, mode 0;
- E-type, modes 1 - 2; and
- E-type, mode 3.

For Connection Oriented services (C/O) and when in E mode, the following priority scheme shall be used to fill the B-subfields:

- 1) **Release:** bearer release messages for this bearer may be transmitted and may be placed in all subfields.
- 2) **Retransmissions of C_F:** for retransmissions of B-fields containing C_F, the same mode shall be used.
- 3) **Bearer quality control In an asymmetric connection:** in an asymmetric connection a "MAC-Mod2-ACKs" message (clause 7.3.4.4) may be placed in the subfield B0.
- 4) **Other MAC layer control (excluding Null message):** this may be placed in the remaining subfields. The subfields are used in the following order of preference, B0, B1, B2, B3, B4, B5, B6, B7, B8, B9.
- 5) **New C_F data:** any remaining subfields may be used for C_F data. The subfields are used in the following order of preference, B_N, B_{N-1}, ..., B₁, B₀. However, the sequence of data through the MC SAP shall be B₀, B₁, ..., B_{N-1}, B_N.
- 6) **New G_F data:** this may be placed in any subfield that has not yet been used. The order of usage of subfields and the sequence of data segments through the MC SAP is not specified.
- 7) **Null message:** this shall be used to fill any subfields still empty.

In connectionless services new CL_F segments have priority over MAC control.

6.2.2.3.2 Half slot modes for 2 level modulation

For D08 half slot mode (2 level modulation) only one B-subfield is available for control. The following types of information have to be multiplexed:

- higher layer control from the C_F or CL_F logical channel;
- higher layer information from G_F logical channel; and
- MAC layer connection related signalling.

Only one E-type mapping exists.

The A-field header coding will distinguish between:

- E-type, mode 0; and
- E-type, mode 1.

Mode 0: the E-type databurst carries C_F or CL_F control;

Mode 1: the E-type databurst carries extended MAC or G_F control.

When in E mode, the following priority scheme shall be used to fill the B0 subfield in connection oriented services:

- 1) **Release:** bearer release messages for this bearer may be placed in B0.
- 2) **Retransmissions of C_F .**
- 3) **MAC layer control** (excluding Null message).
- 4) **New C_F data.**
- 5) **New G_F data.**
- 6) **Null Message:** U-type information should normally be sent in preference to this.

For connectionless services, CL_F data has priority over MAC control.

6.2.3 Encryption

Encryption is a privacy mechanism which may be provided to encrypt all C, I, and G_F -channel data of a connection oriented call. The key stream generator KSG in the MBC produces the encryption sequence which are XOR'd with the original data in the TBC's encryption entity.

NOTE 1: When enabled also M-channel data transmitted in the B-field is encrypted.

NOTE 2: Error control (R-CRC, B-CRC and X-CRC bits) are never encrypted.

Before activating the encryption mechanism for the first time, the DLC provides the MBC with a secret encryption key. This key is loaded into the key stream generator KSG.

Enabling and disabling of encryption is ordered by the DLC. The MBC is responsible for switching between encryption mode and clear mode. The actual encryption mode of the connection controlled by the MBC shall be the same for all established bearers of this connection.

The present document defines:

- the messages required for switching the encryption mode of a connection;
- the primitives exchanged between MAC and DLC; and
- the instant in time to enable encryption during bearer setup provided that the new bearer belongs to a connection in encryption mode.

The following items related to the MAC layer are defined in EN 300 175-7 [6]:

- the algorithm used by the KSG to generate the encryption sequence;
- the MAC procedure to switch a connection between encryption and clear mode; and
- the mapping of the encryption sequence onto the data fields.

6.2.4 Scrambling

A scrambler is used to avoid long "0" or "1" sequences occurring several times due to unaltered data or retransmission protocols. The TBC generates pseudo-random sequences which change for consecutive TDMA frames and combines the original B-field data with these sequences.

Scrambling is applied to all B-field data except the X-field. These are:

- the first 800 bits numbered from b0 to b799 for D80 double slot;
- the first 1600+f bits numbered from b0 to b(1599+f) for D160 double slot;
- the first 2400+f bits numbered from b0 to b(2399+f) for D240 double slot;
- the first 320 bits numbered from b0 to b319 for D32 full slot;
- the first 640+f bits numbered from b0 to b(639+f) for D64 full slot;
- the first 960+f bits numbered from b0 to b(959+f) for D96 full slot;
- the first 80 + j bits numbered from b0 to b(79+j) for D08 half slot;
- the first 160 +2j +f bits numbered from b0 to b(159+2j+f) for D16 half slot;
- the first 240 +3j +f bits numbered from b0 to b(239+3j+f) for D24 half slot.

The scrambled data is a combination of the original data and a scrambling sequence:

$$b_i = b_i \text{ XOR } s_{fi}$$

where:

- $i \in \{0 .. 799\}$ for D80 double slot;
- $i \in \{0 .. 1599+f\}$ for D160 double slot;
- $i \in \{0 .. 2399+f\}$ for D240 double slot;
- $i \in \{0 .. 319\}$ for D32 full slot;
- $i \in \{0 .. 639+f\}$ for D64 full slot;
- $i \in \{0 .. 959+f\}$ for D96 full slot;
- $i \in \{0 .. 79 + j\}$ for D08 half slot;
- $i \in \{0 .. 159+f+2j\}$ for D16 half slot;
- $i \in \{0 .. 239+f+3j\}$ for D24 half slot.

XOR describes the "exclusive-OR" function and s_{fi} denotes bit "i" of the scrambling sequence s_f .

Eight scrambling sequences exist, s_0 to s_7 . The number "f" of the scrambling sequence s_f actually used, depends upon the TDMA frame number within the multi-frame structure:

$$f = (\text{TDMA frame number}) \text{ MOD } 8.$$

The scrambling sequences are based on a pseudo random sequence of length 31. This sequence is the maximal length sequence generated by the five stage shift register shown in figure 6.40.

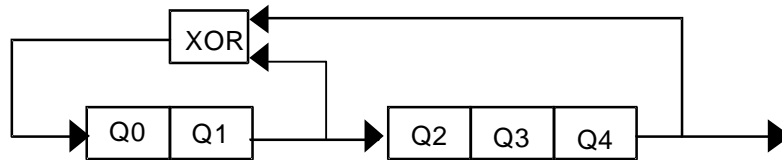

Figure 6.40: Scrambling sequence generation

For the initial state of the shift register, Q_3 and Q_4 are set to 1. Between the settings of Q_0 , Q_1 , Q_2 and the sequence number f of the scrambling sequence sf the following relation shall hold:

$$f = Q_2 * 4 + Q_1 * 2 + Q_0$$

The scrambling sequence corresponds to the shift register output after passing an inversion mechanism.

The output of the shift register is the actual state of Q_4 . Therefore, the first output of the shift register used to build the scrambling bit sf_0 corresponds to the initial state of Q_4 .

The inversion mechanism has two modes, the shift register output passes through non inverted or inverted. The inversion mechanism toggles from one mode to the other mode when the shift register switches to the state following the all one state. The toggle mode is preset to invert the first output of the shift register.

Scrambling of the B-field is mandatory and shall always be applied, even when encryption is active.

6.2.5 Error control

The MAC layer provides error control for all logical channels, using a combination of three Cyclic Redundancy Codes (CRC):

- R-CRC; a 16-bit CRC;
- B-CRC; a 32-bit CRC for I_{PQ} services;
- X-CRC; a 4-bit CRC.

6.2.5.1 R-CRC overview

The R-CRC is used to provide the main MAC layer error control. The MAC layer calculates 16 redundancy bits over several fixed length data blocks:

- all A-fields;
- all B-subfields in protected format.

In each case, the redundancy bits are appended to the data blocks and allow a redundancy check in the receiver. In the different mapping schemes given in clause 6.2.1.3, the fields for transmitting the CRC bits are denoted as R_A and $R_{B0} \dots R_{BN}$. The procedure for calculating the 16 or 32 CRC bits and the rule to check a received data block with its CRC bits is defined in clauses 6.2.5.2 and 6.2.5.5 respectively.

Data transmitted from all logical channels except the I_N -channel and the SI_N -channel is located in data blocks to which these 16 CRC bits are appended (see mapping schemes in clause 6.2.1). This allows the receiver to detect errors in all N, Q, BS, C_S , C_F , CL_S , CL_F , SI_P , I_P , G_F and M-channel data.

For N, Q, BS, CL_S , CL_F , SI_P , M and G_F -channel data and I_P -channel data (when in the I_P _error_detection service) only error detection capability is provided. No MAC layer retransmission scheme is applied for this data.

For C_S and C_F -channel data, a MAC layer retransmission scheme is defined in order to correct transmission errors. A numbering scheme allows successive data transmissions on these channels to be distinguished. This allows repetition (retransmission) of the same data several times until the transmitter gets an acknowledgement from the data receiver or the transmitter stops retransmitting the data. The retransmission process is described in clause 10.8.

For the I_p _error_correction service the MAC layer provides a retransmission scheme for I_p data. Retransmissions are done for each bearer independently. The receiving side requests that the sending side transmits the last packet again until no errors are detected or, until a timer expires. When the timer expires that packet is discarded. Data passed to the upper layer is almost free from errors. This error correction scheme is called the MOD-2 retransmission scheme for I_p data, and described in clause 10.8.2.

6.2.5.2 R-CRC generation and checking

All $m = 64$ bit A-fields and all $m = 80$ bit B-subfields (see clause 6.2.1.3) contain n data bits and 16 check bits. Therefore the data block length n is $m - 16$. The 16 check bits are appended to the n data bits. For encoding, the n data bits shall be considered to be the coefficients of a polynomial having terms from x^{m-1} down to x^{16} . If the m bits of one protected field are transmitted in ascending order (r_0, r_1, \dots, r_{m-1}) the polynomial is built as:

$$r_0 \times x^{m-1} + r_1 \times x^{m-2} + \dots + r_{n-1} \times x^{16}$$

This polynomial is divided by the generating polynomial:

$$g(x) = x^{16} + x^{10} + x^8 + x^7 + x^3 + 1 = 202'611 \text{ (oct)}$$

The 16 check bits shall be the coefficients of the terms from x^{15} to x^0 in the remainder polynomial, found at the completion of the division. The remainder polynomial has the form:

$$r_n \times x^{15} + r_{n+1} \times x^{14} + \dots + r_{m-1} \times x^0$$

The last check bit (coefficient r_{m-1} of the x^0 term in the remainder polynomial) is finally inverted.

In the resulting $m = n + 16$ bit codeword, the leading n bits correspond to the original data bits.

For error detecting it has to be ensured that the received m -bit codeword is a valid codeword. Again the m bits can be considered to be the coefficients of a polynomial having terms from x^{m-1} down to x^0 . If the m bits of one protected field are received in ascending order (r_0, r_1, \dots, r_{m-1}) the polynomial is built as:

$$r_0 \times x^{m-1} + r_1 \times x^{m-2} + \dots + r_{m-1} \times x^0$$

After inverting the coefficient r_{m-1} of the x^0 term the generator polynomial $g(x)$ divides all valid codewords.

6.2.5.3 X-CRC overview

For error control of B-field data a limited error detection scheme is always applied, even for unprotected B-field formats. This is the only protection that is applied to the I_N and SI_N logical channels. The MAC layer calculates 4, 8 or 12 redundancy bits (depending on the level of modulation) from selected B-field data bits. These bits are transmitted in the X-field. The X-field occupies the last four, eight or twelve bits of the B-field in all multiplexes. The X-field allows a redundancy check in the receiver. The procedure for calculating and checking the X-field bits is defined in clause 6.2.5.4.

6.2.5.4 X-CRC generation and checking

The X-field consists of the last 4 bits of the B-field for 2 level modulation, the last 8 bits of the B-field for 4 level modulation and the last 12 bits for 8 level modulation. It is used to test channel quality and to detect sliding collisions. Therefore, a CRC check is done over a selected number of scrambled B-field bits.

The overall number of test bits is m . These m bits include the 4, 8 or 12 X-field bits. The number m is different for half slot, for full slot, and for double slot and also depends on the level of modulation:

- $m = 84 + j$ for 2 level modulation half slot;
- $m = 88 + 2j+f/2$ for 4 level modulation half slot;
- $m = 92 + 3j+f/2$ for 8 level modulation half slot;
- $m = 84$ for 2 level modulation full slot;
- $m = 168 + f/4$ for 4 level modulation full slot;
- $m = 252 + f/4$ for 8 level modulation full slot;
- $m = 164$ for 2 level modulation double slot.
- $m = 408 + f/4$ for 4 level modulation double slot;
- $m = 612 + f/4$ for 8 level modulation double slot.

With a test bit assignment of $(r_0, r_1, \dots, r_{m-1})$ the mapping of the test bits onto the B-field is the following:

For 2 level modulation:

$$r_i = b_i \quad ; \quad 0 \leq i \leq 83 + j \text{ for half slot,}$$

$$r_i = b_{i+48} \quad ; \quad 0 \leq i \leq 15$$

$$b_{i+96} \quad ; \quad 16 \leq i \leq 31$$

$$b_{i+144}; \quad 32 \leq i \leq 47$$

$$b_{i+192}; \quad 48 \leq i \leq 63$$

$$b_{i+240}; \quad 64 \leq i \leq 83 \text{ for full slot,}$$

$$r_i = b_{i+64} \quad ; \quad 0 \leq i \leq 15$$

$$b_{i+128}; \quad 16 \leq i \leq 31$$

$$b_{i+192}; \quad 32 \leq i \leq 47$$

$$b_{i+256}; \quad 48 \leq i \leq 63$$

$$b_{i+320}; \quad 64 \leq i \leq 79$$

$$b_{i+384}; \quad 80 \leq i \leq 95$$

$$b_{i+448}; \quad 96 \leq i \leq 111$$

$$b_{i+512}; \quad 112 \leq i \leq 127$$

$$b_{i+576}; \quad 128 \leq i \leq 143$$

$$b_{i+640}; \quad 144 \leq i \leq 163 \text{ for double slot.}$$

For 4 level modulation:

$$r_i = b_{i+16} ; 0 \leq i \leq 15$$

$$b_{i+32} ; 16 \leq i \leq 31$$

$$b_{i+48} ; 32 \leq i \leq 47$$

$$b_{i+64} ; 48 \leq i \leq 63$$

$$b_{i+80} ; 64 \leq i \leq 79$$

$$b_{i+100} ; 80 \leq i \leq 87 + f/2 + 2j \text{ for half slot}$$

$$r_i = b_{i+48} ; 0 \leq i \leq 15$$

$$b_{i+96} ; 16 \leq i \leq 31$$

$$b_{i+144} ; 32 \leq i \leq 47$$

$$b_{i+192} ; 48 \leq i \leq 63$$

$$b_{i+240} ; 64 \leq i \leq 79$$

$$b_{i+288} ; 80 \leq i \leq 95$$

$$b_{i+336} ; 96 \leq i \leq 111$$

$$b_{i+384} ; 112 \leq i \leq 127$$

$$b_{i+432} ; 128 \leq i \leq 143$$

$$b_{i+480} ; 144 \leq i \leq 167 + f/4 \text{ for full slot}$$

$$r_i = b_{i+48} ; 0 \leq i \leq 15$$

$$b_{i+96} ; 16 \leq i \leq 31$$

$$b_{i+144} ; 32 \leq i \leq 47$$

$$b_{i+192} ; 48 \leq i \leq 63$$

$$b_{i+240} ; 64 \leq i \leq 79$$

$$b_{i+288} ; 80 \leq i \leq 95$$

$$b_{i+336} ; 96 \leq i \leq 111$$

$$b_{i+384} ; 112 \leq i \leq 127$$

$$b_{i+432} ; 128 \leq i \leq 143$$

$$b_{i+480} ; 144 \leq i \leq 159$$

$$b_{i+528} ; 160 \leq i \leq 175$$

$$b_{i+576} ; 176 \leq i \leq 191$$

$$b_{i+624} ; 192 \leq i \leq 207$$

$$\begin{aligned}
b_{i+672} & ; 208 \leq i \leq 223 \\
b_{i+720} & ; 224 \leq i \leq 239 \\
b_{i+768} & ; 240 \leq i \leq 255 \\
b_{i+816} & ; 256 \leq i \leq 271 \\
b_{i+864} & ; 272 \leq i \leq 287 \\
b_{i+912} & ; 288 \leq i \leq 303 \\
b_{i+960} & ; 304 \leq i \leq 319 \\
b_{i+1008} & ; 320 \leq i \leq 335 \\
b_{i+1056} & ; 336 \leq i \leq 351 \\
b_{i+1104} & ; 352 \leq i \leq 367 \\
b_{i+1152} & ; 368 \leq i \leq 383 \\
b_{i+1200} & ; 384 \leq i \leq 407+f/4 \quad \text{for double slot.}
\end{aligned}$$

For 8 level modulation:

$$\begin{aligned}
r_i & = b_{i+16} ; 0 \leq i \leq 15 \\
& b_{i+32} ; 16 \leq i \leq 31 \\
& b_{i+48} ; 32 \leq i \leq 47 \\
& b_{i+64} ; 48 \leq i \leq 63 \\
& b_{i+80} ; 64 \leq i \leq 79 \\
& b_{i+160} ; 80 \leq i \leq 91+f/2+3j \quad \text{for half slot} \\
r_i & = b_{i+48} ; 0 \leq i \leq 15 \\
& b_{i+96} ; 16 \leq i \leq 31 \\
& b_{i+144} ; 32 \leq i \leq 47 \\
& b_{i+192} ; 48 \leq i \leq 63 \\
& b_{i+240} ; 64 \leq i \leq 79 \\
& b_{i+288} ; 80 \leq i \leq 95 \\
& b_{i+336} ; 96 \leq i \leq 111 \\
& b_{i+384} ; 112 \leq i \leq 127 \\
& b_{i+432} ; 128 \leq i \leq 143 \\
& b_{i+480} ; 144 \leq i \leq 159 \\
& b_{i+528} ; 110 \leq i \leq 175
\end{aligned}$$

$$b_{i+576} ; 176 \leq i \leq 191$$

$$b_{i+624} ; 192 \leq i \leq 207$$

$$b_{i+672} ; 208 \leq i \leq 223$$

$$b_{i+720} ; 224 \leq i \leq 251+f/4 \quad \text{for full slot}$$

$$r_i = b_{i+48} ; 0 \leq i \leq 15$$

$$b_{i+96} ; 16 \leq i \leq 31$$

$$b_{i+144} ; 32 \leq i \leq 47$$

$$b_{i+192} ; 48 \leq i \leq 63$$

$$b_{i+240} ; 64 \leq i \leq 79$$

$$b_{i+288} ; 80 \leq i \leq 95$$

$$b_{i+336} ; 96 \leq i \leq 111$$

$$b_{i+384} ; 112 \leq i \leq 127$$

$$b_{i+432} ; 128 \leq i \leq 143$$

$$b_{i+480} ; 144 \leq i \leq 159$$

$$b_{i+528} ; 160 \leq i \leq 175$$

$$b_{i+576} ; 176 \leq i \leq 191$$

$$b_{i+624} ; 192 \leq i \leq 207$$

$$b_{i+672} ; 208 \leq i \leq 223$$

$$b_{i+720} ; 224 \leq i \leq 239$$

$$b_{i+768} ; 240 \leq i \leq 255$$

$$b_{i+816} ; 256 \leq i \leq 271$$

$$b_{i+864} ; 272 \leq i \leq 287$$

$$b_{i+912} ; 288 \leq i \leq 303$$

$$b_{i+960} ; 304 \leq i \leq 319$$

$$b_{i+1008} ; 320 \leq i \leq 335$$

$$b_{i+1056} ; 336 \leq i \leq 351$$

$$b_{i+1104} ; 352 \leq i \leq 367$$

$$b_{i+1152} ; 368 \leq i \leq 383$$

$$b_{i+1200} ; 384 \leq i \leq 399$$

$$b_{i+1248} ; 400 \leq i \leq 415$$

$$b_{i+1296}; \quad 416 \leq i \leq 231$$

$$b_{i+1344}; \quad 432 \leq i \leq 447$$

$$b_{i+1392}; \quad 448 \leq i \leq 463$$

$$b_{i+1440}; \quad 464 \leq i \leq 479$$

$$b_{i+1488}; \quad 480 \leq i \leq 495$$

$$b_{i+1536}; \quad 496 \leq i \leq 511$$

$$b_{i+1584}; \quad 512 \leq i \leq 527$$

$$b_{i+1632}; \quad 528 \leq i \leq 543$$

$$b_{i+1680}; \quad 544 \leq i \leq 559$$

$$b_{i+1728}; \quad 560 \leq i \leq 575$$

$$b_{i+1776}; \quad 576 \leq i \leq 383$$

$$b_{i+1800}; \quad 384 \leq i \leq 407+f/4 \quad \text{for double slot.}$$

The first $m-4$ (or $m-8$ or $m-12$) bits (r_0, r_1, \dots, r_{m-5} (or $m-9$ or $m-13$)) are considered as the coefficients of the polynomial:

$$r_0 \times x^{m-1} + r_1 \times x^{m-2} + \dots + r_{m-5} \times x^4 \quad \text{for 2 level modulation;}$$

$$r_0 \times x^{m-1} + r_1 \times x^{m-2} + \dots + r_{m-9} \times x^8 \quad \text{for 4 level modulation;}$$

$$r_0 \times x^{m-1} + r_1 \times x^{m-2} + \dots + r_{m-13} \times x^{12} \quad \text{for 8 level modulation.}$$

This polynomial shall be divided by the polynomial:

$$x^4 + 1 = 21 \quad (\text{oct}) \quad \text{for 2 level modulation;}$$

$$x^8 + 1 = 401 \quad (\text{oct}) \quad \text{for 4 level modulation;}$$

$$x^{12} + x^{11} + x^3 + x^2 + x + 1 = 14016 \quad (\text{oct}) \quad \text{for 8 level modulation.}$$

The remainder polynomial has the form:

$$r_{m-4} \times x^3 + r_{m-3} \times x^2 + r_{m-2} \times x + r_{m-1} \quad \text{for 2 level modulation;}$$

$$r_{m-8} \times x^7 + r_{m-7} \times x^6 + r_{m-6} \times x^5 + r_{m-5} \times x^4 + r_{m-4} \times x^3 + r_{m-3} \times x^2 + r_{m-2} \times x + r_{m-1} \quad \text{for 4 level modulation;}$$

$$r_{m-12} \times x^{11} + r_{m-11} \times x^{10} + r_{m-10} \times x^9 + r_{m-9} \times x^8 + r_{m-8} \times x^7 + r_{m-7} \times x^6 + r_{m-6} \times x^5 + r_{m-5} \times x^4 + r_{m-4} \times x^3 + r_{m-3} \times x^2 + r_{m-2} \times x + r_{m-1} \quad \text{for 8 level modulation,}$$

where the coefficients r_{m-4} ($m-8/m-12$) \dots r_{m-1} shall represent the last four (eight or twelve) test bits and shall be transmitted in the X-field for 2-level, 4-level respectively 8-level modulation.

For the X-field check, the received test pattern (r_0, r_1, \dots, r_{m-1}) builds the polynomial:

$$r_0 \times x^{m-1} + r_1 \times x^{m-2} + \dots + r_{m-1} \times x^0$$

The polynomial $x^4 + 1 = 21$ (oct), $x^8 + 1 = 401$ (oct) and $x^{12} + x^{11} + x^3 + x^2 + x + 1 = 14016$ (oct) divide all valid test patterns.

6.2.5.5 B-CRC generation and checking for I_{PQ} services

For more efficient user data transmission I_{PQ} services using a single 32 Bit CRC over the whole B-field are introduced.

All m bit I_{PQ} format B-fields (see clause 6.2.1.3) contain n data bits and 32 check bits. Therefore the data block length n is m - 32. The 32 check bits are appended to the n data bits. For encoding, the n data bits shall be considered to be the coefficients of a polynomial having terms from x^{m-1} down to x^{32} . If the m bits of one protected field are transmitted in ascending order (r_0, r_1, \dots, r_{m-1}) the polynomial is built as:

$$d(x) = r_0 x^{m-1} + r_1 x^{m-2} + \dots + r_{n-1} x^{32}$$

The generator polynomial defines to:

$$g(x) = x^{32} + x^{26} + x^{23} + x^{22} + x^{16} + x^{12} + x^{11} + x^{10} + x^8 + x^7 + x^5 + x^4 + x^2 + x + 1$$

The 32 Bit checksum shall be the ones complement of the sum (modulo 2) of:

the remainder of $x^n \times (x^{31} + x^{30} + \dots + x + 1)$ divided (modulo 2) by the generator polynomial $g(x)$,

the remainder of the division (modulo 2) by the generator polynomial $g(x)$ of the data bit polynomial $d(x)$.

As a typical implementation at the transmitter, the initial content of the register of the device computing the remainder of the division is pre-set to all 1s and is then modified by division by the generator polynomial (as described above) on the address, control, and information fields; the ones complement of the resulting remainder is transmitted as the thirty-two-bit checksum.

As a typical implementation at the receiver, the initial content of the register of the device computing the remainder is pre-set to all 1s. The final remainder after multiplication by x^{32} and then division (modulo 2) by the generator polynomial $g(x)$ of the serial incoming protected bits and the checksum, will be "1100 0111 0000 0100 1101 1101 0111 1011" (x^{31} through x^0 , respectively) in the absence of transmission errors.

6.2.6 Broadcast controller

The broadcast controller in the TBC or CBC or DBC adds RFP specific information to data from the BMC. Some examples for RFP specific information are: the RPN number (see clause 7.2.2), the number of transceivers within the RFP, description of slot position and frequency of the radio channel in use (see clause 7.2.3.2), or blind slot information (see clause 7.2.4.3.3).

7 Medium access layer messages

General remarks:

- 1) When not specially defined, all numbers in A-field or B-field messages are coded with the natural binary value and are arranged such that the Most Significant Bit (MSB) is transmitted first and the Least Significant Bit (LSB) is transmitted last.

EXAMPLE: A five bit number with a value of 12 (decimal) = 01100 (binary) which is transmitted in the bits a_{13} to a_{17} or in the bits bn_{13} to bn_{17} is coded as in figure 7.1:

	0	1	1	0	0
	MSB				LSB
	a_{13}	a_{14}	a_{15}	a_{16}	a_{17}
	bn_{13}	bn_{14}	bn_{15}	bn_{16}	bn_{17}

Figure 7.1: Most and Last Significant Bit

- 2) "Escape" codes are for proprietary use. The main escape is provided in the tail identification (see clause 7.1.2). Secondary escapes are also provided for proprietary extensions to the messages. These secondary codes shall not be used to replace functions that can be equally provided using DECT standard functions.
- 3) "Reserved" codes are for future DECT CI expansions. These codes shall not be used. These codes may be specified in future revisions of the present document.
- 4) Messages not implemented shall be ignored.

7.1 Header field

7.1.1 Overview/formatting

The header field, H, occupies bits a₀ to a₇ of the A-field. See figure 7.2.

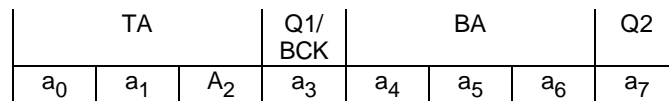

Figure 7.2: Header field formatting

7.1.2 Tail identification, TA, bits a₀ to a₂

These bits describe the contents of the 40 bits that follow the header field. See table 7.1.

Table 7.1: Tail Identification

a ₀	a ₁	a ₂	Tail Contents	Restrictions
0	0	0	C _T data packet number 0	
0	0	1	C _T data packet number 1	
0	1	0	identities information (N _T) on connectionless bearer	
0	1	1	identities information (N _T)	
1	0	0	multiframe synchronization and system information (Q _T)	
1	0	1	Escape	
1	1	0	MAC layer control (M _T)	
1	1	1	paging tail (P _T)	RFP only
1	1	1	first PP transmission (M _T)	PP only
"RFP only" means: RFP transmissions only.				
"PP only" means : PP transmissions only.				

NOTE: Rigorous testing of all possible reserved tails is not intended. A manufacturer's declaration is appropriate.

When the escape code is used it shall appear in every header and no other TA code shall be used. The escape code indicates the use of proprietary protocols and no compatibility with the standard protocol can be assumed (see EN 300 175-1 [1]).

7.1.3 The "Q1 / BCK" bit, bit a_3

The bit a_3 has only a defined meaning for duplex traffic bearers, i.e. duplex bearers in connection oriented services. For all other bearers and services this bit is set to "0".

For duplex bearers of a MAC layer I_P _error_correction service (connection oriented service) this bit is the "BCK" bit and is used for I_P -channel flow control. Its value is defined by the procedures given in clause 10.8.2.

For duplex bearers of all the other connection oriented MAC layer services, this bit is the "Q1" bit and used for bearer quality control. Its value is defined by the procedures given in clause 10.8.1.3.

7.1.4 B-field identification, BA, bits a_4 to a_6

These bits describe the contents of the B-field that follows the A-field. See table 7.2.

Table 7.2: B-field ID

a_4	a_5	a_6	B-field contents
0	0	0	U-type, I_N , SI_N , or I_P packet number 0 or no valid I_P error detect channel data
0	0	1	U-type, I_P error detect or I_P packet number 1 or SI_P or no valid I_N channel data
0	1	0	E-type, all C_F or CL_F , packet number 0
0	1	0	double slot required
0	1	1	E-type, all C_F , packet number 1
1	0	0	E-type, not all C_F or CL_F ; C_F packet number 0
1	0	0	half slot required
1	0	1	E-type, not all C_F ; C_F packet number 1
1	1	0	E-type, all MAC control (unnumbered)
1	1	1	no B-field
NOTE 1: The 000 code may be used to indicate that the B-field does not contain valid data, only for an already established I_P error detect connection.			
NOTE 2: The 001 code may be used to indicate that the B-field does not contain valid data, only for an already established I_N connection.			

NOTE: Testing of this H-field with all possible T- and B-fields is not intended. A manufacturer's declaration is appropriate.

In relation to a BEARER_REQUEST message of the A-field advanced connection control set and REP connection control set, the a_4, a_5, a_6 bits shall indicate the following:

- 010: "double slot required",
B-field does not contain valid logical channel data
- 100: "half slot required",
B-field does not contain valid logical channel data

The first response from the called side shall use the same BA bits setting used by the calling side and the B-field does not contain valid logical channel data. In the following messages, the BA bits shall indicate the logical channels contained in the B-field.

In relation to a BEARER_REQUEST message of the A-field advanced connection control set and REP connection control set, all other codings shall indicate full slot with the B-field contents described above.

In relation to a BEARER_REQUEST message of the B-field advanced connection control set the a4, a5, a6 bits shall indicate the following:

010: "double slot required",

100: "half slot required".

In the first response from the called side and in the following messages, the BA bits shall indicate the logical channels contained in the B-field.

7.1.5 The "Q2" bit, bit a₇

The bit a₇ has only a defined meaning for duplex traffic bearers, i.e. duplex bearers in connection oriented services. For all other bearers and services this bit is set to "0".

For duplex bearers of connection oriented MAC layer services, this bit is the "Q2" bit and used for bearer quality control and C-channel flow control. Its value is defined by the procedures given in clause 10.8.1.3 for I_N and I_{p_error_detection} services and in clause 10.8.2.4 for I_{p_error_correction} services.

7.2 Messages in the tail field

7.2.1 Overview

Several different messages may be multiplexed into the tail field, according to the T-MUX algorithm defined in clause 6.2.2.1. The contents of the tail field are defined for each frame by the tail identification bits defined in clause 7.1.2.

Each tail message has a fixed length of 40 bits. In the following descriptions the mapping of the message into the A-field is shown. The first bit of the message always appears in bit position a₈ as shown in figure 7.3:

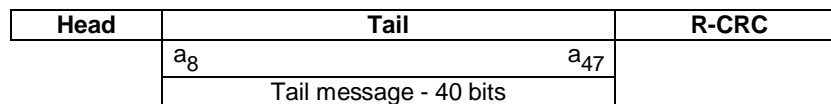

Figure 7.3: Tail field

The following tail messages are defined:

- N-channel messages (see clause 7.2.2);
- Q-channel messages (see clause 7.2.3);
- P-channel messages (see clause 7.2.4);
- M-channel messages (see clause 7.2.5).

7.2.2 Identities information (N_T)

The management entity in the RFP supplies the MAC layer with the primary access rights identifier, an SDU of either 32 bits or 37 bits passed through the ME SAP. The RFP adds its radio fixed part number (8 or 3 bit) RPN to this SDU so that the RPN forms the least significant bits of the resulting 40 bit field. The complete 40 bit message forms the radio fixed part identity (see EN 300 175-6 [5]), and this is the only message that appears in N_T type tails sent by the RFP. The least significant bit of RFPI is placed in bit position a₄₇.

NT type tails sent by a PT contain the RFPI of that RFP with which it is maintaining the bearer.

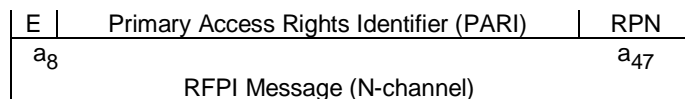

Figure 7.4

7.2.3 System information and multiframe marker (Q_T)

7.2.3.1 General

The multiframe marker is transmitted once every 16 frames. This marker is combined with the tail code for system information (Q). Q-channel information is therefore only transmitted by RFPs once every multiframe.

The basic format of the Q-field is to have a 4 bit header (the Q_H field) followed by a 36 bit information field. See figure 7.5.

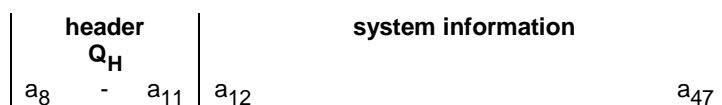

Figure 7.5: System Information field

The Q_H field is used to identify 16 different system information fields. Any one of these fields can be transmitted in each multiframe. Some of these fields need never be transmitted. PTs are required to understand some of these fields. There is a maximum time interval between transmissions of mandatory fields. The exact sequencing of different Q fields by an RFP is not defined.

Table 7.3

Q_H	SYSTEM INFORMATION	MAN	FREQ
000X	static system info	Yes	8
0010	extended RF carriers	note 1	8
0011	fixed part capabilities	Yes	8
0100	extended fixed part capabilities	note 2	8
0101	SARI list contents	No	4
0110	multi-frame number	note 3	8
0111	escape	No	-
1000 to 1111	} } Reserved }		
MAN = Mandatory transmission (Yes/No). FREQ = Maximum repeat interval in multiframe, if implemented. NOTE 1: If an extended frequency allocation is used this message shall be transmitted in the multiframe following every transmission of the static system information. NOTE 2: If extended fixed part capabilities information is available this message shall be transmitted in the multiframe following every transmission of the fixed part capabilities information. NOTE 3: If an RFP implements encryption then this message shall be transmitted at least once every 8 multiframe.			

7.2.3.2 Static system information

7.2.3.2.1 General, $Q_H = 0, 1$ (hex)

This message shall be sent at least once every 8 multiframes. See figure 7.6.

Q_H				SN	SP	esc	Txs	Mc	RF-cars	spr	CN	spr	PSCN
0	0	0	N R										
8				a_{12} a_{15}	a_{16} a_{17}	a_{18}	a_{19} a_{20}	a_{21}	22	a_{32} a_{33}	34	a_{40} a_{41}	42 a_{47}

Figure 7.6: Static System Information

7.2.3.2.2 Q_H and Normal-Reverse (NR)

NR defines whether the RFP is transmitting in its normal half frame, or whether this is the reversed half of an asymmetric connection. See table 7.4.

Table 7.4: NR bit

bit a_{11}	meaning
0	"normal" RFP transmit half frame
1	"normal" PP transmit half frame

NOTE: Q_H and NR are combined to allow easier decoding.

7.2.3.2.3 Slot Number (SN)

This defines the number of the slot pair in which this transmission begins. See table 7.5.

Table 7.5: Slot Number

bits				meaning
a_{12}	a_{13}	a_{14}	a_{15}	
0	0	0	0	slot pair {0,12}
0	0	0	1	slot pair {1,13}
0	0	1	0	slot pair {2,14}
0	0	1	1	slot pair {3,15}
0	1	0	0	slot pair {4,16}
0	1	0	1	slot pair {5,17}
0	1	1	0	slot pair {6,18}
0	1	1	1	slot pair {7,19}
1	0	0	0	slot pair {8,20}
1	0	0	1	slot pair {9,21}
1	0	1	0	slot pair {10,22}
1	0	1	1	slot pair {11,23}
1	1	0	0	}
to				} reserved
1	1	1	1	}

7.2.3.2.4 Start Position (SP)

Start position defines the bit in the full slot pair where transmission of the first bit of the S-field starts. See table 7.6.

Table 7.6: Start Position

bits		meaning
a ₁₆	a ₁₇	
0	0	S-field starts at bit f0
0	1	reserved for future use
1	0	S-field starts at bit f240
1	1	reserved for future use

NOTE 1: f240 is a "half slot".

NOTE 2: Only full slots starting at bit f0 are currently fully defined.

7.2.3.2.5 ESCape bit (ESC)

When set to "1", indicates that the "escape" Q_T message will be broadcast (see clause 7.2.3.8). See table 7.7.

Table 7.7: ESCape bit

bit a ₁₈	meaning
0	no "Q _T Escape" is broadcast
1	the "Q _T Escape" is broadcast

7.2.3.2.6 Number of transceivers

This gives the number of transceivers in the RFP. See table 7.8.

Table 7.8: Number of transceivers

bits		meaning
a ₁₉	a ₂₀	
0	0	RFP has 1 transceiver
0	1	RFP has 2 transceivers
1	0	RFP has 3 transceivers
1	1	RFP has 4 or more transceivers

7.2.3.2.7 Extended RF carrier information available (Mc)

If the "extended RF carrier information" Q message is transmitted by this RFP, this bit shall be set. The "extended RF carrier information" message shall be transmitted in the multi-frame following this "static system information" message. See table 7.9.

Table 7.9: Extended RF carrier information

bit a ₂₁	meaning
0	no "extended RF carrier information" message;
1	"extended RF carrier information" message shall be transmitted in the next multiframe.

7.2.3.2.8 RF carriers available (RF-cars)

10 bits are used to tell the PT which of the 10 carriers are available at this RFP.

It is required that all RFPs in the same DECT FP shall have exactly the same RF carriers available.

For bit a_x , $22 \leq x \leq 31$:

if $a_x = 0$, then RF carrier (x-22) is not available at this RFP;

else $a_x = 1$ and RF carrier (x-22) is available at this RFP.

a_x shall be set to 1 except where local regulatory conditions determine local RF carrier availability.

7.2.3.2.9 Spare bits (SPR)

Until their use is defined, these bits shall not be used. They shall be set equal to "0". See table 7.10.

Table 7.10: Spare bits

bit	Value
a_{32}	0
a_{33}	0

7.2.3.2.10 Carrier number

This defines the number of the RF carrier of this transmission. See table 7.11.

Table 7.11: Carrier number

bits						meaning
a_{34}	a_{35}	a_{36}	a_{37}	a_{38}	a_{39}	
0	0	0	0	0	0	RF Carrier 0
0	0	0	0	0	1	RF Carrier 1
0	0	0	0	1	0	RF Carrier 2
	 etc.				
0	0	1	0	0	1	RF Carrier 9
0	0	1	0	1	0	RF Carrier 10
	 etc.				
1	0	0	0	0	0	RF Carrier 32
1	0	0	0	0	1	reserved
	 to				
1	1	1	1	1	1	reserved

7.2.3.2.11 Spare bits (SPR)

Until their use is defined, these bits shall not be used. They shall be set equal to "0". See table 7.12.

Table 7.12: Spare bits

bit	Value
a_{40}	0
a_{41}	0

7.2.3.2.12 Primary receiver Scan Carrier Number (PSCN)

The PSCN defines the RF carrier on which one receiver will be listening on the next frame when only one receiver is idle. See table 7.13.

Table 7.13

bits						meaning
a ₄₂	a ₄₃	a ₄₄	a ₄₅	a ₄₆	a ₄₇	
0	0	0	0	0	0	primary scan next on RF Carrier 0
0	0	0	0	0	1	primary scan next on RF Carrier 1
0	0	0	0	1	0	primary scan next on RF Carrier 2
	 etc.				
0	0	1	0	0	1	primary scan next on RF Carrier 9
0	0	1	0	1	0	primary scan next on RF Carrier 10
	 etc.				
1	0	0	0	0	0	primary scan next on RF Carrier 32
1	0	0	0	0	1	reserved
	 to				
1	1	1	1	1	1	reserved

NOTE: In normal systems the value in the PSCN field may change with each transmission (as PSCN has a 10 frame cycle and Q messages have a 16 frame cycle).

7.2.3.3 Extended RF carrier information

7.2.3.3.1 General, $Q_H = 2$ (hex)

The transmission of this message is mandatory if a DECT FT is able to transmit on a RF carrier that is not in the set {0,1,2,3,4,5,6,7,8,9}.

All PTs shall be able to understand bits a₈ to a₁₁, and bits a₄₂ to a₄₇ inclusive, of this message. See figure 7.7.

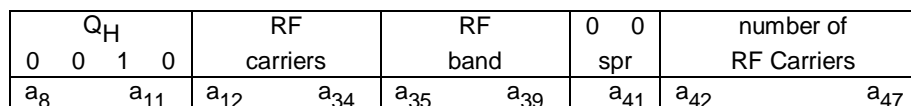

Figure 7.7: Extended RF carrier information

23 bits are used to tell the PT which of the additional 23 carriers in the set {10, 11, 12...,32} are available at this RFP.

For bit a_x, 12 ≤ x ≤ 34:

if a_x = 0 then RF carrier (x-2) is not available at this RFP; else a_x = 1 and RF carrier (x-2) is available at this RFP.

The relation between carrier frequency and carrier number is defined in the Physical Layer specification and depends on the RF band number.

Bits a₃₅ to a₃₉ give the number of the RF band. Bit a₃₉ is the least significant bit. The RF band numbers to be used are defined by the Physical Layer specification.

7.2.3.3.2 Number of RF carriers

Bits a₄₂ to a₄₇ give the total number of RF carriers that the RFP scans in a regular sequence. Bit a₄₇ is the least significant bit.

NOTE: The coding of bits a₁₂ to a₃₉, inclusive, is left for future standardization when additional frequencies are allocated.

7.2.3.4 Fixed part capabilities

7.2.3.4.1 General, $Q_H = 3$ (hex)

The fixed part shall transmit this message at least once every 8 multiframes.

A PT shall understand the bits in this message that relate to the service that the PT requires; e.g. if the PT needs an RFP with frequency control, the PT shall be able to understand the bit that says whether the RFP implements frequency control. See figure 7.8.

Q_H 0011	capabilities available information	
a_8 a_{11}	a_{12}	a_{47}

Figure 7.8: Fixed Part Capabilities

7.2.3.4.2 Standard capabilities

NOTE: Fixed part capabilities relate to the whole FP. Other capabilities are defined, which relate to, for example, a specific cluster or a specific RFP.

0011	Physical and MAC layer capabilities	Higher layer information
a_8 a_{11}	a_{12} a_{31}	a_{32} a_{47}

Figure 7.9

Physical and MAC layer capabilities available:

If a capability is available:

then bit a_x shall be set to 1;

else (capability is not available) the bit a_x shall be set to 0.

Reserved bits shall be set to 0.

Table 7.14

bit number	Capability
a12	extended FP Info (QH = 4)
a13	double duplex bearer connections
a14	reserved
a15	double slot
a16	half slot
a17	full slot
a18	frequency control
a19	page repetition
a20	C/O setup on dummy allowed
a21	C/L uplink
a22	C/L downlink
a23	basic A-field set up
a24	advanced A-field set up
a25	B-field set up
a26	CF messages
a27	I _N _minimum_delay
a28	I _N _normal_delay
a29	I _P _error_detection
a30	I _P _error_correction
a31	multibearer connections
NOTE 1: Bit a19 indicates whether or not Idle_Locked PPs may enter the low duty cycle Idle_Locked mode (see clause 11.3.3.1).	
NOTE 2: The bits a21 and a22 indicate only the capabilities of the FT to provide connectionless services in the uplink or downlink direction. They do not indicate if these services are active when the message is transmitted.	

Higher layer information:

The management entity in the fixed part supplies the MAC layer with a 16 bit SDU via the ME SAP. At the PT the MAC layer passes the 16 bits out through the ME SAP to the management entity.

For the setting of the higher layer information bits refer to annex F of EN 300 175-5 [4].

7.2.3.5 Extended fixed part capabilities**7.2.3.5.1 General, Q_H = 4 (hex)**

Part of this message is reserved for future standardization. See figure 7.10.

If this message is transmitted, it shall be sent at least once in every 8 multiframes.

NOTE: Bit a12 of the standard capabilities message (see clause 7.2.3.4) indicates whether or not this message is broadcast.

QH 0100	Extended Physical and MAC layer capabilities	Extended Higher layer capabilities
a8 a11	a12	ax ay a47

Figure 7.10: Extended fixed parts capabilities

7.2.3.5.2 Extended Physical and MAC layer capabilities

The bits for which the coding is not defined shall be set to 0. These bits are left for future standardization.

Figure 7.11 presents the structure of the extended physical and MAC layer capabilities field.

Wireless relay stations		Synchronization field		Reserved	MAC suspend and resume	I _{PA} services supported	For further standardization
a ₁₂	a ₁₇	a ₁₈	a ₁₉	a ₂₀	a ₂₁	a ₂₂	a ₂₃ a _x

Figure 7.11: Extended physical and MAC layer capabilities

7.2.3.5.2.1 Wireless relay stations

The definition of the WRS support field, a₁₂ to a₁₇ is given in table 7.15. The default value of the WRS support field is all bits set to 0.

Table 7.15: Wireless Relay Stations

WRS support	CRFP bits			REP bits			Meaning
	a ₁₂	a ₁₃	a ₁₄	a ₁₅	a ₁₆	a ₁₇	
CRFP Hops: The number of CRFPs allowed to be cascaded with the part with received RFPI	0 0 1 1	0 1 0 1	x x x x	x x x x	x x x x	x x x x	1 CRFP is allowed 2 CRFP allowed in cascade 3 CRFP allowed in cascade No CRFP allowed
CRFP encryption	x x	x x	0 1	x x	x x	x x	CRFP encryption not supported CRFP encryption supported
REP hops: The number of REPs allowed to be cascaded with the part with received RFPI	x x x x	x x x x	x x x x	0 0 1 1	0 1 0 1	x x x x	REP not supported 1 REP is allowed 2 REP are allowed in cascade 3 REP are allowed in cascade
REP capabilities	x x	x x	x x	x x	x x	0 1	REP interlacing not supported REP interlacing supported

7.2.3.5.2.2 Synchronization field options

Bits a₁₈ and a₁₉ define the synchronization field options support as given in table 7.16.

Table 7.16: Synchronization filed options

bits		Meaning
a ₁₈	a ₁₉	
0	0	standard, see EN 300 175-2 [2] clauses 4.6 & 5.2
0	1	prolonged preamble, see EN 300 175-2 [2] annex C (note)
1	0	reserved
1	1	reserved

NOTE: This message indicates that the FT is capable of using the prolonged preamble and is transmitting the prolonged preamble. When a PT receives this message, and is capable of using the prolonged preamble and/or is capable of transmitting the prolonged preamble then it should use the extended channel selection window (see EN 300 175-2 [2], clause 8.3).

7.2.3.5.2.3 MAC suspend and resume

Bit a₂₁ indicates support of the MAC suspend and resume procedures (see 10.3.1.1) when set to 1.

7.2.3.5.2.4 MAC service I_{PQ} supported

Bit a22 indicates support of the MAC service I_{PQ} to transport I_P -channel data using a singlesubfield protected B-field format as defined by clause 5.6.2.1 and 5.6.2.2 when set to 1.

7.2.3.5.3 Extended higher layer capabilities

Figure 7.12 presents the structure of the extended higher layer capabilities field.

Extended higher layer information	
ay	a47

Figure 7.12: Extended higher layer information field

The coding and the meaning of these bits are defined in annex F of EN 300 175-5 [4]. The bits for which the coding is not defined shall be set to 0.

7.2.3.6 Secondary access rights identities

7.2.3.6.1 General, $Q_H = 5$ (hex)

The transmission of this message is optional, subject to the existence of one or more valid SARIs (see figure 7.13).

If this message is transmitted, it shall be transmitted at least once every 4 multiframes.

Q_H				SARI message			
0	1	0	1				
a ₈		a ₁₁		a ₁₂			a ₄₇

Figure 7.13: SARI message field

7.2.3.6.2 SARI message

The management entity in the fixed part supplies the MAC layer with a 36 bit SDU via the ME SAP. At the PT the MAC layer passes the 36 bits out through the ME SAP to the management entity. See EN 300 175-6 [5].

7.2.3.7 Multiframe number

7.2.3.7.1 General, $Q_H = 6$ (hex)

Every RFP that supports encryption shall transmit this message at least once every 8 multiframes.

All PTs that support encryption shall understand this message (see figure 7.14).

Q_H				(spare)		multiframe number	
0	1	1	0	1111 0000 1111			
a ₈		a ₁₁		a ₁₂	a ₂₃	a ₂₄	a ₄₇

Figure 7.14: Multiframe number

7.2.3.7.2 Multiframe number

This is the number of the multiframe, modulo 2_{24} . The least significant bit of the multiframe number is placed in bit position a₄₇.

If encryption is supported, the multiframe number shall be the same across the whole of a DECT FP.

7.2.3.8 Escape

7.2.3.8.1 General, $Q_H = 7$ (hex)

The transmission of this message is optional.

Any DECT RFP may transmit an escape message. See figure 7.15.

Q_H				escape			
0	1	1	1	information			
a_8		a_{11}		a_{12}			a_{47}

Figure 7.15: Escape

7.2.3.8.2 Escape information

The content of the escape information field (a_{12} to a_{47}) is not specified. This message is provided for application specific use.

7.2.4 Paging Tail (P_T)

7.2.4.1 General format

7.2.4.1.1 P_T format for full and long page messages

P_T		36 bits of BS-channel data					
header							
a_8	a_{11}	a_{12}					a_{47}

Figure 7.16: ??

7.2.4.1.2 P_T format for short page messages

P_T		20 bits of			info		MAC Layer	
header		BS-channel data			type		information	
a_8	a_{11}	a_{12}		a_{31}	a_{32}	a_{35}	a_{36}	a_{47}

Figure 7.17: ??

7.2.4.1.3 P_T format for zero length page messages

P_T		20 least significant			info		MAC Layer	
header		bits of RFPI			type		information	
a_8	a_{11}	a_{12}		a_{31}	a_{32}	a_{35}	a_{36}	a_{47}

Figure 7.18: ??

7.2.4.1.4 P_T format for MAC_resume page message

P_T		PMID (20 bits)		ECN		Spare	
Header=x011							
a_8	a_{11}	a_{12}	a_{31}	a_{32}	a_{35}	a_{36}	a_{47}

Figure 7.19: Pt format for MAC_resume page message

Table 7.17: Values used within MAC resume page message format

MAC message	Field within the message	Standard values within the MAC message	Normative action/comment
<<Pt MAC resume page format>>			
	<Pt-header extend flag > (a8)	0,1	a8=1 means another page message shall start in the next frame in this multiframe that is permitted to contain a Pt type.
	<BS SDU length indication> (a9 - a11)	011	MAC resume page
	<PMID>(a12 - a31)	All	PMID
	<ECN> (a32-a35)	All	Exchanged connection number
	(a36 - a47)	1111 1111 1111	Spare

7.2.4.2 P_T header format

7.2.4.2.1 General format

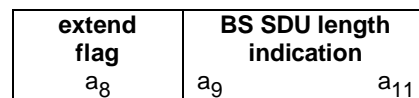
**Figure 7.20**

7.2.4.2.2 Bit a₈ is the extend flag

a₈ = 0: the next occurrence of a normal page shall be in a frame 0.

a₈ = 1: another page message shall start in the next frame in this multiframe that is permitted to contain a PT type tail.

7.2.4.2.3 BS SDU length indication

Table 7.18

a ₉	a ₁₀	a ₁₁	Length indication
0	0	0	zero length page
0	0	1	short page
0	1	0	full page
0	1	1	MAC resume page
1	0	0	not the last 36 bits of a long page
1	0	1	the first 36 bits of a long page
1	1	0	the last 36 bits of a long page
1	1	1	all of a long page (first and last)

On receipt of the MAC resume paging message the PT shall start bearer establishment by sending a B_field Bearer_Request (advanced, ECN= the true ECN related to the connection to be resumed, i.e. the ECN received in the MAC resume page message).

7.2.4.3 MAC layer information for PT

7.2.4.3.1 Information type

Table 7.19

a32	a33	a34	a35	Information type
0	0	0	0	fill bits (note)
0	0	0	1	blind full slot information for circuit mode service
0	0	1	0	other bearer
0	0	1	1	recommended other bearer
0	1	0	0	good RFP bearer
0	1	0	1	dummy or C/L bearer position
0	1	1	0	Reserved
0	1	1	1	escape
1	0	0	0	dummy or C/L bearer marker
1	0	0	1	bearer handover/replacement information
1	0	1	0	RFP status and modulation types
1	0	1	1	active carriers
1	1	0	0	C/L bearer position
1	1	0	1	RFP power level
1	1	1	0	blind double slot / RFP-FP interface resource information
1	1	1	1	blind full slot information for packet mode service

NOTE: This information type should be avoided in new developments, to allow this code to be re-used in future standard maintenance. Sending Fill bits can be avoided by sending other information, for example Other Bearer information.

7.2.4.3.2 Fill bits

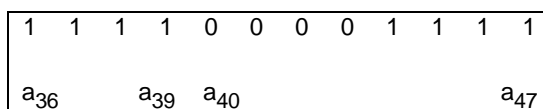

Figure 7.21

7.2.4.3.3 Blind full slot information

The blind full slot information for circuit mode service is intended for voice and streaming data services, to indicate which slots are available and which slots reserved. The blind full slot information for data mode service is intended for bursty and otherwise non-continuous services. These two messages have equal format of the blind slot mask, see figure 7.22 below. The two masks can be used to separate the different services, minimizing disturbances to each other. The data mode service may be further subdivided using channel list messages to separate the symmetric from the asymmetric services, because the last may cause even more disturbance on the timeslots where it is allowed.

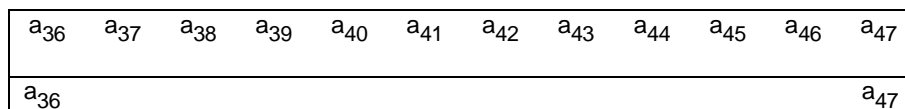

Figure 7.22: Blind Full Slot Information

For a_x with 36 ≤ x ≤ 47:

if a_x = 1: then full slot pair {(x-36),(x-24)} is not "blind", i.e. available;

else (a_x = 0) full slot pair {(x-36),(x-24)} is "blind", i.e. not available.

NOTE: The blind slot information applies to the same slot number of all available carriers.

7.2.4.3.4 Bearer description

These codings are used to provide bearer information and consist of the following information types:

- other bearer;
- recommended other bearer;
- good RFP bearer;
- dummy or connectionless bearer position; and
- connectionless bearer position.

The meaning of the messages are, however, different:

- "other bearer" means that this RFP has a bearer on the physical channel pair that is described in the remaining 12 bits;
- "recommended other bearer" means that this RFP has another bearer on the physical channel pair that is described in the remaining 12 bits. This message shall not be sent unless the bearer that it is sent on will be released in less than or equal to 4 multiframes;

NOTE 1: The bearer referred to in "other bearer" and "recommended other bearer" can mean any types of bearers indicated in clause 5.5.2.

- "good RFP bearer" means that this RFP thinks that the physical channel pair described in the remaining 12 bits is a good bearer for the PT to use to set up a bearer with that RFP;
- "dummy or C/L bearer position" describes a dummy bearer position and/or marks the position of the bearer which is used for the downlink connectionless service;

NOTE 2: The "fixed part capabilities message" (see clause 7.2.3.4) defines whether it is prohibited to setup a traffic bearer on this pair of physical channels.

- "C/L bearer position" describes the position of a bearer which is used for the downlink connectionless service.

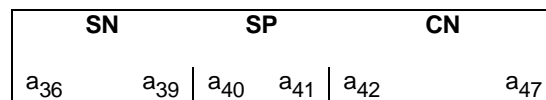

Figure 7.23: SP, SN and CN fields

The coding of SP, SN, and CN are the same as in the "static system information" described in clause 7.2.3.2. See figure 7.23 above.

7.2.4.3.5 Escape

Any DECT RFP may transmit an escape message.

The content of the escape information field (a₃₆ to a₄₇) is not specified. This message is provided for proprietary extensions.

7.2.4.3.6 Dummy or connectionless downlink bearer marker

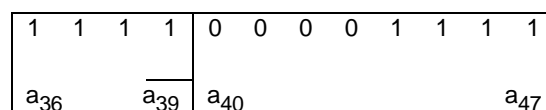

Figure 7.24

This message shall only be transmitted on a dummy bearer or on a connectionless downlink bearer.

7.2.4.3.7 Bearer handover/replacement information

info type		parameter	
a ₃₆	a ₃₉	a ₄₀	a ₄₇

Figure 7.25

Table 7.20

Info type	Parameter	Meaning
0 0 0 0	0 0 0 0 1 1 1 1	no bearer handover/replacement to other RFPs no intracell bearer handover/replacement
0 0 0 1	0 0 0 0 1 1 1 1	no bearer handover/replacement to other RFPs intracell bearer handover/replacement supported
0 0 1 0	0 0 0 0 1 1 1 1	bearer handover/replacement supported in whole internal handover area (see EN 300 175-6 [5])
0 0 1 1	bit mask	bearer handover/replacement supported to all RFPs with an RFPI that differs only in the masked bits, see below
0 1 0 0 to 1 1 1 1	} } reserved	reserved
Info type "0011": Bit mask		

The transmitted bit mask serves to test the RFPI of any (new) RFP to determine if a bearer handover/replacement is possible to that new RFP. Bearer handover/replacement to this RFP is only possible if the RFPI of that new RFP only differs from the old (current) RFPI in one or more of the bit positions identified by a "0" in the bit mask. In all cases, the bit mask shall be aligned to the last octet of the RFPI.

NOTE: The RFPI is obtained from the N_T message, (see clause 7.2.2).

EXAMPLE: A bit mask "1111 1000" will allow a bearer handover/replacement to all RFPs with an RFPI that differs only in the last three bits from the RFPI of the current RFP.

Single cell DECT FPs (i.e. only one RFP) shall not broadcast other bearer handover information than info type "0000" and info type "0001".

7.2.4.3.8 RFP status and modulation types

RFP status		Modulation types			
		A-field	(B+Z)-fields		
a ₃₆	a ₃₉	a ₄₀	a ₄₃	a ₄₄	a ₄₇

Figure 7.26

Table 7.21

RFP status	Meaning
xxx0	RFP clear for speech
xxx1	RFP busy for speech (note 1)
xx0x	system clear
xx1x	system busy (note 2)
x0xx	asynchronous FP not available
x1xx	asynchronous FP available (note 3)
0xxx	RFP clear for data
1xxx	RFP busy for data (note 4)
NOTE 1: "RFP busy for speech" means that the RFP recommends PPs not to send access_request messages for speech towards this RFP.	
NOTE 2: "system busy" means that the FP recommends PPs not to send access_request messages towards this FP.	

NOTE 3: "asynchronous FP available" means that a PP can expect to find an alternative FP not synchronized to its actual FP and which the PP has access rights to.
NOTE 4: "RFP busy for data" means that the RFP recommends PPs not to send access request messages for data towards this RFP.
NOTE 5: "RFP busy for speech/data" is a suggested indication for RFP that do not support speech/data, but are active in a FP which supports this feature. Typical use of "busy for data" is a WRS with speech only.

Bits a_{44} to a_{47} define the modulation schemes supported in the (B+Z)-fields, in addition to the default one (see note).

Table 7.22

a_{44} a_{45} a_{46} a_{47}	(B+Z)-fields modulation scheme
X X X 1	2-level modulation supported
X X X 0	2-level modulation not supported
X X 1 X	4-level modulation not supported
X X 0 X	4-level modulation supported
X 1 X X	8-level modulation not supported
X 0 X X	8-level modulation supported
0 X X X	reserved
1 1 1 0	escape
1 1 1 1	previous "spare" code: only 2-level modulation supported.
The "escape" coding means a proprietary modulation scheme	

Bits a_{40} to a_{43} define the modulation schemes supported in the A-field, in addition to the default one.

Table 7.23

a_{40} a_{41} a_{42} a_{43}	A-field modulation scheme
X X X 1	2-level modulation not supported
X X X 0	2-level modulation supported
X X 1 X	4-level modulation supported
X X 0 X	4-level modulation not supported
X 1 X X	8-level modulation supported
X 0 X X	8-level modulation not supported
1 X X X	reserved
0 0 0 1	escape
0 0 0 0	previous "spare" code: only 2-level modulation supported.
The "escape" coding means a proprietary modulation scheme	

NOTE: The "default" modulation scheme is profile dependant.

7.2.4.3.9 Active carriers

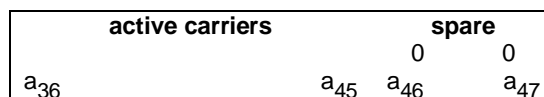

Figure 7.27

For a_x , with $36 \leq x \leq 45$:

if $a_x = 0$ then RFP is not transmitting on carrier (x-36);

if $a_x = 1$ then RFP is active transmitting on carrier (x-36);

Bits a_{46} and a_{47} are spare.

7.2.4.3.10 RFP power level

RFP power		Fading margin		FP/RFP specific	reserved for future development	
a ₃₆	a ₃₉	a ₄₀	a ₄₃	a ₄₄	a ₄₅	a ₄₇

Figure 7.28

Procedures for utilizing the RFP power message of figure 7.28 are defined in EN 300175-2 [2], Annex E.

The coding of bits a₃₆ to a₃₉ is shown in table 7.24.

Table 7.24: RFP power message

a ₃₆	a ₃₇	a ₃₈	a ₃₉	RFP power, Pr
1	1	1	1	30 dBm
1	1	1	0	28 dBm
1	1	0	1	26 dBm
		..etc..		..etc..
0	0	0	1	2 dBm
0	0	0	0	0 dBm

The RFP power Pr is the NTP and is derived by multiplying the 4 bit (a₃₆ to a₃₉) binary presented number by 2.

The coding of bits a₄₀ to a₄₃ is shown in table 7.25.

Table 7.25: Fading margin

a ₄₀	a ₄₁	a ₄₂	a ₄₃	Fading margin, MF
1	1	1	1	20 dB
1	1	1	0	19 dB
		..etc..		..etc..
0	0	1	0	7 dB
0	0	0	1	6 dB
0	0	0	0	5 dB

The fading margin MF is derived by adding 5 to the 4 bit (a₄₀ to a₄₃) binary presented number.

The RFP/FP specific bit a₄₄ = 1 indicates that each RFP may have different Pr and/or MF values. a₄₄ = 0 indicates that all RFPs within the FP have the same values on Pr and MF.

7.2.4.3.11 Blind double slot / RFP-FP interface resource information

blind double slot information		fs units on RFP-FP i/f	ds units on RFP-FP i/f
a ₃₆	a ₄₁	a ₄₂	a ₄₅
		a ₄₄	a ₄₇

Figure 7.29

For a_x with $36 \leq x \leq 41$:

- if $a_{36} = 1$ then double slot pair $K = 0/12$ (full slot pair $\{(x-36)/(x-35), (x-24)/(x-23)\}$) is not "blind", i.e. available; else double slot pair $K = 0/12$ is "blind";
- if $a_{37} = 1$ then double slot pair $K = 2/14$ (full slot pair $\{(x-35)/(x-34), (x-23)/(x-22)\}$) is not "blind", i.e. available; else double slot pair $K = 2/14$ is "blind";
- if $a_{38} = 1$ then double slot pair $K = 4/16$ (full slot pair $\{(x-34)/(x-33), (x-22)/(x-21)\}$) is not "blind", i.e. available; else double slot pair $K = 4/16$ is "blind";
- if $a_{39} = 1$ then double slot pair $K = 6/18$ (full slot pair $\{(x-33)/(x-32), (x-21)/(x-20)\}$) is not "blind", i.e. available; else double slot pair $K = 6/18$ is "blind";
- if $a_{40} = 1$ then double slot pair $K = 8/20$ (full slot pair $\{(x-32)/(x-31), (x-20)/(x-19)\}$) is not "blind", i.e. available; else double slot pair $K = 8/20$ is "blind";
- if $a_{41} = 1$ then double slot pair $K = 10/22$ (full slot pair $\{(x-31)/(x-30), (x-19)/(x-18)\}$) is not "blind", i.e. available; else double slot pair $K = 10/22$ is "blind".

NOTE 1: The blind double slot information applies to the same slot number of all available carriers.

NOTE 2: Double slots are numbered $K = 0$ to 22 for even values of K according to EN 300 175-2 [2].

For a_x with $42 \leq x \leq 44$:

Table 7.26

a_{42}	a_{43}	a_{44}	number of available full slot units on RFP-FP interface
0	0	0	0
0	0	1	1
0	1	0	2
0	1	1	3
1	0	0	4
1	0	1	5
1	1	0	6
1	1	1	≥ 7

For a_x with $45 \leq x \leq 47$:

Table 7.27

a_{45}	a_{46}	a_{47}	number of available double slot units on RFP-FP interface
0	0	0	0
0	0	1	1
0	1	0	2
0	1	1	3
1	0	0	4
1	0	1	5
1	1	0	≥ 6

7.2.5 MAC control (M_T)

7.2.5.1 General format and contents

Two different combinations of TA bits are used to indicate the presence of MAC layer control information in the tail. The "first PT transmission" code is used only in the first transmission from a PT. This is intended to aid RFPs in busy systems to identify bearer set up requests amongst a background of ongoing connections.

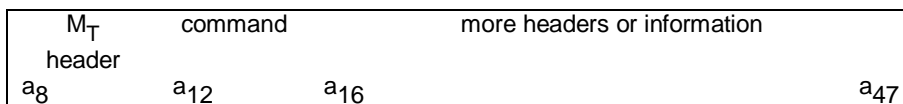

Figure 7.30: M_T messages

M_T messages (see figure 7.30 above) are sent as 40 bit packets in the tail of the A-field. The first 4 bit header provides a coarse division of messages and for most message types a second header, completing the first octet, provides a finer division of the messages.

Table 7.28

M_T header	Message type
0 0 0 0	basic connection control
0 0 0 1	advanced connection control
0 0 1 0	MAC layer test messages
0 0 1 1	quality control
0 1 0 0	broadcast and connectionless services
0 1 0 1	encryption control
0 1 1 0	Tail for use with the first transmission of a B-field "bearer request" message
0 1 1 1	escape
1 0 0 0	TARI message
1 0 0 1	REP connection control
1 0 1 0	}
to	}
	reserved
1 1 1 1	}

7.2.5.2 Basic connection control

7.2.5.2.1 General

The basic connection control messages shall only be used by PPs and RFPs that are attempting to establish a single duplex bearer voice connection with a B-field of 324 bits.

7.2.5.2.2 Format for most messages

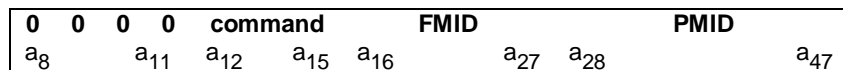

NOTE: For definitions of FMID, PMID, see clause 11.7.

Figure 7.31

Table 7.29

Command	Basic connection control messages	
0 0 0 0	access_request	**
0 0 0 1	bearer_handover_request	**
0 0 1 0	connection_handover_request	**
0 0 1 1	unconfirmed_access_request	**
0 1 0 0	bearer_confirm	
0 1 0 1	wait (format see clause 7.2.5.2.3)	
0 1 1 0	attributes_T_request	
0 1 1 1	attributes_T_confirm	
1 0 0 0	} reserved	
to		
1 1 1 0	}	
1 1 1 1	release	
** indicates messages that use the "first PT transmission" code. The other messages use the normal M _T code.		

This release message shall only refer to the bearer that it is transmitted on.

NOTE 1: An RFP that receives an UNCONFIRMED_ACCESS_REQUEST message does not return a BEARER_CONFIRM. It may listen to following frames to receive MAC attributes messages or data.

NOTE 2: The use of the UNCONFIRMED_ACCESS_REQUEST message is intended here for achieving handover by changing base stations but remaining on the same physical channel. The use of this message in basic cases is still uncertain.

NOTE 3: Fast bearer set up requests are not allowed in basic A-field setups.

The FT may use the messages indicated with ** without the "first PT transmission" code.

7.2.5.2.3 WAIT

0 0 0 0	0 1 0 1	FMID	PMID or spare (1111 0000 1111 0000 1111)				
a ₈	a ₁₁	a ₁₂	a ₁₅	a ₁₆	a ₂₇	a ₂₈	a ₄₇

NOTE: The procedure does not make reference to the values of a₁₆ to a₄₇. It is not intended that the contents of this field be included in any mandatory tests.

Figure 7.32

7.2.5.2.4 ATTRIBUTES_T_{Req;Cfm}

0000	011	R/C	ECN	LBN	up/down/sm/ss	ser type	max life	slot type	CF	(spare)	(spare)	A-field mod type	(B+Z) fields mod. type									
a ₈	a ₁₁	a ₁₂	a ₁₅	a ₁₆	a ₁₉	a ₂₀	a ₂₃	a ₂₄	a ₂₅	a ₂₆	a ₂₈	a ₂₉	a ₃₁	a ₃₂	a ₃₅	a ₃₆	a ₃₇	a ₃₉	a ₄₀	a ₄₃	a ₄₄	a ₄₇

Figure 7.33

For all the parameter codings see clause 7.2.5.3.8.

7.2.5.3 Advanced connection control

7.2.5.3.1 General

Table 7.30

Command	Advanced connection control messages	
0 0 0 0	ACCESS_REQUEST	**
0 0 0 1	bearer_handover_request	**
0 0 1 0	connection_handover_request	**
0 0 1 1	unconfirmed_access_request	**
0 1 0 0	bearer_confirm	
0 1 0 1	wait (contains FMID)	
0 1 1 0	attributes_T_request	
0 1 1 1	attributes_T_confirm	
1 0 0 0	bandwidth_T_request	
1 0 0 1	bandwidth_T_confirm	
1 0 1 0	channel_list	
1 0 1 1	unconfirmed_dummy	**
1 1 0 0	unconfirmed_handover	**
1 1 0 1	reserved	
1 1 1 0	reserved	
1 1 1 1	release	

** indicates messages that, if transmitted by a PT, use the "first PT transmission" code.

These messages allow an advanced connection to be established using M_T messages. The connection set up time is expected to be much longer than if MAC control messages are sent in the B-field.

The FT may use the messages indicated with ** without the "first PT transmission" code.

7.2.5.3.2 ACCESS_REQUEST

0 0 0 1	0 0 0 0	FMID	PMID				
a_8	a_{11}	a_{12}	a_{15}	a_{16}	a_{27}	a_{28}	a_{47}

Figure 7.34

7.2.5.3.3 BEARER_HANDOVER_REQUEST

0 0 0 1	0 0 0 1	FMID	PMID				
a_8	a_{11}	a_{12}	a_{15}	a_{16}	a_{27}	a_{28}	a_{47}

Figure 7.35

7.2.5.3.4 CONNECTION_HANDOVER_REQUEST

0 0 0 1	0 0 1 0	FMID	PMID				
a_8	a_{11}	a_{12}	a_{15}	a_{16}	a_{27}	a_{28}	a_{47}

Figure 7.36

7.2.5.3.5 UNCONFIRMED_ACCESS_REQUEST

0	0	0	1	0	0	1	1	FMID	PMID			
a ₈		a ₁₁		a ₁₂		a ₁₅		a ₁₆	a ₂₇	a ₂₈		a ₄₇

NOTE: An RFP or a PP that receives an UNCONFIRMED_ACCESS_REQUEST message does not return a confirm. It may listen to following frames to receive MAC attributes messages or data.

Figure 7.37

7.2.5.3.6 BEARER_CONFIRM

0	0	0	1	0	1	0	0	FMID	PMID			
a ₈		a ₁₁		a ₁₂		a ₁₅		a ₁₆	a ₂₇	a ₂₈		a ₄₇

Figure 7.38

7.2.5.3.7 WAIT

0	0	0	1	0	1	0	1	FMID	PMID or spare (1111 0000 1111 0000 1111)			
a ₈		a ₁₁		a ₁₂		a ₁₅		a ₁₆	a ₂₇	a ₂₈		a ₄₇

NOTE: The procedure does not make reference to the values of a₁₆ to a₄₇. It is not intended that the contents of this field be included in any mandatory tests.

Figure 7.39

7.2.5.3.8 ATTRIBUTES_T_{Req;Cfm}

		R/C	ECN	LBN	up/down/sm/ss	ser type	max life	slot type	CF	(spare)	(spare)	A-field mod type	(B+Z) fields mod. type									
0001	011									111	0000	11	11									
a ₈	a ₁₁	a ₁₂	a ₁₅	a ₁₆	a ₁₉	a ₂₀	a ₂₃	a ₂₄	a ₂₅	a ₂₆	a ₂₈	a ₂₉	a ₃₁	a ₃₂	a ₃₅	a ₃₆	a ₃₇	a ₃₉	a ₄₀	a ₄₃	a ₄₄	a ₄₇

Figure 7.40

Table 7.31

R/C	Meaning
0	request
1	confirm

ECN: Exchanged Connection Number. LBN: Logical Bearer Number.

Table 7.32

up/down/sm/ss a ₂₄	a ₂₅	Meaning
0	0	asymmetric uplink connection
0	1	asymmetric downlink connection
1	0	symmetric multibearer connection
1	1	symmetric single bearer connection

Table 7.33

Ser type		service type	
0	0	0	I _N voice
0	0	1	I _N non-voice
0	1	0	I _P error detection
0	1	1	I _P , MAC modulo-2
1	0	0	unknown
1	0	1	C-channel only
1	1	0	I _{PQ} error detection
1	1	1	I _{PQ} MAC modulo 2 error correction

max life: unless the service type is I_P_error_correction, this parameter is set to 000.

For I_P_error_correction services this parameter determines the maximum lifetime of the packet (i.e. the latest possible retransmission) in the MAC layer (1 to 7 TDMA frames); "max life" = 000 indicates that no lifetime is set, i.e. retransmit until received without error.

NOTE 1: If in the future, the reserved connection types are used, the "max life" field may also be used (potentially for another purpose).

Table 7.34

slot type		Meaning		
0	0	0	0	normal full slot
0	0	0	1	half slot with j = 0
0	0	1	0	double slot
all others				reserved

CF = 0: this endpoint does not support CF transmission;

CF = 1: this endpoint does support CF transmission.

NOTE 2: If the slot type or j value is not implementable at the destination, a release is sent, preferably with the "reasons for release" field completed.

Table 7.35

A-field modulation type		meaning	
1	1	2-level modulation	
1	0	4-level modulation	
0	1	8-level modulation	
all other values		reserved	

Table 7.36

(B+Z)-fields modulation type		meaning	
1	1	2-level modulation	
1	0	4-level modulation	
0	1	8-level modulation	
all other values		reserved	

7.2.5.3.9 BANDWIDTH_T_{Req;Cfm}

0 0 0 1	1 0 0	R / C	0 0 0 (spare)	M _{Up}	0 0 0 (spare)	T _{Up}	0 0 0 (spare)	M _{Down}	0 0 0 (spare)	T _{Down}									
a ₈	a ₁₁	a ₁₂	a ₁₅	a ₁₆	a ₁₈	a ₁₉	a ₂₃	a ₂₄	a ₂₆	a ₂₇	a ₃₁	a ₃₂	a ₃₄	a ₃₅	a ₃₉	a ₄₀	a ₄₂	a ₄₃	a ₄₇

Figure 7.41

NOTE: This message is not needed for symmetric single duplex bearer connections.

R/C: see clause 7.2.5.3.8.

M_{Up}, M_{Down}: these are the minimum numbers of simplex bearers required by the DLC in, respectively, the PT to FT and the FT to PT directions.

T_{Up}, T_{Down}: these are the target numbers of simplex bearers in, respectively, the PT to FT and the FT to PT directions.

7.2.5.3.10 Channel_list

0 0 0 1	1 0 1 0	RPN	command and channel description				spare	
a ₈	a ₁₁	a ₁₅	a ₁₆	a ₂₃	a ₂₄	a ₃₉	a ₄₀	a ₄₇

Figure 7.42

Command and channel description

command	S / D	SN	SP	CN	
c ₀	c ₂ c ₃	c ₄	c ₇ c ₈	c ₉ c ₁₀	c ₁₅

Figure 7.43

Table 7.37

command field	message type
0 0 0	ACTIVE
0 0 1	GOOD
0 1 0	POOR
0 1 1	F/S_NOT
1 0 0	QUERY_N
1 0 1	QUERY_H
1 1 0	LISTEN
1 1 1	START
NOTE: The meanings of these message types are described in clause 10.5.2.	

For all messages except the F/S_NOT channel list message:

S/D = 0: double simplex bearer; or

S/D = 1: duplex bearer.

NOTE: The direction of asymmetry, and slot type are contained in the MAC_attributes messages or in the B-field bearer request message.

For the F/S_NOT message:

S/D = 0: carrier "CN" not supported (no setup on this carrier);

S/D = 1: blind slot pair "SP" (no setup on this slot pair).

The coding of SP, SN, and CN are the same as in the static system information described in clause 7.2.3.2.

7.2.5.3.11 Unconfirmed_dummy

0	0	0	1	1	0	1	1	FMID	PMID
a ₈	a ₁₁	a ₁₂	a ₁₅	a ₁₆	a ₂₇	a ₂₈			a ₄₇

Figure 7.44

7.2.5.3.12 Unconfirmed_handover

0	0	0	1	1	1	0	0	FMID	PMID
a ₈	a ₁₁	a ₁₂	a ₁₅	a ₁₆	a ₂₇	a ₂₈			a ₄₇

Figure 7.45

7.2.5.3.13 RELEASE

0	0	0	1	1	1	1	1	0	0	0	0	LBN	reason	PMID
(spare)														
a ₈								a ₁₆	a ₂₀	a ₂₄	a ₂₈			a ₄₇
			a ₁₅					a ₁₉	a ₂₃	a ₂₇				

Figure 7.46

NOTE: LBN refers to the bearer that is to be released. This message can be sent on a different bearer of the same connection to the one that is to be released.

Table 7.38

reason				Reason for release
a ₂₄	a ₂₅	a ₂₆	a ₂₇	
0	0	0	0	unknown
0	0	0	1	bearer release (reduce capacity)
0	0	1	0	connection release
0	0	1	1	bearer setup or handover failed
0	1	0	0	bearer handover successfully completed
0	1	0	1	attempted bearer HO to another cluster
0	1	1	0	timeout, loss of signal
0	1	1	1	timeout, loss of handshake
1	0	0	0	requested unacceptable slot type
1	0	0	1	requested unacceptable MAC service
1	0	1	0	base station busy
1	0	1	1	reverse direction (double simplex)
1	1	0	0	duplicate PMID
1	1	0	1	unacceptable PMID
1	1	1	0	reserved
1	1	1	1	reserved

NOTE: "bearer handover successfully completed" is only intended for use in some double simplex release.

7.2.5.4.3 LOOPBACK_DATA

This message instructs the IUT to perform the loopback function in which a test data pattern transmitted by the LT is replicated in the reply transmission of the IUT. The test data pattern is a bit sequence located in the D-fields of the LT and IUT. The bits of the D-field that are affected by the loopback function depends on the equipment type and are given in table 7.40.

Table 7.40: LOOPBACK_DATA bits

DECT Implementation	Loopback bits
Transmits only A-field:	a ₁₆ to a ₄₇
Transmits half-slots:	b ₀ to b ₇₉
Transmits full-slots:	b ₀ to b ₃₁₉
Transmits double-slots:	b ₀ to b ₇₉₉

Equipment capable of transmitting more than one slot type shall use the longest slot type.

For A-field loopback, the format of the LOOPBACK_DATA test message is given in figure 7.49.

				Loopback data (A-field)											
0	0	1	0	0	0	0	1	XXXX	XXXX	XXXX	XXXX	XXXX	XXXX	XXXX	XXXX
a ₈		a ₁₁		a ₁₂		a ₁₅		a ₁₆							a ₄₇

NOTE: 'X' is the data looped back to the tester.

Figure 7.49: LOOPBACK_DATA test message, A-field

For B-field loopback, the format of the LOOPBACK_DATA test message is given in figure 7.50.

				spare											
0	0	1	0	0	0	0	1	0000	1111	0000	1111	0000	1111	0000	1111
a ₈		a ₁₁		a ₁₂		a ₁₅		a ₁₆							a ₄₇

Figure 7.50: LOOPBACK_DATA test message, B-field

See clause 12.4 for the relevant procedures.

7.2.5.4.4 DEFEAT_ANTENNA_DIVERSITY

This message inhibits antenna diversity operation in the IUT and selects an antenna. The antennas shall be numbered 0 to N where (N + 1) is the number of antennas employed in the antenna diversity operation. The numbering of antennas shall be done by the manufacturer.

IUTs with no antenna diversity shall ignore this message.

IUTs receiving this message with an ANT > N shall ignore this message.

The IUT remains in this mode until the test message "CLEAR_TEST_MODES" is received.

The format of the DEFEAT_ANTENNA_DIVERSITY test message is given in figure 7.51.

				S		spare										
0	0	1	0	0	0	1	0	S	ANT	1111	0000	1111	0000	1111	0000	1111
a ₈		a ₁₁		a ₁₂		a ₁₅		a ₁₆	a ₁₉	a ₂₀						a ₄₇

Figure 7.51: DEFEAT_ANTENNA_DIVERSITY test message

NOTE: SP = spare bit = 0.

Table 7.41 details the encoding of the ANT bit.

Table 7.41: ANT bit

ANT			Antenna number
a ₁₇	a ₁₈	a ₁₉	
0	0	0	0
0	0	1	1
0	1	0	2
0	1	1	3
1	0	0	4
1	0	1	5
1	1	0	6
1	1	1	7

See clause 12.5 for the relevant procedures.

7.2.5.4.5 ESCAPE

The transmission of this message to the IUT indicates that the data in the test data field is a proprietary test message. Every transmission of a proprietary test message shall be preceded by the "escape" message. The format of the ESCAPE message is given in figure 7.52.

0 0 1 0		0 1 0 0		proprietary test message									
a ₈	a ₁₁	a ₁₂	a ₁₅	a ₁₆	XXXX	XXXX	XXXX	XXXX	XXXX	XXXX	XXXX	XXXX	a ₄₇

Figure 7.52: ESCAPE message

See clause 12.7 for the relevant procedure.

7.2.5.4.6 NETWORK_TEST

The lower layer management entity in the testing unit supplies the MAC layer with a 32 bit SDU via the ME SAP. At the unit under test, the MAC layer passes the 32 bit test message out through the ME SAP to the lower layer management entity. See EN 300 175-5 [4].

The format of the NETWORK_TEST message is given in figure 7.53.

0 0 1 0		0 1 0 1		test message									
a ₈	a ₁₁	a ₁₂	a ₁₅	a ₁₆	XXXX	XXXX	XXXX	XXXX	XXXX	XXXX	XXXX	XXXX	a ₄₇

Figure 7.53: NETWORK_TEST message

See clause 12.6 for the relevant procedure.

7.2.5.4.7 CLEAR_TEST_MODES

The receipt of this message shall clear all current test modes (including proprietary) within 16 frames and return the IUT to the test standby mode.

The format of the CLEAR_TEST_MODES message is given in figure 7.54.

0 0 1 0		1 1 1 1		spare									
a ₈	a ₁₁	a ₁₂	a ₁₅	a ₁₆	0000	1111	0000	1111	0000	1111	0000	1111	a ₄₇

Figure 7.54: CLEAR_TEST_MODES

See clause 12.8 for the relevant procedure.

Table 7.43

command	param_1		param_2		Meaning
0000	LBN	LBN	LBN	LBN	antenna switch for the bearer(s) identified by LBN request: PT --> FT reject: FT --> PT
0001		RPN	0000	1111	antenna switch for all bearers of this connection to the RFP identified by its RPN request: PT --> FT reject: FT --> PT
0010	0000	LBN	0000	0000 or RPN	bearer handover / bearer replacement of the bearer identified by LBN request: FT --> PT reject: PT --> FT
0010	1111	LBN	0000	0000 or RPN	bearer handover / bearer replacement of the bearer identified by LBN request: PT --> FT reject: FT --> PT
0011	0000	1111	0000	1111	connection handover request: FT --> PT reject: PT --> FT
0100	0000	LBN	frequency error		frequency control for the bearer identified by LBN request: FT --> PT reject: PT --> FT
0101		RPN	frequency error		frequency control for all bearers of this connection to the RFP identified by its RPN request: FT --> PT reject: PT --> FT
0110		RPN	advance timing increment decrement		Advance timing for all the bearers of this connection to the RFP identified by its RPN request: FT --> PT reject: PT --> FT
0111		RPN	0000	1111	PT --> FT: PT informs that it is transmitting prolonged preamble in all the frames
1000	0000	SN	0000	CN	frequency replacement to carrier CN on slot pair SN. request PT -> FT confirm FT -> PT
1000	0001	SN	0000	CN	frequency replacement to carrier CN on slot pair SN. grant PT -> FT
1001 to 1111					reserved

NOTE 1: The function of these commands depends on the transmission direction. The commands are either requests or rejects. A reject should only be used if the requested action is not supported.

NOTE 2: For basic connections LBN is set to 1111.

NOTE 3: All other values for bits a_{16} to a_{47} inclusive are reserved. Potential uses include RSSI reporting, synchronization word correlation report, clock jitter report, etc.

NOTE 4: For the bearer handover request, the RPN is an optional parameter. If set to all "0" the FP does not propose a particular RFP for handover.

NOTE 5: A PP may or may not accept the RFP's proposal of the new RPN.

NOTE 6: The frequency error in kHz is encoded in 2's complement form, to give a range of +127 kHz to -128 kHz. The LSB of the error is placed in bit position a_{31} .

NOTE 7: The advance timing changes are encoded in 2's complement form (+127 bits to -128 bits). The LSB of the advance timing is placed in position a_{31} . Changes with less than 2 bits should not be requested.

NOTE 8: The bearer handover request command in the PT to FT direction is used in the double simplex bearer handover procedure.

7.2.5.5.1 Prolonged preamble diversity

7.2.5.5.1.1 Procedure for prolonged preamble diversity in RFP

This procedure applies to RFPs that use the prolonged preamble for diversity. The procedure secures that the prolonged preamble is transmitted only by the PP if it knows that the RFP uses it for diversity. The PP shall not transmit the prolonged preamble if the synchronization field options in the extended fixed part capabilities indicates standard synchronization field (see clause 7.2.3.5.2.2).

The RFP shall indicate the support for prolonged preamble in the extended fixed part capabilities only in case it is capable of using a prolonged preamble.

- 1) Immediately after the bearer setup procedure, the PP informs the RFP that it sends the prolonged preamble. This indicates that the RFP can use the prolonged preamble for diversity (see clauses 7.2.5.5 and 7.3.5.2). Repeats of this requests are allowed.

NOTE 1: The bearer setup procedure above also relates to handover.

NOTE 2: Bearer setup procedure ends when the initiating side receives the "other"- message.

- 2) All PP transmissions following the information message shall contain the prolonged preamble. The PP may send the prolonged preamble immediately after it has transmitted the prolonged preamble indication or it may transmit the prolonged preamble from the bearer request onwards.

7.2.5.5.1.2 Procedure for prolonged preamble diversity in PP

This procedure applies to PPs that use the prolonged preamble for diversity. The procedure secures that the prolonged preamble is not transmitted by the RFP if it the synchronization field options in the extended fixed part capabilities indicates standard synchronization field (see clause 7.2.3.5.2.2).

- 1) The RFP shall transmit a prolonged preamble for automatic antenna selection by the PP if and only if it indicates the support for prolonged preamble in the extended fixed part capabilities.
- 2) The PP does not need to take further control actions, it can enable automatic antenna selection based on prolonged preamble as long as the extended fixed part capabilities indicate the support of this feature.

7.2.5.6 Broadcast and connectionless services

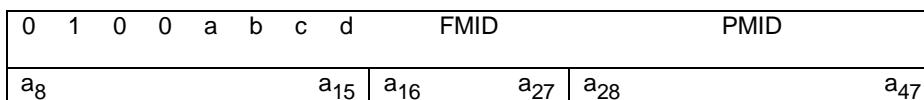

Figure 7.57

Table 7.44

a	b	c	d	Meaning
0	0	0	0	CL _F , first of 2 transmissions, half slot
0	0	0	1	CL _F , first of 2 transmissions, full slot
0	0	1	0	CL _F , first of 2 transmissions, double slot
0	0	1	1	Reserved
0	1	0	0	CL _F , last transmission, half slot
0	1	0	1	CL _F , last transmission, full slot
0	1	1	0	CL _F , last transmission, double slot
0	1	1	1	Reserved
1	0	0	0	C/L single transmission, no CL _F or CL _S service
1	0	0	1	CL _S service, first transmission
1	0	1	0	Reserved
1	0	1	1	Reserved
1	1	0	0	change dummy bearer position
1	1	0	1	Reserved
1	1	1	0	Extended System Information; A-field procedure
1	1	1	1	Extended System Information; B-field procedure

The "extended system information" messages are the only messages used in both directions. All other messages are sent only in direction PT to FT.

Connectionless single transmission uplink services:

abcd = 01xx: CL_F service;

abcd = 1000: PMID exchange (no CL-channel data).

Connectionless double transmission uplink services:

abcd = 00xx followed by abcd = 01xx: CL_F service;

abcd = 1001 followed by a C_T tail: CL_S service.

Non-continuous broadcast services:

abcd = 1100: change dummy bearer position;

abcd = 111x: extended system information: this message shall be used for requests and replies of extended system information (see clause 9.3.1).

7.2.5.7 Encryption control

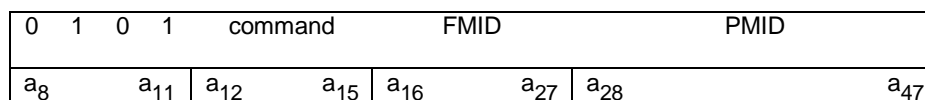

Figure 7.58

Table 7.45

command	Message
0 0 x x	start encryption
0 1 x x	stop encryption
1 0 x x	reserved
1 1 x x	reserved
x x 0 0	request
x x 0 1	confirm
x x 1 0	grant
x x 1 1	reserved

7.2.5.8 B-field setup, first PT transmission

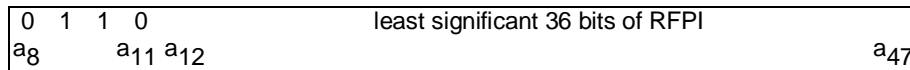

Figure 7.59

This message shall only be used for the first transmission on a new physical channel and only by PTs.

7.2.5.9 Escape

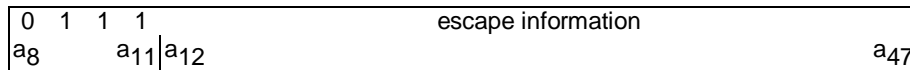

Figure 7.60

Any DECT equipment may transmit an escape message.

The content of the escape information field (a₃₆ to a₄₇) is not specified. This message is provided for application specific use.

7.2.5.10 TARI message

The message is assumed to be a "request" when transmitted in direction PT to FT, and to be a "reply" when transmitted in direction FT to PT.



Figure 7.61

The management entity in the transmitting radio endpoint supplies the MAC layer with a 36-bit SDU via the ME SAP. At the receiving endpoint the MAC layer passes the 36-bit SDU out through the ME SAP to the management entity.

For the coding of the TARI field refer to EN 300 175-6 [5].

7.2.5.11 REP connection control

7.2.5.11.1 General

The REP connection control messages shall be used to establish a duplex bearer and to create a double duplex bearer.

7.2.5.11.2 Format for most messages

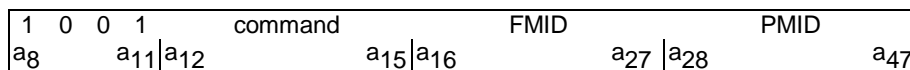

NOTE: For definitions of FMID and PMID, see clause 11.7.

Figure 7.62

Table 7.46

command	REP connection control messages	
0 0 0 0	REP_access_request	*
0 0 0 1	REP_bearer_handover_request	*
0 1 0 0	REP_bearer_confirm	
0 1 0 1	REP_wait	
1 1 1 1	REP_release	
0 1 1 0	REP_channel_map_request	
0 1 1 1	REP_channel_map_confirm	
1 0 0 0		
	to reserved	
1 1 1 1		
*	indicates messages that use the first "PT transmission" code. Other messages use the normal M _T code.	

For REP_channel_map.req and REP_channel_map.cfm messages the format is defined in figures 7.63 and 7.64.

7.2.5.11.3 REP CHANNEL MAP REQUEST

1	0	0	1	0	1	1	0	SN	CN	FMID	SN	CN	
a ₈	a ₁₁	a ₁₂	a ₁₅	a ₁₆	a ₁₉	a ₂₀	a ₂₅	a ₂₆	a ₃₇	a ₃₈	a ₄₁	a ₄₂	a ₄₇

Figure 7.63: REP_channel_map.req

7.2.5.11.4 REP CHANNEL MAP CONFIRM

1	0	0	1	0	1	1	1	SN	CN	A/R	spare 000111110000	SN	CN	
a ₈	a ₁₁	a ₁₂	a ₁₅	a ₁₆	a ₁₉	a ₂₀	a ₂₅	a ₂₆	a ₂₇	a ₃₇	a ₃₈	a ₄₁	a ₄₂	a ₄₇

Figure 7.64: REP_channel_map.cfm

The coding of SN and of CN is the same as in "static system information" described in clause 7.2.3.2. The A/R flag set to 1 means "Accepted", otherwise "Rejected".

7.3 Messages in the B-field

7.3.1 Overview

Messages may be carried in the B-field only when operating in the E-type multiplex (see clause 6.2.2.2). Each B-field message occupies one subfield, and different subfields will usually carry a different message. The possible arrangements of B-field messages are defined by the C-MUX algorithm defined in clause 6.2.2.3.

All B-field messages have a fixed length of 64 bits.

MAC B-field messages are used to:

- 1) set up, maintain and release bearers and connections;
- 2) provide extra flow, error and quality control in symmetric connections;
- 3) carry G_F-channel data;
- 4) transport extended system information and TARI information; and
- 5) fill the B-field if there is insufficient C_F or G_F to fill the whole of the B-field.

A M_{Bn} message is a B-field MAC layer control message sent in the Bn subfield. M_{Bn} messages are sent in 80 bit packets using the E mapping described in clause 6.2.2.2. This allows M_{Bn} messages to be compatible across all types of packets. Within the 80 bits, the format is as given in figure 7.65.

d(64+n*80)		d(143+n*80)	
MBn header		M or G_F	
16 bit CRC			
bn0	bn3	bn4	bn63
		bn64	bn79

Figure 7.65: B-field messages

"n" denotes the number of the subfield in the B-field. For the D08 field, $n = 0$, while for the D32 field $n = \{0,1,2,3\}$. The CRC calculation is described in clause 6.2.5.2.

The M_{Bn} header defines whether the message contains M or G_F -channel data and whether another M_{Bn} message follows in the next Bn subfield. In a full-slot transmission, up to 4 messages can be sent in the B-field.

Table 7.47

M_{Bn} header	Message type
X 0 0 0	reserved
X 0 0 1	advanced connection control
X 0 1 0	null
X 0 1 1	quality control
X 1 0 0	extended system information
X 1 0 1	G_F -channel data packet
X 1 1 0	reserved
X 1 1 1	escape

For half slots 2-level modulation:

$$X = 1.$$

For all other slot types and modulation levels:

X = 1: subfield $B(n+1)$ exists and contains a M_{Bn} message or subfield $B(n)$ is the last subfield in this slot;

X = 0: subfields $B(n+1)$ and all following in this slot contain C_F or CL_F data.

7.3.2 Advanced connection control

7.3.2.1 General format

X 0 0 1	command	information
bn0	bn3	bn63
		bn7
		bn8

Figure 7.66

Table 7.48

command	Advanced connection control messages	
0 0 0 0	ACCESS_REQUEST	**
0 0 0 1	bearer_handover_request	**
0 0 1 0	connection_handover_request	**
0 0 1 1	unconfirmed_access_request	**
0 1 0 0	bearer_confirm	
0 1 0 1	wait	
0 1 1 0	attributes_B_request	
0 1 1 1	attributes_B_confirm	
1 0 0 0	bandwidth_B_request	
1 0 0 1	bandwidth_B_confirm	
1 0 1 0	channel_list	
1 0 1 1	unconfirmed_dummy	**
1 1 0 0	unconfirmed_handover	**
1 1 0 1	reserved	
1 1 1 0	reserved	
1 1 1 1	release	

** indicates messages, that if transmitted by a PT, use the "first PT transmission" code.

The FT may use the messages indicated with ** without the "first PT transmission" code.

7.3.2.2 BEARER_REQUEST

X 0 0 1 0 0	I/B /C /N	FMID	PMID	ECN	LBN	up/ down/ sm/ss	ser type	max life	slot type	(spare) 1 1 1 1
bn ₀	bn ₆ bn ₅ bn ₇	bn ₈ bn ₁₉	bn ₂₀ bn ₃₉	bn ₄₀ bn ₄₃	bn ₄₄ bn ₄₇	bn ₄₈ bn ₄₉	bn ₅₀ bn ₅₂	bn ₅₃ bn ₅₅	bn ₅₆ bn ₅₉	bn ₆₀ bn ₆₃

Figure 7.67

Table 7.49

I/B/C/N	Meaning
b ₆ b ₇	
0 0	access_request
0 1	bearer_handover_request
1 0	connection_handover_request
1 1	unconfirmed_access_request

For the coding of bits b₄₀ ... b₅₉, see clause 7.2.5.3.8.

PMID = Portable part MAC layer IDentity (see clause 11.7);

FMID = Fixed part MAC layer IDentity (see clause 11.7).

7.3.2.3 BEARER_CONFIRM

X 0 0 1 0 1 0 0	FMID	PMID	ECN	LBN	up/ down/ sm/ss	ser type	max life	slot type	spare 1 1 1 1
bn ₀	bn ₈ bn ₇ bn ₁₉	bn ₂₀ bn ₃₉	bn ₄₀ bn ₄₃	bn ₄₄ bn ₄₇	bn ₄₈ bn ₄₉	bn ₅₀ bn ₅₂	bn ₅₃ bn ₅₅	bn ₅₆ bn ₅₉	bn ₆₀ bn ₆₃

Figure 7.68

For the coding of bits b₄₀ ... b₅₉, see clause 7.2.5.3.8.

7.3.2.4 WAIT

X 0 0 1 0 1 0 1	FMID	PMID or spare 11110000111100001111	spare 00001111 00001111
bn ₀	bn ₇ bn ₁₉	bn ₂₀ bn ₃₉	bn ₄₀ bn ₆₃

NOTE: The procedure does not make reference to the values of bn₈ to bn₆₃. It is not intended that the contents of this field be included in any mandatory tests.

Figure 7.69

7.3.2.5 ATTRIBUTES_B_{Req;Cfm}

X 0 0 1 0 1 1	R / C	FMID	PMID	spare 0000 1111	up/ down/ sm/ss	ser type	max life	slot type	A- field mod. type	(B+Z) fields mod. type
bn ₀	bn ₆ bn ₇	bn ₈ bn ₁₉	bn ₂₀ bn ₃₉	bn ₄₀ bn ₄₇	bn ₄₈ bn ₄₉	bn ₅₀ bn ₅₂	bn ₅₃ bn ₅₅	bn ₅₆ bn ₅₉	bn ₆₀	bn ₆₃

NOTE: These messages are used when modifying a connection (typically as a result of a page with "unknown" service type).

For R/C see clause 7.2.5.3.8. For FMID, PMID see clause 11.7. For coding of bits b₄₈ ... b₆₃ see clause 7.2.5.3.8.

Figure 7.70

7.3.2.6 BANDWIDTH_B_{Req;Cfm}

X 0 0 1 1 0 0	R / C	FMID	1111 0000 1111 spare	0 0 0 spare	MUp	0 0 0 spare	TUp	0 0 0 spare	MDown	0 0 0	TDown
bn ₀	bn ₆ bn ₇	bn ₈ bn ₁₉	bn ₂₀ bn ₃₁	bn ₃₂ bn ₃₉	bn ₄₀	bn ₄₀ bn ₄₇	bn ₄₈	bn ₄₈ bn ₅₅	bn ₅₆	bn ₆₃	

Figure 7.71

For R/C, M_{Up}, T_{Up}, M_{Down} and T_{Down} refer to clause 7.2.5.3.9. For FMID refer to clause 11.7.

7.3.2.7 CHANNEL_LIST

X 0 0 1 1 0 1 0	RPN	1st command and channel description	2nd command and channel description	3rd command and channel description
bn ₀	Bn ₈ bn ₁₅	bn ₁₆ bn ₃₁	bn ₃₂ bn ₄₇	bn ₄₈ bn ₆₃

Figure 7.72

"Command and channel description" shall have the same coding as in clause 7.2.5.3.10. All three commands and channel descriptions shall apply to the same RFP, identified by RPN.

7.3.2.8 UNCONFIRMED_DUMMY

X 0 0 1 1 0 1 1	FMID	PMID	ECN	spare 1 1 1 1	up/ down/ sm/ss	ser type	max life	slot type	spare 1 1 1 1
bn ₀	bn ₈ bn ₁₉	bn ₂₀ bn ₃₉	bn ₄₀ bn ₄₃	bn ₄₄ bn ₄₇	bn ₄₈ bn ₄₉	bn ₅₀ bn ₅₂	bn ₅₃ bn ₅₅	bn ₅₆ bn ₅₉	bn ₆₀ bn ₆₃

Figure 7.73

7.3.2.9 UNCONFIRMED_HANDOVER

X 0 0 1 1 1 0 0	FMID	PMID	ECN	LBN	up/ down/ sm/ss	ser type	max life	slot type	spare 1 1 1 1
bn ₀	bn ₈ bn ₁₉	bn ₂₀ bn ₃₉	bn ₄₀ bn ₄₃	bn ₄₄ bn ₄₇	bn ₄₈ bn ₄₉	bn ₅₀ bn ₅₂	bn ₅₃ bn ₅₅	bn ₅₆ bn ₅₉	bn ₆₀ bn ₆₃

Figure 7.74

7.3.2.10 RELEASE

X 0 0 1 1 1 1 1	FMID	PMID	spare 0000	LBN	spare 0000 1111	reason
bn ₀	bn ₈ bn ₁₉	bn ₂₀ bn ₃₉	bn ₄₀ bn ₄₃	bn ₄₄ bn ₄₇	bn ₄₈ bn ₅₅	bn ₅₆ bn ₆₃

Figure 7.75

Table 7.50

reason	Explanation for release
0 0 0 0 0 0 0 0 0	unknown
0 0 0 0 0 0 0 0 1	bearer release (reduce capacity)
0 0 0 0 0 0 0 1 0	connection release
0 0 0 0 0 0 0 1 1	bearer setup or handover failed
0 0 0 0 0 0 1 0 0	bearer handover successfully completed
0 0 0 0 0 0 1 0 1	attempted bearer HO to another cluster
0 0 0 0 0 0 1 1 0	timeout, loss of signal
0 0 0 0 0 0 1 1 1	timeout, loss of handshake
0 0 0 0 0 1 0 0 0	requested unacceptable slot type
0 0 0 0 0 1 0 0 1	requested unacceptable MAC service
0 0 0 0 0 1 0 1 0	base station busy
0 0 0 0 0 1 0 1 1	reverse direction (double simplex)
0 0 0 0 0 1 1 0 0	duplicate PMID
0 0 0 0 0 1 1 0 1	unacceptable PMID
0 0 0 0 0 1 1 1 0	target number exceeded
0 0 0 0 0 1 1 1 1	}
to	}
1 1 1 1 1 1 1 1 1	reserved

NOTE 3: "Bearer handover successfully completed" is only intended for use in double simplex release.

7.3.3 Null

This message is used to fill bn subfields when there is no I data or CF data or GF data or other M_{Bn} messages to send.

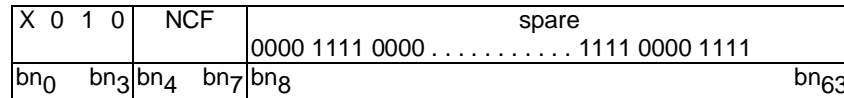

Figure 7.76

Table 7.51

NCF	Meaning
0 0 0 0	no CF or CLF data in the B-field
0 0 0 1	one B-subfield contains CF or CLF data
0 0 1 0	two B-subfields contain CF or CLF data
0 0 1 1	three B-subfields contain CF or CLF data
0 1 0 0	four B-subfields contain CF or CLF data
0 1 0 1	five B-subfields contain CF or CLF data
0 1 1 0	six B-subfields contain CF or CLF data
0 1 1 1	seven B-subfields contain CF or CLF data
1 0 0 0	eight B-subfields contain CF or CLF data
1 0 0 1	nine B-subfields contain CF or CLF data
1 0 1 0	} reserved
to	
1 1 1 1	}

7.3.4 Quality control

7.3.4.1 General format

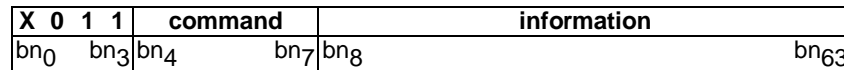

Figure 7.77

Table 7.52

command	Meaning
0 0 0 0	} Bearer and Connection Control
to	
1 0 0 0	} reserved
1 0 0 1	
to	
1 1 0 1	} Reset
1 1 1 0	
1 1 1 1	Bearer quality in an asymmetric connection

7.3.4.2 Bearer and connection control

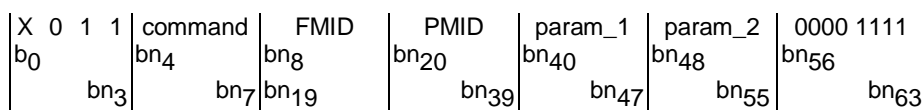

Figure 7.78

Table 7.53

command				param_1	param_2	Meaning
0	0	0	0	LBN LBN	LBN LBN	antenna switch for the bearer(s) identified by LBN request: PT --> FT reject: FT --> PT
0	0	0	1	RPN	0000 1111	antenna switch for all bearers of this connection to the RFP identified by its RPN request: PT --> FT reject: FT --> PT
0	0	1	0	0000 LBN	LBN LBN (note 8)	bearer handover / bearer replacement of the bearer(s) identified by LBN request: FT --> PT reject: PT --> FT
0	0	1	0	1111 LBN	LBN LBN (note 8)	bearer handover / bearer replacement of the bearer(s) identified by LBN request: PT --> FT reject: FT --> PT
0	0	1	1	0000 1111	0000 1111	connection handover request: FT --> PT reject: PT --> FT
0	1	0	0	0000 LBN	frequency error	frequency control for the bearer identified by LBN request: FT --> PT reject: PT --> FT
0	1	0	1	RPN	frequency error	frequency control for all bearers of this connection to the RFP identified by its RPN request: FT --> PT reject: PT --> FT
0	1	1	0	RPN	advance timing increment decrement	Advance timing for all the bearers of this connection to the RFP identified by its RPN request: FT --> PT reject: PT --> FT
0	1	1	1	RPN	0000 1111	PT --> FT: PT informs that it is transmitting prolonged preamble in all the frames
1	0	0	0	0000 SN	0000 CN	frequency replacement to carrier CN on slot pair SN. request PT -> FT confirm FT -> PT
1	0	0	0	0001 SN	0000 CN	frequency replacement to carrier CN on slot pair SN. grant PT -> FT
1	0	0	1			}
to						Reserved
1	1	0	1			}

NOTE 1: The function of these commands depends on the transmission direction. The commands are either requests or reject. A reject should only be used if the requested action is not supported.

NOTE 2: For the bearer handover request, the RPN is an optional parameter. If set to all "0" the FP does not propose a particular RFP for handover.

NOTE 3: A PP may or may not accept the RFP's proposal of the new RPN.

NOTE 4: The frequency error in kHz is encoded in 2's complement form, to give a range of +127 kHz to -128 kHz. The least significant bit of the error is placed in bit position bn_{55} .

NOTE 5: The advance timing changes are encoded in 2's complement form (+127 bits to -128 bits). The LSB of the advance timing is placed in position a_{31} . Changes with less than 2 bits should not be requested.

NOTE 6: The bearer handover request command in the PT to FT direction is used in the double simplex bearer handover procedure.

NOTE 7: Duplicate the last used LBN to all not used LBN parameter fields to ensure detection capability for the receiver. Values 0000 and 1111 can be ignored.

NOTE 8: The param_2 field in previous versions was RPN, now LBN,LBN. This can result in ambiguity! This coding has been changed for B-field messages only, because it was standardized in EN 301 649 (DPRS) (see Bibliography).

7.3.4.3 RESET

This message shall only be used in the MAC I_p_error_correction service.

X 0 1 1 1 1 1 0	FMID	PMID	ctrl	LBN	spare 0000 1111	spare 0000 1111
bn ₀	bn ₈ bn ₇	bn ₂₀ bn ₁₉ bn ₃₉	bn ₄₀ bn ₄₃	bn ₄₄ bn ₄₇	bn ₄₈ bn ₅₅	bn ₅₆ bn ₆₃

Figure 7.79

Table 7.54

ctrl	Meaning
0 0 X X	request
0 1 X X	confirm
0 X 0 0	reserved
0 X 0 1	first TDMA half frame
0 X 1 0	second TDMA half frame
0 X 1 1	both TDMA half frames
1 X X X	reserved

7.3.4.4 Bearer quality in an asymmetric connection

X 0 1 1 1 1 1 1	Acknowledgements for Channels in the first Half of the frame	acknowledgements for channels in the second half of the frame
bn ₀	bn ₇ bn ₈	bn ₃₅ bn ₃₆ bn ₆₃

Figure 7.80

Acknowledgements for physical channels in the first half of the TDMA frame.

LBN1		LBN2		LBN3		LBN4		LBN5		...	LBN14	
Q1/	Q2	Q1/	Q2	Q1/	Q2	Q1/	Q2	Q1/	Q2		Q1/	Q2
BCK		BCK		BCK		BCK		BCK			BCK	
bn ₈	bn ₉	bn ₁₀										bn ₃₅

Figure 7.81

Acknowledgements for physical channels in the second half of the TDMA frame.

LBN1		LBN2		LBN3		LBN4		LBN5		...	LBN14	
Q1/	Q2	Q1/	Q2	Q1/	Q2	Q1/	Q2	Q1/	Q2		Q1/	Q2
BCK		BCK		BCK		BCK		BCK			BCK	
bn ₃₆												bn ₆₃

Figure 7.82

In pairs two bits are related to one simplex half of a double simplex bearer identified by the LBN. Depending on the MAC layer service the meaning of these bits is different.

For I_N and I_P _error_detection services the two bits have the function of the Q1 and Q2 bit. The setting of the Q1 and Q2 bit are described in the procedures of clause 10.8.1.3.

For the I_P _error_correction service the two bits have the function of the BCK and Q2 bit. The coding of these bits are described in clause 10.8.2.4.

7.3.5 Extended system information

7.3.5.1 General format

X 1 0 0	command	information
bn ₀ bn ₃	bn ₄ bn ₇	bn ₈ bn ₆₃

Figure 7.83

Table 7.55

command	Meaning
0 0 0 0	TARI messages
0 0 0 1	} reserved
to	
1 1 1 1	

7.3.5.2 TARI messages

The management entity in the transmitting radio endpoint supplies the MAC layer with a 36-bit SDU via the ME SAP. At the receiving endpoint the MAC layer passes the 36-bit SDU out through the ME SAP to the management entity.

X 1 0 0 0 0 0 0	TARI field	spare 1111	spare 0000 1111	spare 0000 1111
bn ₀ bn ₇	bn ₈ bn ₄₃	bn ₄₄	bn ₆₃	

Figure 7.84

For the coding of the TARI field refer to EN 300 175-6 [5].

7.3.6 G_F -channel data packet

X 1 0 1	NCF	56 bit G_F -channel SDU
bn ₀ bn ₃	bn ₄ bn ₇	bn ₈ bn ₆₃

Figure 7.85

Table 7.56

NCF	Meaning
0 0 0 0	no C _F data in the B-field
0 0 0 1	one B-subfield contains C _F data
0 0 1 0	two B-subfields contain C _F data
0 0 1 1	three B-subfields contain C _F data
0 1 0 0	four B-subfields contain C _F data
0 1 0 1	five B-subfields contain C _F data
0 1 1 0	six B-subfields contain C _F data
0 1 1 1	seven B-subfields contain C _F data
1 0 0 0	eight B-subfields contain C _F data
1 0 0 1	nine B-subfields contain C _F data
1 0 1 0 }	reserved
to }	
1 1 1 1 }	

7.3.7 Escape

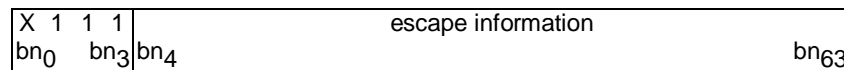

Figure 7.86

Any DECT equipment may transmit an escape message.

The content of the escape information field (bn₄ to bn₆₃) is not specified. This message shall not be used to perform a function that is specified in another part of the DECT CI standard.

8 Medium access layer primitives

The contents of clause 8 are for information only. This clause is aimed to assist in the description of layer to layer procedures.

These primitives are abstract and their concrete representations may vary from implementation to implementation. Therefore, they shall not be considered to be a testable entity.

Four types of primitives exist, Request (req), Indicate (ind), Response (res) and Confirm (cfm). A "cfm" primitive only occurs as confirmation of an action initiated by a "req" primitive. A "res" primitive can only follow a "ind" primitive. The direction of the primitives is shown in figure 8.1:

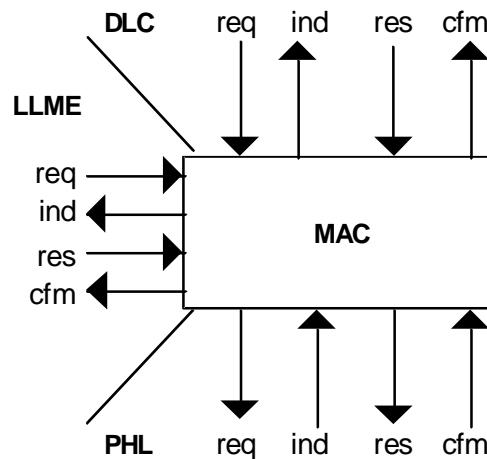

Figure 8.1: MAC layer primitives

8.1 Connection oriented service primitives

Connections are identified by the MAC Connection Endpoint Identifier, MCEI.

8.1.1 Connection setup: MAC_CON {req;ind;cfm}

Parameter list:

Table 8.1

Parameter	req	ind	cfm
MCEI	X	X	X
FMID, note 1	X	X	-
PMID	X	X	-
connection handover	X	X	-
old MCEI, note 2	X	-	-
CF required	X	X	-
slot type	X	X	-
service type	X	X	-
max lifetime, note 3	O	X	-
up/down/sm/ss, note 4	O	X	-
connection type	-	X	X
ECN, note 5	-	X	X
X = parameter exists O = parameter optional - = parameter does not exist in this primitive			
NOTE 1: FMID is only needed for fixed part initiated "fast setup".			
NOTE 2: The "old MCEI" parameter is only needed if "connection handover" = "yes" and the previous "connection type" = "basic".			
NOTE 3: The "maximum lifetime" parameter only applies to the IP_error_correction service. The setting of this parameter in the MAC_CON-req primitive is optional. Default value (i.e. assumed when not set) is: maximum lifetime = unlimited.			
NOTE 4: The setting of this parameter in the MAC_CON-req primitive is optional. Default value is "ss", the symmetric single bearer connection.			
NOTE 5: The "ECN" parameter is only used if "connection type" = "advanced".			

Parameter values:

MCEI = local matter;

connection handover = { yes, no };

old MCEI = local matter, or null;

C_F required = { yes, no };

service type = { I_N_minimum_delay, I_N_normal_delay, I_P_error_detection;

slot type = { double, full, half with j = 0 };

I_P_error_correction, unknown, C-channel only I_{PQ}_error_detect, I_{PQ}_error_correct };

maximum lifetime = { unlimited, 1, 2, ... , 7 };

up/down/sm/ss: up = asymmetric uplink connection;
 down = asymmetric downlink connection;
 sm = symmetric multibearer connection;
 ss = symmetric single bearer connection;

connection type = { basic, advanced };

ECN = {0, 1, ... 15}.

8.1.2 Connection modification: MAC_MOD {req;ind;cfm}

Parameter list:

Table 8.2

Parameter	req	ind	cfm
MCEI	X	X	X
ECN	X	X	X
slot type	X	X	-
switching	O	O	-
service type	X	X	-
max lifetime	O	O	-
target number of uplink simplex bearers	O	-	-
target number of downlink simplex bearers	O	-	-
minimum acceptable uplink simplex bearers	O	-	-
minimum acceptable downlink simplex bearers	O	-	-
result	-	X	X
modulation type	O	O	O
X = parameter exists			
O = parameter optional			
- = parameter does not exist in this primitive			

Parameter values are the same as MAC_CON except:

MCEI = local matter;

ECN = {0, 1, ... 15};

switching = {full to double, double to full, full to full, full to half, half to full, basic to advanced, none};

slot type = { double, full, half with j = 0 };

service type = { I_N-minimum_delay, I_N-normal_delay, I_P-error_detection,
 I_P-error_correction, C-channel only, I_{PQ}-error_detect, I_{PQ}-error_correct };

maximum lifetime = { unlimited, 1, 2, ... , 7 };

target number of uplink simplex bearers = {1,2, ... 30};

target number of downlink simplex bearers = {1,2, ... 30};

minimum acceptable uplink simplex bearers = {1,2, ... 30};

minimum acceptable downlink simplex bearers = {1,2, ... 30}.

result = {accept, reject}.

Modulation type = {2-level mod. in (B+Z) fields; 2-level mod. in the A-field; 4-level-mod. in (B+Z)-fields; 4-level mod. in the A-field; 8-level mod. in (B+Z) fields; 8-level mod. in the A-field}.

NOTE 1: Target number \geq minimum acceptable.

NOTE 2: If "slot type" = "half" then target number = minimum acceptable = 1.

"Slot type" shall only be used to adjust j.

NOTE 3: If the "modulation type" parameter is not present, the correct modulation scheme is confirmed.

8.1.3 CO data transmit ready: MAC_CO_DTR {ind}

Table 8.3

Parameter	ind
MCEI	X
data channel type	X
number of segments	X
number of duplex bearers	X
X = parameter exists	

Data channel type = { G_F, C_S, C_F, I_N, I_P }.

Number of segments = { 0, 1, ... 30 }.

No. of duplex bearers = integer; this value is only set for data channel type C_F .

8.1.4 CO data transfer: MAC_CO_DATA {req;ind}

Parameter list:

Table 8.4

Parameter	req	ind
MCEI	X	X
transmit data channel type	X	-
receive data channel type	-	X
number of segments	X	X
number of bearers for control	X	-
SDU	X	X
CRC Results	-	O
X = parameter exists O = parameter optional - = parameter does not exist in this primitive		

Parameter values:

transmit data channel type = { $G_F, C_S, C_F, I_N, I_P, \text{null}$ };

receive data channel type = { $G_F, C_S, C_F, I_N, I_P, \text{unknown}$ };

number of segments = { 0, 1, ... 30 };

no of bearers for control = integer; this parameter is only set if transmit channel type is C_F ;

CRC results = local matter.

NOTE: Except I_N , all data is provided with MAC layer 16 or 32 bit CRCs. Indicating the CRC results may be needed in error detect services.

8.1.5 Restart DLC: MAC_RES_DLC {ind}

Parameter list:

Table 8.5

Parameter	ind
MCEI	X
X = parameter exists	

8.1.6 Connection release: MAC_DIS {req;ind}

Parameter list:

Table 8.6

Parameter	req	ind
MCEI	X	X
reason	-	O
X = parameter exists O = parameter optional - = parameter does not exist in this primitive		

Reason = { normal, abnormal }.

NOTE: Disconnect with the aim of reconnecting should be performed by sending appropriate higher layer messages before issuing this primitive.

8.1.7 MAC bandwidth: MAC_BW {ind;res}

Parameter list:

Table 8.7

Parameter	ind	res
MCEI	X	X
target number of uplink simplex bearers	X	-
target number of downlink simplex bearers	X	-
minimum acceptable uplink simplex bearers	X	-
minimum acceptable downlink simplex bearers	X	-
X = parameter exists - = parameter does not exist in this primitive		

Parameter values:

MCEI = local matter;

target number of uplink simplex bearers = {1,2, ... 30};

target number of downlink simplex bearers = {1,2, ... 30};

minimum acceptable uplink simplex bearers = {1,2, ... 30};

minimum acceptable downlink simplex bearers = {1,2, ... 30}.

8.1.8 Encryption

8.1.8.1 Load encryption key: MAC_ENC_KEY {req}

Parameter list:

Table 8.8

Parameter	req
MCEI	X
SDU, containing encryption key	X
X = parameter exists	

8.1.8.2 Enable/disable encryption: MAC_ENC_EKS {req;ind;cfm}

Parameter list:

Table 8.9

Parameter	req	ind	cfm
MCEI	X	X	X
"go crypted / go clear" flag	X	X	X
X = parameter exists			

8.1.9 C-plane switching procedure

8.1.9.1 C-plane switching procedure: MAC_C_S_C_F {req, cfm, ind, res}

Parameter list:

Table 8.10

Parameter	req	ind	res	cfm
MCEI	X	X	X	X
LCN old	X	X	X	X
LCN new	X	X	X	X
switching type	X	X	X	X
result	X	X	X	X
X = parameter exists - = parameter optional				

Parameter values:

MCEI = local matter;

LCN old = {0, 1, ...,7};

LCN new = {0, 1, ...,7};

switching type: {C_S to C_F, C_F to C_S, C_S to C_S};

result: accept/reject.

8.1.9.2 C-plane switching procedure: MAC_CSCF_END {ind}

Parameter list:

Table 8.11

Parameter	ind
MCEI	X
LCN old	X
LCN new	X
switching type	X
result	X
X = parameter exists - = parameter optional	

Parameter values:

MCEI = local matter;
 LCN old = {0, 1, ...,7};
 LCN new = {0, 1, ...,7};
 switching type: { C_S to C_F, C_F to C_S, C_S to C_S};
 result: accept/reject.

8.2 Connectionless and broadcast service primitives

8.2.1 Paging: MAC_PAGE {req;ind}

Parameter list:

Table 8.12

Parameter	req	ind
cluster ID	X	X
page type	X	-
length of page field	X	-
long flag	X	X
SDU	X	X
CRC results	-	O
X = parameter exists O = parameter optional - = parameter does not exist in this primitive		

Parameter values:

cluster ID = { all clusters / an integer };
 page type = { fast, normal };
 length of page field = {0, 20, 36, 72, 108, 144, 180, 216};
 long flag = { long, other }; this parameter is only needed for page fields of length 36;
 CRC results = local matter.

8.2.2 Downlink connectionless: MAC_DOWN_CON {req;ind}

Table 8.13

Parameter	req	ind
logical channel	X	X
number of segments	X	X
ARI	-	X
data contains errors	-	X
SDU	X	X
X = parameter exists - = parameter does not exist in this primitive		

logical channel = { CL_F, CL_S, SI_N, SI_P }.

number of segments = { 1 ... 10 }.

NOTE: Number of segments is only needed for CL_F data.

8.2.3 Uplink connectionless: MAC_UP_CON {req;ind;cfm}

Table 8.14

Parameter	req	ind	cfm
SDU length	X	X	-
SDU	O	O	-
PMID	-	X	-
data contains errors	-	X	-
status			X
X = parameter exists O = parameter optional - = parameter does not exist in this primitive			

SDU length = { 0, 40, n*64 }; n = { 1, 2, ... 20 }.

status = { no C/L uplink service, CL_F not supported, data transmitted }.

8.3 Management primitives

Parameter values shall not be defined for the management primitives in this EN to allow the possibility of alternative implementations.

8.3.1 Connection control

8.3.1.1 Connection setup: MAC_ME_CON {ind}

Parameters:

- basic/advanced connection;
- ECN (if advanced connection);
- new connection/bearer handover/connection handover;
- old MCEI (if connection handover).

8.3.1.2 Connection setup allowed: MAC_ME_CON_ALL {req}

Parameters:

- forbid/allow flag;
- forbid reason (i.e. asked for basic, can retry with advanced);
- ECN;
- new MBC required;
- MCEI.

8.3.1.3 Bearer release: MAC_ME_REL {req}

This primitive is used by the LLME to release a bearer due to not finding an MBC on handover.

8.3.1.4 MBC release report: MAC_ME_REL_REP {ind}

Parameter:

- ECN.

8.3.2 System information and identities

8.3.2.1 FP information preloading: MAC_ME_RFP_PRELOAD {req}

Parameters:

- PARI;
- RPN;
- SARI;
- fixed part capabilities;
- multiframe number.

8.3.2.2 PT information preloading: MAC_ME_PT_PRELOAD {req}

Parameters:

- assigned individual TPUI;
- assigned/default flag.

8.3.2.3 System information output: MAC_ME_INFO {ind;res}

Parameters:

- PARI;
- RPN;
- SARI;
- fixed part capabilities;
- multiframe number.

8.3.2.4 Extended system info: MAC_ME_EXT.{req;ind;res;cfm}

Parameters:

- FMID;
- PMID;
- SDU.

8.3.3 Channel map: MAC_ME_CHANMAP {ind;res}

Parameters:

- strongest channels;
- Quietest/free channels.

8.3.4 Status reports: MAC_ME_STATUS {req;ind;res;cfm}

Parameters:

- call status;
- slot drift/slot theft (X-field) report;
- CRC report (retransmission report);
- timer status;
- handover required;
- diversity switch required.

8.3.5 Error reports: MAC_ME_ERROR {ind;res}

Parameters:

- service overload;
- call failure.

8.4 Flow control

8.4.1 MA SAP flow control

Transmitter: the BMC of an FT may accept MAC_PAGE-req primitives. According to the paging type (fast or normal, see clause 9.1.3.1), the SDU length, and the T-Mux algorithm the BMC will distribute the P-channel information to all TBCs, CBCs and DBCs of a cluster. If the BMC cannot distribute the SDU contained in the MAC_PAGE-req primitive, that SDU is discarded and nothing is returned to the higher layers.

Receiver: the BMC in a PT may receive paging messages from any bearer. If BS-channel messages were received in one TDMA frame the BMC should send at least one of these messages with a MAC_PAGE-ind primitive to the DLC.

8.4.2 MB SAP flow control

The flow control of SI_N, SI_p, CL_S and CL_F-channel data depends on the transmission direction and the connectionless service. Flow control is described separately for downlink and uplink directions in the corresponding procedures in clauses 9.1.2 and 9.2 respectively.

8.4.3 MC SAP flow control

The MBC shall request the DLC for all data to be transmitted from the C_S , C_F , G_F , I_N and I_P -channel. With the MAC_CO_DTR -ind primitive the MBC may request for segments of several channels or selectively for segments of only one channel. The DLC responds by issuing one or several MAC_CO_DATA -req primitives to the MAC. A MAC_CO_DATA primitive shall carry data segments from only one logical (sub)channel. Data is delivered from the MAC to the DLC with the MAC_CO_DATA -ind primitive.

The following primitive flow shall be provided on the transmitting side:

- a) **C_S and C_F -channels:** before an ARQ window starts (see clause 10.8.1) the MAC shall request with MAC_CO_DTR -ind primitives for the maximum number of allowed higher layer control segments (C_S and C_F -channel data). By requesting C_F segments the MAC indicates the number of established duplex bearers. The DLC shall respond with MAC_CO_DATA -req primitives. These primitives shall contain at most the indicated number of C_S and C_F segments, and for data type C_F , the number of duplex bearers allowed to carry higher layer control.

NOTE 1: The number of allowed C_S or C_F segments indicated with the MAC_CO_DTR -ind primitive may be zero, e.g. when retransmissions are needed.

If no C_F -channel is provided the number of acceptable C_F segments in the MAC_CO_DTR -ind primitive and the number of allowed duplex bearers for higher layer control in the MAC_CO_DATA -req primitive shall always be zero.

The C_F data shall always be transmitted on the allowed number of duplex bearers indicated with the MAC_CO_DATA -req primitive. This rule is also applied for retransmissions of C_F data. The MAC shall only retransmit the C_F data on the number of bearers specified by the DLC, a value "0" disables all retransmissions.

A MAC_CO_DATA -ind primitive may allow the DLC to issue one or more C_F segments. The DLC may respond with a MAC_CO_DATA -req primitive for C_F data that reserves some bearers for higher layer control but the primitive itself does not contain a SDU (i.e. number of C_F segments = 0). The number of reserved bearers shall not be used for I-channel data. If no or not sufficient G_F -channel data is available (see item d)) the MAC shall fill the remaining segments (see item e)).

- b) **I_N normal delay and I_P :** before a TDMA half frame starts the MAC shall request with a MAC_CO_DTR -ind primitive for all new I-channel data segments which can be transmitted in this TDMA half frame. The DLC shall reply with a MAC_CO_DATA -req primitive. This primitive shall contain the requested number of I-channel segments for the I_N normal delay service. For I_P services the number of delivered I_P segments shall not exceed the number indicated in the MAC_CO_DTR -ind primitive. If a TDMA half frame is the beginning half frame of an ARQ window, the I-channel request shall follow the C-channel request.

If two bearers with the same LBN are maintained during bearer handover, I-channel data shall be duplicated on both bearers, the new and the old bearer.

- c) **I_N minimum delay:** just before the transmission of a bearer carrying I_N data in a I_N minimum delay service starts the MAC request with a MAC_CO_DTR -ind primitive this segment. The DLC shall respond with a MAC_CO_DATA -req primitive and deliver a I_N segment.

If two bearers with the same LBN are maintained during bearer handover, I-channel data may be different on both bearers. The MAC shall ask for data for the two bearers using two independent primitives. See annex F for information regarding seamless handover operation.

- d) **G_F -channel:** if the G_F -channel is used (I_P service) and capacity is available for G_F segments, the MAC request just before the transmission starts with a MAC_CO_DTR -ind primitive and indicates the maximum number of acceptable G_F segments. The DLC may respond with a MAC_CO_DATA -req primitive and deliver at most the indicated number of segments. Capacity can be available on bearers carrying some higher layer control, extended MAC control or on bearers which are not used to carry either C_F or I_P data;
- e) **Filling:** if the DLC delivers insufficient control segments for a particular bearer, the MAC shall fill the remaining segments.

If no control segments are delivered by the DLC, the MAC shall fill all segments.

NOTE 2: I_N mode filling is performed by the DLC.

The following primitive flow shall be provided on the receiving end:

- a) if the A-field CRC fails, the B-field data segments are delivered with a MAC_CO_DATA-ind primitive, and are labelled as "unknown";
- b) correctly received new C_S and C_F data segments shall be delivered with a MAC_CO_DATA-ind primitive to the DLC at TDMA half frame boundaries;
- c) correctly received G_F segments are delivered to the DLC immediately with a MAC_CO_DATA-ind primitive;
- d) for the I_P _error_correction and I_N _minimum_delay services, correctly received I-channel segments are delivered to the DLC immediately with a MAC_CO_DATA-ind primitive; B-field segments labelled as "unknown" may be delivered for I_N _minimum_delay services.
- e) for the I_P _error_detection and I_N _normal_delay services, Correctly received I-channel segments are issued to the DLC with MAC_CO_DATA-ind primitives at half frame boundaries. Segments labelled as "unknown" may be delivered for I_N _normal_delay services. Sequencing shall be provided. For sequencing the "unknown" segments are treated as I-channel segments.

9 Broadcast and connectionless procedures

9.1 Downlink broadcast and connectionless procedures

This clause describes the procedures for the continuous downlink BMC and CMC services.

9.1.1 Downlink broadcast procedure

9.1.1.1 Broadcast information

The broadcast information provides three basic services to any locked PPs:

- 1) access rights identifiers: (N-channel and Q-channel);
- 2) system information: (Q-channel);
- 3) paging information: (P-channel).

Access Rights Identifiers (ARIs):

Access right identifiers are broadcast in two channels. The primary access rights identifier is repeated most frequently using the N-channel, and shall be provided by all RFPs. The RFP may indicate the existence of secondary access rights identities. Any SARIs are broadcast as part of the Q-channel using the SARI message (see clause 7.2.3.6).

NOTE: Tertiary Access Right Identifiers (TARIs) may also exist. These are available on demand (see clause 9.3).

The ARIs determine if a PP can request service from the RFP, according to the rules given in EN 300 175-6 [5].

System information:

System information gives many details about the operation of the fixed part. This is a mixture of general information, plus RFP specific information.

Certain system information messages are essential for PTs to lock to a system. These messages shall be transmitted by all RFPs. The contents and provisions of these messages and the maximum interval between repeats are defined in clause 7.2.3. Transmission of these messages is described in clause 11.1.1. The PT locking procedure is defined in clause 11.3.

Paging information:

Paging information is used to send transient information to locked PPs. The main application of this service is to deliver call setup messages, these messages are used to connect incoming (FP-originated) calls.

There is a fast and a normal paging mode. In normal paging mode the paging message positions within a multiframe are restricted to minimize the duty cycle of idle locked PPs. This enables idling PPs to switch off for the other frames.

However, paging message delays may occur, and the fast paging mode is defined for cases where a higher duty cycle is acceptable and shorter delay is wanted. Fast paging is expected to be primarily used for data terminals.

Paging procedures are defined in clause 9.1.3.

9.1.1.2 Channel selection for downlink broadcast services

As defined in clause 5.7.1 the continuous broadcast service shall always be available at each CSF. This service shall be provided on:

- all traffic bearers with transmissions in the direction FT to PT;
- any connectionless bearer used for a downlink CMC service;
- the dummy bearer.

Channel selection to provide the downlink broadcast service shall only be applied to setup a dummy bearer, and may occur if either:

- 1) in presence of traffic bearers neither a bearer providing a connectionless downlink service nor a dummy bearer exists; or
- 2) the last bearer with transmissions in the direction FT to PT is released, and neither a dummy bearer nor a bearer providing a connectionless downlink service exists; or
- 3) one dummy bearer but no traffic bearer exists and the CSF tries to install a second dummy bearer; or
- 4) the RFP decides to change the physical channel for a dummy bearer; or
- 5) the RFP receives a "change dummy bearer position" message (see clause 7.2.5.6) and the FT's CSF allows a change; or

NOTE: It depends on the system configuration if a CSF allows a dummy bearer change when requested. FTs may ignore a "change dummy bearer position" message.

- 6) a connectionless downlink service has finished.

Except for situation 6) above, the FT shall choose a channel according to clause 11.4.3 with following preferences:

For situation 2) above: if the last bearer with transmissions in the direction FT to PT was a traffic bearer, this bearer should be converted into a dummy bearer.

For situation 5) above: the physical channel proposed in the "change dummy bearer position" message should be chosen if allowed (see clause 11.4.3).

If a CSF decides to install dummy bearer(s) when a connectionless service has finished (situation 6)) above, the CSF shall convert the connectionless downlink bearers to dummy bearers.

The following rules for the placement of the dummy-bearers should be applied so that a PP can always find alternative RFPs when it is locked to one RFP and searches for a stronger one:

- general for TDMA-multicell-systems:
 - at least two bearers (dummy or traffic bearers) need to be TX-active so that a PP can always find its surrounding FPs. This is necessary because one of the two dummies can be hidden in the slot which is RX-active at the PP (for staying locked or maintaining a traffic-bearer);
- when using slow-hopping RF-modules in the PP (this means that slots which are directly neighboured to active receive or transmit slots cannot be used):
 - **with two active dummy bearers:**
 - the slot number of the first dummy bearer has to be taken into account during channel-selection of the second dummy bearer. Slot N of the second dummy bearer has to have a minimum distance of 3 slots ($N \pm 3$) relative to the slot of the first dummy bearer;
 - **with one active dummy bearer:**
 - when opening a new traffic-bearer slot it has to be checked in the FP, if the FP can still be "seen" by the PP, i.e. a minimum number of 2 active TX-slots at the FP have got a minimum distance of 3 slots. If this is the case, the dummy bearer can be released. If it is not the case, the dummy bearer has to be moved to a suitable slot;
 - **with no active dummy bearer:**
 - when opening a new traffic-bearer slot it has to be checked in the FP, if the FP can still be "seen" by the PP, i.e. a minimum number of 2 active TX-slots at the FP have got a minimum distance of 3 slots. If this is not the case, a dummy bearer has to be activated in a suitable slot.

9.1.1.3 Downlink broadcast procedure description

The downlink broadcast procedure is defined by the T-MUX rule (see clause 6.2.2.1). This rule defines the distribution of the available capacity for Q, N and P-channels.

The Q-channel information depends on the system configuration. Q-channel capacity shall be split for transmission of the different messages according to the rules defined in clause 7.2.3.1.

The P-channel capacity shall be used as defined in clause 9.1.3.

9.1.2 Downlink connectionless procedure

9.1.2.1 Channel selection at the RFP

If dummy bearers exist in the CSF, all dummy bearers shall be converted into connectionless bearers.

When no dummy bearer is present or when the RFP decides to change the physical channel to provide the connectionless downlink service, the RFP shall choose a channel according to clause 11.4.3.

BMC services may be used to announce the creation of a new downlink service.

9.1.2.2 Downlink connectionless procedure description

FT procedure:

The CBC of a downlink service normally transmits continuously, i.e. in one slot every frame (see clause 5.7). The CBC supports the BMC and the CMC downlink service. Dependent on the downlink service (see clause 5.7.2.1) the DLC may deliver CL_S, CL_F SI_N or SI_P data with a MAC_DOWN_CON-req primitive. During SI_N services the DLC shall submit one segment of SI_N channel data per frame. During SI_P services the DLC shall submit the maximum number of SI_P segments that can be transmitted in one frame. For CL_F services the DLC may submit at most the maximum number of CL_F segments that can be transmitted in one frame. In addition the DLC may deliver one segment of CL_S data every second frame.

CL_S data is transmitted by the RFP strictly following the T-MUX rules defined in clause 6.2.2.1. No numbering is applied for CL_S segments. The TA bits in the A-field header may use either code for C_T tails.

CL_F data is positioned in the B-field according to the definition in clause 6.2.2.3.

PT Procedure:

Predicate: The PT has a CBC installed and is receiving the FT's connectionless bearer.

NOTE: The FT's connectionless downlink transmissions can be recognized by the special header coding for the N_T tails. In addition, the FT may use the BMC service to broadcast the connectionless bearer position.

The PT's CMC delivers all connectionless data together with the CRC results to the DLC using the MAC_DOWN_CON-ind primitive. If the A-field was received with errors any B-field data shall be delivered with data type set to "unknown". The A-field tail shall be delivered as "unknown" on A-field CRC failure only when received in a TDMA frame where C_T tails in the downlink direction are allowed (see clause 6.2.2.1).

9.1.3 Paging broadcast procedure

In clause 9.1.3 the following definitions shall apply:

- if "length of page field" = 0, the page is "zero length";
- if "length of page field" = 20, the page is "short";
- if "length of page field" = 36, the page is "full" or "long";
- if "length of page field" > 36, the page is "long"; and
- if "BS SDU length indication" indicate MAC resume page, the page is "resume".

9.1.3.1 RFP paging broadcasts

Paging messages are used to alert a PP at any location within a DECT fixed part. The BS-channel is handled by the broadcast message controller and the broadcast controllers in every TBC, CBC, and DBC.

The BMC in each cluster shall check that the "cluster ID" parameter in the MAC_PAGE-req primitive refers to the BMC's cluster. Zero length, short, full, long and resume pages are distinguished by their different SDU length and the "long" flag for SDU length 36.

All paging messages are broadcast by an RFP using the P_T type tails. Within one cluster, all BS-channel information shall be duplicated in the P_T type tails of all bearers.

The BMC shall not generate a P_T type tail containing short, full, or long page information except after having received a MAC_PAGE-req primitive. Zero length pages may be generated either after receiving a MAC_PAGE-req primitive with "length of page field" = 0, or by the broadcast controller in the TBC, CBC, or DBC itself.

Zero length page messages are allowed in every frame where P_T information is allowed. Normal length page messages with BS data and resume page shall have priority over zero length page messages.

NOTE 1: Care has to be taken not to force the PPs which are operating in low power mode to listen to all page messages. This can be done by deactivation of the page-extend bit.

The MAC_PAGE-req primitive shall define one of two possible paging types:

- normal paging;
- fast paging.

P_T type tail transmissions are only allowed in certain frames of the multiframe (see clause 6.2.2.1). Fast paging may only be used to alert PPs that listen to all allowed frames for P_T tails. Normal paging is applied to alert PPs that do not listen to all of these frames. To ensure that PPs have not to listen to all allowed frames for P_T tails within one multiframe but can receive all page tails of the normal paging type transmitted in that multiframe the FT sets an extend flag in the P_T tail header. Paging tails of the normal and fast paging type shall be transmitted within a multiframe according to the following rules:

Fast resume, fast full and fast short paging messages and the first segment of a fast long page message may be placed in any frame in which transmission of P_T type tails is permitted, except that they shall not interrupt long pages.

NOTE 2: Higher layer functions are used to ascertain whether a PT is likely to respond to fast paging.

Fast zero length pages shall be treated as normal, zero length pages. Normal resume, normal full, normal short and normal zero length paging messages and the first segment of a normal long page message shall be restricted to the following frames:

- a) frame 0 in any multiframe sequence;
- b) frame 2, only if frame 0 has the extend flag set to 1;
- c) frame 4, only if frames 0, 2 have the extend flag set to 1;
- d) frame 6, only if frames 0, 2, 4 have the extend flag set to 1;
- e) frame 10, only if frames 0, 2, 4, 6 have the extend flag set to 1;
- f) frame 12, only if frames 0, 2, 4, 6, 10 have the extend flag set to 1.

In frame 12, the extend flag shall be set to 0.

Long pages shall have the extend flag set to 0.

NOTE 3: Within one multiframe, at most one long page of the normal paging type may be transmitted, and this is the last transmitted page of the normal paging type for that multiframe.

Long pages are divided into segments of 36 bits and shall be transmitted in successive frames in which P_T type tails are permitted. Long pages shall not continue from frame 12 to frame 0.

Every P_T tail contains a 4 bit header. One bit is the extend flag, referred to above. The other three bits in this header indicate the length of the page. For the BS SDU length 36 two codes are used to distinguish full and long pages. Pages longer than 36 bits make use of three codes, one indicating "the first 36 bits of a long page" another "not the last 36 bits of a long page", and the other indicating "the last 36 bits of a long page".

Resume pages contain the ECN and the PMID.

Short pages contain 2 bytes of MAC layer information. Zero length pages contain 20 bits of RFP identity and then 2 bytes of MAC layer information. See clause 7.2.4 for the format of the P_T messages. The broadcast controller in each TBC, CBC or DBC decides which type of MAC layer information is placed in the two byte field, and the information shall be specific to that RFP.

The BMC shall at least distribute full and resume pages to the broadcast controllers in TBCs, CBCs and DBCs for transmission in frame 0. The BMC need not distribute pages to the broadcast controllers in TBCs, CBCs, and DBCs for transmission in frames other than frame 0.

The broadcast controller in a TBC, CBC or DBC shall transmit the P_T type tail distributed to it by the BMC in the frame indicated by the BMC.

The MAC layer shall transmit an N_T type tail in frame 0 at least once every T205 seconds.

NOTE 4: FPs that allow PPs to enter into low duty cycle Idle_Locked mode (see clause 11.3.3) should transmit an N_T type tail in frame 0 of at least four multiframes every T205 seconds. The multiframes selected for these transmissions should be selected with care to ensure that all locked PPs can receive the N_T type tail. The FP that allows low duty cycle paging should also select the moment of transmitting MAC control paging (in any of 4 multiframes) such that all information can be received by a PP which is receiving only once.

The BMC shall not supply the bearers in its cluster with page messages that are older than T204 multiframes, measured from the time instant when the MAC_PAGE-req primitive was received. This limits the lifetime of a page message in the MAC layer.

NOTE 5: This limit applies to MAC layer repeats as well as to initial transmissions.

"Long" pages shall be issued by a cluster's BMC to all TBCs, CBCs and DBCs not more than once.

For FPs that do not allow PPs to enter into low duty cycle Idle_Locked mode (see clause 11.3.3) and provided that capacity is available and the lifetime of the page information in the MAC layer has not expired, then "resume", "short" and "full" pages shall be issued by the BMC at least once and may be repeated at most three times. New page messages have priority over repetitions.

For FPs that allow the PPs to enter into low duty cycle Idle_Locked mode, provided that capacity is available and the lifetime of the page information in the MAC layer has not expired, the BMC shall issue "resume", "short" and "full" pages for a first transmission to all TBCs, CBCs and DBCs. The BMC shall repeat the transmission of "short" and "full" page messages in the three multiframes following the first transmission of the messages, provided that the MAC layer lifetime has not expired. Repeats of page messages have priority over first transmissions of new page messages.

NOTE 6: MAC control added to short page messages (see clause 7.2.4) need not be the same for all repetitions.

NOTE 7: The FP broadcasts within the "fixed part capabilities" message (see clause 7.2.3.4) whether or not PPs are allowed to enter the low duty cycle Idle_Locked mode.

The normal and the fast paging may be combined, so that FPs could allow the PPs to enter into low duty cycle Idle_Locked mode by using the normal paging type and FPs could allow PPs that will stay in the high duty cycle Idle_Locked mode to establish the connection rapidly by using the fast paging type additionally.

9.1.3.2 PP paging procedures

9.1.3.2.1 PP paging detection

Idle_Locked is the normal state of a PP between calls. In this state the PP maintains synchronism with at least one RFP by receiving regularly P_T or N_T type tail messages on any bearer from an RFP. The frequency of the reception depends on the Idle_Locked mode:

- high duty cycle Idle_Locked mode;
- normal Idle_Locked mode;
- low duty cycle Idle_Locked mode.

These modes are described in clause 11.3.3 and define the ability to receive page messages.

9.1.3.2.2 PP paging processing

The extend flag should be used to extend normal page detection, irrespective of the CRC result (pass or fail).

The various lengths of page fields shall be handled as follows:

Resume page: the PT shall start bearer establishment by sending a Bearer_Request (advanced, ECN).

Zero length page: a MAC_PAGE-ind primitive shall not be issued. The contents of the P_T tail may be used by the portable termination.

Short and full page: the complete BS-channel SDUs should be delivered to the higher layer, irrespective of the CRC result (pass or fail) with a MAC_PAGE-ind primitive. For short pages the rest of the information in the P_T tail may be used by the PT.

Long page: the complete BS-channel SDU of a long page should be delivered to the higher layer with a MAC_PAGE-ind primitive, provided that all parts of the message (see clause 9.1.3.1) are received without error (CRC passed).

NOTE 1: The BMC in the PT may assemble a complete message from receptions on several bearers. However during reception of a long page message the PT should not lock to another RFP; it should wait until the end of the long page message has been detected because on different RFPs the page messages are not necessarily synchronized.

NOTE 2: Bearers from different RFPs may carry different page messages, but the page messages are the same for all RFPs belonging to one cluster.

9.2 Uplink connectionless procedures

9.2.1 General

This procedure allows the DLC layer in a PT to send a short protected message to the DLC layer in the FT. The PT's MAC layer may use a random access technique to select when to transmit the message.

To provide protection, the PT's MAC layer adds CRCs to the higher layer data.

The connectionless uplink service consists of one or two transmissions on a selected C/L uplink bearer. For connectionless uplink services the number of transmissions from a single PT shall not exceed N203 for any period of T215 multiframes.

Segment numbering is not defined for this service.

9.2.2 Bearer selection for the connectionless uplink

The "standard capabilities" Q_T message shall indicate whether an FT offers the connectionless uplink service. If it does not provide this service, the PT shall not attempt to make connectionless uplink transmissions. If a "connectionless uplink" service is provided, but C_F messages are not supported, the PT's MAC layer shall not attempt to transmit CL_F data.

When no C_F-channel is supported at the FT (see "standard capabilities", clause 7.2.3.4.2) and a PT's MAC layer receives a MAC_UP_CON-req primitive containing CL_F segments, the PT shall respond with a MAC_UP_CON-cfm primitive with the status parameter set to "CL_F not supported".

For RFPs of an FP which supports the C/L uplink service (see "fixed part capabilities", clause 7.2.3.4), the TDD pair of any dummy or C/L downlink bearer shall be considered as a C/L uplink bearer, i.e. the RFPs listen to the allocated channel in all TDMA frames.

If a dummy bearer or a connectionless downlink bearer can be found within T214 frames after receiving a MAC_UP_CON-req primitive, the PT shall use the TDD pair of this bearer. Otherwise the PT shall select a channel for the uplink service according to the procedure defined in clause 11.4.2.

NOTE 1: An RFP may provide one dummy bearer when traffic bearers are present. If a connectionless downlink service is needed this dummy bearer is converted to a connectionless bearer and is the only bearer at the RFP which supports the C/L downlink service. RFPs may broadcast the position of a permanent broadcast or connectionless bearer using the BMC service (P_T tail).

NOTE 2: At least one dummy bearer is always maintained when no traffic or connectionless bearer for downlink transmissions exist.

A dummy bearer is marked as a short bearer (no B-field) in the BA field of the A-field header and uses the normal identification for N_T tails.

A connectionless downlink bearer is marked by using a special identification for N_T tails.

9.2.3 Procedure for the connectionless uplink

9.2.3.1 Predicates

- 1) The PT shall be in the Idle_Locked or Active_Locked state.
- 2) the PT shall know of at least one bearer suitable for an uplink connectionless transmission (see clause 9.2.2).
- 3) the PT knows the FMID of a suitable RFP.
- 4) the PT has a CBC installed.

9.2.3.2 PT D-field construction

When the PT's MAC layer receives a MAC_UP_CON-req primitive it constructs one or two D-fields to be transmitted by its physical layer.

The A-field of the first D-field contains the "first PT transmission" TA bits; FMID; PMID; and a byte identifying the connectionless uplink service (see clause 7.2.5.6).

For the CL_F service as many CL_F segments as possible are placed in the B-field, and MAC layer CRCs are added. Segments of CL_F data are positioned according to the rules of clause 6.2.2.3.

If the SDU length is 0 (only PMID exchange) or 40 bits (CL_S service), the B-field may be filled in any manner with the BA code in the A-field header = 000, or need not even be transmitted at all with the BA code = 111.

A second D-field shall be constructed for CL_F services with 11 to 20 segments in double slot mode, with 5 to 8 CL_F segments in full slot mode, or with 2 CL_F segments in half slot mode, and for the CL_S service.

For the CL_S service the TA bits in the second D-field indicate data from the CL_S -channel by using either of the C_T tail coding and place the SDU in the tail.

For the CL_F services the A-field shall contain a M_T tail identifying the second transmission of a connectionless uplink service (see clause 7.2.5.6).

9.2.3.3 PT transmission sequence

Transmission sequence of the PT's CBC depends on the channel selection criteria:

- a) the selected channel is the TDD pair of a connectionless downlink or a dummy bearer;
- b) the PT selected a free channel.

Case a)

The transmission sequences are different for C/L uplink services using one or two transmissions:

1) One transmission:

- the PT sends the D-field in an arbitrarily chosen frame.

2) Two transmissions:

- the PT sends the first D-field in an arbitrarily chosen frame, and the second D-field on the same channel in the next TDMA frame.

NOTE 1: The uplink channel on the TDD pair of a dummy or C/L downlink bearer is not checked prior to transmission.

NOTE 2: Controlled by the higher layers retransmissions of the same C/L uplink data may occur. To prevent continuous collisions (e.g. two PTs start transmission in the same TDMA frame and use the same retransmission algorithm in their higher layers), the MAC layer should choose a random delay between receiving a MAC_UP_CON-req primitive and the beginning of the first transmission.

Case b)

- After selecting the channel (see clause 11.4) the PT sends the first D-field in any frame in time with the primary receiver scan of the FT;
- if the connectionless uplink service consists of two transmissions the PT sends the second D-field on the same channel in the next TDMA frame.

9.2.3.4 FT procedure

The FT may receive a C/L uplink transmission either on the TDD half of its dummy or connectionless downlink bearer, or by scanning for PT first transmissions. When receiving a PT's C/L uplink transmission marked as "first PP transmission" (see clause 7.1.2) with correct A-field CRC and containing the FT's FMID, the FT shall install a CBC to process the C/L uplink service.

The FT shall decide upon the coding of the M_T tail message (see clause 7.2.5.6) whether the PT uses a single transmission uplink service or a double transmission uplink service. If a double transmission uplink service is in progress the FT's CBC shall receive the second transmission in the next TDMA frame on the same connectionless uplink bearer.

If all data related to the C/L uplink service has been received correctly, i.e. with correct CRCs, the CMC issues a MAC_UP_CON-ind primitive to the DLC with the SDU containing received CL_F or CL_S data.

9.3 Non-continuous broadcast procedure

A-field and B-field procedures exist which allow PTs to acquire more Q-channel information and as a further BMC service to request a new dummy bearer.

9.3.1 Request for specific Q-channel information

A PT may acquire extended system information upon request. The procedure is initiated by the PT's LLME (see clause 11.2.1).

9.3.1.1 A-field procedure

PT procedure:

The PT creates two D-fields to be transmitted by its physical layer. The B-field of both transmissions may be filled in any manner or need not even be transmitted at all.

The A-field of the first D-field contains the "first PT transmission" TA bits, FMID, PMID, and a byte identifying the service (extended system information; see clause 7.2.5.6).

The A-field of the second D-field contains the M_T tail TA bits and the request in the A-field tail (see clause 7.2.5.10).

The PT selects a channel according to the rules for duplex bearers (see clause 11.4) and sends the first D-field in any frame in time with the primary receiver scan of the FT. The PT transmits the second D-field on the same channel in the next TDMA frame.

The PT then listens to the TDD pair of the bearer until a reply is received or time-out expires (T206, see clause 11.2.2).

FT procedure:

An FT receiving an extended system information request issues the request to the LLME (see clause 11.2.2). If the LLME replies the FT creates two D-fields to be transmitted. The B-field of both transmissions may be filled in any manner or need not even be transmitted at all.

The A-field header of both transmissions use the M_T tail TA bits.

The first A-field tail contains FMID, PMID, and a byte identifying the service (extended system information; see clause 7.2.5.6).

The second A-field tail contains the FT response (see clause 7.2.5.10).

The RFP selects the TDD pair of that channel on which the request was received and transmits the D-fields in two successive frames. The first D-field may be transmitted in any frame.

9.3.1.2 B-field procedure

PT procedure:

The PT creates one single D-field for the request. This D-field is marked as a "first PT transmission" in the A-field header. The A-field tail contains a special M_T tail identifying the transmission as part of the extended system information service. The B-field contains the request(s) (see clause 7.3.5).

The PT selects a free channel according to the rules for duplex bearers (see clause 11.4.2) and transmits the D-field in any frame in time with the primary receiver scan of the FT. The PT then scans the TDD pair of the bearer until a reply is received or time-out expires (T206, see clause 11.2.2). A reply is marked with the same M_T tail as used for the request. Replies are delivered to the LLME (see clause 11.2.1).

FT procedure:

An FT receiving a extended system information request issues the request to the LLME (see clause 11.2.2). If the LLME replies the FT creates one D-field with the A-field containing an M_T tail. This tail identifies the D-field as part of the extended system information service (see clause 7.2.5.6). The B-field contains the response from the LLME.

The RFP selects the TDD pair of that channel on which the request was received and transmits the D-field once on this channel in any frame.

9.3.2 Request for a new dummy bearer

A PT may request the continuous BMC service on a new dummy bearer. The PT, therefore, selects a channel according to the rules defined in clause 11.4 and prepares one single D-field. The D-field contains an A-field with an M_T tail identifying the service (see clause 7.2.5.6). The D-field is marked as "first PT transmission" (see clause 7.1.2). The B-field may be filled in any manner or need not even be transmitted at all. The PT transmits the D-field in any frame in time with the primary receiver scan of the FT on the selected channel.

The FT may ignore the PT's request or install the dummy bearer on the TDD half of that channel on which the request was received. A PT shall not attempt to change the dummy bearer position at an RFP after two successive unsuccessful attempts to this RFP.

10 Connection oriented service procedures

10.1 Overview

The connection oriented procedures use two peer-to-peer associations, connections and bearers. A connection is the association that is visible to the DLC layer, and each connection uses the services of one or more bearers as described in clause 5.6.

The procedures are described in the following groups:

- Connection control procedures:
 - connection setup (see clause 10.2);
 - connection modification (see clause 10.3);
 - connection release (see clause 10.4).
- Bearer control procedures:
 - bearer setup (see clause 10.5);
 - bearer handover (see clause 10.6);
 - bearer release (see clause 10.7).
- Data transfer (see clause 10.8):
 - CRFP connection control procedures (see clause 10.9).

The procedures are written in the style of a time sequence diagram, with the PT and FT procedures interlaced to represent the order of events. The steps are numbered as a single series, and the varied outcomes are described with a series of lettered substeps (3a, 3b etc).

10.2 C/O connection setup

Connection setup is the first phase of a connection orientated MAC service and the first phase of a connection handover. The phrase "Connection_Established" is defined to mean completion of setup at the MAC layer.

Connection setup can be originated from either side. These directions are defined as follows:

- MAC PT_originated;
- MAC FT_originated;
- MAC REP_originated.

All setup attempts for connection handover are PT_originated.

10.2.1 General

There are four connection setup processes:

- basic connection setup process, PT_terminated;
- normal connection setup process, PT_terminated;
- fast connection setup process, FT_terminated;
- complementary connection setup process, REP_terminated.

The basic setup process is used to set up a basic connection. The normal and fast setup processes create advanced connections (see clause 5.6).

The complementary connection setup process is used to set up a complementary connection (see clause 10.5.1.5).

10.2.2 Initiation of a basic and a normal connection setup

A basic or normal setup may be initiated by a network layer call that originates from either the PT or FT as detailed in the following overview:

FT_terminated call:

- FT higher layer sends a paging command to the PT higher layer;
- if this page is received successfully, the PT higher layer initiates a connection setup by issuing a MAC_CON-req primitive to the PT MAC layer.

PT_terminated call:

- the PT higher layer initiates a connection setup by issuing a MAC_CON-req primitive to the PT MAC layer.

10.2.3 Initiation of a fast connection setup

FT_terminated call only:

- the FT DLC initiates a connection setup without any prior paging by issuing a MAC_CON-req primitive to the MAC layer. This primitive is addressed to only one RFP and the address of the RFP shall be known in advance.

10.2.4 Connection setup procedure description

10.2.4.1 Creation of MBCs

Calling side:

A connection setup starts with the initiation process, either the DLC in the PT (basic and normal setup) or the DLC in the FT (fast setup) issues a MAC_CON-req primitive to its MAC.

This primitive includes a MAC Connection Endpoint Identifier (MCEI) which is used to identify all further primitives related to this connection.

For fast connection setup the MAC_CON-req primitive shall include the Radio fixed Part Number (RPN) to identify the RFP to which the PT is registered, and the calling address which is the PMID. If the wanted RFP cannot be addressed by the MBC the MAC issues a MAC_DIS-ind primitive to the DLC and releases the MBC entity.

If a connection is requested to perform a connection handover the MAC_CON-req primitive shall include the new and the old MCEI.

In addition, the MAC_CON-req primitive shall include the necessary parameters to identify the wanted service. After receiving a paging command the full service description is not always known by the PTs. Then the service has type "unknown".

If the MAC cannot establish a connection (e.g. an advanced connection is needed and the FT only supports basic connections) or the MAC does not support the wanted service (e.g. the MAC only knows basic connections and a data service is wanted) the MAC issues a MAC_DIS-ind primitive to the DLC and releases the MBC ending the procedure.

The MBC asks the LLME for allowance to set up the connection between the FT (as identified by its ARI) and the PT (as identified by its PMID). If a single bearer I_N _minimum_delay service is wanted and no C_F -channel is required the MBC may ask to establish a basic connection, otherwise the MBC asks for an advanced connection (see clause 5.6). If the new connection is for connection handover the MBC also issues the MCEI of the old connection to the LLME.

Whenever an MBC is allowed to establish an advanced connection the LLME assigns the Exchanged Connection Number (ECN) to the MBC.

The LLME may forbid the establishment of the desired connection (e.g. there already exists a basic connection, no further ECNs available). If a basic connection was requested by the MBC and then prohibited by the LLME, the MBC may reattempt by asking for an advanced connection.

If it is not allowed to set up the wanted connection the MAC issues a MAC_DIS-ind primitive to the DLC indicating the reason, and releases the MBC.

If the MBC is allowed to set up the connection the MAC reports the connection type (basic or advanced) with the MAC_CON-cfm primitive to the DLC after the successful setup of the first bearer.

NOTE 1: In the case of a successful connection setup there exists a common identification for the connection known at both, PT and FT. It consists of ARI + PMID (+ ECN) where the ECN only appears for advanced connections. For advanced connections this identification is always unique within the PT and the FT. For basic connections a duplication may occur only during connection handover.

NOTE 2: It is assumed that the PMID does not change during one connection (e.g. from an arbitrary PMID to a PMID derived from the assigned individual TPUI (see clause 11.7.2)).

The first task of the calling side's MBC is to invoke the creation of a new MBC at the called side. To allow the necessary radio transmissions at least one bearer controlled by a TBC shall exist. For setting up new bearers the MBC chooses one of the bearer setup procedures. The choice depends on the requested service (see clauses 10.2.4.2 and 10.2.4.3).

Higher layer control during connection setup:

At the calling side the MAC may enable transmissions of higher layer control even in the first transmission. After receiving the MAC_CON-req primitive the MAC may ask immediately for higher layer control segments with a MAC_CO_DTR-ind primitive (see clause 8.4.3).

Called side:

On the called side a new TBC is created by receiving a "bearer_request" message including both a calling address and its own address (FMID and PMID) on the scanned physical channel. The message type also contains the information if the new bearer belongs to a basic or an advanced connection.

The TBC has then to receive all necessary parameters to identify an MBC. The MBC is fully identified after:

- a) receiving with the "bearer_request" message either an access request or a handover request, including the calling address (FMID or PMID) and defining the connection type (advanced or basic); and
- b) for advanced connections only, receiving an ECN; and
- c) for basic connections and only in case of a handover request, an indication if bearer or connection handover is wanted.

NOTE 3: The parameters are not always known after the first received message, e.g. for setup procedures using the advanced connection control M_T message set, the conditions are fulfilled after receiving two messages, the "bearer_request" message and the "attributes_request" message (see clause 10.5.1.2.1).

The TBC issues PMID, ARI and for an advanced connection also the ECN to the LLME and indicates the purpose of the wanted connection (bearer/connection handover or new connection).

NOTE 4: For an FT initiated bearer setup the calling address is the FMID. But the PT has to be locked to the calling RFP and, therefore, the PT knows the FT's ARI.

The LLME can now decide:

- a) to release the TBC;
- b) to connect the TBC to an existing MBC; or
- c) to create a new MBC for connecting the TBC.

If a new MBC is needed the LLME requests the MAC to create a new MBC and assigns a MCEI to this MBC. The creation of a new MBC is reported to the DLC by issuing a MAC_CON-ind primitive after the first successful bearer setup. This primitive informs the DLC if a basic or an advanced connection is set up, and describes the wanted service type.

NOTE 5: The wanted service may be of type "unknown" at this moment.

Higher layer control during connection setup:

The called side may enable transmission of higher layer control after issuing the MAC_CON-ind primitive. The MAC has to ask for this higher layer control with a MAC_CO_DTR-ind primitive (see clause 8.4.3).

10.2.4.2 Establishment of a single bearer duplex connection of a known service type

This procedure is applied for all basic connections and for some advanced connections. Advanced connections are established with this procedure provided that:

- a) the MAC_CON-req primitive at the initiating side contained the full MAC layer service description; and
- b) the connection is a single bearer connection.

For a single bearer connection the duplex bearer setup is initiated by:

- a) the PT, for basic and normal connection setup;
- b) the FT, for fast connection setup.

With the creation of the MBC on the initiating side a connection setup timer (T200, see annex A) is started. A successful connection setup shall be completed before this timer expires. Otherwise the connection setup fails.

The MBC of the initiating side shall have knowledge of at least one available physical channel. The MBC shall also know the address (FMID or PMID) of the called part. The MBC creates a TBC and issues the called address (FMID/PMID) and the physical channel description to the new TBC. The MBC also indicates if the wanted bearer is used for bearer handover, connection handover or for a new MAC connection and which single bearer setup procedure has to be used. For advanced single bearer connections the logical bearer number of the only bearer shall be set to 15 (= "1111"). The MBC issues the LBN and the ECN to the TBC.

To establish the bearer the TBC uses one of the following procedures:

- a) the basic bearer setup procedure (see clause 10.5.1.1) for a basic connection setup;
- b) the PT initiated A-field advanced single bearer setup procedure (see clause 10.5.1.2.1) or the PT initiated B-field advanced single bearer setup procedure (see clause 10.5.1.3.1) for a normal connection setup;
- c) the FT initiated B-field advanced single bearer setup (see clause 10.5.1.3.2) for fast connection setup.

At the end of a setup procedure a TBC will report to the MBC either:

- "Bearer_established" or "bearer_setup_failed", indicating the reason.

NOTE 1: At the destination side these messages only occur if a bearer setup attempt was detected and a new MBC was created.

If a bearer setup attempt failed the TBC is released (see bearer setup procedures). The calling MBC can reattempt with the same procedure up to N200 (see annex A) times, subject to using a new available channel each time and/or accessing a new RFP (see clause 11.4.2). Each reattempt is reported to the DLC with a MAC_RES_DLC-ind primitive.

NOTE 2: This reporting of reattempts is necessary to support overlapped setup, whereby setup of the higher layers occurs at the same time as setup of the MAC layer.

Explanation: The MAC forgets acknowledged higher layer data and so this data cannot be repeated in a MAC bearer setup reattempt. The primitive, therefore, tells the higher layers that a new connection setup was started automatically. Higher layers shall restart their overlapped procedures, or shall release the MAC setup with a MAC_DIS-req primitive.

If the setup attempt fails N200 + 1 times or the connection setup time-out (T200) expires, the initiating MAC reports "setup_failure" to its DLC, using a MAC_DIS-ind primitive with the reason and releases the MBC. This event is also reported to the LLME.

At the called side it is not always possible to recognize how often setup attempts fail. Here the MBC is always released when "bearer_setup_failed" was recognized (see single bearer setup procedures) or by a time-out (e.g. T200 or T201). The connection setup timer (T200) for a new MBC shall be started at creation of the MBC. Release of an MBC at the called side is always reported to the LLME, and to its DLC with a MAC_DIS-ind primitive provided that a MAC_CON-ind primitive was issued before.

NOTE 3: This condition may occur if a bearer setup was successful at the called side but failed at the calling side. Here the calling side may reattempt to setup a bearer.

An MBC assumes that a bearer setup was successful when the TBC reported "bearer_established".

When the TBC at the called side reports "bearer_established" the MBC knows all necessary MAC parameters for the wanted service. If the MAC does not support the wanted service it will proceed with a connection release procedure and should indicate the reason (see clause 10.4).

If the MAC supports the service the connection setup for a single bearer connection is completed. Immediately after the TBC reported "bearer_established" the MAC reports "connection_established" plus service parameters with a MAC_CON-ind primitive at the called side or with a MAC_CON-cfm primitive at the initiating side to the DLC. All following transmissions may contain valid I-channel data and the MAC uses the appropriate multiplex for the wanted service.

10.2.4.3 Establishment of multi-bearer connections and connections needing service negotiation

Overview:

The following service negotiation procedures shall be used to establish all asymmetric connections, and shall also be used for symmetric multi-bearer connections.

The procedure shall also be applied for connections with service type "unknown".

Channel list messages shall be used for the establishment of asymmetric connections as defined in clause 10.5.1.4. Channel list messages should be used for all multibearer connection establishment.

During a multi-bearer connection establishment, the first pilot (duplex) bearer within one connection shall be set up by the initiating side (see clauses 10.2.2 and 10.2.3). Either of the two MBCs may be the master for all subsequent bearer establishment in the sense that this MBC initiates all of the remaining bearer setups.

The multi-bearer connection establishment procedure starts with the setting up of one duplex bearer, the "pilot channel". This allows the service type to become known, (if it was unknown), and initial channel list messages to be exchanged.

NOTE 1: Channel list messages and procedures are described in clause 10.5.2.

The pilot (duplex) bearer setup is initiated by:

- the PT, for normal connection setup;
- the FT, for fast connection setup.

Procedure description:

The receipt of a MAC_CON-req primitive causes the creation of the MBC on the initiating side and the starting of a connection setup timer (T200). A successful connection setup shall be completed before this timer expires. Otherwise the connection setup fails and any bearers that have been set up are released.

The MBC of the initiating side shall have knowledge of at least one available physical channel. The MBC shall also know the address (FMID or PMID) of the called part. The MBC creates a TBC and issues the called address (FMID/PMID) and the physical channel description to the new TBC. The MBC also indicates if the wanted pilot bearer is used for connection handover or for a new connection. For the pilot bearer the MBC sets the logical bearer number to 15 (= "1111") and issues the LBN and the ECN to the TBC.

To establish the bearer the TBC uses one of the following procedures:

- the PT initiated A-field advanced single bearer setup procedure (see clause 10.5.1.2.1) or the PT initiated B-field advanced single bearer setup procedure (see clause 10.5.1.3.1) for a normal connection setup;
- the FT initiated B-field advanced single bearer setup (clause 10.5.1.3.2) for fast connection setup.

At the end of a setup procedure a TBC will report to the MBC either:

- "bearer_established"; or
- "bearer_setup_failed", indicating the reason.

NOTE 2: At the destination side these messages only occur if a bearer setup attempt was detected and a new MBC was created.

If a bearer setup attempt failed the TBC is released (see bearer setup procedures) and the calling MBC can reattempt with the same procedure up to N200 (see annex A) times, subject to using a new available channel each time and/or accessing a new RFP (see clause 11.4.2). Each reattempt is reported to the DLC with a MAC_RES_DLC-ind primitive.

NOTE 3: This reporting of reattempts is necessary to support overlapped setup, whereby setup of the higher layers occurs at the same time as setup of the MAC layer.

Explanation: The MAC forgets acknowledged higher layer data and so this data cannot be repeated in a MAC bearer setup reattempt. The primitive, therefore, tells the higher layers that a new connection setup was started automatically. Higher layers shall restart their overlapped procedures, or shall release the MAC setup with a MAC_DIS-req primitive.

If the setup attempt fails N200 + 1 times or the connection setup time-out expires (T200) the initiating MAC reports "setup_failure" to the DLC, using a MAC_DIS-ind primitive with the reason set and releases the MBC. This event is also reported to the LLME.

At the called side it is not always possible to recognize how often setup attempts fail. Here the MBC is always released when "bearer_setup_failed" was recognized (see single bearer setup procedures) or by a time-out (e.g. T200 or T201). The setup timer (T200) for a new MBC shall be started at the creation of the MBC. A release of an MBC is always reported to the LLME, and to the DLC with a MAC_DIS-ind primitive provided that a MAC_CON-ind primitive was issued before.

An MBC assumes that a bearer setup was successful when the TBC reported "bearer_established".

When the TBC at the called side reports "bearer_established" the called MBC may know all the necessary MAC parameters for the wanted service. If the service is defined and the called MAC does not support this service it will proceed with a connection release procedure and should indicate the reason (see clause 10.4). Otherwise the MBC issues a MAC_CON-ind primitive to the DLC.

The MBC on the initiating side issues a MAC_CON-cfm primitive to the DLC after the TBC reported "bearer_established".

If the service is not fully defined, e.g. the service type is "unknown" or the number of bearers is undefined, the connection is in a pending state until the DLC on either side issues a MAC_MOD-req primitive that shall contain all necessary parameters.

NOTE 4: For PT initiated calls the MAC_MOD-req primitive may be issued at the same time as the MAC_CON-req primitive.

NOTE 5: A MAC_MOD-req primitive is needed for all multibearer connections.

The MBC at the side where the MAC_MOD-req primitive was issued shall release the connection when the wanted service is not able to be supported. Otherwise the MBC sends repeatedly the appropriate attributes and/or bandwidth request messages, until these messages are confirmed or a connection release is recognized. If both messages are needed, the bandwidth request message shall not precede the attribute request message.

When negotiating the bandwidth the requesting side shall propose the wanted bandwidth. The bandwidth confirm message, however, may contain the same minimum and target number of bearers or a reduced number of bearers. The negotiated bandwidth is given by the numbers in the confirm message. If the bandwidths in the request and confirm message are different the MBC at the initiating side shall issue a MAC_BW-ind primitive to the DLC. When the offered bandwidth is sufficient for the service the DLC shall reply with a MAC_BW-res primitive, otherwise with MAC_DIS-req primitive. The latter case shall cause a connection release.

MAC_MOD-ind and MAC_MOD-cfm shall not be issued until the connection is fully established. To establish the other bearers of the connection (additional duplex or double simplex bearers) the access_request message shall always be used, even in case the pilot bearer has been setup for connection handover.

Now the two MBC functions have the same, complete, knowledge of the connection that is required. Further progress depends upon the service type:

- symmetric connection;
- asymmetric uplink connection; or
- asymmetric downlink connection.

Additional bearers for ciphered connections shall be established in clear and afterwards they shall be switched to the current encryption state.

10.2.4.3.1 Symmetric connection

A symmetric connection is one that offers a symmetric I-channel service to the DLC. The eventual bandwidth and service type for the direction PP to FP and FP to PP are identical. A symmetric connection shall only use duplex bearers.

If the connection is a single bearer connection (previously of type "unknown"), this is now established and MAC_MOD-ind and MAC_MOD-cfm primitives are issued.

Otherwise this is a multibearer connection, and all following bearer set ups shall be PT initiated. The PT shall "add" duplex bearers using the A-Field advanced or B-Field single bearer setup procedures (see clauses 10.5.1.2.1 and 10.5.1.3.1). The channel list procedures described in clause 10.5.2 should be used to decrease the connection establishment time by negotiating changes to the receiver scanning patterns at the receiving side.

10.2.4.3.2 Asymmetric uplink connection

An asymmetric uplink connection is one that offers an asymmetric I-channel service to the DLC. It shall use a mixture of double simplex bearers in the direction PP to FP and duplex bearers.

For all subsequent double simplex bearer setups the PT is the T-side. The double simplex setup procedure is described in clause 10.5.1.4.

The number of duplex bearers shall be determined by the MBC in the PT, and at least one duplex bearer shall be maintained at all times. The PT may add duplex bearers by using the procedures defined in clauses 10.5.1.2.1 or 10.5.1.3.1. For setting up further duplex bearers the channel list procedures (see clause 10.5.2) should be used in order to decrease the connection establishment time.

10.2.4.3.3 Asymmetric downlink connection

A asymmetric downlink connection is one that offers an asymmetric I-channel service to the DLC. It shall use a mixture of double simplex bearers in the direction FP to PP and duplex bearers.

For all subsequent double simplex bearer setups the FT is the T-side. The double simplex setup procedure is described in clause 10.5.1.4.

The number of duplex bearers shall be determined by the MBC in the FT, and at least one duplex bearer shall be maintained at all times. The FT may add duplex bearers by using the procedures defined in clauses 10.5.1.2.2 or 10.5.1.3.2. For setting up further duplex bearers the channel list procedures (see clause 10.5.2) should be used in order to decrease the connection establishment time.

10.2.4.3.4 Connection established

When the number of established bearers equals the "minimum" parameter the MBC entities shall issue the appropriate MAC_MOD primitive (ind or cfm) to report "connection_established". The MBCs shall keep attempting to obtain the "target" number of bearers until the connection setup timer (T200) expires, and may try to obtain this number of bearers afterwards.

If the connection set up timer expires at either side before the "minimum" number of bearers are established, a MAC_DIS-ind primitive is issued containing "connection_establishment_failure" and all established bearers are released. The release of the bearers shall cause the other side to issue a MAC_DIS-ind primitive.

All transmissions following the MAC_MOD-ind or MAC_MOD-cfm primitive respectively may contain valid I-channel data and the MAC shall use the appropriate multiplex for the wanted service.

The number of bearers established shall not exceed the agreed target number.

NOTE: The receiving side should send a Release message (with release reason "Target number exceeded") in response to an access_request for a new bearer which would exceed the agreed target number.

10.3 C/O connection modification

10.3.1 Advanced connection: bandwidth modification

The DLC on either side may initiate a connection modification of an advanced connection by issuing a MAC_MOD-req primitive.

Bandwidth modifications to existing connections allow the bandwidth to be changed, i.e. the number of required bearers. The transmission direction of double simplex bearers may be switched by using the fast release procedure (see clause 10.7.2.3). Switching a bearer from duplex to double simplex and vice versa is prohibited.

NOTE 1: A bandwidth change may switch a single bearer connection to a multibearer connection and vice versa.

NOTE 2: A bandwidth change may switch an asymmetric connection to a symmetric connection and vice versa or may change the direction of an asymmetric connection.

NOTE 3: Some bandwidth change requests may cause ambiguous situations of the MAC I-channel data flow, e.g.:

- the wanted minimum number of simplex bearers in one direction is above the actual number of established bearers, and, therefore, the MAC cannot provide the new service instantaneously;
- sequencing of data segments in I_{N_normal_delay} and I_{p_error_detection} services might fail during the establishment of new bearers.

NOTE 4: In multibearer connections the sequencing of I-channel data segments for I_{N_normal_delay} and I_{p_error_detection} services can only be guaranteed by the MAC layer if the minimum number of needed bearers equals the target number of bearers. Adding or releasing bearers during a call may cause ambiguous situations (see clauses 8.4.3 and 10.8.3.2).

Whenever the bandwidth change might cause ambiguity for the data service it is assumed that the side which invokes the connection modification has already negotiated the modification at a higher layer. In these cases, the receiving DLC should ignore I-channel data delivered before receiving a MAC_MOD-ind or -cfm primitive.

The MBC at the initiating side sends the appropriate bandwidth request message (A-field or B-field) in up to five successive allowed frames until a bandwidth confirm message is received or a connection release is recognized. The bandwidth request and confirm messages shall be exchanged on the duplex bearer of the connection characterized by the highest logical bearer number (LBN). If after five consecutive bandwidth request messages being sent no bandwidth confirm message is detected, the MBC at the initiating side shall react as if a bandwidth confirm message to the current band was received.

The bandwidth confirm message may contain the same minimum and target number of bearers or reduced number of bearers. The negotiated bandwidth is given by the numbers in the confirm message. If the bandwidths in the request and confirm message are different the MBC at the initiating side shall issue a MAC_BW-ind primitive to the DLC. When the offered bandwidth is sufficient for the service, the DLC shall reply with a MAC_BW-res primitive, otherwise with a MAC_DIS-req primitive.

A bandwidth request from the far side should be answered before a bandwidth request from the near side may be sent. A bandwidth confirm message should be regarded as acknowledged when no further bandwidth request message is received in the next suitable frame. A bandwidth request or a bandwidth confirm message shall be taken into account by the receiving side only if error free, that means message type decoded and the corresponding CRC passed.

Example:

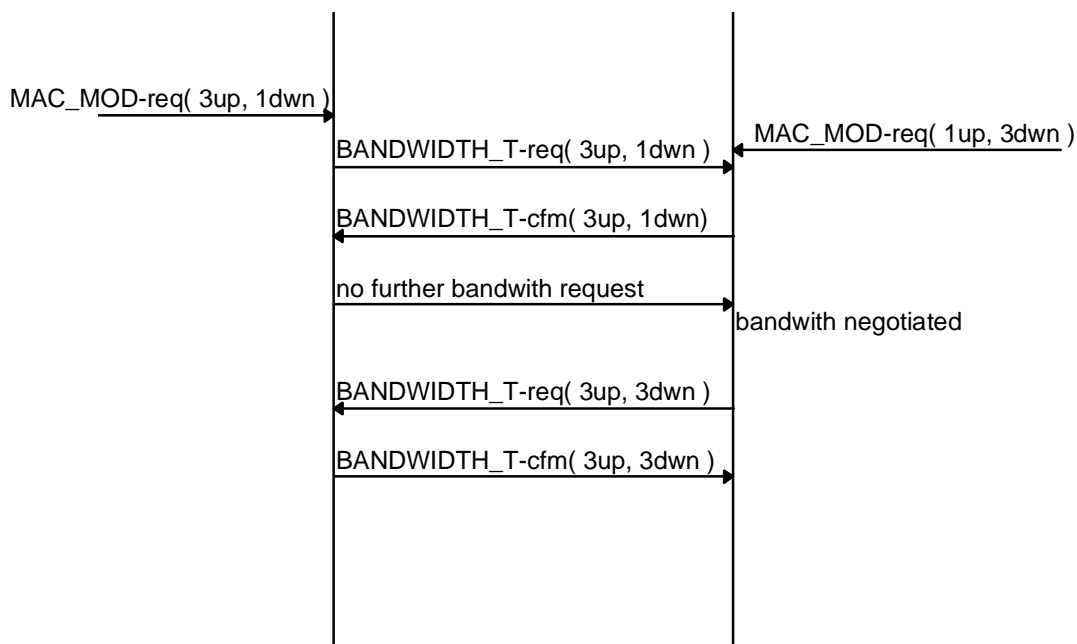

Figure 10.1: Bandwidth Modification example

In case of a request to decrease the bandwidth the receiving side may reply with the actual bandwidth.

After this negotiation the agreed bandwidth for both directions may be the same (e.g. the far end does not allow a change and the bandwidth is still sufficient). For this case the procedure ends.

To modify the connection according to the negotiated new bandwidth one of the MBC is the master in the sense that only this MBC may initiate new bearer setups. If the modified connection is symmetric or an asymmetric uplink, the PT is the master. For asymmetric downlink connections the FT is the master.

The slave shall release all existing double simplex bearers in the direction slave to master. Independently for each double simplex bearer, the slave shall choose either the unacknowledged release procedure or the fast release procedure. The fast release procedure allows the immediate setup of a new double simplex bearer on the same physical channels but in the reverse direction.

First the master shall release bearers, such that in neither direction the established number of bearers remains above the target number.

If in both directions the number of surviving bearers is equal to or greater than the minimum number of bearers, both MBCs, issue a MAC_MOD primitive (-ind or -cfm) to indicate the new available bandwidth. The masters MBC may still try to setup the target number of bearers.

If in either direction the number of surviving bearers is less than the minimum required bearers the connection modification timer (T211) is started and the master tries to setup the required number of bearers using the procedures in clause 10.2.4.3.1 through clause 10.2.4.3.3. If the minimum number of bearers is not established before the connection modification timer expires, the MBCs send a MAC_DIS-ind primitive to the DLC. As a consequence the connection is released.

The modification is successfully completed when the minimum number of bearers is established before the modification timeout expires. This event is reported to the DLC on both sides with a MAC_MOD primitive (-ind or -cfm). The master's MBC may still try to achieve the target number of bearers even after the connection modification timer expires (T211).

The number of bearers established shall not exceed the agreed target number.

NOTE 5: The receiving side should send a Release message (with release reason "Target number exceeded") in response to an access_request for a new bearer which would exceed the agreed target number.

10.3.1.1 Suspend and Resume

The suspend and resume procedures are particular cases of Bandwidth Modification. In the suspend procedure, the negotiated bandwidth value is zero. As result of this modification the "logical connection" will pass to "suspended state" and all physical connection associated to it will be release.

The connection resumption is the procedure to leave the suspended state by setting up a pilot duplex bearer, followed by bandwidth modification when necessary. The "logical connection" will pass to "active state" as result of the connection resumption procedure. The resumption procedure can be initiated either by FP or PP. The FP could use the MAC-resume paging in order to initiate the connection resume procedure.

10.3.1.2 MAC resume paging

MAC resume paging is the procedure which may be used by the FP MBC to resume a suspended MAC connection without using fast connection setup procedures.

The FP MBC may, if the PP is known not to support fast setup or if this procedure has previously failed, issue a resume page message using the MAC page procedure (see 9.1.3.1) and start timer an implementation dependent timer. If the PP supports fast paging and is known to be in high duty cycle Idle_Locked mode, fast paging shall be used. The PP MBC shall reply the resume page message only if a suspended connection with the indicated PMID and ECN exists by resuming the connection, i.e. initiating a set up of the physical connection followed by a bandwidth modification. The FP MBC shall stop the timer if a successful resume is made within the duration of the timer. If the timer expires, the procedure shall be considered failed and this shall be indicated to the higher layers.

The value of the timer is up to the implementor.

10.3.2 Advanced connection: service type or slot type modification

The procedures from this section can be used to change the service type and or the slot type of an existing advanced connection. The following procedures are given in detail: service type modification, slot type modification (i.e. full to double slot and double to full slot).

The modification of a connection service type and/or slot type starts with the initiation process, the DLC in either the PT or the FT, issuing a MAC_MOD-req primitive to its MAC.

This primitive includes the following parameters:

- MCEI: used to identify the connection at which the request applies;
- ECN: used to identify the connection at which the request applies;
- switching type: used to identify the requested switching;
- slot type: used to identify the requested slot type;
- service type: used to identify the requested service type.

The relevant MAC messages shall be exchanged on a duplex bearer of the connection.

Procedure for service type modification:

The initiating side, which is the one that has received the MAC_MOD-req primitive, starts to transmit in the next allowed frame the attributes_T_request (advanced connection control set). This is repeated in the five successive allowed frames or until the initiating side receives the attributes_T_confirm (advanced connection control set).

The initiating side shall acknowledge the receipt of the attributes_T_confirm message by the transmission of an other message in the next TDMA frame. For this procedure the other message means any other message than a MAC release message or a repeated attributes_T_request message in a frame suitable for retransmission of the attributes_T_request message.

If the attributes_T_confirm is not received the initiating side shall release the connection and the DLC layer is informed using the MAC_DIS-ind primitive.

After receiving the attributes_T_request message from the initiating side, the receiving side shall start the T218 timer within which the switching procedure (attributes scenario) shall be completed and it shall transmit the attributes_T_confirm message. Every time the attributes_T_request is received from the initiating side (repeated) the attributes_T_confirm shall be retransmitted to the initiating side.

If the timer expires the receiving side shall release the connection and the DLC layer is informed using the MAC_DIS-ind primitive.

After the attributes scenario has been performed successfully, the MAC at both sides sends to the DLC the MAC_MOD primitive, confirm or indication indicating that the old connection has changed its service profile as requested and that the procedure has been successfully completed.

For the timing, when to switch to the new service type, the following rules shall apply:

The attributes_T_confirm message is the first burst sent by the responding side containing data of the new service type. All following bursts sent by the responding side shall contain data of the new service type. The initiating side may assume received data to be of the new service type starting from that burst containing the attributes_T_confirm message. From that TDMA frame where the first attributes_T_confirm message is expected up to the first error free received attributes_T_confirm message, received user data should be ignored due to the uncertain service type used.

The other message is the first burst sent by the initiating side containing data of new service type. All following bursts sent by the initiating side shall contain data of the new service type. The responding side may assume received data to be of the new service type starting from that burst containing the other message. From that TDMA frame where the first other message is expected up to the first error free received other message, received user data should be ignored due to the uncertain service type used.

Procedure for slot type modification full to double

- FT initiated:

The initiating side (i.e. the FT), starts to transmit in the next allowed frame the attributes_T_request (advanced connection control set). This is repeated in the five successive allowed frames or until the attributes_T_confirm (advanced connection control set) is received.

The initiating side shall acknowledge the receipt of the attributes_T_confirm message by the transmission of an other message in the next TDMA frame and after that it shall start the handover procedure.

If the attributes_T_confirm is not received the initiating side shall release the connection and the DLC layer is informed using the MAC_DIS-ind primitive.

The receiving side after receiving the attributes_T_request message from the initiating side, shall start the T218 timer within which the switching procedure (attributes scenario and handover scenario) shall be completed and it shall transmit the attributes_T_confirm message. Every time the attributes_T_request is received from the initiating side (repeated) the attributes_T_confirm shall be retransmitted to the initiating side.

If the timer expires the receiving side shall release the connection and the DLC layer is informed using the MAC_DIS-ind primitive.

If the handover procedure fails, the connection is released and the DLC is informed using the MAC_DIS-ind primitive. After the handover procedure has been performed successfully, the MAC at both sides sends to the DLC the MAC_MOD primitive, confirm or indication indicating that the old connection has changed its slot type as requested and that the procedure has been successfully completed.

- PT initiated:

For connection modification PT initiated, the attributes exchange scenario shall not apply and only the handover procedure shall be performed: the PT after receiving the MAC_MOD-req primitive starts the handover scenario directly.

NOTE: For the handover procedure either the bearer or the connection handover can be used.

Procedure for slot type modification double to full:

The initiating side, which is the one that has received the MAC_MOD-req primitive, starts to transmit in the next allowed frame the attributes_T_request (advanced connection control set). This is repeated in the five successive allowed frames or until the initiating side receives the attributes_T_confirm (advanced connection control set): the slot is still double.

The initiating side shall acknowledge the receipt of the attributes_T_confirm message by the transmission of an other message in the next TDMA frame. The MAC layer then switches from double to full slot releasing the second part of the double slot and sends to its DLC the MAC_MOD-cfm primitive with the "result" parameter set to accept and the "slot type" parameter set to full.

If the attributes_T_confirm is not received the initiating side shall release the connection and the DLC layer is informed using the MAC_DIS-ind primitive.

After receiving the attributes_T_request message from the initiating side, the receiving side shall transmit the attributes_T_confirm message: the slot type is still double. Every time the attributes_T_request is received from the initiating side (repeated) the attributes_T_confirm shall be retransmitted to the initiating side.

After receiving the other message the receiving side switches to a full slot releasing the second part of the double slot and sends to the DLC the MAC_MOD-ind with the "result" parameter sets to accept and the "slot type" parameter sets to full.

At both DLC layers, the receipt of this primitive (MAC_MOD-cfm or ind) acts as a synchronization signal for the U-Plane switching procedure. Then, the DLC in both initiating and receiving side shall switch correctly the C-Plane link and U-plane service and release the old link. The DLC at both sides indicates to the LLME that the procedure has been correctly done.

10.3.3 Connection type modification

These procedures can be used to change connection type (basic to advanced or advanced to basic). During the same procedure the service type and/or slot type of an existing connection can also be changed.

In this section the following three procedures are given in detail: the basic to advanced connection type modification, the advanced to basic connection type modification and the basic to advanced connection type modification plus full to double slot type modification.

A connection type modification starts with the initiation process, the DLC in either the PT or the FT, issuing a MAC_MOD-req primitive to its MAC.

This primitive includes the following parameters:

- MCEI: used to identify the basic/advanced connection at which the request applies;
- ECN: the new value that will be assigned to the basic connection changed in an advanced one;
- switching type: used to identify the requested switching (i.e. basic to advanced);
- slot type: used to identify the requested slot type;
- service type: used to identify the requested service type.

The relevant MAC messages shall be exchanged on a duplex bearer of the connection.

Procedure for connection type modification basic to advanced:

The initiating side, that is the one that has received the MAC_MOD-req primitive, starts to transmit in the next allowed frame the attributes_T_request (basic connection control set). This is repeated in five successive allowed frames or until the initiating side receives the attributes_T_confirm (basic connection control set).

The initiating side shall acknowledge the receipt of the attributes_T_confirm message by the transmission of another message in the next TDMA frame.

If the attributes_T_confirm is not received the initiating side shall release the connection and the DLC layer is informed using the MAC_DIS-ind primitive.

After receiving the attributes_T_request message from the initiating side, the receiving side shall start the T218 timer within which the switching procedure (attributes scenario) shall be completed and it shall transmit the attributes_T_confirm message. Every time the attributes_T_request is received from the initiating side (repeated) the attributes_T_confirm shall be retransmitted to the initiating side.

If the timer expires the receiving side shall release the connection and the DLC layer is informed using the MAC_DIS-ind primitive.

After the attributes scenario has been performed successfully, the MAC at both sides sends to the DLC the MAC_MOD primitive, confirm or indication indicating that the old connection identified by the MCEI has changed its connection type as requested and is now identified by the pair old MCEI and new ECN and that the procedure has been successfully completed.

Procedure for connection type modification advanced to basic:

The same procedure as the one used for connection type modification basic to advanced shall apply with the following exceptions:

- The attributes_T_request/confirm messages shall belong to the advanced connection control set.
- The new (basic) connection shall be identified only by the same MCEI which identified the old (advanced) connection.

Procedure for connection type modification basic to advanced plus slot type modification full to double:

The initiating side, which is the one that has received the MAC_MOD-req primitive, starts to transmit in the next allowed frame the attributes_T_request (basic connection control set). This is repeated in five successive allowed frames or until the initiating side receives the attributes_T_confirm (basic connection control set).

The initiating side shall acknowledge the receipt of the attributes_T_confirm message by the transmission of an other message in the next TDMA frame and after that it shall start the handover procedure.

If the attributes_T_confirm is not received than the initiating side shall release the connection and the DLC layer is informed using the MAC_DIS-ind primitive.

After receiving the attributes_T_request message from the initiating side, the receiving side shall start the T218 timer within which the switching procedure (attributes scenario and handover scenario) shall be completed and it shall transmit the attributes_T_confirm message. Every time the attributes_T_request is received from the initiating side (repeated) the attributes_T_confirm shall be retransmitted to the initiating side.

If the timer expires the receiving side shall release the connection and the DLC layer is informed using the MAC_DIS-ind primitive.

If the handover procedure fails, the connection is released and the DLC is informed using the MAC_DIS-ind primitive.

After the handover procedure has been performed successfully, the MAC at both sides sends to the DLC the MAC_MOD primitive, confirm or indication indicating that the old connection identified by the MCEI has changed its service profile as requested and is now identified by the pair old MCEI and new ECN and that the procedure has been successfully completed. The DLC can now perform the switching of the U-plane channel. The DLC at both sides indicates to the LLME that the procedure has been correctly done.

NOTE: For the handover procedure either the bearer or the connection handover can be used.

10.3.4 Modulation type modification

The modulation type modification defined by this clause can only be used to modify the modulation type of the B-field while keeping a 2 level modulation for the A-field.

At MAC layer, the modulation type modification procedure shall always be PT initiated.

The modulation scheme is associated to a physical connection. A physical connection is always set up using the default modulation scheme (Ref. Note 1) and might be switched to a higher layer negotiated modulation scheme afterwards using the procedure defined by this clause. For a multibearer connection, the modulation type negotiation can take place onto one of the duplex bearers of the connection.

All the bearers of a MAC connection shall always be setup by using the default modulation scheme (Ref. Note 1); in case a different modulation scheme has been negotiated (e.g. a high level one) for the associated physical connection, this shall be used onto the new bearer immediately after bearer establishment (for the definition of "Bearer established", see clause 10.5). This rule applies for bearer handover as well. In case of connection handover, and if the required modulation scheme is different from the default one, the modulation type modification procedure defined by this clause shall be started again.

NOTE 1: The "default" modulation scheme is profile dependant.

Procedure description:

- PT side:

The DLC layer of the initiating side shall start the modulation type modification procedure by issuing the MAC_MOD.req primitive, with the required modulation type, to the MAC layer.

At the MAC_MOD.req primitive detection, the MBC shall send, in the next allowed frame, the appropriate Attributes_T_request message (see clause 7.2.5.3.8 for coding) to the peer entity.

This is repeated in up to five successive allowed frames or until the PT receives the attributes_T_confirm message. If the attributes_T_confirm is not received after five retransmissions of the attributes_T_request message, the PT shall release the connection and the DLC layer is informed using the MAC_DIS-ind primitive.

As soon as the `Attributes_T_confirm` message is detected, the MBC shall issue the `MAC_MOD.cfm` primitive, with the negotiated modulation scheme, to the DLC layer.

The PT shall acknowledge the receipt of the `attributes_T_confirm` message by the transmission of an other message in the next TDMA frame. For this procedure the other message means any other message than a MAC release message or a repeated `attributes_T_request` message in a frame suitable for retransmission of the `attributes_T_request` message.

- FT side:

At the detection of the `Attributes_T_request` message, the MBC shall issue the `MAC_MOD.ind` primitive, with the required modulation type, to the DLC layer.

The DLC can either decide to release the connection, (e.g. in case the required modulation scheme is not acceptable for the service) or shall send the `MAC_MOD.res` primitive, with the agreed modulation type, to the MAC layer.

At the reception of the `MAC_MOD.res` primitive, the MBC shall send, in the next allowed frame, the appropriate `Attributes_T_confirm` message (see clause 7.2.5.3.8 for coding) to the peer entity.

The MBC shall confirm all the following `Attributes_T_request` messages which it can receive after the first `Attributes_T_confirm` message has been sent.

NOTE 2: The `Attributes_T_confirm` message is detected if message type decoded and modulation type indication coincident with the required one.

For the timing, when to switch to the new service type, the following rules shall apply:

The `attributes_T_confirm` message is the first burst sent by the FT using the new modulation type. All following bursts sent by the FT shall use the new modulation type. The PT may process received data according to the new modulation type starting from that burst containing the `attributes_T_confirm` message. From that TDMA frame where the first `attributes_T_confirm` message is expected up to the first error free received `attributes_T_confirm` message, received B-field data should be ignored due to the uncertain modulation type used.

The other message is the first burst sent by the PT using the new modulation type. All following bursts sent by the PT shall use the new modulation type. The FT may process received data according to the new modulation type starting from that burst containing the other message. From that TDMA frame where the first other message is expected up to the first error free received other message, received B-field data should be ignored due to the uncertain modulation type used.

10.4 C/O connection release

10.4.1 General

Connection release is the last phase of a connection orientated MAC service. During connection release an existing MBC will be released. This action is reported to the LLME and to the DLC if necessary.

Several events can cause a release of an established connection:

- a) the DLC of either side issues a `MAC_DIS-req` primitive to the MBC;
- b) during connection setup, an MBC was created for a service which is not provided by the MAC (e.g. I_p data service requested on an FT which supports only I_N services);
- c) due to a bearer release, a TBC reports "connection_release" to the MBC (i.e. in the received `RELEASE` message the reason was set to "connection_release");
- d) as a result of bearer release, no TBC controlling a duplex bearer exists;
- e) due to a bearer release, the MBC cannot maintain the minimum acceptable service.

The events d) and e) do not cause a connection release if they are consequence of a connection suspend procedure.

The events d) and e) do not cause a connection release if the service allows a suspension connection procedure. In this case, the MBC will inform the LLME.

Event a) describes the initiation of a normal connection release. The DLC of either side decides to release the connection. As a consequence, one of the events c), d) or e) will cause a connection release at the opposite side.

During connection setup, event d) does not normally cause a connection release at the calling side. Before the MAC_CON-cfm primitive is issued to the DLC the event d) only causes a connection release when the TBC reports that the MAC service cannot be provided to the MBC. Without this report the MBC may reattempt the bearer setup (see clause 10.2.4).

Events d) and e) may occur at any time due to a bearer failure.

NOTE: A bearer release will be the consequence if a bearer fails.

10.4.2 Procedure description

If an MBC receives a MAC_DIS-req primitive from its DLC the MBC initiates a bearer release on all TBCs and disconnects the TBCs. The MAC releases the MBC and reports this event to the LLME.

During connection setup, one of the MBCs may be asked to provide a service that cannot be provided by its MAC layer. In this case that MBC initiates bearer release at all TBCs and then disconnects these TBCs. A MAC Layer issues a MAC_DIS-ind if it has received a MAC_CON-req or already issued a MAC_CON-ind. The MAC releases the MBC and reports this event to the LLME.

A TBC may report bearer released to the MBC for several reasons, e.g. bearer failed due to a timeout or release message received. The MBC disconnects this TBC and tests if:

- the last duplex bearer has been released;
- the wanted service cannot be provided further;
- the TBC indicated a connection release.

The occurrence of at least one of these events will normally cause a connection release (exception see clause 10.4.1, comment to events d) and e)). The MBC initiates a bearer release on all remaining TBCs and disconnects the TBCs. A MAC layer issues a MAC_DIS-ind if it has received a MAC_CON-req or already issued a MAC_CON-ind. The MAC releases the MBC and reports this event to the LLME.

10.5 C/O bearer setup

10.5.1 Single bearer setup procedures

In the following procedures, the set of messages used to switch the bearer state to Bearer_Established after the confirm message has been received are called the "other" messages. The "other" messages comprises all messages except release.

10.5.1.1 Basic bearer setup procedure

Predicates:

- a) PT is in frame and multiframe synchronism with a cluster. The PT has already received the RFPI of at least one RFP within this cluster and knows the RFP's receiver scanning sequence;
- b) an MBC has been created in the PT's MAC to control a connection. The MBC has knowledge of at least one available channel and knows the FMID of the desired RFP;
- c) the PT's MBC has created a new TBC in order to set up a new bearer. The MBC has issued the PMID, FMID and the physical channel identification to the TBC. The MBC indicated if the wanted bearer is to be used for a bearer handover, bearer replacement or a new connection, and whether the connection is "normal" or a "handover".

Procedure Description:

This procedure is always PT initiated and based on the exchange of:

- a "bearer_request" message from PT to FT; followed by
- a "bearer_confirm" message from FT to PT; followed by
- an "other" message from PT to FT; followed by
- an "other" message from FT to PT.

The "bearer_request" message is one of the following messages defined in clause 7.2.5.2:

- the ACCESS_REQUEST message;
- the BEARER_HANDOVER_REQUEST message;
- the CONNECTION_HANDOVER_REQUEST message.

The "bearer_confirm" message is:

- the BEARER_CONFIRM message from clause 7.2.5.2.

The messages are carried in the tail of the A-field. The bearer request and bearer confirm messages are M_T messages of the basic connection control message set. With these messages the FT and PT exchange their MAC identities. Between request and confirm the exchange of some WAIT messages (see clause 7.2.5.2) is allowed. The FMID contained in the WAIT and the "bearer_confirm" messages shall be the same as that in the "bearer_request" message. The "other" message is used to switch the bearer state at the receiving end to Bearer_Established.

The bearer request message and the first response (confirm or WAIT message) from the called side may appear in any frame, over-riding the rules of the T-Mux algorithm described in clause 6.2.2.1. This first response of the called side shall occur in the TDMA half frame following the successful reception of the request message. Until the PT transmits the "other" message in a successful bearer setup, the MAC control messages following the request shall occupy all allowed tails for M_T . The T-Mux algorithm defines which tails are allowed. The two "other" messages are any A-field messages transmitted in successive TDMA half frames following that TDMA half frame in which the PT received the bearer confirm message.

Before Bearer_Established, the B-field may not contain valid I-channel data. If valid I-channel data is available, then it should be included in the B-field. When Bearer Established, the B-field shall contain valid I-channel data if available. If no I-channel data is available, it is recommended that all bits in the B-field are set to "F".

Independent of the current encryption mode of the connection (enabled or disabled) bearer setup always starts in "clear" (encryption disabled). In the case of bearer handover, transmissions on the new bearer are switched to the current encryption mode of the connection immediately after the second "other" message was transmitted/received.

Procedure:

- 1) PT transmits one "bearer_request" at the right time on a given available channel (selection defined in clause 11.4.2) to one of its known RFPs using the "first PT transmission" header code given in clause 7.1.2.
- 2) FT receives "bearer_request" error free (see note 2) with correct FMID and creates a new TBC else procedure ends (bearer setup failed, no TBC = no further transmissions).

NOTE 1: It is assumed that an FT which does not have the capacity to create a new TBC (e.g. simple residential system, call in progress, no bearer or connection handover capability) is not listening to bearer request messages and, therefore, cannot receive this message. If the MBC can create a new TBC this FMID check has to be done within one TDMA half frame = 5 ms. The PT may try to access another base station on reception of a release message in the half-frame immediately following the bearer request instead of wait or bearer confirm.

- 3) FT's TBC asks LLME for an MBC identified by (ARI + PMID) to be connected. If the FT cannot provide an MBC the procedure ends (bearer setup failed, see note 3).

WHILE (FT not ready to transmit "bearer_confirm") DO BEGIN

- a) FT sends WAIT;
- b) If the PT receives WAIT error free:
 - then the PT responds with WAIT;
 - else procedure ends (bearer setup failed).

If WAIT messages were received before, the PT should release the TBC by using a bearer release procedure. Otherwise the TBC shall stop transmissions and the PT should release the TBC.

- c) If the FT receives WAIT message error free:
 - then continue;
 - else procedure ends with FT initiating bearer release (bearer setup failed).

END {WHILE}

- 4) FT sends "bearer_confirm".
- 5) If the PT receives "bearer_confirm" error free:
 - then the PT sends immediately "other" (see note 4);
 - else the procedure ends (bearer setup failed).

If WAIT messages were received before, the PT should release the TBC by using a bearer release procedure. Otherwise the TBC shall stop transmissions and the PT should release the TBC.

- 6) If the FT receives "other" with errors or a release:
 - then the FT initiates bearer release (bearer setup failed),
 - else the TBC reports "bearer_established" to the MBC, and the FT sends immediately "other" (see note 4).
- 7) If the PT receives "other" with errors or a release:
 - then the PT initiates bearer release (bearer setup failed);
 - else the TBC reports "bearer_established" to the MBC.

NOTE 2: Receiving without error means, A-field and X-field CRC hold and message is recognized (message type decoded). When WAIT-messages are used during the setup procedure, the following definition of error free is allowed: For the first four transmissions (two in each direction) on a bearer, A-field CRC and X-field CRC hold and message is recognized (message type decoded). For the following transmissions until "bearer_established": At least one out of every two successive expected Mt-messages is recognized (message type decoded) and A-field CRC holds.

NOTE 3: The FT should release the TBC with a bearer release procedure.

If WAIT messages were received before, the PT should release the TBC by using a bearer release procedure. Otherwise the TBC shall stop transmissions and the PT should release the TBC.

NOTE 4: "Immediately" means, in the TDMA half frame following the transmission of the "bearer_confirm" message (step 5 above) or of the first "other" message (step 6 above).

NOTE 5: During bearer handover and connection handover with encryption from a RFP to a CRFP it is allowed that the FT and CRFP exchange higher layer messages and start messages between the bearer_handover.req message (PT PMID) and the bearer.cfm message.

10.5.1.2 A-field advanced single bearer setup procedure

The A-field advanced single bearer setup procedure may be initiated from either side, PT or FT.

10.5.1.2.1 PT initiated

Predicates:

- a) PT is in frame and multiframe synchronism with a cluster. The PT has already learned the RFPI of at least one RFP within this cluster and knows the RFP's receiver scanning sequence;
- b) an MBC has been created in the PT's MAC to control a connection. The MBC has knowledge of at least one available channel and knows the FMID of the wanted RFP;
- c) the PT's MBC has created a new TBC in order to set up a new bearer. The MBC has issued the PMID, FMID, ECN, the channel identification and a LBN to the TBC. The MBC indicated if the wanted bearer is to be used for a bearer handover or a new connection, and whether the connection is "normal" or a "handover".

Procedure description:

This procedure is based on the exchange of:

- a "bearer_request" message from PT to FT; followed by
- a "bearer_confirm" message from FT to PT; followed by
- an "attributes_request" message from PT to FT; followed by
- an "attributes_confirm" message from FT to PT; followed by
- an "other" message from PT to FT; followed by
- an "other" message from FT to PT.

The "bearer_request" message is one of the following messages defined in clause 7.2.5.3:

- the ACCESS_REQUEST message;
- the BEARER_HANDOVER_REQUEST message;
- the CONNECTION_HANDOVER_REQUEST message.

The "bearer_confirm" message is:

- the BEARER_CONFIRM message of clause 7.2.5.3.

The "attributes_request" message is:

- the ATTRIBUTES_T message (clause 7.2.5.3). The Request/Confirm (R/C) bit is set to 0.

The "attributes_confirm" message is:

- the ATTRIBUTES_T message (clause 7.2.5.3). The Request/Confirm (R/C) bit is set to 1.

All service parameters in the ATTRIBUTES_T messages used as the "attributes_request" and "attributes_confirm" messages shall be the same. The only difference is the setting of the R/C bit.

The messages are carried in the tail of the A-field. Except for the "other" message all messages are M_T messages of the advanced control message set. With the M_T messages the FT and PT exchange their MAC identities and agree the service type. Between the needed setup messages the exchange of some WAIT messages (see clause 7.2.5.3) is allowed. The FMID contained in the WAIT and the "bearer_confirm" messages shall be the same as that in the "bearer_request" message. The "other" message is used to switch the bearer state at the receiving end to Bearer_Established.

The bearer request message and the first response (confirm or WAIT message) from the called side may appear in any frame, overriding the rules of the T-Mux algorithm described in clause 6.2.2.1. This first response of the called side shall occur in the TDMA half frame following the successful reception of the request message. Until the PT transmits the "other" message in a successful bearer setup, the MAC control messages following the request shall occupy all allowed tails for M_T . The T-Mux algorithm defines which tails are allowed. The "other" messages are any A-field messages transmitted in successive TDMA half frames following that half frame in which the PT received the bearer confirm message.

Before Bearer_Established, the B-field need not contain valid I-channel data. If the U-type multiplex is used during setup and no valid I-channel data is available, it is recommended that all bits in the B-field are set to "0".

Independent of the current encryption mode of the connection (enabled or disabled) bearer setup starts always in "clear" (encryption disabled). In case of bearer handover, transmissions on the new bearer are switched to the current encryption mode of the connection immediately after the second "other" message was transmitted/received.

Procedure:

- 1) PT transmits one "bearer_request" at the right time on a given available channel (selection defined in clause 11.4.2) to one of its known RFPs using the "first PT transmission" header code given in clause 7.1.2.
- 2) FT receives "bearer_request" error free (see note 2) with correct FMID and creates new TBC else procedure ends (bearer setup failed, no TBC = no transmissions).

NOTE 1: It is assumed that an FT which does not have the capacity to create a new TBC (e.g. simple residential system, call in progress, no bearer or connection handover capability) is not listening to bearer request messages and, therefore, cannot receive this message. If the MBC can create a new TBC this FMID check has to be done within one TDMA half frame = 5 ms.

WHILE (FT not ready to transmit "bearer_confirm") DO BEGIN

- a) FT sends WAIT.
- b) If the PT receives WAIT error free:
 - then the PT responds with WAIT;
 - else procedure ends (bearer setup failed).

If WAIT messages were received before, the PT should release the TBC by using a bearer release procedure. Otherwise the TBC shall stop transmissions and the PT should release the TBC.

- c) If the FT receives WAIT message error free:
 - then continue;
 - else procedure ends with FT initiating bearer release (bearer setup failed).

END {WHILE}

-
- 3) FT sends "bearer_confirm";
 - 4) If the PT receives "bearer_confirm" error free:
 - then continue;
 - else the procedure ends (bearer setup failed).

If WAIT messages were received before, the PT should release the TBC by using a bearer release procedure. Otherwise the TBC shall stop transmissions and the PT should release the TBC.

WHILE (PT not ready to transmit "attributes_request") DO BEGIN

- a) PT sends WAIT.
- b) If the FT receives WAIT error free:
 - then the FT responds with WAIT;
 - else procedure ends (bearer setup failed), with the FT initiating a bearer release.
- c) If the PT receives WAIT message error free:
 - then continue;
 - else procedure ends (bearer setup failed) with the PT initiating a bearer release.

END {WHILE}

- 5) PT sends "attributes_request".
 - 6) FT receives "attributes_request" error free else procedure ends (bearer setup failed) with FT initiating a bearer release.
 - 7) FT's TBC asks LLME for an MBC identified by (ARI + PMID + ECN) to be connected. If the FT cannot provide an MBC the procedure ends (bearer setup failed) with FT initiating a bearer release.
 - 8) FT's TBC asks MBC for connection with the received logical bearer number (LBN). If the MBC cannot accept a new bearer with this LBN the procedure ends (bearer setup failed) with FT initiating a bearer release.
-

WHILE (FT not ready to transmit "attributes_confirm") DO BEGIN

- a) FT sends WAIT.
- b) If PT receives WAIT error free:
 - then the PT responds with WAIT;
 - else procedure ends (bearer setup failed) with PT initiating a bearer release.
- c) If FT receives WAIT message error free:
 - then continue;
 - else procedure ends with FT initiating bearer release (bearer setup failed).

END {WHILE}

- 9) FT sends "attributes_confirm".
- 10) If PT receives "attributes_confirm" without error:
 - then continue;
 - else the procedure ends (bearer setup failed) with PT initiating bearer release.
- 11) PT sends immediately "other" (see note 3).

12) If the FT receives "other" with errors or a release:
 then the FT initiates bearer release (bearer setup failed);
 else the TBC reports "bearer_established" to the MBC.

13) FT sends immediately "other" (see note 3).

14) If the PT receives "other" with errors or a release:
 then the PT initiates bearer release (bearer setup failed);
 else the TBC reports "bearer_established" to the MBC.

NOTE 2: Receiving without error means A-field and X-field CRC hold and message is recognized (message type decoded). When WAIT-messages are used during the setup procedure, the following definition of error free is allowed: For the first four transmissions (two in each direction) on a bearer, A-field CRC and X-field CRC hold and message is recognized (message type decoded). For the following transmissions until "bearer_established": At least one out of every two successive expected Mt-messages is recognized (message type decoded) and A-field CRC holds.

If WAIT messages were received before, the PT should release the TBC by using a bearer release procedure. Otherwise the TBC shall stop transmissions and the PT should release the TBC.

NOTE 3: "immediately" means, In the TDMA half frame following the transmission of the "attributes_confirm" message (step 11) or of the first "other" message (step 13).

NOTE 4: During bearer handover and connection handover with encryption from a RFP to a CRFP it is allowed that the FT and CRFP exchange higher layer messages and start messages between the bearer_handover.req message (PT PMID) and the bearer.cfm message.

10.5.1.2.2 FT initiated

Predicates:

- a) For setting up the first bearer of a connection: the PT is location registered with the FT and has informed the FT of the RFPI of the RFP that it was locked to;
- b) the PT is scanning all channels of the FT, using the same scanning sequence as the FT or the FT has received a LISTEN-channel list message;
- c) an MBC has been created in the FT's MAC to control a connection. The MBC has knowledge of at least one available channel;
- d) the FT's MBC has created a new TBC in order to set up a new bearer. The MBC has issued PMID, FMID, ECN, the physical channel identification and a new LBN for this connection to the TBC.

Procedure description:

Same as in clause 10.5.1.2.1 with the following two exceptions:

- change transmission direction of all messages;
- the "bearer_request" message cannot be the BEARER_HANDOVER_REQUEST message or the CONNECTION_HANDOVER_REQUEST message as defined in clause 7.2.5.3. Bearer handover and connection handover of a duplex bearer is always initiated by the PT.

Procedure:

Same procedure as PT initiated with following changes:

- exchange names PT and FT in procedure steps;
- change PMID in step 2 to FMID.

Step 1 is changed to:

- FT transmits one "bearer_request" at the right time on a given available channel (selection defined in clause 11.4.3) to its known PT.

10.5.1.3 B-field single bearer setup procedure

The B-field single bearer setup procedure may be initiated from either side, PT or FT.

10.5.1.3.1 PT initiated

During bearer setup the A-field tail messages follow the normal T-MUX rules, except for the first transmission of the PT. The first transmission of the PT is labelled in the header's tail identification and the tail carries a M_T message indicating that the connection uses B-field setup (see clause 7.2.5.8).

Predicates:

The same as in clause 10.5.1.2.

Procedure description:

This procedure is based on the exchange of:

- a "bearer_request" message from PT to FT; followed by
- a "bearer_confirm" message from FT to PT; followed by
- an "other" message from PT to FT; followed by
- an "other" message from FT to PT.

The "bearer_request" message is:

- the BEARER_REQUEST message of clause 7.3.2.2 where the second header indicates ACCESS_REQUEST, BEARER_HANDOVER_REQUEST or CONNECTION_HANDOVER_REQUEST.

The "bearer_confirm" message is:

- the BEARER_CONFIRM message of clause 7.3.2.3.

All service parameters in the bearer request and the bearer confirm message shall be the same.

The messages shall be carried in the B0 subfield and may also be carried in other subfields. The bearer request and bearer confirm messages are extended MAC control. Between request and confirm the exchange of some WAIT messages (B-field Advanced connection control set see clause 7.3.2.4) are allowed and, if used, shall be carried in the B0 subfield. The FMID contained in the WAIT and the "bearer_confirm" messages shall be the same as that in the "bearer_request" message. The "other" message is used to switch the bearer state at the receiving end to Bearer_Established.

The first response of the called side (bearer_confirm or wait) shall occur in the TDMA half frame following the successful reception of the request message.

The other messages are any messages transmitted in successive TDMA half frames following that half frame in which the PT received the bearer confirm message.

Independent of the current encryption mode of the connection (enabled or disabled) bearer setup starts always in "clear" (encryption disabled). In case of bearer handover, transmissions on the new bearer are switched to the current encryption mode of the connection immediately after the second "other" message was transmitted/received.

Procedure:

- 1) PT transmits one "bearer_request" at the right time on a given available channel (selection defined in clause 11.4.2) to one of its known RFPs;
- 2) FT receives "bearer_request" error free with correct FMID and creates new TBC else procedure ends bearer setup failed, no TBC = no transmissions);

NOTE 1: It is assumed that an FT which does not have the capacity to create a new TBC (e.g. simple residential system, call in progress, no bearer or connection handover capability) is not listening to bearer request messages and, therefore, cannot receive this message. If the MBC can create a new TBC this FMID check has to be done within one TDMA half frame = 5 ms.

- 3) FT's TBC asks LLME for an MBC identified by (ARI + PMID + ECN) to be connected. If the FT cannot provide an MBC the procedure ends (bearer setup failed);
- 4) FT's TBC asks MBC for connection with the received logical bearer number (LBN). If the MBC cannot accept a new bearer with this LBN the procedure ends (bearer setup failed).

WHILE (FT not ready to transmit "bearer_confirm") DO BEGIN

- a) FT sends WAIT;
- b) If PT receives WAIT error free:
 - then PT responds with WAIT;
 - else procedure ends (bearer setup failed);
- c) If FT receives WAIT message error free:
 - then continue;
 - else procedure ends with FT initiating bearer release (bearer setup failed);

END {WHILE}

- 5) FT sends "bearer_confirm";
- 6) If PT receives "bearer_confirm" without error:
 - then continue;
 - else the procedure ends (bearer setup failed).
- 7) PT sends immediately "other".
- 8) If the FT receives "other" with correct A-field and X-field CRCs:
 - then the TBC reports "bearer_established" to the MBC;
 - else the FT initiates bearer release (bearer setup failed).
- 9) FT sends immediately "other".
- 10) If the PT receives "other" with correct A-field and X-field CRCs:
 - then the TBC reports "bearer_established" to the MBC;
 - else the PT initiates bearer release (bearer setup failed).

In the preceding procedure the wording "Immediately" means, in the TDMA half frame following the transmission of the "bearer_confirm" message (step 7) or in the TDMA half frame following the transmission of the first "other" message (step 9).

In the preceding procedure the expression "Received error free" means that the A-field and the B0-subfield shall be received without CRC error. When WAIT-messages are used during the setup procedure, the following definition of error is allowed: for the first four transmissions (two in each direction) on a bearer, A-field CRC and B0-subfield hold and message is recognized (message type decoded). For the following transmissions until "bearer_established": at least one out of every two successive expected MAC B-field advanced_connection control set messages is recognized (message type decoded) and A-field and B0-subfield CRC holds.

In case of the bearer setup failure is detected at the FT side, the FT should release the TBC with an FT initiated bearer release procedure.

In case of the bearer setup failure is detected at the PT side and when WAIT messages were exchanged before, the PT should release the TBC by using a PT initiated bearer release procedure. Otherwise the TBC shall stop transmissions and the PT should afterwards release the TBC.

Although the relevant MAC messages (bearer request, bearer confirm, WAIT and release) shall be located in B0-subfield, duplication of these messages is allowed in other Bn-subfields.

NOTE 2: During bearer handover and connection handover with encryption from a RFP to a CRFP it is allowed that the FT and CRFP exchange higher layer messages and start messages between the bearer_handover.req message (PT PMID) and the bearer.cfm message.

10.5.1.3.2 FT initiated

During bearer setup the A-field tail messages follow the normal T-MUX rules.

Predicates:

Same as in clause 10.5.1.2.2

Procedure description:

Same as in clause 10.5.1.3.1 with the following two exceptions:

- change transmission direction of all messages;
- the "bearer_request" message cannot be the BEARER_HANDOVER_REQUEST message or the CONNECTION_HANDOVER_REQUEST message as defined in clause 7.2.5.3. Bearer handover and connection handover of a duplex bearer is always initiated by the PT.

Procedure:

Same procedure as PT initiated with following changes:

- exchange names PT and FT;
- change FMID in step 2 to PMID;
- step 1 changes to:
- FT transmits one "bearer_request" at the right time on a given available channel (selection defined in clause 11.4.3) to its known PT.

10.5.1.4 Double simplex setup procedure

Terminology:

T-side: the side that will be the eventual transmitter of the double simplex bearer.

R-side: the side that will be the eventual receiver of the double simplex bearer.

Predicates:

- a) the connection (or the MBC) already exists, i.e. a double simplex bearer shall only be added to an existing connection. At least one (pilot) duplex bearer shall be controlled by this connection;
- b) the wanted service is known at both endpoints. To provide the wanted service an asymmetric connection is to be used;
- c) the T-side knows the FT's ARI, the PT's PMID, the ECN and the LBN of the wanted bearer. It also knows if the wanted bearer is to be used for a bearer handover or for a connection setup, and whether the connection setup is for handing over a connection.

The procedure has two phases:

- selection of suitable physical channels;
- bearer setup using those channels.

There are two methods of double simplex bearer setup: indirect setup, and direct setup.

The indirect double simplex bearer setup is based on the R-side transmission of a single "dummy" message on that physical channel of the channel pair which lies in the normal R-side transmit half-frame. When received without error, the T-side may proceed with the direct bearer setup procedure starting the double simplex transmissions on the same channel pair in the next TDMA frame.

The "dummy" message is the following message:

- the UNCONFIRMED_DUMMY message defined in clause 7.2.5.3 (A-field setup) and clause 7.3.2.8 (B-field setup): Sent by the R-side.

The direct double simplex bearer setup is based on the exchange of the following messages:

- the START channel list message sent by the T-side; together with
- the "bearer_request" messages transmitted by the T-side; followed by
- the "attributes" message transmitted by the T-side; followed by
- the ACTIVE channel list message received by the T-side.

NOTE 1: The "attributes" message occurs only in A-field setup.

NOTE 2: The START channel list message is sent on a already established bearer.

NOTE 3: The ACTIVE channel list message is transmitted on any duplex bearer.

The "bearer_request" message is the following message:

- the UNCONFIRMED_ACCESS_REQUEST message defined either in clause 7.2.5.3 (A-field setup) or in clause 7.3.2.2 (B-field setup).

The "attributes" message for A-field setup is:

- the ATTRIB_T message (clause 7.2.5.2). The Request/Confirm (R/C) bit is set to 0.

Channel selection procedure:

Prior to initiating an Indirect Setup, the R-side shall select a channel using the double simplex channel procedures as described in clause 11.4. The T-side shall not select the channel.

Although the R-side only makes a single (backward) transmission, the channel selection shall use the double simplex procedure.

The R-side should select other suitable physical channels for setup, and should indicate these to the T-side using indirect setup (the "dummy" message) or GOOD or LISTEN channel list messages.

NOTE 4: These channel list messages may be transmitted on any existing bearer of this connection, and may be M_T messages or extended MAC control.

The T-side always initiates the double simplex transmissions as described in the direct setup procedure. When initiating this procedure, the T-side should give preference to accepting any indirect setup procedures from the R-side.

When selecting channels for the direct procedure (i.e. when not responding to an indirect setup transmission) the T-side should select a channel in the following order of preference:

- a) a channel indicated by a LISTEN message;
- b) any channel that is aligned to a predefined R-side scanning pattern (see clause 11.8 for RFPs, and clause 11.9 for PPs);
- c) a channel indicated by a GOOD message.

In these cases the T-side channel selection shall use the double simplex channel selection procedures as described in clause 11.4.

Before selecting a physical channel, the T-side should attempt to receive one (or more) transmission on that channel. If a connectionless or broadcast transmission is received as indicated by the BA coding (see clause 7.1.4) the physical channel should not be used.

NOTE 5: Connectionless and broadcast transmissions should be given special treatment, to improve their reliability.

Indirect setup procedure:

The indirect procedure enables the R-side to propose a channel to set up a double simplex bearer. Nevertheless, it is the T-side's responsibility to accept the proposal.

R-side proposal:

The R-side shall initiate the set up by transmitting a "dummy" message in the normal half of the TDMA frame. This transmission shall be aligned to a known T-side scanning pattern (see clauses 11.8 and 11.9). The R-side shall then attempt to receive a direct double simplex set up on these channels as though a LISTEN message had been sent (i.e. the R-side shall listen to the channel for 4 TDMA frames).

If the "dummy" message is received successfully by the T-side, the T-side should initiate a direct double simplex setup on that channel using the procedure listed below. If the T-side responds to this "dummy" transmission, it shall commence double simplex transmissions in the TDMA frame immediately following the TDMA frame that contained the DUMMY message.

Direct setup procedure:

The T-side shall report a setup attempt on the selected physical channels by issuing a START channel list message. This message shall be transmitted only once for one setup attempt on any bearer of this connection. The START message shall be transmitted on at least one established bearer when responding to a GOOD message (channel selection (c) above; see clause 10.5.2 for the channel list messages).

NOTE 6: The START message may be duplicated on more than one bearer, provided that all transmissions of the START message occur within a single TDMA frame.

NOTE 7: The START message may be a M_T message or extended MAC control.

At the T-side the MBC creates a TBC and shall start transmissions on both physical channels of the new bearer in the same TDMA frame if the R-side scanning pattern is known (channel selection type (b) above) or if the R-side has a temporary TBC installed (channel selection type (a) above). Otherwise, the TBC shall start transmissions on both physical channels of the new bearer in the TDMA frame following that frame in which the START channel list message was transmitted. Transmissions on a new bearer shall start in "clear" (encryption disabled), and for encrypted connections the transmissions shall be switched to "encrypted" at the third TDMA frame boundary after the transmission of the START message.

This ensures that the next two TDMA frames, which may contain B-field setup messages, shall always be transmitted in "clear".

For A-field setup:

The first transmissions on both channels may violate the T-MUX rules defined in clause 6.2.2.1 and at least one channel shall contain the "bearer_request" message in the A-field tail. This message shall be labelled in the A-field header as a M_T message. The next two allowed TDMA frames for M_T tails (T-MUX algorithm) shall also be used for the bearer setup. In the first of these frames the "bearer_request" message shall be repeated on at least one channel, and in the second the "attributes" message shall be transmitted on at least one channel.

NOTE 8: The A-field setup may transmit the "bearer_request" message in one channel, and the "attributes" message in the other channel.

For B-field setup:

The first transmission on each channel shall contain the "bearer_request" message. This message shall be repeated in the following TDMA frame on both physical channels of the new bearer. The "bearer_request" message shall always be present in the B0 subfield and may be duplicated into other subfields.

NOTE 9: Further transmissions of the "bearer_request" message are allowed, subject to the rules in the following paragraphs.

NOTE 10: The minimum retransmission of the "bearer_request" message defines the earliest point at which "early" data transmission may occur.

In certain cases the double simplex transmissions shall be limited to a maximum period of 2 TDMA frames. This limit shall apply only if the T-side has not received a GOOD, ACTIVE, or a LISTEN message for the selected double simplex channel.

NOTE 11: A suitable GOOD, ACTIVE, or LISTEN message may be received at any time up to the expiry of this transmission limit. In cases a) and c) above, the GOOD or LISTEN message will have been received before the double simplex transmissions start, and no special action is needed.

NOTE 12: In case b), a rapid response is needed from the R-side if a partial setup attempt is received by the R-side. The immediate transmission of a LISTEN message is therefore recommended.

The T-side shall now wait for a confirmation from the R-side of successful double simplex bearer establishment. A confirmation shall be indicated by the reception of an ACTIVE channel list message for this pair of physical channels on any existing bearer of the connection.

NOTE 13: This ACTIVE channel list message may also occur as a reply to a QUERY_N or a QUERY_H channel list message issued by the initiating side.

At the T-side the reception of the ACTIVE channel list message switches the bearer state to Bearer_Established. If this message is not received within T212 frames after the first bearer request message was transmitted or a POOR channel list message is received for this bearer at any time during bearer setup, the bearer setup has failed and the MAC releases the new bearer with the unacknowledged release procedure (see clause 10.7.2.1).

At the R-side of a double simplex bearer a correctly received START channel list message may occur on any established bearer, and shall immediately alter the receiver scanning pattern if this is possible.

When a scanning change is possible, the R-side receiver scanner shall listen on the indicated pair of physical channels during at least four TDMA frames following that frame in which the START message was received. If a LISTEN message has not already been sent as part of the channel selection procedure, the R-side should immediately return a LISTEN message for the indicated channels.

NOTE 14: The LISTEN message may be transmitted in all cases.

If a change to the scanning is not possible, the R-side should respond with a POOR channel list message.

At the R-side, a "bearer_request" message may be received on any physical channel. The physical channel should also be indicated by the receipt of a START message, but the receipt of the START message only essential in certain cases (notably for encrypted connections).

NOTE 15: The first "bearer_request" message may occur before the START message, even for encrypted connections.

For encrypted connections, a successfully established TBC shall only be connected to the MBC if a START message has been received for that bearer. Otherwise the TBC shall be released.

NOTE 16: The START message is essential for encrypted connections to enable the start of encryption.

For connections which are not encrypted, a successfully established TBC shall be connected to the MBC even if the START message is not received.

In both cases, successful establishment of a TBC requires the following setup messages to be received.

For A-field setup:

If a "bearer_request" message is received on at least one channel a TBC shall be created. The TBC shall try to receive the repeated "bearer_request" and the "attributes" messages on both physical channels. If both these messages are received within 3 frames without errors, and at least one message is received without errors on each channel, the TBC should be connected to the MBC and the bearer shall switch its state to Bearer_Established. Otherwise, the MAC shall release the TBC.

For B-field setup:

If a "bearer_request" message is received on at least one channel a TBC shall be created. The TBC shall try to receive the repeated "bearer_request" message on both physical channels. If this message is received within 2 frames without errors on both physical channels the TBC should be connected to the MBC and the bearer shall switch its state to Bearer_Established. Otherwise, the MAC shall release the TBC.

As soon as a new double simplex bearer TBC is established, the MBC at the receiving end shall report this event with an ACTIVE channel list message to the T-side. This message shall be transmitted on any established bearer of the connection.

If the R-side detects an unsuccessful setup attempt (i.e. at least one setup message is received for a given bearer, but the full setup criteria as given above have not been achieved), then the R-side should request an immediate halt to the setup attempt by sending a POOR channel list message.

NOTE 17: This action is not essential. The setup attempt should terminate due to lack of a positive message.

I-channel data transmission may start on both physical channels as soon as there is available capacity. For A-field setup this can occur in the first transmission, but for B-field setup at least two setup messages have to be transmitted. Any I-channel data transmitted before the bearer state is "established" (i.e. before receipt of the ACTIVE channel list message) may be lost if the bearer setup fails.

NOTE 18: Data transfer on an unestablished bearer is unreliable. In particular, the I_p error corrected service cannot return acknowledgements until it has been connected to the MBC.

10.5.1.5 Complementary connection bearer setup

A complementary connection setup shall always be REP initiated. A complementary connection allows to setup one duplex bearer without any interaction/notification with/to the higher layers, as explained in the following overview.

The calling side does not require the creation of a new MBC at the called side but can identify an existing MBC which the complementary connection can be referred to by activating a mapping procedure (see 10.5.1.6).

Called side:

- on the called side a new TBC is created by receiving a "REP_bearer_request" message, including the MAC addresses PMID and FMID on the scanned physical channel. The message type also contains the information that the new bearer belongs to a complementary connection.

MBC identification:

The TBC has to receive all necessary parameters to identify an MBC.

The MBC is fully identified after:

- a) receiving with "REP_bearer_request" message either a REP_access request or a REP_bearer_handover request (see clause 7.2.5.11), including the calling address PMID and defining the connection type as complementary; and
- b) receiving the REP_channel_map_request message (see clause 7.2.5.11) which indicates the duplex bearer to which the complementary connection setup bearer has to be linked. This message is necessary only for a new bearer setup; in case of a bearer handover request, the old mapping still stays effective. The MBC to refer to is the one to which belongs the TBC of the linked bearer.

The TBC issues a PMID, ARI and the REP_channel_map.request message, when received, to the referred MBC and indicates the purpose of the wanted connection (bearer handover or a new setup).

The MBC can now decide:

- a) to release the TBC;
- b) to accept the TBC.

Procedure description:

The procedure for a complementary connection bearer setup is identical to the basic bearer setup procedure as described in clause 10.5.1.1 and to the duplex bearer handover procedure as described in clause 10.6.2, in case of bearer handover, where:

- the PT is REP and the FT could also be a REP;
- the exchanged Mt messages belong to the REP control set (see clause 7.2.5.11);
- the bearer_request message can be either a REP_access.request or a REP_bearer_handover.request message.

10.5.1.6 Double duplex bearer setup procedure: Mapping procedure

The mapping procedure shall always be REP initiated. This procedure allows to set up a double duplex bearer, after two duplex bearers have been setup between two far ends. When one of the two duplex bearers already belongs to a double duplex bearer the procedure is called "interlacing".

After receiving without errors the REP_channel_map.request message (see 7.2.5.11.3) onto a duplex bearer, the receiving side can decide:

- a) to Accept to map together the indicated channels;
- b) to Reject to map together the indicated channels.

NOTE 1: Receiving without errors means A-field CRC holds and message is recognized (message type decoded).

NOTE 2: Case (b) may apply when interlacing of the two duplex bearers is requested and the receiving side does not support "interlacing".

As soon as it is ready, the receiving side shall answer by sending onto the same duplex bearer the REP_channel_map.confirm message (see 7.2.5.11.4) with the A/R flag set to "Accepted", if it is case (a), otherwise to "Rejected".

After reception without errors of the REP_channel_map.confirm message with A/R flag set to "Accepted", the double duplex bearer is setup. After reception without errors of the REP_channel_map.confirm message with A/R flag set to Rejected, a new REP_channel_map.request message may be forwarded but selecting a more suitable duplex bearer (i.e. a duplex bearer which does not already belong to a double duplex bearer).

The REP_channel_map.request message may be repeated until the REP_channel_map.confirm message is detected or a connection release is recognized.

Within the double duplex bearer the two duplex bearers shall exchange their simplex bearers such that the information flow, for the uplink transmission direction, shall use the uplink simplex bearer of one duplex bearer and, for the downlink transmission direction, the downlink simplex bearer of the other duplex bearer. The figure at the end of this clause shows an example of information flow within a double duplex bearer.

The first SN and CN fields (bits a16 to a25) of the channel_map.request message indicate the "Master channel": it is the channel controlled by that MBC which, after the mapping, will also control the other channel indicated by the following SN and CN fields (bits a38 to a47). In other words, after the mapping procedure has been successfully completed, the linked channels shall both belong to the master channel connection.

The release of one of the two duplex bearers composing the double duplex shall cancel the link, given with the mapping procedure, between the surviving duplex bearer and the released one.

The REP_channel_map.req message may over-ride the T-Mux algorithm (see clause 6.2.2.1) when transmitted as a first "other" message (see clause 10.5) during a bearer setup procedure. The first response (REP_channel_map.confirm message) shall occur in the TDMA half frame following the successful reception of the REP_channel_map.request from the receiving side and may also over-ride the T-Mux algorithm. The TBC shall report "bearer established" after the mapping procedure is successfully completed (i.e. the double duplex bearer has been setup).

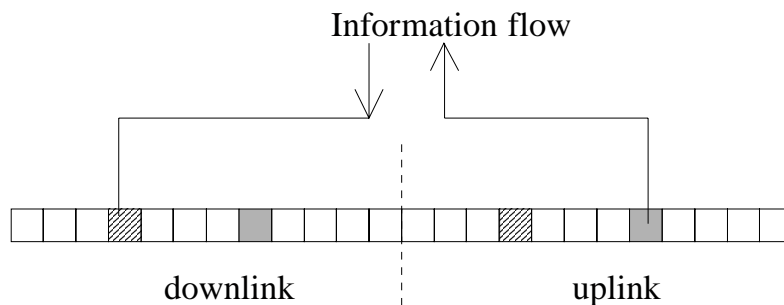

Figure 10.2

10.5.2 Channel list procedures

10.5.2.1 Scope

Channel list procedures use a set of channel list messages to:

- negotiate pairs of physical channels to be used for new bearers;
- report the status of a pair of physical channels;
- trigger bearer setup procedures.

The channel list messages relate to the base station with the RPN contained in the messages.

10.5.2.2 Description of the channel list messages

Message	Meaning
ACTIVE:	The endpoint that sends this message reports that the indicated pair of physical channels is in use as an established bearer of this connection.
GOOD:	The indicated pair of physical channels is unused at the endpoint that sends this message, and may be used for a new bearer.
POOR:	The endpoint that sends this message tells the recipient that the indicated pair of physical channels cannot be used for a new bearer, e.g. poor quality or already in use with a third party.
F/S_NOT:	The endpoint that sends this message does either not support the indicated frequency or has a "blind slot" at the indicated slot position (see coding in clause 7.2.5.3.10).
QUERY_N:	The endpoint that sends this message requests some information on the indicated pair of physical channels.
QUERY_H:	The QUERY_H channel list message has exactly the same function as the QUERY_N message. The QUERY_H message however shall only be used to get channel information needed for bearer handover and for connection handover.
LISTEN:	The endpoint that sends this message reports that it's receiver temporarily installs a 'receive only' TBC which will listen to the receive channels of the indicated pair of physical channels for at least the next 4 TDMA frames in order to recognize bearer setup requests.
START:	The endpoint that sends this message has selected the indicated pair of physical channels for a new bearer and shall transmit on this bearer in at least the next TDMA frame. If the channel pair is accessible and no TBC is installed at the receiving endpoint of a START message, the receiving side should install a temporary 'receive only' TBC to recognize bearer setup requests.

10.5.2.3 Usage of the channel list messages

Message	Meaning
ACTIVE:	This message shall be used by the receiving side to confirm the establishment of a double simplex bearer, and may be used from either side at any time to report the status of the physical channel pair.
F/S_NOT:	These messages may be used at any time from either side to report the status of the physical channel pair.
QUERY_N:	This message may be used at any time from either side.
QUERY_H:	This message is allowed only during a handover operation (bearer or connection).
LISTEN:	This message may be used at any time.
NOTE 1:	Clauses 10.2.4.3.1 to 10.2.4.3.3 describe which endpoint is allowed to initiate bearer setup. Therefore, a LISTEN message transmitted in the wrong direction is meaningless.
START:	This message is used to announce double simplex bearer setup attempts (handover or initial setup) on the indicated channel pair and to trigger encryption on those bearers. For one setup attempt the START channel list message shall be sent on one or more bearers within one TDMA frame. The START channel list message is sent by the PT when the bearer belongs to an asymmetric uplink connection, and by the FT when the connection is asymmetric downlink. The START message may also be used to announce duplex bearer setup attempts on channels other than the scanned channels (see clauses 11.8 and 11.9). When used, the message is sent on one or more bearers within one single TDMA frame. FTs may use this mechanism only when the connection is asymmetric downlink, and PTs when the connection is symmetric or asymmetric uplink.

Except for the START message, all channel list messages may be retransmitted. When not explicitly prohibited, the channel list messages can be sent on any bearer of the connection, even during bearer setup (if the capacity is available).

NOTE 2: There is no guarantee the receiving endpoint will decode the channel list messages during bearer setup. It is recommended to transmit important messages which may influence setup procedures (i.e. LISTEN, START, and ACTIVE) only on established bearers.

The following channel list messages should produce a response from the receiving entity:

- QUERY_N or QUERY_H messages:
 - Message responses shall be: GOOD, POOR, ACTIVE, LISTEN or F/S_NOT.
- START message for double simplex bearer:
 - Message response shall be: ACTIVE or POOR.

10.6 C/O bearer handover

10.6.1 General

The MAC layer provides PTs and FTs with several mechanisms to control the quality of transmissions and receptions. Bearer handover may be initiated either by using this quality information or by receiving a bearer handover request message from the far end (see clauses 7.2.5.5 and 7.2.5). For duplex bearers the PT only can initiate a bearer handover, and for double simplex bearers the transmitting side only can initiate a bearer handover. The existing bearer can be maintained until the new bearer has been established. During bearer handover the two bearers can operate in parallel.

NOTE 1: Bearer handover requires that an MBC for the connection exists on both sides, PT and FT, and that the new selected RFP at the fixed side belongs to the same cluster.

PTs should use bearer handover to attempt to connect to the best RFP of the cluster in which the connection is established. This may be the same RFP as the existing bearer, or may be a new RFP.

DECT equipments may have several indicators to monitor reception quality:

- the A-field CRC;
- the X-field CRC;
- the CRCs of the B-subfields in protected mode (E-type or U-type for IP);
- X-field to Z-field comparison (for Z-field refer to EN 300 175-2 2);
- link identity information;
- synchronization pulse;
- clock jitter;
- signal strength;

...

To control the quality of transmissions the MAC layer uses the reports from the far end, coded in two bits:

- the (Q1,Q2) bits or the
- (BCK,Q2) bits (see clauses 7.1.1 and 7.3.4.4).

There are no specified rules for the PT which define when a bearer handover attempt has to be made. For system reasons the maximum rate at which bearer handovers can be performed is limited by a simple timer. No more than two successful bearer handovers should occur within T202 seconds.

NOTE 2: This should not be confused with multiple attempts for one handover.

NOTE 3: For bearer handover (both intra- and inter-cell) in multibearer connections, each bearer is treated separately.

Different handover procedures exist for duplex and double simplex bearers.

10.6.2 Duplex bearer handover procedure

The setup of a new bearer for duplex bearer handover is always initiated by the PT. The MBC of the PT shall have knowledge of at least one available channel and shall know the address (FMID) of the wanted FT. The MBC creates a TBC and issues called address (PMID/FMID) and the physical channel description to the new TBC. The MBC indicates to the TBC that the wanted bearer is used for a bearer handover and which bearer setup procedure shall be used. In addition, for advanced connections the MBC issues the new TBC with the ECN and the LBN, which is also assigned to the TBC of the bearer which has to be handed over.

The TBC tries to set up a new bearer using one of the single bearer setup procedures described in clause 10.5.1:

- the basic bearer setup procedure for all basic connections;
- the A-field single bearer setup procedure or the B-field single bearer setup procedure for advanced connections.

At the end of all these procedures the TBC reports either "bearer_established" or "bearer_setup_failed" to the MBC.

NOTE 1: At the called side these messages only occur if a bearer setup attempt was detected (TBC created).

If the bearer setup failed the MBC can reattempt a bearer handover with the same procedure, subject to using a new available channel each time (see clause 11.4) and/or accessing a new RFP. Within any time window of T202 seconds at most N201 bearer setup reattempts shall occur for a bearer handover of one particular bearer.

An MBC assumes that a bearer setup was successful when the TBC reported "bearer_established". Immediately after this TBC report the MAC switches the new bearer to the same E/U multiplex as used by the old bearer. For U-type databursts all following transmissions shall contain valid I-channel data.

NOTE 2: In advanced connections the "new" and the "old" bearers have the same LBN number.

In basic connections, two bearers shall only occur during bearer handover. There is no LBN, i.e. the "new" and the "old" bearer are the only bearers of the connection.

For a limited time the MBC may maintain both TBCs, controlling the new and the old bearer. The MBC in the FT decides when and which one of the two TBCs is released with a bearer release procedure. The FT shall invoke this bearer release procedure within a time interval of T203 after the new bearer was established (TBC reported "bearer_established").

NOTE 3: During the time where the new and the old bearer are maintained, both bearers together form one logical bearer (see clause 5.5.2).

For the limited time where both bearers are established:

Except for $I_{N_minimum_delay}$ services all I-channel data transmitted in one TDMA half frame is the same for both bearers (see data flow control, clause 8.4).

For $I_{N_minimum_delay}$ services I-channel data transmitted in one TDMA frame may be different for both bearers (see clause 8.4).

NOTE 4: For protected data connections the preferred procedure to delete an old bearer and setup a new one is the Bearer Replacement procedure (see clause 10.6.4).

10.6.3 Double simplex bearer handover

Although the double simplex bearer handover procedure is initiated by the transmitting endpoint (T-side), the receiving endpoint of a specific double simplex bearer may request a bearer handover. The request may be transmitted on any bearer in reverse direction. The request message is defined as a M_T message in clause 7.2.5.5 and as an extended MAC control message in clause 7.3.4.

By receiving a request to initiate a bearer handover procedure the transmitting side of a double simplex bearer may either initialize a bearer handover, reject the handover request with a `BEARER_HANDOVER_REJECT` message (see clauses 7.2.5.5 and 7.3.4) or not react upon this request message.

Initialization of a bearer handover starts with the negotiation of a new pair of physical channels. This is done using the channel list procedures. The new bearer is set up with the double simplex setup procedure (see clause 10.5.1.4), except that the `UNCONFIRMED_HANDOVER` message is used in place of the `UNCONFIRMED_ACCESS_REQUEST` message. The same logical bearer number LBN is assigned to the new double simplex bearer as for the old bearer.

As soon as possible all I-channel information carried on this logical bearer is duplicated on both double simplex bearers.

This occurs no later than when the bearer is established, i.e. when the transmitting side end receives the `ACTIVE` message (see channel list procedure).

Within any time window of T202 seconds at most N201 double simplex bearer setup re-attempts shall occur for a bearer handover of one particular double simplex bearer.

NOTE: The relevant reattempts are those where the initiating side actually starts transmissions on a new bearer.

The new bearer setup is successful when the initiating side receives a confirmation, i.e. an `ACTIVE` message (clauses 7.2.5.3.10 and 7.3.2.7) for this bearer. As soon as this message is received the initiating side proceeds with a bearer release of the old double simplex bearer with the unacknowledged release procedure (see clause 10.7.2.1).

10.6.4 Bearer replacement

10.6.4.1 General bearer replacement

This procedure is one way to improve the quality of a connection by changing bearers to different channels within the same cluster.

"Bearer replacement" is defined to be the procedure where an old bearer is replaced with a new bearer that has a different LBN or where the old bearer was lost before the new bearer is setup with the same LBN. The procedure to setup the new bearer is defined by clause 10.5. The procedure to release the old bearer is defined in clause 10.7.

For replacement of one bearer of an Ip-error-correct connection the procedure is defined in clause 10.8.2.5.1.

It is preferred to first drop the old bearer and then set-up the new bearer, or to do this simultaneously. It is not required to have the new bearer active before the old bearer is released.

10.6.4.2 Frequency replacement

"Frequency Replacement" is defined as a case of bearer replacement procedure where an old bearer is replaced with a new bearer which is located on the same time slot pair but uses a different frequency.

The procedure shall only apply if a different time slot pair cannot be found before the bearer would be released.

The selection of the new frequency shall be done in accordance with the channel selection rules as described in clause 11.4. This requires stopping the reception of the affected channel for a frame in order to perform the required RSSI measurements on the new frequency.

The frequency replacement procedure shall always be PT initiated and applies either to duplex or to double simplex bearers.

Procedure description:**Frequency Replacement for a Duplex Bearer**

- The PT side:

The PT shall send the frequency replacement request message to the peer entity with the indication of the new bearer to be setup (see 7.2.5.5 and 7.3.4.2).

This quality control message shall be sent on one duplex bearer of the connection which could be the affected one.

In the frame after the transmission of the frequency replacement request message, the PT shall switch reception from the old to the new bearer and try to receive the frequency replacement confirm message (see 7.2.5.5 and 7.3.4.2) on that bearer. If a confirm message is not detected, the request message can be repeated up to N206 times or until the old bearer is released.

If, after N206 attempts, the confirm message is not received the PT shall release the old bearer and the new bearer. Otherwise, if a confirm message is received, in the same frame the PT shall switch transmission from the old bearer to the new bearer and send the frequency replacement grant message (see 7.2.5.5 and 7.3.4.2) on that bearer. The frequency replacement grant message can be repeated up to N207 times or until the new bearer is released.

- The FT side:

Upon reception of a frequency replacement request message, the FT shall switch the transmission and reception from the old to the new bearer and send the frequency replacement confirm message on that bearer. The confirm message can be repeated up to N207 times until a frequency replacement grant message is detected or until the new bearer is released. If, after N207 attempts, the grant message is not received the FT shall release the new bearer.

Frequency Replacement for a Double Simplex Bearer.

The same procedure as for the duplex bearer applies with the following exceptions.

The relevant MAC messages shall all be exchanged on one duplex bearer of the connection. The FT shall switch transmission and reception from the old bearer to the new bearer in the frame after the confirm message has been sent. The PT shall switch transmission and reception from the old to the new bearer in the frame where the grant message is sent.

The frequency replacement request, confirm and grant messages can be duplicated, when possible, in all the Bn sub-fields of the time slot (see 7.3) in order to improve the probability that the message is recognized (message type decoded and related CRC correct) by the peer entity.

The frequency replacement request, confirm and grant messages can overrule the T-MUX algorithm (see 6.2.2) when sent as Mt messages.

Frequency replacement grant messages received after the first one should be ignored.

10.7 C/O bearer release

10.7.1 General

Bearer release describes the release of a TBC which controlled a duplex or a double simplex bearer.

A bearer release may be caused by several events:

- a) the MBC on either side initiates a bearer release;
- b) a bearer in setup phase cannot be connected to an MBC. Here the LLME initiates a bearer release (see single bearer setup procedures);
- c) a TBC received faulty MAC messages during setup (see setup procedures);
- d) the TBC releases the bearer due to a timeout. See handshaking requirement, (see clause 11.5);
- e) the TBC receives a release message error free.

NOTE 1: Event b) should not occur for double simplex bearers. Here the channels have to be negotiated before transmissions on a double simplex bearer start.

A bearer release is initiated when on either side one of the events a) .. d) occurs. The FP shall only release a bearer if it has previously received a MAC control message referencing that bearer with correct FMID and PMID. Two bearer release procedures exist:

- the unacknowledged bearer release procedure; and
- the acknowledged bearer release procedure.

The unacknowledged bearer release procedure is always applied for a release of a duplex bearer, and for a double simplex bearer only if the MBC on the transmitting side decides to release the bearer. During this procedure MAC RELEASE messages (see clause 7.2.5.3.13) are transmitted and afterwards the TBC stops transmitting. As a consequence, one of the events d) or e) will occur at the far end.

NOTE 2: If event d) is recognized at the far end a second bearer release procedure is initiated.

The acknowledged bearer release procedure is applied when the receiving end of a double simplex bearer decides to release this bearer (events a), c) and d)). The release is negotiated on a duplex bearer.

NOTE 3: A connection release may interrupt this procedure.

10.7.2 Bearer release procedure description

10.7.2.1 Unacknowledged release procedure

The unacknowledged release procedure shall be applied to release duplex bearers, and double simplex bearers only by the transmitting side (exception for double simplex bearer, see clause 10.7.2.3).

The unacknowledged release procedure uses the RELEASE message. This message allows the reason for a bearer release to be reported (only for advanced connections).

All sets of MAC connection control messages contain a RELEASE message. The unacknowledged bearer release procedure shall use the RELEASE message of that message set which was used to setup the bearer. If this message is transmitted in the B-field, the message may be duplicated into all subfields.

The RELEASE message appears twice without any warning, replacing the normal transmission. The message is sent two times in successive frames on that bearer which has to be released, and the transmitting end releases the radio channel immediately afterwards. If the TBC is connected to an MBC and it was not the MBC's decision to release the bearer, the TBC reports this event to the MBC and indicates the reason. Finally the MAC releases the TBC.

The receiving end shall release the bearer immediately after successful receipt of any RELEASE message. If the TBC is connected to an MBC the TBC shall report this event to the MBC and indicate the reason. The MBC shall release the TBC afterwards.

10.7.2.2 Acknowledged release procedure

The acknowledged release procedure is only used to release double simplex bearers when initiated by the receiving end.

NOTE: The receiving end of double simplex bearers may only initiate an acknowledged release of any of these bearers when at least one established duplex bearer exists. Otherwise the TBC is released without any negotiation.

The receiving end of a double simplex bearer may request a release of this bearer by sending a RELEASE message on any bearer in reverse direction. Within this message the setting of the LBN shall identify the double simplex bearer, and whenever necessary the reason shall be set.

During bearer handover it is possible that the receiving end initiates an acknowledged bearer release either for the "new" bearer or for the "old" bearer due to a timeout. To avoid ambiguity the reason shall be set to "bearer handover successfully completed" or to "bearer handover failed". The first command means to release the "old" bearer the latter command indicates to release the "new" bearer.

If the transmitting end of an established double simplex bearer receives a RELEASE message for this bearer, it shall proceed with an unacknowledged bearer release.

The receiving end of a double simplex bearer may correctly receive a RELEASE command issued during the unacknowledged release procedure. In this case the bearer release is confirmed, the MAC releases the TBC and the procedure stops. If no release command is received within T213 frames after initiating the procedure the receiving end of the double simplex bearer shall use the channel list procedure to verify the channel status. The transmitting end may reply with an GOOD or a POOR message. These two messages indicate that the bearer is released. The MAC releases the TBC and the procedure stops. If the reply is the ACTIVE message the release procedure shall be repeated.

10.7.2.3 Fast release procedure

The fast release procedure allows to switch the transmission direction of double simplex bearers very quickly.

The fast release procedure shall only be used during connection modification (see clause 10.3) to release double simplex bearers. The procedure is always initiated by the MBC of the transmitting side and uses the RELEASE message with the reason set to "reverse".

Both sets of advanced MAC connection control messages, A-field and B-field, contain this RELEASE message. The fast release procedure shall use the RELEASE message of that message set which was used to setup the bearer. If this message is transmitted in the B-field, the message may be duplicated into all subfields.

The RELEASE message appears in one TDMA frame on both physical channels of the double simplex bearer. The transmitting end releases the radio channel immediately afterwards and starts to scan on both radio channels for at least 4 TDMA frames. Within this 4 frames the "old" receiving side is now allowed to setup directly a double simplex bearer in the reverse direction.

The receiving TBC of a RELEASE message with the reason set to "reverse" shall report this event to the MBC. The MBC shall decide either to release the TBC or to setup a new double simplex bearer in reverse direction. Receiving a RELEASE message with reason set to "reverse" has the same effect as a normal release and a received LISTEN channel list message for this physical channel pair. To setup a new double simplex bearer the MBC proceeds with the double simplex setup procedure and takes into account that a equivalent to the LISTEN channel list message was already received.

NOTE: The "old" transmitting side of a double simplex bearer stops transmissions after sending the RELEASE message. If the RELEASE message is not received correctly a timeout should cause a release on the "old" receiving side (see clause 11.5).

10.7.2.4 REP relayed bearer release

In case of unacknowledged release procedure (see clause 10.7.2.1) of a bearer which has been mapped with another bearer (see clause 10.5.1.6):

- at the FT as transmitting side:

the radio channel and the associated TBC shall not be released after sending the RELEASE messages, IF it's an MBC decision to release the bearer and IF the channel is also interlaced with another channel (see clause 10.5.1.6 for definitions);

- at the FT as receiving side:

the radio channel and the associated TBC shall not be released after successful receiving of a RELEASE message IF the channel is also interlaced with another channel.

10.8 C/O data transfer

10.8.1 Higher layer associated signalling (C)

All higher layer control (C_S and C_F -channel data) is protected by a MAC layer ARQ procedure. This procedure is based on the principle that a data transmitter shall retransmit C_S and C_F segments when no acknowledgements for these segments have been received.

For the transmission of C-channel data time windows called ARQ windows are defined. These ARQ windows start with the normal TDMA half frame for transmissions. Therefore, the windows are different for FT and PT:

- ARQ windows for FT start with slot 0;
- ARQ windows for PT start with slot 12.

10.8.1.1 C_S -channel data

The C_S data service is a low rate service with a variable throughput of maximum 2 kbit/s. Independent of the number of bearers controlled by an MBC a maximum of one C_S segment may be transmitted in a given direction in an ARQ window of 10 ms. The same segment may, however, be duplicated over several bearers.

10.8.1.1.1 Transmission principle

- a) Those TDMA frames where the T-MUX algorithm does not allow C_T messages (see clause 6.2.2.1) shall not be used for transmissions of C_S segments.
- b) C_S data shall be sent only on duplex bearers. The same C_S segment may be sent on several duplex bearers during one frame. Only one C_S segment shall be transmitted within one ARQ window.
- c) If a C_S segment is sent in one particular ARQ window the successful transmission of this segment is confirmed when an acknowledgement is received in the second half of the same ARQ window on any of those duplex bearers which carried the C_S segment. Successful acknowledgement is achieved when the A-field of at least one of these bearers was received by the sending side of the C_S segment without CRC failure and with the Q2 bit in the header set to 1. In the direction FT to PT an acknowledgement is also given when Q2 equals 0 and Q1 is set to 1 (Q1 and Q2 bit setting, see clause 10.8.1.3).
- d) A C_S segment shall be retransmitted until the successful transmission of this segment is confirmed. Retransmission shall be done before another C_S segment is transmitted in the same data direction.

10.8.1.1.2 Numbering principle

- a) A one bit packet number is assigned to each C_S segment. The number shall alter for successive C_S segments. In databursts containing C_S segments this packet number is transmitted in the tail identification field of the A-field header (see clause 7.1.2).
- b) Packet number "1" shall be assigned to the first C_S segment transmitted by an MBC.

10.8.1.2 C_F -channel data

A MAC_CO_DATA-req primitive carrying C_F -channel data delivers a set of C_F segments to the MBC. The number of C_F segments building this set may be equal to or less than the maximum number of acceptable segments indicated by the MBC with the MAC_CO_DTR-ind primitive (see clause 8.4). The maximum number shall always be chosen such that all C_F segments can be transmitted in the B-field of one databurst.

C_F -channel data is transmitted as sets of C_F segments, a set of 1 segment for half slot, up to 4 segments for full slot, and up to 10 segments for double slot. Thus either all the C_F segments of one single MAC_CO_DATA-req primitive are contained in the B-field of an E-type databurst or no C_F data at all is in the B-field. The mapping of the C_F segments onto the B-field is described in clause 6.2.2.3.

10.8.1.2.1 Transmission principle

- a) C_F data shall be sent only on duplex bearers. The same set of C_F segments may be sent on several duplex bearers during one ARQ window. Only one set of C_F segments shall be transmitted within one ARQ window.
- b) If a set of C_F segments is sent in one particular ARQ window the successful transmission of this set is confirmed when an acknowledgement is received in the second half of the same ARQ window on any of those bearers which carried the C_F data. Successful acknowledgement is achieved when the A-field of at least one of these bearers was received without CRC failure and with the Q2 bit in the header set to 1. (Q2 bit setting, see clause 10.8.1.3).
- c) A set of C_F segments shall be retransmitted until the successful transmission of this set is confirmed. Retransmission shall be done before another set of C_F segments is transmitted in the same data direction.

NOTE 1: Retransmissions of an already acknowledged set of C_F segments is allowed as long as no new set of C_F segments is transmitted.

NOTE 2: Step c) implies that retransmissions may occur on another bearer and/or with interruptions. As a consequence the receiver should not accept any C_F data when the A-field CRC failed.

NOTE 3: E-type databursts containing MAC control only (e.g. release) may follow C_F transmissions on a bearer even when the C_F data are not yet acknowledged.

10.8.1.2.2 Numbering principle

- a) A one bit packet number is assigned to each set of C_F segments. The number shall alter for successive sets. In databursts containing a set of C_F segments this packet number is transmitted in the BA identification of the A-field header (see clause 7.1.4).
- b) Packet number "1" shall be assigned to the first set of C_F segments transmitted by an MBC.

10.8.1.3 Q1 and Q2 bit settings for I_N and I_P error detection services

The Q1 and Q2 bits are used for C-channel flow control and for quality control. The setting of the Q2 bit fulfils all necessary requirements to guarantee a reliable C-channel data service.

The setting of the Q1 bits may report some further quality details which can improve the functionality. Nevertheless, the setting of Q1 is optional and the meaning depends on the transmission direction.

The following two tables give an overview of the Q1 and Q2 bit setting for both directions.

Table 10.1: Q1 and Q2 sent from PT to FT

Q1 bit setting		Q2 bit setting	
antenna switch request	1	1	(A-field CRC passed) AND (all CF accepted when CF segments were received)
no special action from FT requested	0	0	(A-field CRC failed) OR (one or more CF segments not accepted)

Table 10.2: Q1 and Q2 sent from FT to PT

Q1 setting for given Q2		Q2 bit setting	
sliding collision	1	1	A-field CRC passed (AND B-field data accepted)*
no sliding collision	0	1	
A-field CRC passed	1	0	A-field CRC failed (OR B-field data rejected)*
A-field CRC failed	0	0	
* The indication whether or not B-field data have been accepted/rejected is only mandatory when a set of CF segments was received (see clause 10.8.1.3.1).			

The two following clauses describe the setting of Q1 and Q2 in more detail.

10.8.1.3.1 Q2 bit settings

For duplex bearers the Q2 bit is the bit a_7 of the A-field header. This bit is used for C_S and C_F -channel flow control and may also be used to report bearer quality. The Q2 bit shall be set in response to the last received databurst on this bearer.

The quality of double simplex bearer shall be reported with the bearer quality control message defined in clause 7.3.4.4. This message provides a Q2 bit for each simplex bearer. The location of the Q2 bits depends on the logical bearer number (LBN). The Q2 bits reserved for established double simplex bearers shall be set according to the last known quality results. The Q2 bits reserved for non-existing double simplex bearers shall be set to "0".

NOTE 1: No C-channel data is transmitted on double simplex bearers.

NOTE 2: For double simplex bearers the bit a_7 of the A-field header is always set to 0.

NOTE 3: During bearer handover of a double simplex bearer the values of the Q2 bits for this logical bearer should be ignored.

Rules for Q2 bit setting:

- the Q2 bit is set to "0" whenever the A-field CRC failed. If the A-field CRC passes the Q2 bit setting is determined by the rules b) or c);
- when a set of CF segments was received (correct A-field and BA bits indicate E-type with CF) the Q2 bit setting depends on the CF data only. Setting the bit to "1" indicates an acknowledgement for this set of CF data (duplex bearer only);
- if the B-field contains an IP segment the Q2 bit shall be set to "1";

- d) if the B-field contains an I_N segment or only MAC control (see BA bit setting in the A-field header) the Q2 bit setting depends on the transmission direction:
- d.1) **Data from FT to PT, Q2 from PT to FT:** The Q2 bit shall be set to "1";
 - d.2) **Data from PT to FT, Q2 from FT to PT:** The Q2 bit may either be set to "1" or report if the B-field data were accepted. In the latter case the Q2 bit shall be set to "1" for accepted B-field data and to "0" for rejected B-field data. It is the manufacturer's freedom to define the rules for accepting B-field data.

Notes to rule d.2):

NOTE 4: Manufacturers should set the Q2 bit according to B-field data acceptance. This option enables PTs to initiate a bearer handover whenever the bearer quality is bad. Tests may be based e.g. on the X-field CRC result or on R_B CRC results of B-subfields if MAC control was received.

NOTE 5: Q2 set to "1" is also an acknowledgement for received C_S data (duplex bearers only). If the setting of the Q2 bit depends on the acceptance of B-field data the Q1 bit setting option to report the A-field CRC result should also be applied. Otherwise the C_S data throughput may suffer.

10.8.1.3.2 Q1 bit settings

For duplex bearers the Q1 bit is the bit a_3 of the A-field header.

The Q1 bit for double simplex bearers in reverse direction is located in the bearer quality control message defined in clause 7.3.4.4. This message provides a Q1 bit for each simplex bearer. The location of the Q1 bits depends on the Logical Bearer Number (LBN) of the related double simplex bearer. All Q1 bits reserved for non-existing double simplex bearers shall be set to "0".

NOTE 1: For double simplex bearers the bit a_3 of the A-field header is always set to 0.

NOTE 2: During bearer handover of a double simplex bearer the values of the Q1 bits for this logical bearer should be ignored.

The setting of the Q1 bit has different optional rules for both directions, except when the received B-field contains an Ip error detect segment, then the Q1 bit may indicate any reception quality error. For example a B-CRC error may be reported by setting Q1, but also a request for antenna diversity or a sliding collision may be indicated this way. The peer side can use this information for a quality control algorithm, initiating antenna diversity, bearer replacement and/or handover.

Q1 transmitted in direction PT to FT: An RFP may be provided with antenna diversity. The PT may request the FT to switch the antenna by setting the Q1 bit to "1". Otherwise the Q1 bit is set to "0".

NOTE 3: Requesting to switch the antenna is optional. It is allowed to set Q1 always to "0".

Q1 transmitted in direction FT to PT: The rule to set the Q1 bit depends on the Q2 setting:

- a) **Q2 set to 1:** Q1 set to "1" indicates a detected sliding collision with another radio signal. Otherwise Q1 is set to "0"; If the option of reporting sliding collisions is applied the setting of the Q1 bit shall report a collision on one single received databurst on this bearer (i.e. no statistical averaging shall be applied).

NOTE 4: The indication of sliding collision is optional. It is allowed to set Q1 always to "0".

- b) **Q2 set to 0:** Q1 may be set according to the A-field CRC result: Q1 = "1" reports CRC passed and Q1 = "0" reports CRC failed. Otherwise Q1 is set to "0".

NOTE 5: Q1 setting according to the A-field CRC is optional. It is allowed to set Q1 always to "0".

If the option to report A-field CRC is applied the Q1 bit shall be set:

- in response to the last received databurst on this bearer for a duplex bearer;
- in response of the last known CRC result of this bearer for a double simplex bearer.

10.8.2 MOD-2 protected I-channel operation (I_P)

10.8.2.1 General

The modulo-2 procedure uses a 2-state packet number in the A-field header. This packet number applies to the complete B-field of I_P data. The first I_P packet sent on a new logical bearer is labelled with packet number "1".

Successful reception of the data is acknowledged independently for each logical bearer. For duplex bearers the acknowledgement mechanism uses the Q2 and the BCK bits in the return A-field header. For double simplex bearers, these bits, the Q2 and BCK bits, for each logical simplex bearer are multiplexed into a "MAC-MOD2-ACKS" message, and this message is sent in at least one B-subfield on at least one reverse bearer.

MOD-2 operation in the asymmetric case shall use the E32-mux or the E80-mux in the reverse direction.

NOTE: The MOD-2 receiver may use selective reception, or even majority voting to achieve CRC success.

10.8.2.2 Limiting the lifetime of packets

The originating entity (the sender of packets) is required to limit the lifetime of every data packet to an integral number of TDMA frames, according to the service demanded by the DLC layer in the MAC_CON-req primitive.

This requirement shall be met by stopping the MOD-2 retransmission of any packet that exceeds this time limit, irrespective of whether an acknowledgement has been received from the peer TBC. This process will typically cause invocation of one of the "data jump" procedures described in clause 10.8.2.5.

10.8.2.3 A-field shall always be correct

The receive procedure is required to always receive the A-field successfully before accepting any of the B-field during MOD-2 operation.

NOTE: This requirement means that E-mode interruptions are allowed at any time. For example a B-field MAC message ("bearer release") can be sent on the old bearer during bearer handover, without causing an exception condition and risking data errors.

10.8.2.4 Use of the acknowledge bits

During MOD-2 operation two bits are used for I_P-channel flow control. These bits are located in different positions for duplex and double simplex bearers. The two bits are:

- the Q2 bit and the BCK bit in the A-field header at positions a₃ and a₇ as described in clause 7.1 for a duplex bearer;
- two pairs of an Q2 and a BCK bit in the quality control message described in clause 7.3.4.4 for a double simplex bearer.

The settings of the Q2 bit is described in clause 10.8.2.4.1.

The setting of the BCK bit is described in clause 10.8.2.4.2.

The two control bits Q2 and BCK in the A-field shall be set individually for each duplex bearer of a symmetric or an asymmetric connection.

The two control bits Q2 and BCK in the quality control message shall be set individually for each logical half of a double simplex bearer in asymmetric connections. The Q2 bits for non-existing logical double simplex bearers shall be set to "0" and the BCK bits to "1".

During bearer handover of a double simplex bearer, the acknowledge results for the old and the new bearer (bearers with the same LBN) should be combined to produce a single set of results.

NOTE: It is not allowed to transmit two different I_P segments in the same TDMA half frame on the "new" and the "old" double simplex bearer during bearer handover (see clause 10.6.3).

10.8.2.4.1 Q2 and ACK bit setting for I_P_error_correction services

Q2 bit setting for duplex bearer

The Q2 bit setting influences the retransmission mechanism from C_S, C_F and I_P data. The setting of the Q2 bit is exactly the same as in I_P_error_detection services (see clause 10.8.1.3.1).

NOTE: When an I_P segment was received (A-field CRC correct and the BA bits set to I_P segment with number 0 or 1) the Q2 bit is set to "1", regardless of the results of the B-field CRCs. The MOD-2 retransmission scheme assumes for proper operation, that the packet number of the I_P segment is then known to the I_P data receiver.

Q2 bit setting for double simplex bearer:

Data received on a double simplex bearer is acknowledged on another bearer in reverse direction. The reverse bearer provides an Q2 bit for each simplex bearer in forward direction.

The Q2 bit on the reverse bearer does not influence the C_S and the C_F retransmission scheme and is set as follows:

- When an I_P segment was received (A-field CRC correct and the BA bits set to I_P segment with number 0 or 1) the Q2 bit is set to "1", regardless of the results of the B-field CRCs.

Exception: When receiving a RESET message (during a I_P bearer reset procedure, see clause 10.8.2.5.3) the Q2 bit shall be reset to "0".

10.8.2.4.2 BCK bit setting

In MOD-2 mode the second control bit, BCK, is used to report the I_P packet number of the next expected I_P segment.

NOTE: An unilateral jump procedure (see clause 10.8.2.5.2) may toggle the BCK bit.

10.8.2.5 Data jump procedures

"Data jump" is defined as the name for any procedure that is used to unstick a bearer that is failing to transmit its I_P data successfully. This is required to stop a retransmission when the packet lifetime has expired, or to stop a transmission if the packet has been rescheduled (via another bearer). There are three data jump procedures:

- bearer replacement (incl. bearer release);
- unilateral (unacknowledged) jump;
- I_P bearer reset.

NOTE 1: In the preferred implementation the MBC functional block contains the data jump control.

NOTE 2: Data jump procedures may cause a loss and/or a duplication of data.

NOTE 3: Rescheduling of data packets has to be taken into account by the transmitting side in respect to the agreed packet lifetime. The rescheduled packets may be sent on any bearer of the connection.

10.8.2.5.1 Bearer replacement

In the event of repeated data errors, bearer handover is the expected MAC response. Bearer handover is attempted, and bearer release may occur if the handover is unsupported or unsuccessful. If a (non-seamless) handover is done - here defined as "bearer replacement", then it can provide a data jump.

During normal bearer handover a new bearer with the same LBN is created. The packet numbering of both bearers is the same, and I_P data is duplicated on both bearers.

"Bearer replacement" is defined to be the case where an old bearer is replaced with a new bearer that has a different LBN. For bearer replacement the new bearer contains independent packet numbering for I_P MOD-2 protected data. Now the data on a new bearer may be different data or may (still) be a duplicate of the data on the old bearer.

NOTE 1: Due to the inevitable lower performance obtained by this procedure, the bearer handover procedure should be used in the event of repeated errors.

NOTE 2: In case the bearer replacement procedure is used for connections where the agreed target value equals the minimum, timer T201 allows the amount of bearers to be less than the minimum during 5 seconds.

10.8.2.5.2 Unilateral jump

The unilateral jump process is described with two state tables, one for the transmitter, and one for the receiver.

Receiver:

The three state variables at the receiver are:

- LAST-BCK meaning "what packet number was transmitted in the last BCK bit to indicate the number of the next expected I_p segment";
- LAST-PKT meaning "what I_p packet number appeared in the last databurst containing I_p data";
- THIS-PKT-NO meaning "what IP packet number appears in the databurst just received containing I_p data".
- NEXT-PK-NO meaning "what I_p packet number the Receiver shall ask for in the next burst".
- The variables LAST-PKT and THIS-PKT-NO can take three values: „0", „1" and „unknown". The value „unknown" is produced if it not possible to determine the I_p packet number appeared in the databurst. This situation is produced, for instance, when the CRC of A-field is incorrect.

The Receiver, after evaluating the received I_p packet (see clause 10.8.2.3.) evaluates the state variables following table 10.3 to know how the Transmitter acted; after that, it evaluates the Rb-CRCs of all the B subfields and shall act as indicated in table 10.4.

Table 10.3: Unilateral Jump TX action

	THIS-PKT=LAST-PKT	THIS-PKT=LAST-BCK	How transmitter acted
(a)	yes	Yes	Retransmit
(b)	no	Yes	normal advance
(c)	yes	No	unnecessary retransmit
(d)	no	No	Jump
(e)	Unknown	Yes	Either retransmit or advance
(f)	Unknown	No	Either retransmit or jump
(g)	Unknown	Unknown	Unknown

NOTE: The states (e), (f) happens when LAST-PKT is unknown and the state (g) when THIS-PKT is unknown.

Table 10.4: Unilateral Jump RX action

Table 78 state	Rb-CRC result	how Receiver shall act
(g)	Not considered	NEXT-BCK = LAST-BCK
(a), (b), (e)	Rb-CRCs passed	NEXT-BCK = LAST-BCK + 1 (MOD 2)
(a), (b), (e)	Rb-CRCs failed	NEXT-BCK = LAST-BCK
(c)	Rb-CRCs passed	NEXT-BCK = LAST-BCK; RX still requires the same I _p packet
(c)	Rb-CRCs failed	NEXT-BCK = LAST-BCK; RX still requires the same I _p packet
(d), (f)	Rb-CRCs passed	NEXT-BCK = LAST-BCK
(d), (f)	Rb-CRCs failed	NEXT-BCK = LAST-BCK + 1 (MOD 2)

NOTE: In cases (e) and (f), the receiver can not be sure what was the action in the TX side. In these cases the packet should be delivered to the DLC layer.

Transmitter:

Define: **LT_{IP}** = packet number of the last transmitted I_P segment.

The two state variables at the transmitter are:

- **ACKN** meaning " an I_P packet has been received in the receiver last databurst";
 - for duplex bearer the reception of the IP packet is acknowledged by receiving an A-field correct and with the Q2 bit set to 1 (see clause 10.8.2.4.1);
 - for double simplex bearer the reception of the IP packet is acknowledged by receiving an A-field correct and with Q1 bit set to 1 (see clause 10.8.2.4.1).

NOTE 1: For double simplex bearer this process is independent for both simplex bearers.

- **LAST-BCK** meaning "what was the setting of the last correct received BCK bit (with the BCK bit the receiver reports the next expected I_P packet)?".

NOTE 2: If ACKN switches to "yes" also a new BCK is received.

Table 10.5

	ACKN	LT_{IP} = LAST-BCK	How transmitter shall act
(a)	Yes	No	normal advance (or retransmit)
(b)	Yes	Yes	retransmit or jump
(c)	No	No	retransmit or jump
(d)	No	Yes	retransmit or jump

The transmitter shall use the jump procedure when the packet limit lifetime expires.

In state (b) the transmitter can choose between retransmission and jump. Its choice is reflected in the pkt number chosen. If jump the pkt number toggles if retransmit the pkt number is unchanged.

10.8.2.5.3 MAC I_P bearer reset

Any Control using an E-Type multiplex interrupts I_P data flow on a physical channel of a logical bearer without warning. A MAC I_P bearer reset on that half of the logical bearer which uses a particular physical channel is accomplished by the transmission of a RESET_REQUEST message on that physical channel.

NOTE: During bearer handover one half of a logical bearer may consist of two physical channels, one physical channel belonging to the 'old' bearer and one belonging to the 'new' bearer. The reception of a RESET_REQUEST message on either of these physical channels indicates an I_P bearer reset. No U-type multiplex, i.e. I_P-channel data, would be sent on either of these physical channels until the MAC I_P bearer reset is completed.

The transmitter (T-side) repeats the RESET_REQUEST message on the same logical half bearer until a RESET_CONFIRM message is received in reply or the bearer is released. No further I_P data shall be sent on this bearer, until the reply is received.

The receiving end (R-side) of a RESET_REQUEST message shall reset the packet number sequence variable and the receive buffers of that logical half bearer on which the message was received. The R-side shall reply with a RESET_CONFIRM message. The RESET_CONFIRM message may be transmitted on any bearer with capacity in direction to the T-side, and may be duplicated onto more than one bearer.

If possible the RESET_REQUEST and RESET_CONFIRM messages should be duplicated onto more than one B-subfield of a bearer. The RESET messages are defined in clause 7.3.4.3.

Upon receipt of RESET_CONFIRM the T-side may resume transmission of I_P data on the logical half bearer, starting with packet 1.

10.8.3 Higher layer unprotected information (I_N) and MAC error detection services (I_P)

10.8.3.1 I_N _minimum_delay service

Each U-type databurst carries one I_N data segment. The MBC asks for each I_N data segment with a MAC_CO_DTR-ind primitive and receives one I_N segment from the DLC in a MAC_CO_DATA-req primitive (see clause 8.4).

NOTE: During bearer handover two established bearers may be assigned to one logical bearer. The I_N data segments transmitted in one TDMA frame on these two bearers need not be the same.

10.8.3.2 I_N _normal_delay and I_P _error_detection services

At the beginning of each TDMA half frame the MBC shall dispose of all I-channel (I_N or I_P -channel) segments which are transmitted in this TDMA half frame (see clause 8.4). The number of segments equals the number of logical simplex bearers which are allocated for I-channel data transmissions in this TDMA half frame. For segments that have no sequence numbering inside (e.g. FU1 and FU2), the segments shall be assigned to the allocated logical simplex bearers in ascending order: the first segment to the logical simplex bearer with the smallest LBN number, the last segment to that bearer with the highest LBN number. For segments that do have sequence numbers inside, the segments can be assigned to the allocated logical simplex bearers in any order.

NOTE 1: There might exist additional logical simplex bearers which are reserved for transmissions of extended control.

NOTE 2: The list of available LBN numbers may be not continuous: In one TDMA half frame there might be 4 logical simplex bearers with e.g. LBNs 1, 2, 4 and 7 to transmit I-channel data, one simplex bearer with LBN 6 which is used to transmit extended control and two logical simplex bearers with the LBN numbers 3 and 5 for receiving data. Bearers with successive LBNs might not be in consecutive slot order.

10.9 C/O procedures for FT connections with CRFP

The following procedures provide means to address CRFPs on one physical relayed connection of an FT with a PT. The connection with the PT is either in relay state or local state. In relay state, all higher layer C-plane signalling shall be relayed by the CRFPs between FT and PT. In local state, all higher layer C-plane signalling shall be buffered at the FT and CRFP. The local state is a temporary state to allow higher layer communication between FT and a specific CRFP. The procedures defined in this section are required to support encryption of connections relayed by a CRFP.

10.9.1 Dual C/O bearer setup

At FT:

Initially a bearer will be established between the FT and CRFP (identified by its PMID). The FT regards the CRFP initially as a PT. A relayed bearer setup as defined below can only be accepted at the FT when a bearer to the CRFP already exists. By definition the FT is then in the local state.

A relayed bearer setup, indicated by the "bearer_request" without the "first PT transmission" code, shall be treated at the FT as a request from a CRFP. The TBC shall request the LLME to be connected to the MBC related to the PMID (of the PT) received in the message. Then the connection setup procedure as defined in clause 10.2 shall continue. The FT is now establishing the connection via the CRFP with the PT identified by the PMID. When the first bearer of the connection with the PT is established, the connection shall automatically enter the relay state.

At the FT both relayed and local mode connections have been established on one physical connection. However only one of these connections shall be active at the same time, and the other connection is suspended.

10.9.2 C/O connection release of connection with CRFP

When the MBC related to a PT is released, the FT shall release all MBCs associated with the corresponding TBCs.

10.9.3 C/O connection suspend and resume

Modification of the state of the connection with a CRFP after the connection is established, can be accomplished by suspending/resuming connections with the related MBC's in FT and CRFP. This procedure may be necessary to update cipher keys in the CRFP.

At FT:

To support the communication with a specific CRFP, the FT shall be able to address a specific CRFP identified by the PMID on one physical MAC connection. The FT shall be able to temporarily suspend the connection with the PT.

The LLME at the FT shall decide to change the connection of a TBC from one MBC (MBC_1) to another MBC (MBC_2), that is suspended. First the LLME shall suspend the connection of MBC_1 for transmission and resume connection of MBC_2 for transmission. The MBC_1 shall still receive channel data. The MBC_2 then issues the called address (FMID/PMID) to the TBC. The TBC shall transmit an "access_request" on the active TBC with the "normal MT transmit" code.

When the TBC receives "bearer_confirm" the TBC shall report to the MBC_2 that the switch is successfully established, which immediately (next frame) resumes the connection with MBC_2 for reception and suspends the connection with MBC_1 for reception.

In case of a basic connection, the access request and bearer confirm messages belong to the basic connection control set and in case of an advanced connection, the access request and bearer_confirm messages belong to the basic connection control set.

NOTE: This procedure can be used for single bearer connections and multi bearer connections. Furthermore it supports all I_N and I_P channels.

11 Medium access layer management procedures

11.1 Broadcasting

11.1.1 RFP transmission

The DECT fixed part's management entity makes all the N and Q-channel information available to the BMC by means of a MAC_ME_RFP_PRELOAD-req primitive (see clause 8.3.2.1). The LLME may update this information at any time. This primitive is used to give the MAC layer the SARI messages (see clause 7.2.3.6).

11.1.2 PP reception

The MAC layer of the PP passes Q and N logical channel information to the LLME by means of a MAC_ME_INFO-ind primitive. If necessary, the LLME responds with a MAC_ME_INFO-res primitive (see clause 8.3.2.3).

The PP shall understand and comply with all Q-channel information that is needed for the service that the PP requires. For example, a PP that requires an RFP to supply it with frequency control information, shall check that the RFP provides this capability before attempting to establish a connection with it.

11.2 Extended system information

11.2.1 PP requests

The PP may use this facility to submit its ARI(s) for checking by the RFP in its TARI list. The procedure is invoked by the LLME passing a MAC_ME_EXT-req primitive (see clause 8.3.2.4) to the MAC layer. When the MAC layer has received a reply from the RFP, it issues a MAC_ME_EXT-cfm primitive (see clause 8.3.2.4) containing the SDU.

11.2.2 RFP response

An RFP of an FP that provides the extended system information service shall issue a MAC_ME_EXT-ind primitive to the LLME after receiving an extended system information request. The LLME may return a reply with a MAC_ME_EXT-res primitive. Data delivered within this primitive shall be transmitted within T206 frames after receiving the extended system information request.

11.3 PP states and state transitions

Refer to figure 4.7 for PP states and transitions.

11.3.1 Actions in Idle_Unlocked and Active_Unlocked states

In the Idle_Unlocked state, a PP need not do anything.

In the Active_Unlocked state, PPs occasionally try and enter the Idle_Locked state (see clause 11.3.2).

A PP may change between the Idle_Unlocked and the Active_Unlocked state as it wishes.

11.3.2 Entry into the Idle_Locked state

An Active_Unlocked PP occasionally scans for a DECT fixed part with which it can enter the Idle_Locked state. The timing of the start and end of this scan are controlled by the management entity which should consider such things as power consumption and SARI list length.

NOTE: The primitives PL-ME-SYNC, PL-RX, PL-ME-SIG_STR are described in clauses 7.1 and 7.2 of the DECT physical layer (see EN 300 175-2 [2]).

The scan can be achieved using PL_ME_SYNC primitives to obtain slot timing and PL_RX primitives to obtain N and Q-channel information. The Q-channel information allows frame, multi-frame, and receiver scan synchronization to be obtained.

The PP uses a MAC_ME_INFO-ind primitive to pass a PARI or a SARI to the management entity. The management entity issues a MAC_ME_INFO-res containing the PARI only if it identifies an acceptable ARI.

The PP should then use PL_ME_SIG_STR and PL_RX primitives to select the RFP (that transmits the above PARI) with the strongest signal strength.

If the PP wishes to enter the Idle_Locked state it shall extract all the transmitted Q_T information that is necessary for all the MAC and physical layer service types that it can use.

EXAMPLE: If a PP can implement encryption and only B-field connection setups, it has to receive the "multiframe number" and the "fixed part capabilities" messages.

After this Q_T information has been obtained, the PP may enter the Idle_Locked state.

11.3.3 Actions in the Idle_Locked state

In the Idle_Locked state, the PP shall maintain frame and multiframe synchronism with the FP and may occasionally scan for RFPs with a stronger signal strength. If a stronger RFP is found, then the PP may lock to this RFP instead. In addition the PP should be able to receive paging messages and may provide the means to detect connection setup attempts from the FP (fast setup).

In order to remain in the Idle_Locked state the PP shall:

- resynchronize its timing with the FP's timing at least every T216 multiframe (see EN 300 175-2 [2]);
- receive in frame 0 at least one A-field with correct CRC every T207 seconds; and
- receive at least one N_T type tail containing the PARI in the MAC_ME_INFO-res primitive every T208 seconds.

If any of these conditions are not met, the PP shall enter either the Active_Unlocked state or the Idle_Unlocked state.

At any time an Idle_Locked PP may leave this state and enter either the Active_Unlocked state or the Idle_Unlocked state.

11.3.3.1 Page detection in Idle_Locked state

In Idle_Locked state the PP should receive the BS-channel. To provide this function three typical modes of operation for an Idle_Locked PP are described below.

High duty cycle Idle_Locked mode: the PP receives all BS-channel data that is transmitted in frames 0, 2, 4, 6, 10, and 12 of the multiframe sequence. High duty cycle Idle_Locked mode enables a PP to receive fast pages (see clause 9.1.3)

NOTE 1: Higher layer functions are used to ascertain whether a PP is likely to respond to fast paging (see EN 300 175-5 [4]).

Normal Idle_Locked mode: the PP at least receives any BS-channel data transmitted in frame 0 and in any additional frames that are commanded by the extend flag.

Low duty cycle Idle_Locked mode: in at least one out of every four multiframes the PP shall attempt to receive any BS-channel data transmitted in frame 0 and in any additional frames that are commanded by the extend flag. Unless the FP broadcasts that low duty Idle_Locked mode is supported (see "page repetition bit" in "fixed part capabilities", clause 7.2.3.4) the PP shall not enter this mode.

NOTE 2: PPs in low duty cycle Idle_Locked mode do normally not receive long page messages which are used by higher layers for connectionless downlink services.

11.3.3.2 Setup detection in Idle_Locked state

PPs may allow FPs to setup a connection without prior paging. This process is called fast setup and described in clause 10.2.3.

NOTE 1: Higher layer functions are used to ascertain whether a PP is likely to respond to fast setups attempts.

To provide the fast setup capability the PP's receiver scan sequence is synchronized with that of the RFP (see clause 11.9). It receives in every slot on the scanned RF channel and is looking for a "bearer request" message containing its own PMID.

NOTE 2: The RFP transmissions do not indicate the first transmission with a special header coding.

For RFP transmissions, the "Paging tail (P_T)" uses the same header coding as the "First PT transmission" header code. The correct meaning of this coding shall be implied by the direction of transmission (see clause 7.1.2).

11.3.4 Idle_Locked and Active_Locked state transitions

Entry into the Active_Locked state can only be achieved from the Idle_Locked state. This transition is achieved by the establishment of a connection, as described in clause 10.2 or by the resumption of a connection.

When an Active_Locked PP releases its last existing connection or suspends its last connection in "active state", it shall return to the Idle_Locked state.

11.4 Physical channel selection

The physical channel selected for a MAC bearer is only allowed to be changed due to a detected need to change it. Typical needs are detection of bad quality or interference on the physical channel in use, detection of an RFP that is stronger than the own RFP, detection of a physical channel with less interference than the one in use, and detection of local congestion.

11.4.1 The channel selection lists

Prior to the first transmission on any bearer DECT RFPs and PPs have to select physical channels. To find appropriate channels the channels shall be ordered according to the measured field strength.

The term "channel" refers to the relevant physical channel of a TDD pair (i.e. two time slots using the same frequency, and starting points of the time slots are separated by 0,5 frame). The RSSI measurement in the relevant physical channel determines the selection performance for one or both physical channels of a TDD pair. The choice of the relevant physical channel of a TDD pair depends on the wanted bearer type.

a) Duplex bearer:

for a duplex bearer the relevant physical channel is the receiving physical channel, e.g. for a PP the RSSI measurement in slot 3 on frequency f_x defines the selection performance to use slot pair (3/15) on this frequency as a duplex bearer.

b) Double simplex bearer:

for a double simplex bearer the relevant physical channel is that channel of the TDD pair with the higher measured field strength, e.g. for a PP the higher of the RSSI values measured in slots 3 and 15 on frequency f_x defines the selection performance to use slot pair (3/15) on this frequency as a double simplex uplink bearer.

c) Simplex bearer:

for a simplex bearer the relevant physical channel in the transmitter is different for PPs and RFPs. For PPs it is the receiving TDD half of the desired physical channel, e.g. the RSSI measurement in slot 3 on frequency f_x defines the selection performance to use slot 15 on this frequency as an uplink simplex bearer. For RFPs it is that channel of the TDD pair with the higher measured field strength.

Table 11.1

Wanted bearer type	Relevant physical channel of the TDD pair	
	Selection by a PP	Selection by an RFP
duplex	channel in normal receiving TDD half frame	channel in normal receiving TDD half frame
simplex	channel in normal receiving TDD half frame	channel with higher measured RSSI
double simplex	channel with higher measured RSSI	channel with higher measured RSSI

The resolution of the RSSI measurement shall be better than or equal to 6 dB as defined in EN 300 175-2 [2]. The lowest boundary shall be equal or less than - 93 dBm. Channels with a measured RSSI of less than this lowest boundary are considered as quiet channels, and may be immediately selected for a bearer setup attempt. An upper limit may be defined where a channel is considered to be busy. Channels with a RSSI of more than this upper limit need not be ordered with a resolution of 6 dB, but these channels shall not be selected for a bearer setup attempt. Channels with a measured field strength which lies between these two boundaries shall be ordered according to the measured field strength into "n" bands. The RSSI difference of all channels within the same band shall not exceed 6 dB.

NOTE 1: The upper limit may be a variable which depends on the interference environment. Nevertheless the upper limit can not exceed the highest field strength for which a receiver guarantees a RSSI measurement resolution of 6 dB.

The description above leads to the "n"-bandbin model, given in table 11.2.

Table 11.2: RSSI model

RSSI	σ RSSI	band	comment
> max dBm	∞	busy	busy, don't try
	≤ 6 dB	b(n)	possible candidates
	.	.	
	.	.	
	≤ 6 dB	b(4)	
	≤ 6 dB	b(3)	
	≤ 6 dB	b(2)	
	≤ 6 dB	b(1)	
< min dBm	∞	quiet	quiet, always allowed

Depending on the wanted bearer type a basic channel list can be modelled where a quality assignment based on the measured RSSI exists for each TDD pair of physical channels, i.e. for each slot pair of each frequency. The quality assignment is either a band number (b(1), ..., b(n)), a "busy" sign or a "quiet" sign.

The basic channel list describes the overall DECT interference environment for a given upper limit "max" and does not depend on any system restrictions. It is not required that DECT equipments set up a complete basic channel list. However, different slot types require different channel lists.

In reality there might exist channels which cannot be measured or used.

EXAMPLE 1: A DECT equipment may be unable to use slot pair (4/16) on frequency f_x having at the same time an established bearer on slot pair (3/15) and frequency f_y .

EXAMPLE 2: A DECT equipment may be unable to measure the RSSI in slot 15 and frequency f_x while having a bearer established in slot pair (3/15) and frequency f_y .

EXAMPLE 3: An RFP may not be allowed to support all 10 DECT frequencies.

A modified channel list shall therefore take into account all known restrictions. "busy" is used below as a general term for channels that shall not be used. A DECT equipment shall be able to create a modified channel list with following properties:

- a) all entries of own blind slots or blind TDD channel pairs shall be regarded as busy;
- b) not supported frequencies at the FP shall be regarded as busy.

NOTE 2: The information concerning frequencies that are not supported at the FP are broadcast by the FP with the static system information message (see clause 7.2.3.2).

The following deviations are allowed for the modified channel list:

- a) if all possible candidates are below the lower limit "min", the list of quiet channels need not be complete;
- b) the uppermost band of possible candidates (band b(n)) need not be complete, i.e. there might exist channels belonging to b(n) which are regarded as "busy". Nevertheless, the bands below the band b(n) as well as the list of quiet channels have to be complete.

NOTE 3: These two deviations allow the RFP or PP to only create a list of m candidate channels which are quiet and/or the quietest channels. Here the upper limit "max" is a variable and depends on the interference environment. All except the m quietest channels are regarded as "busy".

In addition further channels may be regarded as busy due to restrictions at the far end, e.g. received blind slot or POOR channel information.

NOTE 4: Blind slot information is temporary and specific for each RFP of an FP.

PPs should take into consideration a recognized connectionless downlink bearer or a dummy bearer of the locked RFP.

NOTE 5: The PP's RSSI measurement for the channel used by the RFP for the broadcast or connectionless service will normally lead to the decision not to select it. Nevertheless this channel may be the preferred channel for a new bearer, e.g. a connectionless uplink bearer or a duplex bearer when allowed (see fixed part capabilities, clause 7.2.3.4).

The maintenance of the modified channel list may be done regularly or upon need, subject to rules in clauses 11.4.2 and 11.4.3.

11.4.2 Physical channel and RFP selection at the PP

A PP shall be in a locked state (Idle_Locked or Active_Locked) before it may start transmission on a physical channel.

The initial set up should be performed so as to always connect to the strongest possible RFP, and it shall use the signal strength values obtained with PL_ME_SIG_STR primitives as a criteria. Therefore it is recommended to make at least 3 attempts to the strongest RFP before selecting the next strongest RFP.

The selection of physical channels shall be subject to all of the following rules:

- a) for a duplex bearer the TDD pair including the dummy bearer may only be selected when allowed (see clause 7.2.3.4);
- b) unless the selected channel has a measured RSSI that meets the "quiet" criterion (see clause 11.4.1), the complete modified channel list shall have been updated within the last T209 seconds;
- c) channels marked as "busy" shall not be selected;
- d) for bearer handover and for setting up the pilot channel of an I_N_normal_delay or an I_P service:
 - d1) if the quietest unselected channel is marked as "quiet": if none of the unselected quiet channels can be accessed within the next three TDMA frames, a channel of bands b(1) or b(2) may be selected; otherwise a quiet channel shall be selected for the next setup attempt;
 - d2) if the quietest unselected channel is in band b(x), $x < (n-1)$: If none of the unselected channels in band b(x) can be accessed within the next three TDMA frames, a channel of bands b(x+1) or b(x+2) may be selected; otherwise a channel of band b(x) shall be selected for the next setup attempt;
 - d3) if the quietest unselected channel is in band b(n-1): If none of the unselected channels in band b(n-1) can be accessed within the next three TDMA frames, a channel of band b(n) may be selected; otherwise a channel of band b(n-1) shall be selected for the next setup attempt;
 - d4) if the quietest unselected channel is in the highest band b(n): A channel in band b(n) shall be selected for the next setup attempt;
- e) for all other bearer establishments:
 - e1) unless all channels marked as "quiet" have been selected at least once, no channel of the bands b(1) to b(n) shall be selected;
 - e2) unless all channels of the bands b(1) to b(x-1) have been selected at least once, no channels of the band b(x) shall be selected;
- f) in any time window of T210 seconds the number of channel selections shall not exceed the value N202 multiplied by a factor which depends on the number of required bearers (see table 11.3).

The number of required duplex and double simplex bearers is calculated as the difference between the target number of bearers and the number of already established bearers at the beginning of the time interval.

Table 11.3: Maximum number of selections

Number of required bearers	Maximum number of selections
1	1 * N202
2 - 3	2 * N202
4 - 7	3 * N202
8 - 15	4 * N202
> 15	5 * N202

NOTE 1: For uplink simplex bearers a lower limit is defined in clause 9.2.1.

NOTE 2: For multibearer connections a complete set of channels may be selected at the start of the connection establishment procedure using the channel selection rules. The parallel setup attempts of the multibearer connection may then use these selected channels in any order (for example the order of known receiver scanning and/or an order indicated by received channel list messages).

- g) unless a "GOOD" or a "LISTEN" channel list message or "acceptable channel" information is received a channel shall not be reselected for access to the same RFP until the modified channel list has been completely updated;
- h) a channel may only be selected if it is checked within the last 2 frames before the first transmission, and the RSSI shall not be more than 12 dB stronger than the previous value (checking channels: see clause 11.4.1);

EXAMPLE: Having made a RSSI measurement with a 6 dB resolution the channel may still be selected for a new bearer when it belongs to band $b(x+1)$, assuming the channel was previously in band $b(x)$. The channel shall not be selected for a new bearer if it belongs to a band higher than $b(x+1)$.

- i) the PP may use information from the RFP (e.g. "acceptable channel" or "channel list" information) to aid its choice of channel. Nevertheless, rules a) to h) shall not be violated.

NOTE 3: For simplex uplink bearers this selection procedure is only applied when no dummy or C/L downlink bearer has been found. Otherwise the TDD pair of this downlink bearer has to be chosen for the uplink (see clause 9.2.2).

In addition to these rules it is recommended not to use any channel pair for setting up a duplex or a double simplex bearer to a specific RFP when a C/L downlink or a dummy bearer of another RFP was recognized in the normal receive channel of the PP (slot 0..11).

It is allowed to use the PP channel selection rules for simplex bearers for setting up a dummy bearer when a PP acts as the RFP in PP-to-PP direct communication mode.

11.4.3 Physical channel selection at the RFP

For an FT initiated setup of a duplex bearer (fast setup, see clause 10.5.1.3) and for setting up a double simplex downlink bearer (see clause 10.5.1.4) the RFP shall know the receiver scanning sequence of the PP before it may transmit a "bearer request" message on a physical channel.

For the creation of a dummy bearer following the termination of all other bearers at an RFP, the RFP should select without interruption the channel previously occupied by the last active downlink bearer. The selection of physical channels in all other circumstances or if this recommendation is not followed shall be subject to all of the following rules:

- a) unless the selected channel has a measured RSSI that meets the "quiet" criterion (see clause 11.4.1), the complete modified channel list shall have been updated within the last T209 seconds;
- b) channels marked as "busy" shall not be selected;

- c) for setting up the pilot bearer and for bearer handover of a double simplex bearer when the RFP is in operation as the T-Side:
- c1) if the quietest unselected channel is marked as "quiet". If none of the unselected quiet channels can be accessed within the next three TDMA frames, a channel of bands b(1) or b(2) may be selected; otherwise a quiet channel shall be selected for the next setup attempt;
 - c2) if the quietest unselected channel is in band b(x), $x < (n-1)$. If none of the unselected channels in band b(x) can be accessed within the next three TDMA frames, a channel of bands b(x+1) or b(x+2) may be selected; otherwise a channel of band b(x) shall be selected for the next setup attempt;
 - c3) if the quietest unselected channel is in band b(n-1). If none of the unselected channels in band b(n-1) can be accessed within the next three TDMA frames, a channel of band b(n) may be selected; otherwise a channel of band b(n-1) shall be selected for the next setup attempt;
 - c4) if the quietest unselected channel is in the highest band b(n). A channel in band b(n) shall be selected for the next setup attempt;
- d) for all other bearer establishments:
- d1) unless all channels marked as "quiet" have been selected at least once, no channel of the bands b(1) to b(n) shall be selected;
 - d2) unless all channels of the bands b(1) to b(x-1) have been selected at least once, no channels of the band b(x) shall be selected;
- e) in any time window of T210 seconds the number of channel selections shall not exceed the value N202 multiplied by a factor which depends on the number of required bearers (see table 11.4);

The number of required double simplex bearers is calculated as the difference between the target number of bearers and the number of already established bearers at the beginning of the time interval.

Table 11.4: Maximum number of selections

Number of required bearers	Maximum number of selections
1	1 * N202
2 - 3	2 * N202
4 - 7	3 * N202
8 - 15	4 * N202
> 15	5 * N202

NOTE 1: Setting up dummy or C/L downlink bearer needs only one selection. Therefore no limit for simplex downlink bearer is needed.

NOTE 2: For multibearer connections a complete set of channels may be selected at the start of the connection establishment procedure using the channel selection rules. The parallel setup attempts of the multibearer connection may then use these selected channels in any order (for example the order of known receiver scanning and/or an order indicated by received channel list messages).

- f) unless a GOOD or a LISTEN channel list message is received a channel shall not be reselected for access to the same PP until the modified channel list has been completely updated;
- g) a channel may only be selected if it is checked within the last 2 frames before the first transmission, and the RSSI shall not be more than 12 dB stronger than the previous value (checking channels: see clause 11.4.1);

EXAMPLE: Having made a RSSI measurement with a 6 dB resolution the channel may still be selected for a new bearer when it belongs to band b(x+1), assuming the channel was previously in band b(x). The channel shall not be selected for a new bearer if it belongs to a band higher than b(x+1).

- h) the RFP may use information from the PP (e.g. CHANNEL_LIST information) to aid its choice of channel. Nevertheless rules a) to g) shall not be violated.

In addition to these rules it is recommended not to use any channel pair for setting up any bearer when a C/L downlink or a dummy bearer of a neighbour RFP was recognized in the normal transmit channel of the RFP (slot 0..11).

11.4.4 Hand over criteria due to in-connection base identification

Bearer and connection handover should be performed so as to always connect to the strongest (free) RFP, and it should use channel quality and shall use the signal strength values, the latter obtained using the procedure specified in EN 300 175-2 [2] as a criteria. Information from MAC "channel list" messages may also be used.

11.4.5 Handover criteria due to interference

The handover decision process should be optimized to make a quick intra-cell handover when the DECT transmission suffers interference during a *few consecutive* frames. This is because most interference normally comes from DECT transmissions in the same band, and DECT transmissions will always occur in consecutive frames.

NOTE: Interference may also occur from systems allocated adjacent to the DECT band, UTRA/TDD above 1 900 MHz and GSM 1 800 base station transmit band below 1 880 MHz. This Interference will occur during consecutive DECT frames if the interferer has a frame cycle time of 10/N ms, where N is an integer, e.g. it is true for the UTRA TDD which has a 10 ms frame cycle time, but it is not true for GSM1800 which has a frame cycle time of 60/13 ms, whereby a DECT time slot is interfered as seldom as every 6th frame by a single GSM bearer. It is advised that the DECT handover procedure is implemented to also enable a successful handover when the up-link or the down-link is interfered as seldom as every 6th frame. An example of handover criteria for such an implementation (for speech) is:

Indicted errors of a slot: Sync. failure, A-CRC, X-CRC, sliding collision. One or more of these errors in the same slot indicated as a slot error.

Relevant slots: Up-link and Down-link. Up-link slot error is reported to the PP in the following down-link by proper Q-bit setting. The PP gives the same weight to slot error in up- and down-links.

The PP has a "leaking bucket" procedure to trigger handover when the bucket is empty (0). Max content is 32 (overflow limit), empty is 0. Start setting is 16. Correct slot adds one. Error slot subtracts 8.

This example gives 30-40 ms trigger time for interference from DECT or UMTS/TDD and 480-540 ms for interference from a single GSM bearer. If wanted it is possible to add an extra criteria to further decrease the trigger time for interference on consecutive DECT frames (interference from DECT.)

11.5 In-connection quality control

11.5.1 RFPI handshake

A radio endpoint shall release a bearer if it has not received the correct RFPI with a correct CRC on that bearer in the last T201 seconds.

11.5.2 Frequency control

11.5.2.1 RFP measurement of frequency error

Provided the RFP supports frequency control the frequency error of the received physical packets is reported in the PL_RX-cfm primitive. If the frequency error is too large (when averaged over a suitably long time) a frequency control request is sent to the PT (see clauses 7.2.5.5 and 7.3.4).

If the RFP receives a frequency control reject message, it shall not send any more frequency control message to that PT.

11.5.2.2 PT frequency correction

When a frequency control request message is received by the MAC layer in the PT, it sends an appropriate PL_FREQ_ADJ-req primitive to its physical layer.

In response to a PL_FREQ_ADJ-req primitive the Physical layer may issue a PL_FREQ_ADJ-cfm primitive, indicating that frequency control is not supported. A PP's MAC layer receiving this primitive may send a frequency reject message to the requesting RFP.

11.6 Maximum allowed system load at RFPs

In any frame the maximum capacity occupied by traffic bearers at an RFP shall not exceed 14.4 half slots per TDMA frame, multiplied by the number of RF channels available to the DECT system, as regulated by the national authorities.

NOTE: One half slot traffic bearer occupies two half slots; one full slot traffic bearer occupies four half slot; one double slot traffic bearer occupies eight half slots.

11.7 PMID and FMID definitions

11.7.1 FMID definition

The FMID is supplied to the MAC layer by the management entity and is defined in EN 300 175-6 [5].

11.7.2 PMID definition

The PMID is supplied to the MAC layer by the management entity and is defined in EN 300 175-6 [5].

11.8 RFP idle receiver scan sequence

In every slot a receiver in an RFP is either **active**, or **scanning**, or **idling**.

The receiver is **active** if it is receiving a traffic bearer used by that RFP.

Scanning is when the receiver is listening for bearer set up attempts on physical channels. If the receiver is **active** on a particular slot, it will be unable to **listen** in that slot on a different RF carrier (however, an RFP may have more than one receiver).

Idle is a non-preferred state. It implies that the RFP is not scanning for any (more) bearer set up attempts. Receivers are (almost automatically) idle when the RFP transmits.

All RFPs within a DECT internal handover area (see EN 300 175-6 [5]) shall operate on the same set of RF carriers.

The **primary scan** is defined as the scan that is maintained if the RFP has one or more receiver(s) free. If the RFP has more than one receiver free, it maintains **secondary** and **tertiary** scans that lag behind the **primary scan**.

All RFPs within a DECT internal handover area (see EN 300 175-6 [5]) shall have their **primary scans** on the same RF carrier at the same time.

If different systems are synchronized (e.g. via the synchronization port), it is recommended that at any given time, the **primary scans** of these systems are on different RF carriers.

When RFPs scan the physical channels they shall do so in the order described below.

By the **primary scan** all available RF carriers shall be scanned sequentially at a rate of 1 carrier per TDMA frame. RF carriers shall be scanned in order of ascending carrier numbers.

After scanning the highest numbered available RF carrier, the receiver re-starts the **primary scan** in the following TDMA frame on the lowest numbered available carrier.

An RFP shall listen to all slots in which a PP transmission on a new bearer can be accepted.

NOTE: An RFP of an FP that does not support asymmetric connections may be idle during slots 0 to 11. These are the normal RFP transmit slots.

The RFP uses the Q_T messages to broadcast on which RF carrier its primary scan will be in the next frame. These messages also give the number of transceivers at the RFP (thus giving an indication of whether a secondary or tertiary scan exists) and the number of RF carriers that exist.

Secondary receiver scan lags behind the **primary** receiver scan by 6 TDMA frames.

The tertiary receiver scan lags behind the **primary** receiver scan by 3 TDMA frames.

The operation of any additional **idle** receiver(s) is not defined.

Broadcast blind slot information should reflect the primary receiver scan sequence (see clause 7.2.4.3.3).

In order to optimize system performance for multiple transceiver RFPs, the RFPs should maintain active bearers in the following order of preference:

- a) on any available transceiver without an active receiver scan in operation;
- b) on the transceiver with the tertiary receiver scan;
- c) on the transceiver with the secondary receiver scan;
- d) on the transceiver with the primary receiver scan.

An RFP that has an extended frequency allocation and uses one or more of the basic DECT frequencies shall transmit "static_system_information" with a PSCN set equal to one of the basic DECT frequencies at least once every 32 multiframes. Furthermore, the "extended_RF_carriers" message shall contain the number of RF carriers being scanned at that RFP.

11.9 PT receiver scan sequence

For the fast setup procedure, if the PT does not support the LISTEN message, it shall arrange its receiver scanning sequence such that it scans the same sequence of channels as the primary scan (see clause 11.8) at the chosen RFP. For the double simplex bearer setup procedure, if the PT does not support the LISTEN or GOOD message, it shall arrange its receiver scanning sequence such that it scans the same sequence of channels as the primary scan (see clause 11.8) at the chosen RFP.

The PT scan sequence should lead the RFP (primary) scan by one frame, as shown in figure 11.1.

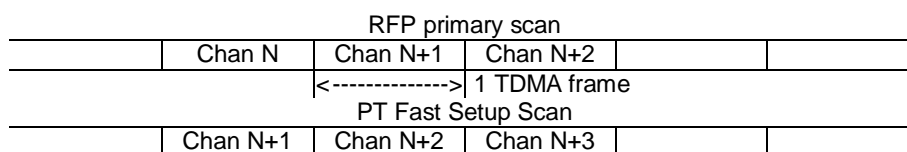

Figure 11.1: PT receiver scan sequence

12 Medium access layer test message procedure

12.1 Introduction

For the purpose of testing, DECT equipment capable of transmitting shall recognize the set of test messages sent by the testing system as defined in the present document. The ability to recognize and implement these messages is contained in the Implementation Under Test (IUT). The response of the IUT to these messages is dependant on the equipment type.

DECT equipment not capable of transmitting shall not be required to recognize these messages.

NOTE: Implementation Under Test (IUT is equivalent to Equipment Under Test (EUT)).

Clause 7.2.5.4 of the present document defines the MAC layer test messages.

DECT equipment that implements only connectionless services shall not be required to implement the test messages. However, the applicant shall declare to the test laboratory how the functions of force transmit, loopback, defeat antenna diversity and clear test modes shall be initiated.

12.2 General

The ability to recognize and implement the test messages is resident in the medium access control layer of the IUT. Execution of these messages are inhibited unless the IUT, in addition to the normal mode operation, is also in the test standby mode. The test standby mode is invoked by some means of manual switching in the IUT (e.g. dip-switch, jumper, or key-pad code as designated by the manufacturer) to prevent accidental execution of these messages in a normal DECT environment.

Receipt of a test message causes the IUT to enter the appropriate test mode(s). The IUT shall stay in the test mode(s) indefinitely or until a "clear test modes" message is received. Receipt of this message shall clear all previously enabled test modes and return the IUT to the test standby mode (see figure 12.1).

State mode diagram for IUTs during testing

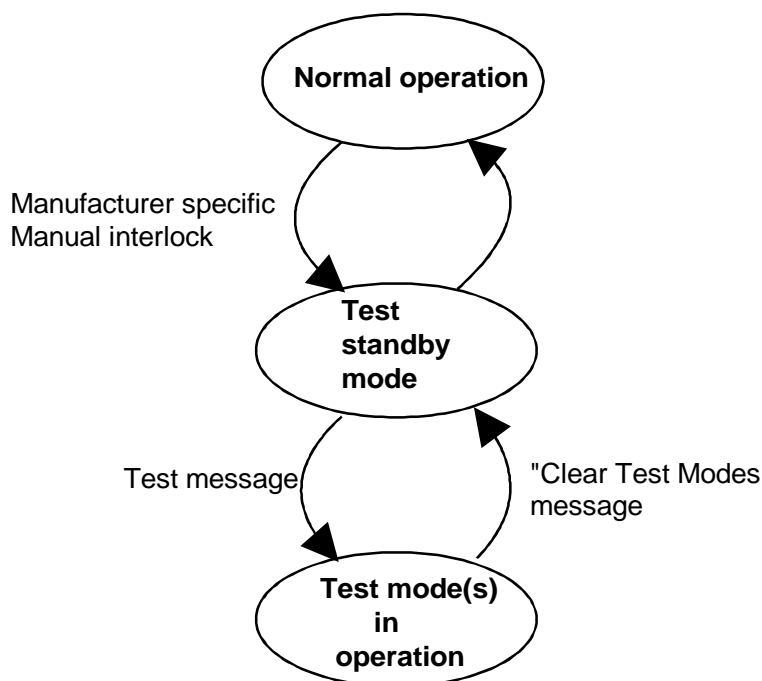

Figure 12.1: State mode diagram for IUTs during testing

After switching to the test standby mode and before the receipt of the test messages the IUT shall have no active bearers other than the dummy bearer if the IUT is an FP. When entering the test standby mode, the modulation of the bearers shall be modulation scheme 1a or 1b, refer to EN 300 175-2 [2]. Test message CHANGE_MODULATION_SCHEME (ref. Clause 12.9) can be used to switch the IUT to another modulation scheme.

The IUT shall be able to be switched out of the test standby mode by the same means of manual switching as described above or by powering down the IUT. The tester should not transmit any test messages before the IUT has entered the test standby mode.

No more than one test message per multiframe shall be sent to the IUT. If, however, the manufacturer declares to the testing authority that the IUT is able to execute test messages at a higher rate, then the test messages shall be allowed to be sent at this higher rate.

Test messages are arranged into two groups. The first group comprises those messages which cause the IUT to enter a static mode of operation. The second group is dynamic. The IUT does not enter a permanent test mode after execution of the test message, i.e. the dynamic test message invokes a temporary test mode. These two groups are listed below:

Static Modes:

- a) FORCE_TRANSMIT;
- b) LOOPBACK_DATA;
- c) DEFEAT_ANTENNA_DIVERSITY;
- d) CHANGE_MODULATION_SCHEME.

Dynamic Modes:

- a) CLEAR_TEST_MODES.

All of the static test modes shall be able to be in operation at the same time.

The ESCAPE test message is neither static nor dynamic; it serves to notify the IUT of the presence of a proprietary test message in the subsequent data bits.

For a detailed description of the test procedures utilizing the test messages, refer to EN 300 176 [8].

12.2.1 Portable part testing

Once in the test standby mode, the IUT shall receive in at least all frames in the first half of a multiframe and all slots declared as being supported. The EUT shall execute the test message within 16 frames of the reception of the test message.

The PP shall be able to receive and process the test messages described in clause 7.2.5.4. The PP shall be able to receive M_T tails sent on a dummy bearer in any frame allowed by the T-MUX algorithm if no bearers currently exist.

The test message shall be sent by the LT in an M_T tail using a dummy bearer if no bearers currently exist otherwise they shall be sent on an existing bearer.

12.2.2 Fixed part testing

The FP shall be able to receive and process the test messages described in clause 7.2.5.4 on a bearer that has been initiated by the LT.

Entry into the test standby mode is from the Active_Idle or C/L state. The EUT shall execute the test message within 16 frames of the reception of the test message.

If there is no interference, a dummy bearer shall not change physical channels in test mode.

12.2.3 Applicability of test messages

For the purposes of testing, DECT equipment is divided into two equipment category types: CI-BASE equipment and CI-PROFILE equipment (see clauses 8 and 9 of EN 300 175-1 [1]). CI-BASE equipment are those implementations which do not adhere to an ETSI approved operating profile. CI-PROFILE equipment are those implementations which comply with an ETSI approved operating profile (e.g. General Access Profile (GAP)). Table 12.1 below details the test messages that are required to be supported by the IUT for each equipment category type.

Table 12.1: DECT equipment categories and test messages

Test message	CI-BASE	CI-PROFILE	CI-PROFILE-PLUS
FORCE_TRANSMIT	Understand	Understand	Understand
LOOPBACK_DATA	Understand (note 4)	Understand (note 4)	Understand (note 4)
DEFEAT_ANTENNA_DIVERSITY	Understand (note 2)	Understand (note 2)	Understand (note 2)
NETWORK_TEST	Ignore	Ignore	Ignore
ESCAPE	Ignore	Ignore	Ignore
CHANGE_MODULATION_SCHEME	Understand (note 5)	Understand (note 5)	Understand (note 5)
CLEAR_TEST_MODES	Understand	Understand	Understand

NOTE 1: All DECT equipment, upon receipt of a test message, shall not malfunction regardless of the applicability of the message.

NOTE 2: If equipment is declared as having antenna diversity or possessing more than one switchable antenna.

NOTE 3: Equipment that is capable of operating in more than one of the above modes shall be tested in each mode separately.

NOTE 4: For fixed parts, loopback is described in clause 12.4.2.

NOTE 5: If equipment is declared as capable of higher level modulation.

12.3 FORCE_TRANSMIT

12.3.1 Portable part

On receipt of this message, all DECT equipment capable of transmitting shall setup a bearer on the slot number, start position, and frequency specified in this message and shall listen for other messages received on this established bearer and act upon them as appropriate.

NOTE 1: This test message is sent from the LT to the IUT prior to all other test messages. This enables the other test messages to be sent on this established bearer.

NOTE 2: Where the IUTs transmitted data requires control by the LT, this message is followed by the LOOPBACK_DATA test message.

The IUT remains in this mode until the CLEAR_TEST_MODES message is received. Receipt of other test messages shall not terminate this mode.

Combinations of slot pairs that are declared by the manufacturer as not being supported in the IUT for this test shall not be selected by the testing system.

If there exists a bearer at the time the IUT receives the FORCE_TRANSMIT message, the IUT shall first examine the status of the "keep previous" bit to determine whether to release the current bearer. If the "keep previous" bit is set to "1", the IUT shall not release the old bearer. The IUT shall execute the appropriate setup procedure at the new slot and frequency indicated in the FORCE_TRANSMIT message. If the "keep previous" bit is set to "0", the IUT shall first release any existing bearers before performing the call setup.

The maximum number of bearers active at any time shall not exceed the declared limit of the IUT.

NOTE 3: A manufacturer could include a multi-bearer force transmit test message as part of a proprietary test message set.

If the "handover disable" bit is set to "1" then bearer and connection handover shall be disabled (see clause 7.2.5.4.2).

12.3.2 Fixed part

The IUT shall allow bearer setup using any PMID while in the test standby mode. In addition, the IUT shall proceed with the bearer setup request on the slot pair on which the bearer setup request was received.

NOTE 1: The LT will initiate bearers with the IUT using the normal bearer setup procedures described in clause 10.2, and in this way controls the transmissions of the IUT.

NOTE 2: The FORCE_TRANSMIT test message is not used when the IUT is a FP.

The IUT shall listen for other messages received on this established bearer.

The IUT remains in this mode until the CLEAR_TEST_MODES message is received. Receipt of other test messages shall not terminate this mode.

DECT equipment utilizing only the connectionless services shall not limit the number of successive transmissions.

12.4 LOOPBACK_DATA

Loopback is that process by which data received in one slot is used to compose the data to be transmitted in the next half-frame. The sequence of the bits and their values as transmitted by the IUT is identical with the sequence of the bits and their values as received by the IUT.

For DECT equipment capable of setting up a bearer, the IUT shall have a bearer existing before this message can be executed by the IUT. If no bearer exists when the test message is transmitted by the tester, the IUT shall ignore this message.

DECT equipment utilizing only A-field transmissions shall loopback bits a_{16} to a_{47} of the A-field. The IUT shall not limit the number of successive transmissions.

DECT equipment capable of B-field transmission shall loopback bits b_0 to b_{79} for half-slot implementations or bits b_0 to b_{319} for full-slot implementations. Equipment supporting both half- and full-slot operation shall loopback bits b_0 to b_{319} . The A-field loopback shall not be used.

DECT equipment capable of transmitting double-slots shall loopback bits b_0 to b_{799} . Equipment supporting half-slots and/or full-slots in addition to the double-slot shall loopback bits b_0 to b_{799} . The A-field loopback shall not be used.

12.4.1 Portable part

The point at which loopback occurs in the MAC of the IUT can be above or below the scrambling functions of the IUT.

If a FORCE_BEARER_HANOVER message is received after receipt of the LOOPBACK_DATA message, the IUT shall continue to operate in the loopback mode after execution of the bearer handover procedure. The IUT may transmit the loopback data on both bearers during execution of its bearer handover procedure. The IUT shall continue to operate in the loopback mode until receipt of the CLEAR_TEST_MODES or power down of the unit.

12.4.2 Fixed Part

12.4.2.1 IUTs implementing the DECT scrambler

The point of loopback in the MAC of the IUT may occur above and below any scrambling functions of the IUT.

12.4.2.2 IUTs implementing a proprietary scrambler

The point of loopback in the MAC of the IUT shall occur below any scrambling functions of the IUT.

NOTE: "Below" means without passing through the scrambling functions of the IUT.

12.5 DEFEAT_ANTENNA_DIVERSITY

All equipment equipped with antenna diversity shall respond to this message. The antenna selected by this message shall be used for both receive and transmit. The IUT stays on the selected antenna until a new antenna is selected or the "clear test modes" message is received.

12.6 NETWORK_TEST

This message is used to invoke testing procedures resident in the network layer. The 32 bit SDU is passed through the ME SAP to the LLME. No further action is required. All implementations shall recognize the network test message, however, IUTs not implementing this method to invoke testing procedures shall ignore the network test message.

12.7 ESCAPE

Proprietary test messages resident in an IUT shall be declared by the manufacturer to the testing authority before testing may begin. Any transmission of a proprietary test message shall be preceded by the ESCAPE message in the same transmission. Proprietary test message(s) shall occupy bit positions a_{16} to a_{47} of the A-field. All implementations shall recognize the ESCAPE test message, however, EUTs not implementing proprietary test message(s) shall ignore the ESCAPE message.

12.8 CLEAR_TEST_MODES

The CLEAR_TEST_MODES message is used as a "reset" function. Its purpose is to force the IUT back to the test standby mode. Receipt of this message shall clear all previously enabled static test modes (including static proprietary modes) within 16 frames and return the IUT to the test standby mode.

12.9 CHANGE_MODULATION_SCHEME

On receipt of the CHANGE_MODULATION_SCHEME message the IUT shall switch to the requested modulation scheme if this requested modulation scheme is supported by the IUT. The message can be received by the IUT in test-standby-mode after setup of a bearer using 2 level modulation in the A-Field.

Annex A (normative): MAC layer timers and constants

A.1 Timers and Time Windows

T200 = 3 seconds:	connection setup timer.
T201 = 5 seconds:	max. time-out for bearer failure.
T202 = 3 seconds:	handover timer/window.
T203 = 16 frames:	max. time to maintain 2 bearers during handover.
T204 = 6 multiframe:	time-out for sending page messages.
T205 = 10 seconds:	max. time between N_T tails in frame 0 of a multiframe.
T206 = 10 frames:	max. respond time for extended system information.
T207 = 5 seconds:	max. time between reception of a correct A-field in idle mode.
T208 = 20 seconds:	max. time between reception of a N_T message in idle mode.
T209 = 30 seconds:	max. time between update of channel list.
T210 = 2 seconds:	time window for max. N_{202} channel selections.
T211 = 3 seconds:	connection modification timer.
T212 = 20 frames:	time to acknowledge a double simplex bearer setup.
T213 = 20 frames:	time to acknowledge a double simplex bearer release.
T214 = 20 frames:	C/L uplink service: maximum time to search for a dummy or connectionless bearer.
T215 = 6 multiframe:	interval for max. N_{203} C/L uplink transmissions.
T216 = 8 multiframe:	max. time for a PP to resynchronize in idle locked state.
T217 = 300ms:	MAC C-plane switching timer.
T218 = 3 seconds:	32 kbit/s to 64 kbit/s switching timer.

A.2 Constants

$N_{200} = 10$:	max. number of MAC setup reattempts during connection setup.
$N_{201} = 15$:	max. number of handover reattempts in T202 sec.
$N_{202} = 10$:	max. number of channel selections in T210 seconds.
$N_{203} = 6$:	max number of C/L uplink transmissions in any interval of T215 multiframe.
$N_{204} = 5$:	max number of MAC C-plane switching attempts.
$N_{205} = 6$:	max number of MAC U-plane switching attempts.
$N_{206} = 12$:	max. number of frequency replacement requests.
$N_{207} = 4$:	max. number of frequency replacement confirms or grants.

Annex B (informative): Construction of the CRC polynomial and error detecting performance

The factorization of the polynomial $g(x)$ results in:

- $g(x) = M_7(13)(x) * M_7(29)(x) * (x + 1)^2$;
- $202'611 = 203 * 253 * (3)_2$ (octal).

$M_7^{(i)}(x)$ denotes the minimal polynomial of α^i where α is the primitive element of $G_F(2^7)$ used in Appendix C of Peterson and Weldon "Error correcting codes" (see Bibliography).

The product of $M_7^{(13)}(x) * M_7^{(29)}(x)$ results in a generator polynomial for a primitive binary (127,113) BCH code with minimum Hamming distance of 5. Multiplying this polynomial with $(x + 1)^2$ gives the generator polynomial $g(x)$. For different data block lengths n the minimum Hamming distance d_{\min} for the (m, n) block code generated with $g(x)$ is given in table B.1.

Table B.1

dmin	m = n + 16
6	17 - 128
4	129 - 254
2	≥ 255

The polynomial $g(x)$ has the minimum number of non zero coefficients for codes with $d_{\min} = 6$.

For $17 \leq m \leq 128$ the resulting (m, n) block code provides the following error detection properties:

- detect all odd number of errors;
- any error pattern with less than 6 errors; and
- any error-burst up to length 16.

Because a BCH code is included, up to double error correcting may be applied.

Annex C (informative): MAC relationship to other layers

A complete DECT fixed radio termination may contain several independent cells, where each cell contains one independent physical layer instance (independent radio transceivers).

The MAC layer provides an intermediate level of grouping between these distributed physical layers and the single (central) instance of the higher layers. This intermediate grouping is termed a (MAC) cluster, where one cluster represents a single MAC layer instance. A complete FT may thereby contain two levels of hierarchy:

- one FT may contain multiple independent MAC clusters (MAC layer instances);
- each cluster may control multiple independent PHL cells (physical layer instances).

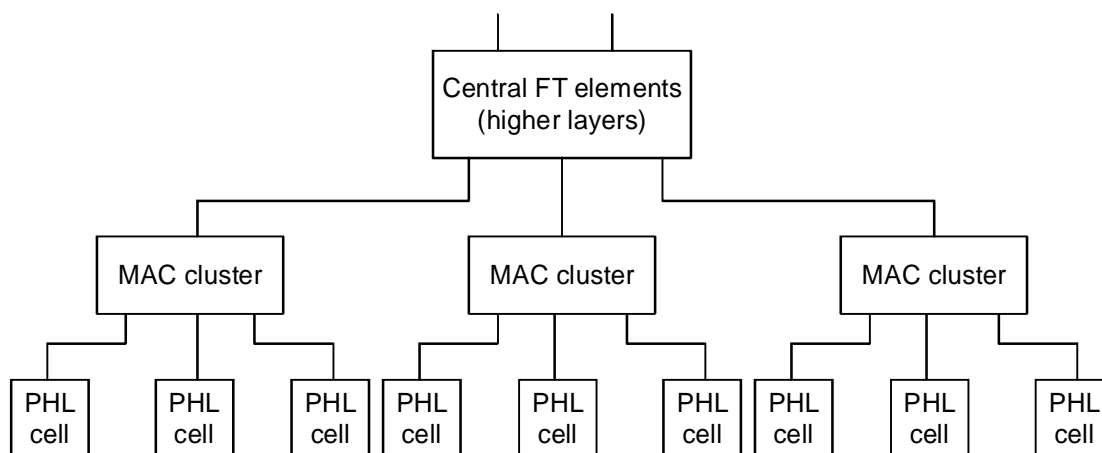

NOTE: This divisions in this picture do not correspond to physical boundaries.

Figure C.1: FT with multiple MAC clusters

The independent lower instances of MAC and PHL are all accessed via independent sets of service access points. The MAC functional groupings correspond to these independent SAPs.

The single instance of MAC cluster control functions relate to the single set of upper SAPs.

The multiple instances of MAC cell site functions relate to the multiple instances of lower SAPs. (There is one CSF for each PHL cell belonging to the cluster).

Annex D (informative): Synchronization

The MAC layer, in combination with the physical layer provides synchronization between fixed radio termination and portable radio terminations. In all cases, the FT is the timing master, and a PT is always required to synchronize to an FT before it can obtain service.

Three types of synchronization are defined:

- slot synchronization; refer to EN 300 175-2 [2];
- frame synchronization; refer to EN 300 175-2 [2];
- multiframe synchronization; refer to clause 4.2.3.

Synchronization of a PT is achieved and maintained by the reception of physical packets by the physical layer for any active slots. This provides the first level of timing. A small number of messages are then used in the Q logical channel to define frame synchronization and multiframe synchronization relative to this slot timing. This process is defined in clause 6.2.2.1.

The FT transmissions are required to be frame and multi-frame synchronized at all RFPs in any one cluster. It is required that this synchronization is maintained across a complete fixed radio termination.

At the PT, successful synchronization is required for the PT to "lock" to the transmissions of an FT. A PT can exist in one of three synchronization states at the MAC layer:

- 1) **Unlocked:** the PT is not synchronized to any RFP;
- 2) **Lock_pending:** the PT is receiving RFP transmissions, but has not yet obtained frame and/or multiframe synchronization;
- 3) **Locked:** the PT has achieved frame and multi-frame lock to an RFP.

Annex E (informative): Scrambling patterns

Table E.1 lists the first 16 bits and the last 2 bits (for both full and half slots) of the scrambling bit sequence that shall be used each frame.

The sequence repeats every 8 frames, so the sequence is the same for frames 0 and 8, and for frames 1 and 9, etc.

Table E.1

BIT NUMBER	FRAME NUMBERS							
	0 8	1 9	2 10	3 11	4 12	5 13	6 14	7 15
b ₀	0	0	0	0	0	0	0	0
b ₁	0	0	0	0	0	0	0	1
b ₂	1	1	1	1	0	0	0	1
b ₃	1	1	0	0	1	1	0	1
b ₄	1	0	1	0	1	0	1	1
b ₅	0	0	1	1	0	0	1	0
b ₆	1	1	0	1	0	1	0	0
b ₇	1	0	1	1	1	1	0	1
b ₈	1	1	1	0	0	1	1	1
b ₉	1	1	1	1	1	0	0	0
b ₁₀	0	0	1	1	1	1	1	1
b ₁₁	0	1	0	1	0	1	1	0
b ₁₂	1	1	1	1	1	1	0	0
b ₁₃	1	1	0	0	1	1	1	1
b ₁₄	0	1	1	0	1	0	1	0
b ₁₅	1	0	0	1	1	0	1	0
etc.								
b ₇₈	0	1	0	1	0	1	1	0
b ₇₉	0	0	0	0	1	1	0	0
etc.								
b ₃₁₇	1	0	1	1	1	1	0	1
b ₃₁₈	1	1	1	0	0	1	1	1
b ₃₁₉	1	1	1	1	1	0	0	0

Annex F (informative): Seamless handover operation

F.1 I-Channel data flow for I_N _minimum_delay service

When two bearers are maintained during bearer handover in a I_N _minimum_delay_service the data transmitted in one frame is not the same for the two bearers using physical channels in different time slots. For transmission, the voice service description in the DLC (see EN 300 175-4 [3]) (LU1) implies that the response on a MAC_CO_DTR-ind primitive is a MAC_CO_DATA-req primitive containing the **latest** octets. Therefore the data depends on the time instant when the MAC_CO_DTR-ind primitive was sent. To achieve minimum delay the occurrence of this primitive should depend on the slot number used by a particular physical channel. This implies that during a bearer handover two MAC_CO_DTR-ind primitives are sent in one frame and two MAC_CO_DATA-req primitives are received by the MBC containing different data for the old and the new bearer. For a handover in which no I_N bits are to be lost or added due to the handover, synchronization between MAC and DLC is necessary. It is recommended to synchronize the MAC and DLC such that the relative offset in data octets for delivering I_N -segments to bearers in different slot positions is given in tables F.1 and F.2.

Table F.1: Double slot operation

slots	octet	slots	octet	slots	octet
(0,12)	x + 0	(4,16)	x + 16	(8,20)	x + 32
(2,14)	x + 8	(6,18)	x + 24	(10,22)	x + 40
NOTE: The slot numbers correspond to the slots where transmission on a double slot bearer starts.					

Table F.2: Full slot operation

slots	octet	slots	octet	slots	octet
(0,12)	x + 0	(4,16)	x + 6	(8,20)	x + 13
(1,13)	x + 1	(5,17)	x + 8	(9,21)	x + 15
(2,14)	x + 3	(6,18)	x + 10	(10,22)	x + 16
(3,15)	x + 5	(7,19)	x + 11	(11,23)	x + 18
NOTE: For half slot operation: no recommendation.					

Annex G (normative): Requirements for PPs with direct PP to PP communication mode

G.1 Description of operation in direct PP to PP communication mode

Direct PP to PP communication is a notation for a PP (or CTA) feature that provides ad hoc networking with specific temporary system ad hoc identities. A PP temporarily switches into FT mode to provide direct access to any of the other PPs of the ad hoc network. There is no requirement or need to being locked to an RFP. Since no RFP is involved in the communication link, direct PP to PP communication only uses half the spectrum compared to normal calls routed via RFPs.

Most PPs will be able to operate also in the normal non-direct communication mode. In this case the direct mode will be temporary, and all PPs in a group of PPs intended to communicate in direct communication mode have to be switched into this mode (manually or by other means), since a PP in non-direct mode can only receive paging information from the system to which it is locked.

The access rights class E and related PARK E are reserved for direct communication only, see EN 300 175-6 [5], clauses 5.5, 6.1.5 and 6.3.2. The Access Rights Identity (ARI) class E requires an entry via keypad or by other means of only 5 decimal digits to provide all identity and subscription data required to form a group of PPs for direct communication. The subscriber numbers consist of 2 decimal digits. The use of class E identities is normally of temporary nature and does not contain an ETSI distributed code.

When there is no communication all PPs are active unlocked, no (dummy) bearer transmission exists, and all PPs are regularly scanning all allocated access channels for a (dummy) bearer transmission with proper Radio Fixed Part Identity (RFPI).

When a PP wants to initiate a connection, it acts like an RFP, selects a least interfered channel within the allocated carriers and starts transmitting a simplex (dummy) bearer with the relevant page message and Q_T information. The paged PP shall enter idle locked mode, and shall respond with a bearer setup.

A PP entering RFP mode is allowed to derive over the air slot synchronization from a "non ARI E" DECT system, e.g. a large office system.

The requirements below allow for two slightly different procedures:

Alternative 1: where the additions for the RFP mode are minimized, and

Alternative 2: where the changes in the PP mode are minimized compared to GAP.

For interoperability the PPs have to conform to a specific interoperability profile (e.g. a PP to PP option in GAP or DPRS).

G.2 Requirements

PPs or CTAs in direct communication mode shall meet the PP requirements for normal non-direct communication with the amendments defined below.

G.2.1 Setting the PP in direct communications mode

Entering and leaving the direct communications mode shall be made by manual keypad entries or by other means. The PP shall be set in direct communications mode provided with proper identities. It is proper to use of class E identities which do not require an ETSI distributed code. The requirements for class E identities are found in EN 300 175-6 [5], clauses 5.5, 6.1.5 and 6.3.2.

When not processing a call, the PP shall be in active unlocked PP state.

G.2.2 Specific Alternative 1 requirements

G.2.2.1 When the PP has not initiated a call

When the PP has not initiated a call, it shall operate as a "non-direct mode" PP starting from the active unlocked PP state, but with the following amendments:

- a) the PP shall in the active unlocked PP state scan all channels on relevant carriers at least every 10 seconds.
- b) the PP is only allowed to stay in idle locked state if it is being paged by an initiating PP; (It must unlock to detect page messages from other PP.)
- c) if ARI class E is used, the paged PP shall make the bearer setup attempt on the channel pair where the initiating PP transmits.

G.2.2.2 When the PP initiates a call

By initiating a call means that the number of the wanted subscriber is entered via the keypad or by other means, and that the PP at "off-hook command" shall enter the RFP active idle state, see clause 4.3.

When the PP initiates a call, it shall operate as a "non-direct mode" RFP starting from the active idle RFP state, with the following amendments:

- a) the 25 ppm PP timer stability requirements apply. See EN 300 175-2 [2] clause 4.2.2;
- b) A PP entering RFP mode is allowed to derive over the air frame and slot synchronization from a DECT system having "non-class E" identities;
- c) the PP shall use FP or PP simplex bearer channel selection rules for the RFP active idle state. See clause 11.4;
- d) the page message shall be transmitted in every multiframe as long as in active idle state;
- e) the short page format shall be used for ARI class E;
- f) the PP shall revert from active idle RFP state to PP active unlocked state, if a duplex bearer has not been established within 20 seconds;
- g) the PP is not required to do receiver scanning for ARI class E in RFP active idle nor active state. See clause 11.8 and EN 300 175-6 [5], clause 5.5;
- h) If identities class E are used, the N_T message will not contain an ETSI distributed code. See EN 300 176-1 [8].

G.2.3 Specific Alternative 2 Requirements

The PP shall meet the requirements of clause G.2.2 except for items b) and c) in clause G.2.2.1 and item g) in G.2.2.2.

In addition:

- a) the initiating PP is not required to do receiver scanning for ARI class E (clause 11.8 and EN 300 175-6 [5], clause 5.5) in RFP active idle nor active state, if it transmits a blind slot information indicating that all slots except the dummy bearer timeslot are blind and if it has set bit a20 in the Q3 message to "1".

Annex H (informative): Bibliography

ETSI EN 300 444: "Digital Enhanced Cordless Telecommunications (DECT); Generic Access Profile (GAP)".

ETSI ETR 042: "Digital Enhanced Cordless Telecommunications (DECT); A Guide to DECT features that influence the traffic capacity and the maintenance of high radio link transmission quality, including the results of simulations".

CEPT Recommendation T/SGT SF2 (89) 6/0: "Draft Recommendation T/SF Services and Facilities of Digital European Cordless Telecommunications".

W.W. Peterson and E.J. Weldon (1972, 2nd edition): "Error Correcting Codes" (MIT Press, Cambridge, MA).

ETSI EN 301 649: "Digital Enhanced Cordless Telecommunications (DECT); DECT Packet Radio Service (DPRS)".

History

Document history		
Edition 1	October 1992	Publication as ETS 300 175-3
Edition 2	September 1996	Publication as ETS 300 175-3
V1.4.2	June 1999	Publication
V1.5.0	October 2000	One-step Approval Procedure OAP 20010216: 2000-10-18 to 2001-02-16
V1.5.1	February 2001	Publication