

Final draft **EN 300 175-2** V1.4.2 (1999-03)

European Standard (Telecommunications series)

**Digital Enhanced Cordless Telecommunications (DECT);
Common Interface (CI);
Part 2: Physical Layer (PHL)**



Reference

REN/DECT-000129-2 (1mci0jdc.PDF)

Keywords

DECT, radio

ETSI

Postal address

F-06921 Sophia Antipolis Cedex - FRANCE

Office address

650 Route des Lucioles - Sophia Antipolis
Valbonne - FRANCE
Tel.: +33 4 92 94 42 00 Fax: +33 4 93 65 47 16
Siret N° 348 623 562 00017 - NAF 742 C
Association à but non lucratif enregistrée à la
Sous-Préfecture de Grasse (06) N° 7803/88

Internet

secretariat@etsi.fr
Individual copies of this ETSI deliverable
can be downloaded from
<http://www.etsi.org>
If you find errors in the present document, send your
comment to: editor@etsi.fr

Copyright Notification

No part may be reproduced except as authorized by written permission.
The copyright and the foregoing restriction extend to reproduction in all media.

© European Telecommunications Standards Institute 1999.
All rights reserved.

Contents

Intellectual Property Rights.....	6
Foreword	6
1 Scope.....	7
2 References.....	7
3 Definitions and abbreviations	8
3.1 Definitions	8
3.2 Abbreviations.....	9
4 PHL services	10
4.1 RF channels (access in frequency).....	10
4.1.1 Nominal position of RF carriers	10
4.1.2 Accuracy and stability of RF carriers	11
4.2 Time Division Multiple Access (TDMA) structure (access in time).....	11
4.2.1 Frame, full-slot, double-slot, and half-slot structure.....	11
4.2.2 Reference timer accuracy and stability	12
4.2.3 RFP transmission jitter	12
4.2.4 PP reference timer synchronization.....	13
4.2.5 System synchronization	13
4.2.6 Inter-system synchronization.....	13
4.2.7 Reference timer adjustment for synchronization	13
4.3 Cells (access in space)	14
4.4 Physical packets.....	14
4.4.1 The short physical packet P00.....	14
4.4.2 The basic physical packet P32	14
4.4.3 The low capacity physical packet P08j	15
4.4.4 The high capacity physical packet P80.....	15
4.5 Physical channels.....	16
4.5.1 Ra (K, L, M, N) notation.....	16
4.5.2 The short physical channel R00(K,L,M,N)	17
4.5.3 The basic physical channel R32(K,L,M,N).....	17
4.5.4 The low-rate physical channel R08j(K,L,M,N).....	18
4.5.5 The high capacity physical channel R80(K,L,M,N).....	18
4.6 Synchronization field S.....	19
4.7 D-field.....	19
4.7.1 Physical packet P00.....	19
4.7.2 Physical packet P32.....	20
4.7.3 Physical packet P08j	20
4.7.4 Physical packet P80.....	20
4.8 Z-field	20
4.9 Bit pattern during ramping.....	21
5 Transmission of physical packets	21
5.1 Definitions	21
5.1.1 End of the physical packet.....	21
5.1.2 Transmitted power.....	21
5.1.3 Normal Transmitted Power (NTP)	21
5.2 Transmission burst.....	21
5.2.1 Transmitter attack time.....	22
5.2.2 Transmitter release time	22
5.2.3 Minimum power	22
5.2.4 Maximum power	22
5.2.5 Maintenance of transmission after packet end.....	22
5.2.6 Transmitter idle power output	22
5.3 Transmitted power	23
5.3.1 Peak power per transceiver	23

5.3.1.1	PP and RFP with an integral antenna.....	23
5.3.1.2	PP and RFP with external connections for all antennas.....	23
5.3.2	Maximum EIRP and number of transceivers.....	23
5.4	RF carrier modulation.....	23
5.4.1	Modulation method.....	23
5.4.2	Definition of "1" and "0".....	23
5.4.3	Deviation limits.....	23
5.5	Unwanted RF power radiation.....	24
5.5.1	Emissions due to modulation.....	24
5.5.2	Emissions due to transmitter transients.....	24
5.5.3	Emissions due to intermodulation.....	25
5.5.4	Spurious emissions when allocated a transmit channel.....	25
6	Reception of physical packets.....	26
6.1	Definitions and conditions for clause 6.....	26
6.1.1	Power levels and field strength.....	26
6.1.2	Test conditions.....	26
6.1.3	Reference DECT radio end point.....	26
6.2	Radio receiver sensitivity.....	26
6.3	Radio receiver reference bit error rate and frame error ratio.....	27
6.4	Radio receiver interference performance.....	27
6.5	Radio receiver blocking.....	27
6.5.1	Owing to signals occurring at the same time but on other frequencies.....	27
6.5.2	Owing to signals occurring at a different time.....	28
6.6	Receiver intermodulation performance.....	28
6.7	Spurious emissions when not allocated a transmit channel.....	28
6.7.1	Out of band.....	28
6.7.2	In the DECT band.....	28
7	Primitives between physical layer and other entities.....	28
7.1	Medium access control layer (D-SAP).....	29
7.1.1	PL_TX {req}.....	29
7.1.2	PL_RX {req,cfm}.....	29
7.1.3	PL_FREQ_ADJ {req,}.....	30
7.2	Management entity (PM-SAP).....	30
7.2.1	PL_ME_SYNC {req,cfm}.....	30
7.2.2	PL_ME_SIG_STR {req,cfm}.....	30
7.2.3	PL_ME_TIME_ADJ {req,cfm}.....	31
8	PHL procedures.....	31
8.1	Addition of synchronization field and transmission.....	31
8.2	Packet reception and removal of synchronization field.....	31
8.3	Measurement of signal strength.....	32
8.4	Synchronization pulse detection.....	32
8.5	Timing adjustment.....	32
8.6	Frequency adjustment.....	32
9	Management entity procedures related to PHL.....	32
9.1	List of quietest physical channels.....	32
9.2	Physical channels with greatest field strength (PP only).....	32
9.3	Extract timing.....	33
Annex A (normative):	RF safety requirements.....	34
A.1	Recommendation.....	34
A.2	Safety distances.....	34
Annex B (normative):	Synchronization port.....	35
B.1	General requirements.....	35
B.2	Wired synchronization ports.....	35
B.2.1	Synchronization signal.....	36

B.3	GPS synchronization.....	37
B.3.1	Synchronization signal.....	38
B.3.2	DECT timings derivation from the GPS time.....	38
B.3.2.1	DECT multiframe number synchronization using GPS.....	39
B.3.2.2	DECT PSCN synchronization using GPS.....	39
B.4	Guidance for installation.....	40
B.4.1	Interconnection cable.....	40
B.4.2	Propagation delay of synchronization signals.....	40
B.4.2.1	Calculation of Propagation delay (informative).....	40
B.4.2.2	Delay compensation.....	41
B.4.3	GPS receiver stability.....	41
Annex C (normative):	Prolonged preamble	42
C.1	Bit pattern.....	42
C.2	The power-time template	42
Annex D (normative):	4-level/8-level modulation option	43
D.1	The $\pi/2$ -DBPSK modulation scheme.....	44
D.1.1	RF carrier modulation.....	44
D.1.1.1	Modulation accuracy.....	44
D.1.2	Transmission of physical packets.....	44
D.2	The $\pi/4$ -DQPSK modulation scheme.....	44
D.2.1	RF carrier modulation.....	44
D.2.1.1	Modulation accuracy.....	45
D.2.2	Transmission of physical packets.....	45
D.3	The $\pi/8$ -D8PSK modulation scheme.....	45
D.3.1	RF carrier modulation.....	45
D.3.1.1	Modulation accuracy.....	46
D.3.2	Transmission of physical packets.....	46
	Bibliography.....	47
	History.....	48

Intellectual Property Rights

IPRs essential or potentially essential to the present document may have been declared to ETSI. The information pertaining to these essential IPRs, if any, is publicly available for **ETSI members and non-members**, and can be found in SR 000 314: "*Intellectual Property Rights (IPRs); Essential, or potentially Essential, IPRs notified to ETSI in respect of ETSI standards*", which is available **free of charge** from the ETSI Secretariat. Latest updates are available on the ETSI Web server (<http://www.etsi.org/ipr>).

Pursuant to the ETSI IPR Policy, no investigation, including IPR searches, has been carried out by ETSI. No guarantee can be given as to the existence of other IPRs not referenced in SR 000 314 (or the updates on the ETSI Web server) which are, or may be, or may become, essential to the present document.

Foreword

This European Standard (Telecommunications series) has been produced by ETSI Project Digital Enhanced Cordless Telecommunications (DECT) and is now submitted for Voting phase of the ETSI standards Two-step Approval Procedure.

The present document is part 2 of a multi-part EN covering the Common Interface (CI) for the Digital Enhanced Cordless Telecommunications (DECT), as identified below:

- Part 1: "Overview";
- Part 2: "Physical Layer (PHL)";**
- Part 3: "Medium Access Control (MAC) layer";
- Part 4: "Data Link Control (DLC) layer";
- Part 5: "Network (NWK) layer";
- Part 6: "Identities and addressing";
- Part 7: "Security features";
- Part 8: "Speech coding and transmission".

Further details of the DECT system may be found in ETR 015 [10], ETR 043 [12] and ETR 056 [13].

Proposed national transposition dates	
Date of latest announcement of this EN (doa):	3 months after ETSI publication
Date of latest publication of new National Standard or endorsement of this EN (dop/e):	6 months after doa
Date of withdrawal of any conflicting National Standard (dow):	6 months after doa

1 Scope

The present document gives an introduction and overview of the complete Digital Enhanced Cordless Telecommunications (DECT) Common Interface (CI).

The present document of the DECT CI specifies the physical channel arrangements. DECT physical channels are radio communication paths between two radio end points. A radio end point is either part of the fixed infrastructure or a Portable Part (PP), typically a handset. The assignment of one or more particular physical channels to a call is the task of higher layers.

The Physical Layer (PHL) interfaces with the Medium Access Control (MAC) layer, and with the Lower Layer Management Entity (LLME). On the other side of the PHL is the radio transmission medium which has to be shared extensively with other DECT users and a wide variety of other radio services. The tasks of the PHL can be grouped into five categories:

- a) to modulate and demodulate radio carriers with a bit stream of a defined rate to create a radio frequency channel;
- b) to acquire and maintain bit and slot synchronization between transmitters and receivers;
- c) to transmit or receive a defined number of bits at a requested time and on a particular frequency;
- d) to add and remove the synchronization field and the Z-field used for rear end collision detection;
- e) to observe the radio environment to report signal strengths.

2 References

The following documents contain provisions which, through reference in this text, constitute provisions of the present document.

- References are either specific (identified by date of publication, edition number, version number, etc.) or non-specific.
- For a specific reference, subsequent revisions do not apply.
- For a non-specific reference, the latest version applies.
- A non-specific reference to an ETS shall also be taken to refer to later versions published as an EN with the same number.

- [1] EN 300 175-1: "Digital Enhanced Cordless Telecommunications (DECT); Common Interface (CI); Part 1: Overview".
- [2] EN 300 175-3: "Digital Enhanced Cordless Telecommunications (DECT); Common Interface (CI); Part 3: Medium Access Control (MAC) layer".
- [3] EN 300 175-4: "Digital Enhanced Cordless Telecommunications (DECT); Common Interface (CI); Part 4: Data Link Control (DLC) layer".
- [4] EN 300 175-5: "Digital Enhanced Cordless Telecommunications (DECT); Common Interface (CI); Part 5: Network (NWK) layer".
- [5] EN 300 175-6: "Digital Enhanced Cordless Telecommunications (DECT); Common Interface (CI); Part 6: Identities and addressing".
- [6] Void.
- [7] Void.
- [8] EN 300 444: "Digital Enhanced Cordless Telecommunications (DECT); Generic Access Profile (GAP)".

- [9] EN 300 176: "Digital Enhanced Cordless Telecommunications (DECT); Approval test specification; (Part 1: Radio; Part 2: Speech)".
- [10] ETR 015: "Digital Enhanced Cordless Telecommunications (DECT); Reference document".
- [11] Void.
- [12] ETR 043: "Digital Enhanced Cordless Telecommunications (DECT); Common Interface (CI); Services and facilities requirements specification".
- [13] ETR 056: "Digital Enhanced Cordless Telecommunications (DECT); System description document".
- [14] Void.
- [15] ENV 50166-2: "Human exposure to electromagnetic fields, 10 kHz to 300 GHz".
- [16] International Non-Ionizing Radiation Committee of the International Radiation Protection Association (IRPA) (1988): "Guidelines on limits of exposure to radio frequency electromagnetic fields in the frequency range from 100 kHz to 300 GHz".
- [17] EIA-RS422-A-78: "Electrical characteristics of balanced voltage digital interface circuits".

3 Definitions and abbreviations

3.1 Definitions

For the purposes of the present document the following terms and definitions apply:

antenna diversity: see EN 300 175-1 [1].

cell: see EN 300 175-1 [1].

Central Control Fixed Part (CCFP): see EN 300 175-1 [1].

channel: see EN 300 175-1 [1].

cluster: see EN 300 175-1 [1].

Connection Oriented mode (C/O): see EN 300 175-1 [1].

Cordless Radio Fixed Part (CRFP): see EN 300 175-1 [1].

coverage area: see EN 300 175-1 [1].

Dect Network (DNW): see EN 300 175-1 [1].

double duplex bearer: see EN 300 175-1 [1].

double simplex bearer: see EN 300 175-1 [1].

double slot: one 12th of a TDMA frame which is used to support one high capacity physical channel.

down-link: see EN 300 175-1 [1].

duplex bearer: see EN 300 175-1 [1].

Fixed Part (DECT Fixed Part) (FP): see EN 300 175-1 [1].

Fixed Radio Termination (FT): see EN 300 175-1 [1].

frame: see EN 300 175-1 [1].

full slot (slot): see EN 300 175-1 [1].

guard space: see EN 300 175-1 [1].

half slot: see EN 300 175-1 [1].

handover: see EN 300 175-1 [1].

intercell handover: see EN 300 175-1 [1].

intracell handover: see EN 300 175-1 [1].

Lower Layer Management Entity (LLME): see EN 300 175-1 [1].

multiframe: see EN 300 175-1 [1].

physical channel (channel): see EN 300 175-1 [1].

Portable Part (DECT Portable Part) (PP): see EN 300 175-1 [1].

Portable radio Termination (PT): see EN 300 175-1 [1].

public access service: see EN 300 175-1 [1].

radio channel: no defined meaning. See RF channel or physical channel.

radio end point: see EN 300 175-1 [1].

Radio Fixed Part (RFP): see EN 300 175-1 [1].

Repeater Part (REP): see EN 300 175-1 [1].

RF carrier (carrier): see EN 300 175-1 [1].

RF channel: see EN 300 175-1 [1].

simplex bearer: see EN 300 175-1 [1].

Single Radio Fixed Part (SRFP): see EN 300 175-1 [1].

TDMA frame: see EN 300 175-1 [1].

Wireless Relay Station (WRS): see EN 300 175-1 [1].

3.2 Abbreviations

For the purposes of the present document the following abbreviations apply:

ACP	Adjacent Channel Power
ACK	Acknowledgement
CCFP	Central Control Fixed Part
CI	Common Interface (standard)
CRFP	Cordless Radio Fixed Part
dBc	dB relative to the peak power of an unmodulated carrier
dBm	dB relative to 1 milliwatt
DECT	Digital Enhanced Cordless Telecommunications
DLC	Data Link Control layer
EIRP	Effective Isotropic Radiated Power
ERP	Effective Radiated Power
FP	Fixed Part
FT	Fixed radio Termination
GFSK	Gaussian Frequency Shift Keying
GMSK	Gaussian Minimum Shift Keying
LLME	Lower Layer Management Entity

MAC	Medium Access Control layer
NTP	Normal Transmitted Power
PHL	Physical Layer
PHS	Portable HandSet
PP	Portable Part
ppm	parts per million
PT	Portable radio Termination
REP	Repeater Part
RF	Radio Frequency
RFP	Radio Fixed Part
RSSI	Radio Signal Strength Indicator
SAR	Specific Absorption Rate
TDD	Time Division Duplex
TDMA	Time Division Multiple Access
WRS	Wireless Relay Station

4 PHL services

A physical channel provides a simplex bit-pipe between two radio end points. To establish, for example, a duplex telephone connection, two physical channels have to be established between the endpoints.

Radio spectrum is needed to create a physical channel. The radio spectrum space has three dimensions:

- geometric (geographic) space;
- frequency; and
- time.

Spectrum is assigned to physical channels by sharing it in these three dimensions.

DECT provides a mechanism called "handover", to release a physical channel and to establish another one in any or all of the three dimensions without releasing the end to end connection.

The requirements of the present document should be read in conjunction with EN 300 176 [9].

The requirements specified apply for nominal conditions unless extreme conditions are stated. Tests at extreme conditions may include combinations of limit values of extreme temperature and of power supply variation, defined for each case in EN 300 176 [9].

Nominal and extreme temperature ranges are defined below:

- Nominal temperature: PP, FP, RFP, CCFP + 15 °C to + 35 °C;
- Extreme temperature: PP 0 °C to + 40 °C;
- FP, RFP, CCFP, class E1 + 10 °C to + 40 °C;
- FP, RFP, CCFP, class E2 - 10 °C to + 55 °C.

The environmental class E1 refers to installation in indoor heated and/or cooled areas allowing for personal comfort, e.g. homes, offices, laboratories or workshops. The environmental class E2 refers to all other installations.

For nominal temperature, each measurement is made at the temperature of the test site, which shall be within + 15 °C to + 35 °C. For extreme temperatures, additional measurements are made, at each limit value of the extreme temperature.

4.1 RF channels (access in frequency)

4.1.1 Nominal position of RF carriers

Ten RF carriers shall be placed into the frequency band 1 880-1 900 MHz with centre frequencies F_C given by:

$$F_c = F_0 - c \times 1,728 \text{ MHz.}$$

where: $F_0 = 1897.344 \text{ MHz}$; and

$$c = 0, 1, \dots, 9.$$

Above this band, additional carriers are defined with centre frequencies F_c given by:

$$F_c = F_9 + c \times 1,728 \text{ MHz}$$

and $c \geq 10$ and RF band = 00001 (See EN 300 175-3 [2], subclause 7.2.3.3.1).

The frequency band between $F_c - 1,728/2 \text{ MHz}$ and $F_c + 1,728/2 \text{ MHz}$ shall be designated RF channel c .

NOTE: A nominal DECT RF carrier is one whose centre frequency is generated by the formula:

$$F_g = F_0 - g \times 1,728 \text{ MHz,}$$

where g is any integer.

All DECT equipment shall be capable of working on all 10 RF channels, $c = 0, 1, \dots, 9$.

4.1.2 Accuracy and stability of RF carriers

At an RFP the transmitted RF carrier frequency corresponding to RF channel c shall be in the range $F_c \pm 50 \text{ kHz}$ at extreme conditions.

At a PP the centre frequency accuracy shall be within $\pm 50 \text{ kHz}$ at extreme conditions either relative to an absolute frequency reference or relative to the received carrier, except that during the first 1 s after the transition from the idle-locked state to the active-locked state the centre frequency accuracy shall be within $\pm 100 \text{ kHz}$ at extreme conditions relative to the received carrier.

NOTE: The above state transition is defined in EN 300 175-3 [2].

The maximum rate of change of the centre frequency at both the RFP and the PP while transmitting, shall not exceed 15 kHz per slot.

4.2 Time Division Multiple Access (TDMA) structure (access in time)

4.2.1 Frame, full-slot, double-slot, and half-slot structure

To access the medium in time, a regular TDMA structure is used. The structure repeats in frames of 11 520 bits, and the data is transmitted at a bit rate of 1 152 kbit/s. Within this frame 24 full-slots are created, each consisting of two half-slots. A double slot has a length of two full slots, and starts concurrently with an even numbered full slot (see figures 1, 2 and 3).

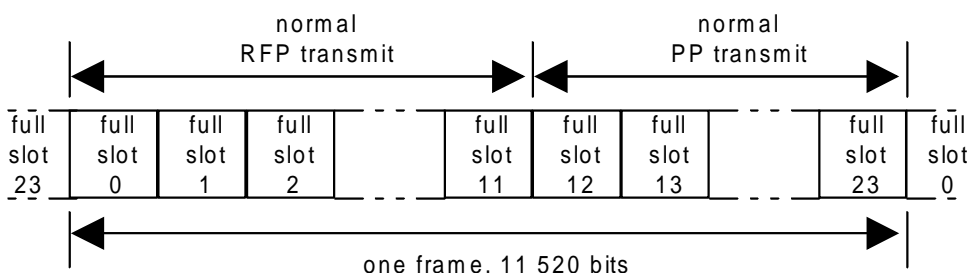

Figure 1: Full slot format

Full-slots are numbered from $K = 0$ to 23, and half-slots are numbered $L = 0$ or 1, where half-slot 0 occurs earlier than half-slot 1. Normally full-slots $K = 0$ to 11 are used in the RFP to PP direction, while full slots $K = 12$ to 23 are normally used in the PP to RFP direction. Double slots are numbered $K = 0$ to 22 for even values of K .

Each full-slot has a duration of 480 bit intervals. Bit intervals within a full-slot are denoted f_0 to f_{479} where interval f_0 occurs earlier than interval f_1 . Each half-slot has a duration of 240 bit intervals. Half-slots commence at f_0 or f_{240} (see figure 2).

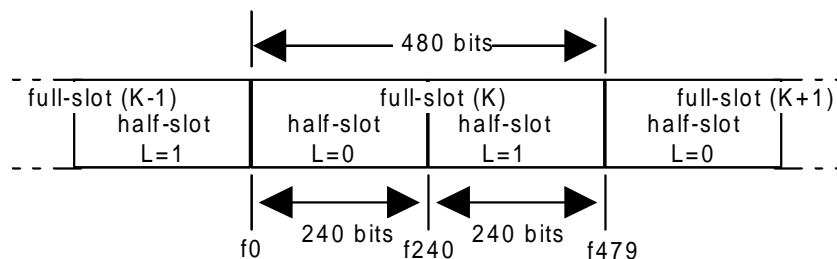

Figure 2: Half-slot format

Each double slot has a duration of 960 bit intervals. Bit intervals within a double slot are denoted f_0 to f_{959} . Bits f_0 to f_{479} coincide with the same notation for full slots with even K , $K(e)$.

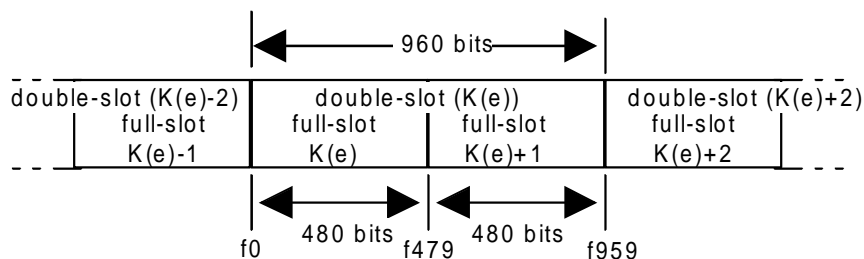

Figure 3: Double slot format

NOTE: Each radio end point has its own timing of the TDMA structure due to propagation delay and non-synchronized systems.

4.2.2 Reference timer accuracy and stability

The reference timer of a RFP or a PP is a notional clock to which the timing parameters of the TDMA framing are related.

A PP shall have its reference timer stability and accuracy better than 25 ppm at extreme conditions.

RFPs that can work with more than one duplex pair of physical channels per frame are known as multi-channel RFPs. Single channel RFPs can only work with one duplex pair of physical channels per frame (excluding handover situations).

A multi channel RFP shall have its reference timer stability and accuracy better than 5 ppm and better than 10 ppm at extreme conditions.

A single channel RFP shall have reference timer stability and accuracy better than 10 ppm at extreme conditions.

4.2.3 RFP transmission jitter

The nominal time when a packet should occur at the RFP antenna is (by this definition) synchronous to the RFP reference timer.

The jitter of a RFP packet transmission in a slot refers to the occurrence at the antenna of the start of bit p_0 of that packet. The jitter is defined in relation to the reference timer of that RFP.

The jitter of a packet transmission shall be less than $\pm 1 \mu\text{s}$ at extreme conditions.

The jitter between p0 and every other bit in a packet shall be within $\pm 0,1 \mu\text{s}$.

NOTE: $0,1 \mu\text{s}$ corresponds to 250 ppm.

4.2.4 PP reference timer synchronization

A PP shall take its reference timer parameters, including half-slot, full-slot, frame, multi-frame and receiver scan (see synchronization, EN 300 175-3 [2]) from any channel of any of the RFPs that it is locked to.

It is allowed (but not required) to have more than one PP reference timer.

The reference timer used for a PP transmission to a RFP shall be synchronized to packets (see subclause 4.4) received from that RFP or from a RFP to which handover (see subclause 4.2.5) is allowed.

This reference timer for packet transmission timing is nominally (by this definition) synchronized to the time when the last packet used for synchronization occurred at the PP antenna.

When a PP transmits a packet, the start of transmission of bit p0 of the packet shall occur at the PP antenna $\pm 2 \mu\text{s}$ at extreme conditions from the nominal transmission time as given by an ideal PP reference timer with 0 ppm accuracy. An exception is allowed for a dummy bearer change request packet transmission (see EN 300 175-3 [2], subclause 7.2.5.6), when the nominal transmission time shall be given by the actual PP reference timer.

NOTE: The reason for the exception is that a residential PP may need to send the dummy bearer change request after a sudden slot theft in the idle locked mode. In this case the last synchronization of the reference timer can be more than 16 frame old. For all other packet transmissions, including bearer set up, the synchronization is normally less than one frame old.

The jitter between p0 and every other bit in a packet shall be within $\pm 0,1 \mu\text{s}$.

Connections to different RFPs are allowed (but not required) to have different reference timers.

4.2.5 System synchronization

RFPs on the same FP shall be in half-slot, full-slot and frame synchronism. If internal handover is provided (see EN 300 175-3 [2] and EN 300 175-4 [3]), receiver scan and multiframe synchronism is also required.

The difference between reference timers of RFPs of the same FP shall be less than $4 \mu\text{s}$ if internal handover is provided between these RFPs.

NOTE: Related to its reference timer, the PP or RFP synchronization window (see EN 300 175-3 [2]) should be at least ± 14 bits, when expecting a first reception and if intracell handover is provided, else ± 4 bits.

4.2.6 Inter-system synchronization

Synchronization between FPs can be provided via an optional synchronization port (see annex B).

NOTE: RFPs of synchronized FPs should have geographically unique Fixed Part MAC Identities (FMIDs) (see EN 300 175-6 [5]).

4.2.7 Reference timer adjustment for synchronization

To obtain system and inter-system synchronization, a RFP or PP may alter the length of a single frame by any amount, or, it may alter the length of successive frames by up to 2 bits.

NOTE 1: Framelength alterations should be performed in accordance to the reference timer stability and accuracy requirements for RFPs and PPs as specified in subclause 4.2.2.

NOTE 2: If the timing of RFPs is adjusted outside the specification of subclause 4.2.2 then PPs are not expected to remain in the IDLE_LOCKED state. Therefore such timing adjustments should be made as infrequently as possible by RFP reference timers.

4.3 Cells (access in space)

The third dimension to divide spectrum space is the geographical volume. Propagation losses may allow time-frequency combinations to be reused in different places.

4.4 Physical packets

Data is transmitted within the frequency, time, and space dimensions using physical packets. Physical packets shall be of one of the following types:

- short physical packet P00;
- basic physical packet P32;
- low capacity physical packet P08j;
- high capacity physical packet P80.

All RFPs shall be capable of transmitting, and all PPs shall be capable of receiving, short physical packets P00. All radio end points shall be capable of transmitting and receiving at least one of the physical packet types P32, P08j, or P80.

Each physical packet contains a synchronization field S and a data field D. The packets P80, P32 and P08j may contain an optional collision detection field, Z.

4.4.1 The short physical packet P00

The short physical packet P00 consists of 96 data bits, used for dummy bearers and short slot connectionless bearers.

The data bits are denoted p_0 to p_{95} where p_0 occurs earlier than p_1 . When the packet is transmitted, the beginning of bit p_0 coincides with the beginning of bit interval f_0 of the full-slot being used (see figure 4).

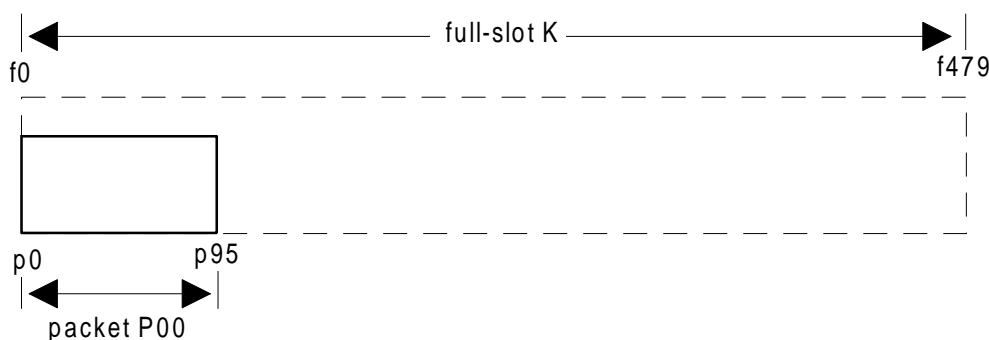

Figure 4: Short packet P00

4.4.2 The basic physical packet P32

The basic physical packet P32, used in the most common types of connection (e.g. telephony), consists of 420 or 424 data bits.

The data bits are denoted p_0 to p_{423} where p_0 occurs earlier than p_1 . When the packet is transmitted, the beginning of bit p_0 coincides with the beginning of bit interval f_0 of the full-slot being used (see figure 5).

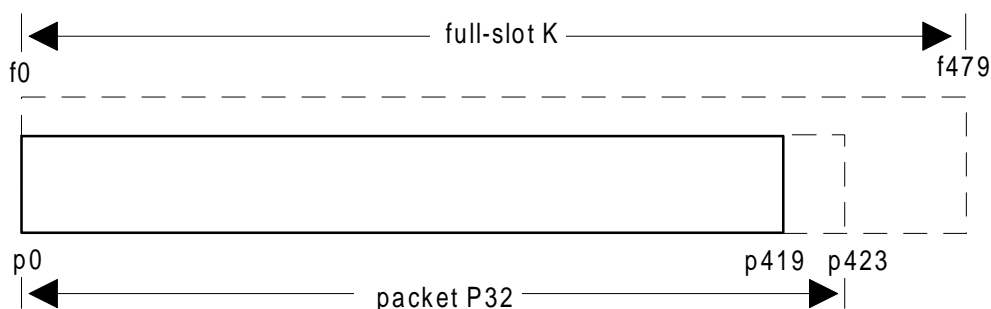

Figure 5: Basic packet P32

4.4.3 The low capacity physical packet P08j

The low capacity physical packet P08j consists of $180+j$ or $184+j$ data bits.

The data bits are denoted p_0 to $p_{(183+j)}$ where p_0 occurs earlier than p_1 . Depending on the half-slot in use, the beginning of bit p_0 coincides either with the beginning of bit interval f_0 or the beginning of bit interval f_{240} of the full-slot being used (see figure 6).

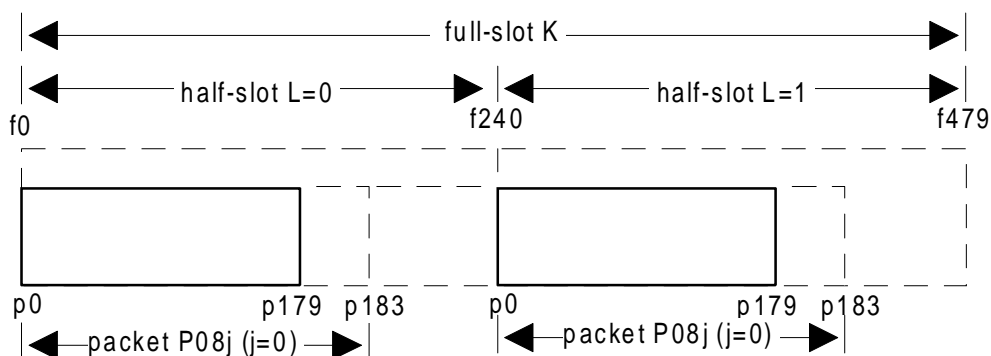

Figure 6: Low capacity packet P08j for $j=0$.

NOTE: Values of j , other than 0, are subject to future standardization.

4.4.4 The high capacity physical packet P80

The high capacity physical packet P80 consists of 900 or 904 data bits.

The data bits are denoted p_0 to p_{903} where p_0 occurs earlier than p_1 . When the packet is transmitted, the beginning of bit p_0 coincides with the beginning of bit interval f_0 of the double-slot. Only even slot numbers K are defined (see figures 3 and 7).

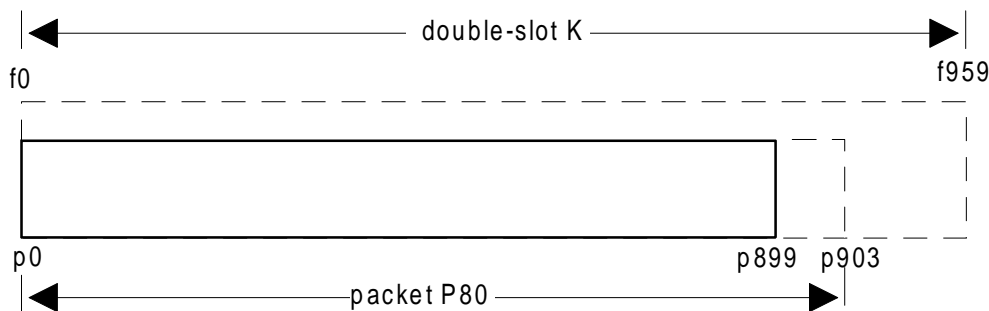

Figure 7: High capacity packet P80

4.5 Physical channels

Physical channels shall be created by transmitting modulated physical packets as described in clause 5 on a particular RF channel, during a particular time in successive frames, at a particular location. Physical channels shall be set up between a PP and a RFP.

One physical channel can provide a connectionless, simplex service, and a pair of physical channels can provide a duplex service.

4.5.1 Ra (K, L, M, N) notation

Physical channels shall be denoted as Ra (K,L,M,N). The parameters are:

- a = 00 physical packet P00 in use;
- a = 32 physical packet P32 in use;
- a = 08j physical packet P08j in use;
- a = 80 physical packet P80 in use;
- K = {0,...,23} the number of the full-slot in which transmission of the packet starts;
- L = 0 packet transmission starts at bit interval f0;
- L = 1 packet transmission starts at bit interval f240;
- M = {0,...,9} the number of the RF channel used to transmit the physical packet;
- N the number, Radio fixed Part Number (RPN) (= N), of the radio fixed part using the physical channel. This parameter depends on the individual system and may be meaningless in many cases. It is, however, particularly helpful in describing handover algorithms;
- s = 0 normal preamble synchronization field;
- s = 16 prolonged preamble synchronization field;
- z = 0 no Z field;
- z = 1 Z field available.

NOTE: Prolonged preamble is defined in annex C. If a system employs prolonged preamble physical packets P00, P32, P08j and P80 will start at bit p-16. Figures 8, 9, 10 & 11 are drawn for normal preamble.

4.5.2 The short physical channel R00(K,L,M,N)

The short physical channel, given in figure 8, shall be created by transmitting a physical packet P00 during full-slot K on carrier M in cell N, where:

$$K = \{0, \dots, 23\},$$

$$L = 0,$$

$$M = \{0, \dots, 9\}, \text{ and}$$

N is arbitrary.

$$s = 0/16,$$

$$z = 0/1.$$

Packet P00 shall only be transmitted on full-slot boundaries.

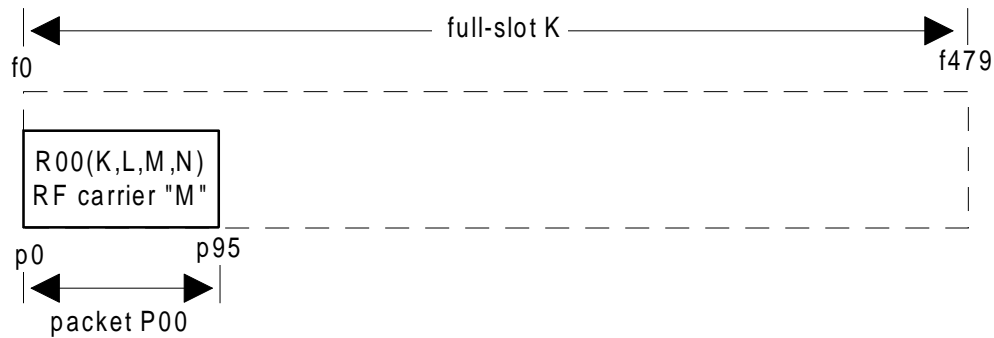

Figure 8: Short physical channel R00

4.5.3 The basic physical channel R32(K,L,M,N)

The basic physical channel, given in figure 9, shall be created by transmitting a physical packet P32 during full-slot K on carrier M in cell N, where:

$$K = \{0, \dots, 23\},$$

$$L = 0,$$

$$M = \{0, \dots, 9\}, \text{ and}$$

N is arbitrary.

$$s = 0/16,$$

$$z = 0/1.$$

Packet P32 shall only be transmitted on full-slot boundaries.

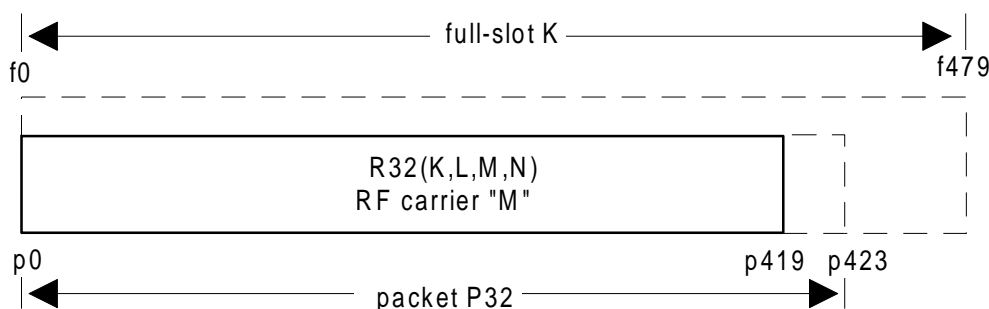

Figure 9: Basic physical channel R32

4.5.4 The low-rate physical channel R08j(K,L,M,N)

The low rate physical channel, given in figure 10, shall be created by transmitting a physical packet P08j during the first or second half-slot of full-slot K on carrier M in cell N, where:

$$K = \{0, \dots, 23\};$$

$$L = \{0, 1\};$$

$$M = \{0, \dots, 9\}; \text{ and}$$

N is arbitrary;

$$s = 0/16;$$

$$z = 0/1.$$

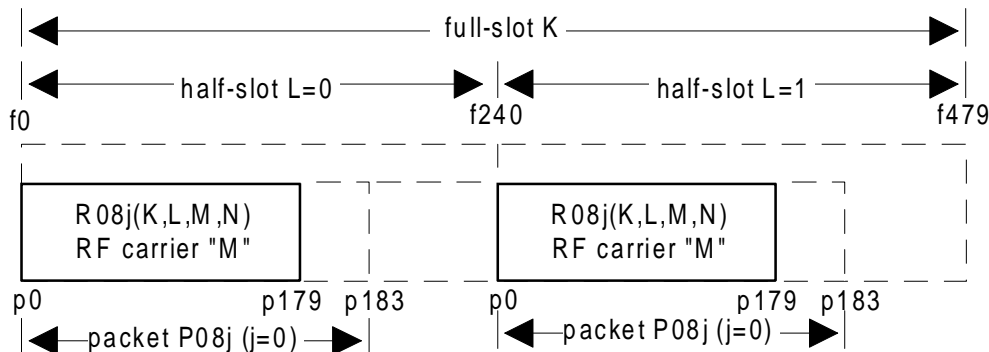

Figure 10: Low rate physical channel R08j for j = 0.

NOTE: Values of j, other than 0, are subject to future standardization.

4.5.5 The high capacity physical channel R80(K,L,M,N)

The high capacity physical channel, given in figure 11, shall be created by transmitting a physical packet P80 during double-slot K on carrier M in cell N, where:

$$K = \{0, \dots, 22\} \text{ and } K \text{ is an even number};$$

$$L = 0;$$

$$M = \{0, \dots, 9\}; \text{ and}$$

N is arbitrary;

$$s = 0/16;$$

$z = 0/1$.

Packet P80 shall only be transmitted on boundaries of a full slot with an even value of K .

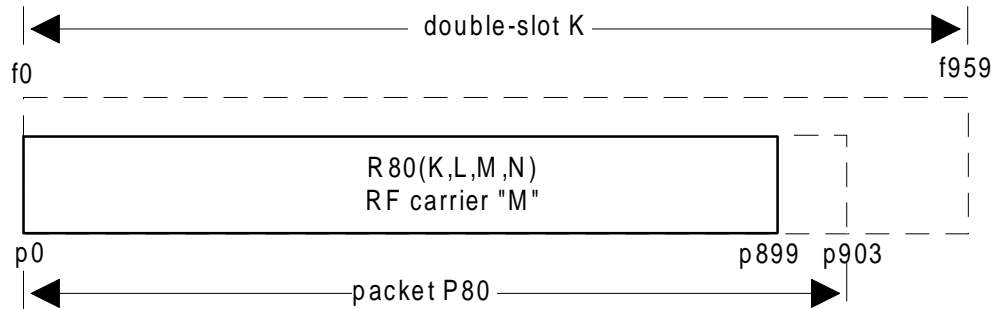

Figure 11: High capacity physical channel R80

4.6 Synchronization field S

The synchronization field S may be used by the receiver for clock and packet synchronization of the radio link. The first 16 bits are a preamble, and the last 16 bits are the packet synchronization word.

The field contains 32 bits denoted s_0 to s_{31} and is transmitted in bits p_0 to p_{31} . Starting with s_0 , the synchronization bits are defined as follows:

RFP transmissions:

1010 1010 1010 1010 1110 1001 1000 1010 (binary)

s_0 s_{15} s_{16} s_{31}

PP transmissions:

0101 0101 0101 0101 0001 0110 0111 0101 (binary)

s_0 s_{15} s_{16} s_{31}

The two bit sequences $s_0 - s_{31}$ are the inverse of each other.

Annex C outlines an optional prolonged preamble field which extends the preamble bit pattern by 16 bits. This prolonged preamble field may be used by a receiver for implementation of an antenna selection diversity algorithm.

4.7 D-field

4.7.1 Physical packet P00

The D-field contains 64 bits denoted d_0 to d_{63} and is transmitted in bits p_{32} to p_{95} (see figure 12).

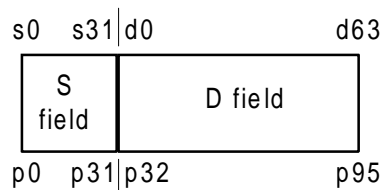

Figure 12: P00 packet

4.7.2 Physical packet P32

The D-field contains 388 bits denoted d0 to d387 and is transmitted in bits p32 to p419 (see figure 13).

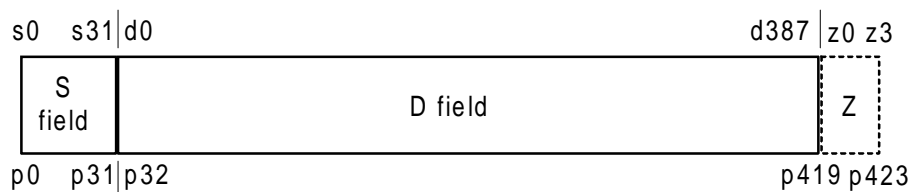

Figure 13: Packet P32

4.7.3 Physical packet P08j

The D-field contains $148+j$ bits denoted d0 to $d(147+j)$ and shall be transmitted in bits p32 to $p(179+j)$ (see figure 14).

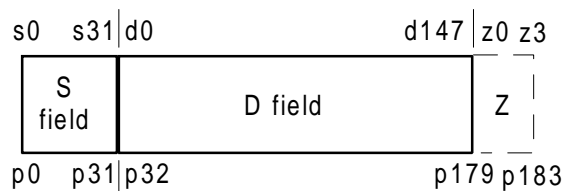

Figure 14: Packet P08j for j = 0

NOTE: Values of j, other than 0, are subject to future standardization.

4.7.4 Physical packet P80

The D-field contains 868 bits denoted d0 to d867 and is transmitted in bits p32 to p899 (see figure 15).

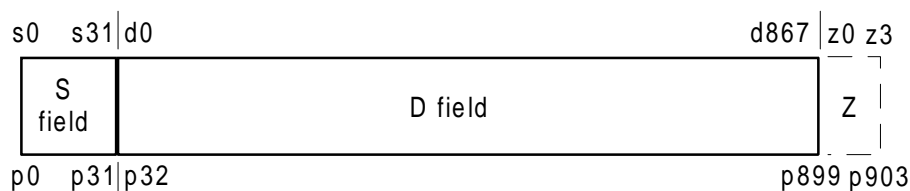

Figure 15: Packet P80

4.8 Z-field

The Z-field may be used by the receiver for early detection of an unsynchronized interference sliding into the end of the physical packet P32, P08j, or P80.

NOTE 1: Unsynchronized interference sliding into the beginning of a physical packet can be detected by monitoring bit errors in the S-field.

The Z-field contains 4 bits, z0 to z3, immediately following the last bit of the D-field (see figure 16).

The bits z0 to z3 shall be set equal to the 4 last bits of the D-field. These last 4 bits are the X-field (see EN 300 175-3 [2]).

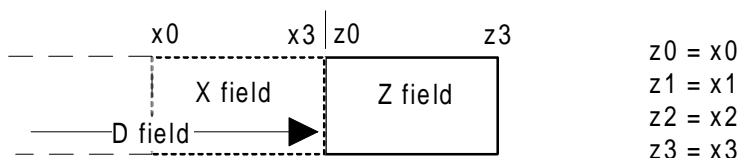

Figure 16 : The Z-field

The provision of the Z-field operation is optional, subject to mandatory requirements of profiles (see EN 300 444 [8]).

NOTE 2: The Z-field is especially useful for the I_N services like speech (see EN 300 175- 3 [2]). By comparing the received Z-field with a correctly received X-field, an early sliding interferer (X correct and errors in Z) can be distinguished from an unsynchronized slot theft that also corrupts the D-field, e.g. speech (errors in X). Optimized handover procedures can be applied for each case.

4.9 Bit pattern during ramping

During the interval before the physical packet, when the transmitter power is ramped up (see subclause 5.2.1), the transmitter shall either transmit a bit pattern which is the natural extension of the preamble bit pattern (see subclause 4.6), or transmit the carrier center frequency without modulation. During the interval after the physical packet, when the transmitter power is ramped down (see subclause 5.2.2), the transmitter bit pattern is not defined.

NOTE: Receiver EN 300 176 [18] tests use a specified short unmodulated ramp up, considered to cover the worst case. Receivers are also expected to comply when other allowed ramp up signals are used.

5 Transmission of physical packets

5.1 Definitions

5.1.1 End of the physical packet

The physical packet P00 ends at the end of bit p95.

The physical packet P32 ends at the end of bit p419 or p423.

The physical packet P08j ends at the end of bit p(179+j) or p(183+j).

The physical packet P80 ends at the end of bit p899 or p903.

5.1.2 Transmitted power

This is the mean power delivered over one radio frequency cycle.

5.1.3 Normal Transmitted Power (NTP)

The NTP is the transmitted power averaged from the start of bit p0 of the physical packet, to the end of the physical packet.

5.2 Transmission burst

The transmission requirements are defined in subclauses 5.2.1 to 5.2.6 and graphically represented in figure 17.

5.2.1 Transmitter attack time

This is the time taken for the transmitted power to increase from 25 μW to the time that the first bit of the physical packet, p0, starts transmission.

The transmitter attack time shall be less than 10 μs at extreme conditions.

5.2.2 Transmitter release time

This is the time taken from the end of the physical packet for the transmitted power to decrease to 25 μW .

The transmitter release time shall be less than 10 μs at extreme conditions.

5.2.3 Minimum power

From the first bit of the packet, p0, to the end of the physical packet, the transmitted power shall be greater than (NTP - 1 dB) at extreme conditions.

5.2.4 Maximum power

From 10 μs after the start of bit p0 to 10 μs after the end of the physical packet, the transmitted power shall be less than (NTP + 1 dB) at extreme conditions.

From 10 μs before the start of bit p0 to 10 μs after the start of bit p0, the transmitted power shall be less than (NTP + 4 dB) and less than 315 mW at extreme conditions.

5.2.5 Maintenance of transmission after packet end

The transmitted power shall be maintained greater than (NTP - 6 dB) for 0,5 μs after the end of the physical packet at extreme conditions.

5.2.6 Transmitter idle power output

For the time period starting 27 μs after the end of the physical packet and finishing 27 μs before the next transmission of a data bit p0, the transmitter idle power shall be less than 20 nW, except when p0 of the next transmitted packet occurs less than 54 μs after the end of the transmitted physical packet.

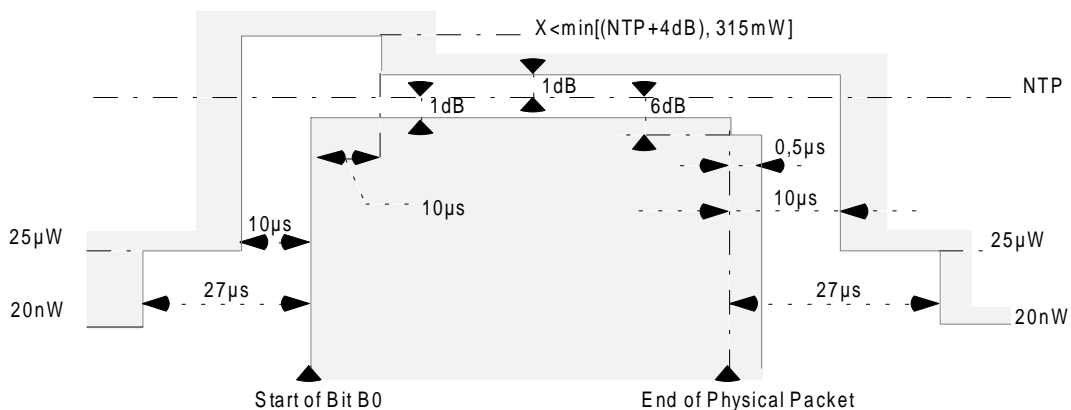

Figure 17: Physical packet power-time template

5.3 Transmitted power

5.3.1 Peak power per transceiver

5.3.1.1 PP and RFP with an integral antenna

The equivalent isotropically radiated NTP shall be less than P_{NTP} per simultaneously active transceiver at nominal conditions.

The transmitter power P_{NTP} is defined in the following table.

Power level	P_{NTP} (mW)
Level 1	2,5
Level 2	250

5.3.1.2 PP and RFP with external connections for all antennas

A matched load is connected to each antenna port of the PP or RFP and the power delivered to these loads is measured.

For a radio end point with more than one antenna port, the instantaneous power from each antenna port shall be added together to give the NTP.

The NTP shall be less than P_{NTP} per simultaneously active transceiver at extreme conditions.

NOTE: The antenna gain should in the majority of applications be no more than 12 dBi, but may for specific applications be up to 22 dBi. Use of antenna gain values higher than 12 dBi may be subject to agreement with national radio authorities.

5.3.2 Maximum EIRP and number of transceivers

The safety requirements of annex A shall be met.

5.4 RF carrier modulation

5.4.1 Modulation method

The modulation method shall be Gaussian Frequency Shift Keying, (GFSK), with a bandwidth-bit period product of nominally 0,5.

5.4.2 Definition of "1" and "0"

A binary "1" is encoded with a peak frequency deviation of (+ f), giving a peak transmit frequency of ($F_c + f$), which is greater than the carrier frequency of (F_c). A binary "0" is encoded with a peak frequency deviation of (- f), giving a peak transmit frequency of ($F_c - f$).

The nominal peak deviation (f) shall be 288 kHz.

5.4.3 Deviation limits

The achieved deviation in any given PP or RFP may vary from this nominal value as follows:

NOTE 1: These limits apply equally to positive and negative deviations.

Case A: Case A shall apply to the transmission of a repeating binary sequence of four "1"s and four "0"s:

....000011110000111100001111....

The deviation limits for case A shall be:

- peak deviation greater than 259 kHz (90 % of nominal);
- peak deviation less than 403 kHz (140 % of nominal).

Case B: Case B shall apply to the transmission of all other binary sequences (sequences both longer and shorter than case A) that contain a maximum "digital sum variation" (see note 2) with an absolute value equal to or less than sixty four.

The deviation limits for case B shall be:

- peak deviation greater than 202 kHz (70 % of nominal);
- peak deviation less than 403 kHz (140 % of nominal).

NOTE 2: Case B includes the case of a ".1010." sequence.

NOTE 3: "Digital Sum Variation" (DSV) is defined as the cumulative total of all transmitted symbols, counted from the start of the transmission burst. A binary "1" counts as (+ 1); a binary "0" as (- 1). The DSV total indicates the cumulative DC balance of the transmitted symbols.

5.5 Unwanted RF power radiation

5.5.1 Emissions due to modulation

With transmissions on physical channel Ra (K,L,M,N) in successive frames, the power in physical channel Ra (K,L,Y,N) shall be less than the values given in Table 1.

Table 1

Emissions on RF channel "Y"	Maximum power level
Y = M ± 1	160 µW
Y = M ± 2	1 µW
Y = M ± 3	40 nW
Y = any other DECT channel	20 nW
NOTE: For Y = "any other DECT channel", the maximum power level shall be less than 20 nW except for one instance of a 500 nW signal.	

The power in RF channel Y is defined by integration over a bandwidth of 1 MHz centred on the nominal centre frequency, F_y, averaged over at least 60 % but less than 80 % of the physical packet, and starting before 25 % of the physical packet has been transmitted but after the synchronization word.

5.5.2 Emissions due to transmitter transients

The power level of all modulation products (including Amplitude Modulation (AM) products due to the switching on or off of a modulated RF carrier) arising from a transmission on RF channel M shall, when measured using a peak hold technique, be less than the values given in Table 2. The measurement bandwidth shall be 100 kHz and the power shall be integrated over a 1 MHz bandwidth centred on the DECT frequency, F_y.

Table 2

Emissions on RF channel "Y"	Maximum power level
$Y = M \pm 1$	250 μ W
$Y = M \pm 2$	40 μ W
$Y = M \pm 3$	4 μ W
Y = any other DECT channel	1 μ W

5.5.3 Emissions due to intermodulation

The power level of intermodulation products that are on any DECT physical channel when any combination of the transmitters at a radio end point are in calls on the same slot on different frequencies shall be less than 1 μ W. The power level is defined by integration over the 1 MHz centred on the nominal centre frequency of the afflicted channel and averaged over the time period in subclause 5.5.1.

5.5.4 Spurious emissions when allocated a transmit channel

The peak power level of any RF emissions outside the radio frequency band allocated to DECT, as defined in subclause 4.1.1, when a radio end point has an allocated physical channel, shall not exceed 250 nW at frequencies below 1 GHz and 1 μ W at frequencies above 1 GHz. The power shall be defined in the bandwidths given in Table 3. If a radio end point has more than one transceiver, any out of band transmitter intermodulation products shall also be within these limits.

Table 3

Frequency offset, f_o from edge of band	Measurement bandwidth
$0 \text{ MHz} \leq f_o < 2 \text{ MHz}$	30 kHz
$2 \text{ MHz} \leq f_o < 5 \text{ MHz}$	30 kHz
$5 \text{ MHz} \leq f_o < 10 \text{ MHz}$	100 kHz
$10 \text{ MHz} \leq f_o < 20 \text{ MHz}$	300 kHz
$20 \text{ MHz} \leq f_o < 30 \text{ MHz}$	1 MHz
$30 \text{ MHz} \leq f_o < 12,75 \text{ GHz}$	3 MHz

Measurements shall not be made for transmissions on the RF channel closest to the nearest band edge for frequency offsets of up to 2 MHz.

In addition, not regarding up to 2 instances of a continuous-wave spurious signal for PPs for which the total peak power level shall be less than 250 nW as measured in a 3 MHz measurement bandwidth, the peak power level shall be less than 20 nW in a 100 kHz measuring bandwidth for the following broadcast bands:

47 MHz to 74 MHz;

87,5 MHz to 108 MHz;

108 MHz to 118 MHz;

174 MHz to 230 MHz;

470 MHz to 862 MHz.

6 Reception of physical packets

6.1 Definitions and conditions for clause 6

6.1.1 Power levels and field strength

In this subclause, the requirements are given in terms of power levels at the receiver input. Equipment without an external antenna connection may be taken into account by assuming that they have a 0 dBi gain antenna and converting these power level requirements into field strength requirements. This means that the tests on equipment without an external antenna will consider field strengths (E) related to the power levels (P), as specified by the following formula:

$$E \text{ (dB}\mu\text{V/m)} = P \text{ (dBm)} + 142,7$$

derived from:

$$E = P + 20\log F \text{ (MHz)} + 77,2, \text{ and assuming } F = 1\,890 \text{ MHz.}$$

6.1.2 Test conditions

Steady state, non-fading conditions are assumed for both wanted and unwanted signals.

Unless otherwise stated, the frame error ratio shall be less than 5 %.

6.1.3 Reference DECT radio end point

A "reference DECT radio end point" is a DECT equipment that meets the criteria for a reference DECT radio as given in EN 300 176 [9]. Two of the requirements for the reference DECT radio end point are:

- a) transmit power of $250 \text{ mW} \pm 1 \text{ dB}$ is maintained from the beginning of bit p0 to the end of the physical packet, as defined in subclause 5.1.1;
- b) use of GMSK modulation with $BT = 0,5$, thus giving an adjacent channel interference level of 40 dB below 250 mW.

A reference DECT interferer is a continuous transmission as defined in EN 300 176 [9].

6.2 Radio receiver sensitivity

The radio receiver sensitivity is defined as the power level at the receiver input at which the Bit Error Rate (BER) is 0,001 in the D-field.

The radio receiver sensitivity shall be -86 dBm (i.e. $57 \text{ dB}\mu\text{V/m}$), or better. This limit shall be met for a reference DECT radio end point transmitted frequency error of $\pm 50 \text{ kHz}$ for PPs and RFPs.

This requirement shall be met with the radio end point under test operating in time division duplex mode with a reference DECT radio end point.

Before using a DECT physical channel for transmission or reception, the receiver shall be able to measure the strength of signals on that physical channel, that are received stronger than - 93 dBm (i.e. $50 \text{ dB}\mu\text{V/m}$) and weaker than - 33 dBm (i.e. $110 \text{ dB}\mu\text{V/m}$) with a resolution of better than 6 dB. Signals that are received weaker than - 93 dBm shall produce a result equal to, or less than that produced by a signal of - 93 dBm. Signals that are received stronger than - 33 dBm shall produce a result equal to, or greater than that produced by a signal of - 33 dBm.

6.3 Radio receiver reference bit error rate and frame error ratio

The radio receiver reference bit error rate and frame error ratio is the maximum allowed bit error rate and frame error ratio for a power level at the receiver input of -73 dBm or greater (i.e. 70 dB μ V/m).

The reference bit error rate is 0,00001 in the D-field. The reference frame error ratio is 0,0005.

6.4 Radio receiver interference performance

With a received signal strength of -73 dBm (i.e. 70 dB μ V/m) on RF channel M, the BER in the D-field shall be maintained better than 0,001 when a modulated, reference DECT interferer of the indicated strength is introduced on the DECT RF channels shown in Table 4.

Table 4

Interferer on RF channel "Y":	Interferer signal strength	
	(dB μ V/m)	(dBm)
Y =M	60	-83
Y =M \pm 1	83	-60
Y =M \pm 2	104	-39
Y =any other DECT channel	110	-33
NOTE: The RF carriers "Y" shall include the three nominal DECT RF carrier positions immediately outside each edge of the DECT band.		

6.5 Radio receiver blocking

6.5.1 Owing to signals occurring at the same time but on other frequencies

The receiver should work in the presence of strong signals on other frequencies. These interferers may be modulated carriers or single frequency signals. The operation in the presence of DECT modulated signals has been described in subclause 6.4.

With the desired signal set at -80 dBm, the BER shall be maintained below 0,001 in the D-field in the presence of any one of the signals shown in Table 5.

The receiver shall operate on a frequency band allocation with the low band edge F_L MHz and the high band edge F_U MHz.

Table 5

Frequency (f)	Continuous wave interferer level	
	For radiated measurements dB μ V/m	For conducted measurements dBm
$25 \text{ MHz} \leq f < F_L - 100 \text{ MHz}$	120	-23
$F_L - 100 \text{ MHz} \leq f < F_L - 5 \text{ MHz}$	110	-33
$ f - F_C > 6 \text{ MHz}$	100	-43
$F_U + 5 \text{ MHz} < f \leq F_U + 100 \text{ MHz}$	110	-33
$F_U + 100 \text{ MHz} < f \leq 12,75 \text{ GHz}$	120	-23

For the basic DECT frequency band allocation F_L is 1 880 MHz and F_U is 1 900 MHz. Receivers may support additional carriers, e.g. up to $F_U = 1 920$ MHz.

6.5.2 Owing to signals occurring at a different time

With a signal of strength -14 dBm (i.e. 129 dB/ μ Vm) incident on the receiver in slot "N" on RF carrier "M", the receiver shall be able to receive at -83 dBm, and with the BER in the D-field maintained better than 0,001, on slot (N + 2) modulo 24 on any DECT RF carrier.

6.6 Receiver intermodulation performance

With a call set up on a particular physical channel, two interferers are introduced so that they can produce an intermodulation product on the physical channel already in use.

If RF carrier number "d" is in use, a reference DECT interferer and a continuous wave interferer are introduced on DECT carriers "e" and "f" to produce an intermodulation product on carrier "d". Neither "e" nor "f" shall be adjacent to "d".

The received level of carriers "e" and "f" shall be -47 dBm and the received level of carrier "d" shall be -80 dBm.

With "e" and "f" being received 33 dB greater than "d", and "d" being received at -80 dBm, the receiver shall still operate with a BER of less than 0,001 in the D-field.

6.7 Spurious emissions when not allocated a transmit channel

6.7.1 Out of band

The power level of any spurious emissions when the radio end point has no allocated transmit channel shall not exceed 2 nW between 30 MHz and 1 GHz. Between 1 GHz and 12,75 GHz the power level shall not exceed 20 nW.

The power shall be measured using a peak hold technique with a 100 kHz measurement bandwidth.

6.7.2 In the DECT band

The power level of any spurious emissions within the DECT band shall not exceed 2 nW measured in a 1 MHz bandwidth. The following exceptions are allowed:

- a) in one 1 MHz band, the maximum allowable Effective Radiated Power (ERP) shall be less than 20 nW;
- b) in up to two bands of 30 kHz, the maximum ERP shall be less than 250 nW.

7 Primitives between physical layer and other entities

The contents of this clause are provided for information only. This clause is aimed to assist in the description of layer to layer procedures.

These primitives are abstract and their concrete representations may vary from implementation to implementation. Therefore, they shall not be considered to be a testable entity.

In the parameter lists in this clause:

- X = this parameter is present in this primitive;
- = this parameter is not present in this primitive;
- O = this parameter is optional.

7.1 Medium access control layer (D-SAP)

The physical layer communicates with the MAC Layer by primitives through the D-SAP (SAP = Service Access Point). The D-SAP is mainly used to exchange D-fields between the PHL and the MAC Layer. In addition this SAP may be used for frequency adjustment purposes and sliding collision information.

D-field segments may be passed through the D-SAP in either direction, depending upon whether the segments have to be transmitted or received by the PHL. The Service Data Unit (SDU) length of primitives carrying one D-field corresponds to the D-field length of the physical packet in use (see subclause 4.7).

The following primitives are exchanged through the D-SAP:

- For D-Field transmissions: PL_TX {req};
- for D-Field receptions: PL_RX {req,cfm};
- for frequency adjustment: PL_FREQ_ADJ {req}.

7.1.1 PL_TX {req}

The MAC layer supplies the physical layer with the D-field, the physical channel number on which it is to be transmitted and an optional command to add the Z-field. The physical channel number defines the length of the D-field.

Table 6: PL_TX parameter list

Parameter	Primitive type	
	Request	Confirm
D-field	X	-
a	X	-
K	X	-
L	X	-
M	X	-
add Z field	O	-
s	O	-

7.1.2 PL_RX {req,cfm}

The MAC layer supplies the physical layer with a physical channel number excluding RPN.

The confirm primitive contains a "valid synchronization word" and the "D-field", and optionally, "frequency error" and "sliding collision information".

Table 7: PL_RX parameter list

Parameter	Primitive type	
	Request	Confirm
a	X	-
K	X	-
L	X	-
M	X	-
valid synchronization word	-	X
D field	-	X
frequency error	-	O
sliding collision information	-	O

7.1.3 PL_FREQ_ADJ {req,}

With a request primitive the MAC layer instructs the physical layer to increase or decrease the transmit or receive centre frequency by a given small amount (this is not the "change RF channel" command). The physical layer may respond with a confirm primitive which indicates that the function is not supported.

If this function is not supported the physical layer may issue a PL_FREQ_ADJ-cfm primitive.

NOTE: The PL-FREQ_ADJ message is defined in EN 300 175-3 [2].

7.2 Management entity (PM-SAP)

The physical layer communicates with the lower layer management entity by primitives through the PM-SAP. The primitives passed through the PM-SAP are mainly used to invoke and control physical layer processes.

The following primitives are exchanged through the PM-SAP:

- PL_ME_SYNC {req,cfm};
- PL_ME_SIG_STR {req,cfm};
- PL_ME_TIME_ADJ {req,cfm}.

7.2.1 PL_ME_SYNC {req,cfm}

The ME requests the physical layer to search, over a time and frequency period, for a synchronization pulse.

7.2.2 PL_ME_SIG_STR {req,cfm}

The ME requests the physical layer to provide a measure of the signal strength on physical channel Ra(K,L,M,N). The signal strength is measured according to the description in subclause 8.3.

The confirm primitive contains the measured signal strength relative to some internal standard.

7.2.3 PL_ME_TIME_ADJ {req,cfm}

The ME requests the physical layer to lengthen or shorten a single frame by a given amount.

An RFP uses this timing adjustment for intra-system or inter-system synchronization. A PP uses this timing adjustment to lock to an RFP.

8 PHL procedures

8.1 Addition of synchronization field and transmission

When the PHL receives a PL_TX-req primitive, the appropriate synchronization field, defined in subclause 4.6, shall be added and the Z-field, subclause 4.8, may be added and the complete physical packet shall be transmitted on the next slot of physical channel Ra(K,L,M,N).

If the Z-field is added, it shall be transmitted during the entire existence of a simplex bearer.

8.2 Packet reception and removal of synchronization field

When the PHL receives a PL_RX-req primitive it shall:

- a) receive the specified physical packet in the next occurrence of the specified physical channel;
- b) acquire and confirm slot synchronization using the synchronization field.

NOTE 1: Different parameters may be used for initial slot acquisition and slot maintenance. For example synchronization window size and required synchronization pulse height may differ.

NOTE 2: The time of the derived synchronization pulse maybe used to adjust the PP reference timer.

NOTE 3: One correlator can detect and distinguish the related PP and RFP synchronization words (see subclause 4.6).

- c) deliver the D-field data to the MAC layer.

NOTE 4: The size of the D-field depends on the specified physical channel.

- d) optionally report the frequency error of the received channel to the MAC layer.

NOTE 5: This is used by an RFP to operate frequency control of PPs.

- e) report sliding collision information to the MAC layer. This is optional subject to mandatory requirements of profiles.

NOTE 6: It is not mandatory to understand the Z-field or to have the receiver active to receive it, except when mandated in a profile. The Z-field is compared with the X-field in order to detect Z-field errors.

Whether or not a Z-field is transmitted could be detected by 2 consecutive receptions of "Z-field = X-field" during the first 8 frames of a bearer transmission. Sliding collision information parameters could be "Zack" if Z = X, "Znack" if Z not equal to X, and "Zno" if the Z-field is not transmitted. Collision at the beginning of a slot can be detected by monitoring errors in the synchronization field and could be reported e.g. as "SN", where N is the number of consecutive error free bits in the last part of the preamble of the S-field, or report deviation from a "stable" N.

NOTE 7: When sliding collision indication using the Q1 bit is sent from the RFP to the PP, Q1 may be set to 1, e.g. if there are errors in the S-field or the-Z field, while the A-field is correct (see EN 300 175-3 [2], annex F).

8.3 Measurement of signal strength

On receipt of a PL_ME_SIG_STR-req primitive, the physical layer measures the signal strength on the requested physical channel.

When using this primitive, the signal strength is the peak value obtained from a circuit with a time constant of between 10 μ s and 40 μ s.

The peak measurement shall extend over the complete packet (packet P00, P32 or P08j depending upon the intended use) and should also include a pre-packet interval of at least 10 μ s and a post-packet interval of at least 10 μ s.

The signal strength is integrated over a bandwidth of nominally 1 MHz centred on the received RF carrier centre frequency.

The measurement for traffic channel selections should include the prolonged preamble when the prolonged preamble is supported by FT and PT (see EN 300 175-3 [2], subclause 7.2.3.5.2.2).

8.4 Synchronization pulse detection

When the PHL receives a PL_ME_SYNC-req primitive, the PHL searches for a valid synchronization pulse.

8.5 Timing adjustment

When the PHL receives a PL_ME_TIME_ADJ-req primitive, it may adjust the length of the next frame by the requested amount.

8.6 Frequency adjustment

The PHL may receive a PL_FREQ_ADJ-req primitive in order to adjust its local oscillator. The PHL may react upon this primitive by adjusting its oscillator. Adjusting the oscillator shall be done within 30 ms after transmission of the PL-FREQ_ADJ message by the FT.

If this function is not supported the PHL may issue a PL_FREQ_ADJ-cfm primitive.

NOTE: The PL-FREQ_ADJ message is defined in EN 300 175-3 [2].

9 Management entity procedures related to PHL

9.1 List of quietest physical channels

Using the signal strength measurements obtained with the PL_ME_SIG_STR primitives, the LLME produces an ordered list of least interfered channels.

The resolution of the signal strengths is specified in subclause 6.2.

Physical channels with actual signal strengths that differ by less than this resolution may be listed in any order.

Physical channels with actual signal strengths that differ by greater than this resolution shall be listed in their actual order.

NOTE: This subclause does not prevent a PP or RFP from considering the interference on physical channel pairs.

9.2 Physical channels with greatest field strength (PP only)

Using the signal strength measurements obtained with the PL_ME_SIG_STR primitives, the LLME in a PP produces an ordered list of physical channels with the greatest signal strength.

The resolution of the signal strengths is specified in subclause 6.2.

Physical channels with actual signal strengths that differ by less than this resolution may be listed in any order.

Physical channels with actual signal strengths that differ by greater than this resolution shall be listed in their actual order.

NOTE: This information is used with higher layer information to identify the strongest RFPs.

9.3 Extract timing

Using the PL_ME_SYNC primitives, and interworking with higher layer detection of slot numbers, the LLME shall establish the slot and frame timing.

Annex A (normative): RF safety requirements

The contents of this annex is based on the following documents:

ICNIRP, "Guidelines for limiting exposure to time-varying electric, magnetic, and electromagnetic fields (up to 300 GHz)", International Commission on Non-Ionizing Radiation Protection (ICNIRP), Health Physics, vol. 74, pp 494-522, April 1998.

CENELEC ENV 50166-2, "Human exposure to electromagnetic fields: High frequency (10 kHz – 300 GHz)", European Prestandard, European Committee for Electrotechnical Standardization (CENELEC), January 1995.

A.1 Recommendation

In areas accessible for the general public, the RF exposure should not exceed the power density reference level at 1800 MHz, which is 9 W/m^2 averaged over a period of 6 minutes. The reference level can be exceeded if the basic SAR (Specific Absorption Rate, W/kg) restrictions are met. The SAR requirements are:

- a) the whole-body averaged SAR should not exceed 0,08 W/kg;
- b) the localized SAR averaged over any 10 gram of tissue should not exceed 2,0 W/kg, except for the limbs (arms, legs, hands, feet), where the maximum SAR is 4,0 W/kg;

All of the SAR limits are averaged over 6 minutes.

A.2 Safety distances

Safety distance means the minimum recommended distance of any part of the body to the antenna.

In any exposure situation, SAR is directly proportional to the mean output power from the antenna. For low-power devices like DECT equipment, the safety distances are therefor very short, usually less than a few centimetres. This is true for both low- and high-gain antennas. Since high-gain antennas have larger size and lower near-field exposure levels, the SAR levels are usually lower than for low-gain antennas.

The following safety distances are recommended for DECT equipment:

- a) Portable part (PP). The maximum average power is 10 mW (RMS). At this level the whole-body and localized SAR limits can not be exceeded and no safety distance is needed.
- b) Radio Fixed Part (RFP) (residential). The maximum average power is typical no more than 60 mW (RMS) (6 simultaneous transmissions). At this level the whole-body and localized SAR limits can not be exceeded and no safety distance is needed.
- c) Radio Fixed Part (RFP) (general). The maximum average power is 250 mW (RMS). At such low power level, the whole-body averaged SAR limit can not be exceeded. For most types of antennas, the localized partial-body SAR is also well below the limits at all distances. This can be confirmed by SAR measurements. If such measurements have not been conducted, a safety distance of 5 cm should be used.

Annex B (normative): Synchronization port

B.1 General requirements

Synchronization between adjacent systems can allow to optimize the use of the radio resources and to improve the performance of the synchronized systems.

Two synchronization classes are defined:

- Class 1 is intended for mutually increased traffic capacity of adjacent systems by aligning guard bands. This Class provides frame synchronization;
- Class 2 is intended for the case when handover has to be provided between the systems. This Class provides frame and multiframe synchronization. Primary receiver Scan Carrier Number (PSCN) and MultiFrame Number (MFN) synchronization is optional (see EN 300 175-5 [4] for more information about the possible synchronization levels).

Depending on the application, either the Class 1 or the Class 2 requirements can be met.

For a RFP, T_0 is defined as the nominal time (see subclause 4.2.3) when the start of bit p0 of a packet occurs or should occur at the antenna of this RFP, if being transmitted on slot $K = 0$.

T_0 of every RFP belonging to the mutually synchronized FPs shall occur T_t μ s after the reference synchronization signal, where:

- $T_t = 15 \pm 5$ μ s for Class 1;
- $T_t = 15 \pm 2$ μ s for Class 2.

The reference synchronization signal is generated internally to the FP in case of "Master" FP, or is generated externally to the FP in case of "Slave" FP.

Several synchronization methods can be used to meet the above mentioned requirements. This annex defines the following two:

- wired synchronization ports;
- GPS synchronization.

B.2 Wired synchronization ports

A cable is used to carry the reference synchronization signal between a Master FP, which generates the signal, and a Slave FP, which receives the signal externally. The synchronization ports consist of an external input port "SYNC IN" and an external output port "SYNC OUT" conformed to the V11 electrical recommendation (see EIA-RS422-A-78 [17]).

Figure B.1 shows a block description of this configuration.

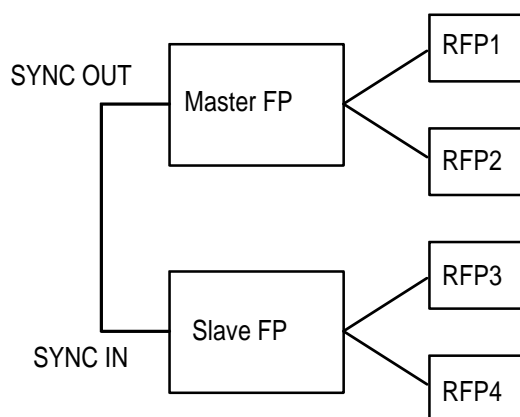

Figure B.1: Synchronization ports configuration

The Slave FP shall monitor the external synchronization input port for a valid input synchronization signal. If a valid synchronization signal is detected at the SYNC-IN, the Slave FP shall regenerate the signal at its SYNC-OUT. The propagation delay in the regenerated signal between the input and output synchronization ports shall not exceed 200 ns. The propagation delay shall be measured at the zero crossing points of the differential input and output signals. The regeneration circuit should incorporate input hysteresis (the difference between positive going and negative going input threshold voltages) of nominally 50 mV.

The transition times of the synchronization signal at the output synchronization port, either generated or regenerated within the FP, from the 10 % to 90 % points and from the 90 % to 10 % points shall not exceed 120 ns when measured into a $100 \Omega \pm 10 \%$ load (see figure B.2).

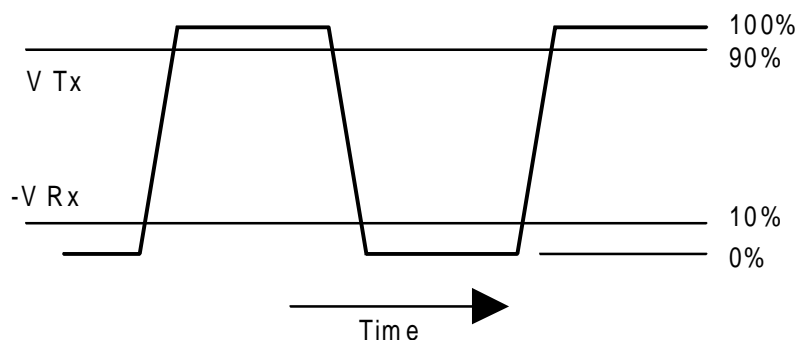

Figure B.2: Transition timing of synchronization signal

B.2.1 Synchronization signal

The synchronization signal illustrated in figure B.3 is a 100 Hz signal having positive pulses of width between $5 \mu\text{s}$ and 1 ms, except for frame 0 (every 16th pulse), which has a pulse width between 2 ms and 5 ms. This signal establishes the 10 ms DECT frame interval and the 160 ms DECT multiframe interval.

The synchronization signal shall have a long term frequency accuracy of better than ± 5 ppm (nominal conditions) or ± 10 ppm (extreme conditions).

As the wave form is asymmetric, devices can establish proper timing relations in the event that the differential pair of input signal wires is (improperly) connected (pair inversion).

The random phase jitter on the falling edge of the synchronization signal shall not exceed $0,5 \mu\text{s}$ rms. The differential amplitude shall be greater than 400 mV peak to peak.

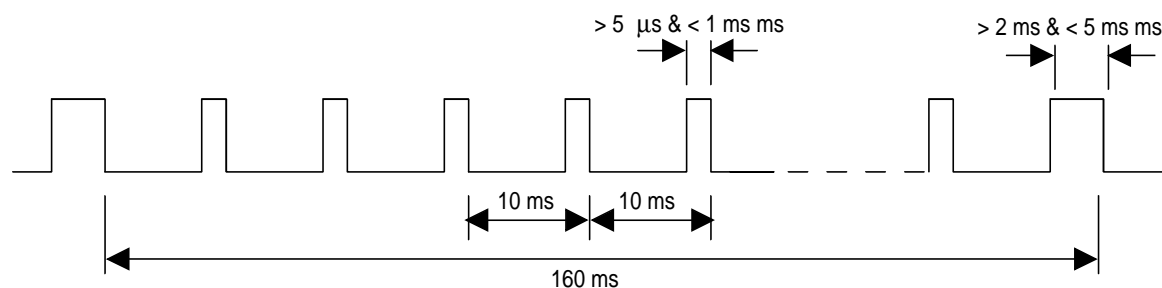

Figure B.3: Synchronization signal timing

T_0 of every RFP belonging to the Master FP shall occur T_t μ s after the rear falling edge of the transmitted synchronization pulse occurs at the output synchronization port. T_0 of every RFP belonging to the Slave FP shall occur T_t μ s after the rear falling edge of the received synchronization pulse occurs at the input synchronization port. Where:

- $T_t = 15 \mu\text{s} \pm 5 \mu\text{s}$ for Class 1;
- $T_t = 15 \mu\text{s} \pm 2 \mu\text{s}$ for Class 2.

For Class 2 synchronized systems, it may be needed to use the signal described in figure B.3 to achieve also the PSCN synchronization. PSCN defines the radio frequency carrier on which one receiver will be listening on the next frame when only one receiver is idle (see EN 300 175-3 [2]).

In such a case, every Xth multiframe pulse shall have a width between 4 ms and 5 ms. The falling edge of this pulse shall mark the start of a new scanning radio frequency cycle: at the reception of this marker, every RFP of the synchronized FP shall start scanning from the highest radio frequency. All the other multiframe pulses shall have a width between 2 ms and 3 ms.

The number X of required multiframes depends on the number of carriers N_C used by the FPs according to the following rule:

$$X = N \frac{MCM(16, N_C)}{16}$$

Where N is an integer ≥ 1 and $MCM(16; N_C)$ denotes the Minimum Common Multiple between 16 and N_C .

NOTE: PSCN synchronization is possible only between FPs which are at least multiframe synchronized and if they use the same set of radio frequency carriers.

The introduction of the PSCN synchronization pulses is optional.

B.3 GPS synchronization

The signal transmitted by a Global Positioning System (GPS) satellite indicates the GPS time, which is related but not equal to the Universal Time Coordinated (UTC). The GPS time should be considered as the standard time of the GPS system.

In contrast with the UTC, the GPS time is not subject to leaped seconds. The GPS time provides an absolute time reference. This makes the GPS receiver time suitable for multiframe synchronization of DECT systems. MFN synchronization and PSCN synchronization are also derivable.

A FP can broadcast the information that it is GPS synchronized by setting a dedicated bit of the Extended Fixed Part Capabilities message (see EN 300 175-5 [4], annex F).

The GPS receiver can either be integrated in the FP (FP Master) or can be an external device (Slave FP).

Figures B.4 and B.5 show a block description of these two configurations.

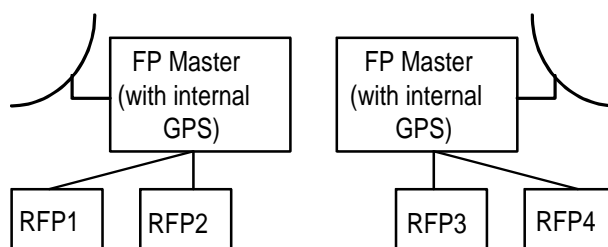

Figure B.4: Internal GPS receiver configuration

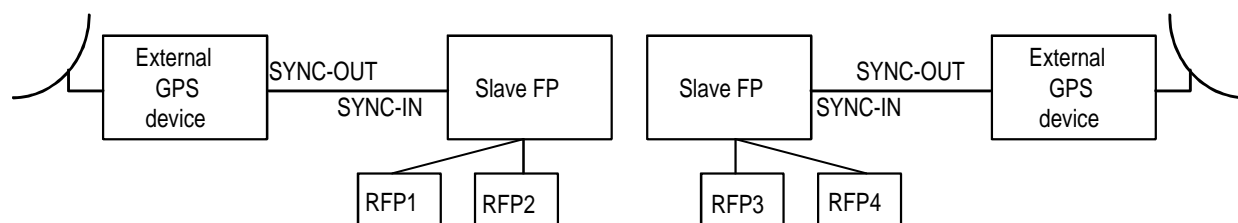

Figure B.5: External GPS receiver configuration

The configuration solution with the GPS receiver integrated in the FP may also provide a wired synchronization output port which can be used for test purposes or to synchronize a Slave FP.

Figure B.6 shows the block description of this configuration.

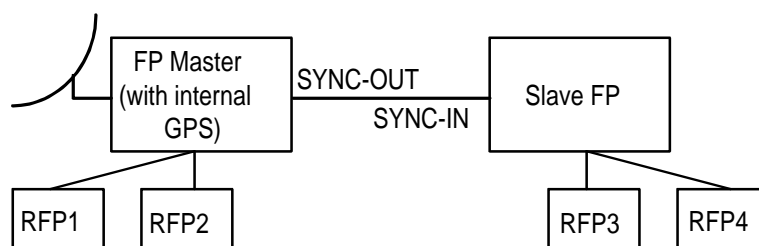

Figure B.6: Internal GPS receiver plus output synchronization port configuration

B.3.1 Synchronization signal

The synchronization signal and the T_0 time, in respect to this signal, of the synchronized RFPs are described in subclause B.2.1.

B.3.2 DECT timings derivation from the GPS time

DECT systems are synchronized by relating the start of the first frame of a multiframe to the GPS time. Since the time duration of a DECT multiframe is 160 ms, this implies that once every 4 s the start of a DECT multiframe coincides with an integer GPS second. For convenience, this is called a DECT hyperframe. The DECT hyperframe has a duration of 4 s and contains 25 DECT multiframe.

The logical relation between the DECT timings and the GPS time is described in Figure B.7.

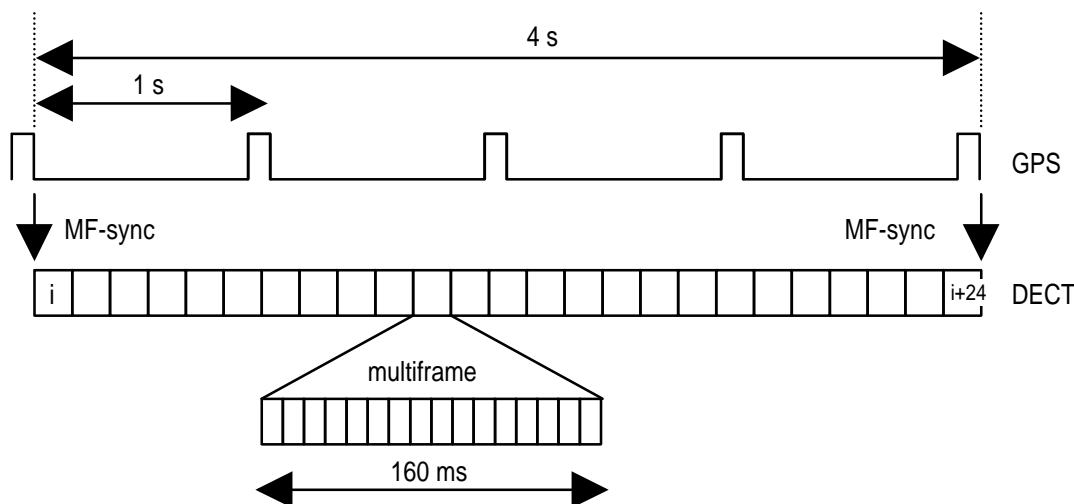

Figure B.7: Logical relation between DECT and GPS timings

The reference synchronization signal coincides with the falling edge of the GPS second pulse when $T_{GPS} \bmod 4 = 0$.

This marks the start of a DECT hyperframe.

B.3.2.1 DECT multiframe number synchronization using GPS

Multiframe number synchronization can only be established between two adjacent systems if they are also multiframe synchronized. The multiframe number of the first multiframe of a DECT hyperframe (starting at $T_{GPS} \bmod 4 = 0$) shall be related to the corresponding GPS time as follows:

$$MFN = \left(\frac{25}{4} T_{GPS} \right) \bmod 2^{24}$$

NOTE: The multiframe number consists of 24 bits in a MAC Q_T message (EN 300 175-3 [2], subclause 7.2.3.7).

B.3.2.2 DECT PSCN synchronization using GPS

PSCN synchronization can be achieved by relating the PSCN synchronization pulse (see subclause B.2.1) to an integer N_H multiple of DECT hyperframe pulses (see subclause B.3.2). Assuming that N_C carriers are being used by the system, this implies that all N_C carriers are scanned within a sequence of N_C frames (one carrier per frame). Since a hyperframe contains 400 frames, the minimum number of hyperframes at which the PSCN sequence repeats itself is given by:

$$N_H = \frac{N_C}{LCD(N_C, 400)}$$

where the notation $LCD(N_C, 400)$ denotes the Largest Common Denominator of N_C and 400.

When using GPS for synchronization of the PSCN, the PSCN of the first frame of the hyperframe starting at $T_{GPS} \bmod (4 \cdot N_H) = 0$ shall be equal to the RF carrier number corresponding with the highest carrier frequency used by the system. Currently only 10 carriers in the frequency band 1880 - 1900 MHz are applied so $N_C = 10$ and $RF=0$ (see EN 300 175-3 [2], subclause 7.2.3.2.12).

EXAMPLE 1: $N_C = 10$, Carrier no. 0 - 9. (current situation):

$N_H = 1$; In the first frame of each hyperframe at $T_{GPS} \bmod 4 = 0$, PSCN shall be equal to 0. It takes a maximum of 4 seconds before the PSCN can be synchronized.

EXAMPLE 2: $N_C = 13$, Carrier no. 17 - 29 (fictitious future situation):

$N_H = 13$; In the first frame of each hyperframe at $T_{GPS} \bmod 52 = 0$ PSCN shall be equal to 29. It takes a maximum of 52 seconds before the PSCN can be synchronized.

B.4 Guidance for installation

B.4.1 Interconnection cable

Where interconnecting cable is used to provide synchronization between systems or devices to be synchronized, it shall provide two independent signal paths, neither of which is grounded. The type and length of interconnecting cable used for synchronization shall ensure that during the transition period, the signal wave form (measured at the input synchronization port) shall change monotonically between the 10 % and 90 % points and shall not cross the 10 % and 90 % thresholds again until the next state transition point. The interconnection cable shall ensure that the input signal meets the requirements of subclause B.2.1.

B.4.2 Propagation delay of synchronization signals

B.4.2.1 Calculation of Propagation delay (informative)

The purpose of this informative subclause is to show a derivation of the maximum synchronization signal propagation delay, and to illustrate the trade off between the number of devices which may be connected in a cluster and the total length of interconnecting cable.

Let the maximum propagation delay of the synchronization signal from the first device in a cluster to the final device be D_{max} . The time D_{max} is derived as follows:

$$D_{max} = G - J - S - T$$

Where:

G = guard time;

J = portable timing jitter;

S = synchronization accuracy;

T = ramp down time.

The maximum number of regenerations, R_{max} , with no cable delay is:

$$R_{max} = \frac{D_{max}}{T_{reg}}$$

Where T_{reg} = regeneration delay in a device (= 200 ns, see clause B.2).

The maximum cable length, L_{max} , with no regenerations, is given by:

$$L_{max} = C * VF * D_{max}$$

Where:

C = speed of light (= 3×10^8 metres per second);

VF = cable velocity factor (= in the range 0,6 to 0,7).

This calculation indicates the maximum total length of cable between two devices to be synchronized. The maximum practical length for an individual section of cable between two devices will also be restricted by transmission line effects (see subclause B.4.1).

Neither the maximum cable length nor the maximum number of regenerations derived above will be achievable in any practical system. There will always be a trade-off between the number of synchronized devices or systems (i.e. regenerations) and the length of cable needed to interconnect them.

B.4.2.2 Delay compensation

In order to compensate for installation dependent synchronization signal delays (e.g. as a result of cable propagation delays) between devices to be synchronized, it is recommended that it be possible for slave devices to be capable of adjusting T_t (see clause B.1) between 0 and 20 μs to a resolution of at least $\pm 1 \mu\text{s}$. Means of making this timing adjustment shall be provided by Class 2 equipment.

B.4.3 GPS receiver stability

In order to provide synchronous external handover, it is recommended that the time accuracy of the GPS receiver should be at least within $\pm 1 \mu\text{s}$ from the logical T_{GPS} time.

Annex C (normative): Prolonged preamble

Implementing this provision is optional.

Prolonged preamble transmissions are intended to be used in combination with a preamble switched antenna instant receiver selection diversity algorithm implemented at the receiving end. This algorithm implies that the receiver during a first part of the preamble makes a first link quality estimate using one antenna, and during a second part makes a second estimate using the other antenna, and then, for a third (the last) part of the preamble and the rest of the packet, selects the antenna which gave the highest quality estimate. This algorithm can provide a performance improvement corresponding to 10 dB increased link budget in a mobile or moving environment. Traditional means to provide this performance improvement requires two complete radio receivers. The prolonged preamble helps implementing low-cost and efficient means for the quality estimates needed in the algorithm.

NOTE 1: Normal procedures carried out during the preamble when this algorithm is implemented will thus be sliding slot detection, bit synchronization, two quality estimations and two antenna switchings.

NOTE 2: The M_T "Quality control" advance timing command message is intended to facilitate the implementation of the prolonged preamble option for distances beyond 1 km (see EN 300 175-3 [2] subclause 7.2.5.5, command 0110).

C.1 Bit pattern

The extension of the preamble is 16 bits, s-16 to s-1, and the bit pattern is a continuous advance extension of the bit patterns defined for the preamble in subclause 4.6, Synchronization field S.

RFP transmissions: 1010 1010 1010 1010
 s-16 s-1

PP transmissions: 0101 0101 0101 0101
 s-16 s-1

C.2 The power-time template

Packets with prolonged preamble are subject to the definitions and requirements of subclauses 5.1 and 5.2 with the notation p0 generally changed to p-16.

Annex D (normative): 4-level/8-level modulation option

Equipment is allowed to use 4-level and/or 8-level modulation in addition to 2-level modulation. This will increase the bit rate of single radio DECT equipment by a factor 2 or 3, which allows for 2 Mbit/s services. For example, the asymmetric double-slot service with modulation configuration 3 (see Table D.1) will provide up to 2.640 Mbit/s B-field data rate and up to 2.112 Mbit/s data rate in a protected LU7 type application [4].

The 4-level modulation shall be $\pi/4$ -DQPSK and the 8-level modulation $\pi/8$ -D8PSK as defined in clauses D.2 and D.3. It is only allowed to use 4-level and/or 8-level modulation in the B+Z or the A+B+Z fields [3], whereby the S+A or the S field respectively shall use the $\pi/2$ -DBPSK 2-level modulation as defined in clause D.1. The allowed combinations of modulation schemes are defined in Table D.1.

Table D.1: Allowed combinations of modulation schemes

Configuration	S -field	A-field	B+Z-field
1a	GFSK	GFSK	GFSK
1b	$\pi/2$ -DBPSK	$\pi/2$ -DBPSK	$\pi/2$ -DBPSK
2	$\pi/2$ -DBPSK	$\pi/2$ -DBPSK	$\pi/4$ -DQPSK
3	$\pi/2$ -DBPSK	$\pi/2$ -DBPSK	$\pi/8$ -D8PSK
4a	$\pi/2$ -DBPSK	$\pi/4$ -DQPSK	$\pi/4$ -DQPSK
4b	$\pi/2$ -DBPSK	$\pi/8$ -D8PSK	$\pi/8$ -D8PSK

Configuration 1a is the basic DECT modulation scheme defined in subclause 5.4.

Equipment that is capable of operating in any of the configurations 2-4 shall also be able to operate in configuration 1 (1a or 1b). Such equipment shall in configuration 1a conform to all requirements of this EN that apply for equipment using the basic 1a configuration. Such equipment that does not support configuration 1a, shall in configuration 1b conform to all requirements of this EN that apply for equipment using the basic 1a configuration, with the exception for subclauses 5.4 "RF carrier modulation", 5.2.3 "Minimum power" and 5.2.4 "Maximum power". This implies that the receiver in configuration 1b shall be able to cope with the inaccuracies of a transmitter in configuration 1a. The requirements on RF carrier modulation, Minimum power and Maximum power for the 1b configuration are defined in clause D.1.

Additionally, if the equipment includes a radio transmitter capable of 4-level and/or 8-level modulation, the requirements of subclauses 5.3 "Transmitted power" and 5.5 "Unwanted RF power radiation" shall apply for the transmissions using the 4-level and/or 8-level modulation in the B+Z or A+B+Z fields. Receiver requirements are only applied for configuration 1, which however will have a rather direct impact on the performance also for configurations 2 – 4. Configurations 2 - 4 will with a digital receiver implementation typically meet the receiver sensitivity requirements of configuration 1. Additional sensitivity limits could be introduced in profile standards covering configurations 2, 3 and 4.

Procedures and messages for call set-up and switching between modulation schemes are defined in EN 300 175-3 [3].

Schemes 2 and 3 ensure that equipment with basic 2-level modulation, and equipment with a higher rate option, can efficiently share a common base station infrastructure. The GFSK modulation can be detected for instance in a non-coherent $\pi/2$ -DPSK receiver, and the $\pi/2$ -DPSK modulation can be detected in a GFSK receiver. Therefore all A-field information including broadcast system information, paging and call control can be received independently of whether configuration 1, 2 or 3 is used.

Default modulation scheme for ETSI profiles is the 2 level modulation scheme, unless otherwise stated in that profile standard. Equipment conforming to an ETSI profile shall use the default modulation scheme for the A-fields.

The RF carrier accuracy and reference timer stability requirements of subclauses 4.1 and 4.2 apply. The specified modulation accuracy requirements below allow for implementation of coherent detection and also equalization if desired, whereby the 2-level modulation in the S and A field of every slot gives suitable provision for the required carrier tracking for interoperability of profile equipment.

D.1 The $\pi/2$ -DBPSK modulation scheme

D.1.1 RF carrier modulation

The shaping filter shall be root-raised cosine with $T_s = 1/1152000$ s (T_s = symbol duration) and $\alpha = 0,5$ (α = roll-off time), the same as for the $\pi/4$ -DQPSK modulation scheme.

The $\pi/2$ -DBPSK modulation scheme has been chosen so that the $\pi/2$ -DBPSK modulation scheme states is a subset of the $\pi/4$ -DQPSK modulation scheme states.

Considering B_k as the bits of the binary data stream, the in-phase and quadrature components of an unfiltered carrier are given by:

$$\begin{aligned} I_k &= -Q_{k-1} \sin(\Delta\Phi(B_k)) \\ Q_k &= I_{k-1} \sin(\Delta\Phi(B_k)) \end{aligned}$$

The phase change shall be determined from Table D.2.

Table D.2

B_k	$\Delta\Phi$
0	$-\pi/2$
1	$+\pi/2$

D.1.1.1 Modulation accuracy

Modulation accuracy is the actual value of the vector error which is the square root of the sum of the squares of the errors of the vectors divided by the number of symbols in the slot.

The vector error magnitude shall be less than 0,125 in any slot.

D.1.2 Transmission of physical packets

The requirements of clause 5 shall be met with the exception that the lower limit of the instantaneous power (subclause 5.2.3) shall be NTP – 6 dB, and the upper limit of the instantaneous power (subclause 5.2.4) shall be NTP + 4 dB.

D.2 The $\pi/4$ -DQPSK modulation scheme

D.2.1 RF carrier modulation

The shaping filter shall be root-raised cosine with $T_s = 1/1152000$ s (T_s = symbol duration) and $\alpha = 0,5$ (α = roll-off time).

The binary stream is converted into two separate binary data streams with all even numbered bits forming stream X_k and all odd numbered bits forming stream Y_k . The in-phase and quadrature components of an unfiltered carrier are given by:

$$\begin{aligned} I_k &= I_{k-1} \cos(\Delta\Phi(X_k, Y_k)) - Q_{k-1} \sin(\Delta\Phi(X_k, Y_k)) \\ Q_k &= I_{k-1} \sin(\Delta\Phi(X_k, Y_k)) + Q_{k-1} \cos(\Delta\Phi(X_k, Y_k)) \end{aligned}$$

The phase change shall be Gray encoded as determined from Table D.3.

Table D.3

X _k	Y _k	ΔΦ
1	1	-3π/4
0	1	+3π/4
0	0	+π/4
1	0	-π/4

D.2.1.1 Modulation accuracy

Modulation accuracy is the actual value of the vector error which is the square root of the sum of the squares of the errors of the vectors divided by the number of symbols in the slot.

The vector error magnitude shall be less than 0,125 in any slot.

D.2.2 Transmission of physical packets

The requirements of clause 5 shall be met with the exception that the lower limit of the instantaneous power (subclause 5.2.3) shall be NTP – 14 dB, and the upper limit of the instantaneous power (subclause 5.2.4) shall be NTP +4 dB.

D.3 The π/8-D8PSK modulation scheme

D.3.1 RF carrier modulation

The shaping filter shall be root-raised cosine with $T_s = 1/1152000$ s (T_s = symbol duration) and roll-off (α) = 0,5, the same as for the π/4-DQPSK modulation scheme.

The π/8-D8PSK modulation scheme has been chosen so that the π/4-DQPSK modulation scheme states is a subset of the π/8-D8PSK modulation scheme states.

The binary stream is divided into consecutive 3-bit packets. The packets are converted into three binary data streams (X_k, Y_k, Z_k). The stream X_k is built up from the first bit of each packet, the stream Y_k is built up from the second bit of each packet and the stream Z_k is built up from the third bit of each packet.

$$I_k = I_{k-1} \cos(\Delta\Phi(X_k, Y_k, Z_k)) - Q_{k-1} \sin(\Delta\Phi(X_k, Y_k, Z_k))$$

$$Q_k = I_{k-1} \sin(\Delta\Phi(X_k, Y_k, Z_k)) + Q_{k-1} \cos(\Delta\Phi(X_k, Y_k, Z_k))$$

Table D.4

X _k	Y _k	Z _k	ΔΦ
0	0	0	π/8
0	0	1	3π/8
0	1	1	5π/8
0	1	0	7π/8
1	1	0	-7π/8
1	1	1	-5π/8
1	0	1	-3π/8
1	0	0	-π/8

D.3.1.1 Modulation accuracy

Modulation accuracy is the actual value of the vector error which is the square root of the sum of the squares of the errors of the vectors divided by the number of symbols in the slot.

The vector error magnitude shall be less than 0,06 in any slot.

D.3.2 Transmission of physical packets

The requirements of clause 5 shall be met with the exception that the lower limit of the instantaneous power (subclause 5.2.3) shall be NTP -22 dB, and the upper limit of the instantaneous power (subclause 5.2.4) shall be NTP +4 dB.

Bibliography

The following material, though not specifically referenced in the body of the present document (or not publicly available), gives supporting information.

- EN 300 175-7: "Digital Enhanced Cordless Telecommunications (DECT); Common Interface (CI); Part 7: Security features".
- EN 300 175-8: "Digital Enhanced Cordless Telecommunications (DECT); Common Interface (CI); Part 8: Speech coding and transmission".
- ETR 042: "Digital Enhanced Cordless Telecommunications (DECT); A Guide to DECT features that influence the traffic capacity and the maintenance of high radio link transmission quality, including the results of simulations".
- CEPT Recommendation T/SGT SF2 (89) 6/0: "Draft Recommendation T/SF Services and Facilities of Digital European Cordless Telecommunications".
- M.A. Stuchly (1987), Health Physics, Vol. 53, N° 6: "Proposed revision of the Canadian recommendations on radio frequency-exposure protection".

History

Document history		
Edition 1	October 1992	Publication as ETS 300 175-2
Edition 2	September 1996	Publication as ETS 300 175-2
V1.4.1	February 1998	Public Enquiry PE 9824: 1998-02-13 to 1998-06-12
V1.4.2	March 1999	Vote V 9921: 1999-03-23 to 1999-05-21