

Draft **ETSI EN 300 162-1** V1.4.1 (2005-05)

European Standard (Telecommunications series)

**Electromagnetic compatibility
and Radio spectrum Matters (ERM);
Radiotelephone transmitters and receivers for the
maritime mobile service operating in VHF bands;
Part 1: Technical characteristics
and methods of measurement**



ReferenceREN/ERM-TG26-071-1

KeywordsEMC, GMDSS, maritime, radio, telephony,
testing, VHF**ETSI**

650 Route des Lucioles
F-06921 Sophia Antipolis Cedex - FRANCE

Tel.: +33 4 92 94 42 00 Fax: +33 4 93 65 47 16

Siret N° 348 623 562 00017 - NAF 742 C
Association à but non lucratif enregistrée à la
Sous-Préfecture de Grasse (06) N° 7803/88

Important notice

Individual copies of the present document can be downloaded from:

<http://www.etsi.org>

The present document may be made available in more than one electronic version or in print. In any case of existing or perceived difference in contents between such versions, the reference version is the Portable Document Format (PDF). In case of dispute, the reference shall be the printing on ETSI printers of the PDF version kept on a specific network drive within ETSI Secretariat.

Users of the present document should be aware that the document may be subject to revision or change of status. Information on the current status of this and other ETSI documents is available at

<http://portal.etsi.org/tb/status/status.asp>

If you find errors in the present document, please send your comment to one of the following services:

http://portal.etsi.org/chaicor/ETSI_support.asp

Copyright Notification

No part may be reproduced except as authorized by written permission.
The copyright and the foregoing restriction extend to reproduction in all media.

© European Telecommunications Standards Institute 2005.
All rights reserved.

DECT™, **PLUGTESTS™** and **UMTS™** are Trade Marks of ETSI registered for the benefit of its Members.
TIPHON™ and the **TIPHON logo** are Trade Marks currently being registered by ETSI for the benefit of its Members.
3GPP™ is a Trade Mark of ETSI registered for the benefit of its Members and of the 3GPP Organizational Partners.

Contents

Intellectual Property Rights	8
Foreword.....	8
1 Scope	9
2 References	9
3 Definitions, symbols and abbreviations	10
3.1 Definitions	10
3.2 Symbols.....	10
3.3 Abbreviations	10
4 General and operational requirements.....	10
4.1 Construction	10
4.2 Controls and indicators.....	11
4.3 Handset and loudspeaker.....	12
4.4 Safety precautions	12
4.5 Labelling.....	12
4.6 Warm up.....	13
5 Technical requirements	13
5.1 Switching time.....	13
5.2 Class of emission and modulation characteristics	13
5.3 Multiple watch facilities	13
5.3.1 Additional performance standards	13
5.3.2 Scanning characteristics.....	14
5.4 DSC controller interfaces	14
5.4.1 Operational interfaces	14
6 General conditions of measurement	14
6.1 Arrangements for test signals applied to the receiver input.....	14
6.2 Squelch.....	14
6.3 Normal test modulation	15
6.4 Artificial antenna.....	15
6.5 Arrangements for test signals applied to the transmitter input	15
6.6 Test channels	15
6.7 Measurement uncertainty and interpretation of the measured results	15
6.7.1 Measurement uncertainty.....	15
6.7.2 Interpretation of the measurement results	16
6.8 Test conditions, power sources and ambient temperatures.....	16
6.8.1 Normal and extreme test conditions.....	16
6.8.2 Test power source	16
6.9 Normal test conditions.....	16
6.9.1 Normal temperature and humidity	16
6.9.2 Normal power sources	16
6.9.2.1 Mains voltage and frequency	16
6.9.2.2 Battery power source.....	17
6.9.2.3 Other power sources.....	17
6.10 Extreme test conditions	17
6.10.1 Extreme temperatures	17
6.10.2 Extreme values of test power sources	17
6.10.2.1 Mains voltage.....	17
6.10.2.2 Battery power source.....	17
6.10.2.3 Other power sources.....	17
6.11 Procedure for tests at extreme temperatures.....	17
7 Environmental tests	18
7.1 Procedure.....	18
7.2 Performance check	18

7.3	Vibration test	18
7.3.1	Definition	18
7.3.2	Method of measurement	18
7.3.3	Requirement.....	19
7.4	Temperature tests	19
7.4.1	Definition	19
7.4.2	Dry heat	19
7.4.2.1	Definition	19
7.4.2.2	Method of measurement.....	19
7.4.2.3	Requirement	19
7.4.3	Damp heat.....	19
7.4.3.1	Definition	19
7.4.3.2	Method of measurement.....	20
7.4.3.3	Requirement	20
7.4.4	Low temperature cycle.....	20
7.4.4.1	Definition	20
7.4.4.2	Method of measurement.....	20
7.4.4.3	Requirement	20
8	Transmitter	20
8.1	Frequency error	20
8.1.1	Definition.....	20
8.1.2	Method of measurement	20
8.1.3	Limits.....	21
8.2	Carrier power.....	21
8.2.1	Definitions	21
8.2.2	Method of measurement	21
8.2.3	Limits.....	21
8.2.3.1	Normal test conditions	21
8.2.3.2	Extreme test conditions	21
8.3	Frequency deviation	21
8.3.1	Definition.....	21
8.3.2	Maximum permissible frequency deviation.....	21
8.3.2.1	Method of measurement.....	21
8.3.2.2	Limits	22
8.3.3	Reduction of frequency deviation at modulation frequencies above 3 kHz.....	22
8.3.3.1	Method of measurement.....	22
8.3.3.2	Limits	22
8.4	Sensitivity of the modulator, including microphone	23
8.4.1	Definition.....	23
8.4.2	Method of measurement	23
8.4.3	Limits.....	23
8.5	Audio frequency response	23
8.5.1	Definition.....	23
8.5.2	Method of measurement	24
8.5.3	Limit	24
8.6	Audio frequency harmonic distortion of the emission.....	24
8.6.1	Definition.....	24
8.6.2	Method of measurement	24
8.6.2.1	Normal test conditions	25
8.6.2.2	Extreme test conditions	25
8.6.3	Limits.....	25
8.7	Adjacent channel power	25
8.7.1	Definition.....	25
8.7.2	Method of measurement	25
8.7.3	Limits.....	26
8.8	Conducted spurious emissions conveyed to the antenna.....	26
8.8.1	Definition.....	26
8.8.2	Method of measurement	26
8.8.3	Limit	26
8.9	Cabinet radiation and conducted spurious emissions other than those conveyed to the antenna	26
8.9.1	Definitions	26

8.9.2	Method of measurement	26
8.9.3	Limits.....	27
8.10	Residual modulation of the transmitter	27
8.10.1	Definition.....	27
8.10.2	Method of measurement	27
8.10.3	Limit	28
8.11	DSC audio input characteristics	28
8.11.1	Definition.....	28
8.11.2	Method of measurement	28
8.11.3	Limits.....	28
8.12	DSC audio input limitation.....	28
8.12.1	Definition.....	28
8.12.2	Method of measurement	28
8.12.3	Limit	28
8.13	Modulation attack time.....	29
8.13.1	Definition.....	29
8.13.2	Method of measurement	29
8.13.3	Limit	29
8.14	Transient frequency behaviour of the transmitter.....	30
8.14.1	Definitions	30
8.14.2	Method of measurement	30
8.14.3	Limits.....	33
9	Receiver.....	33
9.1	Harmonic distortion and rated audio frequency output power	33
9.1.1	Definition.....	33
9.1.2	Methods of measurement.....	33
9.1.3	Limits.....	34
9.2	Audio frequency response	34
9.2.1	Definition.....	34
9.2.2	Method of measurement	34
9.2.3	Limits.....	34
9.3	Maximum usable sensitivity.....	35
9.3.1	Definition.....	35
9.3.2	Method of measurement	35
9.3.3	Limits.....	36
9.4	Co-channel rejection.....	36
9.4.1	Definition.....	36
9.4.2	Method of measurement	36
9.4.3	Limit	36
9.5	Adjacent channel selectivity.....	36
9.5.1	Definition.....	36
9.5.2	Method of measurement	36
9.5.3	Limits.....	37
9.6	Spurious response rejection.....	37
9.6.1	Definition.....	37
9.6.2	Method of measurement	37
9.6.3	Limit	37
9.7	Intermodulation response	37
9.7.1	Definition.....	37
9.7.2	Method of measurement	38
9.7.3	Limit	38
9.8	Blocking or desensitization	38
9.8.1	Definition.....	38
9.8.2	Method of measurement	38
9.8.3	Limit	38
9.9	Conducted spurious emissions	38
9.9.1	Definition.....	38
9.9.2	Method of measurement	39
9.9.3	Limit	39
9.10	Radiated spurious emissions.....	39
9.10.1	Definition.....	39

9.10.2	Method of measurements	39
9.10.3	Limit	40
9.11	Receiver noise and hum level.....	40
9.11.1	Definition.....	40
9.11.2	Method of measurement	40
9.11.3	Limit	41
9.12	Squelch operation	41
9.12.1	Definition.....	41
9.12.2	Method of measurement	41
9.12.3	Limits.....	41
9.13	Squelch hysteresis	41
9.13.1	Definition.....	41
9.13.2	Method of measurement	42
9.13.3	Limit	42
9.14	Multiple watch characteristic	42
9.14.1	Definition.....	42
9.14.2	Method of measurement	42
9.14.3	Limits.....	42
9.15	DSC audio output characteristic	42
9.15.1	Definition.....	42
9.15.2	Methods of measurement	43
9.15.3	Limit	43
10	Duplex operation	43
10.1	Receiver desensitization with simultaneous transmission and reception.....	43
10.1.1	Definition.....	43
10.1.2	Method of measurement	43
10.1.3	Limits.....	44
10.2	Duplex transceiver internal mixing	44
10.2.1	Definition.....	44
10.2.2	Method of measurement	44
10.2.3	Limits.....	44
Annex A (normative): Measuring receiver for adjacent channel power measurement.....		45
A.1	Power measuring receiver specification.....	45
A.1.1	IF filter	45
A.1.2	Attenuation indicator.....	46
A.1.3	RMS value indicator.....	46
A.1.4	Oscillator and amplifier.....	46
Annex B (normative): Protocol for the IEC 1162-1 commands Frequency Set Information (FSI)		47
B.1	Frequency Set Information (FSI)	47
Annex C (normative): Radiated measurements		48
C.1	Test sites and general arrangements for measurements involving the use of radiated fields	48
C.1.1	Outdoor test site	48
C.1.2	Test antenna.....	48
C.1.3	Substitution antenna	49
C.1.4	Optional additional indoor site	49
C.2	Guidance on the use of radiation test sites	50
C.2.1	Measuring distance.....	50
C.2.2	Test antenna.....	50
C.2.3	Substitution antenna	50
C.2.4	Artificial antenna.....	50
C.2.5	Auxiliary cables.....	51
C.2.6	Acoustic measuring arrangement	51
C.3	Further optional alternative indoor test site using an anechoic chamber	51
C.3.1	Example of the construction of a shielded anechoic chamber	51

C.3.2	Influence of parasitic reflections in anechoic chambers	52
C.3.3	Calibration of the shielded anechoic chamber	52
History	55

Intellectual Property Rights

IPRs essential or potentially essential to the present document may have been declared to ETSI. The information pertaining to these essential IPRs, if any, is publicly available for **ETSI members and non-members**, and can be found in ETSI SR 000 314: "*Intellectual Property Rights (IPRs); Essential, or potentially Essential, IPRs notified to ETSI in respect of ETSI standards*", which is available from the ETSI Secretariat. Latest updates are available on the ETSI Web server (<http://webapp.etsi.org/IPR/home.asp>).

Pursuant to the ETSI IPR Policy, no investigation, including IPR searches, has been carried out by ETSI. No guarantee can be given as to the existence of other IPRs not referenced in ETSI SR 000 314 (or the updates on the ETSI Web server) which are, or may be, or may become, essential to the present document.

Foreword

This European Standard (Telecommunications series) has been produced by ETSI Technical Committee Electromagnetic compatibility and Radio spectrum Matters (ERM), and is now submitted for the Public Enquiry phase of the ETSI standards Two-step Approval Procedure.

The present document is part 1 of a multi-part deliverable covering the Radiotelephone transmitters and receivers for the maritime mobile service operating in VHF bands, as identified below:

- Part 1: "Technical characteristics and methods of measurement";**
- Part 2: "Harmonized EN covering essential requirements of article 3.2 of the R&TTE Directive";
- Part 3: "Harmonized EN covering essential requirements of article 3.3 (e) of the R&TTE Directive".

Proposed national transposition dates	
Date of latest announcement of this EN (doa):	3 months after ETSI publication
Date of latest publication of new National Standard or endorsement of this EN (dop/e):	6 months after doa
Date of withdrawal of any conflicting National Standard (dow):	6 months after doa

1 Scope

The present document specifies the minimum requirements for shipborne Very High Frequency (VHF) transmitters and receivers capable of voice and Digital Selective Calling (DSC), fitted with an external antenna connector for use on board ships.

The present document lays down minimum requirements for VHF radio transmitters and receivers operating in certain frequency bands allocated to the maritime mobile service using both 25 kHz and 12,5 kHz channels, and incorporates the requirements of the relevant recommendations of the International Maritime Organization (IMO).

2 References

The following documents contain provisions which, through reference in this text, constitute provisions of the present document.

- References are either specific (identified by date of publication and/or edition number or version number) or non-specific.
- For a specific reference, subsequent revisions do not apply.
- For a non-specific reference, the latest version applies.

Referenced documents which are not found to be publicly available in the expected location might be found at <http://docbox.etsi.org/Reference>.

- [1] Radio Regulations (2004), appendix 18: "Table of transmitting frequencies in the VHF maritime mobile band".
- [2] ITU-T Recommendation E.161 (2001): "Arrangement of digits, letters and symbols on telephones and other devices that can be used for gaining access to a telephone network".
- [3] ITU-R Recommendation M.493-11 (2004): "Digital selective-calling system for use in the maritime mobile service".
- [4] ITU-R Recommendation M.541-9 (2004): "Operational procedures for the use of digital selective-calling equipment in the maritime mobile service".
- [5] IMO Resolution A.803(19): "Performance Standards for Shipborne VHF Radio Installations capable of Voice Communication and Digital Selective Calling".
- [6] IMO Resolution A.524(13): "Performance Standards for VHF Multiple Watch facilities".
- [7] ITU-T Recommendation O.41 (1994): "Psophometer for use on telephone-type circuits".
- [8] IEC 61162-1 (2000): "Maritime navigation and radiocommunication equipment and systems - Digital interfaces - Part 1: Single talker and multiple listeners".
- [9] ETSI TR 100 028-1 (V1.4.1): "Electromagnetic compatibility and Radio spectrum Matters (ERM); Uncertainties in the measurement of mobile radio equipment characteristics; Part 1".
- [10] ETSI EN 300 338: "Electromagnetic compatibility and Radio spectrum Matters (ERM); Technical characteristics and methods of measurement for equipment for generation, transmission and reception of Digital Selective Calling (DSC) in the maritime MF, MF/HF and/or VHF mobile service".
- [11] ITU-R Recommendation SM.332-4 (1978): "Selectivity of receivers".
- [12] ITU-R Recommendation M.1084-4 (2001): "Interim solutions for improved efficiency in the use of the band 156-174 MHz by stations in the maritime mobile service".

3 Definitions, symbols and abbreviations

3.1 Definitions

For the purpose of the present document, the following terms and definitions apply:

Channel 16: frequency of 156,800 MHz

G3E: phase-modulation (frequency modulation with a pre-emphasis of 6 dB/octave) for speech

G2B: phase-modulation with digital information, with a sub-carrier for Digital Selective Calling (DSC) operation

modulation index: ratio between the frequency deviation and the modulation frequency

performance check: check of:

- the transmitter carrier power and frequency; and
- receiver sensitivity (see clause 7.2).

3.2 Symbols

For the purposes of the present document, the following symbols apply:

dBA	dB relative to 2×10^{-5} Pa
emf	electromotive force
λ	lambda (wavelength)

3.3 Abbreviations

For the purposes of the present document, the following abbreviations apply:

ad	amplitude difference
DSC	Digital Selective Calling
EUT	Equipment Under Test
fd	frequency difference
FSI	Frequency Set Information
IMO	International Maritime Organization
RF	Radio Frequency
rms	root mean square
SINAD	Signal + Noise + Distortion/Noise + Distortion
VHF	Very High Frequency

4 General and operational requirements

4.1 Construction

The manufacturer shall declare that compliance to the requirement of clause 4 is achieved and shall provide relevant documentation.

The mechanical and electrical construction and finish of the equipment shall conform in all respects to good engineering practice, and the equipment shall be suitable for use on board ships.

All controls shall be of sufficient size to enable the usual control functions to be easily performed and the number of controls should be the minimum necessary for simple and satisfactory operation.

All parts of the equipment to be checked during inspection or maintenance operations shall be readily accessible. The components shall be readily identifiable.

Technical documentation shall be supplied with the equipment.

The VHF maritime mobile service uses both single-frequency and two-frequency channels. For two-frequency channels there shall be a separation of 4,6 MHz between the transmitting frequency and the receiving frequency (see Radio Regulations [1]).

The equipment, which can consist of more than one unit, shall be capable of operating on single frequency and two-frequency channels with manual control (simplex). It may also be capable of operating on two-frequency channels without manual control (duplex).

The equipment shall be able to operate on all channels defined in appendix 18 to the Radio Regulations [1].

Additional VHF channels outside those defined by appendix 18 to the Radio Regulations [1] may also be provided.

If 12,5 kHz channels are implemented in the equipment it shall be in accordance with ITU-R Recommendation M.1084-4 [12] and these are considered as additional channels for the purpose of the present document.

Means shall be provided to block any or all of these additional channels, as may be required by the licence before installation on board vessels. It shall not be possible for the user to unblock any blocked channels.

The equipment shall be so designed that use of channel 70 for purposes other than Digital Selective Calling (DSC) is prevented (see ITU-R Recommendation M.493-11 [3] and ITU-R Recommendation M.541-9 [4]) and that use of channels AIS1 and AIS2 for purposes other than AIS is prevented.

It shall not be possible to transmit while any frequency synthesizer used within the transmitter is out of lock.

It shall not be possible to transmit during channel switching operations.

4.2 Controls and indicators

The equipment shall have a channel selector and shall indicate the designator, as shown in appendix 18 to the Radio Regulations [1], of the channel at which the installation is set. Equipment with 12,5 kHz channels shall also indicate the channel designator as shown in annex 4 of ITU-R Recommendation M.1084-4 [12]. The channel designator shall be legible irrespective of the external lighting conditions.

Channels 16 and 70 should be distinctively marked. Selection of channel 16, and if possible channel 70, shall be by readily accessible means (e.g. a distinctively marked key). Selection of channel 16 by any means shall automatically set the transmitter output power to maximum. This power level may subsequently be reduced by manual user control if required.

Where an input panel on the equipment for entering the digits 0 to 9 is provided, this shall conform to ITU-T Recommendation E.161 [2].

The equipment shall have the following additional controls and indicators (see IMO Resolution A.803(19) [5]):

- on/off switch for the entire installation with a visual indication that the installation is in operation;
- a manual non-locking push to talk switch to operate the transmitter;
- on/off switch for the loudspeaker;
- a switch for reducing transmitter output power to no more than 1 W;
- an audio frequency power volume control;
- a squelch control;
- a control for reducing the brightness of the equipment illumination to zero;
- a visual indication that the transmitter is activated.

The equipment shall also meet the following requirements:

- the user shall not have access to any control which, if wrongly set, might impair the technical characteristics of the equipment;
- if the accessible controls are located on a separate console and if there are two or more control consoles, one of the consoles shall have priority over the others. If there are two or more control consoles, the operation of one console shall be indicated on the other consoles.

4.3 Handset and loudspeaker

The equipment shall be fitted with a telephone handset or microphone, and an integral loudspeaker and/or a socket for an external loudspeaker. A handset is required if duplex operation is provided.

It shall be possible to switch off the loudspeaker without causing a variation in the audio frequency power provided to the handset, if supplied.

During transmission in simplex operation the receiver output shall be muted. During transmission in duplex operation only the handset shall be operative. Measures shall be taken to ensure correct operation when duplex is used and precautions shall be taken to prevent harmful electrical or acoustic feedback which might produce oscillations.

4.4 Safety precautions

Measures shall be taken to protect the equipment against the effects of overcurrent or overvoltage.

Measures shall be taken to prevent damage to the equipment that might arise from an accidental reversal of polarity of the electrical power source.

Means shall be provided for earthing exposed metallic parts of the equipment but this shall not cause any terminal of the source of electrical energy to be earthed.

All components and wiring in which the dc or ac voltage (other than radio-frequency voltage), produce, singly or in combination, peak voltages in excess of 50 V, shall be protected against any accidental access and shall be automatically isolated from all electrical power sources if the protective covers are removed. Alternatively, the equipment shall be constructed in such a way as to prevent access to components operating at such voltages unless an appropriate tool is used such as a nut-spanner or screwdriver. Conspicuous warning labels shall be affixed both inside the equipment and on the protective covers.

No damage to the equipment shall occur when the antenna terminals are placed on open circuit or short circuit for a period of at least 5 minutes in each case.

In order to provide protection against damage due to the build up of static voltages at the antenna terminals, there shall be a dc path from the antenna terminals to chassis not exceeding 100 k Ω .

The information in any volatile memory device shall be protected from interruptions in the power supply of up to 60 s duration.

4.5 Labelling

All controls, instruments, indicators and terminals shall be clearly labelled (see IMO Resolution A.803(19) [5]).

Details of the power supply from which the equipment is intended to operate shall be clearly indicated on the equipment.

All units of the equipment shall be clearly marked on the exterior with the identification of the manufacturer, type designation of the equipment, and the serial number of the unit.

The compass safe distance shall be stated on the equipment or in the user document supplied with the equipment.

4.6 Warm up

After being switched on the equipment shall be operational within 5 s.

5 Technical requirements

5.1 Switching time

The channel switching arrangement shall be such that the time necessary to change over from using one of the channels to using any other channel does not exceed 5 s.

The time necessary to change over from transmission to reception or vice versa, shall not exceed 0,3 s.

5.2 Class of emission and modulation characteristics

The equipment shall use phase modulation, G3E (frequency modulation with a pre-emphasis of 6 dB/octave) for speech, and G2B for DSC signalling.

The equipment shall be designed to operate satisfactorily with channel separations of both 12,5 kHz and 25 kHz.

5.3 Multiple watch facilities

5.3.1 Additional performance standards

VHF radiotelephone equipment having multiple watch facilities shall comply with the following additional performance standards (see IMO Resolution A.524(13) [6]):

- a) the equipment shall include a provision for the automatic scanning of a priority channel and one additional channel. Facilities for the automatic sequential change of the additional channel may be provided, which are not accessible to the user. Means shall be provided to block/unblock;
- b) the priority channel is that channel which will be sampled even if there is a signal on the additional channel and on which the receiver will lock during the time a signal is detected;
- c) the additional channel is that channel which will be monitored during the periods the equipment is not sampling or receiving signals on the priority channel;
- d) provision shall be included to switch the scanning facility on and off by means of a manually operated control. In addition, it shall be ensured that the receiver remains on the same channel as the transmitter for the entire duration of any communication with the ship, e.g. the scanning facility could be switched off automatically when the handset is off its hook;
- e) selection of the additional channel and selection of the priority channel shall be possible at the operating position;
- f) when the scanning facility is in operation, the channel number of both channels on which the equipment is operating shall be clearly indicated simultaneously;
- g) in a transceiver, transmission shall not be possible when the scanning facility is operating. When the scanning facility is switched off, both transmitter and receiver shall be tuned automatically to the selected additional channel;
- h) a transceiver shall be provided with a single manual control (e.g. push-button) in order to switch the equipment quickly for operation on the priority channel;
- j) at the operating position of a transceiver the selected additional channel shall be clearly indicated as being the operational channel of the equipment.

5.3.2 Scanning characteristics

When the scanning facility is switched on, the priority channel shall be sampled with a sampling period of not more than 2 s. If a signal is detected on the priority channel the receiver shall remain on this channel for the duration of that signal.

If a signal is detected on the additional channel the sampling of the priority channel shall continue, thus interrupting the reception on the channel for periods as short as possible and not greater than 150 ms.

The design of the receiver shall provide for its proper functioning during the period the priority channel is sampled since the receiving conditions on the priority channel may differ from those on the additional channel.

In the absence of a signal on the priority channel, and, during reception of a signal on the additional channel, the duration of each listening period on this channel shall be at least 850 ms.

Means shall be provided to indicate the channel on which a signal is being received.

5.4 DSC controller interfaces

The equipment shall have DSC signal input and output impedances of 600 Ω , symmetrical and free of earth.

If the equipment is designed as an integral unit or fitted with digital interface to a DSC controller, the equipment shall also comply with the relevant requirements of EN 300 338 [10], as an integral equipment.

5.4.1 Operational interfaces

The interface for control shall comply with IEC 61162-1 [8].

The protocols shall at least comply to Frequency Set Information (FSI) (see annex B). Transmitter key input interface shall be a 2-wire circuit closure to transmit with a maximum/minimum open circuit voltage of 50 V and a maximum closed circuit current of 100 mA.

Compliance of the DSC controller interfaces shall be demonstrated by the successful set-up of an individual acknowledged DSC call via the air interface using a working channel that is different to the channel that was selected by the equipment before the call was placed. The transceiver shall be connected to a compliant DSC controller for the purposes of this test.

Readily available commercial connections should be used. Manufacturers shall provide means for user identification of the connectors used.

6 General conditions of measurement

6.1 Arrangements for test signals applied to the receiver input

Test signal sources shall be connected to the receiver input in such a way that the impedance presented to the receiver input is 50 Ω , irrespective of whether one or more test signals are applied to the receiver simultaneously.

The levels of the test signals shall be expressed in terms of the emf at the terminals to be connected to the receiver.

The nominal frequency of the receiver is the carrier frequency of the selected channel.

6.2 Squelch

Unless otherwise specified, the receiver squelch facility shall be made inoperative for the duration of the conformance tests.

6.3 Normal test modulation

For normal test modulation, the modulation frequency shall be:

- 25 kHz channels: 1 kHz and the frequency deviation shall be ± 3 kHz.
- 12,5 kHz channels: 1 kHz and the frequency deviation shall be $\pm 1,5$ kHz.

6.4 Artificial antenna

When tests are carried out with an artificial antenna, this shall be a non-reactive, non-radiating 50 Ω load.

6.5 Arrangements for test signals applied to the transmitter input

For the purpose of the present document, the audio frequency modulating signal applied to the transmitter shall be produced by a signal generator applied to the connection terminals replacing the microphone transducer.

6.6 Test channels

Tests shall be made on channel 16 unless otherwise stated.

6.7 Measurement uncertainty and interpretation of the measured results

6.7.1 Measurement uncertainty

Table 1: Absolute measurement uncertainties: maximum values

Parameter	Maximum uncertainty
RF frequency	$\pm 1 \times 10^{-7}$
RF power	$\pm 0,75$ dB
Maximum frequency deviation: - within 300 Hz to 6 kHz of modulation frequency - within 6 kHz to 25 kHz of modulation frequency	± 5 % ± 3 dB
Deviation limitation	± 5 %
Adjacent channel power	± 5 dB
Conducted spurious emission of transmitter	± 4 dB
Audio output power	$\pm 0,5$ dB
Amplitude characteristics of receiver limiter	$\pm 1,5$ dB
Sensitivity at 20 dB SINAD	± 3 dB
Conducted emission of receiver	± 3 dB
Two-signal measurement	± 4 dB
Three-signal measurement	± 3 dB
Radiated emission of transmitter	± 6 dB
Radiated emission of receiver	± 6 dB
Transmitter transient time	± 20 %
Transmitter transient frequency	± 250 Hz
Receiver desensitization (duplex operation)	$\pm 0,5$ dB

For the test methods according to the present document the uncertainty figures are valid to a confidence level of 95 % calculated according to the methods described in TR 100 028-1 [9].

6.7.2 Interpretation of the measurement results

The interpretation of the results recorded in a test report for the measurements described in the present document shall be as follows:

- the measured value related to the corresponding limit will be used to decide whether an equipment meets the requirements of the present document;
- the measurement uncertainty value for the measurement of each parameter shall be included in the test report;
- the recorded value of the measurement uncertainty shall be, for each measurement, equal to or lower than the figures in table 1.

NOTE: This procedure for using maximum acceptable uncertainty values is valid until superseded by other appropriate publications of ETSI covering this subject.

6.8 Test conditions, power sources and ambient temperatures

6.8.1 Normal and extreme test conditions

Conformance tests shall be made under normal test conditions and also, where stated, under extreme test conditions (clauses 6.10.1 and 6.10.2 applied simultaneously).

6.8.2 Test power source

During conformance testing, the equipment shall be supplied from a test power source capable of producing normal and extreme test voltages as specified in clauses 6.9.2 and 6.10.2.

The internal impedance of the test power source shall be low enough for its effect on the test results to be negligible. For the purpose of testing the power source voltage shall be measured at the input terminals of the equipment.

During testing, the power source voltages shall be maintained within a tolerance of ± 3 % relative to the voltage level at the beginning of each test.

6.9 Normal test conditions

6.9.1 Normal temperature and humidity

The normal temperature and humidity conditions for tests shall be a combination of temperature and humidity within the following ranges:

- temperature: $+15^{\circ}\text{C}$ to $+35^{\circ}\text{C}$;
- relative humidity: 20 % to 75 %.

When the relative humidity is lower than 20 %, it shall be stated in the test report.

6.9.2 Normal power sources

6.9.2.1 Mains voltage and frequency

The normal test voltage for equipment to be connected to the ac mains shall be the nominal mains voltage. For the purpose of the present document, the nominal voltage shall be the declared voltage or any of the declared voltages for which the equipment is indicated as having been designed. The frequency of the test voltage shall be $50\text{ Hz} \pm 1\text{ Hz}$.

6.9.2.2 Battery power source

Where the equipment is designed to operate from a battery, the normal test voltage shall be the nominal voltage of the battery (12 V, 24 V, etc.).

6.9.2.3 Other power sources

For operation from other power sources the normal test voltage shall be that declared by the manufacturer.

6.10 Extreme test conditions

Unless otherwise stated the extreme tests conditions means that the Equipment Under Test (EUT) shall be tested at the upper temperature and at the upper limit of the supply voltage applied simultaneously, and at the low temperature and the lower limit of the supply voltage applied simultaneously.

6.10.1 Extreme temperatures

For tests at extreme temperatures, measurements shall be made in accordance with clause 6.11, at a lower temperature of -15°C and an upper temperature of +55°C.

6.10.2 Extreme values of test power sources

6.10.2.1 Mains voltage

The extreme test voltages for equipment to be connected to the ac mains shall be the nominal mains voltage $\pm 10\%$. The frequency of the test voltage shall be $50\text{ Hz} \pm 1\text{ Hz}$.

6.10.2.2 Battery power source

Where the equipment is designed to operate from a battery, the extreme test voltages shall be 1,3 and 0,9 times the nominal voltage of the battery (12 V, 24 V, etc.).

6.10.2.3 Other power sources

For operation from other power sources the extreme test voltages shall be agreed between the testing authority and the equipment manufacturer.

6.11 Procedure for tests at extreme temperatures

The equipment shall be switched off during the temperature stabilizing periods.

Before conducting tests at the upper temperature, the equipment shall be placed in the test chamber and left until thermal equilibrium is reached. The equipment shall then be switched on for half an hour in the high power transmit condition at the normal voltage, the equipment shall meet the requirement of the present document.

For tests at the lower temperature, the equipment shall be left in the test chamber until thermal equilibrium is reached and shall then be switched to the standby or receive position for one minute, after which the equipment shall meet the requirements of the present document.

7 Environmental tests

7.1 Procedure

Environmental tests shall be carried out before tests are performed on the same equipment with respect to the other requirements of the present document. Unless otherwise stated, the equipment shall be connected to an electrical power source during the periods for which it is specified that electrical tests shall be carried out. These tests shall be performed using the normal test voltage.

7.2 Performance check

The performance check shall be a check of transmitter frequency error (see clause 8.1.1), transmitter carrier power (see clause 8.2.1) and maximum usable sensitivity of the receiver (see clause 9.3.1):

- the transmitter carrier frequency shall be measured on channel 16 in the absence of modulation with the transmitter connected to an artificial antenna (see clause 6.4). The test shall be carried out with output switch set in the maximum position. The frequency error shall be within $\pm 1,5$ kHz;
- the transmitter carrier power shall be measured on channel 16 with the transmitter connected to the artificial antenna (see clause 6.4). The test shall be carried out with the output switch set in the maximum position. The carrier power shall be between 6 W and 25 W;
- the maximum usable sensitivity of the receiver shall be measured on channel 16. A test signal modulated by the normal test modulation (see clause 6.3) shall be applied to the receiver input. An audio frequency load and an instrument for measuring SINAD ratio (through a psophometric filter as specified in clause 9.3.1) shall be connected to the receiver output terminals. The level of the test signal shall be adjusted until a SINAD ratio of 20 dB is obtained and with the receiver's audio frequency power control adjusted to produce at least 50 % of the rated output power. The level of the test signal shall not exceed +12 dB μ V (emf).

7.3 Vibration test

7.3.1 Definition

This test determines the ability of equipment to withstand vibration without resulting in mechanical weakness or degradation in performance.

7.3.2 Method of measurement

The EUT, complete with any shock and vibration absorbers with which it is provided, shall be clamped to the vibration table by its normal means of support and in its normal attitude. The EUT may be resiliently suspended to compensate for weight not capable of being withstood by the vibration table. Provision may be made to reduce or nullify any adverse effect on EUT performance which could be caused by the presence of an electro-magnetic field due to the vibration unit.

The EUT shall be subjected to sinusoidal vertical vibration at all frequencies between:

- 5 Hz and up to 13,2 Hz with an excursion of ± 1 mm ± 10 % (7 m/s² maximum acceleration at 13,2 Hz);
- above 13,2 Hz and up to 100 Hz with a constant maximum acceleration of 7 m/s².

The frequency sweep rate shall be slow enough to allow the detection of resonances in any part of the EUT.

A resonance search shall be carried out throughout the test. If any resonance of the EUT has $Q \geq 5$ measured relative to the base of the vibration table, the EUT shall be subjected to a further vibration endurance test at each resonant frequency at the vibration level specified in the test with a duration of two hours. If any resonance with $Q < 5$ occurs the further endurance test shall be carried out at one single observed frequency. If no resonance occurred, the further endurance test shall be carried out at a frequency of 30 Hz.

Performance check(s) shall be carried out at the end of each two hour endurance test period.

The procedure shall be repeated with vibration in each of two mutually perpendicular directions in the horizontal plane.

After conducting the vibration tests, the equipment shall be inspected for any mechanical deterioration.

7.3.3 Requirement

The equipment shall meet the requirements of the performance check.

There shall be no harmful deterioration of the equipment visible.

7.4 Temperature tests

7.4.1 Definition

The immunity against the effects of temperature is the ability of the equipment to maintain the specified mechanical and electrical performance after the following tests has been carried out.

7.4.2 Dry heat

7.4.2.1 Definition

This test determines the ability of equipment to be operated at high ambient temperatures and to operate through temperature changes.

7.4.2.2 Method of measurement

The EUT shall be placed in a chamber at normal room temperature and relative humidity. The EUT and, if appropriate, any climatic control devices with which it is provided shall then be switched on. The temperature shall then be raised to and maintained at $+55^{\circ}\text{C} \pm 3^{\circ}\text{C}$.

At the end of a soak period of 10 hours to 16 hours at $+55^{\circ}\text{C} \pm 3^{\circ}\text{C}$, the EUT shall be subjected to the performance check. The temperature of the chamber shall be maintained at $+55^{\circ}\text{C} \pm 3^{\circ}\text{C}$ during the whole performance check period. At the end of the test, the EUT shall be returned to normal environmental conditions or to those required at the start of the next test. The maximum rate of raising or reducing the temperature of the chamber in which the equipment is being tested shall be $1^{\circ}\text{C}/\text{minute}$.

7.4.2.3 Requirement

The equipment shall meet the requirements of the performance check.

7.4.3 Damp heat

7.4.3.1 Definition

This test determines the ability of equipment to be operated under conditions of high humidity.

7.4.3.2 Method of measurement

The EUT shall be placed in a chamber at normal room temperature and relative humidity. The temperature shall then be raised to $+40^{\circ}\text{C} \pm 2^{\circ}\text{C}$, and the relative humidity raised to $93\% \pm 3\%$ over a period of three hours $\pm 0,5$ hour. These conditions shall be maintained for a period of 10 hours to 16 hours. Any climatic control devices provided in the EUT may be switched on at the conclusion of this period. The EUT shall be switched on 30 minutes later, or after such period as agreed by the manufacturer, and shall be kept operational for at least two hours during which period the EUT shall be subjected to the performance check. The temperature and relative humidity of the chamber shall be maintained as specified during the whole test period. At the end of the test period and with the EUT still in the chamber, the chamber shall be brought to room temperature in not less than one hour. At the end of the test the EUT shall be returned to normal environmental conditions or to those required at the start of the next test. The maximum rate of raising or reducing the temperature of the chamber in which the equipment is being tested shall be $1^{\circ}\text{C}/\text{minute}$.

7.4.3.3 Requirement

The equipment shall meet the requirements of the performance check.

7.4.4 Low temperature cycle

7.4.4.1 Definition

These tests determine the ability of equipment to be operated at low temperatures. They also allow equipment to demonstrate an ability to start up at low ambient temperatures.

7.4.4.2 Method of measurement

The EUT shall be placed in a chamber at normal room temperature and relative humidity. The temperature shall then be reduced to and maintained at $-15^{\circ}\text{C} \pm 3^{\circ}\text{C}$, for a period of 10 hours to 16 hours. Any climatic control devices provided in the EUT may be switched on at the conclusion of this period. The EUT shall be switched on 30 minutes later, and shall be kept operational for at least two hours during which period the EUT shall be subjected to the performance check. The temperature of the chamber shall be maintained at $-15^{\circ}\text{C} \pm 3^{\circ}\text{C}$ during the whole test period. At the end of the test the EUT shall be returned to normal environmental conditions or to those required at the start of the next test. The maximum rate of raising or reducing the temperature of the chamber in which the equipment is being tested shall be $1^{\circ}\text{C}/\text{minute}$.

7.4.4.3 Requirement

The equipment shall meet the requirements of the performance check.

8 Transmitter

All tests on the transmitter shall be carried out with the output power switch set at its maximum except where otherwise stated.

8.1 Frequency error

8.1.1 Definition

The frequency error is the difference between the measured carrier frequency and its nominal value.

8.1.2 Method of measurement

The carrier frequency shall be measured in the absence of modulation, with the transmitter connected to an artificial antenna (see clause 6.4). Measurements shall be made under normal test conditions (see clause 6.9) and under extreme test conditions (see clause 6.10).

This test shall be carried out with the output power switch being set at both maximum and minimum.

8.1.3 Limits

The frequency error shall be within $\pm 1,5$ kHz.

8.2 Carrier power

8.2.1 Definitions

The carrier power is the mean power delivered to the artificial antenna during one radio frequency cycle in the absence of modulation.

The rated output power is the carrier power declared by the manufacturer.

8.2.2 Method of measurement

The transmitter shall be connected to an artificial antenna (see clause 6.4) and the power delivered to this artificial antenna shall be measured. The measurements shall be made under normal test conditions (see clause 6.9) and also under extreme test conditions (see clause 6.10) on the highest frequency channel, the lowest frequency channel and on channel 16.

8.2.3 Limits

8.2.3.1 Normal test conditions

The carrier power on the appendix 18 channels [1], measured under normal test conditions with the output power switch (see clause 4.2) set at maximum, shall remain between 6 W and 25 W and not differ by more than $\pm 1,5$ dB from the rated output power.

8.2.3.2 Extreme test conditions

With the output power switch set at maximum, the carrier power shall remain between 6 W and 25 W and be within +2 dB, -3 dB of the rated output power under extreme conditions.

With the output power switch set at minimum, the carrier power shall remain between 0,1 W and 1 W.

8.3 Frequency deviation

8.3.1 Definition

For the purpose of the present document, the frequency deviation is the difference between the instantaneous frequency of the modulated radio frequency signal and the carrier frequency.

8.3.2 Maximum permissible frequency deviation

8.3.2.1 Method of measurement

The frequency deviation shall be measured at the output with the transmitter connected to an artificial antenna (see clause 6.4), by means of a deviation meter capable of measuring the maximum deviation, including that due to any harmonics and intermodulation products which may be generated in the transmitter.

The modulation frequency shall be varied between 100 Hz and 3 kHz. The level of this test signal shall be 20 dB above the level which produces normal test modulation (see clause 6.3). This test shall be repeated with the output power switch set at maximum and minimum.

8.3.2.2 Limits

The maximum permissible frequency deviation shall be:

- 25 kHz channels: ± 5 kHz.
- 12,5 kHz channels: $\pm 2,5$ kHz.

8.3.3 Reduction of frequency deviation at modulation frequencies above 3 kHz

8.3.3.1 Method of measurement

The transmitter shall operate under normal test conditions (see clause 6.9) connected to a load as specified in clause 6.4. The transmitter shall be modulated by the normal test modulation (see clause 6.3). With the input level of the modulation signal being kept constant, the modulation frequency shall be varied between 3 kHz (see note) and a frequency equal to the channel separation for which the equipment is intended and the frequency deviation shall be measured.

NOTE: 2,55 kHz for transmitters intended for 12,5 kHz channel separation.

8.3.3.2 Limits

The frequency deviation at modulation frequencies between 3,0 kHz (for equipment operating with 25 kHz channel separations) or 2,55 kHz (for equipment operating with 12,5 kHz channel separation) and 6,0 kHz shall not exceed the frequency deviation at a modulation frequency of 3,0 kHz/2,55 kHz. At 6,0 kHz the deviation shall be not more than 30,0 % of the maximum permissible frequency deviation.

The frequency deviation at modulation frequencies between 6,0 kHz and a frequency equal to the channel separation for which the equipment is intended shall not exceed that given by a linear representation of the frequency deviation (dB) relative to the modulation frequency, starting at the 6,0 kHz limit and having a slope of -14,0 dB per octave. These limits are illustrated in figure 1.

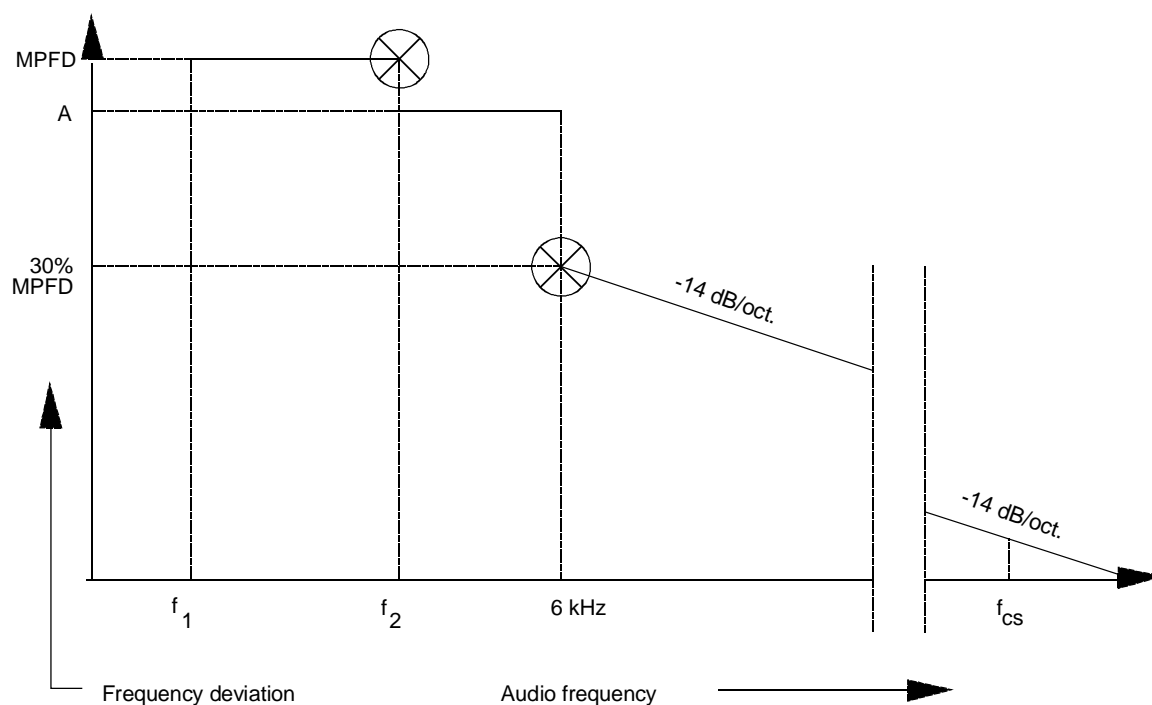

NOTE:

Abbreviations:

- f1 lowest appropriate frequency
 f2 3,0 kHz (for 25 kHz channel separation), or
 2,55 kHz (for 12,5 kHz channel separation)
 MPFD maximum permissible frequency deviation, clause 5.1.4.1
 A measured frequency deviation at f2
 fcs frequency equal to channel separation

Figure 1

8.4 Sensitivity of the modulator, including microphone

8.4.1 Definition

This characteristic expresses the capability of the transmitter to produce sufficient modulation when an audio frequency signal corresponding to the normal mean speech level is applied to the microphone.

8.4.2 Method of measurement

A 25 kHz channel shall be selected and the transmitter activated. An acoustic signal with a frequency of 1 kHz and sound level of 94 dBA shall be applied to the microphone. The resulting deviation shall be measured.

8.4.3 Limits

The resulting frequency deviation shall be between $\pm 1,5$ kHz and ± 3 kHz.

8.5 Audio frequency response

8.5.1 Definition

The audio frequency response is the frequency deviation of the transmitter as a function of the modulating frequency.

8.5.2 Method of measurement

A modulating signal at a frequency of 1 kHz shall be applied to the transmitter and the deviation shall be measured at the output. The audio input level shall be adjusted so that the frequency deviation is ± 1 kHz. This is the reference point in figure 2 (1 kHz corresponds to 0 dB).

The modulation frequency shall then be varied between 300 Hz and 3 kHz (see note), with the level of the audio frequency signal being kept constant and equal to the value specified above.

The test shall be carried out on one channel only (see clause 6.6).

NOTE: 2,55 kHz for transmitters intended for 12,5 kHz channel separation.

8.5.3 Limit

The audio frequency response shall be within +1 dB and -3 dB of a 6 dB/octave line passing through the reference point (see figure 2). The upper limit frequency shall be 2,55 kHz for 12,5 kHz channels.

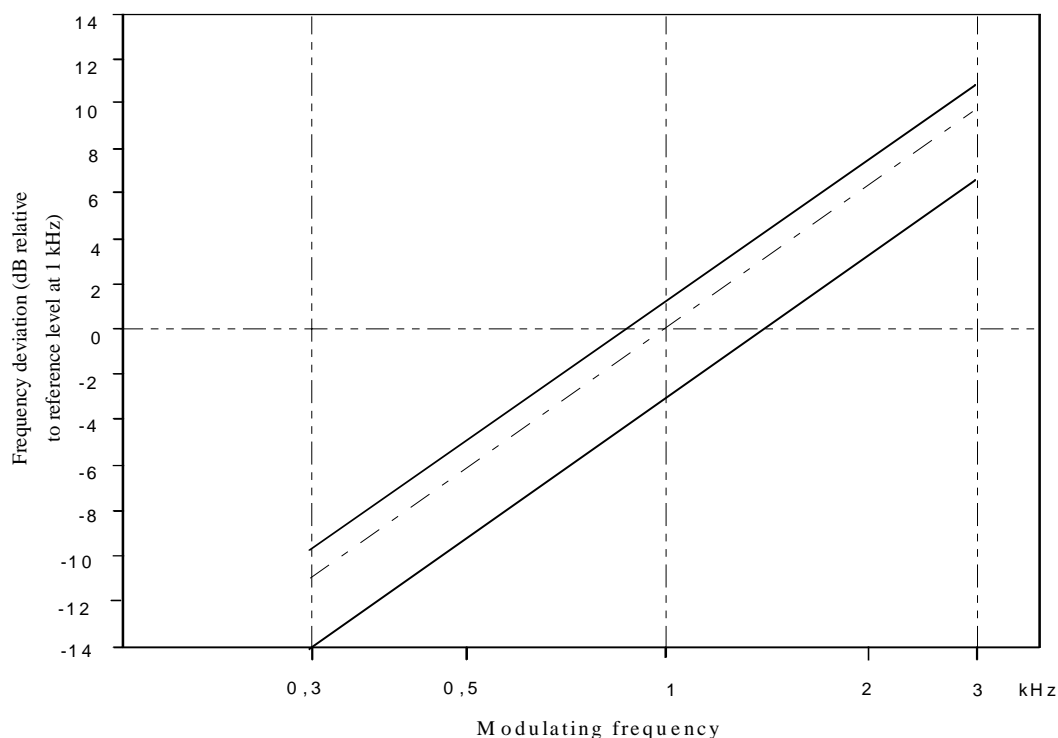

Figure 2: Audio frequency response

8.6 Audio frequency harmonic distortion of the emission

8.6.1 Definition

The harmonic distortion of the emission modulated by an audio frequency signal is defined as the ratio, expressed as a percentage, of the root mean square (rms) voltage of all the harmonic components of the fundamental frequency to the total rms voltage of the signal after linear demodulation.

8.6.2 Method of measurement

The RF signal produced by the transmitter shall be applied via an appropriate coupling device to a linear demodulator with a de-emphasis network of 6 dB per octave. This test shall be carried out on a 25 kHz channel with the output power switch at both maximum and minimum.

8.6.2.1 Normal test conditions

Under normal test conditions (see clause 6.9) the RF signal shall be modulated successively at frequencies of 300 Hz, 500 Hz and 1 kHz with a constant modulation index of 3.

The distortion of the audio frequency signal shall be measured at all the frequencies specified above.

8.6.2.2 Extreme test conditions

Under extreme test conditions (see clauses 6.10.1 and 6.10.2 applied simultaneously), the measurements shall be carried out at 1 kHz with a frequency deviation of ± 3 kHz.

8.6.3 Limits

The harmonic distortion shall not exceed 10 %.

8.7 Adjacent channel power

8.7.1 Definition

The adjacent channel power is that part of the total power output of a transmitter under defined conditions of modulation, which falls within a specified passband centred on the nominal frequency of either of the adjacent channels. This power is the sum of the mean power produced by the modulation, hum and noise of the transmitter.

8.7.2 Method of measurement

The test shall be made on the lowest frequency channel, the highest frequency channel and on channel 16.

The adjacent channel power can be measured with a power measuring receiver which conforms to annex A (referred to in this clause and annex A as the "receiver") see also ITU-R Recommendation SM.332-4 [11]:

- a) The transmitter shall be operated at the carrier power determined in clause 8.2 under normal test conditions. The output of the transmitter shall be linked to the input of the "receiver" by a connecting device such that the impedance presented to the transmitter is 50 Ω and the level at the "receiver" input is appropriate.
- b) With the transmitter unmodulated, the tuning of the "receiver" shall be adjusted so that a maximum response is obtained. This is the 0 dB response point. The "receiver" attenuator setting and the reading of the meter shall be recorded.

The measurement may be made with the transmitter modulated with normal test modulation, in which case this fact shall be recorded with the test results.

- c) The tuning of the "receiver" shall be adjusted away from the carrier so that the "receiver" -6 dB response nearest to the transmitter carrier frequency is located at a displacement from the nominal carrier frequency of 17 kHz for 25 kHz channels or 8,25 kHz for 12,5 kHz channels.
- d) The transmitter shall be modulated with 1,25 kHz at a level which is 20 dB higher than that required to produce ± 3 kHz deviation for 25 kHz channels or $\pm 1,5$ kHz deviation for 12,5 kHz channels.
- e) The "receiver" variable attenuator shall be adjusted to obtain the same meter reading as in step b) or a known relation to it.
- f) The ratio of adjacent channel power to carrier power is the difference between the attenuator settings in steps b) and e), corrected for any differences in the reading of the meter.
- g) The measurement shall be repeated with the "receiver" tuned to the other side of the carrier.

8.7.3 Limits

The adjacent channel power shall not exceed a value of:

- 25 kHz channel: 70 dB below the carrier power of the transmitter without any need to be below 0,2 μ W.
- 12, kHz channel: 60 dB below the carrier power of the transmitter without any need to be below 0,2 μ W.

8.8 Conducted spurious emissions conveyed to the antenna

8.8.1 Definition

Conducted spurious emissions are emissions on a frequency or frequencies which are outside the necessary bandwidth and the level of which may be reduced without affecting the corresponding transmission of information. Spurious emissions include harmonic emissions, parasitic emissions, intermodulation products and frequency conversion products, but exclude out of band emissions.

8.8.2 Method of measurement

Conducted spurious emissions shall be measured with the unmodulated transmitter connected to the artificial antenna (see clause 6.4).

The measurements shall be made over a range from 9 kHz to 2 GHz, excluding the channel on which the transmitter is operating and its adjacent channels.

The measurements for each spurious emission shall be made using a tuned radio measuring instrument or a spectrum analyser.

8.8.3 Limit

The power of any conducted spurious emission on any discrete frequency shall not exceed 0,25 μ W.

8.9 Cabinet radiation and conducted spurious emissions other than those conveyed to the antenna

8.9.1 Definitions

Cabinet radiation consists of emissions at frequencies, radiated by the equipment cabinet and structures.

Conducted spurious emissions other than those conveyed to the antenna are emissions at frequencies, other than those of the carrier and the sideband components resulting from the wanted modulation process, which are produced by conduction in the wiring and accessories used with the equipment.

8.9.2 Method of measurement

On a test site, selected from annex C, the equipment shall be placed at the specified height on a non-conducting support and in position closest to normal use as declared by the manufacturer.

The transmitter antenna connector shall be connected to on artificial antenna, see clause 6.4.

The test antenna shall be orientated for vertical polarization and the length of the test antenna shall be chosen to correspond to the instantaneous frequency of the measuring receiver.

The output of the test antenna shall be connected to a measuring receiver.

The transmitter shall be switched on without modulation, and measuring receiver shall be tuned over the frequency range 30 MHz to 2 GHz, except for the channel on which the transmitter is intended to operate and its adjacent channels.

At each frequency at which a spurious component is detected:

- a) the test antenna shall be raised and lowered through the specified range of heights until a maximum signal level is detected on the measuring receiver;
- b) the transmitter shall be rotated through 360° in the horizontal plane, until the maximum signal level is detected by the measuring receiver;
- c) the maximum signal level detected by the measuring receiver shall be noted;
- d) the transmitter shall be replaced by a substitution antenna as defined in annex C;
- e) the substitution antenna shall be orientated for vertical polarization and the length of the substitution antenna shall be adjusted to correspond to the frequency of the spurious component detected;
- f) the substitution antenna shall be connected to a calibrated signal generator;
- g) the frequency of the calibrated signal generator shall be set to the frequency of the spurious component detected;
- h) the input attenuator setting of the measuring receiver shall be adjusted in order to increase the sensitivity of the measuring receiver, if necessary;
- i) the test antenna shall be raised and lowered through the specified range of heights to ensure that the maximum signal is received;
- j) the input signal to the substitution antenna shall be adjusted to the level that produces a level detected by the measuring receiver that is equal to the level noted while the spurious component was measured, corrected for the change of input attenuator setting of the measuring receiver;
- k) the input level to the substitution antenna shall be recorded as power level, corrected for the change of input attenuator setting of the measuring receiver;
- l) the measurement shall be repeated with the test antenna and the substitution antenna orientated for horizontal polarization;
- m) the measure of the effective radiated power of the spurious components is larger of the two power levels recorded for spurious component at the input to the substitution antenna, corrected for the gain of the antenna if necessary;
- n) the measurements shall be repeated with the transmitter on stand-by.

8.9.3 Limits

When the transmitter is in stand-by the cabinet radiation and spurious emissions shall not exceed 2 nW.

When the transmitter is in operation the cabinet radiation and spurious emissions shall not exceed 0,25 µW.

8.10 Residual modulation of the transmitter

8.10.1 Definition

The residual modulation of the transmitter is the ratio, in dB, of the demodulated RF signal in the absence of wanted modulation, to the demodulated RF signal produced when the normal test modulation is applied.

8.10.2 Method of measurement

The normal test modulation defined in clause 6.3 shall be applied to the transmitter. The high frequency signal produced by the transmitter shall be applied, via an appropriate coupling device, to a linear demodulator with a de-emphasis network of 6 dB per octave. The time constant of this de-emphasis network shall be at least 750 µs.

Precautions shall be taken to avoid the effects of emphasizing the low audio frequencies produced by internal noise.

The signal shall be measured at the demodulator output using an rms voltmeter.

The modulation shall then be switched off and the level of the residual audio frequency signal at the output shall be measured again.

8.10.3 Limit

The residual modulation shall not exceed -40 dB on either 25 kHz or 12,5 kHz channels.

8.11 DSC audio input characteristics

8.11.1 Definition

This test is to ensure the transmitter's ability to correctly modulate a DSC audio signal.

8.11.2 Method of measurement

The test shall be performed on channel 70.

The transmitter shall be set into transmission using the DSC key lines.

The transmitter shall be modulated, using the DSC audio input terminal, by a single tone of 1 300 Hz with a level of $0,775\text{ V} \pm 0,075\text{ V}$.

The modulation index of the transmitter shall be measured. The test shall be repeated with an audio tone of 2 100 Hz having the same amplitude.

8.11.3 Limits

The modulation index shall in both cases be between 1,8 and 2,2.

8.12 DSC audio input limitation

8.12.1 Definition

This test is to ensure, that the transmitter is able to limit deviation in case of excessive DSC input signals.

8.12.2 Method of measurement

The test shall be performed on channel 70.

The transmitter shall be set into transmission using the DSC key lines.

The transmitter shall be modulated, using the DSC audio input terminal, by a single tone of 2 100 Hz with a level of $2,45\text{ V} \pm 0,3\text{ V}$.

The modulation index of the transmitter shall be measured.

8.12.3 Limit

The modulation index shall be below 2,4.

8.13 Modulation attack time

8.13.1 Definition

The modulator attack time is the time elapsed between keying the transmitter and the transmitter being correctly modulated.

8.13.2 Method of measurement

The test shall be performed on channel 70. A signal of 1 300 Hz and an amplitude of $0,775 \text{ V} \pm 0,075 \text{ V rms}$ shall be connected to the transmitter DSC input terminals. The transmitter shall be connected by suitable means to a wideband test discriminator.

The recovered audio from the test discriminator shall be applied to a storage oscilloscope.

The vertical sensitivity of the oscilloscope shall be set, so the recovered audio signal after settling has a peak to peak amplitude corresponding to 4 divisions. The vertical time base of the oscilloscope shall be set to 20 ms per division. The oscilloscope shall be set to trigger at 1 division from the left edge.

An arrangement shall be provided to key the transmitter using the DSC key lines and at the same time trigger the oscilloscope, see figure 3. The oscilloscope shows the modulation behaviour of the transmitter and shows when the transmitter's modulation circuits have settled, see figure 4.

The settling time t_{set} is the time elapsed from when triggering occurs, i.e. the time from when the transmitter is keyed until the recovered audio remains constant with an amplitude of 4 divisions.

The test shall be repeated with the transmitter modulated by a 2 100 Hz tone at the same amplitude.

8.13.3 Limit

The settling time t_{set} shall be less than 90 ms.

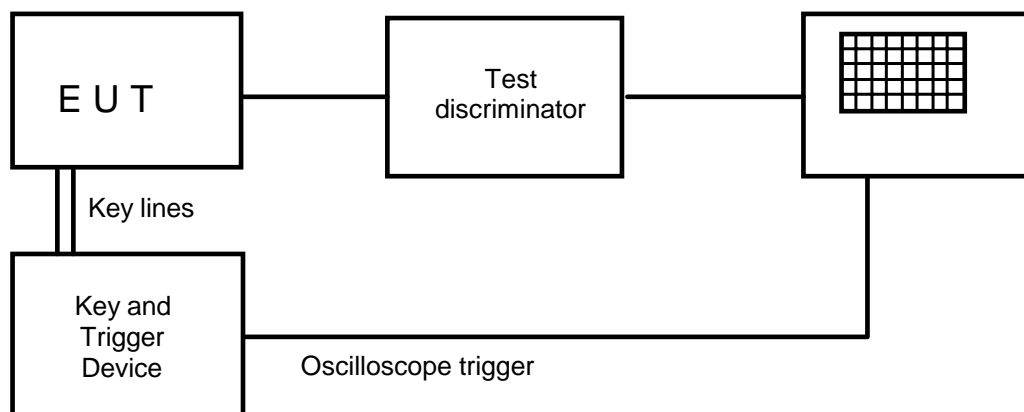

Figure 3: Test arrangement

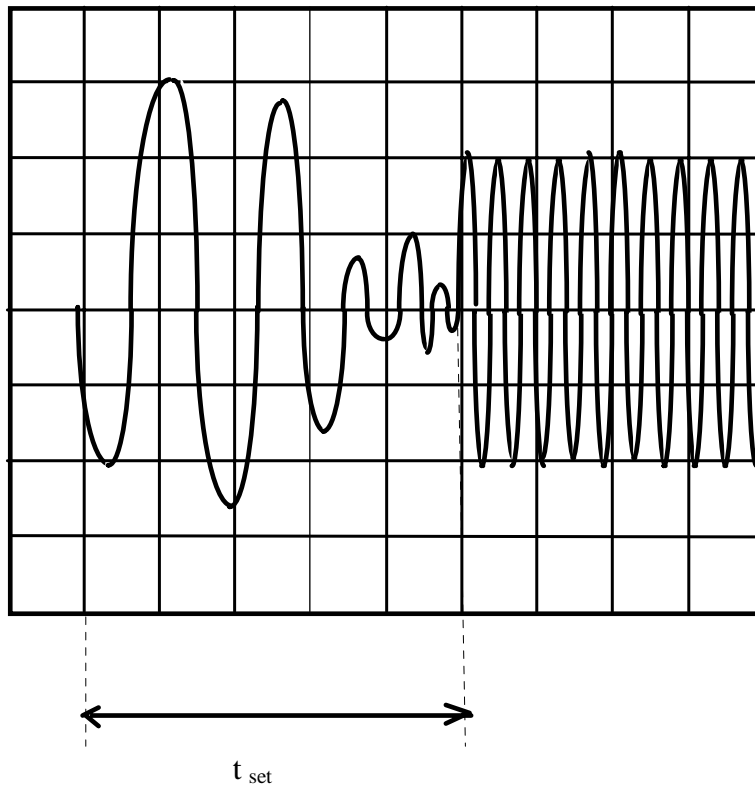

Figure 4: Oscilloscope output

8.14 Transient frequency behaviour of the transmitter

8.14.1 Definitions

The transient frequency behaviour of the transmitter is the variation in time of the transmitter frequency difference from the nominal frequency of the transmitter when the RF output power is switched on and off.

8.14.2 Method of measurement

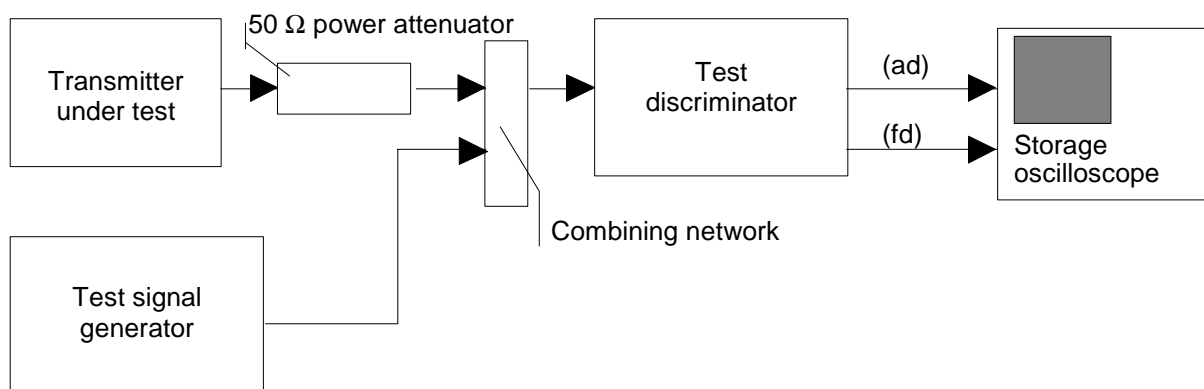

Figure 5: Measurement arrangement

Two signals shall be connected to the test discriminator via a combining network (see clause 6.1).

The transmitter shall be connected to a 50 Ω power attenuator.

The output of the power attenuator shall be connected to the test discriminator via one input of the combining network.

A test signal generator shall be connected to the second input of the combining network.

The test signal shall be adjusted to the nominal frequency of the transmitter.

The test signal shall be modulated by a frequency of 1 kHz with a deviation of ± 25 kHz.

The test signal level shall be adjusted to correspond to 0,1 % of the power of the transmitter under test measured at the input of the test discriminator. This level shall be maintained throughout the measurement.

The amplitude difference (ad) and the frequency difference (fd) output of the test discriminator shall be connected to a storage oscilloscope.

The storage oscilloscope shall be set to display the channel corresponding to the frequency difference (fd) input up to ± 1 channel frequency difference, corresponding to the relevant channel separation from the nominal frequency.

The storage oscilloscope shall be set to a sweep rate of 10 ms/division and set so that the triggering occurs at 1 division from the left edge of the display.

The display shows the 1 kHz test signal continuously.

The storage oscilloscope shall then be set to trigger on the channel corresponding to the amplitude difference (ad) input at a low input level, rising.

The transmitter shall then be switched on, without modulation, to produce the trigger pulse and a picture on the display.

The result of the change in the ratio of power between the test signal and the transmitter output, due to the capture ratio of the test discriminator, produces two separate sides on the picture, one showing the 1 kHz test signal, the other the frequency difference of the transmitter versus time:

- the moment when the 1 kHz test signal is completely suppressed is considered to provide t_{on} ;
- the periods of time t_1 and t_2 as defined in the table shall be used to define the appropriate template;
- during the period of time t_1 and t_2 the frequency difference shall not exceed the values given in table 2;
- the frequency difference, after the end of t_2 , shall be within the limit of the frequency error, see clause 8.1;
- the result shall be recorded as frequency difference versus time;
- the transmitter shall remain switched on.

The storage oscilloscope shall be set to trigger on the channel corresponding to the amplitude difference (ad) input at a high input level, decaying and set so that the triggering occurs at 1 division from the right edge of the display:

- the transmitter shall then be switched off;
- the moment when the 1 kHz test signal starts to rise is considered to provide t_{off} ;
- the period of time t_3 as defined in table 2 shall be used to define the appropriate template;
- during the period of time t_3 the frequency difference shall not exceed the values given in table 2;
- before the start of t_3 the frequency difference shall be within the limit of the frequency error, see clause 8.1;
- the result shall be recorded as frequency difference versus time.

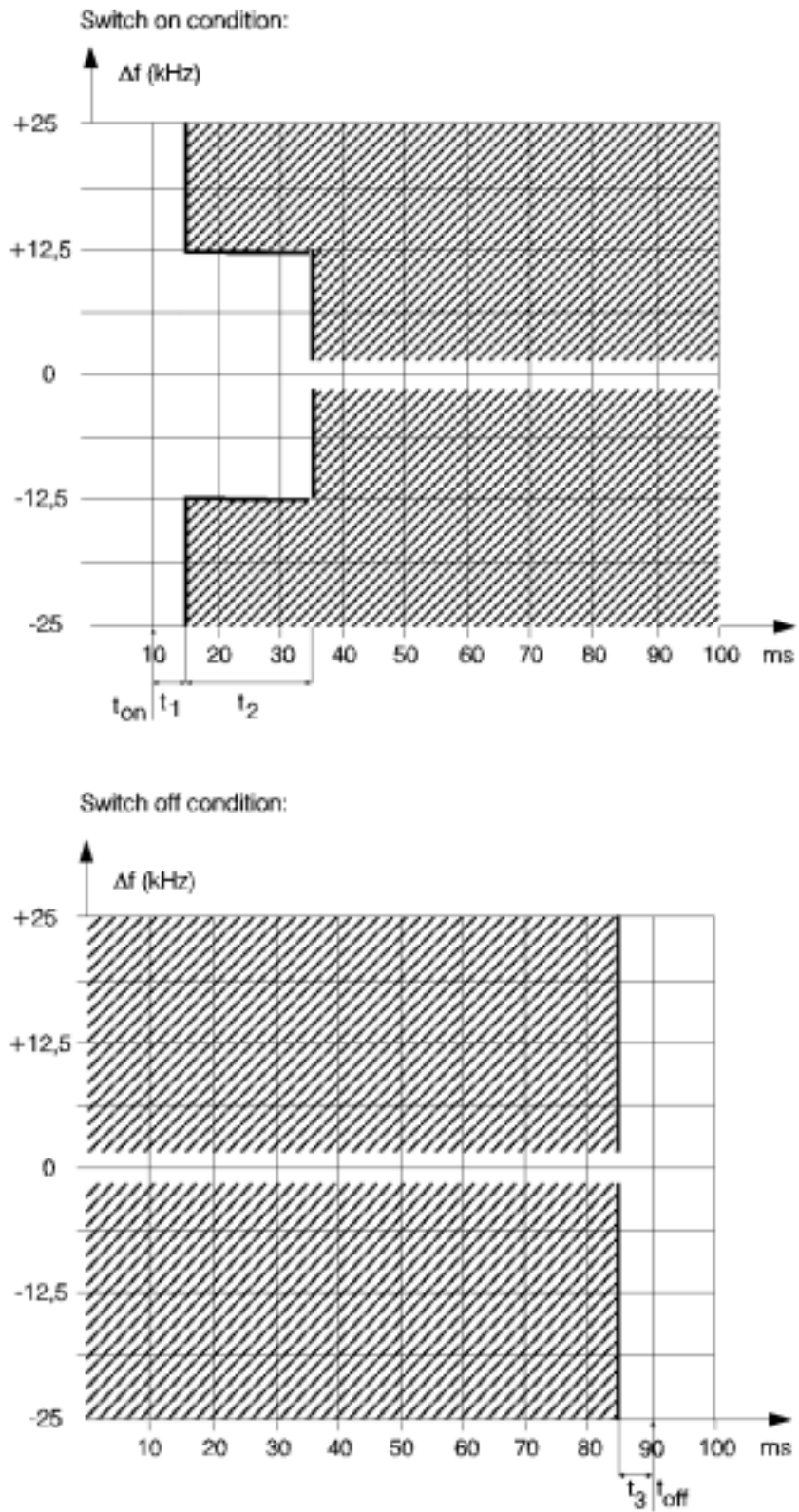

Figure 6: Storage oscilloscope view t_1 , t_2 and t_3

8.14.3 Limits

- ton: according to the method of measurement described in clause 8.14.2 the switch-on instant ton of a transmitter is defined by the condition when the output power, measured at the antenna terminal, exceeds 0,1 % of the nominal power;
- t1: period of time starting at ton and finishing according to table 2;
- t2: period of time starting at the end of t1 and finishing according to table 2;
- toff: switch-off instant defined by the condition when the nominal power falls below 0,1 % of the nominal power;
- t3: period of time that finishing at toff and starting according to table 2.

Table 2: Transient frequency limits

Designator	Frequency limit
t ₁ (ms)	5,0
t ₂ (ms)	20,0
t ₃ (ms)	5,0
NOTE: During the periods t ₁ and t ₃ the frequency difference shall not exceed the value of 25 kHz. During the period t ₂ the frequency difference shall not exceed the value of 12,5 kHz.	

9 Receiver

9.1 Harmonic distortion and rated audio frequency output power

9.1.1 Definition

The harmonic distortion at the receiver output is defined as the ratio, expressed as a percentage, of the total rms voltage of all the harmonic components of the modulation audio frequency to the total rms voltage of the signal delivered by the receiver.

The rated audio frequency output power is the value stated by the manufacturer to be the maximum power available at the output, for which all the requirements of the present document are met.

9.1.2 Methods of measurement

Test signals at a level of +100 dBμV, at a carrier frequency equal to the nominal frequency of the receiver and modulated by the normal test modulation (see clause 6.3) shall be applied in succession to the receiver input under the conditions specified in clause 6.1.

For each measurement, the receiver's audio frequency volume control shall be set so as to obtain, in a resistive load which simulates the receiver's operating load, the rated audio frequency output power (see clause 9.1.1). The value of this load shall be stated by the manufacturer.

Under normal test conditions (see clause 6.9) the test signal shall be modulated successively at 300 Hz, 500 Hz and 1 kHz with a constant modulation index of 3 (ratio between the frequency deviation and the modulation frequency). The harmonic distortion and audio frequency output power shall be measured at all the frequencies specified above.

Under extreme test conditions (see clauses 6.10.1 and 6.10.2 applied simultaneously), the tests shall be made at the receiver's nominal frequency and at the nominal frequency ±1,5 kHz. For these tests, the modulation shall be 1 kHz and the frequency deviation shall be ±3 kHz.

9.1.3 Limits

The rated audio frequency output power shall be at least:

- 2 W in a loudspeaker;
- 1 mW in the handset earphone.

The harmonic distortion shall not exceed 10 %.

9.2 Audio frequency response

9.2.1 Definition

The audio frequency response is the variation in the receiver's audio frequency output level as a function of the modulating frequency of the radio frequency signal with constant deviation applied to its input.

9.2.2 Method of measurement

A test signal of +60 dB μ V (emf), at a carrier frequency equal to the nominal frequency of the receiver and modulated with normal test modulation (see clause 6.3), shall be applied to the receiver antenna port under the conditions specified in clause 6.1.

The receiver's audio frequency power control shall be set so as to produce a power level equal to 50 % of the rated output power (see clause 9.1). This setting shall remain unchanged during the test.

The frequency deviation shall then be reduced to 1 kHz and the audio output is the reference point in figure 7 (1 kHz corresponds to 0 dB).

The frequency deviation shall remain constant while the modulation frequency is varied between 300 Hz and 3 kHz and the output level shall then be measured.

The measurement shall be repeated with a test signal at frequencies 1,5 kHz above and below the nominal frequency of the receiver.

The test shall be carried out on one channel only (see clause 6.6).

9.2.3 Limits

The audio frequency response shall not deviate by more than +1 dB or -3 dB from a characteristic giving the output level as a function of the audio frequency, decreasing by 6 dB per octave and passing through the measured point at 1 kHz (figure 7).

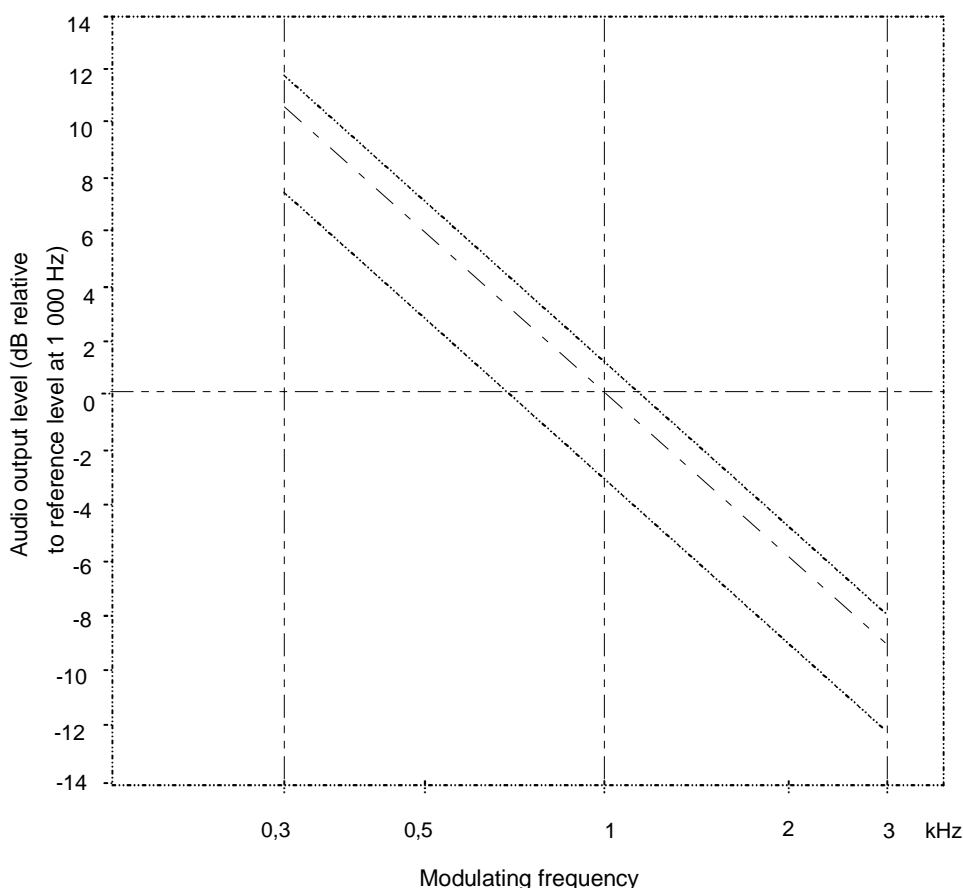

Figure 7: Audio frequency response

9.3 Maximum usable sensitivity

9.3.1 Definition

The maximum usable sensitivity of the receiver is the minimum level of the signal (emf) at the nominal frequency of the receiver which, when applied to the receiver input with normal test modulation (see clause 6.3), will produce:

- in all cases, an audio frequency output power equal to 50 % of the rated output power (see clause 9.1); and
- a SINAD ratio of 20 dB, measured at the receiver output through a psophometric telephone filtering network such as described in ITU-T Recommendation O.41 [7].

9.3.2 Method of measurement

The test shall be made on the lowest frequency channel, the highest frequency channel and on channel 16.

A test signal at a carrier frequency equal to the nominal frequency of the receiver, modulated by the normal test modulation (see clause 6.3) shall be applied to the receiver input. An audio frequency load and a measuring instrument for measuring the SINAD ratio (through a psophometric network as specified in clause 9.3.1) shall be connected to the receiver output terminals.

The level of the test signal shall be adjusted until a SINAD ratio of 20 dB is obtained, using the psophometric network and with the receiver's audio frequency power control adjusted to produce 50 % of the rated output power. Under these conditions, the level of the test signal at the input is the value of the maximum usable sensitivity.

The measurements shall be made under normal test conditions (see clause 6.9) and under extreme test conditions (see clauses 6.10.1 and 6.10.2 applied simultaneously).

A receiver output power variation of ± 3 dB relative to 50 % of the rated output power may be allowed for sensitivity measurements under extreme test conditions.

9.3.3 Limits

The maximum usable sensitivity for either 25 kHz or 12,5 kHz channels shall not exceed +6 dB μ V (emf) under normal test conditions and +12 dB μ V (emf) under extreme test conditions.

9.4 Co-channel rejection

9.4.1 Definition

The co-channel rejection is a measure of the capability of the receiver to receive a wanted modulated signal without exceeding a given degradation due to the presence of an unwanted modulated signal, both signals being at the nominal frequency of the receiver.

9.4.2 Method of measurement

The two input signals shall be connected to the receiver via a combining network (see clause 6.1). The wanted signal shall have normal test modulation (see clause 6.3). The unwanted signal shall be modulated by 400 Hz with a deviation of ± 3 kHz (see note). Both input signals shall be at the nominal frequency of the receiver under test and the measurement repeated for displacements of the unwanted signal of up to ± 3 kHz (see note).

The wanted input signal level shall be set to the value corresponding to the maximum usable sensitivity as measured in clause 9.3. The amplitude of the unwanted input signal shall then be adjusted until the SINAD ratio (psophometrically weighted) at the output of the receiver is reduced to 14 dB.

The co-channel rejection ratio shall be expressed as the ratio in dB of the level of the unwanted signal to the level of the wanted signal at the receiver input for which the specified reduction in SINAD ratio occurs.

NOTE: For 12,5 kHz channels the frequency deviation and the displacement of the unwanted signal shall be $\pm 1,5$ kHz.

9.4.3 Limit

The co-channel rejection ratio, at any frequency of the unwanted signal within the specified range, shall be between:

- -10 dB and 0 dB for 25 kHz channels;
- -12 dB and 0 dB for 12,5 kHz channels.

9.5 Adjacent channel selectivity

9.5.1 Definition

The adjacent channel selectivity is a measure of the capability of the receiver to receive a wanted modulated signal without exceeding a given degradation due to the presence of an unwanted modulated signal which differs in frequency from the wanted signal by the nominal channel spacing.

9.5.2 Method of measurement

The test shall be made on the lowest frequency channel, the highest frequency channel and on channel 16.

The two input signals shall be applied to the receiver input via a combining network (see clause 6.1). The wanted signal shall be at the nominal frequency of the receiver and shall have normal test modulation (see clause 6.3). The unwanted signal shall be modulated by 400 Hz with a deviation of ± 3 kHz for 25 kHz channels or $\pm 1,5$ kHz for 12,5 kHz channels, and shall be at the frequency of the channel immediately above that of the wanted signal.

The wanted input signal level shall be set to the value corresponding to the maximum usable sensitivity as measured in clause 9.3. The amplitude of the unwanted input signal shall then be adjusted until the SINAD ratio at the receiver output, psophometrically weighted, is reduced to 14 dB. The measurement shall be repeated with an unwanted signal at the frequency of the channel below that of the wanted signal.

The adjacent channel selectivity shall be expressed as the lower value of the ratios in dB for the upper and lower adjacent channels of the level of the unwanted signal to the level of the wanted signal.

The measurements shall then be repeated under extreme test conditions (see clauses 6.10.1 and 6.10.2 applied simultaneously) with the wanted signal set to the value corresponding to the maximum usable sensitivity under these conditions.

9.5.3 Limits

25 kHz channels: The adjacent channel selectivity shall be not less than 70 dB under normal test conditions and not less than 60 dB under extreme test conditions.

12,5 kHz channels: The adjacent channel selectivity shall be not less than 60 dB under normal test conditions and not less than 50 dB under extreme test conditions.

9.6 Spurious response rejection

9.6.1 Definition

The spurious response rejection is a measure of the capability of the receiver to discriminate between the wanted modulated signal at the nominal frequency and an unwanted signal at any other frequency at which a response is obtained.

9.6.2 Method of measurement

Two input signals shall be applied to the receiver input via a combining network (see clause 6.1). The wanted signal shall be at the nominal frequency of the receiver and shall have normal test modulation (see clause 6.3).

The unwanted signal shall be modulated by 400 Hz with a deviation of ± 3 kHz.

The wanted input signal level shall be set to the value corresponding to the maximum usable sensitivity as measured in clause 9.3. The amplitude of the unwanted input signal shall be adjusted to an emf of +86 dB μ V. The frequency shall then be swept over the frequency range from 100 kHz to 2 000 MHz.

At any frequency at which a response is obtained, the input level shall be adjusted until the SINAD ratio psophometrically weighted, is reduced to 14 dB.

The spurious response rejection ratio shall be expressed as the ratio in dB between the unwanted signal and the wanted signal at the receiver input when the specified reduction in the SINAD ratio is obtained.

9.6.3 Limit

At any frequency separated from the nominal frequency of the receiver by more than 25 kHz, the spurious response rejection ratio shall be not less than 70 dB.

9.7 Intermodulation response

9.7.1 Definition

The intermodulation response is a measure of the capability of a receiver to receive a wanted modulated signal without exceeding a given degradation due to the presence of two or more unwanted signals with a specific frequency relationship to the wanted signal frequency.

9.7.2 Method of measurement

Three signal generators, A, B and C shall be connected to the receiver via a combining network (see clause 6.1). The wanted signal, represented by signal generator A shall be at the nominal frequency of the receiver and shall have normal test modulation (see clause 6.3). The unwanted signal from signal generator B shall be unmodulated and adjusted to the frequency 50 kHz above (or below) the nominal frequency of the receiver. The second unwanted signal from signal generator C shall be modulated by 400 Hz with a deviation of ± 3 kHz, and adjusted to a frequency 100 kHz above (or below) the nominal frequency of the receiver.

The wanted input signal shall be set to a value corresponding to the maximum usable sensitivity as measured in clause 9.3. The amplitude of the two unwanted signals shall be maintained equal and shall be adjusted until the SINAD ratio at the receiver output, psophometrically weighted, is reduced to 14 dB. The frequency of signal generator B shall be adjusted slightly to produce the maximum degradation of the SINAD ratio. The level of the two unwanted test signals shall be readjusted to restore the SINAD ratio of 14 dB. The intermodulation response ratio shall be expressed as the ratio in dB between the two unwanted signals and the wanted signal at the receiver input, when the specified reduction in the SINAD ratio is obtained.

9.7.3 Limit

The intermodulation response ratio shall not be less than 68 dB.

9.8 Blocking or desensitization

9.8.1 Definition

Blocking is a change (generally a reduction) in the wanted output power of the receiver or a reduction of the SINAD ratio due to an unwanted signal on another frequency.

9.8.2 Method of measurement

Two input signals shall be applied to the receiver via a combining network (see clause 6.1). The modulated wanted signal shall be at the nominal frequency of the receiver and shall have normal test modulation (see clause 6.3). Initially the unwanted signal shall be switched off and the wanted signal set to the value corresponding to the maximum usable sensitivity.

The output power of the wanted signal shall be adjusted, where possible, to 50 % of the rated output power and in the case of stepped volume controls, to the first step that provides an output power of at least 50 % of the rated output power. The unwanted signal shall be unmodulated and the frequency shall be swept between +1 MHz and +10 MHz, and also between -1 MHz and -10 MHz, relative to the nominal frequency of the receiver. The input level of the unwanted signal, at all frequencies in the specified ranges, shall be so adjusted that the unwanted signal causes:

- a) a reduction of 3 dB in the output level of the wanted signal; or
- b) a reduction to 14 dB of the SINAD ratio at the receiver output using a psophometric telephone filtering network such as described in ITU-T Recommendation O.41 [7] whichever occurs first. This level shall be noted.

9.8.3 Limit

The blocking level for any frequency within the specified ranges, shall be not less than 90 dB μ V (emf), except at frequencies on which spurious responses are found (see clause 9.6).

9.9 Conducted spurious emissions

9.9.1 Definition

Conducted spurious emissions from the receiver are components at any frequency, present at the receiver input port.

9.9.2 Method of measurement

The level of spurious emissions shall be measured as the power level at the antenna.

Conducted spurious radiations shall be measured as the power level of any discrete signal at the input terminals of the receiver. The receiver input terminals are connected to a spectrum analyser or selective voltmeter having an input impedance of 50 Ω and the receiver is switched on.

If the detecting device is not calibrated in terms of power input, the level of any detected components shall be determined by a substitution method using a signal generator.

The measurements shall extend over the frequency range of 9 kHz to 2 GHz.

9.9.3 Limit

The power of any spurious radiation shall not exceed 2 nW at any frequency in the range between 9 kHz and 2 GHz.

9.10 Radiated spurious emissions

9.10.1 Definition

Radiated spurious emissions from the receiver are components at any frequency radiated by the equipment cabinet and the structure.

9.10.2 Method of measurements

On a test site, selected from annex C, the equipment shall be placed at the specified height on a non-conducting support and in position closest to normal use as declared by the manufacturer.

The test antenna shall be orientated for vertical polarization and the length of the test antenna shall be chosen to correspond to the instantaneous frequency of the measuring receiver.

The output of the test antenna shall be connected to a measuring receiver.

The receiver shall be switched on without modulation, and measuring receiver shall be tuned over the frequency range 30 MHz to 2 GHz.

At each frequency at which a spurious component is detected:

- a) the test antenna shall be raised and lowered through the specified range of heights until a maximum signal level is detected on the measuring receiver;
- b) the receiver shall be rotated through 360° in the horizontal plane, until the maximum signal level is detected by the measuring receiver;
- c) the maximum signal level detected by the measuring receiver shall be noted;
- d) the receiver shall be replaced by a substitution antenna as defined in annex C;
- e) the substitution antenna shall be orientated for vertical polarization and the length of the substitution antenna shall be adjusted to correspond to the frequency of the spurious component detected;
- f) the substitution antenna shall be connected to a calibrated signal generator;
- g) the frequency of the calibrated signal generator shall be set to the frequency of the spurious component detected;
- h) the input attenuator setting of the measuring receiver shall be adjusted in order to increase the sensitivity of the measuring receiver, if necessary;
- i) the test antenna shall be raised and lowered through the specified range of heights to ensure that the maximum signal is received;
- j) the input signal to the substitution antenna shall be adjusted to the level that produces a level detected by the measuring receiver that is equal to the level noted while the spurious component was measured, corrected for the change of input attenuator setting of the measuring receiver;
- k) the input level to the substitution antenna shall be recorded as power level, corrected for the change of input attenuator setting of the measuring receiver;
- l) the measurement shall be repeated with the test antenna and the substitution antenna orientated for horizontal polarization;
- m) the measure of the effective radiated power of the spurious components is larger of the two power levels recorded for spurious component at the input to the substitution antenna, corrected for the gain of the antenna if necessary.

9.10.3 Limit

The power of any spurious radiation shall not exceed 2 nW at any frequency in the range between 30 MHz and 2 GHz.

9.11 Receiver noise and hum level

9.11.1 Definition

The receiver noise and hum level is defined as the ratio, in dB, of the audio frequency power of the noise and hum resulting from spurious effects of the power supply system or from other causes, to the audio frequency power produced by a high frequency signal of average level, modulated by the normal test modulation and applied to the receiver input.

9.11.2 Method of measurement

A test signal with a level of +30 dB μ V (emf) at a carrier frequency equal to the nominal frequency of the receiver, and modulated by the normal test modulation specified in clause 6.3, shall be applied to the receiver input. An audio frequency load shall be connected to the output terminals of the receiver. The audio frequency power control shall be set so as to produce the rated output power level conforming to clause 9.1.

The output signal shall be measured by an rms voltmeter having a -6 dB bandwidth of at least 20 kHz. The modulation shall then be switched off and the audio frequency output level measured again.

9.11.3 Limit

The receiver noise and hum level shall not exceed -40 dB, relative to the modulated signal.

9.12 Squelch operation

9.12.1 Definition

The purpose of the squelch facility is to mute the receiver audio output signal when the level of the signal at the receiver input is less than a given value.

9.12.2 Method of measurement

The following procedure shall be followed:

- a) With the squelch facility switched off, a test signal of +30 dB μ V, at a carrier frequency equal to the nominal frequency of the receiver and modulated by the normal test modulation specified in clause 6.3, shall be applied to the input terminals of the receiver. An audio frequency load and a psophometric filtering network (see clause 9.3.1) shall be connected to the output terminals of the receiver. The receiver's audio frequency power control shall be set so as to produce the rated output power defined in clause 9.1.

The output signal shall be measured with the aid of an rms voltmeter.

The input signal shall then be suppressed, the squelch facility switched on and the audio frequency output level measured again;

- b) With the squelch facility switched off again, a test signal modulated by the normal test modulation shall be applied to the receiver input at a level of +6 dB μ V (emf) and the receiver shall be set to produce 50 % of the rated output power. The level of the input signal shall then be reduced and the squelch facility shall be switched on. The input signal shall then be increased until the above-mentioned output power is reached. The SINAD ratio and the input level shall then be measured.
- c) (Applicable only to equipment with continuously adjustable squelch control) with the squelch facility switched off, a test signal with normal test modulation shall be applied to the receiver input at a level of +6 dB μ V (emf), and the receiver shall be adjusted to give 50 % of the rated audio output power. The level of the input signal shall then be reduced and the squelch facility shall be switched on. The squelch shall then be at its maximum position and the level of the input signal increased until the output power again is 50 % of the rated audio output power.

9.12.3 Limits

Under the conditions specified in a) clause 9.12.2, the audio frequency output power shall not exceed -40 dB relative to the rated output power.

Under the conditions specified in b) clause 9.12.2, the input level shall not exceed +6 dB μ V (emf).

Under the conditions specified in c) clause 9.12.2, the input signal shall not exceed +6 dB μ V (emf) when the control is set at maximum.

9.13 Squelch hysteresis

9.13.1 Definition

Squelch hysteresis is the difference in dB between the receiver input signal levels at which the squelch opens and closes.

9.13.2 Method of measurement

If there is any squelch control on the exterior of the equipment it shall be placed in its maximum muted position. With the squelch facility switched on, an unmodulated input signal at a carrier frequency equal to the nominal frequency of the receiver shall be applied to the input of the receiver at a level sufficiently low to avoid opening the squelch. The input signal shall be increased to the level just opening the squelch. This input level shall be recorded. With the squelch still open, the level of the input signal shall be slowly decreased until the squelch mutes the receiver audio output again.

9.13.3 Limit

The squelch hysteresis shall be between 3 dB and 6 dB.

9.14 Multiple watch characteristic

9.14.1 Definition

The scanning period is the time between the start of two successive samples of the priority channel in the absence of a signal on that channel.

The dwell time on the priority channel is the time between the start and finish of any sample of the priority channel in the absence of a signal on that channel.

The dwell time on the additional channel is the time between the start and finish of any sample of the additional channel.

9.14.2 Method of measurement

The equipment shall be adjusted to scan the priority channel and one additional channel. The scan facilities shall not be possible on the DSC channel (channel 70).

The squelch shall be operational and so adjusted that the receiver just mutes on both the channels. A test signal at the carrier frequency equal to the nominal frequency of the additional channel of the receiver, modulated by the normal test modulation (see clause 6.3) shall be connected to the receiver via a combining network (see clause 6.1). A second test signal with a frequency equal to the nominal frequency of the priority channel having no modulation shall be connected to the receiver via the other input of the combining network. The level of the two test signals shall be +12 dB μ V (emf) at the receiver input. A storage oscilloscope shall be connected to the audio output. Initially the output of the test signal on the priority channel shall be switched off. The scanning process is started and the output observed on the oscilloscope. The gap between and the duration of the audio bursts shall be measured. Now the test signal on the priority channel shall be switched on and the scanning shall stop on the priority channel after the last burst and within the dwell time on the priority channel. The measurement shall be carried out where the additional channel is a simplex channel and repeated where it is a duplex channel.

9.14.3 Limits

The scanning period shall not exceed 2 s.

The dwell time on the priority channel shall not exceed 150 ms.

The dwell time on the additional channel shall be between 850 ms and 2 s as indicated by the time of the gap between two output bursts.

9.15 DSC audio output characteristic

9.15.1 Definition

DSC audio characteristic is the level of the two DSC tones at the DSC audio output terminal when the receiver is receiving a correctly modulated DSC signal.

9.15.2 Methods of measurement

The test shall be performed at channel 70.

The test signal at the nominal carrier frequency shall be applied to the receiver input. The signal shall be modulated by a 1 300 Hz tone to a modulation index of 2. The signal level of the generator shall be set to +26 dB μ V.

The DSC audio output terminals shall be loaded with a 600 Ω load.

The audio level at the terminals shall be measured.

The test shall be repeated with the test signal modulated by a 2 100 Hz tone maintaining the modulation index of 2.

9.15.3 Limit

The level of the audio signal developed across the load of the DSC output terminals shall be between 0,55 V rms and 1,1 V rms.

10 Duplex operation

If the equipment is designed for duplex operation, when submitted for conformance testing it shall be fitted with a duplex filter and the following additional measurements shall be carried out to ensure satisfactory duplex operation.

10.1 Receiver desensitization with simultaneous transmission and reception

10.1.1 Definition

The desensitization is the degradation of the sensitivity of the receiver resulting from the transfer of power from the transmitter to the receiver due to coupling effects.

It is expressed as the difference in dB of the maximum usable sensitivity levels with simultaneous transmission and without.

10.1.2 Method of measurement

The antenna terminal of the equipment comprising the receiver, transmitter and duplex filter shall be connected through a coupling device to the artificial antenna specified in clause 6.4.

A signal generator with normal test modulation (see clause 6.3) shall be connected to the coupling device so that it does not affect the impedance matching.

A 25 kHz duplex channel shall be selected

The transmitter shall be brought into operation at the carrier output power as defined in clause 8.2, modulated by 400 Hz with a deviation of ± 3 kHz:

- the receiver sensitivity shall then be measured in accordance with clause 9.3;
- the output level of the signal generator shall be recorded as C in dB μ V (emf);
- the transmitter shall be switched off and the receiver sensitivity is again measured;
- the output level of the signal generator shall be recorded as D in dB μ V (emf);
- the desensitization is the difference between the values of C and D.

10.1.3 Limits

The desensitization shall not exceed 3 dB. The maximum usable sensitivity under conditions of simultaneous transmission and reception shall not exceed the limits specified in clause 9.3.3.

10.2 Duplex transceiver internal mixing

10.2.1 Definition

The duplex transceiver internal mixing will result in an unwanted receiver sensitivity at certain frequencies.

10.2.2 Method of measurement

The antenna terminal of the equipment comprising of the receiver, the transmitter and duplex filter shall be connected through a coupling device to the artificial antenna specified in clause 6.4.

A test port enabling signal to be converted to the receiver shall be provided.

The equipment shall be tuned to channel 18 and the transmitter be brought in to unmodulated operation at the carrier output as defined in clause 8.2.

The test defined in clause 9.6.2 using the test port as the receiver port shall be performed. Notwithstanding the frequency mentioned in clause 9.6 the test shall only be performed in the following bands:

- 161,5 MHz - $2 \times f_i$ - 1 MHz to 161,5 MHz - $2 \times f_i$ + 1 MHz
- 161,5 MHz + $2 \times f_i$ - 1 MHz to 161,5 MHz + $2 \times f_i$ + 1 MHz
- 155,9 MHz to 157,9 MHz

f_i is the centre frequency of the first intermediate frequency of the receiver to be stated by the manufacturer.

10.2.3 Limits

At any frequency at which a response is detected the ratio defined in clause 9.6.2 shall be not less than 70 dB.

Annex A (normative): Measuring receiver for adjacent channel power measurement

A.1 Power measuring receiver specification

The power measuring receiver consists of a mixer, an IF filter, and oscillator, an amplifier, a variable attenuator and an rms value indicator. Instead of the variable attenuator with the rms value indicator it is also possible to use an rms voltmeter calibrated in dB. The technical characteristics of the power measuring receiver are given in figure A.1. See also ITU-R Recommendation SM.332-4 [11].

A.1.1 IF filter

The IF filter shall be within the limits of the following selectivity characteristic.

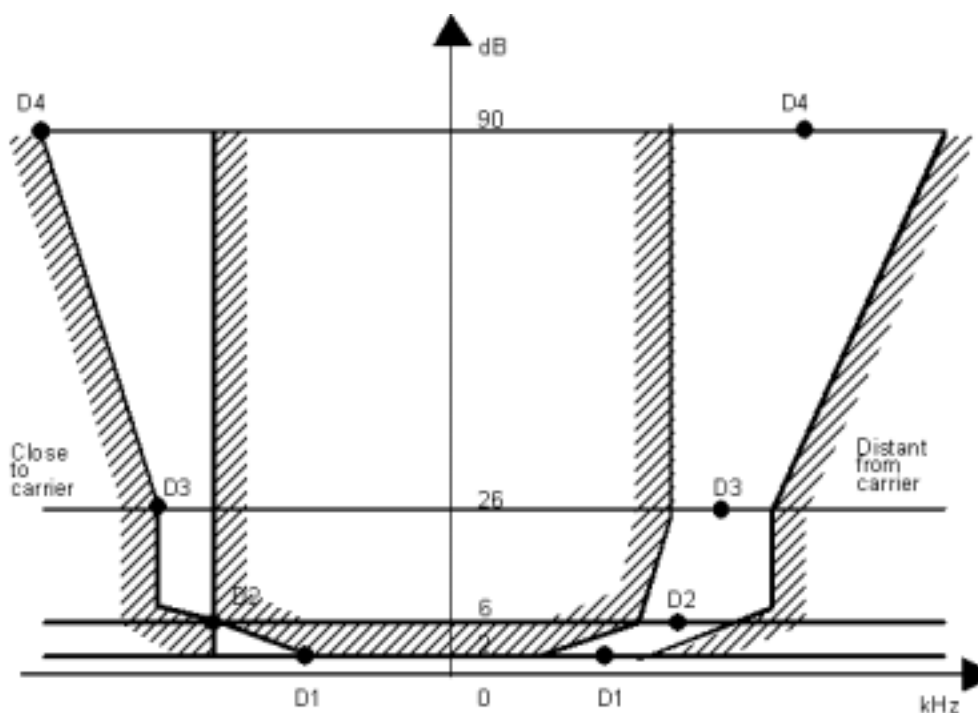

Figure A.1

The selectivity characteristic shall keep the frequency separations shown in table A.1 from the nominal centre frequency of the adjacent channel.

Table A.1: Selectivity characteristic

Channel separation (kHz)	Frequency separation of filter curve from nominal centre frequency of adjacent channel (kHz)			
	D1	D2	D3	D4
12,5	3	4,25	5,5	9,5
25	5	8,0	9,25	13,25

The attenuation points shall not exceed following tolerances shown in table A.2.

Table A.2: Tolerance of attenuation points close to carrier

Channel separation (kHz)	Tolerance range (kHz)			
	D1	D2	D3	D4
12,5	+1,35	$\pm 0,1$	-1,35	-5,35
25	+3,1	$\pm 0,1$	-1,35	-5,35

Table A.3: Tolerance of attenuation points distant from the carrier

Channel separation (kHz)	Tolerance range (kHz)			
	D1	D2	D3	D4
12,5	$\pm 2,0$	$\pm 2,0$	$\pm 2,0$	+2,0 -6,0
25	$\pm 3,5$	$\pm 3,5$	$\pm 3,5$	+3,5 -7,5

The minimum attenuation of the filter outside the 90 dB attenuation points shall be equal to or greater than 90 dB.

A.1.2 Attenuation indicator

The attenuation indicator shall have a minimum range of 80 dB and a reading accuracy of 1 dB. With a view to future regulations the attenuation should be 90 dB or more.

A.1.3 RMS value indicator

The instrument shall accurately indicate non-sinusoidal signals in a ratio of up to 10:1 between peak value and rms value.

A.1.4 Oscillator and amplifier

The oscillator and the amplifier shall be designed in such a way that the measurement of the adjacent channel power of a low-noise unmodulated transmitter, whose self-noise has a negligible influence on the measurement result, yields a measured value of < -90 dB.

Annex B (normative): Protocol for the IEC 1162-1 commands Frequency Set Information (FSI)

B.1 Frequency Set Information (FSI)

This sentence is used to set frequency, mode of operation and transmitter power level of a radiotelephone, to read out frequencies, mode and power and to acknowledge setting commands.

\$--FSI,xxxxxx,xxxxxx,c,x*hh<CR><LF>

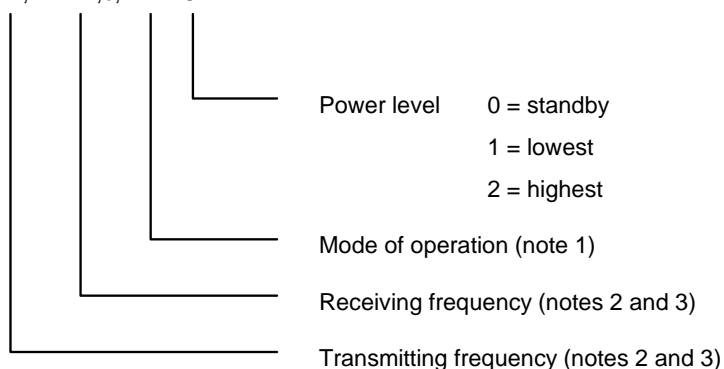

NOTE 1: Mode of operation:

- d = F3E/G3E simplex, telephone;
- e = F3E/G3E duplex, telephone;
- m = J3E, telephone;
- o = H3E, telephone;
- q = F1B/J2B FEC NBDP, TELEX/teleprinter;
- s = F1B/J2B ARQ NBDP, TELEX/teleprinter;
- t = F1B/J2B receive only, teleprinter/DSC;
- w = F1B/J2B, teleprinter/DSC;
- x = A1A Morse, tape recorder;
- { = A1A Morse, morse key/head set;
- | = F1C/F2C/F3C, FAX-machine;
- null for no information.

NOTE 2: Frequencies to be in 100 Hz increments:

MF/HF telephone channels shall have first digit 3 followed by ITU channel numbers with leading zeros as required;

MF/HF teletype channels shall have first digit 4; the second and third digit frequency bands; and the fourth to sixth digits ITU channel numbers; each with leading zeros as required.

VHF channels shall have the first digit 9 followed by channel numbers with leading zeros as required.

NOTE 3: For paired frequencies the transmitting frequency only need to be included; null for receiving frequency field. For receive frequencies only, the transmitting frequency field shall be null.

Figure B.1: Frequency set information

Annex C (normative): Radiated measurements

C.1 Test sites and general arrangements for measurements involving the use of radiated fields

C.1.1 Outdoor test site

The outdoor test site shall be on a reasonably level surface or ground. At one point on the site, a ground plane of at least 5 m diameter shall be provided. In the middle of this ground plane, a non-conducting support, capable of rotation through 360° in the horizontal plane, shall be used to support the test sample at 1,5 m above the ground plane. The test site shall be large enough to allow the erection of a measuring or transmitting antenna at a distance of $\lambda/2$ or 3 m whichever is the greater. The distance actually used shall be recorded with the results of the tests carried out on the site.

Sufficient precautions shall be taken to ensure that reflections from extraneous objects adjacent to the site and ground reflections do not degrade the measurements results.

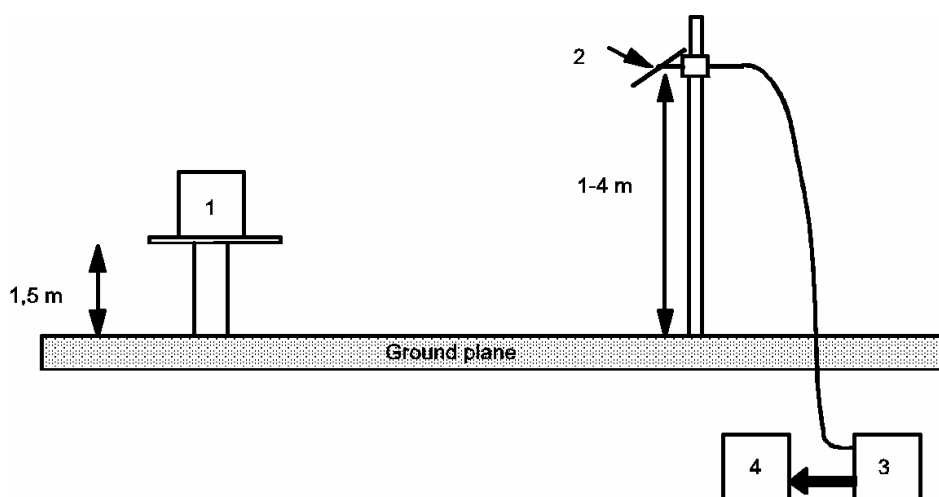

Key:

- 1 Equipment under test.
- 2 Test antenna.
- 3 High pass filter (necessary for strong fundamental Tx radiation).
- 4 Spectrum analyser or measuring receiver.

Figure C.1

C.1.2 Test antenna

The test antenna is used to detect the radiation from both the test sample and the substitution antenna, when the site is used for radiation measurements; where necessary, it is used as a transmitting antenna, when the site is used for the measurement of receiver characteristics.

This antenna is mounted on a support such as to allow the antenna to be used in either horizontal or vertical polarization and for the height of its centre above ground to be varied over the range 1 m to 4 m. Preferably a test antenna with pronounced directivity should be used. The size of the test antenna along the measurement axis shall not exceed 20 % of the measuring distance.

For receiver and transmitter radiation measurements, the test antenna is connected to a measuring receiver, capable of being tuned to any frequency under investigation and of measuring accurately the relative levels of signals at its input. For receiver radiated sensitivity measurements the test antenna is connected to a signal generator.

C.1.3 Substitution antenna

When measuring in the frequency range up to 1 GHz the substitution antenna shall be a $\lambda/2$ dipole, resonant at the frequency under consideration, or a shortened dipole, calibrated to the $\lambda/2$ dipole. When measuring in the frequency range above 4 GHz a horn radiator shall be used. For measurements between 1 GHz and 4 GHz either a $\lambda/2$ dipole or a horn radiator may be used. The centre of this antenna shall coincide with the reference point of the test sample it has replaced. This reference point shall be the volume centre of the sample when its antenna is mounted inside the cabinet, or the point where an external antenna is connected to the cabinet.

The distance between the lower extremity of the dipole and the ground shall be at least 0,3 m.

The substitution antenna shall be connected to a calibrated signal generator when the site is used for spurious radiation measurements and transmitter effective radiated power measurements. The substitution antenna shall be connected to a calibrated measuring receiver when the site is used for the measurement of receiver sensitivity.

The signal generator and the receiver shall be operating at the frequencies under investigation and shall be connected to the antenna through suitable matching and balancing networks.

NOTE: The gain of a horn antenna is generally expressed relative to an isotropic radiator.

C.1.4 Optional additional indoor site

When the frequency of the signals being measured is greater than 80 MHz, use may be made of an indoor site. If this alternative site is used, this shall be recorded in the test report.

The measurement site may be a laboratory room with a minimum area of 6 m by 7 m and at least 2,7 m in height.

Apart from the measuring apparatus and the operator, the room shall be as free as possible from reflecting objects other than the walls, floor and ceiling.

The potential reflections from the wall behind the equipment under test are reduced by placing a barrier of absorbent material in front of it. The corner reflector around the test antenna is used to reduce the effect of reflections from the opposite wall and from the floor and ceiling in the case of horizontally polarized measurements. Similarly, the corner reflector reduces the effects of reflections from the side walls for vertically polarized measurements. For the lower part of the frequency range (below approximately 175 MHz) no corner reflector or absorbent barrier is needed. For practical reasons, the $\lambda/2$ antenna in figure C.2 may be replaced by an antenna of constant length, provided that this length is between $\lambda/4$ and λ at the frequency of measurement and the sensitivity of the measuring system is sufficient. In the same way the distance of $\lambda/2$ to the apex may be varied.

The test antenna, measuring receiver, substitution antenna and calibrated signal generator are used in a way similar to that of the general method.

To ensure that errors are not caused by the propagation path approaching the point at which phase cancellation between direct and the remaining reflected signals occurs, the substitution antenna shall be moved through a distance of $\pm 0,1$ m in the direction of the test antenna as well as in the two directions perpendicular to this first direction.

If these changes of distance cause a signal change of greater than 2 dB, the test sample should be re-sited until a change of less than 2 dB is obtained.

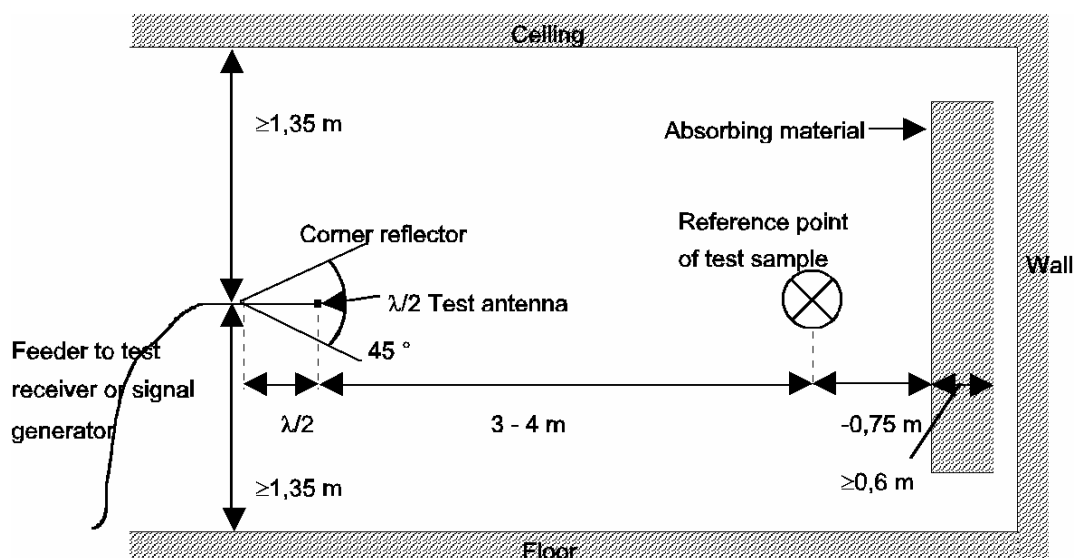

Figure C.2: Indoor site arrangement (shown for horizontal polarization)

C.2 Guidance on the use of radiation test sites

For measurements involving the use of radiated fields, use may be made of a test site in conformity with the requirements of clause C.1. When using such a test site, the following conditions should be observed to ensure consistency of measuring results.

C.2.1 Measuring distance

Evidence indicates that the measuring distance is not critical and does not significantly affect the measuring results, provided that the distance is not less than $\lambda/2$ at the frequency of measurement, and the precautions described in this annex are observed. Measuring distances of 3 m, 5 m, 10 m and 30 m are in common use in European test laboratories.

C.2.2 Test antenna

Different types of test antenna may be used, since performing substitution measurements reduces the effect of the errors on the measuring results.

Height variation of the test antenna over a range of 1 m to 4 m is essential in order to find the point at which the radiation is a maximum.

Height variation of the test antenna may not be necessary at the lower frequencies below about 100 MHz.

C.2.3 Substitution antenna

Variations in the measuring results may occur with the use of different types of substitution antenna at the lower frequencies below about 80 MHz.

Where a shortened dipole antenna is used at these frequencies, details of the type of antenna used should be included with the results of the tests carried out on the site. Correction factors shall be taken into account when shortened dipole antennas are used.

C.2.4 Artificial antenna

The dimensions of the artificial antenna used during radiated measurements should be small in relation to the sample under test.

Where possible, a direct connection should be used between the artificial antenna and the test sample.

In cases where it is necessary to use a connecting cable, precautions should be taken to reduce the radiation from this cable by, for example, the use of ferrite cores or double screened cables.

C.2.5 Auxiliary cables

The position of auxiliary cables (power supply and microphone cables etc.) which are not adequately decoupled may cause variations in the measuring results. In order to get reproducible results, cables and wires of auxiliaries should be arranged vertically downwards (through a hole in the non conducting support).

C.2.6 Acoustic measuring arrangement

When carrying out measurements of the maximum usable sensitivity (radiated) of the receiver, the audio output shall be monitored by acoustically coupling the audio signal from the receiver loudspeaker/transducer to the test microphone. On the radiation test site all conducting materials shall be placed below the ground surface and the acoustic signal is conveyed from the receiver to the test microphone in a non-conducting acoustic pipe.

The acoustic pipe shall have an appropriate length. The acoustic pipe shall have an inner diameter of 6 mm and a wall thickness of 1,5 mm. A plastic funnel of a diameter corresponding to the receiver loudspeaker/transducer shall be attached to the receiver surface centred in front of the receiver loudspeaker/transducer. The plastic funnel shall be very soft at the attachment point to the receiver in order to avoid mechanical resonance. The narrow end of the plastic funnel shall be connected to the one end of the acoustic pipe and the test microphone to the other.

C.3 Further optional alternative indoor test site using an anechoic chamber

For radiation measurements when the frequency of the signals being measured is greater than 30 MHz, use may be made of an indoor site being a well-shielded anechoic chamber simulating free space environment. If such a chamber is used, this shall be recorded in the test report.

The test antenna, measuring receiver, substitution antenna and calibrated signal generator are used in a way similar to that of the general method, clause C.1. In the range between 30 MHz and 100 MHz some additional calibration may be necessary.

An example of a typical measurement site may be an electrically shielded anechoic chamber being 10 m long, 5 m broad and 5 m high.

Walls and ceiling should be coated with RF absorbers of 1 m height.

The base should be covered with absorbing material 1 m thick, and a wooden floor, able to carry test equipment and operators.

A measuring distance of 3 m to 5 m in the long middle axis of the chamber can be used for measurements up to 12,75 GHz.

The construction of the anechoic chamber is described in the following clauses.

C.3.1 Example of the construction of a shielded anechoic chamber

Free-field measurements can be simulated in a shielded measuring chamber where the walls are coated with RF absorbers.

Figure C.3 shows the requirements for shielding loss and wall return loss of such a room.

As dimensions and characteristics of usual absorber materials are critical below 100 MHz (height of absorbers < 1 m, reflection attenuation < 20 dB) such a room is preferably suitable for measurements above 100 MHz.

Figure C.4 shows the construction of a shielded measuring chamber having a base area of 5 m by 10 m and a height of 5 m.

Ceilings and walls are coated with pyramidal formed absorbers approximately 1 m high. The base is covered with absorbers which are able to carry and which forms a sort of floor.

The available internal dimensions of the room are 3 m x 8 m x 3 m, so that a measuring distance of maximum 5 m length in the middle axis of this room is available.

At 100 MHz the measuring distance can be extended up to a maximum of 2 lambda.

The floor absorbers reject floor reflections so that the antenna height need not be changed and floor reflection influences need not be considered.

All measuring results can therefore be checked with simple calculations and the measuring tolerances have the smallest possible values due to the simple measuring configuration.

For special measurements it can be necessary to re-introduce floor reflections. Taking away the floor absorbers would mean a removal of approximately 24 m³ absorber material. Therefore the floor absorbers are covered with metal plates of metallic nets instead.

C.3.2 Influence of parasitic reflections in anechoic chambers

For free-space propagation in the far field condition the correlation $E = E_0 (R_0 / R)$ is valid for the dependence of the field strength E on the distance R , whereby E_0 is the reference field strength in the reference distance R_0 .

It is useful to use just this correlation for comparison measurements, as all constants are eliminated with the ratio and neither cable attenuation nor antenna mismatch or antenna dimensions are of importance.

Deviations from the ideal curve can be seen easily if the logarithm of the above equation is used, because the ideal correlation of field strength and distance can then be shown as a straight line and the deviations occurring in practice are clearly visible. This indirect method shows the disturbances due to reflections more readily and is far less problematical than the direct measurement of reflection attenuation.

With an anechoic chamber of the dimensions suggested in clause C.3 at low frequencies up to 100 MHz there are no far field conditions, and therefore reflections are stronger so that careful calibration is necessary.

In the medium frequency range from 100 MHz to 1 GHz the dependence of the field strength on the distance meets the expectations very well.

In the frequency range of 1 GHz to 12,75 GHz, because more reflections will occur, the dependence of the field strength on the distance will not correlate so closely.

C.3.3 Calibration of the shielded anechoic chamber

Careful calibration of the chamber shall be performed over the range 30 MHz to 12,75 GHz.

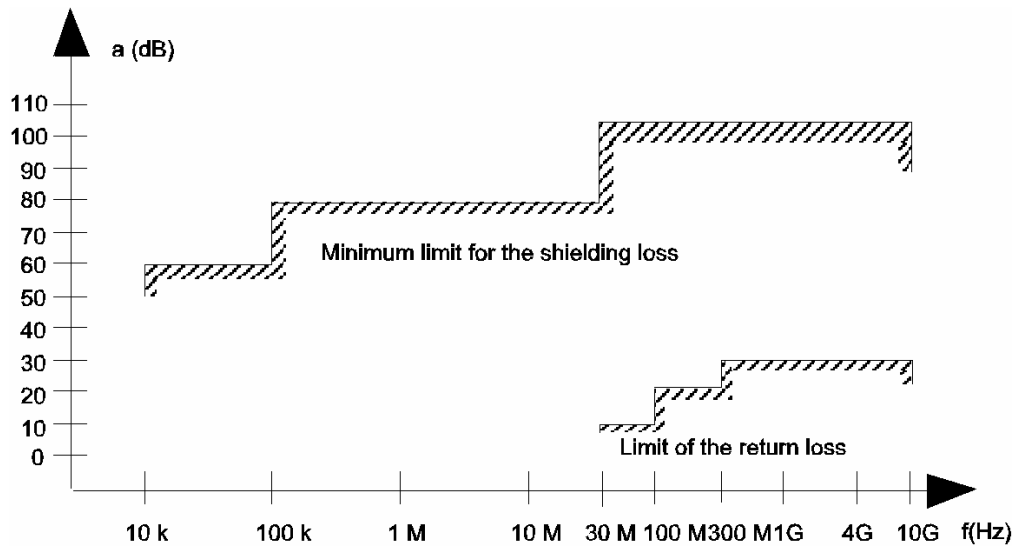
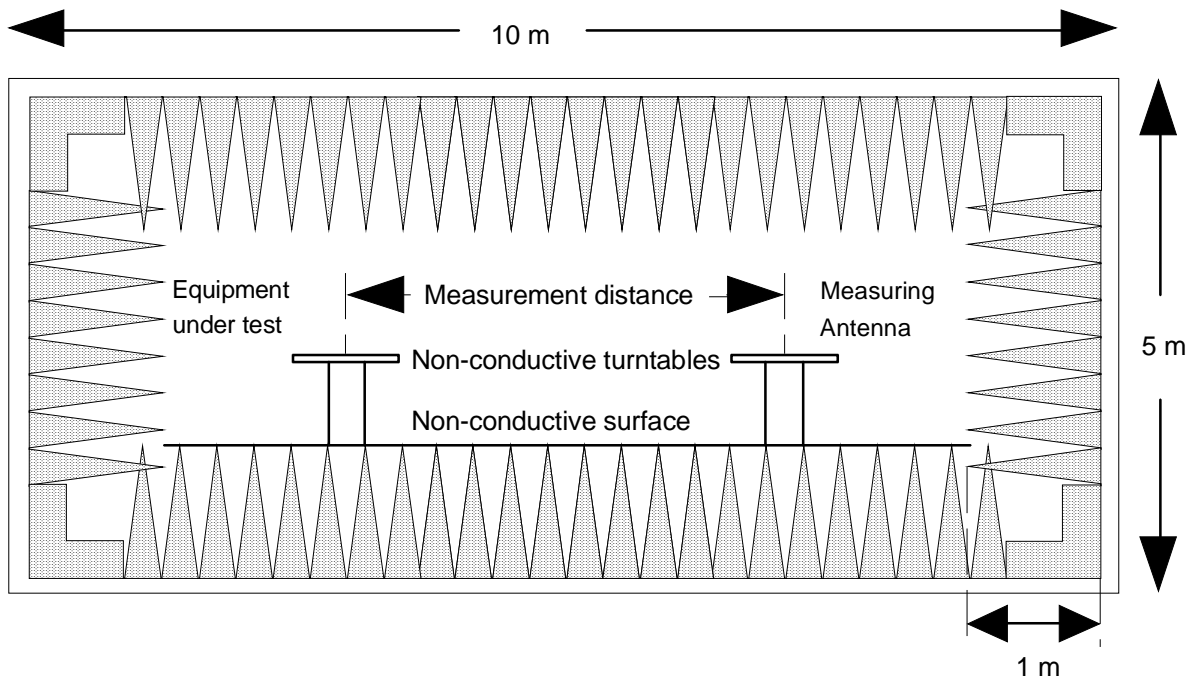

Figure C.3: Specifications for shielding and reflections



Ground plan

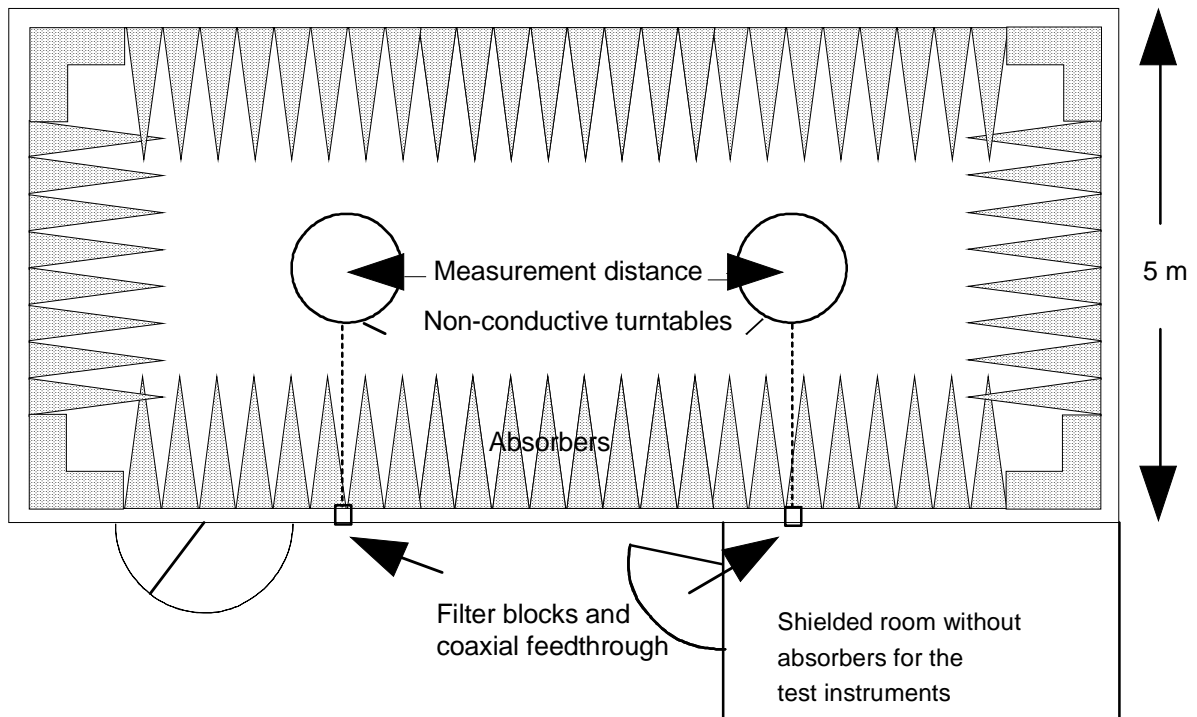

Figure C.4: Example of construction of an anechoic shielded chamber

History

Document history		
Edition 1	October 1993	Publication as ETS 300 162
Edition 2	March 1998	Publication as ETS 300 162
V1.2.2	December 2000	Publication
V1.3.1	December 2003	Publication
V1.4.1	May 2005	Public Enquiry PE 20050923: 2005-05-25 to 2005-09-23