



**User Group;
Quality of ICT services;
Definitions and methods for assessing the QoS parameters
of the customer relationship stages other than utilization**

Reference

REG/USER-00039

Keywords

QoS, USER

ETSI

650 Route des Lucioles
F-06921 Sophia Antipolis Cedex - FRANCE

Tel.: +33 4 92 94 42 00 Fax: +33 4 93 65 47 16

Siret N° 348 623 562 00017 - NAF 742 C
Association à but non lucratif enregistrée à la
Sous-Préfecture de Grasse (06) N° 7803/88

Important notice

Individual copies of the present document can be downloaded from:

<http://www.etsi.org>

The present document may be made available in more than one electronic version or in print. In any case of existing or perceived difference in contents between such versions, the reference version is the Portable Document Format (PDF). In case of dispute, the reference shall be the printing on ETSI printers of the PDF version kept on a specific network drive within ETSI Secretariat.

Users of the present document should be aware that the document may be subject to revision or change of status. Information on the current status of this and other ETSI documents is available at

<http://portal.etsi.org/tb/status/status.asp>

If you find errors in the present document, please send your comment to one of the following services:

http://portal.etsi.org/chaicor/ETSI_support.asp

Copyright Notification

No part may be reproduced except as authorized by written permission.
The copyright and the foregoing restriction extend to reproduction in all media.

© European Telecommunications Standards Institute 2013.
All rights reserved.

DECT™, PLUGTESTS™, UMTS™ and the ETSI logo are Trade Marks of ETSI registered for the benefit of its Members.
3GPP™ and LTE™ are Trade Marks of ETSI registered for the benefit of its Members and
of the 3GPP Organizational Partners.
GSM® and the GSM logo are Trade Marks registered and owned by the GSM Association.

Contents

Intellectual Property Rights	21
Foreword.....	21
Introduction	21
1 Scope	23
2 References	23
2.1 Normative references	23
2.2 Informative references.....	23
3 Definitions, symbols and abbreviations	24
3.1 Definitions	24
3.2 Symbols.....	27
3.3 Abbreviations	30
4 Common Basis for QoS parameter assessment	30
4.1 Opinion Rating	31
4.1.1 Definition of OR	31
4.1.2 Example	31
4.2 Selection of an appropriate data source	32
4.2.1 Expert panel	32
4.2.2 Customer survey	33
4.2.3 Service provider data	34
4.3 Samples sizes and examples	34
4.3.1 Statistical considerations.....	35
4.3.1.1 Low sample sizes	35
4.3.1.2 Medium sample sizes	36
4.3.1.3 Large sample sizes	36
4.3.2 Mean value versus Median	38
4.3.3 Confidence level	39
4.3.4 Accuracy of indicators	39
4.3.5 Observation period.....	39
4.3.6 Selection of Panels.....	40
4.3.7 Determination of boundary conditions prior to assessment of parameters	40
4.4 Guidance on the presentation of the results.....	40
4.4.1 Histogram	41
4.4.2 Distribution Functions	41
4.4.3 Mean value.....	41
4.4.4 Quantile	41
4.4.5 Chart	41
4.4.6 Choice of the best suited presentations	41
5 Parameter Definitions.....	41
5.1 Customer Relationship Stage: Preliminary information (PI).....	42
5.1.1 P101: Integrity of PI [OR]	42
5.1.1.1 Definition of Parameter.....	42
5.1.1.1.1 Explanation on Parameter Definition	42
5.1.1.1.2 Equation	43
5.1.1.1.3 Measure	43
5.1.2 P102: Pricing transparency [OR]	43
5.1.2.1 Definition of Parameter.....	43
5.1.2.1.1 Explanation on Parameter Definition	43
5.1.2.1.2 Equation	44
5.1.2.1.3 Measure	44
5.1.3 P103: Availability of PI [%]	44
5.1.3.1 Definition of Parameter.....	44
5.1.3.1.1 Explanation on Parameter Definition	44
5.1.3.2 Equation	44

5.1.3.3	Measure	45
5.1.4	P104: Response time for the provision of PI [Time]	45
5.1.4.1	Definition of Parameter	45
5.1.4.1.1	Explanation on Parameter Definition	45
5.1.4.2	Equation	45
5.1.4.3	Measure	45
5.1.5	P105: Response time of the commercial desk [Time & %]	45
5.1.6	P106: Overall rating of the responsiveness of the service desk [OR]	46
5.1.7	P107: User friendliness of the Internet user interface [OR]	46
5.1.8	P108: User friendliness of the service desk operators [OR]	46
5.2	Customer Relationship Stage: Contract Establishment	46
5.2.1	P201: Integrity of contract information [OR]	47
5.2.1.1	Definition of Parameter	47
5.2.1.1.1	Explanation on Parameter Definition	47
5.2.1.2	Equation	47
5.2.1.3	Measure	48
5.2.2	P202: Compliance of contractual terms with PI [%]	48
5.2.2.1	Definition of Parameter	48
5.2.2.1.1	Explanation on Parameter Definition	48
5.2.2.2	Equation	48
5.2.2.3	Measure	48
5.2.3	P203: Flexibility for customisation before contract [OR]	48
5.2.3.1	Definition of Parameter	48
5.2.3.1.1	Explanation on Parameter Definition	49
5.2.3.2	Equation	49
5.2.3.3	Measure	49
5.2.4	P204: Ease and flexibility to amend terms after formal contract [OR]	49
5.2.4.1	Definition of Parameter	49
5.2.4.1.1	Explanation on Parameter Definition	49
5.2.4.2	Equation	49
5.2.4.3	Measure	49
5.2.5	P205: Response time of the commercial desk [Time & %]	49
5.2.6	P206: Delay to settle a contract [Time & %]	50
5.2.7	P207: Delay for a contract acknowledgment [Time & %]	50
5.2.8	P208: Overall rating of the responsiveness of the sales desk [OR]	50
5.2.9	P209: Ease of the subscription process [OR]	50
5.2.10	P210: Vendors empathy and responsiveness [OR]	50
5.3	Customer Relationship Stage: Service provisioning	50
5.3.1	P301: Meeting promised provisioning date [%]	53
5.3.1.1	Definition of Parameter	53
5.3.1.1.1	Explanation on Parameter Definition	53
5.3.1.2	Equation	53
5.3.1.3	Measure	53
5.3.2	P302: Time for provisioning [Time]	54
5.3.2.1	Definition of Parameter	54
5.3.2.1.1	Explanation on Parameter Definition	54
5.3.2.2	Equation	54
5.3.2.3	Measure	54
5.3.3	P303: Successful provisioning within specified period [%]	54
5.3.3.1	Definition of Parameter	54
5.3.3.1.1	Explanation on Parameter Definition	54
5.3.3.2	Equation	54
5.3.3.3	Measure	55
5.3.4	P304: Contract cancelled due to non fulfilment [%]	55
5.3.4.1	Definition of Parameter	55
5.3.4.1.1	Explanation on Parameter Definition	55
5.3.4.2	Equation	55
5.3.4.3	Measure	56
5.3.5	P305: Completeness of fulfilment of contractual specification in the provision of a service [%]	56
5.3.5.1	Definition of Parameter	56
5.3.5.1.1	Explanation on Parameter Definition	56
5.3.5.2	Equation	56

5.3.5.3	Measure	56
5.3.6	P306: Punctuality of service provisioning [Time]	56
5.3.6.1	Definition of Parameter	56
5.3.6.1.1	Explanation on Parameter Definition	56
5.3.6.2	Equation	57
5.3.6.3	Measure	57
5.3.7	P307: Punctuality of equipment delivery for service provisioning [Time]	57
5.3.7.1	Definition of Parameter	57
5.3.7.1.1	Explanation on Parameter Definition	57
5.3.7.2	Equation	57
5.3.7.3	Measure	58
5.3.8	P308: Provisioning not complete and correct first time [%]	58
5.3.8.1	Definition of Parameter	58
5.3.8.1.1	Explanation on Parameter Definition	58
5.3.8.2	Equation	58
5.3.8.3	Measure	58
5.3.9	P309: Provisioning time [Time & %]	59
5.3.10	P310: Overall quality of the provisioning process including the reception desk [OR]	59
5.3.11	P311: Provider ability to match the customer's wishes for conditions of achievement [OR]	59
5.3.12	P312: User friendliness of the means available to the customer for the operations he has to perform [OR]	59
5.3.13	P313: Portage delay (when applicable) [Time & %]	59
5.3.14	P314: Proportion of problems with number portability procedures [%]	59
5.4	Customer Relationship Stage: Service alteration	60
5.4.1	P401: Time for alteration [Time]	61
5.4.1.1	Definition of Parameter	61
5.4.1.1.1	Explanation on Parameter Definition	61
5.4.1.2	Equation	62
5.4.1.3	Measure	62
5.4.2	P402: Successful service alteration within specified period [%]	62
5.4.2.1	Definition of Parameter	62
5.4.2.1.1	Explanation on Parameter Definition	62
5.4.2.2	Equation	62
5.4.2.3	Measure	63
5.4.3	P403: Completeness of fulfilment of contractual specification in the alteration of a service [%]	63
5.4.3.1	Definition of Parameter	63
5.4.3.1.1	Explanation on Parameter Definition	63
5.4.3.2	Equation	63
5.4.3.3	Measure	63
5.4.4	P404: Punctuality of appointments for service alteration [Time]	63
5.4.4.1	Definition of Parameter	63
5.4.4.1.1	Explanation on Parameter Definition	64
5.4.4.2	Equation	64
5.4.4.3	Measure	64
5.4.5	P405: Punctuality of equipment delivery for service alteration [Time]	64
5.4.5.1	Definition of Parameter	64
5.4.5.1.1	Explanation on Parameter Definition	64
5.4.5.2	Equation	64
5.4.5.3	Measure	65
5.4.6	P406: Service alteration not complete and correct first time [%]	65
5.4.6.1	Definition of Parameter	65
5.4.6.1.1	Explanation on Parameter Definition	65
5.4.6.2	Equation	65
5.4.6.3	Measure	65
5.4.7	P407: Conformity and success of service alteration [%]	65
5.4.7.1	Definition of Parameter	65
5.4.7.1.1	Explanation on Parameter Definition	66
5.4.7.2	Equation	66
5.4.7.3	Measure	66
5.4.8	P408: Technical reliability of service within an agreed period after alteration [%]	66
5.4.8.1	Definition of Parameter	66
5.4.8.1.1	Explanation on Parameter Definition	66

5.4.8.2	Equation	66
5.4.8.3	Measure	66
5.4.9	P409: Response time of the alteration service [Time & %]	67
5.4.10	P410: Overall quality of the alteration process [OR]	67
5.4.11	P411: User friendliness of the means available to the customer for the operations he has to perform [OR]	67
5.4.12	P412: Organisational efficiency of service provider to carry out service alteration (SPO) [OR]	67
5.4.12.1	Definition of Parameter	67
5.4.12.1.1	Explanation on Parameter Definition	67
5.4.12.2	Equation	67
5.4.12.3	Measure	67
5.5	Customer Relationship Stage: Technical upgrade	68
5.5.1	P501: Time for technical upgrade of a service [Time]	70
5.5.1.1	Definition of Parameter	70
5.5.1.1.1	Explanation on Parameter Definition	70
5.5.1.2	Equation	70
5.5.1.3	Measure	70
5.5.2	P502: Successful technical upgrade within a specified period [%]	70
5.5.2.1	Definition of Parameter	70
5.5.2.1.1	Explanation on Parameter Definition	70
5.5.2.2	Equation	71
5.5.2.3	Measure	71
5.5.3	P503: Completeness of fulfilment of specification in the technical upgrade of a service [%]	71
5.5.3.1	Definition of Parameter	71
5.5.3.1.1	Explanation on Parameter Definition	71
5.5.3.2	Equation	71
5.5.3.3	Measure	72
5.5.4	P504: Punctuality of appointments for technical upgrade [Time]	72
5.5.4.1	Definition of Parameter	72
5.5.4.1.1	Explanation on Parameter Definition	72
5.5.4.2	Equation	72
5.5.4.3	Measure	72
5.5.5	P505: Outage time due to technical upgrade [Time]	72
5.5.5.1	Definition of Parameter	72
5.5.5.1.1	Explanation on Parameter Definition	73
5.5.5.2	Equation	73
5.5.5.3	Measure	73
5.5.6	P506: Technical upgrade not complete and correct first time [%]	73
5.5.6.1	Definition of Parameter	73
5.5.6.1.1	Explanation on Parameter Definition	73
5.5.6.2	Equation	73
5.5.6.3	Measure	74
5.5.7	P507: Conformity and success of technical upgrade [%]	74
5.5.7.1	Definition of Parameter	74
5.5.7.1.1	Explanation on Parameter Definition	74
5.5.7.2	Equation	74
5.5.7.3	Measure	74
5.5.8	P508: Technical reliability of service within an agreed period after technical upgrade [%]	74
5.5.8.1	Definition of Parameter	74
5.5.8.1.1	Explanation on Parameter Definition	74
5.5.8.2	Equation	75
5.5.8.3	Measure	75
5.5.9	P509: Overall quality of the technical upgrade process [OR]	75
5.5.10	P510: Provider ability to match the customer's wishes for conditions of achievement [OR]	75
5.5.11	P511: User friendliness of the means available to the customer for the operations he has to perform [OR]	75
5.5.12	P512: Organisational efficiency of SP to carry out technical upgrade (SPO) [OR]	75
5.5.12.1	Definition of Parameter	75
5.5.12.1.1	Explanation on Parameter Definition	76
5.5.12.2	Equation	76
5.5.12.3	Measure	76
5.5.13	P513: Competence and preparedness of SP for technical upgrade (SPO) [OR]	76

5.5.13.1	Definition of Parameter.....	76
5.5.13.1.1	Explanation on Parameter Definition	76
5.5.13.2	Equation	76
5.5.13.3	Measure	76
5.6	Customer Relationship Stage: Service Support.....	76
5.6.1	Documentation.....	77
5.6.1.1	P611: Documentation delivery time [Time].....	77
5.6.1.1.1	Definition of Parameter	77
5.6.1.1.2	Equation.....	77
5.6.1.1.3	Measure	78
5.6.1.2	P612: Availability of documentation within specified period of time [%].....	78
5.6.1.2.1	Definition of Parameter	78
5.6.1.2.2	Equation.....	78
5.6.1.2.3	Measure	78
5.6.1.3	P613: Integrity (correctness and completeness) of documentation [OR].....	79
5.6.1.3.1	Definition of Parameter	79
5.6.1.3.2	Equation.....	79
5.6.1.3.3	Measure	79
5.6.1.4	P614: Modes of documentation [Number].....	79
5.6.1.4.1	Definition of Parameter	79
5.6.1.4.2	Equation.....	80
5.6.1.4.3	Measure	80
5.6.1.5	P615: Legibility of documentation [OR].....	80
5.6.1.5.1	Definition of Parameter	80
5.6.1.5.2	Equation.....	80
5.6.1.5.3	Measure	80
5.6.1.6	P616: Overall reliability of documentation services [OR]	80
5.6.1.6.1	Definition of Parameter	80
5.6.1.6.2	Equation.....	81
5.6.1.6.3	Measure	81
5.6.2	Technical support.....	81
5.6.2.1	P621: Accessibility of the technical support [%]	82
5.6.2.1.1	Definition of Parameter	82
5.6.2.1.1.1	Explanation on Parameter Definition.....	82
5.6.2.1.2	Equation.....	82
5.6.2.1.3	Measure	82
5.6.2.2	P622: Technical solutions achieved within a specified period [%]	82
5.6.2.2.1	Definition of Parameter	82
5.6.2.2.1.1	Explanation on Parameter Definition.....	82
5.6.2.2.2	Equation.....	83
5.6.2.2.3	Measure	83
5.6.2.3	P623: Number of attempts before successful solution [Number].....	83
5.6.2.3.1	Definition of Parameter	83
5.6.2.3.1.1	Explanation on Parameter Definition.....	83
5.6.2.3.2	Equation.....	83
5.6.2.3.3	Measure	83
5.6.2.4	P624: Integrity of technical solutions [OR]	83
5.6.2.4.1	Definition of Parameter	83
5.6.2.4.1.1	Explanation on Parameter Definition.....	84
5.6.2.4.2	Equation.....	84
5.6.2.4.3	Measure	84
5.6.2.5	P625: Reliability of technical solutions achieved [%]	84
5.6.2.5.1	Definition of Parameter	84
5.6.2.5.1.1	Explanation on Parameter Definition.....	84
5.6.2.5.2	Equation.....	84
5.6.2.5.3	Measure	85
5.6.2.6	P626: Modes of technical support [Number]	85
5.6.2.6.1	Definition of Parameter	85
5.6.2.6.1.1	Explanation on Parameter Definition.....	85
5.6.2.6.2	Equation.....	85
5.6.2.6.3	Measure	85
5.6.2.7	P627: Recognition of the customer technical request [%]	85

5.6.2.8	P628: Response time of the technical support [Time & %]	85
5.6.2.9	P629: Request to technical support resolution time [Time & %]	86
5.6.2.10	P630: Number of customer requests to technical support [Number]	86
5.6.2.11	P631: User friendliness of the technical support [OR]	86
5.6.3	Commercial support	86
5.6.3.1	P641: Accessibility of the commercial support [%]	87
5.6.3.1.1	Definition of Parameter	87
5.6.3.1.2	Equation	87
5.6.3.1.3	Measure	87
5.6.3.2	P642: Commercial solution delivery time [Time]	87
5.6.3.2.1	Definition of Parameter	87
5.6.3.2.2	Equation	88
5.6.3.2.3	Measure	88
5.6.3.3	P643: Commercial solutions achieved within a specified period [%]	88
5.6.3.3.1	Definition of Parameter	88
5.6.3.3.2	Equation	88
5.6.3.3.3	Measure	88
5.6.3.4	P644: Integrity of solution achieved by the SP [OR]	89
5.6.3.4.1	Definition of Parameter	89
5.6.3.4.2	Equation	89
5.6.3.4.3	Measure	89
5.6.3.5	P645: Modes of commercial support [Number]	89
5.6.3.5.1	Definition of Parameter	89
5.6.3.5.2	Equation	89
5.6.3.5.3	Measure	89
5.6.3.6	P646: Recognition of the customer commercial request [%]	90
5.6.3.7	P647: Response time of the commercial support [Time & %]	90
5.6.3.8	P648: Request to commercial support resolution time [Time & %]	90
5.6.3.9	P649: Number of customer requests to commercial support [Number]	90
5.6.3.10	P650: Quality of the commercial support [OR]	90
5.6.3.11	P651: User friendliness of the commercial support [OR]	90
5.6.3.12	P652: Organisational efficiency of commercial support (SPO) [OR]	90
5.6.3.12.1	Definition of Parameter	90
5.6.3.12.2	Equation	91
5.6.3.12.3	Measure	91
5.6.4	Complaint management	91
5.6.4.1	P661: Accessibility of the complaint management desk [%]	92
5.6.4.1.1	Definition of Parameter	92
5.6.4.1.2	Equation	92
5.6.4.1.3	Measure	92
5.6.4.2	P662: Recognition of the customer complaints [%]	92
5.6.4.2.1	Definition of Parameter	92
5.6.4.2.2	Equation	92
5.6.4.2.3	Measure	93
5.6.4.3	P663: Complaint solutions not complete and correct first time [%]	93
5.6.4.3.1	Definition of Parameter	93
5.6.4.3.1.1	Explanation on Parameter Definition	93
5.6.4.3.2	Equation	93
5.6.4.3.3	Measure	93
5.6.4.4	P664: Integrity of complaint resolution [%]	93
5.6.4.4.1	Definition of Parameter	93
5.6.4.4.1.1	Explanation on Parameter Definition	93
5.6.4.4.2	Equation	94
5.6.4.4.3	Measure	94
5.6.4.5	P665: Customer perception of the complaint management [OR]	94
5.6.4.5.1	Definition of Parameter	94
5.6.4.5.1.1	Explanation on Parameter Definition	94
5.6.4.5.2	Equation	95
5.6.4.5.3	Measure	95
5.6.4.6	P666: Overall quality of the complaint management process [OR]	95
5.6.4.6.1	Definition of Parameter	95
5.6.4.6.1.1	Explanation on Parameter Definition	95

5.6.4.6.2	Equation.....	95
5.6.4.6.3	Measure	95
5.6.4.7	P667: Response time of the complaint management desk [Time & %]	96
5.6.4.8	P668: Customer complaints resolution time [Time & %]	96
5.6.4.9	P669: Number of customer complaints of any kind [Number]	96
5.6.4.10	P670: Professionalism of the complaint management desk [OR]	96
5.6.4.11	P671: Organisational efficiency of complaint management system (SPO) [OR].....	96
5.6.4.11.1	Definition of Parameter	96
5.6.4.11.1.1	Explanation on Parameter Definition.....	96
5.6.4.11.2	Equation.....	96
5.6.4.11.3	Measure	97
5.7	Customer Relationship Stage: Repair services	97
5.7.1	P701: Accessibility of repair services [%]	98
5.7.1.1	Definition of Parameter.....	98
5.7.1.1.1	Explanation on Parameter Definition	98
5.7.1.2	Equation	98
5.7.1.3	Measure	98
5.7.2	P702: Successful repairs carried out within a specified period [%]	98
5.7.2.1	Definition of Parameter.....	98
5.7.2.1.1	Explanation on Parameter Definition	98
5.7.2.2	Equation	98
5.7.2.3	Measure	99
5.7.3	P703: Repairs not complete and correct first time [%]	99
5.7.3.1	Definition of Parameter.....	99
5.7.3.1.1	Explanation on Parameter Definition	99
5.7.3.2	Equation	99
5.7.3.3	Measure	99
5.7.4	P704: Punctuality of appointments for repairs [OR & Time]	99
5.7.4.1	Definition of Parameter.....	99
5.7.4.1.1	Explanation on Parameter Definition	99
5.7.4.2	Equation	99
5.7.4.3	Measure	100
5.7.5	P705: Efficiency of the repair service [OR].....	100
5.7.5.1	Definition of Parameter.....	100
5.7.5.1.1	Explanation on Parameter Definition	100
5.7.5.2	Equation	100
5.7.5.3	Measure	100
5.7.6	P706: Fault repair time [Time & %]	101
5.7.7	P707: Number of customer complaints related to repair services [Number]	101
5.7.8	P708: Professionalism of the repair staff [OR]	101
5.7.9	P709: Provider ability to match the customer's wishes for conditions of achievement [OR]	101
5.7.10	P710: User friendliness of the repair service [OR]	101
5.7.11	P711: Organisational efficiency of repair service (SPO) [OR].....	101
5.7.11.1	Definition of Parameter.....	101
5.7.11.1.1	Explanation on Parameter Definition	101
5.7.11.2	Equation	102
5.7.11.3	Measure	102
5.8	Customer Relationship Stage: Metering, Charging, Billing	102
5.8.1	P801: Accessibility of the tariff information [%]	105
5.8.1.1	Definition of Parameter.....	105
5.8.1.1.1	Explanation on Parameter Definition	105
5.8.1.2	Equation	105
5.8.1.3	Measure	105
5.8.2	P802: Successful notification of exceeding billing budget [%]	105
5.8.2.1	Definition of Parameter.....	105
5.8.2.1.1	Explanation on Parameter Definition	106
5.8.2.2	Equation	106
5.8.2.3	Measure	106
5.8.3	P803: Notification time (delay) of exceeding billing budget [Time]	106
5.8.3.1	Definition of Parameter.....	106
5.8.3.1.1	Explanation on Parameter Definition	106
5.8.3.2	Equation	106

5.8.3.3	Measure	106
5.8.4	P804: Accessibility of the account management [%]	107
5.8.4.1	Definition of Parameter	107
5.8.4.1.1	Explanation on Parameter Definition	107
5.8.4.2	Equation	107
5.8.4.3	Measure	107
5.8.5	P805: Time to update charging information [Time]	107
5.8.5.1	Definition of Parameter	107
5.8.5.1.1	Explanation on Parameter Definition	107
5.8.5.2	Equation	107
5.8.5.3	Measure	107
5.8.6	P806: Timeliness of bill delivery [%]	108
5.8.6.1	Definition of Parameter	108
5.8.6.1.1	Explanation on Parameter Definition	108
5.8.6.2	Equation	108
5.8.6.3	Measure	108
5.8.7	P807: Bill delivery delay [Time]	108
5.8.7.1	Definition of Parameter	108
5.8.7.1.1	Explanation on Parameter Definition	108
5.8.7.2	Equation	108
5.8.7.3	Measure	108
5.8.8	P808: Late notification of amount due [%]	109
5.8.8.1	Definition of Parameter	109
5.8.8.1.1	Explanation on Parameter Definition	109
5.8.8.2	Equation	109
5.8.8.3	Measure	109
5.8.9	P809: Modes of billing information transfer [Number]	109
5.8.9.1	Definition of Parameter	109
5.8.9.1.1	Explanation on Parameter Definition	109
5.8.9.2	Equation	109
5.8.9.3	Measure	109
5.8.10	P810: Bill correctness complaints [%]	110
5.8.11	P811: Prepaid account credit correctness complaints [%]	110
5.8.12	P812: Provider ability to match the customer's wishes for charging/billing conditions [OR]	110
5.8.13	P813: User friendliness of the desk in charge of billing issues [OR]	110
5.8.14	P814: Bill presentation quality [OR]	110
5.8.15	P815: Organisational efficiency of the billing service (SPO) [OR]	110
5.8.15.1	Definition of Parameter	110
5.8.15.1.1	Explanation on Parameter Definition	110
5.8.15.2	Equation	110
5.8.15.3	Measure	111
5.9	Customer Relationship Stage: Network/Service (N/S) Management by the customer	111
5.9.1	P901: Outage duration [Time]	112
5.9.1.1	Definition of Parameter	112
5.9.1.1.1	Explanation on Parameter Definition	112
5.9.1.2	Equation	113
5.9.1.3	Measure	113
5.9.2	P902: Number of outages [Number]	113
5.9.2.1	Definition of Parameter	113
5.9.2.1.1	Explanation on Parameter Definition	113
5.9.2.2	Equation	113
5.9.2.3	Measure	113
5.9.3	P903: Response time for reply to requests [Time]	113
5.9.3.1	Definition of Parameter	113
5.9.3.1.1	Explanation on Parameter Definition	113
5.9.3.2	Equation	114
5.9.3.3	Measure	114
5.9.4	P904: Successful request response [%]	114
5.9.4.1	Definition of Parameter	114
5.9.4.1.1	Explanation on Parameter Definition	114
5.9.4.2	Equation	114
5.9.4.3	Measure	114

5.9.5	P905: Overall reliability of network/service management service [OR]	114
5.9.5.1	Definition of Parameter.....	114
5.9.5.1.1	Explanation on Parameter Definition	114
5.9.5.2	Equation	115
5.9.5.3	Measure	115
5.9.6	P906: Accessibility of the network/service management facility [Time & %].....	115
5.9.7	P907: Response time of the operator of the network/service management facility [Time & %].....	115
5.9.8	P908: Network/Service (N/S) Management access time [Time]	115
5.9.9	P909: Number of customer complaints related to network/service management by the customer [Number]	115
5.9.10	P910: Overall quality of the network/service management process [OR]	115
5.9.11	P911: Provider ability to match the customer's wishes for network/service management conditions [OR]	116
5.9.12	P912: User friendliness of the means available to the customer for the operations he has to perform [OR]	116
5.9.13	P913: Organizational efficiency of the network/service management service (SPO) [OR]	116
5.9.13.1	Definition of Parameter.....	116
5.9.13.1.1	Explanation on Parameter Definition	116
5.9.13.2	Equation	116
5.9.13.3	Measure	116
5.10	Customer Relationship Stage: Cessation	117
5.10.1	P1001: Cessation acknowledgement time [Time].....	117
5.10.1.1	Definition of Parameter.....	117
5.10.1.1.1	Explanation on Parameter Definition	117
5.10.1.2	Equation	118
5.10.1.3	Measure	118
5.10.2	P1002: Cessation request acknowledgement [%]	118
5.10.2.1	Definition of Parameter.....	118
5.10.2.1.1	Explanation on Parameter Definition	118
5.10.2.2	Equation	118
5.10.2.3	Measure	118
5.10.3	P1003: Accessibility of the cessation facility [%]	118
5.10.3.1	Definition of Parameter.....	118
5.10.3.1.1	Explanation on Parameter Definition	119
5.10.3.2	Equation	119
5.10.3.3	Measure	119
5.10.4	P1004: Contractual cessations achieved [%]	119
5.10.4.1	Definition of Parameter.....	119
5.10.4.1.1	Explanation on Parameter Definition	119
5.10.4.2	Equation	119
5.10.4.3	Measure	120
5.10.5	P1005: Correctness and completeness in taking the customer cessation request into account [Number & %]	120
5.10.6	P1006: Response time of the cessation facility [Time & %]	120
5.10.7	P1007: Overall quality of the cessation process [OR]	120
5.10.8	P1008: Number of customer complaints related to cessation [Number].....	120
5.10.9	P1009: Ease of the cessation process [OR].....	120
6	Evaluation specific methodology/system	120
6.1	Customer Relationship Stage: Preliminary information (PI).....	121
6.1.1	P101: Integrity of PI [OR]	121
6.1.1.1	Evaluation specific description	121
6.1.1.2	Trigger points.....	121
6.1.1.3	Accuracy of indicator (metric of the measure).....	121
6.1.1.4	Representativeness	121
6.1.1.5	Presentation of parameter values.....	122
6.1.2	P102: Pricing transparency [OR]	122
6.1.2.1	Evaluation specific description	122
6.1.2.2	Trigger points.....	122
6.1.2.3	Accuracy of indicator (metric of measure).....	122
6.1.2.4	Representativeness	123
6.1.2.5	Presentation of parameter values.....	123

6.1.3	P103: Availability of PI [%]	123
6.1.3.1	Evaluation specific description	123
6.1.3.2	Trigger points	123
6.1.3.3	Accuracy of indicator (metric of measure).....	124
6.1.3.4	Representativeness	124
6.1.3.5	Presentation of parameter values.....	124
6.1.4	P104: Response time for the provision of PI [Time]	124
6.1.4.1	Evaluation specific description	124
6.1.4.2	Trigger points	124
6.1.4.3	Accuracy of indicator (metric of measure).....	125
6.1.4.4	Representativeness	125
6.1.4.5	Presentation of parameter values.....	125
6.2	Customer Relationship Stage: Contract Establishment	126
6.2.1	P201: Integrity of contract information [OR]	126
6.2.1.1	Evaluation specific description	126
6.2.1.2	Trigger points	126
6.2.1.3	Accuracy of indicator (metric of measure).....	126
6.2.1.4	Representativeness	127
6.2.1.5	Presentation of parameter values.....	127
6.2.2	P202: Compliance of contractual terms with PI [%]	127
6.2.2.1	Evaluation specific description	127
6.2.2.2	Trigger points	127
6.2.2.3	Accuracy of indicator (metric of measure).....	127
6.2.2.4	Representativeness	127
6.2.2.5	Presentation of parameter values.....	127
6.2.3	P203: Flexibility for customisation before contract [OR].....	128
6.2.3.1	Evaluation specific description	128
6.2.3.2	Trigger points	128
6.2.3.3	Accuracy of indicator (metric of measure).....	128
6.2.3.4	Representativeness	128
6.2.3.5	Presentation of parameter values.....	128
6.2.4	P204: Ease and flexibility to amend terms after formal contract [OR].....	128
6.2.4.1	Evaluation specific description	128
6.2.4.2	Trigger points	129
6.2.4.3	Accuracy of indicator (metric of measure).....	129
6.2.4.4	Representativeness	129
6.2.4.5	Presentation of parameter values.....	129
6.3	Customer Relationship Stage: Service provisioning	129
6.3.1	P301: Meeting promised provisioning date [%]	129
6.3.1.1	Evaluation specific description	129
6.3.1.2	Trigger points	130
6.3.1.3	Accuracy of indicator (metric of measure).....	130
6.3.1.4	Representativeness / confidence level.....	130
6.3.1.5	Presentation of parameter values.....	130
6.3.2	P302: Time for provisioning [Time].....	130
6.3.2.1	Evaluation specific description	130
6.3.2.2	Trigger points	131
6.3.2.3	Accuracy of indicator (metric of measure).....	131
6.3.2.4	Representativeness	131
6.3.2.5	Presentation of parameter values.....	131
6.3.3	P303: Successful provisioning within specified period [%]	131
6.3.3.1	Evaluation specific description	131
6.3.3.2	Trigger points	132
6.3.3.3	Accuracy of indicator (metric of measure).....	132
6.3.3.4	Representativeness	132
6.3.3.5	Presentation of parameter values.....	132
6.3.4	P304: Contract cancelled due to non fulfilment [%].....	132
6.3.4.1	Evaluation specific description	132
6.3.4.2	Trigger points	133
6.3.4.3	Accuracy of indicator (metric of measure).....	133
6.3.4.4	Representativeness	133
6.3.4.5	Presentation of parameter values.....	133

6.3.5	P305: Completeness of fulfilment of contractual specification in the provision of a service [%]	133
6.3.5.1	Evaluation specific description	133
6.3.5.2	Trigger points	134
6.3.5.3	Accuracy of indicator (metric of measure).....	134
6.3.5.4	Representativeness	134
6.3.5.5	Presentation of parameter values.....	134
6.3.6	P306: Punctuality of service provisioning [Time]	134
6.3.6.1	Evaluation specific description	134
6.3.6.2	Trigger points	135
6.3.6.3	Accuracy of indicator (metric of measure).....	135
6.3.6.4	Representativeness	135
6.3.6.5	Presentation of parameter values.....	135
6.3.7	P307: Punctuality of equipment delivery for service provisioning [Time]	136
6.3.7.1	Evaluation specific description	136
6.3.7.2	Trigger points	136
6.3.7.3	Accuracy of indicator (metric of measure).....	136
6.3.7.4	Representativeness	136
6.3.7.5	Presentation of parameter values.....	136
6.3.8	P308: Provisioning not complete and correct first time [%].....	137
6.3.8.1	Evaluation specific description	137
6.3.8.2	Trigger points	137
6.3.8.3	Accuracy of indicator (metric of measure).....	137
6.3.8.4	Representativeness	137
6.3.8.5	Presentation of parameter values.....	137
6.4	Customer Relationship Stage: Service alteration	138
6.4.1	P401: Time for alteration [Time]	138
6.4.1.1	Evaluation specific description	138
6.4.1.2	Trigger points	138
6.4.1.3	Accuracy of indicator (metric of measure).....	138
6.4.1.4	Representativeness	138
6.4.1.5	Presentation of parameter values.....	138
6.4.2	P402: Successful service alteration within specified period [%]	139
6.4.2.1	Evaluation specific description	139
6.4.2.2	Trigger points	139
6.4.2.3	Accuracy of indicator (metric of measure).....	139
6.4.2.4	Representativeness	139
6.4.2.5	Presentation of parameter values.....	139
6.4.3	P403: Completeness of fulfilment of contractual specification in the alteration of a service [%]	140
6.4.3.1	Evaluation specific description	140
6.4.3.2	Trigger points	140
6.4.3.3	Accuracy of indicator (metric of measure).....	140
6.4.3.4	Representativeness	140
6.4.3.5	Presentation of parameter values.....	140
6.4.4	P404: Punctuality of appointments for service alteration [Time]	140
6.4.4.1	Evaluation specific description	140
6.4.4.2	Trigger points	141
6.4.4.3	Accuracy of indicator (metric of measure).....	141
6.4.4.4	Representativeness	141
6.4.4.5	Presentation of parameter values.....	141
6.4.5	P405: Punctuality of equipment delivery for service alteration [Time]	141
6.4.5.1	Evaluation specific description	141
6.4.5.2	Trigger points	142
6.4.5.3	Accuracy of indicator (metric of measure).....	142
6.4.5.4	Representativeness	142
6.4.5.5	Presentation of parameter values.....	142
6.4.6	P406: Service alteration not complete and correct first time [%]	142
6.4.6.1	Evaluation specific description	142
6.4.6.2	Trigger points	143
6.4.6.3	Accuracy of indicator (metric of measure).....	143
6.4.6.4	Representativeness	143
6.4.6.5	Presentation of parameter values.....	143
6.4.7	P407: Conformity and success of service alteration [%]	143

6.4.7.1	Evaluation specific description	143
6.4.7.2	Trigger points	143
6.4.7.3	Accuracy of indicator (metric of measure).....	144
6.4.7.4	Representativeness	144
6.4.7.5	Presentation of parameter values.....	144
6.4.8	P408: Technical reliability of service within an agreed period after alteration [%].....	144
6.4.8.1	Evaluation specific description	144
6.4.8.2	Trigger points	144
6.4.8.3	Accuracy of indicator (metric of measure).....	144
6.4.8.4	Representativeness	144
6.4.8.5	Presentation of parameter values.....	145
6.4.9	P409: Response time of the alteration service [Time & %]	145
6.4.9.1	Evaluation specific description	145
6.4.9.2	Trigger points	145
6.4.9.3	Accuracy of indicator (metric of measure).....	145
6.4.9.4	Representativeness	145
6.4.9.5	Presentation of parameter values.....	145
6.4.10	P412: Organisational efficiency of service provider to carry out service alteration (SPO) [OR]	146
6.4.10.1	Evaluation specific description	146
6.4.10.2	Trigger points	146
6.4.10.3	Accuracy of indicator (metric of measure).....	146
6.4.10.4	Representativeness	146
6.4.10.5	Presentation of parameter values.....	146
6.5	Customer Relationship Stage: Technical upgrade	147
6.5.1	P501: Time for technical upgrade of a service [Time].....	147
6.5.1.1	Evaluation specific description	147
6.5.1.2	Trigger points	147
6.5.1.3	Accuracy of indicator (metric of measure).....	147
6.5.1.4	Representativeness	147
6.5.1.5	Presentation of parameter values.....	147
6.5.2	P502: Successful technical upgrade within a specified period [%].....	147
6.5.2.1	Evaluation specific description	147
6.5.2.2	Trigger points	148
6.5.2.3	Accuracy of indicator (metric of measure).....	148
6.5.2.4	Representativeness	148
6.5.2.5	Presentation of parameter values.....	148
6.5.3	P503: Completeness of fulfilment of specification in the technical upgrade of a service [%].....	148
6.5.3.1	Evaluation specific description	148
6.5.3.2	Trigger points	149
6.5.3.3	Accuracy of indicator (metric of measure).....	149
6.5.3.4	Representativeness	149
6.5.3.5	Presentation of parameter values.....	149
6.5.4	P504: Punctuality of appointments for technical upgrade [Time]	149
6.5.4.1	Evaluation specific description	149
6.5.4.2	Trigger points	150
6.5.4.3	Accuracy of indicator (metric of measure).....	150
6.5.4.4	Representativeness	150
6.5.4.5	Presentation of parameter values.....	150
6.5.5	P505: Outage time due to technical upgrade [Time].....	150
6.5.5.1	Evaluation specific description	150
6.5.5.2	Trigger points	151
6.5.5.3	Accuracy of indicator (metric of measure).....	151
6.5.5.4	Representativeness	151
6.5.5.5	Presentation of parameter values.....	151
6.5.6	P506: Technical upgrade not complete and correct first time [%].....	151
6.5.6.1	Evaluation specific description	151
6.5.6.2	Trigger points	152
6.5.6.3	Accuracy of indicator (metric of measure).....	152
6.5.6.4	Representativeness	152
6.5.6.5	Presentation of parameter values.....	152
6.5.7	P507: Conformity and success of technical upgrade [%]	152
6.5.7.1	Evaluation specific description	152

6.5.7.2	Trigger points.....	153
6.5.7.3	Accuracy of indicator (metric of measure).....	153
6.5.7.4	Representativeness	153
6.5.7.5	Presentation of parameter values.....	153
6.5.8	P508: Technical reliability of service within an agreed period after technical upgrade [%]	153
6.5.8.1	Evaluation specific description	153
6.5.8.2	Trigger points.....	153
6.5.8.3	Accuracy of indicator (metric of measure).....	154
6.5.8.4	Representativeness	154
6.5.8.5	Presentation of parameter values.....	154
6.5.9	P512: Organisational efficiency of SP to carry out technical upgrade (SPO) [OR].....	154
6.5.9.1	Evaluation specific description	154
6.5.9.2	Trigger points.....	154
6.5.9.3	Accuracy of indicator (metric of measure).....	154
6.5.9.4	Representativeness	154
6.5.9.5	Presentation of parameter values.....	155
6.5.10	P513: Competence and preparedness of SP for technical upgrade (SPO) [OR]	155
6.5.10.1	Evaluation specific description	155
6.5.10.2	Trigger points.....	155
6.5.10.3	Accuracy of indicator (metric of measure).....	155
6.5.10.4	Representativeness	155
6.5.10.5	Presentation of parameter values.....	155
6.6	Customer Relationship Stage: Service Support.....	156
6.6.1	Documentation.....	156
6.6.1.1	P611: Documentation delivery time [Time].....	156
6.6.1.1.1	Evaluation specific description.....	156
6.6.1.1.2	Trigger points	156
6.6.1.1.3	Accuracy of indicator (metric of measure)	156
6.6.1.1.4	Representativeness	156
6.6.1.1.5	Presentation of parameter values	156
6.6.1.2	P612: Availability of documentation within specified period of time [%].....	157
6.6.1.2.1	Evaluation specific description.....	157
6.6.1.2.2	Trigger points	157
6.6.1.2.3	Accuracy of indicator (metric of measure)	157
6.6.1.2.4	Representativeness	157
6.6.1.2.5	Presentation of parameter values	157
6.6.1.3	P613: Integrity (correctness and completeness) of documentation [OR].....	157
6.6.1.3.1	Evaluation specific description.....	157
6.6.1.3.2	Trigger points	158
6.6.1.3.3	Accuracy of indicator (metric of measure)	158
6.6.1.3.4	Representativeness	158
6.6.1.3.5	Presentation of parameter values	158
6.6.1.4	P614: Modes of documentation [Number].....	158
6.6.1.4.1	Evaluation specific description.....	158
6.6.1.4.2	Trigger points	158
6.6.1.4.3	Accuracy of indicator (metric of measure)	158
6.6.1.4.4	Representativeness	158
6.6.1.4.5	Presentation of parameter values	158
6.6.1.5	P615: Legibility of documentation [OR].....	159
6.6.1.5.1	Evaluation specific description.....	159
6.6.1.5.2	Trigger points	159
6.6.1.5.3	Accuracy of indicator (metric of measure)	159
6.6.1.5.4	Representativeness	159
6.6.1.5.5	Presentation of parameter values	159
6.6.1.6	P616: Overall reliability of documentation services [OR]	159
6.6.1.6.1	Evaluation specific description.....	159
6.6.1.6.2	Trigger points	159
6.6.1.6.3	Accuracy of indicator (metric of measure)	159
6.6.1.6.4	Representativeness	159
6.6.1.6.5	Presentation of parameter values	160
6.6.2	Technical support.....	160
6.6.2.1	P621: Accessibility of the technical support [%]	160

6.6.2.1.1	Evaluation specific description.....	160
6.6.2.1.2	Trigger points	160
6.6.2.1.3	Accuracy of indicator (metric of measure)	160
6.6.2.1.4	Representativeness	160
6.6.2.1.5	Presentation of parameter values	160
6.6.2.2	P622: Technical solutions achieved within a specified period [%]	161
6.6.2.2.1	Evaluation specific description.....	161
6.6.2.2.2	Trigger points	161
6.6.2.2.3	Accuracy of indicator (metric of measure)	161
6.6.2.2.4	Representativeness	161
6.6.2.2.5	Presentation of parameter values	161
6.6.2.3	P623: Number of attempts before successful solution [Number].....	162
6.6.2.3.1	Evaluation specific description.....	162
6.6.2.3.2	Trigger points	162
6.6.2.3.3	Accuracy of indicator (metric of measure)	162
6.6.2.3.4	Representativeness	162
6.6.2.3.5	Presentation of parameter values	162
6.6.2.4	P624: Integrity of technical solutions [OR]	162
6.6.2.4.1	Evaluation specific description.....	162
6.6.2.4.2	Trigger points	163
6.6.2.4.3	Accuracy of indicator (metric of measure)	163
6.6.2.4.4	Representativeness	163
6.6.2.4.5	Presentation of parameter values	163
6.6.2.5	P625: Reliability of technical solutions achieved [%]	163
6.6.2.5.1	Evaluation specific description.....	163
6.6.2.5.2	Trigger points	164
6.6.2.5.3	Accuracy of indicator (metric of measure)	164
6.6.2.5.4	Representativeness	164
6.6.2.5.5	Presentation of parameter values	164
6.6.2.6	P626: Modes of technical support [Number]	164
6.6.2.6.1	Evaluation specific description.....	164
6.6.2.6.2	Trigger points	164
6.6.2.6.3	Accuracy of indicator (metric of measure)	164
6.6.2.6.4	Representativeness	165
6.6.2.6.5	Presentation of parameter values	165
6.6.3	Commercial support.....	165
6.6.3.1	P641: Accessibility of the commercial support [%].....	165
6.6.3.1.1	Evaluation specific description.....	165
6.6.3.1.2	Trigger points	165
6.6.3.1.3	Accuracy of indicator (metric of measure)	165
6.6.3.1.4	Representativeness	165
6.6.3.1.5	Presentation of parameter values	165
6.6.3.2	P642: Commercial solution delivery time [Time].....	166
6.6.3.2.1	Evaluation specific description.....	166
6.6.3.2.2	Trigger points	166
6.6.3.2.3	Accuracy of indicator (metric of measure)	166
6.6.3.2.4	Representativeness	166
6.6.3.2.5	Presentation of parameter values	166
6.6.3.3	P643: Commercial solutions achieved within a specified period [%].....	167
6.6.3.3.1	Evaluation specific description.....	167
6.6.3.3.2	Trigger points	167
6.6.3.3.3	Accuracy of indicator (metric of measure)	167
6.6.3.3.4	Representativeness	167
6.6.3.3.5	Presentation of parameter values	167
6.6.3.4	P644: Integrity of solution achieved by the SP [OR]	168
6.6.3.4.1	Evaluation specific description.....	168
6.6.3.4.2	Trigger points	168
6.6.3.4.3	Accuracy of indicator (metric of measure)	168
6.6.3.4.4	Representativeness	168
6.6.3.4.5	Presentation of parameter values	168
6.6.3.5	P645: Modes of commercial support [Number].....	168
6.6.3.5.1	Evaluation specific description.....	168

6.6.3.5.2	Trigger points	169
6.6.3.5.3	Accuracy of indicator (metric of measure)	169
6.6.3.5.4	Representativeness	169
6.6.3.5.5	Presentation of parameter values	169
6.6.3.6	P652: Organisational efficiency of commercial support (SPO) [OR]	169
6.6.3.6.1	Evaluation specific description	169
6.6.3.6.2	Trigger points	169
6.6.3.6.3	Accuracy of indicator (metric of measure)	169
6.6.3.6.4	Representativeness	169
6.6.3.6.5	Presentation of parameter values	169
6.6.4	Complaint management	170
6.6.4.1	P661: Accessibility of the complaint management desk [%]	170
6.6.4.1.1	Evaluation specific description	170
6.6.4.1.2	Trigger points	170
6.6.4.1.3	Accuracy of indicator (metric of measure)	170
6.6.4.1.4	Representativeness	170
6.6.4.1.5	Presentation of parameter values	170
6.6.4.2	P662: Recognition of the customer complaints [%]	171
6.6.4.2.1	Evaluation specific description	171
6.6.4.2.2	Trigger points	171
6.6.4.2.3	Accuracy of indicator (metric of measure)	171
6.6.4.2.4	Representativeness	171
6.6.4.2.5	Presentation of parameter values	171
6.6.4.3	P663: Complaint solutions not complete and correct first time [%]	172
6.6.4.3.1	Evaluation specific description	172
6.6.4.3.2	Trigger points	172
6.6.4.3.3	Accuracy of indicator (metric of measure)	172
6.6.4.3.4	Representativeness	172
6.6.4.3.5	Presentation of parameter values	172
6.6.4.4	P664: Integrity of complaint resolution [%]	172
6.6.4.4.1	Evaluation specific description	172
6.6.4.4.2	Trigger points	173
6.6.4.4.3	Accuracy of indicator (metric of measure)	173
6.6.4.4.4	Representativeness	173
6.6.4.4.5	Presentation of parameter values	173
6.6.4.5	P665: Customer perception of the complaint management [OR]	173
6.6.4.5.1	Evaluation specific description	173
6.6.4.5.2	Trigger points	173
6.6.4.5.3	Accuracy of indicator (metric of measure)	173
6.6.4.5.4	Representativeness	173
6.6.4.5.5	Presentation of parameter values	174
6.6.4.6	P666: Overall quality of the complaint management process [OR]	174
6.6.4.6.1	Evaluation specific description	174
6.6.4.6.2	Trigger points	174
6.6.4.6.3	Accuracy of indicator (metric of measure)	174
6.6.4.6.4	Representativeness	174
6.6.4.6.5	Presentation of parameter values	174
6.6.4.7	P671: Organisational efficiency of complaint management system (SPO) [OR]	175
6.6.4.7.1	Evaluation specific description	175
6.6.4.7.2	Trigger points	175
6.6.4.7.3	Accuracy of indicator (metric of measure)	175
6.6.4.7.4	Representativeness	175
6.6.4.7.5	Presentation of parameter values	175
6.7	Customer Relationship Stage: Repair services	175
6.7.1	P701: Accessibility of repair services [%]	175
6.7.1.1	Evaluation specific description	175
6.7.1.2	Trigger points	176
6.7.1.3	Accuracy of indicator (metric of measure)	176
6.7.1.4	Representativeness	176
6.7.1.5	Presentation of parameter values	176
6.7.2	P702: Successful repairs carried out within a specified period [%]	176
6.7.2.1	Evaluation specific description	176

6.7.2.2	Trigger points.....	176
6.7.2.3	Accuracy of indicator (metric of measure).....	176
6.7.2.4	Representativeness	177
6.7.2.5	Presentation of parameter values.....	177
6.7.3	P703: Repairs not complete and correct first time [%]	177
6.7.3.1	Evaluation specific description	177
6.7.3.2	Trigger points.....	177
6.7.3.3	Accuracy of indicator (metric of measure).....	177
6.7.3.4	Representativeness	177
6.7.3.5	Presentation of parameter values.....	177
6.7.4	P704: Punctuality of appointments for repairs [OR & Time]	178
6.7.4.1	Evaluation specific description	178
6.7.4.2	Trigger points.....	178
6.7.4.3	Accuracy of indicator (metric of measure).....	178
6.7.4.4	Representativeness	179
6.7.4.5	Presentation of parameter values.....	179
6.7.5	P705: Efficiency of the repair service [OR].....	179
6.7.5.1	Evaluation specific description	179
6.7.5.2	Trigger points.....	179
6.7.5.3	Accuracy of indicator (metric of measure).....	179
6.7.5.4	Representativeness	179
6.7.5.5	Presentation of parameter values.....	179
6.7.6	P711: Organisational efficiency of repair service (SPO) [OR].....	180
6.7.6.1	Evaluation specific description	180
6.7.6.2	Trigger points.....	180
6.7.6.3	Accuracy of indicator (metric of measure).....	180
6.7.6.4	Representativeness	180
6.7.6.5	Presentation of parameter values.....	180
6.8	Customer Relationship Stage: Metering, Charging, Billing	180
6.8.1	P801: Accessibility of the tariff information [%]	180
6.8.1.1	Evaluation specific description	180
6.8.1.2	Trigger points.....	181
6.8.1.3	Accuracy of indicator (metric of measure).....	181
6.8.1.4	Representativeness	181
6.8.1.5	Presentation of parameter values.....	181
6.8.2	P802: Successful notification of exceeding billing budget [%]	181
6.8.2.1	Evaluation specific description	181
6.8.2.2	Trigger points.....	182
6.8.2.3	Accuracy of indicator (metric of measure).....	182
6.8.2.4	Representativeness	182
6.8.2.5	Presentation of parameter values.....	182
6.8.3	P803: Notification time (delay) of exceeding billing budget [Time].....	182
6.8.3.1	Evaluation specific description	182
6.8.3.2	Trigger points.....	183
6.8.3.3	Accuracy of indicator (metric of measure).....	183
6.8.3.4	Representativeness	183
6.8.3.5	Presentation of parameter values.....	183
6.8.4	P804: Accessibility of the account management [%]	183
6.8.4.1	Evaluation specific description	183
6.8.4.2	Trigger points.....	184
6.8.4.3	Accuracy of indicator (metric of measure).....	184
6.8.4.4	Representativeness	184
6.8.4.5	Presentation of parameter values.....	184
6.8.5	P805: Time to update charging information [Time]	184
6.8.5.1	Evaluation specific description	184
6.8.5.2	Trigger points.....	185
6.8.5.3	Accuracy of indicator (metric of measure).....	185
6.8.5.4	Representativeness	185
6.8.5.5	Presentation of parameter values.....	185
6.8.6	P806: Timeliness of bill delivery [%]	185
6.8.6.1	Evaluation specific description	185
6.8.6.2	Trigger points.....	185

6.8.6.3	Accuracy of indicator (metric of measure).....	186
6.8.6.4	Representativeness	186
6.8.6.5	Presentation of parameter values.....	186
6.8.7	P807: Bill delivery delay [Time]	186
6.8.7.1	Evaluation specific description	186
6.8.7.2	Trigger points.....	186
6.8.7.3	Accuracy of indicator (metric of measure).....	186
6.8.7.4	Representativeness	186
6.8.7.5	Presentation of parameter values.....	187
6.8.8	P808: Late notification of amount due [%].....	187
6.8.8.1	Evaluation specific description	187
6.8.8.2	Trigger points.....	187
6.8.8.3	Accuracy of indicator (metric of measure).....	187
6.8.8.4	Representativeness	187
6.8.8.5	Presentation of parameter values.....	187
6.8.9	P809: Modes of billing information transfer [Number].....	188
6.8.9.1	Evaluation specific description	188
6.8.9.2	Trigger points.....	188
6.8.9.3	Accuracy of indicator (metric of measure).....	188
6.8.9.4	Representativeness	188
6.8.9.5	Presentation of parameter values.....	188
6.8.10	P815: Organisational efficiency of the billing service (SPO) [OR].....	188
6.8.10.1	Evaluation specific description	188
6.8.10.2	Trigger points.....	189
6.8.10.3	Accuracy of indicator (metric of measure).....	189
6.8.10.4	Representativeness	189
6.8.10.5	Presentation of parameter values.....	189
6.9	Customer Relationship Stage: Network / Service Management by the customer	189
6.9.1	P901: Outage duration [Time]	189
6.9.1.1	Evaluation specific description	189
6.9.1.2	Trigger points.....	190
6.9.1.3	Accuracy of indicator (metric of measure).....	190
6.9.1.4	Representativeness	190
6.9.1.5	Presentation of parameter values.....	190
6.9.2	P902: Number of outages [Number].....	190
6.9.2.1	Evaluation specific description	190
6.9.2.2	Trigger points.....	191
6.9.2.3	Accuracy of indicator (metric of measure).....	191
6.9.2.4	Representativeness	191
6.9.2.5	Presentation of parameter values.....	191
6.9.3	P903: Response time for reply to requests [Time].....	191
6.9.3.1	Evaluation specific description	191
6.9.3.2	Trigger points.....	192
6.9.3.3	Accuracy of indicator (metric of measure).....	192
6.9.3.4	Representativeness	192
6.9.3.5	Presentation of parameter values.....	192
6.9.4	P904: Successful request response [%].....	193
6.9.4.1	Evaluation specific description	193
6.9.4.2	Trigger points.....	193
6.9.4.3	Accuracy of indicator (metric of measure).....	193
6.9.4.4	Representativeness	193
6.9.4.5	Presentation of parameter values.....	193
6.9.5	P905: Overall reliability of network/service management service [OR]	194
6.9.5.1	Evaluation specific description	194
6.9.5.2	Trigger points.....	194
6.9.5.3	Accuracy of indicator (metric of measure).....	194
6.9.5.4	Representativeness	194
6.9.5.5	Presentation of parameter values.....	194
6.9.6	P913: Organizational efficiency of the network/service management service (SPO) [OR]	194
6.9.6.1	Evaluation specific description	194
6.9.6.2	Trigger points.....	194
6.9.6.3	Accuracy of indicator (metric of measure).....	195

6.9.6.4	Representativeness	195
6.9.6.5	Presentation of parameter values.....	195
6.10	Customer Relationship Stage: Cessation.....	195
6.10.1	P1001: Cessation acknowledgement time [Time].....	195
6.10.1.1	Evaluation specific description	195
6.10.1.2	Trigger points	195
6.10.1.3	Accuracy of indicator (metric of measure).....	195
6.10.1.4	Representativeness	195
6.10.1.5	Presentation of parameter values.....	196
6.10.2	P1002: Cessation request acknowledgement [%]	196
6.10.2.1	Evaluation specific description	196
6.10.2.2	Trigger points.....	196
6.10.2.3	Accuracy of indicator (metric of measure).....	196
6.10.2.4	Representativeness	196
6.10.2.5	Presentation of parameter values.....	197
6.10.3	P1003: Accessibility of the cessation facility [%]	197
6.10.3.1	Evaluation specific description	197
6.10.3.2	Trigger points	197
6.10.3.3	Accuracy of indicator (metric of measure).....	197
6.10.3.4	Representativeness	197
6.10.3.5	Presentation of parameter values.....	198
6.10.4	P1004: Contractual cessations achieved [%]	198
6.10.4.1	Evaluation specific description	198
6.10.4.2	Trigger points	198
6.10.4.3	Accuracy of indicator (metric of measure).....	198
6.10.4.4	Representativeness	198
6.10.4.5	Presentation of parameter values.....	199
Annex A:	Aggregate rating of a customer relationship stage (or performance category) from a set of individual performance parameter ratings	200
A.1	Background	200
A.2	Description	200
A.3	Transformation rules	200
A.4	Example of weighting and transformational rules.....	201
A.5	Example of a graphic display of QoS assessment results.....	203
A.5.1	Provisioning stage assessment.....	203
A.5.2	Example for the comparison of the QoS achieved by different SP	204
History	207

Intellectual Property Rights

IPRs essential or potentially essential to the present document may have been declared to ETSI. The information pertaining to these essential IPRs, if any, is publicly available for **ETSI members and non-members**, and can be found in ETSI SR 000 314: "*Intellectual Property Rights (IPRs); Essential, or potentially Essential, IPRs notified to ETSI in respect of ETSI standards*", which is available from the ETSI Secretariat. Latest updates are available on the ETSI Web server (<http://ipr.etsi.org>).

Pursuant to the ETSI IPR Policy, no investigation, including IPR searches, has been carried out by ETSI. No guarantee can be given as to the existence of other IPRs not referenced in ETSI SR 000 314 (or the updates on the ETSI Web server) which are, or may be, or may become, essential to the present document.

Foreword

This final draft ETSI Guide (EG) has been produced by ETSI User Group (USER), and is now submitted for the ETSI standards Membership Approval Procedure.

Although the present document is not a multipart deliverable, it is closely linked to TS 102 844 [i.10] and TS 102 852 [i.11].

- The present document defines parameters and basic information which are universally applicable. One aim here is to keep the parameter definitions stable and complete for any kind of service/application. Ways to aggregate results of different groups, e.g. combination of the results of an audit panel with the results of real customers to only one single number (for executive summary or for simple benchmarking) are also proposed in annex A.
- The TS 102 844 [i.10] defines the test methodologies how to apply the parameters including all necessary boundary conditions and preconditions with the aim to ensure comparability of the results and to guarantee the objectivity of the results.
- The TS 102 852 [i.11] provides the requirements needed to ensure that QoS information is assessed according to the best practices as detailed in the present document.

Introduction

With the emergence of new telecommunications services, the increasing number of service providers (SP) and the increased complexity of the offers, the user may have a lot of difficulty to compare the respective performance of the different SP and of the offered services. Even within the wide range of services offered by a SP the user may face difficulties when selecting the most suited for their particular needs.

The selection of parameters for each stage of the customer relationship is intended to cover most, if not all eventualities. A selection of parameters from the present document could enable potential customers to compare performances of various SP which in turn could enable them to make an informed choice of provider for their needs. These parameters could form the basis of a benchmark for the industry.

The present document provides generic definitions and test methods for most, if not all, of the key parameters of telecommunication services and procedures to enable customers to understand easily different SP's offerings and their performance. The compendium of parameters covers the customer relationship phases of the service, but not the QoS of the telecommunication services themselves (already covered by other ETSI documents, e.g. EG/ES 202 057 series [i.3], [i.4], [i.5] and [i.6]). Thus, it covers the range from the earliest to the latest stages of the customer relationship of a service: Preliminary Information, Establishment of the contract, Service provisioning, Service alteration, Technical upgrade, Service support, Complaint management, Repair, Charging/Billing, Network/service management and Cessation.

All the stakeholders, e.g. regulators, national institutions, operators, SP, users organisations may find in the present document a set of reference definitions and test methods to be used for delivering performance statistics. The same applies to any party which has an interest in the performance of SP, e.g. newspapers or consumers publications. When reported the data becomes a useful guide for the customer to choose a SP most suited for their particular needs. They may be used for any type of application e.g. quality monitoring or benchmark.

General principles formula for an aggregate quality rating of each customer relationship stage are also provided in annex A for an overall assessment although such aggregation should be used with much care (see EG 202 765-1 [i.7]).

Note copied from clause 6 of EG 202 765-1 [i.7]:

"It is very important to present the quality indicators in a relevant way. This presentation allows us to make our own judgement of the global performance of the evaluated object. There is a great temptation to try to give one unique note which aggregates all quality items. Through its uniqueness, this note approaches the concepts of global evaluation and more generally of global satisfaction. But there are two problems of doing this aggregation.

First, there is a gap between technical aspects and perceptive aspects. The links between these two aspects are not trivial. The second problem is that overall satisfaction or overall quality can hardly be modelled. Satisfaction and even quality strongly depends on expectancy levels and environment circumstances. As an example, you will be happy to call your wife/husband at the top of the mountain you climb, even if quality is poor and your QoE would be great. But with the same quality, if you call your wife/husband from your office, you won't ... and your QoE will be bad.

Therefore it is difficult to evaluate quality using one unique note. It is recommended to visualise all indicators at the same time."

1 Scope

The QoS parameters of the Customer Relationship Stages other than Utilization are listed in EG 202 009-2 [i.2]. These stages comprise Preliminary information, Establishment of the contract, Service provisioning, Service alteration, Technical upgrade, Service support, Complaint management, Repair, Charging/Billing, Network/service management and Cessation as detailed in EG 202 009-1 [i.1].

The present document provides detailed definitions and methods for the assessment of the values of the QoS parameters of the service Customer Relationship stages. A major purpose of the present document is to ensure that the results of these QoS measurements are fully reproducible and statistically valid. Then it could be used to assess the delivered QoS performance of Service Providers (SP). The Guide does not cover the QoS of the telecommunication services themselves (already defined by other ETSI documents, e.g. EG/ES 202 057 series [i.3], [i.4], [i.5],[i.6] and EG/ES 202 765 series [i.7], [i.8]). The results could be used to compare the providers' performances over time or for benchmark.

Some parameters listed in the present document refer explicitly to ES 202 057-1 [i.3] where such parameters are defined.

The intention of the present document is to define the QoS parameters and the methodology of testing and not recommend any requirement (i.e. targets values) for the different parameters defined in the present document.

2 References

References are either specific (identified by date of publication and/or edition number or version number) or non-specific. For specific references, only the cited version applies. For non-specific references, the latest version of the reference document (including any amendments) applies.

Referenced documents which are not found to be publicly available in the expected location might be found at <http://docbox.etsi.org/Reference>.

NOTE: While any hyperlinks included in this clause were valid at the time of publication ETSI cannot guarantee their long term validity.

2.1 Normative references

The following referenced documents are necessary for the application of the present document.

Not applicable.

2.2 Informative references

The following referenced documents are not necessary for the application of the present document but they assist the user with regard to a particular subject area.

- [i.1] ETSI EG 202 009-1: "User Group; Quality of telecom services; Part 1: Methodology for identification of parameters relevant to the Users".
- [i.2] ETSI EG 202 009-2: "User Group; Quality of Telecom Services; Part 2: User related parameters on a service specific basis".
- [i.3] ETSI ES 202 057-1: "Speech Processing, Transmission and Quality Aspects (STQ); User related QoS parameter definitions and measurements; Part 1: General".
- [i.4] ETSI EG 202 057-2: "Speech Processing, Transmission and Quality Aspects (STQ); User related QoS parameter definitions and measurements; Part 2: Voice telephony, Group 3 fax, modem data services and SMS".

- [i.5] ETSI EG 202 057-3: "Speech Processing, Transmission and Quality Aspects (STQ); User related QoS parameter definitions and measurements; Part 3: QoS parameters specific to Public Land Mobile Networks (PLMN)".
- [i.6] ETSI EG 202 057-4: "Speech Processing, Transmission and Quality Aspects (STQ); User related QoS parameter definitions and measurements; Part 4: Internet access".
- [i.7] ETSI EG 202 765-1: "Speech and multimedia Transmission Quality (STQ); QoS and network performance metrics and measurement methods; Part 1: General considerations".
- [i.8] ETSI ES 202 765-2: "Speech and multimedia Transmission Quality (STQ); QoS and network performance metrics and measurement methods; Part 2: Transmission Quality Indicator combining Voice Quality Metrics".
- [i.9] ETSI TS 102 250-6 (V1.2.1): "Speech Processing, Transmission and Quality Aspects (STQ); QoS aspects for popular services in GSM and 3G networks; Part 6: Post processing and statistical methods".
- [i.10] ETSI TS 102 844: "User Group; Quality of Telecom Services; Conformity assessment; Requirements for bodies providing QoS audits and surveys".
- [i.11] ETSI TS 102 852: "User Group; Quality of ICT Services; Assessment process of the QoS parameters of the customer relationship stages".
- [i.12] Public Opinion Quarterly, 49, 535-552: "The measurement of values in surveys: A comparison of ratings and rankings", Alwin, D. F. & Krosnick, J. A. (1985).
- [i.13] ITU-T Recommendation E.800: "Definitions of terms related to Quality of Service".
- [i.14] ITU-T Recommendation E.801: "Quality of telecommunication services; Concepts, models, objectives and dependability planning. Terms and definitions related to the quality of telecommunication services".
- [i.15] ITU-T Recommendation P.505: "Objective measuring apparatus; One-view visualization of speech quality measurement results".
- [i.16] ITIL ® V3 Glossary v3.1.24, (30 May 2007): Glossary of Terms, Definitions and Acronyms.
- [i.17] ISO/IEC 18028-3: 2005: "Information technology -- Security techniques -- IT network security -- Part 3: Securing communications between networks using security gateways".
- [i.18] ITU-T Recommendation P.851: "Subjective quality evaluation of telephone services based on spoken dialogue systems".

3 Definitions, symbols and abbreviations

3.1 Definitions

For the purposes of the present document, the following terms and definitions apply:

assurance: knowledge and courtesy of employees and their ability to convey trust and confidence

audit: formal inquiry, formal examination, or verification of facts against expectations, for compliance and conformity

NOTE: From ISO/IEC 18028-3: 2005 [i.17].

availability: ability of a Configuration Item or IT Service to perform its agreed Function when required

NOTE: Availability is determined by Reliability, Maintainability, Serviceability, Performance, and Security. Availability is usually calculated as a percentage. This calculation is often based on Agreed Service Time and Downtime. It is Best Practice to calculate Availability using measurements of the Business output of the IT Service.

From ITIL [i.16].

avatar: animated computer graphics resembling humans, cartoon characters, etc.

NOTE: Applications of this technology include "salespeople" who will demonstrate or show goods to the visitor, and help him or her in selecting items to buy.

Adapted from BusinessDictionary.com.

benchmark: evaluation of performance value/s of a parameter or set of parameters for the purpose of establishing value/s as the norm against which future performance achievements may be compared or assessed

NOTE: From ITU-T Recommendation E.800 [i.13].

billing: administrative function to prepare bills to service customers, to prompt payments, to obtain revenues and to take care of customer reclaims

NOTE: From ITU-T Recommendation E.800 [i.13].

cessation: all activities associated with the cessation of a service by a service provider from the instant a contractual agreement is in force between the customer and the service provider to the instant all hardware and software associated with the service is made inoperative and/or removed from the customer's premises

NOTE: From ITU-T recommendation E.800 [i.13].

charging: set of functions needed to determine the price assigned to the service utilization

NOTE: From ITU-T Recommendation E.800 [i.13].

commercial desk: service desk dedicated to commercial issues

complaint: statement by a user or customer expressing dissatisfaction due to a gap between the expected and the delivered benefits from the use of a service

NOTE: A complaint may be made in various forms, writing, electronic means, or in person.
From ITU-T Recommendation E.800 [i.13].

complaint management desk: service desk dedicated to complaint management

customer: user who is responsible for payment for the services

NOTE: From ITU-T Recommendation E.800 [i.13].

customer survey measurements: customer satisfaction measurements (surveys) obtained through interviews with customers or via statistical analysis of customer reported data in order to evaluate service quality from a customer's perspective

NOTE: Consideration should be given to both incident driven and non-incident (i.e. stock survey) sampling techniques.

From ITU-T Recommendation E.801 [i.14].

empathy: degree of caring and individual attention provided to customers

Help Desk: point of contact for Users to log Incidents

NOTE: A Help Desk is usually more technically focussed than a Service Desk and does not provide a Single Point of Contact for all interaction. The term Help Desk is often used as a synonym for Service Desk.
From ITIL [i.16].

mystery call: call performed anonymously to gain information about SP and his services

NOTE: In order to obtain this information, specific tasks, such as purchasing a product, asking for information, posing questions, registering complaints or behaving in a certain way are performed via telephone calls.

Opinion Rating (OR): quantitative value (a number) assigned to a qualitative performance criterion on a predefined rating scale to reflect the merit of that criterion to a user/customer

NOTE: See clause 4.1 for more details.

panel: group of individuals interviewed at intervals over a given period of time

NOTE: From wikipedia (extract).

quality of service (QoS): totality of characteristics of a telecommunications service that bear on its ability to satisfy stated and implied needs of the user of the service

NOTE: From ITU-T Recommendation E.800 [i.13].

reliability: measure of how long a Configuration Item or IT Service can perform its agreed Function without interruption

NOTE: Usually measured as MTBF or MTBSI. The term Reliability can also be used to state how likely it is that a Process, Function etc. will deliver its required outputs.
See Availability.

From ITIL [i.16].

repair (corrective maintenance): maintenance carried out after fault recognition and intended to restore an item to a state in which it can perform a required function

NOTE: From ITU-T Recommendation E.800 [i.13].

responsiveness: willingness to help customers and provide prompt services

service desk: Single Point of Contact between the Service Provider and the Users

NOTE 1: A typical Service Desk manages Incidents and Service Requests, and also handles communication with the Users.

From ITIL [i.16].

NOTE 2: Many organizations have implemented a central point of contact for handling Customer, User and related issues. The Service Desk function is known under several titles (often interpreted as having increasing levels of business relevance) including:

- Call center;
- Contact center;
- Help desk.

NOTE 3: In the present document, complaint management desk, commercial desk or technical desk are used when a specific call number is often dedicated to the related issues within the service desk.

Service Provider (SP): organization that provides electronic communications services to users and customers

NOTE: From ITU-T Recommendation E.800 [i.13].

(service) provision: all activities associated with the provision of a service by the service provider from the instant an order for a service is contracted to the instant the service is available for use by the customer/user

NOTE: From ITU-T Recommendation E.800 [i.13].

tariff information: set of non ambiguous rules defined by a Service Provider to price the electronic communication service it offers to its consumers

technical desk: service desk dedicated to technical issues

third party: person, group, or Business who is not part of the Service Level Agreement for an ICT Service, but is required to ensure successful delivery of that ICT Service

NOTE: For example a software Supplier, a hardware maintenance company, or a facilities department. Requirements for Third Parties are typically specified in Underpinning Contracts or Operational Level Agreements.

From ITIL [i.16].

user: individual, including consumer, or organization using or requesting telecommunications services available on public or private networks

NOTE: The user may or may not be the person who has subscribed to the provision of the service. Without any specific addition this word is used to identify the telecommunication user community in general, e.g. end-users and IT&T managers who use products and services possibly conforming to standards.

3.2 Symbols

For the purposes of the present document, the following symbols apply:

<i>A</i>	Opinion rating for assurance
<i>C</i>	Opinion rating for contents
<i>C_s</i>	Customer segment
<i>E</i>	Opinion rating for empathy
<i>R</i>	Opinion rating for responsiveness
<i>d_A</i>	Date on which service provisioning is announced to happen
<i>d_p</i>	Date on which service provisioning event occurs
<i>i</i>	Index of attempt/customer/event/expert/interval/mode/request/user
<i>L</i>	Opinion rating for the language
<i>m</i>	Number of modes
<i>N_E</i>	Number of customers/event/experts/modes/requests/users within the CRS possibly linked to a particular event (E = event identification)
<i>p</i>	Weighting factor
P101	Integrity of PI [OR]
P102	Pricing transparency [OR]
P103	Availability of PI [%]
P104	Response time for the provision of PI [Time]
P105	Response time of the commercial desk [Time & %]
P106	Overall rating of the responsiveness of the service desk [OR]
P107	User friendliness of the Internet user interface [OR]
P108	User friendliness of the service desk operators [OR]
P201	Integrity of contract information [OR]
P202	Compliance of contractual terms with PI [%]
P203	Flexibility for customisation before contract [OR]
P204	Ease and flexibility to amend terms after formal contract [OR]
P205	Response time of the commercial desk [Time & %]
P206	Delay to settle a contract [Time & %]
P207	Delay for a contract acknowledgment [Time & %]
P208	Overall rating of the responsiveness of the sales desk [OR]
P209	Ease of the subscription process [OR]
P210	Vendors empathy and responsiveness [OR]
P301	Meeting promised provisioning date [%]
P302	Time for provisioning [Time]
P303	Successful provisioning within a specified period [%]
P304	Contract cancelled due to non fulfilment [%]
P305	Completeness of fulfilment of contractual specification in the provision of a service [%]
P306	Punctuality of service provisioning [Time]
P307	Punctuality of equipment delivery for service provisioning [Time]
P308	Provisioning not complete and correct first time [%]
P309	Provisioning time [Time & %]

P310	Overall quality of the provisioning process including the reception desk [OR]
P311	Provider ability to match the customer's wishes for conditions of achievement [OR]
P312	User friendliness of the means available to the customer for the operations he has to perform [OR]
P313	Portage delay (when applicable) [Time & %]
P314	Proportion of problems with number portability procedures [%]
P401	Time for alteration [Time]
P402	Successful service alteration within a specified period [%]
P403	Completeness of fulfilment of contractual specification in the alteration of a service [%]
P404	Punctuality of appointments for service alteration [Time]
P405	Punctuality of equipment delivery for service alteration [Time]
P406	Service alteration not complete and correct first time [%]
P407	Conformity and success of service alteration [%]
P408	Technical reliability of service within an agreed period after alteration [%]
P409	Response time of the alteration service [Time & %]
P410	Overall quality of the alteration process [OR]
P411	User friendliness of the means available to the customer for the operations he has to perform [OR]
P412	Organisational efficiency of service provider to carry out service alteration (SPO) [OR]
P501	Time for technical upgrade of a service [Time]
P502	Successful technical upgrade within a specified period [%]
P503	Completeness of fulfilment of specification in the technical upgrade of a service [%]
P504	Punctuality of appointments for technical upgrade [Time]
P505	Outage time due to technical upgrade [Time]
P506	Technical upgrade not complete and correct first time [%]
P507	Conformity and success of technical upgrade [%]
P508	Technical reliability of service within an agreed period after technical upgrade [%]
P509	Overall quality of the technical upgrade process [OR]
P510	Provider ability to match the customer's wishes for conditions of achievement [OR]
P511	User friendliness of the means available to the customer for the operations he has to perform [OR]
P512	Organisational efficiency of SP to carry out technical upgrade (SPO) [OR]
P513	Competence and preparedness of SP for technical upgrade (SPO) [OR]
P611	Documentation delivery time [Time]
P612	Availability of documentation within specified period of time [%]
P613	Integrity (correctness and completeness) of documentation [OR]
P614	Modes of documentation [Number]
P615	Legibility of documentation [OR]
P616	Overall reliability of documentation services [OR]
P621	Accessibility of the technical support [%]
P622	Technical solutions achieved within a specified period [%]
P623	Number of attempts before successful solution [Number]
P624	Integrity of technical solution [OR]
P625	Reliability of technical solutions achieved [%]
P626	Modes of technical support [Number]
P627	Recognition of the customer technical request [%]
P628	Response time of the technical support [Time & %]
P629	Request to technical support resolution time [Time & %]
P630	Number of customer requests to technical support [Number]
P631	User friendliness of the technical support [OR]
P641	Accessibility of the commercial support [%]
P642	Commercial solution delivery time [Time]
P643	Commercial solutions achieved within a specified period [%]
P644	Integrity of solution achieved by the SP [OR]
P645	Modes of commercial support [Number]
P646	Recognition of the customer commercial request [%]
P647	Response time of the commercial support [Time & %]
P648	Request to commercial support resolution time [Time & %]
P649	Number of customer requests to commercial support [Number]
P650	Quality of the commercial support [OR]
P651	User friendliness of the commercial support [OR]
P652	Organisational efficiency of commercial support (SPO) [OR]
P661	Accessibility of the complaint management desk [%]
P662	Recognition of the customer complaints [%]
P663	Complaint solutions not complete and correct first time [%]

P664	Integrity of complaint resolution [%]
P665	Customer perception of the complaint management [OR]
P666	Overall quality of the complaint management process [OR]
P667	Response time of the complaint management desk [Time & %]
P668	Customer complaints resolution time [Time & %]
P669	Number of customer complaints of any kind [Number]
P670	Professionalism of the complaint management desk [OR]
P671	Organisation efficiency of complaint management system (SPO) [OR]
P701	Accessibility of repair services [%]
P702	Successful repairs carried out within a specified period [%]
P703	Repairs not complete and correct first time [%]
P704	Punctuality of appointments for repairs [OR & Time]
P705	Efficiency of the repair service [OR]
P706	Fault repair time [Time & %]
P707	Number of customer complaints related to repair services [Number]
P708	Professionalism of the repair staff [OR]
P709	Provider ability to match the customer's wishes for conditions of achievement [OR]
P710	User friendliness of the repair service [OR]
P711	Organisational efficiency of repair service (SPO) [OR]
P801	Accessibility of the tariff information [%]
P802	Successful notification of exceeding billing budget [%]
P803	Notification time (delay) of exceeding billing budget [Time]
P804	Accessibility of the account management [%]
P805	Time to update charging information [Time]
P806	Timeliness of bill reception [%]
P807	Bill delivery delay [Time]
P808	Late notification of amount due [%]
P809	Modes of billing information transfer [Number]
P810	Bill correctness complaints [%]
P811	Prepaid account credit correctness complaints [%]
P812	Provider ability to match the customer's wishes for charging/billing conditions [OR]
P813	User friendliness of the desk in charge of billing issues [OR]
P814	Bill presentation quality [OR]
P815	Organisational efficiency of the billing service (SPO) [OR]
P901	Outage duration [Time]
P902	Number of outages [Number]
P903	Response time for reply to requests [Time]
P904	Successful request response [%]
P905	Overall reliability of Network/Service management service [OR]
P906	Accessibility of the network/service management facility [Time & %]
P907	Response time of the operator of the network/service management facility [Time & %]
P908	Network/Service (N/S) Management access time [Time]
P909	Number of customer complaints related to network/service management by the customer [Number]
P910	Overall quality of the network/service management process [OR]
P911	Provider ability to match the customer's wishes for network/service management conditions [OR]
P912	User friendliness of the means available to the customer for the operations he has to perform [OR]
P913	Organizational efficiency of the network / service management service (SPO) [OR]
P1001	Cessation acknowledgement time [Time]
P1002	Cessation request acknowledgement [%]
P1003	Accessibility of the cessation facility [%]
P1004	Contractual cessation achieved [%]
P1005	Correctness and completeness in taking the customer cessation request into account [Number & %]
P1006	Response time of the cessation facility [Time & %]
P1007	Overall quality of the cessation process [OR]
P1008	Number of customer complaints related to cessation [Number]
P1009	Ease of the cessation process [OR]
<i>q</i>	Weighting factor
<i>r</i>	Weighting factor
<i>S</i>	Opinion rating for the style

$t_{y,i}$ Point of time when a particular CRS event i actually occurs

NOTE: y = ascending number within this stage.

t_E Point of time within the CRS linked to a particular event

NOTE: E = event identification.

T_{xy} Specified period of time e.g. timeout

NOTE: x = customer relationship stage, y = ascending number within this stage.

3.3 Abbreviations

For the purposes of the present document, the following abbreviations apply:

AR	Aggregate Rating
CDF	Cumulative Distribution Function
CM	(Customer) Complaint Management
IT	Information Technology
ITIL	Information Technology Infrastructure Library
MTBF	Mean Time Between Failure

NOTE: Sometimes MTBSI - Mean Time between Service Incidents is used instead.

N/S	Network/Services
OR	Opinion Rating
PABX	Private Automatic Branch eXchange
PDF	Probability Distribution Function
PI	Preliminary Information
QoE	Quality of Experience
QoS	Quality of Service
QoSAP	Quality of Service Assessment Party
SME	Small and Medium Enterprise
SP	Service Provider
SPO	Service Provider Oriented (Parameter)

4 Common Basis for QoS parameter assessment

To ensure comparable and reproducible results, this clause discusses general topics which are relevant in terms of QoS parameter assessment.

First of all, to ensure the impartiality of its results, the QoS assessment process should be, as far as possible, performed by a party independent of the service provision. Such Quality of Service Assessment Party (QoSAP) can be an SP internal department or an independent third party. The QoSAP is expected to manage the QoS assessment process, to analyze the data stored by the SP, to convene the expert panel, to launch the customer survey and to gather the results.

Starting with a definition of Opinion Rating procedures and recommendations related to this issue, the different available data sources for QoS parameter assessment are discussed. Each data source has its specific advantages and disadvantages which should be taken into account before carrying out an assessment.

Some of the most relevant issues which have to be considered from a statistical perspective are discussed as well. This includes the selection of samples sizes as well as the related measures like confidence intervals.

Finally, some hints related to the boundary conditions which are linked to QoS parameter assessments are given. It is important to keep these conditions constant throughout an evaluation to allow a comparison of generated results.

4.1 Opinion Rating

Opinion Rating [OR] is used in the present document to give a quantitative value to a qualitative performance criterion.

4.1.1 Definition of OR

OR is a quantitative value (a number) assigned to a qualitative performance criterion on a predefined rating scale to reflect the merit of that criterion to a user/customer.

Examples of qualitative criteria in telecommunications are:

- User friendliness of man-machine interface of services.
- Empathy shown by service provider's employees towards customers.
- Ergonomics of terminal equipment, etc.

Predefined rating scales considered are usually 5, 7, 10 or 100. However, published literature (based on research) [i.12] indicates a unipolar 7 scale is most suited for best recording opinion ratings. Therefore a 0-6 scale has been chosen for rating qualitative criteria in the present document, thus:

Table 1: 0-6 Unipolar scale

Very poor	Poor	Below average	Average	Above average	Good	Excellent
0	1	2	3	4	5	6

Bipolar scales are numbered with the middle point as '0' and with positive and negative numbers on its either side as illustrated below:

Table 2: Bipolar scale with a middle point '0'

Very poor	Poor	Below average	Average	Above average	Good	Excellent
-3	-2	-1	0	+1	+2	+3

In practice the wordings in the scoring boxes may be varied to suit the particular performance characteristics of the qualitative criterion being surveyed.

However all the wordings in the seven scoring boxes of the bipolar scale should be consistent and refer to same concepts or parameters.

4.1.2 Example

For statistical purposes the scale of -3 to +3 may be converted to 0 to 6 or 1 to 7 and where necessary re-converted to -3 to +3 ratings.

Preliminary Information

-3 Definitely not satisfied with the PI provided

i.e. Too many unanswered questions, contradictory and/or confusing information, etc. Evasive and unhelpful. Obvious lack of professionalism. Definitely not able to proceed further on decision making about this service.

-2 Quite dissatisfied

i.e. Not forthcoming with all pertinent information unless specifically requested. I do not know what questions I have not asked!

-1 Somewhat dissatisfied

i.e. Very little information provided. Need to make further enquiries to be in a position to make informed judgement about this service.

0 Neither satisfied nor dissatisfied

i.e. Not made any enquiries. Further information is needed before making a judgement on the PI available on this service.

+1 OK with basic information

i.e. More queries to ensure I have all relevant information.

+2 Reasonably satisfied

i.e. Ready to make a decision - just a few clarifications needed before making it.

+3 Fully satisfied

i.e. Professionally handled all queries and provided all pertinent PI. I can now make an informed decision on this service.

4.2 Selection of an appropriate data source

This clause describes how to select appropriate data sources and how to represent the data which are generated by these data sources in a meaningful manner.

In general, the measures for the parameters defined in the present document can be determined by various data sources. Depending on the type of data which is used as input data, the resulting parameter values might have a different significance.

The most familiar data sources are the following:

- Expert panel.
- Customer survey.
- Service provider (SP) data.

This list is not exclusive and may be extended by further data sources at any time; however the parameters defined in the present document are assessed from the sources defined above.

For many parameters, different data sources can be taken into account. There is no rule of thumb that only data source A has to be applied to get a measure for topic B. In fact, the individual application of a specific data source has to be checked individually with the aims of an audit, the allowed cost range of this activity and the representativeness of the desired output. Besides these main points, other topics might also restrict the exploitation of a specific data source.

Therefore, the next clauses describe in brief the characteristics of the mentioned data sources and the advantages and limitations of their usage. Additionally, some hints related to an appropriate usage of these data sources are given.

4.2.1 Expert panel

An expert panel is defined as a group of experts which are very familiar with the topic of interest. The expert panel will audit the topic of interest and give their expert opinion on this. Studies carried out on particular QoS aspects such as assessment of call centre QoS made using "mystery calls" or QoS of mobile communications by human operators belong to this category of data source.

Ideally, the selected experts bring a broad theoretical background and practical experience as well as a longer period of personal knowledge with them. Besides that, the selection of experts should take into consideration that all relevant aspects of the examined topic are covered by the combination of experts within the panel. In some cases detailed in the related clauses, experts' role can be played by trained customers.

Advantages of this expert panel approach are:

- Only few experts are required to address a certain topic.
- The high level of expertise guarantees a high qualitative feedback.
- Feedback to one specific subject can be collected rather quickly (during an experts' meeting).
- Customers' point of view is reflected: Experts are used as highly-trained customers.
- Subjective feedback might give additional information to objective feedback (emotions, first thoughts, etc.).
- Data can be generated by anyone who is interested in a specific topic.

Limitations are:

- High effort to find the right experts.
- High organizational effort to gather all required experts together at the same place and time.
- Additional expenses are generated by the involvement of experts.
- Experts could be blinded by their routine. Their judgements may heavily differ from the feedback given by customers.

4.2.2 Customer survey

To get a broader basis of feedback, a survey of customer panels can be used. A customer panel consists of "usual" customers of products or services. The customers should be familiar with the topic they are asked for without reaching an expert level. For some stages, the customers involved in the survey should have had recent (e.g. 6 months) experience with the issue to assess.

In many cases, specialized institutes are engaged to deal with the panel recruitment. This is based on the fact that either a well-defined part of the population should be taken into consideration (e.g. only females aged 25 to 35 years with a certain net household income) or that the selected group of customers should be representative for the complete population of this country or for the complete population of customers of a service provider.

When selecting customer panel it may be useful to ask questions related to the user's background. Such examples are available in ITU-T Recommendation P.851 [i.18], clause 7.1.

Advantages of customer panel approach are:

- Reflection of the "real" customer experience.
- Subjective feedback might give more information than objective feedback (emotions, first thoughts, etc.).
- Data can be generated by anyone who is interested in a specific topic.

Limitations are:

- Additional expenses are generated by the involvement of market research institutions.
- A certain level of customer attendance should be reached to assure the desired level of representativeness of data.
- In general, customer panel interrogations need a longer period of time (up to several weeks).

When an OR is sought via both a customer survey and an expert panel, there may be discrepancy between the findings of these differing channels. Where the difference is significant, reason for this discrepancy should be investigated and any necessary changes incorporated either to the panel's ratings or the way the customer survey is carried out.

4.2.3 Service provider data

For certain customer relevant processes, service providers (SP) may have available customer records for their own purposes or due to regulatory requirements. In these cases such data might be used for the determination of customer relevant parameters as well but in a well controlled process.

However, two conditions have to be carefully checked in advance:

- For what purpose is this data collected? Does it really match the purpose it is now taken for?
- What are the measurement conditions? Or in a more detailed way: Which cases or events are caught in the data, which are not caught or even neglected?

Provider data can be used either by the QoSAP or an expert panel for further evaluation of customer relevant parameters, as soon as they fulfil the conditions described above.

In particular it is needed to check carefully if the purpose of the data collection and the measurement conditions are documented and if the purpose and conditions are compliant with the principles defined in the present document. Details of audit of data are described in clause 5.3 of TS 102 852 [i.11].

The advantages of using SP data are:

- No additional cost for data generation since the data is available from the usual day-to-day business.
- A large amount of data sets may be available (mass data), depending on the number of customers the SP has and depending on their activity.
- Automation of evaluation procedures may be achievable.
- Objective data is free of individual and subjective influences.

Limitations are:

- Limited reflection of the customer perspective since customer relevant processes are already mapped to numbers.
- Data is only accessible after the SP released it for evaluations.
- The conditions under which the data has been generated have to be carefully checked.
- Representativeness of the data has to be considered.
- Lack of data for sensitive areas where service providers do not release internal data.
- Lack of data for areas which are not covered by the observation of internal processes.
- In general, subjective components are missing.

4.3 Samples sizes and examples

Data for customer relationship stages can be of different kinds and should be presented in appropriate ways.

Each data set generated by data sources can be interpreted as a so called "sample". The entirety of all samples related to one specific assessment is defined to be the "sample size".

Besides the different nature of the mentioned data sources, the number of available samples for each of these data sources may also differ heavily:

- To assess a special topic, only few but highly trained experts are required. This leads to a high quality feedback, but includes also very limited number of information.

EXAMPLE 1: 15 experts are requested to assess the "Integrity of Complaint Resolution". The outcome will be 15 different opinions on a chosen scale.

- The assessment of topics which are more common to all customers and which do not require special expertise allows the involvement of a higher number of customers.

EXAMPLE 2: 150 customers of SP A who complained about a certain matter are selected to give their feedback on the "Customer Perception of the Complaint Management".

Here, the quality of the feedback will not be on expert level, but represents the customer perception very clearly. Furthermore, the number of samples is higher than in the first case which improves the data basis for statistical operations.

- Finally, if mass data from service provider's internal processes can be assessed, there are two advantages: The weight of each data set on the overall result is negligible, and most of the data will be measured objectively.

EXAMPLE 3: SP B delivers 10 000 data sets which allow to determine the parameter "Time for alteration" on a very broad basis.

4.3.1 Statistical considerations

Having the above possible scenarios in mind, different kinds of meaningful data representation are considered.

4.3.1.1 Low sample sizes

For low sample sizes (order of magnitude < 100), discrete representations like histograms give the best impression of the results.

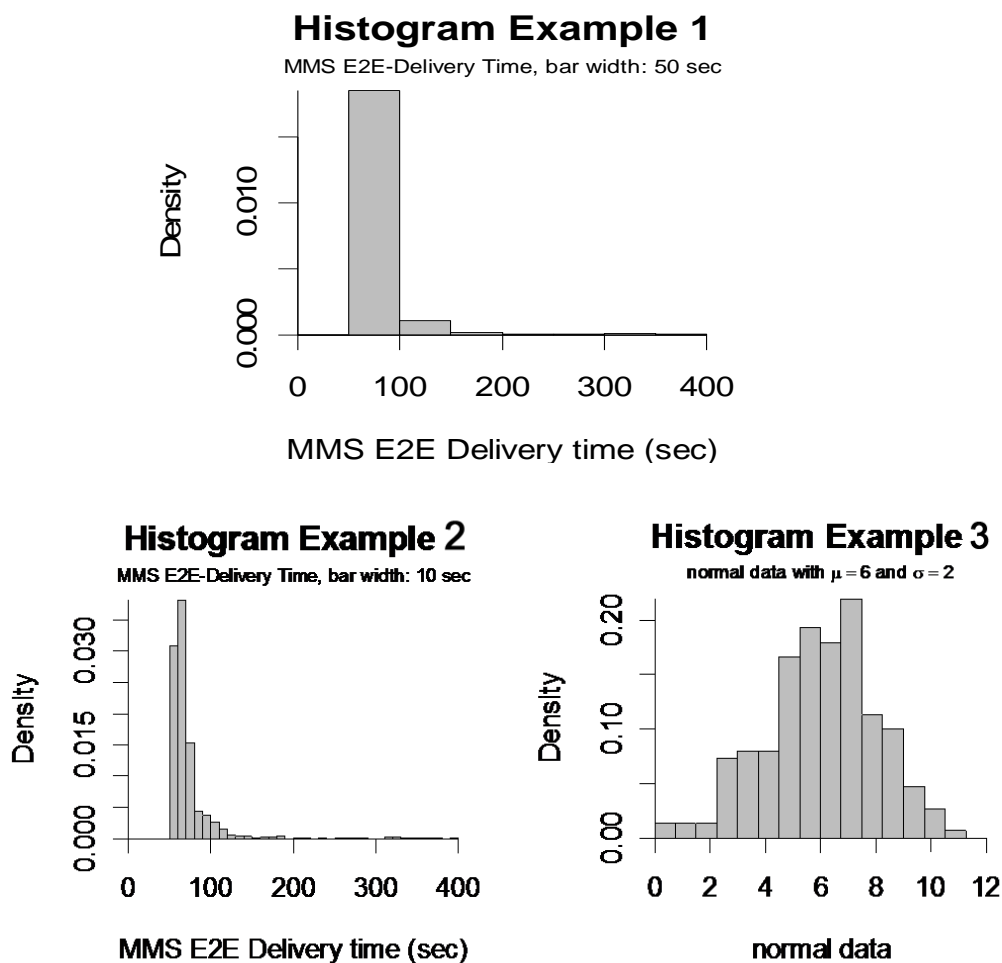

Figure 1: Examples of histograms TS 102 250-6 [i.9]

From a statistical point of view, each sample represents up to 1 % of the overall result. The less samples are available, the higher is the influence of each single sample.

Therefore, the complete information available should be given e.g. as a histogram figure. Statistical measures like mean values or quantile calculations are not recommended at all for this scenario.

As a consequence, single failures may be overestimated when only small sample sizes are considered.

EXAMPLE: If only 10 samples are available and 1 represents a negative outcome of a process, the success rate will immediately be limited to only 90 % whereas a higher sample size may show that the success rate is in the range of 98 %.

NOTE: From a statistical point of view, the binomial distribution (representing binary decisions like "black or white" or "yes or no") can be replaced by Gaussian Normal Distribution (the "bell curve"), if the required condition defined in TS 102 250-6 [i.9] are fulfilled. For further information related to the transition between different kinds of distributions, please refer to TS 102 250-6 [i.9].

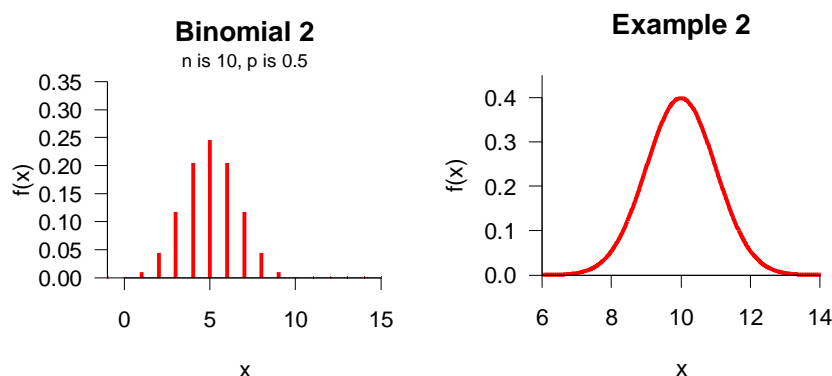

Figure 2: Transition from binomial to normal distribution TS 102 250-6 [i.9]

4.3.1.2 Medium sample sizes

If the order of available samples is higher (order of magnitude between 100 and 200), further statistical measures are meaningful. The calculation of success or failure rates based on these sample sizes is reasonable.

However, if mean rates should be calculated, the nature of the underlying distribution should also be taken into account. There are some cases where the mean rate may lead to wrong conclusions.

EXAMPLE: If 200 customers are asked to assess a certain issue and 100 of them are very satisfied (rating of 7) and the other 100 are very dissatisfied (rating of 1), the mean value of 4 would imply that all requested customers are somehow satisfied. In this case, the really poor perception of half of the customers is ignored!

For an in-depth analysis, the complete set of information related to the distribution of data should be available. On higher level, aggregated information like mean values could be provided. In this case, at least the number of used samples should be given as an additional piece of information.

The calculation of quantile values is not recommended for the scenario discussed in this clause.

4.3.1.3 Large sample sizes

For large sample sizes (order of magnitude > 300), the set of statistical measures can be further extended. In this range of samples the calculation of quantile values is also meaningful. By these calculations, questions like "What is the worst perception that 5 % of the customer base has?" or "What is the median of the delay time?" can be answered.

For representation, the complete information can be given by Probability Density Functions (PDF) or by Cumulative Distribution Functions (CDF).

The relationship between a PDF and a CDF is very simple:

The PDF represents something like a spectral view on the data. It answers the question "Which part of the data is related to a dedicated value on the x axis?" and delivers expression of this kind:

$$f(x) = P(x)$$

However, the CDF represents the sum respectively the integral value of a PDF. With this representation, the question "What is the probability that values are smaller than or equal to x_0 ?" can be answered. In a more formal way it looks like this:

$$F(x) = P(x \leq x_0)$$

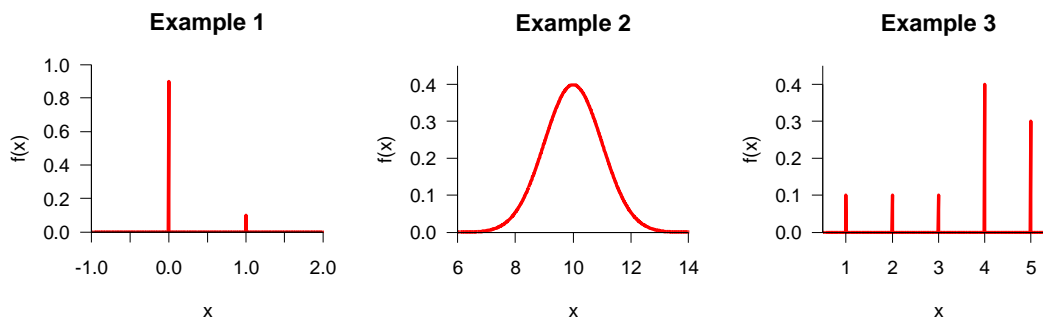

Figure 3: Example Probability Distribution Functions TS 102 250-6 [i.9]

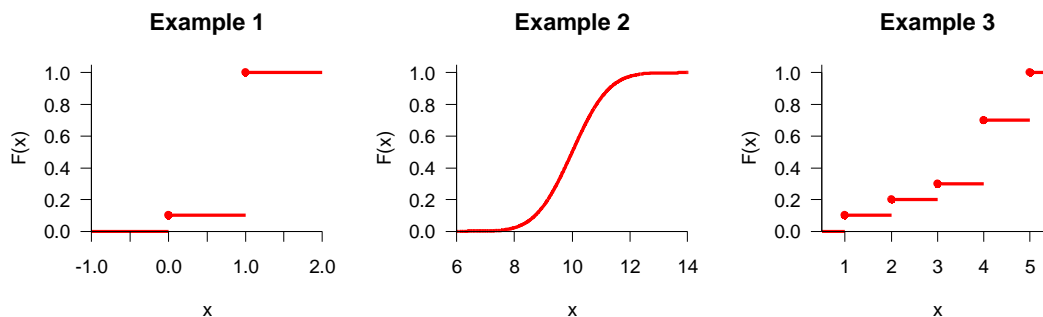

Figure 4: Example Cumulative Distribution Functions TS 102 250-6 [i.9]

The CDF representation allows reading all kinds of quantile value directly from the data. In this case, the desired quantile value is given (e.g. $F(x) = 95\%$) and the corresponding value x_0 can be found in the CDF figure.

To catch the main points of a statistical distribution, a condensed view can be given by picking some quantile values from the CDF, e.g. the 5 %, 10 %, 50 %, 90 % and 95 % quantile (often abbreviated as q_p with p being the percentage considered). This set of quantile values gives a short description of the CDF.

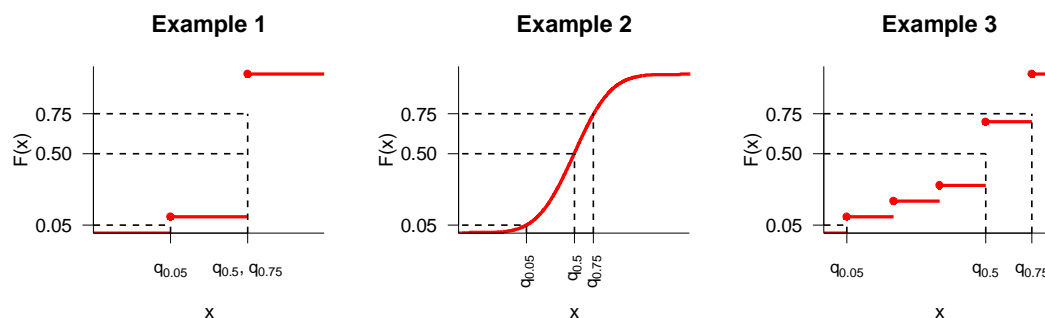

Figure 5: Examples for the determination of quantile values TS 102 250-6 [i.9]

For in-depth analysis, again the complete data base should be accessible.

4.3.2 Mean value versus Median

One important difference between the mean value and the median of a distribution should also be considered.

EXAMPLE: If 10 samples are used to determine the delay of a certain process, a single outlier can make a big difference related to the mean and median values. Assuming that 9 samples give a delay of 1 hour and 1 sample gives a delay of 11 hours, the results would be like this:

Calculation of mean value:

$$(9 \times 1 \text{ hour} + 1 \times 11 \text{ hours}) / 10 = 2 \text{ hours}$$

To make it clear: One sample with a higher value compared to the majority of samples can have a very great influence on the mean value!

On the other side, the median is more "stable" against outliers:

Calculation of median value:

9 samples with 1 hour each, 1 sample with 11 hours

These samples are ordered in ascending order and then half of the samples is counted since the median is the 50 % quantile. The outcome of this procedure would be: The median value is 1 hour!

In this case, the single outlier has no influence on the median, whereas the mean value was doubled. Therefore, the median (like all quantile values) is more robust to outlier effects and should be preferred to give the overall impression of some measure.

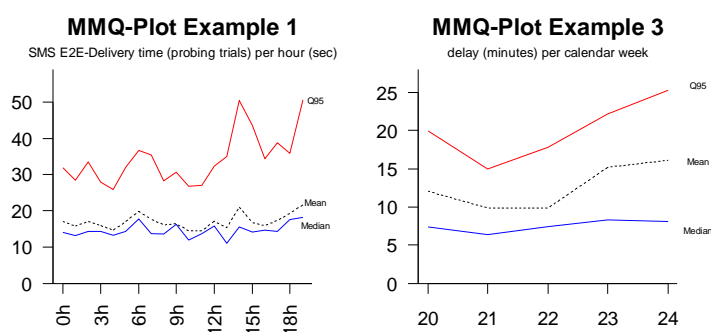

Figure 6: Examples showing the behaviour of mean and median TS 102 250-6 [i.9]

Plot 3 in figure 6 gives a good example of robustness: Whereas the line representing the mean value shows a variation of several minutes from week to week, the median value remains on a rather constant level. This leads to the conclusion that the underlying data is influenced by outliers.

A further sophisticated way of representing statistical data is given by the use of so-called boxplots. Boxplots describe the main characteristics of a data set within a very condensed representation. See more in TS 102 250-6 [i.9].

Considering the Web questionnaire used for the validation of the present ETSI guide, which results are spread on the whole range of the proposed assessment scale, it appears that, in most cases, the mean value hardly brings usable information to the consumer. Its use should be limited to specific cases, provided the standard deviation is low with respect of the assessment range (e.g. 10 %).

Only when an expert panel is asked for an OR then a mean value provides meaningful information. Under no other circumstance in this context, it should be used to define thresholds for an acceptable QoS level.

4.3.3 Confidence level

To describe the quality of a given data set with respect to a certain statistical measure, often the terms "confidence level" or "confidence interval" are used. In general, only a smaller part of all available data sets are used for these considerations.

EXAMPLE 1: A network operator has 10 million customers, but he can only manage to ask 1 000 of them.

In this scenario there is a certain chance that the customers to be asked are not really representative but something like an inappropriate selection of customers. Therefore, if some results are calculated, there is always a chance or probability that the overall population would generate a different outcome. This relationship is covered by the terms "confidence level" and "confidence interval".

The confidence level represents the probability (e.g. 95 %) that the actual value lies within a certain range which is called confidence interval. Based on a confidence level of 95 %, there is still a chance of 5 % that the actual value is not within the determined confidence interval.

EXAMPLE 2: A mean value based on 200 values should be estimated to be 5 %. By using an appropriate method (e.g. the Pearson-Clopper algorithm, see TS 102 250-6 [i.9]), the confidence interval based on a 95 % confidence level can be determined to be [2,42 % ; 9 %]. Then, the width of the confidence interval is 6,58 %.

In other words, the determined mean rate of 5 % lies with a probability of 95 % in fact in the interval [2,42 % ; 9 %]. There is still a probability of 5 % that the real value is smaller than 2,42 % or higher than 9 %.

Following these examples, it is obvious that there is a relationship between the number of data sets ("samples") which are taken into consideration and the quality of the determined measures. Further information on this can be found in the annex A of TS 102 250-6 [i.9].

4.3.4 Accuracy of indicators

For parameters which estimate a ratio of two values, the width of the confidence interval can be determined like described in clause 4.3.3. The outcome of this calculation can be interpreted as the accuracy of the relevant indicator. For other parameters like time parameters or opinion rating parameters, the width of the confidence interval is determined on an individual basis.

4.3.5 Observation period

Many parameters defined in clause 5 make use of observation periods with a limited time duration. These periods are necessary to prevent measurements or data retrieval phases from infinite waiting for events which may never occur in the future. This continued waiting for outstanding events could cause deadlock situation and will hinder an effective application of defined parameters.

For this reason, the waiting periods or observation periods are limited in time. Every event which occurs after this timeout period are not taken into consideration for calculation of parameters. Furthermore, this concept allows to plan the duration of data retrieval phases which will reduce the organizational cost for these evaluations.

4.3.6 Selection of Panels

Opinion ratings [OR] are a commonly used method to assess parameters which are based on an individual and subjective perception. The opinion ratings are to be presented on a segment basis to represent each distinctive customer group. The following segmentation is recommended:

Residential customers:

- Young people aged between 11 and 21 years.
- Adults aged between 21 and 65 years.
- Elderly aged 65 and over.

Business customers:

- Business customers aged 21 and above.

Where other user segments are selected opinion ratings for these may also be reported.

The selection of segmentation should ensure, as far as possible, comparability within the EU.

4.3.7 Determination of boundary conditions prior to assessment of parameters

Comparability of results is a major issue when measures are generated. To achieve this comparability, the boundary conditions of assessments to compare need to be the same.

Typical conditions which should have been defined before an assessment, measurement or opinion rating takes place are the following ones:

- Timeout values: Any kind of period that will be taken into account to terminate a measurement period in a predefined manner. This avoids deadlocks caused by infinite waiting of expected events which will not occur.
- Weighting of results for compound parameters: If a parameter is a composite parameter consisting of different contributions, the weight of each contribution should be determined in advance.

Typically, the stakeholders of an assessment determine these variables prior to any activity. For example, a national regulator defines these parameter sets before the obliged operators start their activities.

The comparability of results is ensure only if the variable settings are kept constant over the period of time that is considered in such a comparison.

4.4 Guidance on the presentation of the results

According to the previous clauses, the following statements are providing generic recommendations for the presentation of results.

Each of these measures may be presented in various combinations of elements. Hereafter are listed the preferred presentation modes for these various contexts. The clause on presentation of results for each parameter specifies which element/s are recommended for its presentation taking into consideration the various conditions of the assessment, in particular the type of the QoS parameters (Opinion Rating [OR], Percentage [%], Time or Number) and the mode of assessment (SP data audit, expert panel or customer survey). For example for parameter P 102 - Pricing Transparency the recommended elements for the presentation of Opinion Rating [OR] are: Histograms and Mean of Expert Panel and Customer panel assessment ratings.

As a principle, the presentation of the results should provide as detailed information as possible on the spread of the results, including those of the expert panel members, and not a single figure e.g. a mean value.

4.4.1 Histogram

In most cases an histogram should be provided to highlight either the breakdown of the results (% or T) or the spread of the opinion of an audit team or of an expert panel (OR).

Main exceptions are where the result is a single figure [Number].

4.4.2 Distribution Functions

Probability Density Functions (PDF) and Cumulative Distribution Functions (CDF) should be given as soon as the size of the data set is large enough (i.e. > 300) in order to provide a more comprehensive information on its spread.

4.4.3 Mean value

Mean can bring additional information to an histogram if the size of the data set is large enough (i.e. > 100) in order, for instance, to monitor the QoS evolution from the SP viewpoint.

In any case, the mean value should not be provided alone but, as far as possible, with the value of the standard deviation and where appropriate boxplots for a condensed representation of the data set.

Where appropriate, the confidence level for mean value is given.

4.4.4 Quantile

Quantile are meaningful provided the data set is large enough (i.e. > 300). As explained in clause 4.3.2 the median value may, in some cases, have some advantages compared with the mean value.

4.4.5 Chart

Charts are needed in particular for a complete information on QoS parameters like P507 or P616 resulting of an aggregation of several parameters or where assessment is carried out on several consumer segments.

4.4.6 Choice of the best suited presentations

In most cases, histograms are providing the most useful statistical information to the consumers. Where applicable PDF CDF and quantile should be given to provide additional information.

Charts could help to visualize and better understand the results in particular for composite indicators.

5 Parameter Definitions

For completeness and ease of understanding, this clause provides generic definitions of the QoS parameters listed in EG 202 009-2 [i.2] for each stage of the Customer Relationship Course although, as explained in scope, the aim of the present document is to detail the testing method only for those where it is considered necessary.

The concept of the present document is based on the idea that QoS parameters can be defined in a very generic way if the perspective is shifted to the customer's one. Usually, the customer is not interested in details or procedures which are not obvious to him. Therefore, he knows when an activity is started and he expects an outcome of the started activity after some time. For this reason, this clause defines QoS parameters for all relevant customer relationship stages from the customer's perspective in a generic way.

More detailed information on evaluation specific topics can be found later on in clause 6. Basic background information related to the evaluation procedures can be found in clause 4.

To illustrate the sequences within the customer stages, this clause makes use of time line figures. Blue boxes (above the timeline) always show the observable events from the customer's point of view whereas the green boxes (below the timeline) represent the related parameters.

Dotted lines connect the parameters to the timeline and show:

- either the start and end points in time (referred as "trigger points") which are relevant for a parameter; or
- they are connected to a specific point of time after which a parameter can be determined.

5.1 Customer Relationship Stage: Preliminary information (PI)

Preliminary Information (PI) is often the first point of contact or interest for the potential customer/user for a telecommunication service. This should contain the main points - sufficient to inform and educate the enquirers to enable them to make an informed judgement.

The timeline below illustrates the relation between customer request and receipt of PI and the parameters derived for this stage.

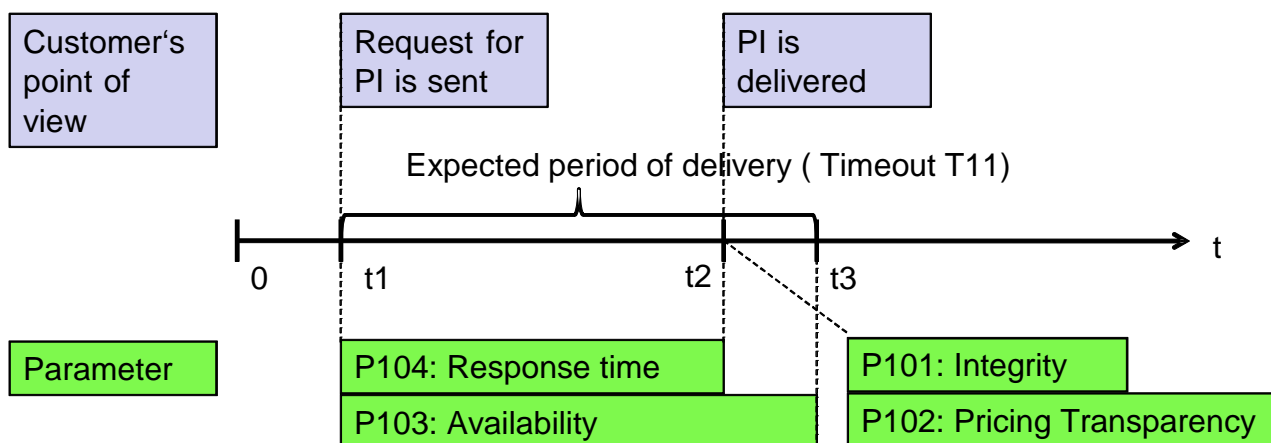

Figure 7: Events and parameters for Preliminary information

The user oriented parameters identified for this stage are:

- P101: Integrity of PI [OR]
- P102: Pricing transparency [OR]
- P103: Availability of PI [%]
- P104: Response time for the provision of PI [Time]
- P105: Response time of the commercial desk [Time & %]
- P106: Overall rating of the responsiveness of the service desk [OR]
- P107: User friendliness of the Internet user interface [OR]
- P108: User friendliness of the service desk operators [OR]

5.1.1 P101: Integrity of PI [OR]

5.1.1.1 Definition of Parameter

The parameter "integrity of PI" is expressed by a true and fair view of the main points of a telecommunications service provided by a SP for the attention of the potential user/customer.

5.1.1.1.1 Explanation on Parameter Definition

For integrity of PI all points made by the SP should be unambiguous, without misleading statements, implied or obvious.

The following issues are relevant to the integrity of the PI requested of a service or an application (clauses 6.1.1.1, 6.1.1.2 and 6.1.1.3 of EG 202 009-1 [i.1] provides details on what PI should provide):

- 1) **Content:** All information relevant to the customer regarding a service or an application should be contained in the PI.

All pertinent information should be clearly stated and should not be hidden/masked: e.g. when a SP indicates the maximum speed of transmission of Broadband it should state under what conditions this can be achieved and the probable frequency of achievement.

- 2) **Language:** The phrasing and expressions used should target the customer segment the (PI) is aimed at.
- 3) **Style:** The style of presentation used should be legible and the context of text provided should be easy to read. For example, badly contrasted text in unsuitable backgrounds will make it difficult to read and assimilate the meaning of the text.

Where there are modes of provision of information the prominent one - or a few of these - should be assessed for integrity.

All modes of conveying the PI e.g. telephone, Internet, hard copy (post or pick up brochures), person to person information, video or Multi Media (including avatar), should comply with the guidelines stated above.

5.1.1.2 Equation

$$P101[OR]_{Cs} = \frac{\sum_i OR_{Cs,i}(C) \times p\%}{N} + \frac{\sum_i OR_{Cs,i}(L) \times q\%}{N} + \frac{\sum_i OR_{Cs,i}(S) \times r\%}{N}$$

Where OR is the weighted opinion rating comprising:

<i>i</i>	Index of expert/customer
<i>N</i>	Number of experts/customers in the panel
<i>Cs</i>	Customer segment
<i>p, q, r</i>	Weighting factors
<i>C</i>	Opinion rating for contents
<i>L</i>	Opinion rating for the language
<i>S</i>	Opinion rating for the style

p, *q* and *r* are the weighting for content, language and style expressed in % and together total 100. The weighting may differ or be equal. The weighting could change with time; however if changes to weighting are implemented it should be born in mind comparability may be affected.

The values of *p*, *q* and *r* should be defined by the stakeholders (e.g. regulators) as well as the duration of their applicability for the sake of comparability.

If no customer segmentation is required, the calculation can be simplified by leaving out the *Cs* parameter so that the equation becomes:

$$P101[OR] = \frac{\sum_i OR_i(C) \times p\%}{N} + \frac{\sum_i OR_i(L) \times q\%}{N} + \frac{\sum_i OR_i(S) \times r\%}{N}$$

5.1.1.3 Measure

Opinion Rating [OR] as defined in clause 4.1.

5.1.2 P102: Pricing transparency [OR]

5.1.2.1 Definition of Parameter

The "pricing transparency" parameter is expressed by OR on clarity, conciseness and unambiguity for all usage conditions in every tariff structure for every service provided by the SP given by an expert panel.

5.1.2.1.1 Explanation on Parameter Definition

Pricing information states clearly the rules for the calculation of the amount the customer has to pay under specified conditions of use and for exceeding the conditions e.g. exceeding the usage time where there is limited allocation for a given tariff. All relevant information should be provided to enable the customer to calculate precisely the amount due to the SP. The pricing structure should include all forms of usage conditions.

5.1.2.2 Equation

$$P102[OR] = \frac{\sum_{i=1}^N OR_i}{N}$$

where OR is the mean opinion rating, with OR_i ($i = 1 \dots N$) being the individual opinion ratings for the N members of the audit panel.

i	Index of expert/customer
N	Number of experts/customers in the panel.

5.1.2.3 Measure

Opinion rating [OR] as defined in clause 4.1.

5.1.3 P103: Availability of PI [%]

5.1.3.1 Definition of Parameter

The parameter "availability of PI" is expressed as the ratio of the number of requests from potential users and customers for PI which has been delivered to the total number of requests within the pre-defined timeout interval T_{11} .

5.1.3.1.1 Explanation on Parameter Definition

This parameter describes the percentage of requests for PI by customers that are successfully fulfilled by an in-time delivery.

The delivery of other than the PI information or a too late delivery of the requested PI would be counted as failed attempts.

The pre defined period will take into account the mode of requesting the PI and the mode in which the PI is delivered to the enquirer.

The available modes of provision or availability of the PI are to be stated by the SP.

Examples of modes are: printed matter, electronic versions such as web pages either as text or video (with or without audio), voice (recorded or live) etc.

The timeout value T_{11} is required to prevent from permanent waiting for the PI delivery event. Delivery that do not occur within the timeout period are counted as unsuccessful which means, that they deliver no contribution to this parameter.

The PI is normally made available to the whole of the population. Where there is an issue on geographical or technological factors the provider could endeavour to make alternative provisions, with different mode/s to make PI available to the potential customers and users in the affected areas.

5.1.3.2 Equation

$$P103 [\%] = \frac{\sum N_{PI}}{\sum N_R}$$

With

$$N_{PI} = \begin{cases} 1 & \text{if } t_{PI} \leq T_{11} \\ 0 & \text{if } t_{PI} > T_{11} \end{cases}$$

and

$$N_R = \begin{cases} 1 & \text{if } PI \text{ is requested} \\ 0 & \text{if } PI \text{ is not requested} \end{cases}$$

and

$$0 \leq t_R \leq t_{PI} \leq t_R + T_{11}$$

where

$\sum N_{PI}$	Number of requests with PI delivery within time period T_{11} after t_R
$\sum N_R$	Number of requests for PI delivery

t_{PI}	Point of time when expected PI delivery period expires (t_3 in figure 7)
t_R	Point of time when PI is requested (t_1 in figure 7)
T_{11}	Maximum expected time for PI delivery, timeout (between t_1 and t_3 in figure 7)

All measures are related to the reporting period.

5.1.3.3 Measure

This parameter is expressed as a percentage.

5.1.4 P104: Response time for the provision of PI [Time]

5.1.4.1 Definition of Parameter

The parameter "response time for the provision of PI" is expressed as the time taken from the instant a request for PI was sent to the SP to the instant all requested information was delivered to the customer requesting the information.

5.1.4.1.1 Explanation on Parameter Definition

Time to provide PI is to be measured for each of the main modes. Examples of modes of providing PI are: post (for printed material), electronic mail, telephone (two way live conversation) and Internet web pages. Response by the SP to a request for PI may be made in any of the other modes available.

Table 3: Provision mode of PI

Mode of request	Mode of response
1 - Email	1, 2 or 3
2 - Voice	2 or 3
3 - Letter	2 or 3
4 - Web page	1, 2, 3 or 5
5 - In person	2, 3 or 5

The modes of response shown are the most commonly encountered but not necessarily constrained to these.

When estimating response times to report a selection from the above combinations ought to be considered.

5.1.4.2 Equation

$$P104 [Time] = \frac{\sum_{i=1}^N (t_{2,i} - t_{1,i})}{N}$$

where

N	Number of PI delivery events
i	Index of each PI delivery event
$t_{1,i}$	Point of time when PI delivery request i is sent
$t_{2,i}$	Point of time when PI delivery event i actually occurs

5.1.4.3 Measure

Mean of the N measurements taken for the supply of PI for a given number of modes.

5.1.5 P105: Response time of the commercial desk [Time & %]

Time elapsed between the end of dialling and reaching a commercial operator:

P105a[Time]	mean time to answer; and
P105b[%]	percentage of calls answered within 20 seconds.

Reference: Response time for admin/billing enquiries; EG 202 009-2 [i.2], ES 202 057-1 [i.3].

5.1.6 P106: Overall rating of the responsiveness of the service desk [OR]

P106[OR] Assessment of the responsiveness of the service desk by a representative user panel

Reference: Quality of customer relations; EG 202 009-2 [i.2], ES 202 057-1 [i.3].

5.1.7 P107: User friendliness of the Internet user interface [OR]

P107[OR] Assessment of the user friendliness of the Internet user interface by a representative user panel.

Reference: Quality of customer relations; EG 202 009-2 [i.2], ES 202 057-1 [i.3].

5.1.8 P108: User friendliness of the service desk operators [OR]

P108[OR] Assessment of the assurance, empathy and responsiveness of the service desk operators by a representative user panel.

Reference: Quality of customer relations; EG 202 009-2 [i.2], ES 202 057-1 [i.3].

5.2 Customer Relationship Stage: Contract Establishment

There is a contract between the SP and the customer. When the customer is a business, small or large, a formal contract is entered into between the two parties. Three categories of contracts exist:

- 1) firstly, straightforward contract without any customisation;
- 2) secondly, contracts with customisation of terms and conditions and QoS aspects, negotiated before signing the contract; and
- 3) thirdly further customization after a contract was signed.

QoS parameters have been identified to take into account the performance characteristics of this contractual stage.

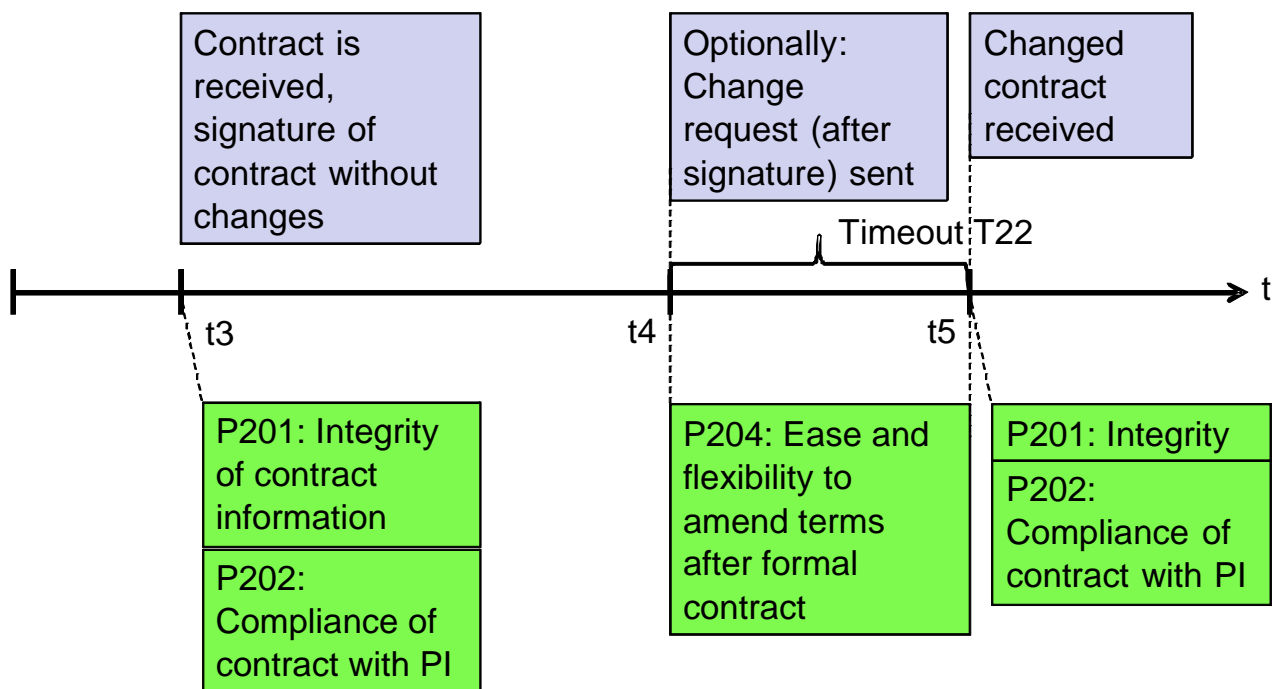

Figure 8a: Events and parameters for contract establishment (without customisation before signature)

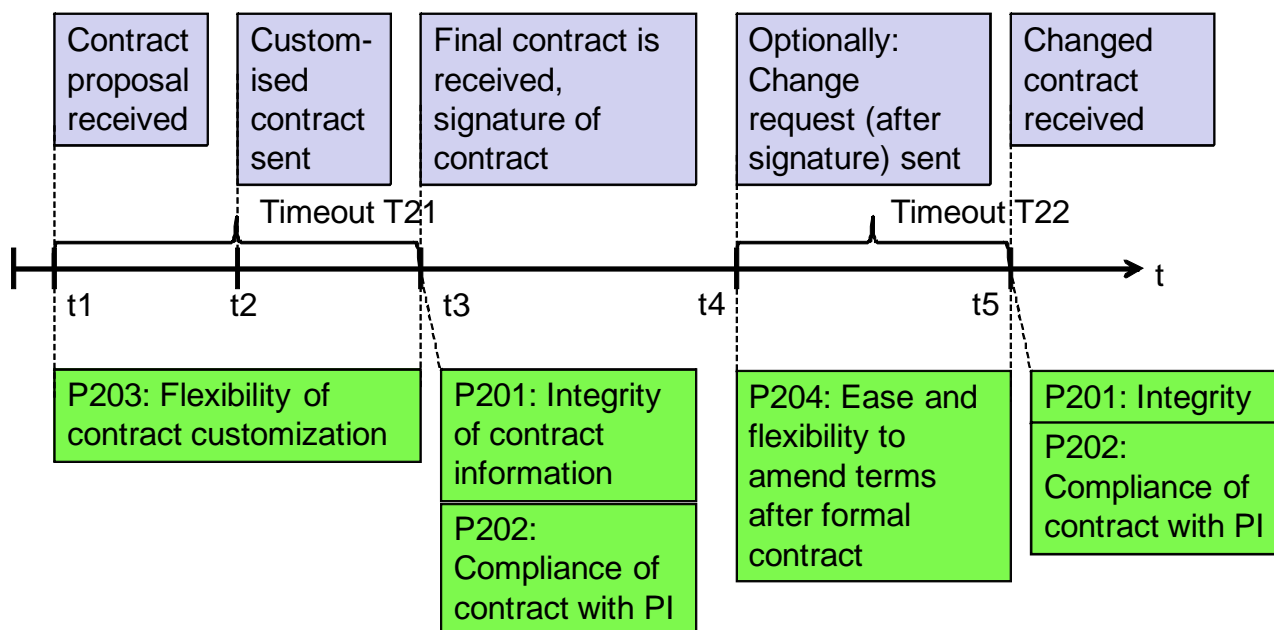

Figure 8b: Events and parameters for contract establishment (with customisation before signature)

The user oriented parameters identified for this stage are:

- P201: Integrity of contract information [OR]
- P202: Compliance of contractual terms with PI [%]
- P203: Flexibility for customisation before contract [OR]
- P204: Ease and flexibility to amend terms after formal contract [OR]
- P205: Response time of the commercial desk [Time & %]
- P206: Delay to settle a contract [Time & %]
- P207: Delay for a contract acknowledgment [Time & %]
- P208: Overall rating of the responsiveness of the sales desk [OR]
- P209: Ease of the subscription process [OR]
- P210: Vendors empathy and responsiveness [OR]

5.2.1 P201: Integrity of contract information [OR]

5.2.1.1 Definition of Parameter

The parameter "integrity of contract information" is expressed by a true and fair view of the information on supply, maintenance and cessation for a telecommunications service provided by a SP.

NOTE 1: A contractual document describing the supply, maintenance and cessation for a telecommunication service by a SP is clear, accurate, complete, understandable and unambiguous.

NOTE 2: The language, phrasing and expressions chosen are aimed at maximum understanding for the target customer segment.

5.2.1.1.1 Explanation on Parameter Definition

The contractual document lists all pertinent terms and conditions that affect both the customer and the SP. These include escalation procedures and any compensation schemes that may apply when the implied or agreed performance of the SP is not met.

The terms and conditions stated are both fair and reasonable to both parties.

5.2.1.2 Equation

$$P201[OR] = \frac{\sum_{i=1}^N OR_i}{N}$$

where OR is the mean opinion rating, with OR_i ($i = 1 \dots N$) being the individual opinion ratings for the N members of the audit panel.

i	Index of expert
N	Number of experts in the panel

5.2.1.3 Measure

Opinion rating [OR] as defined in clause 4.1.

5.2.2 P202: Compliance of contractual terms with PI [%]

5.2.2.1 Definition of Parameter

The parameter "compliance of contractual terms with that offered in the PI" is expressed as the degree of concurrence of the contents of the contractual document to the PI. This comparison between contractual terms and PI should be based on the PI in force during the period of the contract. Contractual document could have detailed terms which were only implicit in the PI. Such differences are not to be considered as errors as long as additional and not contradictory information is provided.

5.2.2.1.1 Explanation on Parameter Definition

Terms and conditions stated in the contract should reflect the PI provided to the customer by the SP. It should be without any ambiguous information.

A pre defined catalogue of criteria is used to assess the matching of contract information to the PI.

5.2.2.2 Equation

$$P202 [\%] = \frac{\sum N_{EF}}{\sum N_C}$$

with $N_{EF} = \begin{cases} 1, & \text{if contract is error - free} \\ 0, & \text{else} \end{cases}$

and $N_C = \begin{cases} 1, & \text{if contract proposal is received} \\ 0, & \text{else} \end{cases}$

where

$\sum N_{EF}$	Number of delivered contract proposals without errors
$\sum N_C$	Number of delivered contract proposals

All measures are related to the reporting period.

5.2.2.3 Measure

Error free rate expressed as a percentage.

5.2.3 P203: Flexibility for customisation before contract [OR]

5.2.3.1 Definition of Parameter

The parameter "flexibility for customisation in a contract" with the SP is expressed by the scope and boundary to meet individual customer's specific requirements of service feature/s, service performance/s and terms and conditions before formal signature on the contract.

NOTE: These specific requirements would be departures from the standard service features, performance and terms and conditions normally offered by the SP.

5.2.3.1.1 Explanation on Parameter Definition

Certain customers may require customisation of service features, service performance and perhaps also terms and conditions of contract from that offered in the standard package by the SP. Such changes are usually motivated by the specific needs of their business and are negotiated on a bilateral basis between the SP and the customer.

5.2.3.2 Equation

$$P203[OR] = \frac{\sum_{i=1}^N OR_i}{N}$$

where OR is the mean opinion rating, with OR_i ($i = 1 \dots N$) being the individual opinion ratings for the N members of the audit panel.

i	Index of expert/experienced user
N	Number of experts/experienced users in the panel

5.2.3.3 Measure

Opinion rating [OR] as defined in clause 4.1.

5.2.4 P204: Ease and flexibility to amend terms after formal contract [OR]

5.2.4.1 Definition of Parameter

The parameter "Ease and flexibility available from the SP to amend terms after contract is signed" is expressed by the scope and boundary of the amendments that could be accommodated to contractual terms to satisfy the post contractual amendments sought by a customer.

This excludes contracts which the provider has specifically stated as not considered for amendments.

5.2.4.1.1 Explanation on Parameter Definition

Certain customers may require amendments to terms and conditions of contract after formal agreement. These may include tariff, payment options, QoS levels etc. to suit the specific requirements of the organisation seeking changes. Such changes are usually motivated by the specific needs of their business and are negotiated on a bilateral basis between the SP and the customer once the need for such amendments becomes apparent to the customer.

5.2.4.2 Equation

$$P204[OR] = \frac{\sum_{i=1}^N OR_i}{N}$$

where OR is the mean opinion rating, with OR_i ($i = 1 \dots N$) being the individual opinion ratings for the N members of the audit panel.

i	Index of expert/user
N	Number of experts/users in the panel

5.2.4.3 Measure

Opinion rating [OR] as defined in clause 4.1.

5.2.5 P205: Response time of the commercial desk [Time & %]

Time elapsed between the end of dialling and reaching a commercial operator:

P205a[Time]	mean time to answer, and
P205b[%]	percentage of calls answered within 20 seconds.

Reference: Response time for admin/billing enquiries; EG 202 009-2 [i.2], ES 202 057-1 [i.3].

5.2.6 P206: Delay to settle a contract [Time & %]

Time taken from the initial contact between the customer and the commercial operator to the instant the contract is placed for a service.

P206a[Time]	the time by which the fastest 50 %, 95 % and 99 % of contract settlement have been completed (expressed in clock hours); or
P206b[%]	the percentage of contract settlement completed any time stated as an objective by the service provider.

Reference: Response time for admin/billing enquiries; EG 202 009-2 [i.2], ES 202 057-1 [i.3].

5.2.7 P207: Delay for a contract acknowledgment [Time & %]

Time taken from the registration by the prospect to the acknowledgment received by the customer.

P207a[Time]	the time by which the fastest 50 %, 95 % and 99 % of acknowledgments have been sent (expressed in clock hours); or
P207b[%]	the percentage of acknowledgments sent any time stated as an objective by the service provider.

Reference: Response time for admin/billing enquiries; EG 202 009-2 [i.2], ES 202 057-1 [i.3].

5.2.8 P208: Overall rating of the responsiveness of the sales desk [OR]

P208[OR]	Assessment of the responsiveness of the sales desk by a representative user panel.
----------	--

Reference: Quality of customer relations; EG 202 009-2 [i.2], ES 202 057-1 [i.3].

5.2.9 P209: Ease of the subscription process [OR]

P209a[OR]	Assessment of the ease of the subscription process by a representative user panel.
P209b[OR]	Ease with which all activities associated with the establishment of the contract may be carried out with the provider.
P209c[OR]	Ease with which forms can be filled and ease with which orders can be placed.

Reference: Quality of customer relations; EG 202 009-2 [i.2], ES 202 057-1 [i.3].

5.2.10 P210: Vendors empathy and responsiveness [OR]

P210[OR]	Assessment of the empathy and responsiveness of the service desk operators by a representative user panel.
----------	--

Reference: Quality of customer relations; EG 202 009-2 [i.2], ES 202 057-1 [i.3].

5.3 Customer Relationship Stage: Service provisioning

This clause defines parameters related to service provisioning procedures. Important points are the complete and correct provisioning of the desired services or service features as well as the in-time provisioning. If one of these elements failed during provisioning, the affected customer can be considered to be unsatisfied.

The service provisioning stage takes two different modes of provisioning procedures into account:

- Version A ("Fixed Date"): The SP communicates one specific date when the service provisioning will take place. This is to ensure that telecommunications services are available as long as they are required at some distinct location. For example, if a company changes its premises, services at the old location are required up to the day of the movement, and the same services are promptly required at the new location.

- Version B ("Announced Period"): In this case, the SP announces a time frame in which the service provisioning should take place. The expectations and requirements related to the exact point of time of the service provisioning procedure are more relaxed. However, an upper threshold of this time frame is defined to reflect the customer's expectation to not to wait too long before he can access the desired service or service features (timeout).

In both versions, the deviation of the time of service provisioning with the scheduled time is evaluated. This applies also to the scheduled delivery of needed equipment and the actual delivery of the equipment.

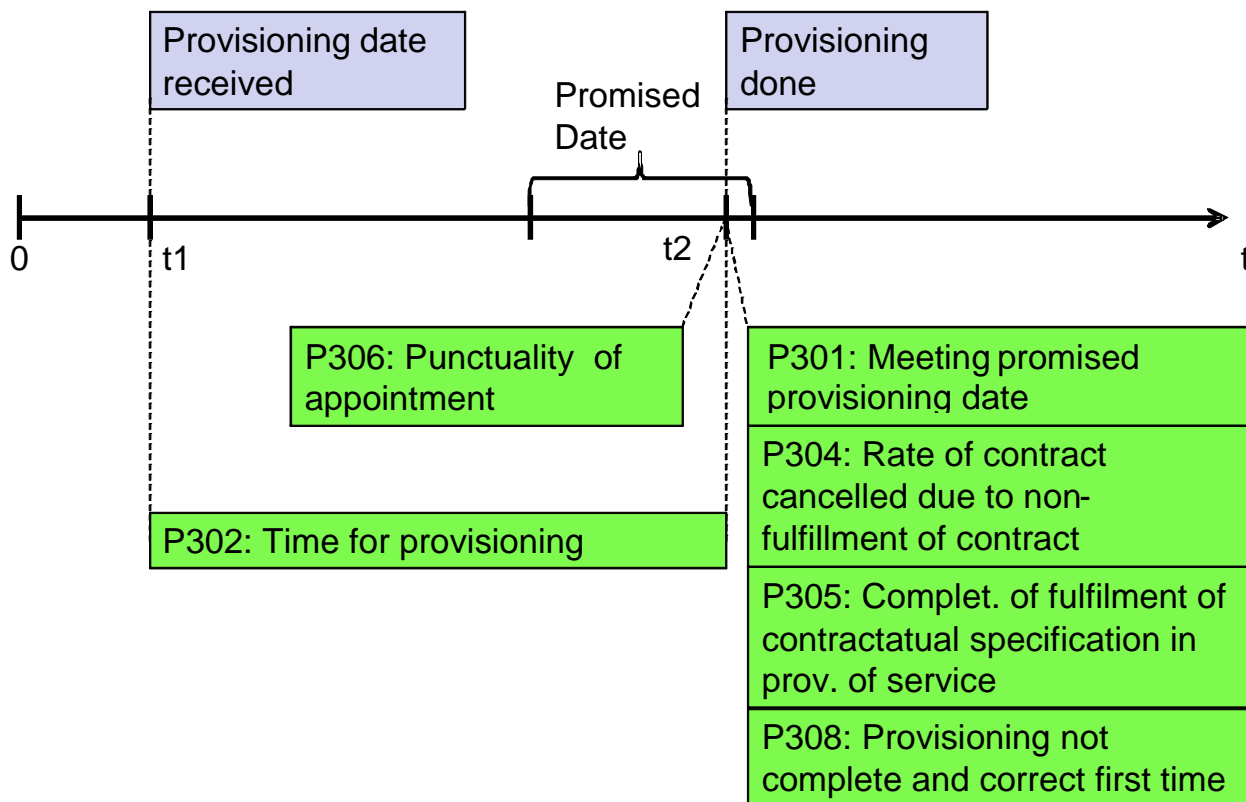

Figure 9a: Events and parameters for service provisioning according to version A ("Fixed Date")

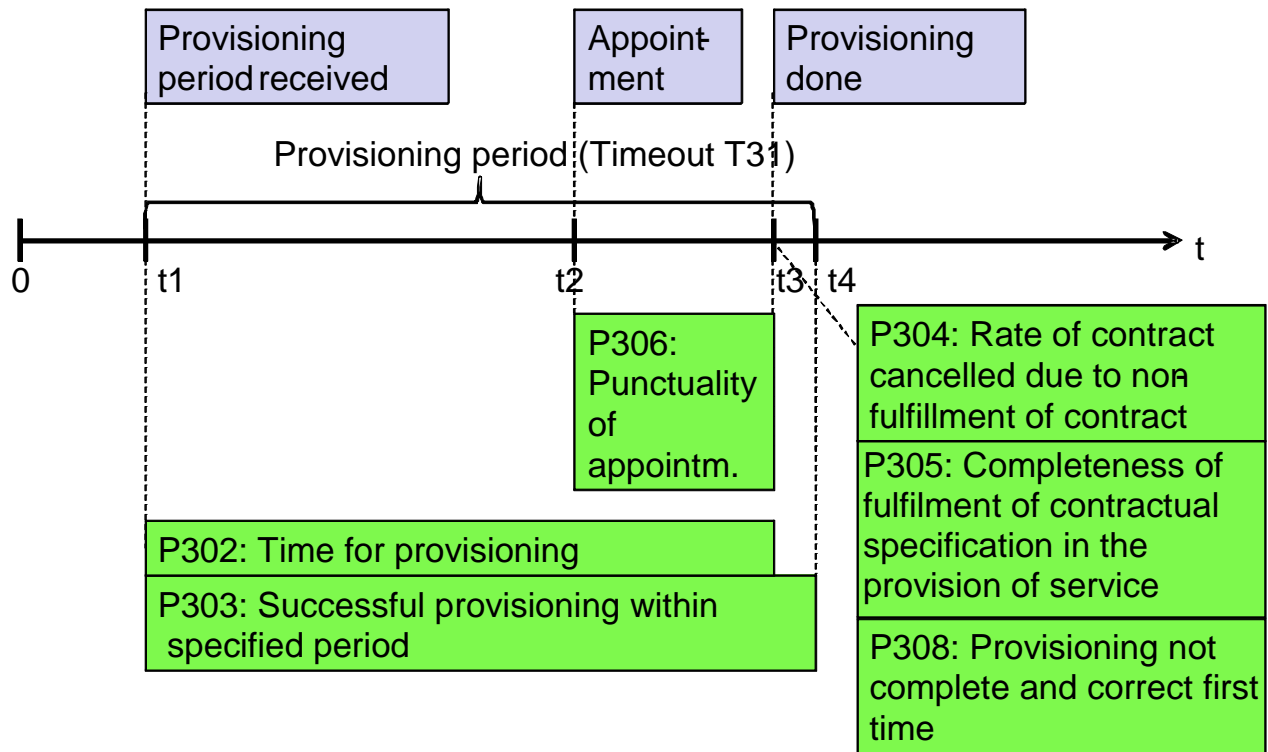

Figure 9b: Events and parameters for service provisioning according to version B ("Announced Period")

As depicted in figure 10, the relation between the time of service provisioning or equipment delivery and the announced point of time is a matter of happening just on time, too early or too late. Therefore, the outcome of the relevant parameters might be positive (≥ 0) if the event happens later than announced, but might also be negative (< 0) if the event appears too early.

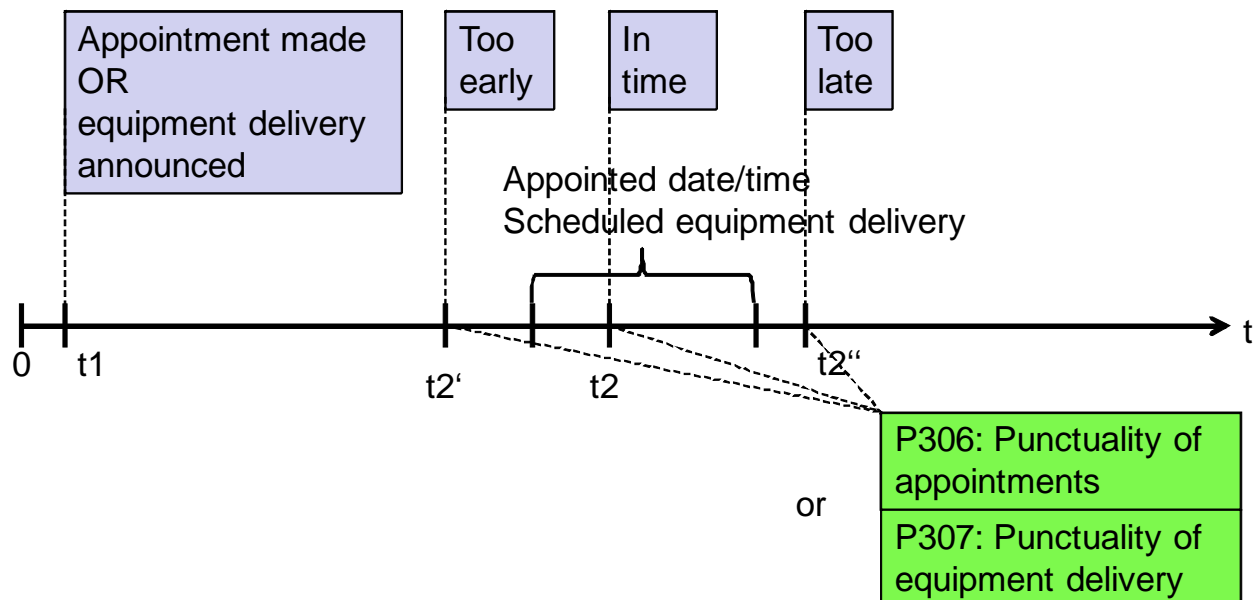

Figure 10: Time deviation between scheduled and actual point of time of service provisioning

The user oriented parameters identified for this stage are:

- P301: Meeting promised provisioning date [%]
- P302: Time for provisioning [Time]
- P303: Successful provisioning within specified period [%]
- P304: Contract cancelled due to non fulfilment [%]
- P305: Completeness of fulfilment of contractual specification in the provision of a service [%]
- P306: Punctuality of service provisioning [Time]
- P307: Punctuality of equipment delivery for service provisioning [Time]
- P308: Provisioning not complete and correct first time [%]
- P309: Provisioning time [Time & %]
- P310: Overall quality of the provisioning process including the reception desk [OR]
- P311: Provider ability to match the customer's wishes for conditions of achievement [OR]
- P312: User friendliness of the means available to the customer for the operations he has to perform [OR]
- P313: Portage delay (when applicable) [Time & %]
- P314: Proportion of problems with number portability procedures [%]

NOTE: In order to avoid any confusion between parameter values obtained according to version A or B, each parameter in this clause will be given a subscript a or b depending on the version adopted.

5.3.1 P301: Meeting promised provisioning date [%]

5.3.1.1 Definition of Parameter

The parameter "meeting promised provisioning date" is expressed as the ratio (percentage) of successful completion of provisioning of service on the date promised in the contract to the total number of signed contracts with promised service provisioning.

5.3.1.1.1 Explanation on Parameter Definition

For specific customers it is of high importance that the promised date is met. This applies especially to customers whose business depends on fully operational network connections.

This parameter is only applicable if the negotiated service contract contains a fixed date for service provisioning.

The parameter refers only to the situation given in figure 9a.

5.3.1.2 Equation

$$P301[\%] = \frac{\sum N_P}{\sum N_S} \times 100\%$$

with
$$N_P = \begin{cases} 1, & \text{if } d_P = d_A \\ 0, & \text{if } d_P \neq d_A \end{cases}$$

and
$$N_S = \begin{cases} 1, & \text{if service provisioning date is announced} \\ 0, & \text{if service provisioning date is not announced} \end{cases}$$

where

$\sum N_P$	Number of contracts with successful service provisioning on promised date
$\sum N_S$	Number of signed contracts with announced service provisioning
d_P	Date on which service provisioning event occurs
d_A	Date on which service provisioning is announced to happen

All measures are related to the reporting period.

5.3.1.3 Measure

The indicator is expressed as percentage.

5.3.2 P302: Time for provisioning [Time]

5.3.2.1 Definition of Parameter

The parameter "time for provisioning" is expressed as the period of time between the scheduled provisioning time and the actual provisioning time.

5.3.2.1.1 Explanation on Parameter Definition

After a contract is concluded, the customer expects the provisioning of his service within a certain timeframe which the SP announces. This parameter reflects the actual period of time which is spent between the announcement by the SP until the service provisioning becomes effective.

A timeout value T_{31} has to be defined to prevent the expected event from unduly long waiting. This parameter is a generic extension of P309 Provisioning time and is applicable to every kind of service.

5.3.2.2 Equation

$$P302 [Time] = \frac{\sum_{i=1}^N (t_{3,i} - t_{1,i})}{N}$$

where

N	Number of service provisioning events
i	Index of each service provisioning event
$t_{1,i}$	Point of time when service provisioning event i is announced
$t_{3,i}$	Point of time when service provisioning event i actually occurs

5.3.2.3 Measure

The indicator is provided in units of time expressed in minutes, hours or days as appropriate.

A timeout value T_{31} is required to prevent from unduly long waiting for the service provisioning event. Provisioning events that do not occur within the timeout period are counted as unsuccessful attempts which deliver no contribution to this parameter.

Related to the parameter "Meeting promised provisioning date [%]", the provisioning period is set to a duration of one day. For longer provisioning periods, the parameter "Ratio of successful provisioning within specified period [%]" should be applied.

5.3.3 P303: Successful provisioning within specified period [%]

5.3.3.1 Definition of Parameter

The parameter "successful provisioning within a specified period" is expressed as the ratio (percentage) of the number of successful service provisioning events to all expected provision events within a pre-defined period of time.

5.3.3.1.1 Explanation on Parameter Definition

By taking into account a specified period of time, this parameter reflects the successful service provisioning that took place within this timeframe.

Only successful service provisioning procedures are considered.

5.3.3.2 Equation

$$P303 [\%] = \frac{\sum N_P}{\sum N_S}$$

with
$$N_P = \begin{cases} 1 & \text{if } t_p \leq T_{31} \\ 0 & \text{if } t_p > T_{31} \end{cases}$$

and
$$N_S = \begin{cases} 1, & \text{if service provisioning date is announced} \\ 0, & \text{if service provisioning date is not announced} \end{cases}$$

and
$$0 \leq t_A \leq t_p \leq t_A + T_{31}$$

where

$\sum N_P$	Number of contracts with successful service provisioning within time period T_{31} after t_A
$\sum N_S$	Number of signed contracts with announced service provisioning
t_p	Point of time when service provisioning event occurs (t_3 in figure 9b)
t_A	Point of time when service provisioning date is announced (t_1 in figure 9b)
T_{31}	Specified period of time

All measures are related to the reporting period.

5.3.3.3 Measure

The indicator is expressed as percentage.

5.3.4 P304: Contract cancelled due to non fulfilment [%]

5.3.4.1 Definition of Parameter

The parameter "contract cancelled due to non fulfilment" is expressed as the ratio (percentage) of the number of contracts cancelled due to the ongoing non-fulfilment as it is considered unreasonable to wait any longer to the total number of signed contracts within the assessment period.

5.3.4.1.1 Explanation on Parameter Definition

Depending on the contractual conditions, the customer may have the right to cancel due to prolonged non-fulfilment of the contract.

The detailed conditions for cancellation have to be defined in the terms and conditions of the contract.

As an example "Permanently not fulfilled" from the customers perspective is defined as the combination of condition 1 with one of the conditions 2 or 3:

- 1) the customer cannot use the service including all the features as agreed in the contract;
- 2) either the contract is not fulfilled within 3 months; or
- 3) the SP did not manage to fulfil the contract within 3 consecutive attempts to repair; or
- 4) the SP did not manage to fulfil the contract within the period of time defined in the contract.

5.3.4.2 Equation

$$P304 [\%] = \frac{\sum N_C}{\sum N_S} \times 100\%$$

with
$$N_C = \begin{cases} 1, & \text{if contract is fulfilled} \\ 0, & \text{if contract is permanently not fulfilled} \end{cases}$$

and
$$N_S = \begin{cases} 1, & \text{if contract is signed} \\ 0, & \text{if contract is not signed} \end{cases}$$

where

$\sum N_C$	Number of contracts which are permanently not fulfilled
$\sum N_S$	Number of signed contracts

All measures are related to the reporting period.

5.3.4.3 Measure

This indicator is expressed as a percentage.

5.3.5 P305: Completeness of fulfilment of contractual specification in the provision of a service [%]

5.3.5.1 Definition of Parameter

The parameter "completeness of fulfilment of contractual specification in the provision of a service" is expressed as the ratio (percentage) of contracts with all network and/or service features specified in the contract fulfilled (after its provisioning) to the number of contracts that have been considered fulfilled for provisioning.

5.3.5.1.1 Explanation on Parameter Definition

The service provisioning procedure is only counted as successful if all contractual specifications have been met. If one or more features specified in the contract are missing, not provisioned or not provisioned in the way expected by the customer, the completeness is lacking.

The criteria to check for completeness should be defined in advance.

5.3.5.2 Equation

$$P305 [\%] = \frac{\sum N_c}{\sum N_s} \times 100\%$$

with $N_c = \begin{cases} 1, & \text{if provisioning is complete} \\ 0, & \text{else} \end{cases}$

and $N_s = \begin{cases} 1, & \text{if contract is signed} \\ 0, & \text{if contract is not signed} \end{cases}$

where

$\sum N_c$	Number of contracts which are permanently not fulfilled
$\sum N_s$	Number of signed contracts

All measures are related to the reporting period.

5.3.5.3 Measure

The parameter is expressed as a percentage.

5.3.6 P306: Punctuality of service provisioning [Time]

5.3.6.1 Definition of Parameter

The parameter "punctuality of service provisioning" is expressed as the time difference between the actual service provisioning time and the contractually specified provisioning time.

5.3.6.1.1 Explanation on Parameter Definition

From the customer's view it is desirable to reduce the efforts which he has to invest when his service is provisioned. For this reason this parameter reflects the compliance of the Service Provider's commitment for the provisioning appointment with the actual event.

The punctuality can be reflected by negative values (service provisioning is done too early) or by positive values (service provisioning is done too late). See also figure 10. In the case of a service provisioning done too early there may be some disadvantages for the customer: e.g. if the service provisioning took place before the customer moved to his new premises, he may have to pay for this period as well.

This parameter can only be calculated after the service provisioning event occurred.

The points of time t_3' and t_3'' in figure 10 apply also to figures 9a and 9b. For simplicity reasons, they are not depicted in these figures.

5.3.6.2 Equation

$$P306 [Time] = \frac{\sum_{i=1}^N (t_{2,i} - t_{1,i})}{N}$$

where

N	Number of service provisioning events
i	Index of each service provisioning event
$t_{1,i}$	Announced service provisioning date for service provisioning event i
$t_{2,i}$	Date when the service provisioning event i actually occurs

NOTE: If $t_{2,i}$ occurs before the announced provisioning date $t_{1,i}$, P306 generates negative values. This is desired to make provisioning events appearing too early also transparent.

5.3.6.3 Measure

The indicator is expressed in unit of time (minutes/hours/days).

5.3.7 P307: Punctuality of equipment delivery for service provisioning [Time]

5.3.7.1 Definition of Parameter

The parameter "punctuality of equipment delivery for service provisioning" is expressed as the time difference between the actual equipment delivery and the delivery announced by the service provider.

5.3.7.1.1 Explanation on Parameter Definition

From the customer's view it may be desirable to have the required equipment delivered before the date of service provisioning. For this reason this parameter reflects the compliance of the Service Provider's commitment for the promised date of equipment delivery with the actual event of receiving the equipment.

The punctuality can be reflected by negative measures (equipment is delivered too early) or by positive measures (equipment is delivered too late). See also figure 10. For equipment delivery, a delivery happening too early may sometimes cause some additional administrative efforts (e.g. the customer has not yet moved to the new premises to receive the equipment), but in general no additional service related expenditures are expected if the equipment is delivered before time.

This parameter can only be calculated after the equipment delivery event occurred.

In general, the reception of the service-specific equipment is a precondition for the service provisioning itself.

5.3.7.2 Equation

$$P307 [Time] = \frac{\sum_{i=1}^N (t_{2,i} - t_{1,i})}{N}$$

where

N	Number of equipment delivery events
i	Index of each equipment delivery event

$t_{1,i}$	Announced equipment delivery date for equipment delivery event i
$t_{2,i}$	Date when the equipment delivery event i actually occurs

NOTE: If $t_{2,i}$ occurs before the announced delivery date $t_{1,i}$, P307 becomes negative. This is a desired situation to make delivery events appearing too early also transparent.

5.3.7.3 Measure

The indicator is expressed in unit of time (days). A finer granularity of the time dimension is not required.

5.3.8 P308: Provisioning not complete and correct first time [%]

5.3.8.1 Definition of Parameter

The parameter "provisioning not complete and correct first time" is expressed as the ratio (percentage) of service provisioning procedures which are either not completely carried out or not correctly carried out in the first attempt to the total number of contracts with the provisioning deemed completed.

NOTE: The indicator for this parameter provides how well the SP has performed in complete and correct provisioning at the first attempt.

5.3.8.1.1 Explanation on Parameter Definition

To ensure that the service provisioning is carried out completely AND correctly in the first attempt, this parameter reflects the ratio of erroneous procedures in relation to all service provisioning procedures within a specified observation period.

It applies also to each time a customer adds a new service to his portfolio.

The parameter reflects the percentage of erroneous firstly applied service provisioning procedures. Further attempts for correct or complete provisioning are not taken into account.

One service unsuccessfully completed in a contract with multiple number of services will be deemed as eligible for this parameter.

5.3.8.2 Equation

$$P308 [\%] = \frac{\sum N_I}{\sum N_S} \times 100\%$$

with $N_I = \begin{cases} 1, & \text{if first time provisioning is not complete or not correct} \\ 0, & \text{else} \end{cases}$

and $N_S = \begin{cases} 1, & \text{if service provisioning is done} \\ 0, & \text{else} \end{cases}$

where

$\sum N_I$ Number of service provisioning events which are either incomplete or not correct in the first attempt

$\sum N_S$ Number of service provisioning events

All measures are related to the reporting period.

5.3.8.3 Measure

The parameter is expressed as a percentage.

5.3.9 P309: Provisioning time [Time & %]

Supply time for fixed network access/supply time for Internet access (time elapsed between the request and the completion of the network connection):

- P309a[Time] the times by which the fastest 50 %, 95 % and 99 % of orders are completed;
 P309b[%] percentage of orders completed by the date agreed with the customer, and, where the percentage of orders completed by the date agreed with the customer is below 80 %, the average number of days, for the late orders, by which the agreed date is exceeded.

separately for:

- 1) narrowband PSTN or ISDN basic rate access where a physical change is required;
- 2) narrowband PSTN or ISDN basic rate access where physical change is not required;
- 3) xDSL access provided over an existing installed access line;
- 4) any other kind of technology in order to provide a fixed network access.

Reference: Supply time for fixed network access/Supply time for Internet access; EG 202 009-2 [i.2], ES 202 057-1 [i.3].

5.3.10 P310: Overall quality of the provisioning process including the reception desk [OR]

- P310[OR] Assessment of the overall quality of the provisioning process by a representative user panel [OR].

Reference: Quality of customer relations; EG 202 009-2 [i.2], ES 202 057-1 [i.3].

5.3.11 P311: Provider ability to match the customer's wishes for conditions of achievement [OR]

- P311[OR] Assessment of the provider ability to match the customer's wishes by a representative user panel [OR].

Reference: Quality of customer relations; EG 202 009-2 [i.2], ES 202 057-1 [i.3].

5.3.12 P312: User friendliness of the means available to the customer for the operations he has to perform [OR]

- P312[OR] Assessment of the user friendliness by a representative user panel [OR].

Reference: Quality of customer relations; EG 202 009-2 [i.2], ES 202 057-1 [i.3].

5.3.13 P313: Portage delay (when applicable) [Time & %]

- P313a[Time] the time by which the fastest 50 %, 95 % and 99 % of acknowledgments have been sent (expressed in clock hours); or
 P313b[%] the percentage of acknowledgments sent any time stated as an objective by the service provider.

5.3.14 P314: Proportion of problems with number portability procedures [%]

- P314[%] Ratio between the number of portability requests having experienced problems and the total request number.

Reference: Proportion of problems with number portability procedures; EG 202 009-2 [i.2], ES 202 057-1 [i.3].

5.4 Customer Relationship Stage: Service alteration

Service alteration is defined as a change in the current service setup which is initiated by the customer of a service or product. The service alteration procedure itself might be executed at the provider's premises, but might also include some change of equipment at the customer's premises.

After the relevant information is exchanged with the service provider, a time window is announced by the provider in which the alteration should take place. A dedicated date is scheduled when the service alteration should take place. Both time dimensions are observed by parameters.

When the service alteration is done, the completeness and correctness of the changes made are proved.

Since changes in the service may incur a change in the applied technology, a reliability parameter is introduced to assess the effectiveness and stability of the executed alteration. In other words, an observation period after the service alteration should assure that the operation has been successfully executed as sustainable.

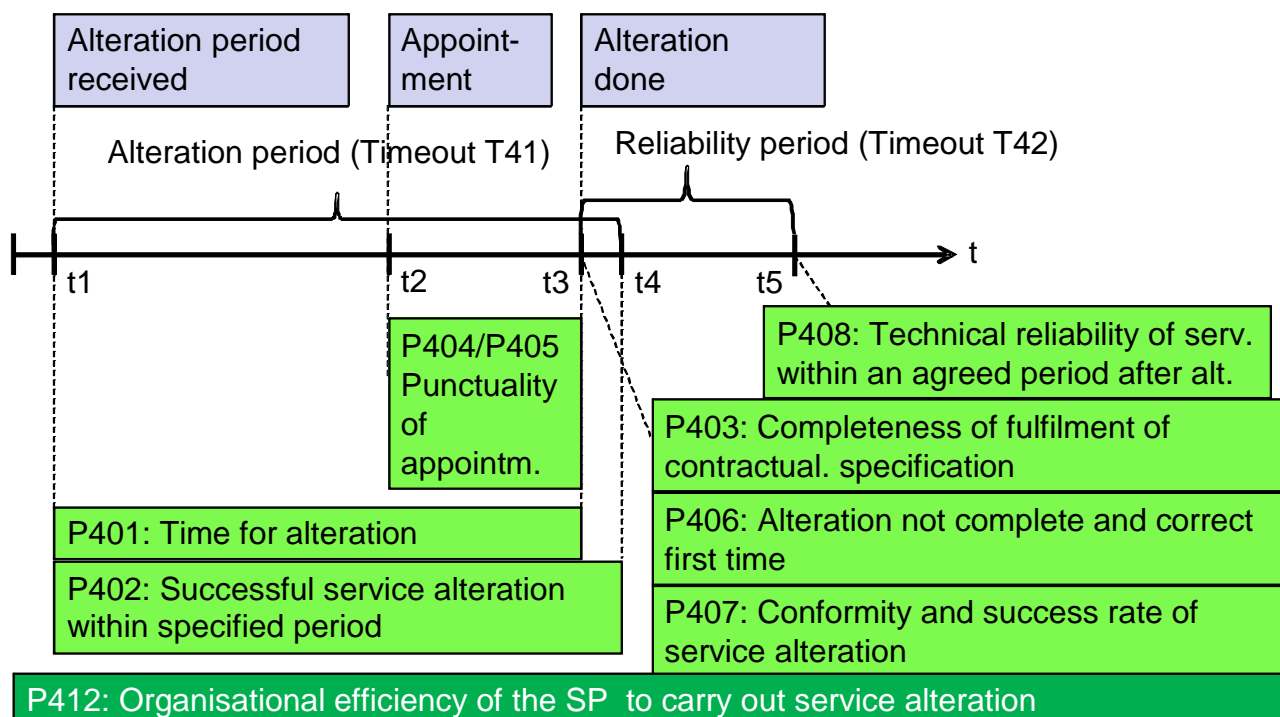

Figure 11: Events and parameters for service provisioning alteration

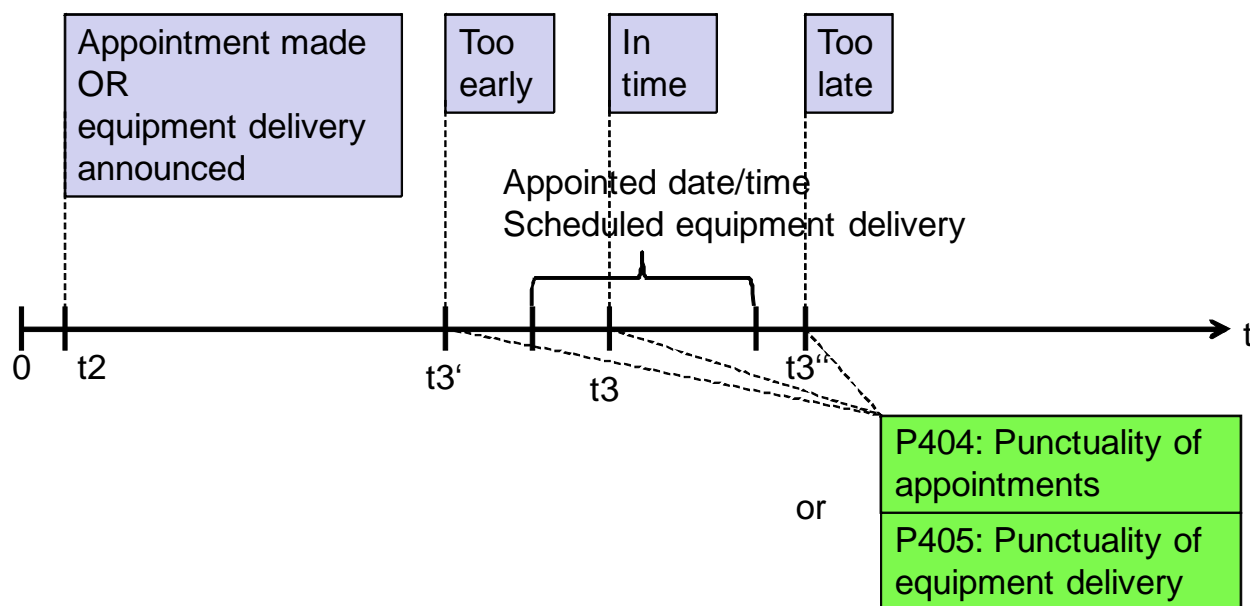

Figure 12: Time deviation between scheduled and actual point of time of service alteration

The user oriented parameters identified for this stage are:

- P401: Time for alteration [Time]
- P402: Successful service alteration within specified period [%]
- P403: Completeness of fulfilment of contractual specification in the alteration of a service [%]
- P404: Punctuality of appointments for service alteration [Time]
- P405: Punctuality of equipment delivery for service alteration [Time]
- P406: Service alteration not complete and correct first time [%]
- P407: Conformity and success of service alteration [%]
- P408: Technical reliability of service within an agreed period after alteration [%]
- P409: Response time of the alteration service [Time & %]
- P410: Overall quality of the alteration process [OR]
- P411: User friendliness of the means available to the customer for the operations he has to perform [OR]

One SP oriented parameter has been identified for this stage:

- P412: Organisational efficiency of service provider to carry out service alteration (SPO) [OR]

5.4.1 P401: Time for alteration [Time]

5.4.1.1 Definition of Parameter

The parameter "time for alteration" is expressed as the time elapsed from the instant alteration notification is received by the user to the instant the alteration is completed.

5.4.1.1.1 Explanation on Parameter Definition

For a customer it is important how long it takes before his requested alteration becomes effective. For this reason, this parameter assesses the actual delay between the announcement of the SP that the alteration will take place to the point of time when it does take place.

The appointment date of service alteration is not taken into account. It may be in advance to the alteration or it may be after the alteration. See also figure 11.

5.4.1.2 Equation

$$P401 [Time] = \frac{\sum_{i=1}^N (t_{3,i} - t_{1,i})}{N}$$

where

N	Number of service alteration events
i	Index of each service alteration event
$t_{1,i}$	Date when the alteration event i is proposed
$t_{3,i}$	Date when the alteration event i actually occurs

5.4.1.3 Measure

The indicator is expressed in unit of time (days). A finer granularity of the time dimension may not be required.

The timeout value T_{41} is required to prevent from undue waiting for the service alteration event. Alteration events that do not occur within the timeout period are counted as unsuccessful attempts which means, that they deliver no contribution to this parameter.

5.4.2 P402: Successful service alteration within specified period [%]

5.4.2.1 Definition of Parameter

The parameter "successful service alteration within specified period" is expressed as the ratio (percentage) of the number of contracts (or services) with successful service alteration to the total number of contracts (or services) with announced service alteration within the contractual specified period of time.

5.4.2.1.1 Explanation on Parameter Definition

By taking into account a specified period of time, this parameter indicates the percentage of successful service alteration procedures that takes place within this timeframe.

Only successful service alterations procedures are considered.

5.4.2.2 Equation

$$P402 [\%] = \frac{\sum N_D}{\sum N_S} \times 100\%$$

with

$$N_D = \begin{cases} 1 & \text{if } t_D \leq T_{41} \\ 0 & \text{if } t_D > T_{41} \end{cases}$$

and

$$N_S = \begin{cases} 1 & \text{if alteration date is announced} \\ 0 & \text{if alteration date is not announced} \end{cases}$$

and

$$0 \leq t_A \leq t_D \leq t_A + T_{41}$$

where

$\sum N_D$	Number of contracts with successful service alteration within time period T_{41} after t_A (compare to t_4 in figure 11)
$\sum N_S$	Number of contracts with announced service alteration
t_D	Point of time when service alteration event occurs (compare to t_3 in figure 11)
t_A	Point of time when service alteration date is announced (compare to t_1 in figure 11)
T_{41}	Period of time specified by the SP

All measures are related to the reporting period.

5.4.2.3 Measure

The parameter is expressed as a percentage.

A timeout value is required to prevent from undue waiting for the service alteration event. Alteration events that do not occur within the timeout period are counted as unsuccessful attempts which means, that they deliver no contribution to the indicator of this parameter.

5.4.3 P403: Completeness of fulfilment of contractual specification in the alteration of a service [%]

5.4.3.1 Definition of Parameter

The parameter "completeness of fulfilment of contractual specification in the alteration of a service" is expressed as the ratio (percentage) of all contracts where all specifications related to the service alteration contractually agreed are met or completed to the total number of contracts where alteration has been requested.

5.4.3.1.1 Explanation on Parameter Definition

The service alteration procedure is only counted as successful if all contractual specifications have been taken into account. If one or more features specified in the contract are missing, not provisioned or not provisioned in the way specified in the contract or the completeness is not achieved.

The criteria to check for completeness should be defined in advance.

This parameter should not be related to time. Whenever a service alteration event occurs, the parameter can be calculated, independently of the fact the event occurs late.

5.4.3.2 Equation

$$P403 [\%] = \frac{\sum N_c}{\sum N_s} \times 100\%$$

with

$$N_c = \begin{cases} 1, & \text{if complete alteration} \\ 0, & \text{else} \end{cases}$$

and

$$N_s = \begin{cases} 1, & \text{if alteration is announced} \\ 0, & \text{if alteration is not announced} \end{cases}$$

where

$\sum N_c$	Number of contracts with completely fulfilled service alteration
$\sum N_s$	Number of contracts with announced alteration

All measures are related to the reporting period.

5.4.3.3 Measure

The parameter should be expressed as a percentage.

5.4.4 P404: Punctuality of appointments for service alteration [Time]

5.4.4.1 Definition of Parameter

The parameter "punctuality of appointments for service alteration" is expressed as the time difference between the actual service alteration and the scheduled alteration time announced by the SP.

5.4.4.1.1 Explanation on Parameter Definition

From the customer's view it is desirable to reduce the efforts which he has to invest when his service is altered. For this reason this parameter reflects the compliance of the SP's commitment for the alteration appointment with the actual event.

The punctuality can be reflected by negative values (service alteration is done too early) or by positive values (service alteration is done too late).

5.4.4.2 Equation

$$P404 [Time] = \frac{\sum_{i=1}^N (t_{3,i} - t_{2,i})}{N}$$

where

N	Number of service alteration events
i	Index of each service alteration event
$t_{2,i}$	Announced service alteration date for service alteration event i
$t_{3,i}$	Date when the service alteration event i actually occurs

NOTE: If $t_{3,i}$ occurs before the announced alteration date $t_{2,i}$, P404 generates negative values. This is desired to make alteration events appearing too early also transparent.

5.4.4.3 Measure

The indicator is expressed in units of time expressed in minutes, hours or days as appropriate.

A timeout value T_{41} is required to prevent from undue waiting for the service alteration event. Alteration events that do not occur within the timeout period are counted as unsuccessful attempts which means, that they deliver no contribution to this parameter.

5.4.5 P405: Punctuality of equipment delivery for service alteration [Time]

5.4.5.1 Definition of Parameter

The parameter "punctuality of equipment delivery for service alteration" is expressed as the time difference between the actual equipment delivery and the scheduled delivery announced by the SP.

5.4.5.1.1 Explanation on Parameter Definition

Special equipment e.g. modem, router may be necessary for the alteration process. This equipment is often sent directly to the user.

Without this equipment it is not possible to perform the alteration. Therefore, the equipment delivery is a precondition for the alteration itself.

5.4.5.2 Equation

$$P405 [Time] = \frac{\sum_{i=1}^N (t_{2,i} - t_{1,i})}{N}$$

where

N	Number of equipment delivery events
i	Index of each equipment delivery event
$t_{1,i}$	Announced equipment delivery date for service alteration event i
$t_{2,i}$	Date when the equipment delivery event i actually occurs

NOTE: If $t_{2,i}$ occurs before the announced equipment delivery date $t_{1,i}$, P405 generates negative values. This is desired to make equipment delivery events appearing too early also transparent.

5.4.5.3 Measure

The indicator is expressed in units of time expressed in minutes, hours or days as appropriate.

A timeout value T_{41} is required to prevent from permanent waiting for the service alteration event. Alteration events that do not occur within the timeout period are counted as unsuccessful attempts which means, that they deliver no contribution to this parameter.

5.4.6 P406: Service alteration not complete and correct first time [%]

5.4.6.1 Definition of Parameter

The parameter "Service alteration not complete and correct first time" is expressed as the ratio (percentage) of service alteration procedures which are either not completely or not correctly carried out in the first attempt to the total number of contracts where alteration has been requested.

5.4.6.1.1 Explanation on Parameter Definition

Upgrades should be carried out successfully first time it is attempted. Various causes could contribute towards successive attempts to fulfil the upgrade, e.g. organisational ineffectiveness, lack of resources, etc.

Due to service alteration procedures, the properties of an already deployed service are changed. To assure that the alterations in the service are carried out completely AND correctly in the first attempt, this parameter reflects the ratio of erroneous procedures in relation to all carried out service alteration procedures within a specified observation period.

5.4.6.2 Equation

$$P406 [\%] = \frac{\sum N_I}{\sum N_S} \times 100\%$$

with $N_I = \begin{cases} 1, & \text{if first time alteration is not complete or not correct} \\ 0, & \text{else} \end{cases}$

and $N_S = \begin{cases} 1, & \text{if service alteration is done} \\ 0, & \text{else} \end{cases}$

where

$\sum N_I$	Number of service alteration events which are either incomplete or not correct in the first try
$\sum N_S$	Number of service alteration events

All measures are related to the reporting period.

5.4.6.3 Measure

The parameter is expressed as a percentage.

A timeout value T_{41} is required to prevent from permanent waiting for the service alteration event. Alteration events that do not occur within the timeout period are counted as unsuccessful attempts which means, that they deliver no contribution to this parameter.

5.4.7 P407: Conformity and success of service alteration [%]

5.4.7.1 Definition of Parameter

The parameter "conformity and success of service alteration" is expressed as the ratio (percentage) of the number of contracts where service alteration was not according to specification and therefore requiring reworking or further service alteration to the total number of contracts where alteration was requested.

5.4.7.1.1 Explanation on Parameter Definition

This parameter is a higher aggregation of the parameters:

- Rate of successful alteration within specified period (P402).
- Completeness of fulfilment of the service alteration stage (P403).

The parameter shows a positive outcome only if a service alteration has been done completely and in-time. If one of these conditions is not achieved, the parameter will have a negative outcome.

5.4.7.2 Equation

$$P407 [\%] = P402 [\%] \times P403 [\%]$$

5.4.7.3 Measure

The parameter is expressed as a percentage.

5.4.8 P408: Technical reliability of service within an agreed period after alteration [%]

5.4.8.1 Definition of Parameter

The parameter "technical reliability of service within an agreed period after alteration" is expressed as the number of observation phases after service alteration without any limitation to the total number of service alteration carried out.

5.4.8.1.1 Explanation on Parameter Definition

A service with alterations carried out should function satisfactorily with all its features for a stated reliability period T_{42} as an expression of the reliability of the alteration process.

Changes in an existing service setup may lead to an increased instability. This parameter makes this potential risk transparent by assessing an observation period after the alteration event. This observation period should not show any service restrictions or limitations related to the customer's service usage.

Only successful reliability phases are considered. This means that there should not be any service restrictions observable after the alteration took place.

One precondition for the calculation of this parameter is that the alteration has been carried out completely (successful outcome of the parameter "Completeness of fulfilment"). For incomplete alterations, the calculation of this parameter has no meaning.

5.4.8.2 Equation

$$P408 [\%] = \frac{\sum N_R}{\sum N_S} \times 100\%$$

where

N_R	Number of observation phases after service alteration without any limitation
N_S	Number of service alteration events

All measures are related to the reporting period.

5.4.8.3 Measure

The parameter is expressed as a percentage.

5.4.9 P409: Response time of the alteration service [Time & %]

The parameter "response time of the alteration service" is expressed as the time taken from the request for an alteration to a service to the instant the altered service is available for use.

- P409a[Time] the times by which the fastest 50 %, 95 % and 99 % of orders are completed;
 P409b[%] the percentage of orders completed by the date agreed with the customer,
 and,
 where the percentage of orders completed by the date agreed with the customer is below 80 %, the average number of days, for the late orders, by which the agreed date is exceeded, separately for each type of alteration.

Reference: Supply time for fixed network access; Supply time for Internet access; EG 202 009-2 [i.2], ES 202 057-1 [i.3].

5.4.10 P410: Overall quality of the alteration process [OR]

Reference: Quality of customer relations; EG 202 009-2 [i.2], ES 202 057-1 [i.3].

5.4.11 P411: User friendliness of the means available to the customer for the operations he has to perform [OR]

Reference: Quality of customer relations; EG 202 009-2 [i.2], ES 202 057-1 [i.3].

The following parameter is SP oriented.

5.4.12 P412: Organisational efficiency of service provider to carry out service alteration (SPO) [OR]

5.4.12.1 Definition of Parameter

The parameter "organisational efficiency of a SP to carry out service alteration" is described and measured by the organisational and hardware resource availability to carry out service alterations to meet the needs of the customer and/or to meet contractual promises.

5.4.12.1.1 Explanation on Parameter Definition

The SP requires organisational and hardware resources to carry out the service alteration management. Shortcomings in this area could lie in shortage of staff, lack of training, shortage of hardware and logistical issues. This parameter is a measure of the efficiency of the provider in addressing these issues and providing adequate resources to satisfy customer's needs.

5.4.12.2 Equation

$$P412[OR] = \frac{\sum_{i=1}^N OR_i}{N}$$

where OR is the mean opinion rating, with OR_i ($i = 1 \dots N$) being the individual opinion ratings for the N members of the audit panel.

- i Index of expert
 N Number of experts in the panel

5.4.12.3 Measure

Opinion rating [OR] as defined in clause 4.1.

5.5 Customer Relationship Stage: Technical upgrade

Technical upgrade is defined as a change in the current service setup which is initiated by the SP of a service or product. An upgrade extends, enhances or improves the available range of services or service features from the customer's perspective.

After the relevant information is exchanged with the SP, a time window is announced by the provider upgrade. A dedicated date is appointed when the technical upgrade should become effective. Outage periods may occur during or after the upgrade. This may come from different causes like e.g. change of equipment, change of transport connection, software upgrades, system reboots, etc.

When the technical upgrade is carried out the completeness and correctness of the changes made can be proved by the customer if he is aware of the completion of the technical upgrade.

Furthermore, since changes in the service may incur in a change in the applied technology, a reliability period is introduced which allows to assess the effectiveness and stability of the executed technical upgrade. In other words, an observation period after the upgrade should assure that the operation has been successfully executed and is sustainable.

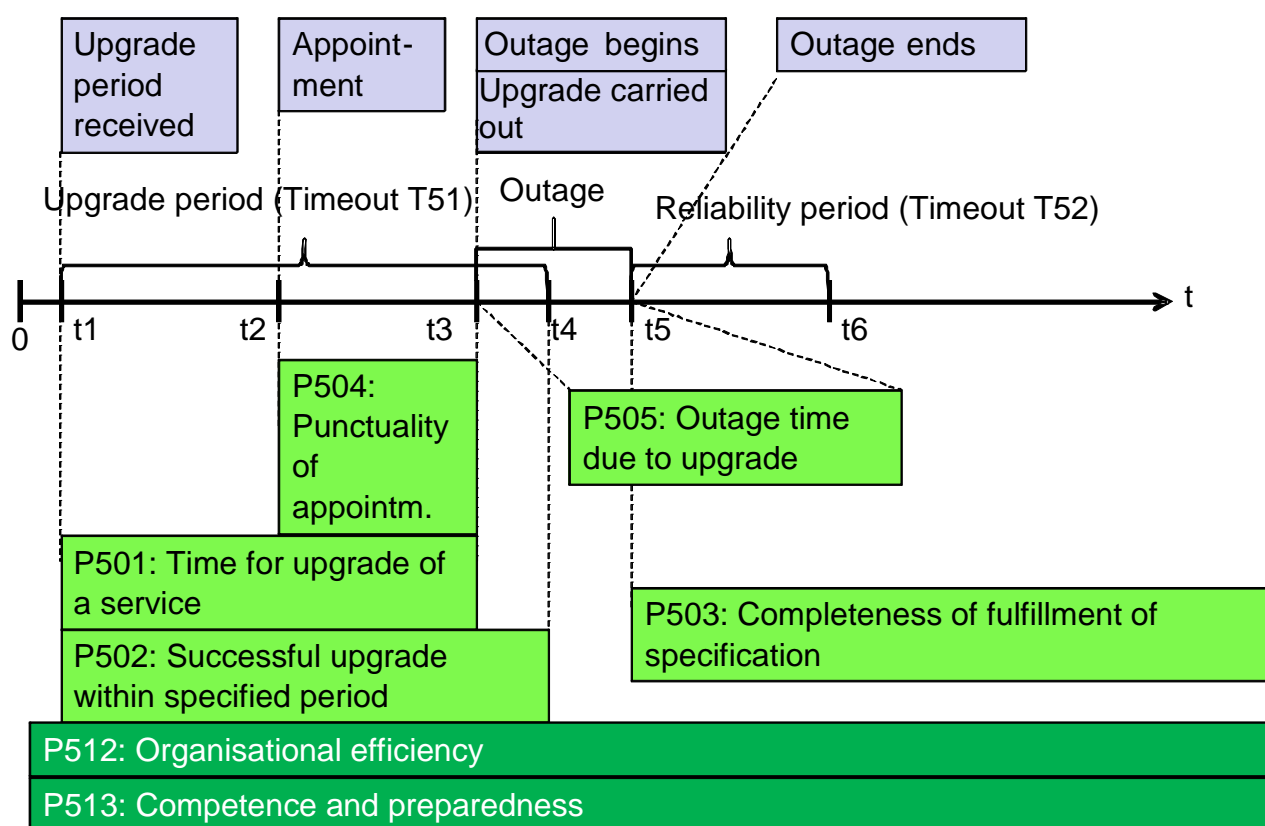

Figure 13a: Events and parameters for technical upgrade procedures (Part 1)

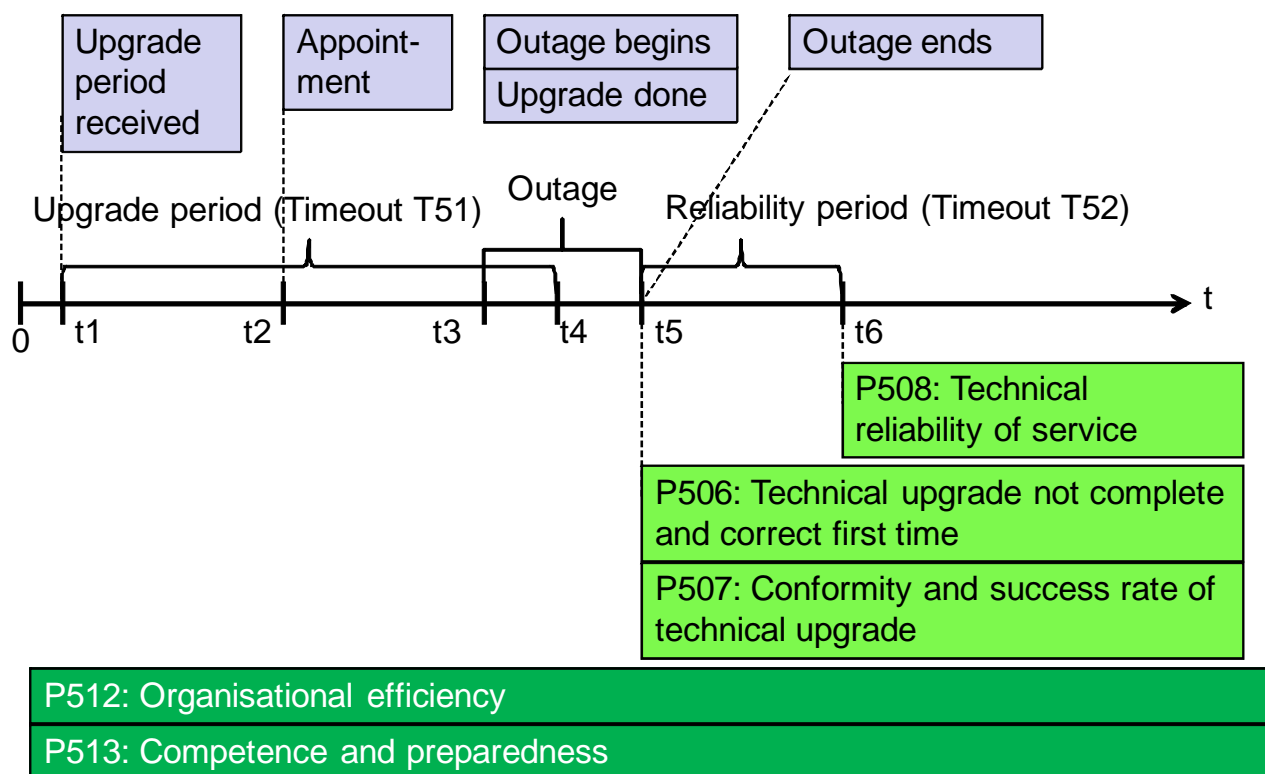

Figure 13b: Events and parameters for technical upgrade procedures (Part 2)

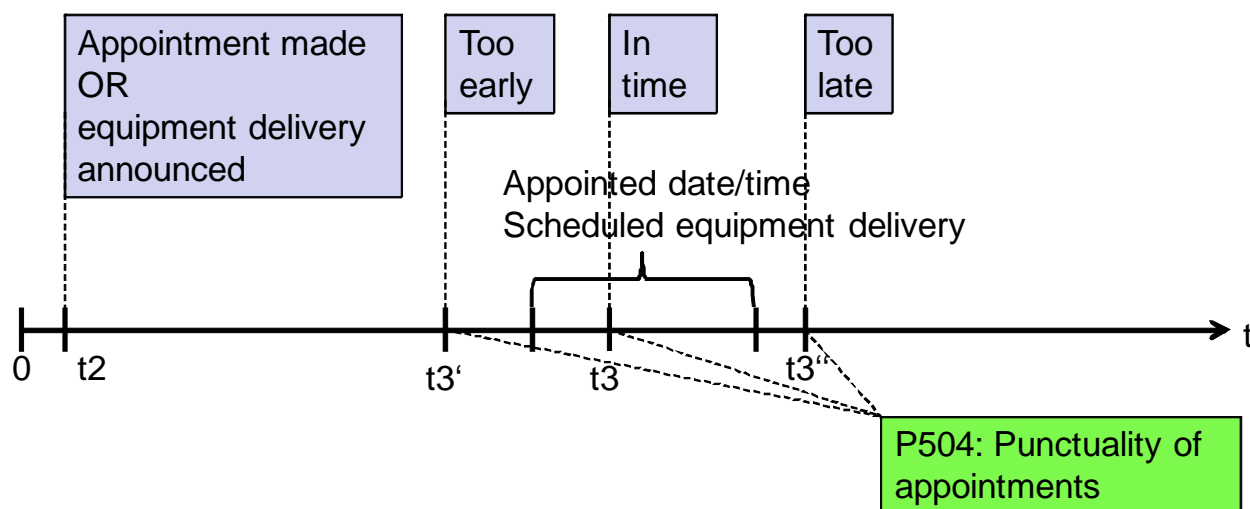

Figure 14: Time deviation between scheduled and actual point of time of technical upgrade procedures

The user oriented parameters identified for this stage are:

- P501: Time for technical upgrade of a service [Time]
- P502: Successful technical upgrade within a specified period [%]
- P503: Completeness of fulfilment of specification in the technical upgrade of a service [%]
- P504: Punctuality of appointments for technical upgrade [Time]
- P505: Outage time due to technical upgrade [Time]
- P506: Technical upgrade not complete and correct first time [%]
- P507: Conformity and success of technical upgrade [%]
- P508: Technical reliability of service within an agreed period after technical upgrade [%]
- P509: Overall quality of the technical upgrade process [OR]
- P510: Provider ability to match the customer's wishes for conditions of achievement [OR]
- P511: User friendliness of the means available to the customer for the operations he has to perform [OR]

Two SP oriented parameters have been identified for this stage:

P512: Organisational efficiency of SP to carry out technical upgrade (SPO) [OR]

P513: Competence and preparedness of SP for technical upgrade (SPO) [OR]

5.5.1 P501: Time for technical upgrade of a service [Time]

5.5.1.1 Definition of Parameter

The parameter "time for technical upgrade" is expressed as the time elapsed from the instant the technical upgrade period was announced to the user to the instant the technical upgrade was carried out.

5.5.1.1.1 Explanation on Parameter Definition

For a customer it is important how long it takes before an announced technical upgrade becomes effective. For this reason, this parameter assesses the actual delay between the announcement of the SP that the technical upgrade will take place to the point of time when it has taken place.

The announced date of technical upgrade is not taken into account. It may be in advance to the alteration or it may be after the technical upgrade. See also figure 13.

5.5.1.2 Equation

$$P501 [Time] = \frac{\sum_{i=1}^N (t_{3,i} - t_{1,i})}{N}$$

where

N	Number of technical upgrade events
i	Index of each technical upgrade event
$t_{1,i}$	Date when the technical upgrade event i is announced
$t_{3,i}$	Date when the technical upgrade event i actually occurs

5.5.1.3 Measure

The indicator should be given in units of time expressed in minutes, hours or days as appropriate.

A timeout value T_{51} is required to prevent undue waiting for the service alteration event. Alteration events that do not occur within the timeout period are counted as unsuccessful attempts which means, that they deliver no contribution to this parameter.

5.5.2 P502: Successful technical upgrade within a specified period [%]

5.5.2.1 Definition of Parameter

The parameter "success of technical upgrade within a specified period" is expressed as the ratio of successful service technical upgrades carried out in a specified timeout interval to the total number of technical upgrades carried out within the same period.

5.5.2.1.1 Explanation on Parameter Definition

By taking into account a specified period of time, this parameter provides a measure of successful service upgrades within this timeframe. This timeframe is chosen to provide a reasonable picture of the efficiency of the SP.

Only successful service upgrade procedures are considered.

5.5.2.2 Equation

$$P502 [\%] = \frac{\sum N_D}{\sum N_S} \times 100\%$$

with

$$N_D = \begin{cases} 1 & \text{if } t_D \leq T_{51} \\ 0 & \text{if } t_D > T_{51} \end{cases}$$

and

$$N_S = \begin{cases} 1 & \text{if technical upgrade date is announced} \\ 0 & \text{if technical upgrade date is not announced} \end{cases}$$

and

$$0 \leq t_A \leq t_D \leq t_A + T_{51}$$

where

$\sum N_D$	Number of contracts with successful technical upgrade within time period T_{51} after t_A (compare to t_4 in figure 13)
$\sum N_S$	Number of contracts with announced technical upgrade
t_p	Point of time when technical upgrade event occurs (compare to t_3 in figure 13)
t_A	Point of time when technical upgrade date is announced (compare to t_1 in figure 13)
T_{51}	Specified observation period

All measures are related to the reporting period.

5.5.2.3 Measure

The parameter should be expressed as a percentage.

A timeout value is required to prevent from permanent waiting for the service alteration event. Alteration events that do not occur within the timeout period are counted as unsuccessful attempts which means, that they deliver no contribution to this parameter.

5.5.3 P503: Completeness of fulfilment of specification in the technical upgrade of a service [%]

5.5.3.1 Definition of Parameter

The parameter "completeness of fulfilment of specification in the technical upgrade of a service" is expressed as the ratio (percentage) of the number of successful upgrades where all specification requirements have been met to the total number of contracts with such upgrades due in a specified period.

5.5.3.1.1 Explanation on Parameter Definition

The technical upgrade procedure is only counted as successful if all the contractual specifications have been taken into account during the technical upgrade. If one or more features specified in the contract are missing, not technically upgraded or not upgraded in the way expected by the customer, the completeness is not achieved.

The criteria to check for completeness should be defined in advance.

This parameter should not be related to time. Whenever a technical upgrade event occurs, the parameter can be calculated, independent of the fact that the event occurs too late.

5.5.3.2 Equation

$$P503 [\%] = \frac{\sum N_C}{\sum N_S} \times 100\%$$

with

$$N_C = \begin{cases} 1, & \text{if complete technical upgrade} \\ 0, & \text{else} \end{cases}$$

and

$$N_S = \begin{cases} 1 & \text{if upgrade is announced} \\ 0 & \text{if upgrade is not announced} \end{cases}$$

where

$\sum N_C$	Number of contracts with completely fulfilled technical upgrade
$\sum N_S$	Number of contracts with announced technical upgrade

All measures are related to the reporting period.

5.5.3.3 Measure

The parameter should be expressed as a percentage.

5.5.4 P504: Punctuality of appointments for technical upgrade [Time]

5.5.4.1 Definition of Parameter

The parameter "punctuality of appointments for technical upgrade" is expressed as the time difference between the actual technical upgrade and the scheduled upgrade time announced by the SP.

5.5.4.1.1 Explanation on Parameter Definition

From the customer's view it is desirable to reduce the efforts which he has to invest when his service is upgraded. For this reason this parameter reflects the compliance of the SP's commitment for the upgrade appointment with the actual event.

The punctuality can be reflected by negative values (service upgrade is done too early) or by positive values (service upgrade is done too late).

5.5.4.2 Equation

$$P504 [Time] = \frac{\sum_{i=1}^N (t_{3,i} - t_{2,i})}{N}$$

where

N	Number of service technical upgrade events
i	Index of each service technical upgrade event
$t_{2,i}$	Announced service technical upgrade date for service technical upgrade event i
$t_{3,i}$	Date when the service technical upgrade event i actually occurs

NOTE: If $t_{3,i}$ occurs before the announced technical upgrade date $t_{2,i}$, P504 generates negative values. This is desired to make technical upgrade events appearing too early also transparent.

5.5.4.3 Measure

The indicator is expressed in units of time expressed in minutes, hours or days as appropriate.

A timeout value is required to prevent from permanent waiting for the technical upgrade event. Upgrade events that do not occur within the timeout period are counted as unsuccessful attempts which means, that they deliver no contribution to this parameter.

5.5.5 P505: Outage time due to technical upgrade [Time]

5.5.5.1 Definition of Parameter

The parameter "outage time due to technical upgrade" is expressed as the duration when the service in part or in full is unavailable to the customer for use due to the technical upgrade process.

5.5.5.1.1 Explanation on Parameter Definition

If the SP upgrades his capabilities (e.g. to improve the services it offers to its customers), in many cases periods of non-availability of the service occur. The duration of these non-availability periods should be minimised to reduce the impact on the service usage.

5.5.5.2 Equation

$$P505 [Time] = \frac{\sum_{i=1}^N (t_{5,i} - t_{3,i})}{N}$$

where

N	Number of technical upgrade events
i	Index of each technical upgrade event
$t_{3,i}$	Time when the outage start event i occurs
$t_{5,i}$	Time when the outage end event i occurs

5.5.5.3 Measure

The indicator is expressed in units of time expressed in minutes, hours or days as appropriate.

A timeout value is required to prevent from undue waiting for the service alteration event. Alteration events that do not occur within the timeout period are counted as unsuccessful attempts which means, that they deliver no contribution to this parameter.

5.5.6 P506: Technical upgrade not complete and correct first time [%]

5.5.6.1 Definition of Parameter

The parameter "technical upgrade not complete and correct first time" is expressed as the ratio (percentage) of the number of contracts not completely carried out or not correctly carried out in the first attempt to the total number of contracts.

NOTE: The indicator for this parameter provides how well the SP has performed in complete and correct technical upgrade at the first attempt.

5.5.6.1.1 Explanation on Parameter Definition

Upgrades should be carried out successfully first time it is attempted. Various causes could contribute towards successive attempts to fulfil the upgrade, e.g. organisational ineffectiveness, lack of resources, etc.

Due to upgrade procedures, the properties of an already deployed service are changed. To assure that the upgrades in the service are carried out completely AND correctly in the first attempt, this parameter reflects the ratio of erroneous procedures in relation to all technical upgrade procedures within a specified observation period.

5.5.6.2 Equation

$$P506 [\%] = \frac{\sum N_I}{\sum N_S} \times 100\%$$

with $N_I = \begin{cases} 1, & \text{if first time upgrade is not complete or not correct} \\ 0, & \text{else} \end{cases}$

and $N_S = \begin{cases} 1, & \text{if upgrade is done} \\ 0, & \text{else} \end{cases}$

where:

$\sum N_I$	Number of upgrade events which are either incomplete or not correct in the first try
$\sum N_S$	Number of upgrade events

All measures are related to the reporting period.

5.5.6.3 Measure

The parameter is expressed as a percentage.

5.5.7 P507: Conformity and success of technical upgrade [%]

5.5.7.1 Definition of Parameter

The parameter "conformity and success rate of technical upgrade" is expressed as the ratio (percentage) of technical upgrade not according to specification and therefore requiring reworking or further service upgrade processes and resources to get it right to the total number of contracts upgraded.

5.5.7.1.1 Explanation on Parameter Definition

This parameter is a higher aggregation of the parameters:

- Rate of successful upgrade within specified period (P502).
- Completeness of fulfilment of the technical upgrade stage (P503).

The parameter shows a positive outcome only if an upgrade has been done completely and in-time. If one of these conditions is not achieved, the parameter will have a negative outcome.

5.5.7.2 Equation

$$P507 [\%] = P502 [\%] \times P503 [\%]$$

5.5.7.3 Measure

The parameter is expressed as a percentage.

5.5.8 P508: Technical reliability of service within an agreed period after technical upgrade [%]

5.5.8.1 Definition of Parameter

The parameter "technical reliability of service within an agreed period after technical upgrade" is expressed as the ratio (percentage) of the upgrades that perform satisfactorily for a specified period after the upgrade to the total number of upgrades carried out.

5.5.8.1.1 Explanation on Parameter Definition

A service with technical upgrades carried out is expected to function satisfactorily with all its features for a specified period of time T_{52} as an expression of the reliability of the upgrade process.

Technical upgrade in an existing service setup may lead to an increased instability. This parameter makes this potential risk transparent by assessing an observation period after the upgrade event. This observation period should not show any service restrictions or limitations related to the customer's service usage.

Only successful reliability phases are considered. This means that there should not any service restrictions be observable after the upgrade took place.

One precondition for the calculation of this parameter is that the upgrade has been carried out completely (successful outcome of the parameter "Completeness of fulfilment"). For incomplete upgrades, the calculation of this parameter has no meaning.

Furthermore, the outage period which is related to the SP work has to be passed before the reliability period begins.

5.5.8.2 Equation

$$P508 [\%] = \frac{\sum N_R}{\sum N_S} \times 100\%$$

with $N_R = \begin{cases} 1, & \text{if no usage restrictions were observed in the reliability period} \\ 0, & \text{else} \end{cases}$

and $N_S = \begin{cases} 1, & \text{if upgrade is done} \\ 0, & \text{else} \end{cases}$

where:

$\sum N_R$	Number of upgrade events with are followed by an unrestricted reliability period
$\sum N_S$	Number of upgrade events

All measures are related to the reporting period.

Precondition:

- Upgrade already carried out.

5.5.8.3 Measure

The parameter is expressed as a percentage.

5.5.9 P509: Overall quality of the technical upgrade process [OR]

P509 Assessment of the overall quality of the technical upgrade process by a representative user panel

Reference: Quality of customer relations; EG 202 009-2 [i.2], ES 202 057-1 [i.3].

5.5.10 P510: Provider ability to match the customer's wishes for conditions of achievement [OR]

P510 Assessment of the provider ability to match the customer's wishes by a representative user panel

Reference: Quality of customer relations; EG 202 009-2 [i.2], ES 202 057-1 [i.3].

5.5.11 P511: User friendliness of the means available to the customer for the operations he has to perform [OR]

P511 Assessment of the user friendliness of the technical upgrade process by a representative user panel

Reference: Quality of customer relations; EG 202 009-2 [i.2], ES 202 057-1 [i.3].

The following parameters are SP oriented.

5.5.12 P512: Organisational efficiency of SP to carry out technical upgrade (SPO) [OR]

5.5.12.1 Definition of Parameter

The parameter "organisational efficiency of a SP to carry out technical upgrade" is described and measured by the organisational and hardware resource availability on the part of the SP to carry out technical upgrades to meet the needs of the customer and/or to meet contractual promises.

5.5.12.1.1 Explanation on Parameter Definition

The SP requires organisational and hardware resources to carry out the upgrades. Shortcomings in this area could lie in shortage of staff, lack of training, shortage of hardware and logistical issues. This parameter is a measure of the efficiency of the provider in addressing these issues and providing adequate resources to satisfy customer's needs.

5.5.12.2 Equation

$$P512[OR] = \frac{\sum_{i=1}^N OR_i}{N}$$

where OR is the mean opinion rating, with OR_i ($i = 1 \dots N$) being the individual opinion ratings for the N members of the audit panel.

i	Index of expert
N	Number of experts in the panel

5.5.12.3 Measure

Opinion rating [OR] as defined in clause 4.1.

5.5.13 P513: Competence and preparedness of SP for technical upgrade (SPO) [OR]

5.5.13.1 Definition of Parameter

The parameter "competence and preparedness of a SP to carry out technical upgrade" is described and measured by its degree of ability (competence) and willingness (preparedness) to incorporate technical upgrade relevant to the service for the benefit of users.

5.5.13.1.1 Explanation on Parameter Definition

Technology is always on an evolutionary course. Some of the developments could profitably be used to improve the benefits and quality of the services for the benefit of the user. This parameter is a measure of the ability or competence of the SP to implement these technology developments and their willingness or preparedness to implement these enhancements in their services.

The parameter can be calculated each time an upcoming technology is available for implementation.

5.5.13.2 Equation

$$P513 [OR] = \frac{OR(C) + OR(W)}{2}$$

with

$OR(C)$	Opinion Rating for competence of SP to deploy upcoming technology developments
$OR(W)$	Opinion Rating for willingness of SP to deploy upcoming technology developments

5.5.13.3 Measure

Opinion rating [OR] as defined in clause 4.1.

5.6 Customer Relationship Stage: Service Support

The service support stage comprises four categories of parameters, documentation, technical support, commercial support and complaint management leading to a presentation differing slightly from other customer relationship stages. This differing categorisation does not mean that these QoS parameters are less important than the others.

5.6.1 Documentation

Provision of Documentation is an essential part of any telecommunication service. The constituent parts of a document accompanying a service are security measure, setting up procedures, operating instructions, trouble shooting, call and help line contact information etc. Once issued documentation needs updating whenever a significant change in the operation of the service takes place or when amendment to existing information is required.

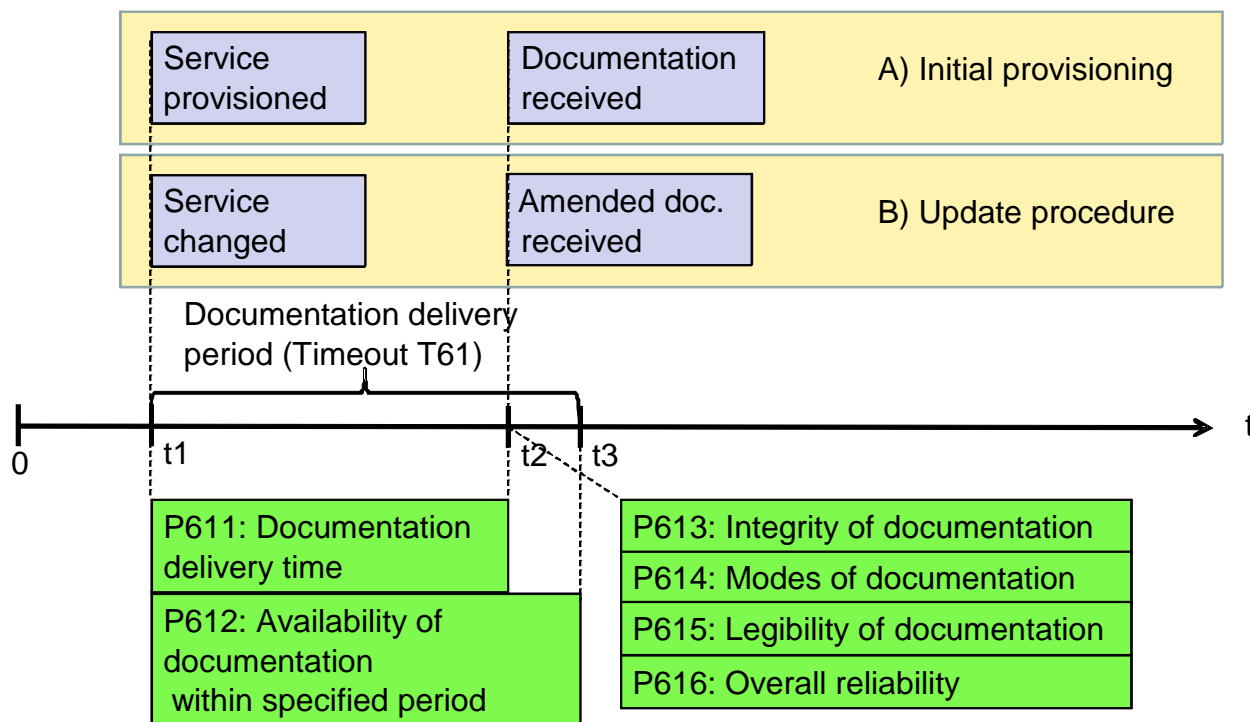

Figure 15: Events and parameters for provision of documentation

The user oriented parameters identified for this stage are:

- P611: Documentation delivery time [Time]
- P612: Availability of documentation within specified period of time [%]
- P613: Integrity (correctness and completeness) of documentation [OR]
- P614: Modes of documentation [Number]
- P615: Legibility of documentation [OR]
- P616: Overall reliability of documentation services [OR]

5.6.1.1 P611: Documentation delivery time [Time]

5.6.1.1.1 Definition of Parameter

The parameter "documentation delivery time" is expressed as the time taken from the instant a service is provided to the instant documentation for the commissioning and use of the service is delivered to the customer.

NOTE: Documentation not delivered before time t3 (figure 15) will be considered as not delivered in time.

5.6.1.1.1.1 Explanation on Parameter Definition

The documentation would normally be delivered together with the service hardware or service commissioning.

5.6.1.1.2 Equation

$$P611 \text{ [Time]} = \frac{\sum_{i=1}^N (t_{2,i} - t_{1,i})}{N}$$

where

N	Number of documentation delivery events
i	Index of each documentation delivery event
$t_{1,i}$	Point of time when service portfolio change event i occurs
$t_{2,i}$	Point of time when documentation delivery event i actually occurs

5.6.1.1.3 Measure

The indicator may be expressed in units of time depending upon the mode of delivery of the documentation. The units of time may be expressed in seconds, minutes, hours or days as appropriate.

5.6.1.2 P612: Availability of documentation within specified period of time [%]

5.6.1.2.1 Definition of Parameter

The parameter "availability of documentation within a specified period of time" is expressed as the ratio (percentage) of the number of contracts where documentation was supplied within a specified period of time to the total number of contracts where documentation was expected.

5.6.1.2.1.1 Explanation on Parameter Definition

This parameter provides an indication on whether or not the SP provides the documentation, associated with a service, to make full use of its features within a specified period.

Ideally the documentation ought to be supplied with the commissioning or the hardware supply. The time difference between t_1 and t_3 in the timeline diagram should be zero. However it may be necessary for practical reasons for a small delay to be associated between supply and availability of a service. The acceptable delay could be specified by stakeholders e.g., regulator or any other national institution. Availability would then be dependent upon supply of documentation during this period.

Not providing documentation at the appropriate time would be regarded as lack of good organisational efficiency on the part of the SP.

5.6.1.2.2 Equation

$$P612 [\%] = \frac{\sum N_D}{\sum N_C} \times 100\%$$

with

$$N_D = \begin{cases} 1 & \text{if } t_D \leq T_{61} \\ 0 & \text{if } t_D > T_{61} \end{cases}$$

and

$$N_C = \begin{cases} 1, & \text{if service portfolio is changed} \\ 0, & \text{else} \end{cases}$$

and

$$0 \leq t_c \leq t_D \leq t_c + T_{61}$$

where

$\sum N_D$	Number of documentation delivery events within time period T_{61} after t_c
$\sum N_C$	Number of changes in service portfolio
t_D	Point of time when expected period for documentation delivery expires (t_3 in figure 15)
t_c	Point of time when service portfolio is changed (t_1 in figure 15)
T_{61}	Maximum expected time for documentation delivery, timeout (t_3 in figure 15)

All measures are related to the reporting period.

5.6.1.2.3 Measure

This parameter is expressed as a percentage.

5.6.1.3 P613: Integrity (correctness and completeness) of documentation [OR]

5.6.1.3.1 Definition of Parameter

The parameter "integrity of documentation" is described and measured by the correctness, completeness and user friendliness of pertinent information associated with the use of all features of a service and its maintenance.

5.6.1.3.1.1 Explanation on Parameter Definition

Integrity of documentation has three main components, correctness, completeness and user friendliness. The following topics are normally included in the documentation:

- 1) safety instructions;
- 2) installation instructions, where these are applicable;
- 3) relevant operating procedures for full use of all service features;
- 4) trouble shooting procedures;
- 5) contact information for help;
- 6) service release number;
- 7) documentation revision number and date.

Any other service specific information would also be expected to be included.

Where new information is gathered for the documentation, based on experience, these could be added to the original or previous edition of documentation together with the revision date.

5.6.1.3.2 Equation

Opinion rating scores expressed as mean with the standard deviation.

$$P613[OR] = \frac{\sum_{i=1}^N OR_i}{N}$$

where OR is the mean opinion rating, with OR_i ($i = 1 \dots N$) being the individual opinion ratings for the N members of the audit panel.

i	Index of expert
N	Number of experts in the panel

5.6.1.3.3 Measure

Opinion rating [OR] as defined in clause 4.1.

5.6.1.4 P614: Modes of documentation [Number]

5.6.1.4.1 Definition of Parameter

The parameter "modes of documentation" is expressed as the number of modes in which documentation is made available to the customer or user of a service.

5.6.1.4.1.1 Explanation on Parameter Definition

There could be a number of ways in which documentation for a service or application is made available to the customer. Examples are: hard copy (paper copies perhaps bound), voice, electronic files downloadable at request, web based files, video files either downloadable or on disks etc. Documentation should also include updates available whenever these are published.

The SP would normally keep a list of modes in which documentation is made available to the customer.

5.6.1.4.2 Equation

$$P614 = \sum_{i=1}^N m_i$$

with

$$m_i = \begin{cases} 1, & \text{if mode } i \text{ is available} \\ 0, & \text{if mode } i \text{ is not available} \end{cases}$$

where

N	Number of potentially available modes of documentation
i	Index of each documentation mode
$\sum m_i$	Number of actually available documentation modes

5.6.1.4.3 Measure

Number of modes in which documentation is available to the customer or the user.

5.6.1.5 P615: Legibility of documentation [OR]

5.6.1.5.1 Definition of Parameter

The parameter "Legibility of documentation" is characterised by visual clarity, language, understandability and layout of the information in the medium in which it is presented.

5.6.1.5.1.1 Explanation on Parameter Definition

Visual clarity would be influenced by font size, contrast of the text and background colours. Diagrams should be clearly drawn and all key points referenced. Images should be clear and illustrate unambiguously the message these are intended to be conveyed.

Usage of standard language would minimise misinterpretations and ambiguity and therefore contribute towards legibility and hence better comprehension of the information. Where translations are used the grammar and meaning should be true to the original.

The layout ought to be pleasing and welcoming to the eye in order to make assimilation of the information easier. Layout could be different on different modes for optimum benefit to the customer. For specific customer segments and for those with special needs the documentation should be produced in an appropriate way e.g. for visually disabled, documentation could be made in large letters or in Braille.

5.6.1.5.2 Equation

$$P615[OR] = \frac{\sum_{i=1}^N OR_i}{N}$$

where OR is the mean opinion rating, with OR_i ($i = 1 \dots N$) being the individual opinion ratings for the N members of the audit panel.

i	Index of expert
N	Number of experts in the panel

5.6.1.5.3 Measure

Opinion rating [OR] as defined in clause 4.1.

5.6.1.6 P616: Overall reliability of documentation services [OR]

5.6.1.6.1 Definition of Parameter

The parameter "overall reliability of the documentation services" is characterised by consistent availability, integrity, speed of provisioning of the documentation and associated support activities provided by the SP for a given service.

5.6.1.6.1.1 Explanation on Parameter Definition

This parameter expresses the combined effects of availability, integrity, speed of provision of documentation and the quality of support activities over the reporting period. Consistency of performances of the combined effect of the above criteria will be judged in the 'overall reliability' of the documentation services.

5.6.1.6.2 Equation

$$P616[OR] = \frac{\sum_{i=1}^N OR_i}{N}$$

where OR is the mean opinion rating, with OR_i ($i = 1 \dots N$) being the individual opinion ratings for the N members of the audit panel.

i Index of expert
 N Number of experts in the panel

5.6.1.6.3 Measure

Opinion rating [OR] as defined in clause 4.1.

5.6.2 Technical support

Technical support is a necessary function to be provided by the SP. This is particularly important in view of the highly technological nature of IT Services and this clause identifies the pertinent parameters to measure the performance of this function.

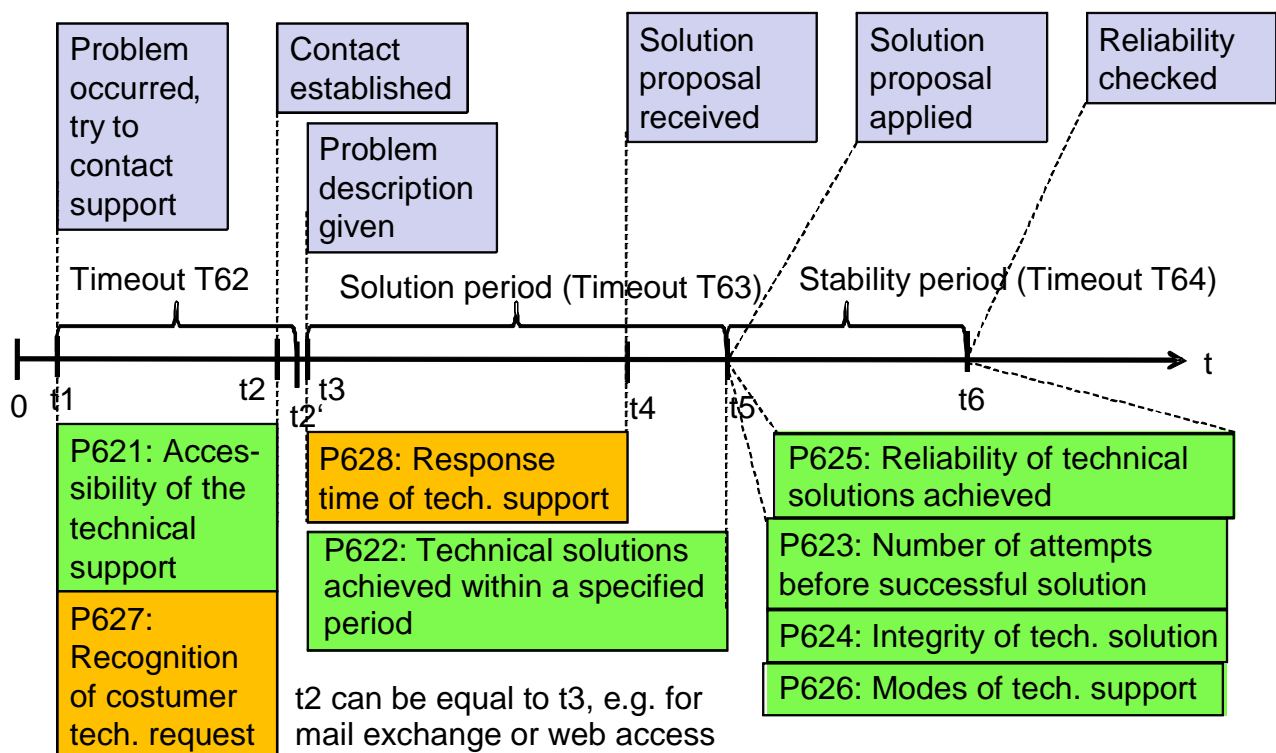

Figure 16: Events and parameters for Technical support

The user oriented parameters identified for this stage are:

- P621: Accessibility of the technical support [%]
- P622: Technical solutions achieved within a specified period [%]
- P623: Number of attempts before successful solution [Number]
- P624: Integrity of technical solutions [OR]
- P625: Reliability of technical solutions achieved [%]
- P626: Modes of technical support [Number]
- P627: Recognition of the customer technical request [%]
- P628: Response time of the technical support [Time & %]
- P629: Request to technical support resolution time [Time & %]
- P630: Number of customer requests to technical support [Number]
- P631: User friendliness of the technical support [OR]

5.6.2.1 P621: Accessibility of the technical support [%]

5.6.2.1.1 Definition of Parameter

The parameter "accessibility of technical support" is expressed as the ratio of the number of successful attempts to technical support to the total number of attempts to reach this support.

5.6.2.1.1.1 Explanation on Parameter Definition

This parameter reflects the accessibility rate of the customer to the technical support of SP in a specified time interval.

5.6.2.1.2 Equation

$$P621 [\%] = \frac{\sum N_R}{\sum N_S} \times 100\%$$

with $N_R = \begin{cases} 1, & \text{if event of access to technical support is successful} \\ 0, & \text{else} \end{cases}$

and $N_S = \begin{cases} 1, & \text{if access event to technical support is started} \\ 0, & \text{else} \end{cases}$

where

$\sum N_R$ Number of successful access events to technical support
 $\sum N_S$ Number of started access events to technical support

All measures are related to the reporting period.

5.6.2.1.3 Measure

The indicator is expressed as percentage.

5.6.2.2 P622: Technical solutions achieved within a specified period [%]

5.6.2.2.1 Definition of Parameter

The parameter "Technical solutions achieved within a specified period" is expressed as the ratio (percentage) of the number of contracts with successful technical solutions applied, to the total number of contracts where solutions were sought and applied within the specified period.

5.6.2.2.1.1 Explanation on Parameter Definition

This parameter reflects the rate of resolved solutions the customers get from the technical support of SP within the specified period T_{63} .

5.6.2.2.2 Equation

$$P622 [\%] = \frac{\sum N_R}{\sum N_S} \times 100\%$$

with $N_R = \begin{cases} 1, & \text{if solution proposal has been applied successfully} \\ 0, & \text{else} \end{cases}$

and $N_S = \begin{cases} 1, & \text{if problem description is given to SP} \\ 0, & \text{else} \end{cases}$

where

$\sum N_R$	Number of resolved problems due to successful application of solution proposal
$\sum N_S$	Number of valid problems addressed to technical support

All measures are related to the reporting period.

5.6.2.2.3 Measure

The indicator is expressed as percentage.

5.6.2.3 P623: Number of attempts before successful solution [Number]

5.6.2.3.1 Definition of Parameter

The parameter "number of attempts before successful solution" is expressed as the number of attempts before the technical request was successfully solved.

5.6.2.3.1.1 Explanation on Parameter Definition

This parameter reflects the number of attempts the customer has had to call upon the technical support of SP to solve his request. There would be a specified maximum number of attempts. Solution of the request after reaching this number of attempts will not be counted as a solution that has been fulfilled for the purposes of this parameter.

The maximum number of attempts should be fixed for each service by stakeholders e.g. the regulator or a national institution that has responsibility for monitoring the QoS of telecommunication services.

5.6.2.3.2 Equation

$$P623 [\text{Number}] = \sum_{i=1} m_i$$

with $m_i = \begin{cases} 1, & \text{if attempt } i \text{ is not successful} \\ 0, & \text{if attempt } i \text{ is successful} \end{cases}$

where

i	Index of each attempts
m	Attempt actually made to resolve problem

5.6.2.3.3 Measure

This indicator should be expressed as number.

5.6.2.4 P624: Integrity of technical solutions [OR]

5.6.2.4.1 Definition of Parameter

The parameter "integrity of technical solution" provided by the SP is expressed by the proportion of successful solutions with respect to the total number of requests within a specified period of time.

5.6.2.4.1.1 Explanation on Parameter Definition

This parameter reflects the rate of (successfully) solved requests after the request to the technical support was accepted by the SP, in relation to all requests within the specified observation period.

5.6.2.4.2 Equation

$$P624[OR] = \frac{\sum_{i=1}^N OR_i}{N}$$

where OR is the mean opinion rating, with OR_i ($i = 1 \dots N$) being the individual opinion ratings for the N members of the audit panel.

i	Index of expert/customer
N	Number of experts/customers in the panel

5.6.2.4.3 Measure

Opinion rating [OR] as defined in clause 4.1.

5.6.2.5 P625: Reliability of technical solutions achieved [%]

5.6.2.5.1 Definition of Parameter

The parameter "reliability of the technical solution achieved" is expressed as the ratio (percentage) of the number of services that were trouble-free for a specified period of time after the technical solution was achieved to the total number of services where the technical support was requested and implemented.

5.6.2.5.1.1 Explanation on Parameter Definition

After the successful solution of a customer's request for technical support was achieved, the service is expected to function satisfactorily with all its features for a specified period of time T_{64} as an expression of the reliability.

Changes in an existing service setup after the resolution of a customer's request for technical support may lead to an increased instability. This parameter makes this potential risk transparent by assessing an observation period after the resolution event. This observation period T_{64} should not show any service restrictions or limitations related to the customer's service usage.

Only successful reliability phases are considered. This means that there should not any service restrictions be observable after the resolution took place.

One precondition for the calculation of this parameter is that the customer's request for technical support has been resolved completely. Furthermore, a possible outage period which is related to the SP work has to pass before the reliability period begins.

5.6.2.5.2 Equation

$$P625 [\%] = \frac{\sum N_R}{\sum N_S} \times 100\%$$

with $N_R = \begin{cases} 1, & \text{if no usage restriction was observed in reliability period} \\ 0, & \text{else} \end{cases}$

and $N_S = \begin{cases} 1, & \text{if customer complaint is resolved successfully} \\ 0, & \text{else} \end{cases}$

where

$\sum N_R$	Number of resolved customer's request for technical support events with are followed by an unrestricted reliability period
$\sum N_S$	Number of resolved customer's request for technical support events

All measures are related to the reporting period.

Precondition:

- Customer's request for technical support event resolved satisfactorily.

5.6.2.5.3 Measure

The parameter is expressed as a percentage.

5.6.2.6 P626: Modes of technical support [Number]

5.6.2.6.1 Definition of Parameter

The parameter "modes of technical support" is expressed as the number of modes in which technical support is available to the customer or user of a service.

5.6.2.6.1.1 Explanation on Parameter Definition

There could be a number of ways in which technical support for a service or application is made available to the customer. Examples are: hard copy (paper copies perhaps bound), voice, electronic files downloadable at request, web based files, video files either downloadable or on disks, etc.

5.6.2.6.2 Equation

$$P626[\text{Number}] = \sum_{i=1}^N m_i$$

with $m_i = \begin{cases} 1, & \text{if mode } i \text{ is available} \\ 0, & \text{if mode } i \text{ is not available} \end{cases}$

where

N	Number of potentially available modes of technical support
i	Index of each technical support mode
$\sum m_i$	Number of actually available technical support modes

5.6.2.6.3 Measure

Number of modes in which technical support is available to the customer or the user. The indicator is expressed as number value.

5.6.2.7 P627: Recognition of the customer technical request [%]

Exhaustiveness and clarity of the recognition of the customer request:

P627[%] Rate of call to the support due to an issue not solved after the first call.

Reference: P662: Recognition of the customer complaints [%].

5.6.2.8 P628: Response time of the technical support [Time & %]

Time elapsed between the end of dialling and reaching a technical operator. (The average of and variation in the time taken to establish a call).

P628a[Time] the times by which the fastest 50 %, 95 % and 99 % of calls reach an operator.
 P628b[%] the percentage of calls answered within 2 minutes. (Information from switchboard (PABX)).

Reference: Response time for admin/billing enquiries; EG 202 009-2 [i.2], ES 202 057-1 [i.3].

5.6.2.9 P629: Request to technical support resolution time [Time & %]

- P629a[Time] the time by which the fastest 80 % and 95 % of complaints have been resolved (expressed in clock hours); or
 P629b[%] the percentage of complaints resolved any time stated as an objective by the SP.

Reference: Customer complaints resolution time; EG 202 009-2 [i.2], ES 202 057-1 [i.3].

5.6.2.10 P630: Number of customer requests to technical support [Number]

- P630[Number] Number of customer requests to technical support logged per customer.

Reference: Number of customer complaints; EG 202 009-2 [i.2], ES 202 057-1 [i.3].

5.6.2.11 P631: User friendliness of the technical support [OR]

- P631[OR] Assessment of the assurance, empathy and responsiveness of the technical support operators by a representative user panel.

Reference: Quality of customer relations; EG 202 009-2 [i.2], ES 202 057-1 [i.3].

5.6.3 Commercial support

Commercial support for customers of a SP dealing with IT services is another necessary function that needs to be evaluated for its performance. This clause identifies the performance parameters.

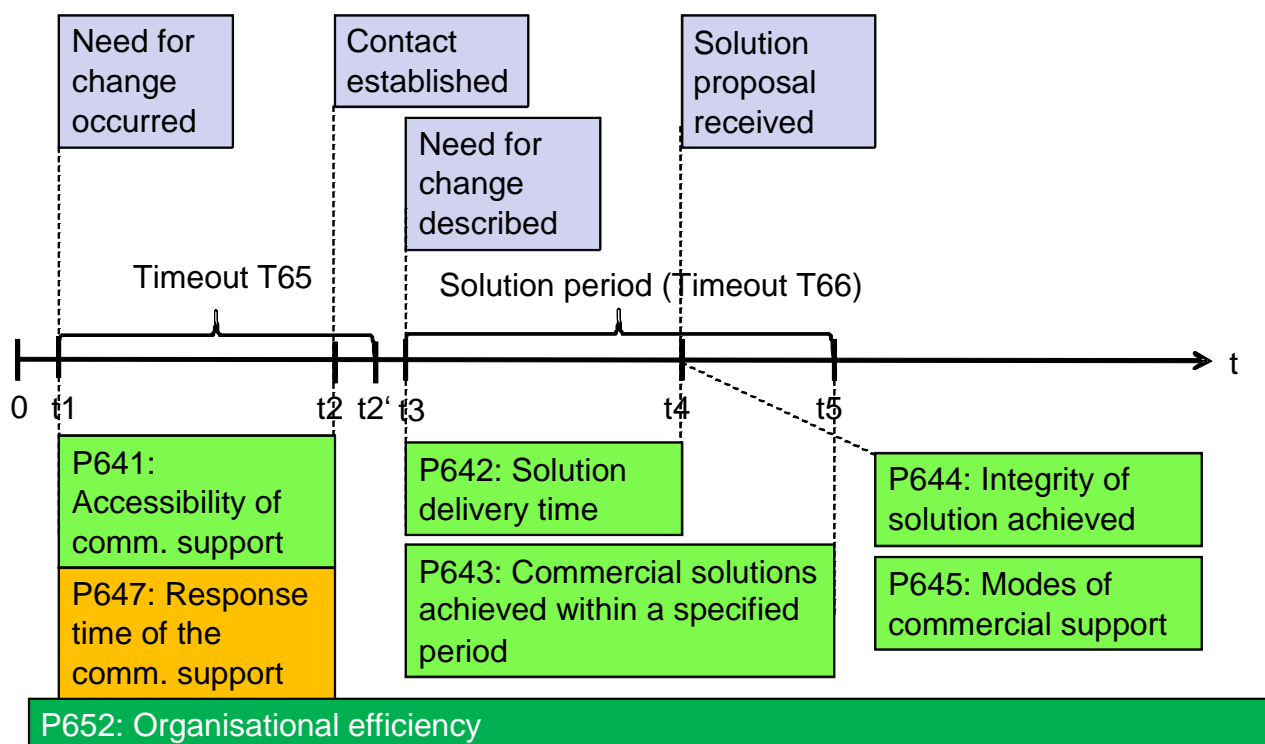

Figure 17: Events and parameters for commercial support

The user oriented parameters identified for this stage are:

- P641: Accessibility of the commercial support [%]
- P642: Commercial solution delivery time [Time]
- P643: Commercial solutions achieved within a specified period [%]
- P644: Integrity of solution achieved by the SP [OR]
- P645: Modes of commercial support [Number]
- P646: Recognition of the customer commercial request [%]
- P647: Response time of the commercial support [Time & %]
- P648: Request to commercial support resolution time [Time & %]
- P649: Number of customer requests to commercial support [Number]
- P650: Quality of the commercial support [OR]
- P651: User friendliness of the commercial support [OR]

One SP oriented parameter has been identified for this stage:

- P652: Organisational efficiency of commercial support (SPO) [OR].

5.6.3.1 P641: Accessibility of the commercial support [%]

5.6.3.1.1 Definition of Parameter

The parameter "accessibility of the commercial support" is expressed as the ratio of the number of successful access attempts to the commercial support to the total number of attempts to reach this support.

5.6.3.1.1.1 Explanation on Parameter Definition

This parameter reflects the accessibility rate of the customer to the commercial support of the SP in a specified time interval.

5.6.3.1.2 Equation

$$P641 [\%] = \frac{\sum N_R}{\sum N_S} \times 100\%$$

with $N_R = \begin{cases} 1, & \text{if event of access to commercial support is successful} \\ 0, & \text{else} \end{cases}$

and $N_S = \begin{cases} 1, & \text{if access event to commercial support is started} \\ 0, & \text{else} \end{cases}$

where

$\sum N_R$	Number of successful access events to commercial support
$\sum N_S$	Number of started access events to commercial support

5.6.3.1.3 Measure

The indicator is expressed as percentage.

5.6.3.2 P642: Commercial solution delivery time [Time]

5.6.3.2.1 Definition of Parameter

The parameter "commercial solution delivery time" is expressed as the time elapsed from the instant the customer raised a problem with commercial support to the instant a solution is achieved.

5.6.3.2.1.1 Explanation on Parameter Definition

This parameter reflects the time taken by the SP before the customer has his request solved.

5.6.3.2.2 Equation

$$P642 [\text{Time}] = \frac{\sum_{i=1}^N (t_{4,i} - t_{3,i})}{N}$$

where

N	Number of needs of change given to commercial support
i	Index of each need for change event
$t_{3,i}$	Point of time when need for change i is given to commercial support
$t_{4,i}$	Point of time when solution proposal i actually is received

5.6.3.2.3 Measure

The indicator is expressed in units of time expressed in minutes, hours or days as appropriate.

The timeout value T_{66} is required to prevent from unduly long waiting for the solution. Events that do not occur within the timeout period are counted as unsuccessful attempts which deliver no contribution to this parameter.

5.6.3.3 P643: Commercial solutions achieved within a specified period [%]

5.6.3.3.1 Definition of Parameter

The parameter "commercial solutions achieved within a specified period" is expressed as the ratio (percentage) of the number of contracts with successful commercial solutions achieved, to the total number of contracts where solutions were sought within a specified period.

5.6.3.3.1.1 Explanation on Parameter Definition

This parameter reflects the rate of solutions the commercial support of SP has provided within the specified period T_{66} .

There would be a time out set for a service. Solution of the request after the time out will not be counted as a solution that has been fulfilled for the purposes of this parameter.

The time out should be fixed for each service by stakeholders e.g. the regulator or a national institution that has responsibility for monitoring the QoS of telecommunication services.

5.6.3.3.2 Equation

$$P643 [\%] = \frac{\sum N_R}{\sum N_S} \times 100\%$$

with $N_R = \begin{cases} 1, & \text{if solution to commercial support request is delivered within predefined period} \\ 0, & \text{else} \end{cases}$

and $N_S = \begin{cases} 1, & \text{if comercial support request is accepted} \\ 0, & \text{else} \end{cases}$

where

$\sum N_R$	Number of solutions to commercial support request events
$\sum N_S$	Number of commercial support events

All measures are related to the reporting period.

5.6.3.3.3 Measure

The indicator is expressed as percentage.

5.6.3.4 P644: Integrity of solution achieved by the SP [OR]

5.6.3.4.1 Definition of Parameter

The parameter "integrity of the commercial solution achieved by the SP" is expressed as the ratio of successful solutions achieved within the specified period of time to the total number of commercial support requests.

5.6.3.4.1.1 Explanation on Parameter Definition

This parameter reflects the rate of (successfully) solved requests after the request was accepted by the SP in relation to all requests within the specified period.

5.6.3.4.2 Equation

$$P644[OR] = \frac{\sum_{i=1}^N OR_i}{N}$$

where OR is the mean opinion rating, with OR_i ($i = 1 \dots N$) being the individual opinion ratings for the N members of the audit panel.

i	Index of expert
N	Number of experts in the panel

5.6.3.4.3 Measure

Opinion rating [OR] as defined in clause 4.1.

5.6.3.5 P645: Modes of commercial support [Number]

5.6.3.5.1 Definition of Parameter

The parameter "modes of commercial support" is expressed as the number of modes in which commercial support is available to the customer or user of a service.

5.6.3.5.1.1 Explanation on Parameter Definition

There could be a number of ways in which commercial support for a service or application is made available to the customer. Examples are: hard copy (paper copies perhaps bound), voice, electronic files downloadable at request, web based files, video files either downloadable or on disks, etc.

5.6.3.5.2 Equation

$$P645 [\text{Number}] = \sum_{i=1}^N m_i$$

with $m_i = \begin{cases} 1, & \text{if mode } i \text{ is available} \\ 0, & \text{if mode } i \text{ is not available} \end{cases}$

where

N	Number of potentially available modes of commercial support
i	Index of each commercial support mode
$\sum m_i$	Number of actually available commercial support modes

5.6.3.5.3 Measure

Number of modes in which commercial support is available to the customer or the user. The indicator should be expressed as number.

5.6.3.6 P646: Recognition of the customer commercial request [%]

Exhaustiveness and clarity of the recognition of the customer request:

P646[%] Rate of call to the support due to an issue not solved after the first call.

Reference: P662: Recognition of the customer complaints [%].

5.6.3.7 P647: Response time of the commercial support [Time & %]

Time elapsed between the end of dialling and reaching a commercial operator:

P647a[Time] mean time to answer; and
P647b[%] percentage of calls answered within 20 seconds.

- a) Reference: Response time for admin/billing enquiries; EG 202 009-2 [i.2], ES 202 057-1 [i.3].
- b) Percentage of calls answered within 2 minutes (Information from switchboard (PABX)).

5.6.3.8 P648: Request to commercial support resolution time [Time & %]

P648a[Time] the time by which the fastest 80 % and 95 % of complaints have been resolved (expressed in clock hours); or
P648b[%] the percentage of complaints resolved any time stated as an objective by the SP.

Reference: Customer complaints resolution time; EG 202 009-2 [i.2], ES 202 057-1 [i.3].

5.6.3.9 P649: Number of customer requests to commercial support [Number]

P649[Number] Number of complaints logged per customer.

Reference: Number of customer complaints; EG 202 009-2 [i.2], ES 202 057-1 [i.3].

5.6.3.10 P650: Quality of the commercial support [OR]

P650[OR] Assessment of the overall quality of the commercial support by a representative user panel.

Reference: Quality of customer relations; EG 202 009-2 [i.2], ES 202 057-1 [i.3].

5.6.3.11 P651: User friendliness of the commercial support [OR]

P651[OR] Assessment of the commercial support dependability, assurance, empathy and responsiveness by a representative user panel.

Reference: Quality of customer relations; EG 202 009-2 [i.2], ES 202 057-1 [i.3].

The following parameter is SP oriented.

5.6.3.12 P652: Organisational efficiency of commercial support (SPO) [OR]

5.6.3.12.1 Definition of Parameter

The parameter "organisational efficiency of the commercial support" provided by the SP is described and measured by the organisational resource availability to fulfil customer needs.

5.6.3.12.1.1 Explanation on Parameter Definition

The SP requires organisational and hardware resources to carry out the commercial support management. Shortcomings in this area could lie in shortage of staff, lack of training, shortage of hardware and logistical issues. This parameter is a measure of the efficiency of the provider in addressing these issues and providing adequate resources to satisfy customer's needs.

5.6.3.12.2 Equation

$$P652[OR] = \frac{\sum_{i=1}^N OR_i}{N}$$

where OR is the mean opinion rating, with OR_i ($i = 1 \dots N$) being the individual opinion ratings for the N members of the audit panel.

i Index of expert
 N Number of experts in the panel

5.6.3.12.3 Measure

Opinion rating [OR] as defined in clause 4.1.

5.6.4 Complaint management

Complaint management is an essential function of any organisation irrespective of the discipline. Thus complaint management processes exist in the management of all industries including the telecommunications sector.

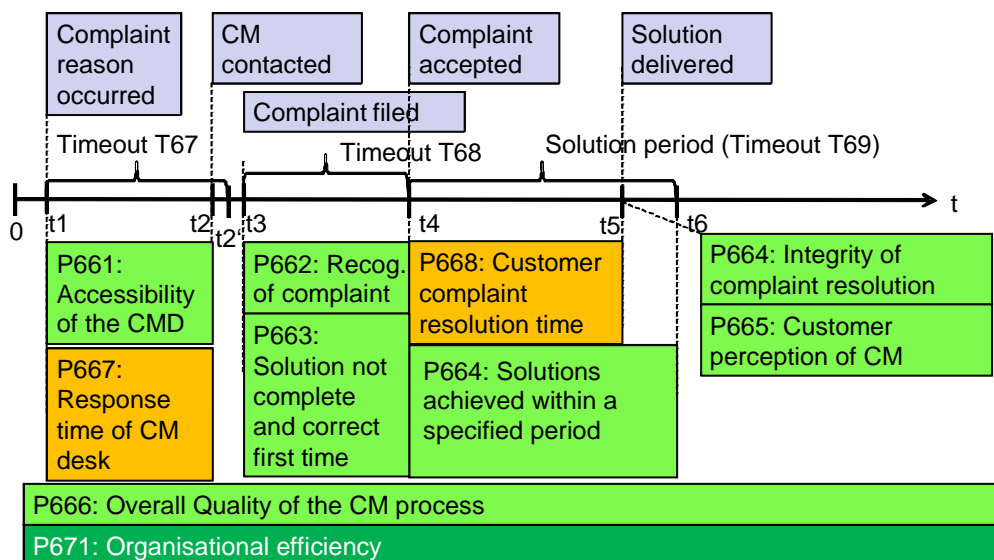

Figure 18: Events and parameters for complaint management

The user oriented parameters identified for this stage are:

- P661: Accessibility of the complaint management desk [%]
- P662: Recognition of the customer complaints [%]
- P663: Complaint solutions not complete and correct first time [%]
- P664: Integrity of complaint resolution [%]
- P665: Customer perception of the complaint management [OR]
- P666: Overall quality of the complaint management process [OR]
- P667: Response time of the complaint management desk [Time & %]
- P668: Customer complaints resolution time [Time & %]
- P669: Number of customer complaints of any kind [Number]
- P670: Professionalism of the complaint management desk [OR]

One SP oriented parameter has been identified for this stage:

- P671: Organisational efficiency of complaint management system (SPO) [OR]

5.6.4.1 P661: Accessibility of the complaint management desk [%]

5.6.4.1.1 Definition of Parameter

The parameter "accessibility of the complaint management desk" is expressed as the ratio of the number of successful attempts to the total number of attempts to reach this support in a specified period.

5.6.4.1.1.1 Explanation on Parameter Definition

This parameter reflects the accessibility rate of the customer to the complaint management desk of the SP in a specified time interval.

5.6.4.1.2 Equation

$$P661 [\%] = \frac{\sum N_R}{\sum N_S}$$

with $N_R = \begin{cases} 1, & \text{if event of access to complaint management desk is successful} \\ 0, & \text{else} \end{cases}$

and $N_S = \begin{cases} 1, & \text{if access event to complaint management desk is started} \\ 0, & \text{else} \end{cases}$

where

$\sum N_R$	Number of successful access events to complaint management desk
$\sum N_S$	Number of started access events to complaint management desk

5.6.4.1.3 Measure

The indicator is expressed as percentage.

5.6.4.2 P662: Recognition of the customer complaints [%]

5.6.4.2.1 Definition of Parameter

The parameter "recognition of the customer complaints" is expressed as the ratio (percentage) of the customer claims recognised by the SP as complaints to the total number of claims made as potential complaints.

5.6.4.2.1.1 Explanation on Parameter Definition

This parameter reflects the rate of recognized customer claims to the complaint management desk.

5.6.4.2.2 Equation

$$P662 [\%] = \frac{\sum N_R}{\sum N_S} \times 100\%$$

with $N_R = \begin{cases} 1, & \text{if customer claim is recognized by the SP} \\ 0, & \text{else} \end{cases}$

and $N_S = \begin{cases} 1, & \text{if customer claim is reported} \\ 0, & \text{else} \end{cases}$

where

$\sum N_R$	Number of recognized customer claim events
$\sum N_S$	Number of customer claim events

All measures are related to the reporting period.

5.6.4.2.3 Measure

The indicator is expressed as percentage.

5.6.4.3 P663: Complaint solutions not complete and correct first time [%]

5.6.4.3.1 Definition of Parameter

The parameter "complaint solutions not complete or not correct first time" is expressed as the ratio (percentage) of the number of complaints which were not successfully resolved at the first attempt to the total number of complaints received by the SP.

NOTE: The indicator for this parameter provides how well the SP has performed in complete and correct handling the customer complaint at the first attempt.

5.6.4.3.1.1 Explanation on Parameter Definition

To ensure that the complaint management is handled completely AND correctly already in the first approach, this parameter reflects the ratio of erroneous procedures in relation to all service customer complaint procedures within a specified observation period.

The parameter reflects the percentage of erroneous customer complaints procedures. Further attempts of correction of completion are not taken into account.

5.6.4.3.2 Equation

$$P663 [\%] = \frac{\sum N_I}{\sum N_S}$$

with $N_I = \begin{cases} 1, & \text{if first time resolution is not complete or not correct} \\ 0, & \text{else} \end{cases}$

and $N_S = \begin{cases} 1, & \text{if customer complaint is resolved} \\ 0, & \text{else} \end{cases}$

where

$\sum N_I$ Number of customer complaint events which are either incomplete or not correct in the first attempt
 $\sum N_S$ Number of customer complaint events

All measures are related to the reporting period.

5.6.4.3.3 Measure

The indicator is expressed as percentage.

5.6.4.4 P664: Integrity of complaint resolution [%]

5.6.4.4.1 Definition of Parameter

The parameter "integrity of complaint resolution" service is expressed as the ratio (percentage) of the number of complete and professional resolution of the contributory causes of a complaint to the total number of accepted user complaints accepted.

5.6.4.4.1.1 Explanation on Parameter Definition

When the user's complaints have been accepted by the SP, this parameter reflects the rate of successfully solved complaint in relation to all complaints accepted. Complaints will be expected to be resolved within a timeout period.

5.6.4.4.2 Equation

$$P664 [\%] = \frac{N_R}{N_S} \times 100\%$$

where

N_R Number of successful solutions provided by SP within specified period
 N_S Number of accepted user complaints received

5.6.4.4.3 Measure

The indicator may be expressed as percentage.

5.6.4.5 P665: Customer perception of the complaint management [OR]

5.6.4.5.1 Definition of Parameter

The parameter "Customer perception of the complaint management" is characterised by the exhibition by the SP of combination of Assurance, Empathy and Responsiveness in dealing with the complaints from its reporting to its satisfactory resolution.

5.6.4.5.1.1 Explanation on Parameter Definition

The three constituent components may be further elaborated as follows.

Assurance has the characteristics of:

- Competence: skills required to deal with the substance of the complaint.
- Courtesy: friendliness, respect, and politeness shown to the complainant.
- Credibility: confidence in the SP usually associated with its professionalism.
- Trust: how well the customer believes the SP.

Empathy has the characteristics of:

- Ease of contact with the SP: it is necessary for customers to feel that the SP is approachable to make complaints.
- Market awareness: the SP should have an intimate knowledge of the market, its culture and the customers in order to relate to them in the most meaningful way - an essential requirement to be able to handle complains with least frustration to both sides.
- Listening to customer: it is necessary for the SP to listen to the customer in order to understand precisely the substance of the complaint. This requires intimate knowledge of the customer.
- Relating to customers: it is necessary for the SP to relate to the customer both before and after the complaint has been processed in order to retain the loyalty.

Responsiveness has the characteristics of:

- Willingness on the part of the SP to ascertain an objective assessment of the complaint.
- Where prompt action is required, putting to practice the steps as soon as practical.
- Where action to resolve can only be taken in the future, to estimate a realistic time frame and indicate this to the customer.
- A follow up contact after the resolution is completed to ensure that the complainant is happy with the outcome.

5.6.4.5.2 Equation

$$P665 [OR] = \frac{\sum_i OR_i(A) \times p\%}{N} + \frac{\sum_i OR_i(E) \times q\%}{N} + \frac{\sum_i OR_i(R) \times r\%}{N}$$

where

i	Index of expert
N	Number of experts in the panel
p, q, r	Weighting factors (defined by stakeholders)
A	Opinion rating for assurance
E	Opinion rating for empathy
R	Opinion rating for responsiveness

5.6.4.5.3 Measure

Opinion rating [OR] as defined in clause 4.1.

5.6.4.6 P666: Overall quality of the complaint management process [OR]

5.6.4.6.1 Definition of Parameter

The parameter "overall quality of the complaint management process" of a SP is characterised by the combined effect of accessibility of the CM service, correct solutions at the first attempt, speed of resolution and the organisational capability to carry out these.

5.6.4.6.1.1 Explanation on Parameter Definition

The Overall reliability of a SP to complaint resolution may be elaborated by the following:

- The CM service ought to be available whenever the customer needs to access it.
- The solutions to the complaints ought to be correct right first time.
- The speed of implementing the solutions ought to be as high as possible.
- The SP ought to deploy sufficient resources to carry out the above.

The combined effect of the above criteria on a consistent basis over a specified period of time would constitute the overall reliability of the CM service of a SP.

5.6.4.6.2 Equation

$$P666[OR] = \frac{\sum_{i=1}^N OR_i}{N}$$

where OR is the mean opinion rating, with OR_i ($i = 1 \dots N$) being the individual opinion ratings for the N members of the audit panel.

i	Index of expert
N	Number of experts in the panel

5.6.4.6.3 Measure

Opinion rating [OR] as defined in clause 4.1.

5.6.4.7 P667: Response time of the complaint management desk [Time & %]

Time elapsed between the end of dialling and reaching an operator to complaint management:

P667a[Time] mean time to answer; and
 P667b[%] the percentage of calls answered within 20 seconds.

Reference: Response time for admin/billing enquiries; EG 202 009-2 [i.2], ES 202 057-1 [i.3].

P667c[%] percentage of calls answered within 2 minutes (Information from switchboard (PABX)).

5.6.4.8 P668: Customer complaints resolution time [Time & %]

P668a[Time] the time by which the fastest 80 % and 95 % of complaints have been resolved (expressed in clock hours); or

P668b[%] the percentage of complaints resolved any time stated as an objective by the SP.

Reference: Customer complaints resolution time; EG 202 009-2 [i.2], ES 202 057-1 [i.3].

5.6.4.9 P669: Number of customer complaints of any kind [Number]

P669[Number] Number of complaints logged per customer.

Reference: Number of customer complaints; EG 202 009-2 [i.2], ES 202 057-1 [i.3].

5.6.4.10 P670: Professionalism of the complaint management desk [OR]

P670[OR] Assessment of the professionalism of the complaint management desk by a representative user panel.

Reference: Professionalism of help line; EG 202 009-2 [i.2], ES 202 057-1 [i.3].

The following parameter is SP oriented.

5.6.4.11 P671: Organisational efficiency of complaint management system (SPO) [OR]

5.6.4.11.1 Definition of Parameter

The parameter "organisational efficiency of the complaint management system" is characterised by the availability and deployment of organisational and hardware resources on the part of the SP to resolve user's complaints.

5.6.4.11.1.1 Explanation on Parameter Definition

The SP requires organisational and hardware resources to resolve user's complaints. Shortcomings in this area could lie in shortage of staff, lack of training, shortage of hardware and logistical issues.

This parameter is intended to be a measure of the efficiency of the provider in addressing these issues and providing adequate resources to satisfy customer's needs. Parameters 668, 669 and 671 contribute towards the performance of this parameter.

5.6.4.11.2 Equation

$$P671[OR] = \frac{\sum_{i=1}^N OR_i}{N}$$

where OR is the mean opinion rating, with OR_i ($i = 1 \dots N$) being the individual opinion ratings for the N members of the audit panel.

i Index of expert
 N Number of experts in the panel

5.6.4.11.3 Measure

Opinion rating [OR] as defined in clause 4.1.

5.7 Customer Relationship Stage: Repair services

Repair services is a necessary function in the management of a SP. Due to the technological nature of the IT services the repair services ought to be efficient and easily accessible to the customer. This clause identifies the parameters for assessing the performance of the SP for this functionality.

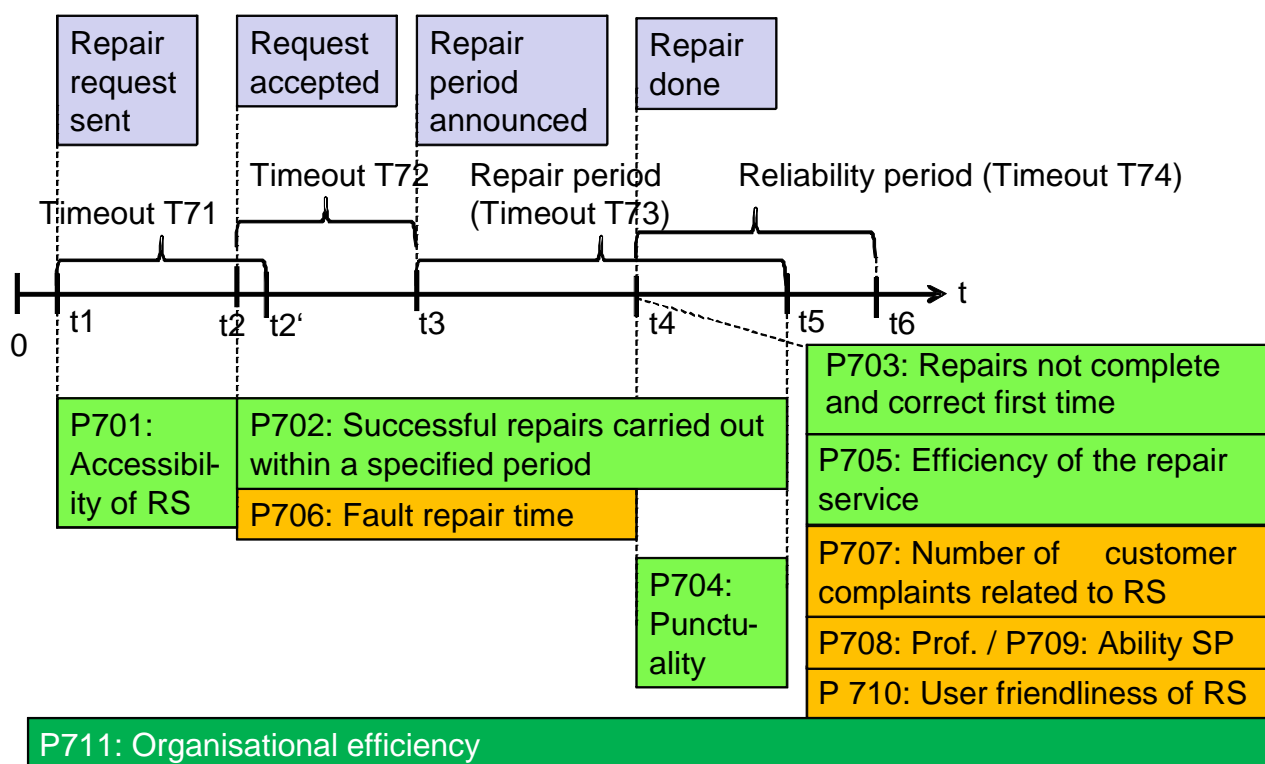

Figure 19: Events and parameters for Repair services

Repair services are an essential part in the life-cycle of any telecommunications service. Despite progress in technology and increase in reliability of the network, faults still occur and repairs are essential to ensure continued full use of services. Data from SP are needed (at least to identify the customers for the panel).

The time line figure above shows the key time outs.

The user oriented parameters identified for this stage are:

- P701: Accessibility of repair services [%]
- P702: Successful repairs carried out within a specified period [%]
- P703: Repairs not complete and correct first time [%]
- P704: Punctuality of appointments for repairs [OR & Time]
- P705: Efficiency of the repair service [OR]
- P706: Fault repair time [Time & %]
- P707: Number of customer complaints related to repair services [Number]
- P708: Professionalism of the repair staff [OR]
- P709: Provider ability to match the customer's wishes for conditions of achievement [OR]
- P710: User friendliness of the repair service [OR]

One SP oriented parameter has been identified for this stage:

- P711: Organisational efficiency of repair service (SPO) [OR]

5.7.1 P701: Accessibility of repair services [%]

5.7.1.1 Definition of Parameter

The parameter "accessibility of repair services" is expressed by the availability of hardware, software and staff resources necessary to restore a service (and its features) to its specified level of performance.

5.7.1.1.1 Explanation on Parameter Definition

Customers may report faults over different modes provided by the SP. Examples of such modes are; telephone, email, postal mail, web etc. The modes available are stated by the SP. The SP may also indicate the access hours to the fault reporting desk available to the customers. The SP will indicate the availability of resources to carry out the repair.

A timeout T_{71} will operate for the purposes of this parameter. Where customer attempts to request repair are not successful within this time these may be counted as failed attempts to access the SP.

5.7.1.2 Equation

$$P701 [\%] = \frac{N_R}{N_S} \times 100\%$$

where

N_R	Number of repair requests successful
N_S	Total number of repair requests

5.7.1.3 Measure

The parameter is expressed as a percentage.

5.7.2 P702: Successful repairs carried out within a specified period [%]

5.7.2.1 Definition of Parameter

The parameter "successful repairs carried out within a specified period" is expressed as the ratio of the number of repairs successfully carried out to the total number of repair requests accepted by the SP within a specified period.

5.7.2.1.1 Explanation on Parameter Definition

Rate of repairs carried out successfully within a specified period of time $T_{72} + T_{73}$.

A repair carried out is considered successful if the service is restored to its specification. This has to be agreed/confirmed by the customer.

If an additional fault is found, not reported but evident while carrying out repairs these may also be repaired in the context of the reported fault.

It may well be that a service may fail again after some time for the same fault. This would be counted as a separate fault.

5.7.2.2 Equation

$$P702 [\%] = \frac{N_R}{N_S} \times 100\%$$

where

N_R	Number of repair requests carried out successfully within a specified period of time $T_{72}+T_{73}$
N_S	Number of repair requests

5.7.2.3 Measure

The parameter is expressed as a percentage.

5.7.3 P703: Repairs not complete and correct first time [%]

5.7.3.1 Definition of Parameter

The parameter "repairs not complete and correct first time" is expressed as the ratio (percentage) of the number of repairs which were not successfully carried out at the first (and only) attempt to the total number of repairs carried out during the specified period.

5.7.3.1.1 Explanation on Parameter Definition

Examples of reasons for unsuccessful repairs at the first attempt are:

- Incorrect diagnosis of fault.
- Lack of resources (parts, human effort, time, etc.).
- Other contributory factors.

5.7.3.2 Equation

$$P703 [\%] = \frac{\sum N_I}{\sum N_S} \times 100\%$$

with $N_I = \begin{cases} 1, & \text{if first time repair is not complete or not correct} \\ 0, & \text{else} \end{cases}$

and $N_S = \begin{cases} 1, & \text{if repair is done} \\ 0, & \text{else} \end{cases}$

where

$\sum N_I$	Number of repairs which are either incomplete or not correct in the first attempt
$\sum N_S$	Number of repairs carried out

All measures are related to the reporting period.

5.7.3.3 Measure

The indicator is expressed as a percentage.

5.7.4 P704: Punctuality of appointments for repairs [OR & Time]

5.7.4.1 Definition of Parameter

The parameter "punctuality of appointments for repairs" is expressed as a record of attendance of a SP agent to carry out repair at the specified time (allowing, if necessary, a grace period for lateness). It may also be expressed as an opinion rating of customers.

5.7.4.1.1 Explanation on Parameter Definition

The SP or its agent may be allowed, at the discretion of the national stakeholder, a grace period for lateness, beyond which the attendance will not be eligible to be counted as punctual.

5.7.4.2 Equation

$$P704a[OR] = \frac{\sum_{i=1}^N OR_i}{N}$$

where OR is the mean opinion rating, with OR_i ($i = 1 \dots N$) being the individual opinion ratings for the N members of the audit panel.

i	Index of expert
N	Number of experts in the panel

$$P704b[\text{Time}] = \frac{\sum_{i=1}^N (t_{4,i} - t_{5,i})}{N}$$

where

i	Index of each service repair event
N	Number of repair events
$t_{4,i}$	Announced service repair time for repair event i
$t_{5,i}$	Time when the service repair event i actually occurs

NOTE: If $t_{4,i}$ occurs before the announced end of the repair period $t_{5,i}$, P704b generates negative values. This is desired to make repair events appearing too early also transparent.

5.7.4.3 Measure

Opinion rating [OR] as defined in clause 4.1 based on a customer survey of customers who have had recent experience of repair (P704a); and/or

average delay in the appointed time based on equation in clause 5.7.4.2 above (P704b).

5.7.5 P705: Efficiency of the repair service [OR]

5.7.5.1 Definition of Parameter

The parameter "efficiency of the repair service" (mainly technical) of a SP is characterised by the combined performances of:

- accessibility (parameter 701);
- the number of repairs in a specified period of time (parameter 702);
- repairs carried out successfully first time (parameter 703); and
- punctuality (parameter 704).

5.7.5.1.1 Explanation on Parameter Definition

This parameter is intended to provide a measure of how well the repair service, mainly technical, is effective. This parameter complements parameter "Organisational Efficiency" (P 711) which is a measure of the organisational efficiency of the SP.

5.7.5.2 Equation

$$P705[\text{OR}] = \frac{\sum_{i=1}^N OR_i}{N}$$

where OR is the mean opinion rating, with OR_i ($i = 1 \dots N$) being the individual opinion ratings for the N members of the panel.

i	Index of customer
N	Number of customers in the panel

5.7.5.3 Measure

Opinion rating [OR] as defined in clause 4.1.

5.7.6 P706: Fault repair time [Time & %]

The duration from the instant a fault has been notified by the customer to the published point of contact of the SP to the instant when the service element or service has been restored to normal working order:

- P706a[Time] Time to repair 80 % and 95 %, and percentage on target date for any category of faults.
 P706b[%] The percentage of faults cleared any time stated as an objective by the SP.

Reference: Fault repair time; Fault repair time for fixed access lines; EG 202 009-2 [i.2], ES 202 057-1 [i.3].

5.7.7 P707: Number of customer complaints related to repair services [Number]

- P707[Number] Number of complaints related to repair services logged per customer.

Reference: Number of customer complaints; EG 202 009-2 [i.2], ES 202 057-1 [i.3].

5.7.8 P708: Professionalism of the repair staff [OR]

- P708[OR] Assessment of the professionalism of the repair staff by a representative user panel.

Reference: Professionalism of help line; EG 202 009-2 [i.2], ES 202 057-1 [i.3].

5.7.9 P709: Provider ability to match the customer's wishes for conditions of achievement [OR]

- P709[OR] Assessment of the provider ability to match the customer's wishes by a representative user panel.

Reference: Quality of customer relations; EG 202 009-2 [i.2], ES 202 057-1 [i.3].

5.7.10 P710: User friendliness of the repair service [OR]

- P710[OR] Assessment of the repair service dependability, assurance, empathy and responsiveness by a representative user panel.

Reference: Quality of customer relations; EG 202 009-2 [i.2], ES 202 057-1 [i.3].

The following parameter is SP oriented.

5.7.11 P711: Organisational efficiency of repair service (SPO) [OR]

5.7.11.1 Definition of Parameter

The parameter "Organisational (or operational) efficiency of repair service" is characterised by the combined performances of:

- punctuality (Parameter 703);
- time to repair (Parameter 706);
- provision of resources (human, hardware and software); and
- the organisational logistics to provide an effective repair service.

5.7.11.1.1 Explanation on Parameter Definition

This parameter is intended to provide a measure of how effective the repair service, is from an organisational or operational point of view. This parameter completes parameter 'Efficiency of Repair Service' (parameter 705) which is a measure of the technical efficiency of the SP.

5.7.11.2 Equation

$$P711[OR] = \frac{\sum_{i=1}^N OR_i}{N}$$

where OR is the mean opinion rating, with OR_i ($i = 1 \dots N$) being the individual opinion ratings for the N members of the panel.

i Index of customer
 N Number of customers in the panel

5.7.11.3 Measure

Opinion rating [OR] as defined in clause 4.1.

5.8 Customer Relationship Stage: Metering, Charging, Billing

Metering Charging and Billing is a particularly sensitive area in the activities of a SP. Customers are sensitive to the charging and billing principally due to the fact the charging formula are usually complex and the absence of meters in the customer's premises. This clause identifies the parameters considered pertinent to be relevant to assess the quality and accuracy of the SP's billing mechanisms.

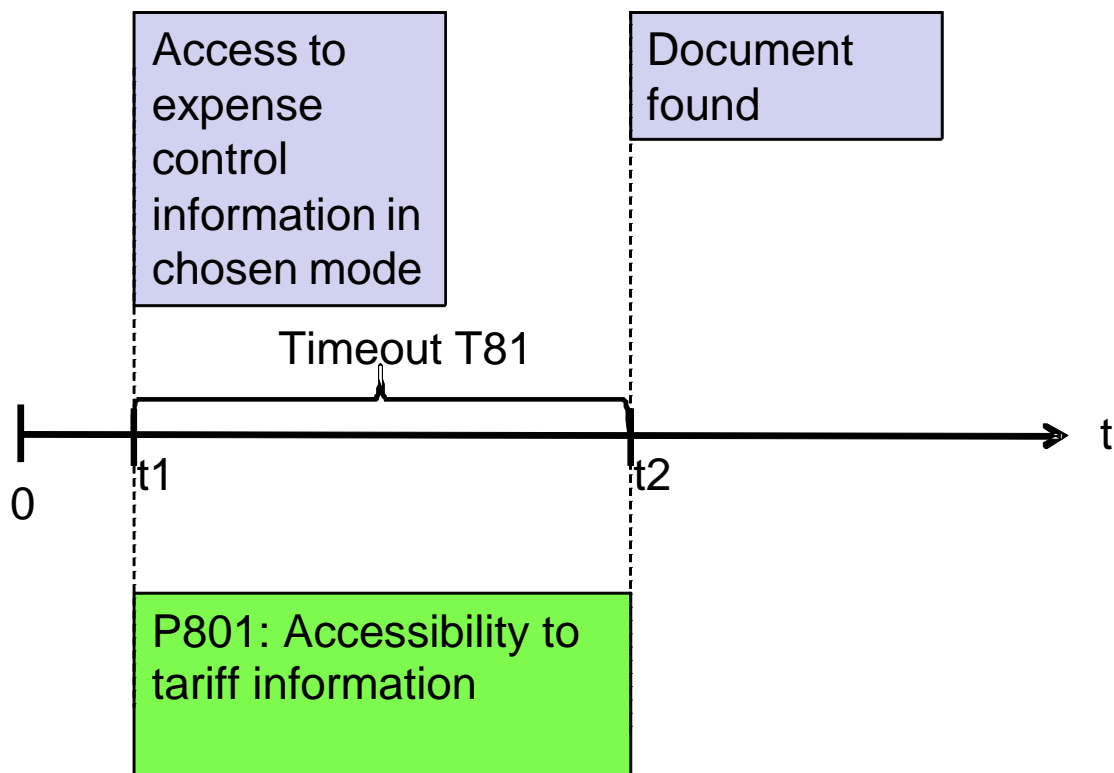

Figure 20a: Events and parameters for Metering, Charging, and Billing

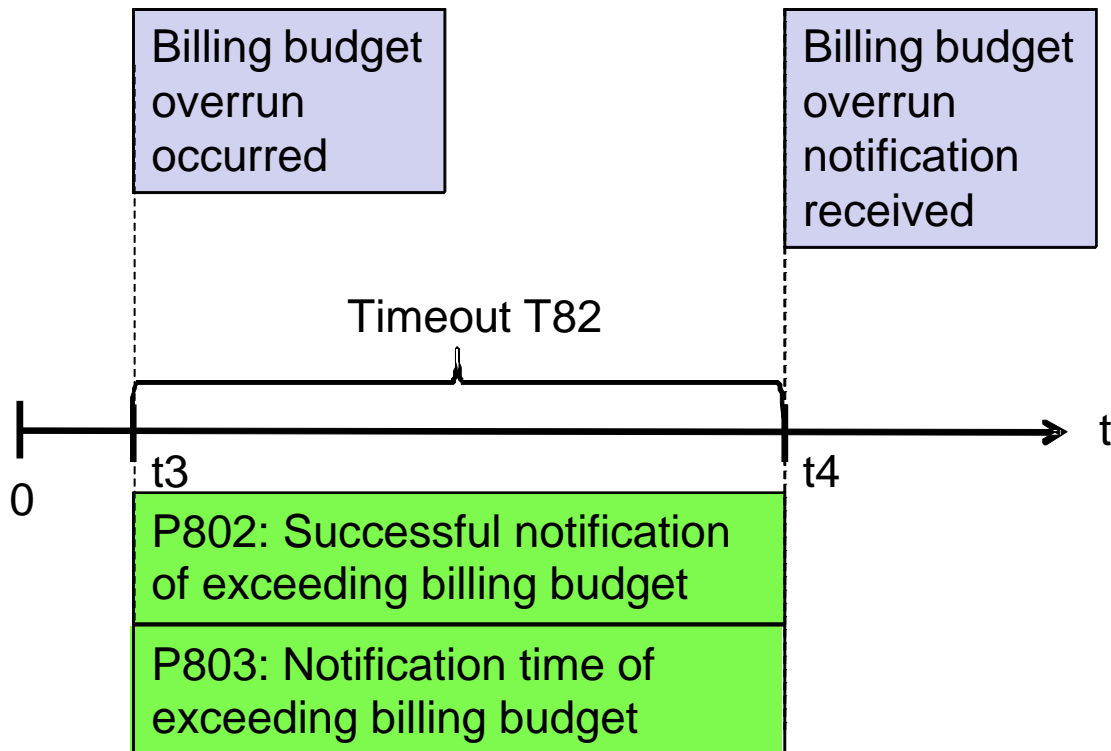

Figure 20b: Events and parameters for Metering, Charging, Billing

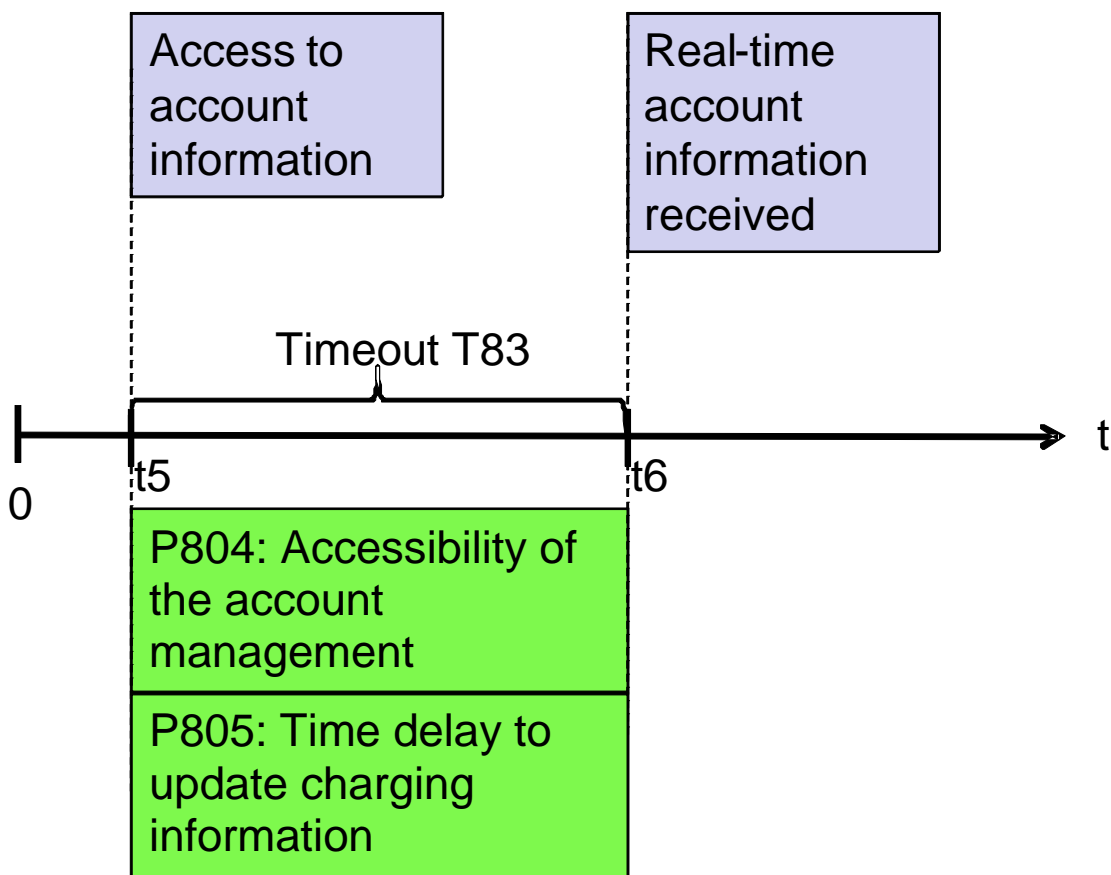

Figure 20c: Events and parameters for Metering, Charging, and Billing

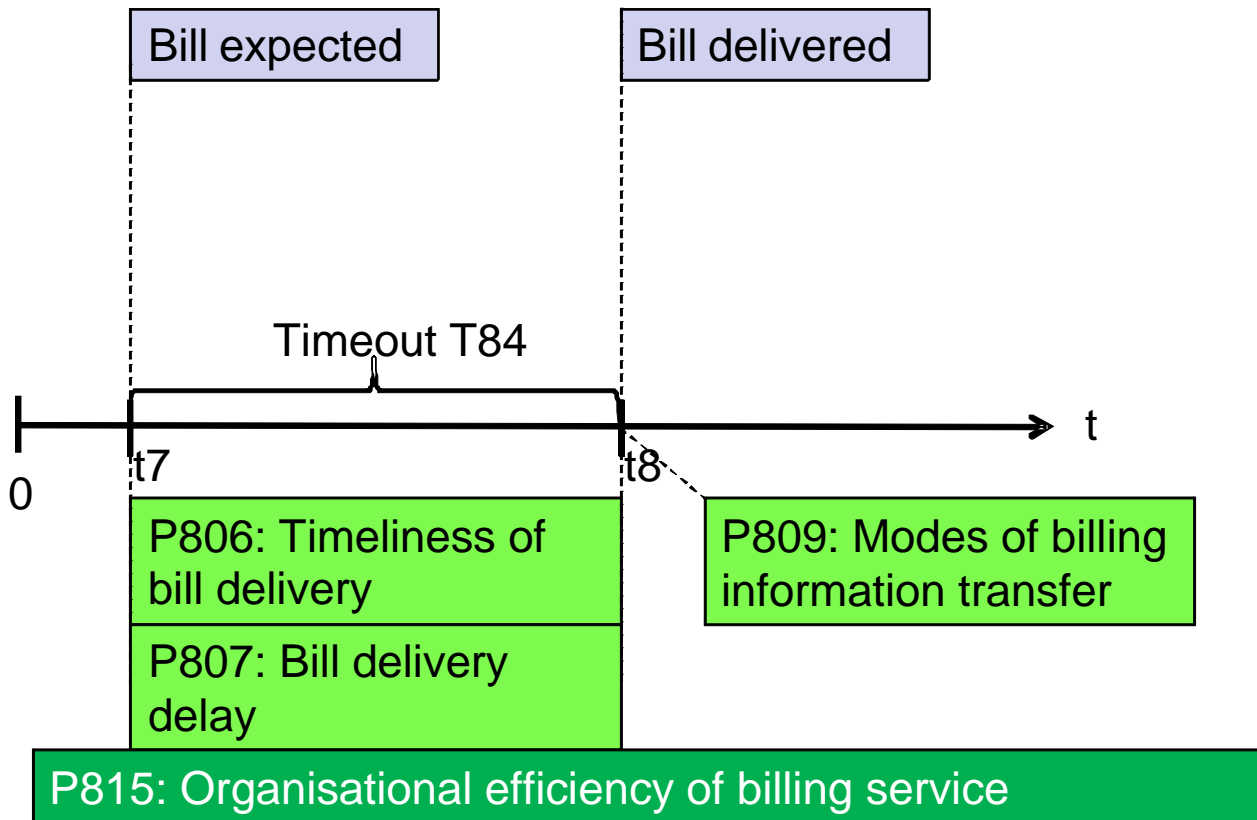

Figure 20d: Events and parameters for Metering, Charging, and Billing

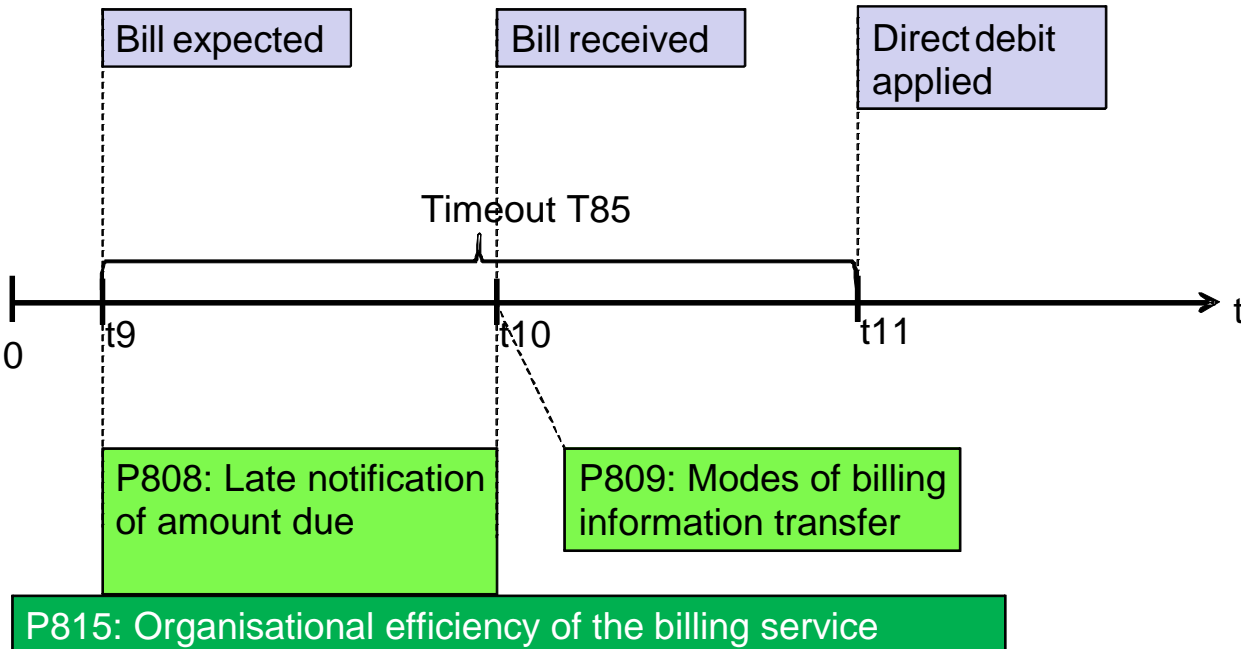

Figure 20e: Events and parameters for Metering, Charging, Billing

The user oriented parameters identified for this stage are:

- P801: Accessibility of the tariff information [%]
- P802: Successful notification of exceeding billing budget [%]
- P803: Notification time (delay) of exceeding billing budget [Time]
- P804: Accessibility of the account management [%]
- P805: Time to update charging information [Time]
- P806: Timeliness of bill delivery [%]
- P807: Bill delivery delay [Time]
- P808: Late notification of amount due [%]
- P809: Modes of billing information transfer [Number]
- P810: Bill correctness complaints [%]
- P811: Prepaid account credit correctness complaints [%]
- P812: Provider ability to match the customer's wishes for charging/billing conditions [OR]
- P813: User friendliness of the desk in charge of billing issues [OR]
- P814: Bill presentation quality [OR]

One SP oriented parameter has been identified for this stage:

- P815: Organisational efficiency of the billing service (SPO) [OR]

5.8.1 P801: Accessibility of the tariff information [%]

5.8.1.1 Definition of Parameter

The parameter "accessibility of the tariff information" facility is expressed as the ratio of the number of successful attempts to the total number of attempts to reach this facility located as indicated in the contract or regulations (Access details to this facility to be provided by the SP).

5.8.1.1.1 Explanation on Parameter Definition

This parameter reflects the accessibility of information regarding the SP's tariffs by the customers. Multiple modes of information have to be considered, e.g. flyers, documents, and web-pages. Tariff information is considered available either in paper at the next SP shop or via post mail, or alternatively when the hyperlink provided in electronic documentation or on flyer shows it directly.

5.8.1.2 Equation

$$P801 [\%] = \frac{N_S}{N_A}$$

where

- N_S Number of successful access attempts to tariff information
- N_A Number of access events to tariff information

5.8.1.3 Measure

The indicator is expressed as percentage.

5.8.2 P802: Successful notification of exceeding billing budget [%]

5.8.2.1 Definition of Parameter

The parameter "successful notification of exceeding billing budget" to the customer by the SP is expressed as the ratio (percentage) of the number of successful notifications by the SP of exceeding the customer's billing budget to the total number of exceeding customer's billing budget events.

5.8.2.1.1 Explanation on Parameter Definition

This parameter reflects the percentage of the successful notification to the customer that he has exceeded his billing budget (i.e. in a short delay and each time it occurs). In order to be usable, the notification should be transmitted to the customer in specified period after occurrence of the event. Different modes of notification have to be considered, e.g. web-access, short message service, email. Different types of contracts could also lead to different modes of information.

5.8.2.2 Equation

$$P802 [\%] = \frac{\sum N_R}{\sum N_S} \times 100\%$$

with $N_R = \begin{cases} 1, & \text{if SP's notification is received by customer} \\ 0, & \text{else} \end{cases}$

and $N_S = \begin{cases} 1, & \text{if customer exceeds his billing budget} \\ 0, & \text{else} \end{cases}$

where

$\sum N_R$	Number of successful notifications for exceeding customer's billing budget received by customer from SP
$\sum N_S$	Number of exceeding customer's billing budget events

All measures are related to the reporting period.

5.8.2.3 Measure

The indicator is expressed as percentage.

5.8.3 P803: Notification time (delay) of exceeding billing budget [Time]

5.8.3.1 Definition of Parameter

The parameter "notification time (delay) of exceeding billing budget" is expressed as the time from the instant of billing budget overrun to the instant of the reception by the customer of this notification from the SP.

5.8.3.1.1 Explanation on Parameter Definition

After the occurrence of the expense overrun event a notification of the SP is sent to the customers. This parameter reflects the delay in notifying the customer.

5.8.3.2 Equation

$$P803 [\text{Time}] = \frac{\sum_{i=1}^N (t_{4,i} - t_{3,i})}{N}$$

where

N	Number of billing budget overrun events
i	Index of each billing budget overrun event
$t_{3,i}$	Point of time when billing budget i is overrun
$t_{4,i}$	Point of time when billing budget notification i actually occurs

5.8.3.3 Measure

The indicator is expressed in units of time expressed in minutes, hours or days as appropriate.

A timeout value is required to prevent from unduly long waiting for the expense overrun notification. Events that do not occur within the timeout period are counted as unsuccessful attempts which deliver no contribution to this parameter.

5.8.4 P804: Accessibility of the account management [%]

5.8.4.1 Definition of Parameter

The parameter "accessibility of the account management" facility is expressed as the ratio of the number of successful attempts to the total number of attempts to reach the account management.

5.8.4.1.1 Explanation on Parameter Definition

This parameter reflects the accessibility rate of the customer to the account management facility of SP within a specified time interval.

5.8.4.2 Equation

Definition for event ratio:

$$P804 [\%] = \frac{\sum N_x}{\sum N_y} \times 100\%$$

where

N_x	Number of successful access attempts to the account management
N_y	Number of access events to the account management

5.8.4.3 Measure

The indicator is expressed as percentage.

5.8.5 P805: Time to update charging information [Time]

5.8.5.1 Definition of Parameter

The parameter "Time to update charging information " is expressed as the time between the use of service and the instant the related charging information is available on the account.

5.8.5.1.1 Explanation on Parameter Definition

This parameter reflects the delay between the creation of a billing record and its effect on the real time expense information the customers can reach.

5.8.5.2 Equation

$$P805 [\text{Time}] = \frac{\sum_{i=1}^N (t_{6,i} - t_{5,i})}{N}$$

where

N	Number of access to account information events
i	Index of each access event
$t_{5,i}$	Point of time when access i is made
$t_{6,i}$	Point of time when account information i actually occurs

5.8.5.3 Measure

The indicator is expressed in units of time expressed in minutes, hours or days as appropriate.

A timeout value T_{83} is required to prevent from unduly long waiting for the expense overrun notification. Events that do not occur within the timeout period are counted as unsuccessful attempts which deliver no contribution to this parameter.

5.8.6 P806: Timeliness of bill delivery [%]

5.8.6.1 Definition of Parameter

The parameter "timeliness of bill reception" is expressed as the ratio of the number of bills delivered within the bill expectation period divided by the number of bills expected within the observation period.

5.8.6.1.1 Explanation on Parameter Definition

Bill expectation period is defined as T_{84} . Expected but not received bills lead to user complaints. This parameter reflects the rate of the received bills versus the expected bills according to the billing procedures stated in their contracts.

5.8.6.2 Equation

$$P806 [\%] = \frac{N_{BR}}{N_{BE}}$$

where

N_{BR}	Number of bills delivered
N_{BE}	Number of bills expected

5.8.6.3 Measure

The indicator is expressed as percentage.

A timeout T_{84} value is required to prevent from unduly long waiting for the bills. Events that do not occur within the timeout period are counted as unsuccessful attempts which deliver no contribution to this parameter.

5.8.7 P807: Bill delivery delay [Time]

5.8.7.1 Definition of Parameter

The parameter "bill delivery delay" is expressed as the delay between the expected time of bill and its receipt.

5.8.7.1.1 Explanation on Parameter Definition

Late delivery of bills leads to user complaints. This parameter reflects the delay between the reception of the expected bill and the time of the expected bill according to the billing procedures stated in their contracts.

5.8.7.2 Equation

$$P807 [\text{Time}] = \frac{\sum_{i=1}^N (t_{8,i} - t_{7,i})}{N}$$

where

N	Number of bill reception events
i	Index of each bill reception event
$t_{8,i}$	Point of time when bill i is received
$t_{7,i}$	Point of time when bill i is expected

5.8.7.3 Measure

The indicator is expressed in units of time expressed in minutes, hours or days as appropriate.

The timeout value T_{84} is required to prevent from unduly long waiting for the bills. Events that do not occur within the timeout period are counted as unsuccessful attempts which deliver no contribution to this parameter.

5.8.8 P808: Late notification of amount due [%]

5.8.8.1 Definition of Parameter

The parameter "Late notification of amount due" on Direct Debit is expressed as the ratio (percentage) of the number of bills whose "Direct Debit" amount was not advised to the customers before payment was taken from their account to the total number of "Direct Debit" payment arrangements in place.

5.8.8.1.1 Explanation on Parameter Definition

Related to direct debit procedures the monthly amount to pay could vary. For this reason customers should be advised on their direct debit amount whenever there is a change.

The parameter is covered by a timeout value T85 to prevent from unduly long waiting after the point of time the bill has been expected.

5.8.8.2 Equation

$$P808 [\%] = \frac{\sum N_{ADD}}{\sum N_{BDD}}$$

where

N_{ADD}	Number of advice of direct debit received after direct debit
N_{BDD}	Number of advice of direct debit expected before direct debit

5.8.8.3 Measure

The indicator is expressed as percentage.

5.8.9 P809: Modes of billing information transfer [Number]

5.8.9.1 Definition of Parameter

The parameter "Modes of billing information transfer" is expressed as the number of modes offered by the SP to communicate the billing information to the customers.

5.8.9.1.1 Explanation on Parameter Definition

Different modes of communication to communicate the billing information from SP to their customers can be used, e.g. billing letters, emails, web-access, SMS, MMS. This parameter reflects the number of offered modes by SP to communicate the billing information to its customers.

5.8.9.2 Equation

$$P809 = \sum_{i=1}^N m_i$$

with

$$m_i = \begin{cases} 1, & \text{if mode } i \text{ is available} \\ 0, & \text{if mode } i \text{ is not available} \end{cases}$$

where

N	Number of potentially available modes of billing information transfer
i	Index of each billing information transfer mode
$\sum m_i$	Number of actually available billing information transfer modes

5.8.9.3 Measure

The indicator is expressed as number value.

5.8.10 P810: Bill correctness complaints [%]

P810[%] Percentage of bills resulting in a customer complaint per point of billing per year.

Reference: Bill correctness complaints; EG 202 009-2 [i.2], ES 202 057-1 [i.3].

5.8.11 P811: Prepaid account credit correctness complaints [%]

P811[%] Percentage of all prepaid accounts resulting in a customer complaint.

Reference: Prepaid account credit correctness complaints; EG 202 009-2 [i.2], ES 202 057-1 [i.3].

5.8.12 P812: Provider ability to match the customer's wishes for charging/billing conditions [OR]

P812[%] Assessment of the provider ability to match the customer's wishes (e.g. for outstanding debt, last bills, etc.) by a representative user panel.

Reference: Quality of customer relations; EG 202 009-2 [i.2], ES 202 057-1 [i.3].

5.8.13 P813: User friendliness of the desk in charge of billing issues [OR]

P813[%] Assessment of the billing service dependability, assurance, empathy and responsiveness by a representative user panel.

Reference: Quality of customer relations; EG 202 009-2 [i.2], ES 202 057-1 [i.3].

5.8.14 P814: Bill presentation quality [OR]

P814a[OR] How easy is it to find exactly which tariffs and optional services you are subscribing to?
 P814b[OR] How easy is it to locate the record of a specific call to a specific number?
 P814c[OR] How easy is it to find the exact price paid including VAT and any discounts, for a specific call?
 P814d[OR] How easy is it to find which charge band and which rate (peak/off-peak) is applied to a specific call?
 P814e[OR] How do you rate the bill overall in terms of clarity, understandability and ease of use?

Reference: Bill presentation quality; EG 202 009-2 [i.2], ES 202 057-1 [i.3].

The following parameter is SP oriented.

5.8.15 P815: Organisational efficiency of the billing service (SPO) [OR]

5.8.15.1 Definition of Parameter

The parameter "organisational efficiency of the billing service" of a SP is described and measured by the organisational and hardware resource availability to carry out the billing service.

5.8.15.1.1 Explanation on Parameter Definition

Shortcomings in organisational and hardware resources to carry out the billing service management could result in shortage of staff, lack of training, shortage of hardware and logistical issues. This parameter is a measure of the efficiency of the provider in addressing these issues and providing adequate resources to satisfy customer's needs.

5.8.15.2 Equation

$$P815[OR] = \frac{\sum_{i=1}^N OR_i}{N}$$

where OR is the mean opinion rating, with OR_i ($i = 1 \dots N$) being the individual opinion ratings for the N members of the panel.

i Index of expert/customer
 N Number of experts/customer in the panel

5.8.15.3 Measure

Opinion rating [OR] as defined in clause 4.1.

5.9 Customer Relationship Stage: Network/Service (N/S) Management by the customer

This clause deals with the parameters pertinent in the interaction between the customer and the network or services.

Access to network/service Management is not possible during outage of this facility.

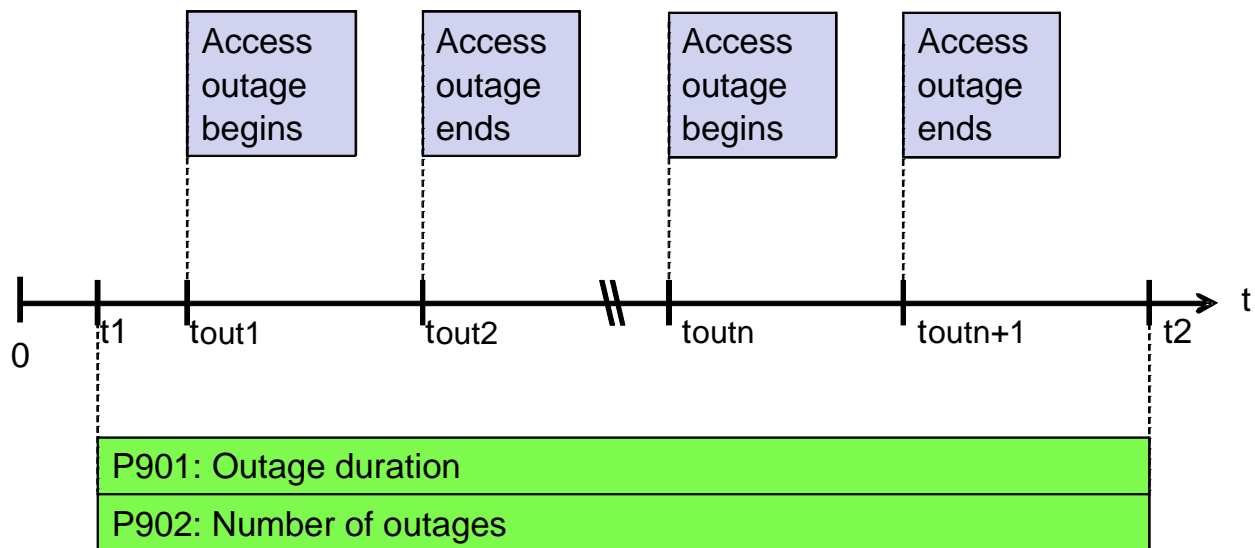

Figure 21a: Events and parameters for Network/Service Management by the customer

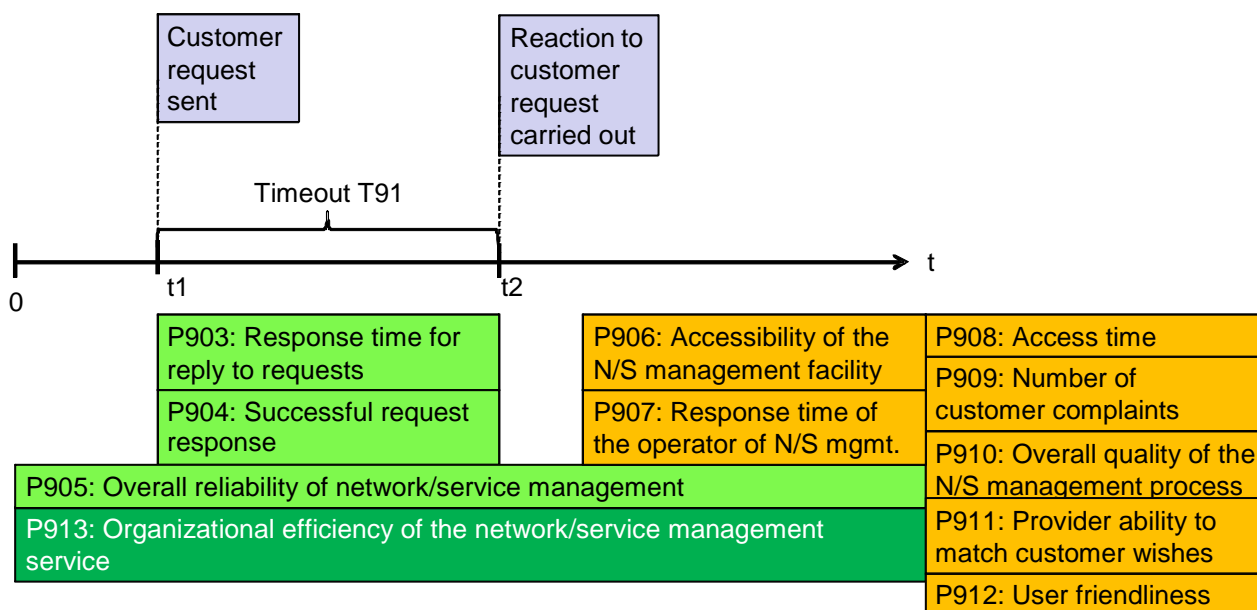

Figure 21b: Events and parameters for Network/Service Management by the customer

The parameters identified for this stage are:

- P901: Outage duration [Time]
- P902: Number of outages [Number]
- P903: Response time for reply to requests [Time]
- P904: Successful request response [%]
- P905: Overall reliability of network/service management service [OR]
- P906: Accessibility of the network/service management facility [Time & %]
- P907: Response time of the operator of the network/service management facility [Time & %]
- P908: Network/Service (N/S) Management access time [Time]
- P909: Number of customer complaints related to network/service management by the customer [Number]
- P910: Overall quality of the network/service management process [OR]
- P911: Provider ability to match the customer's wishes for network/service management conditions [OR]
- P912: User friendliness of the means available to the customer for the operations he has to perform [OR]

One SP oriented parameter has been identified for this stage:

- P913: Organizational efficiency of the network/service management service (SPO) [OR]

5.9.1 P901: Outage duration [Time]

5.9.1.1 Definition of Parameter

The parameter "outage duration" is expressed as the total time a Network/Service Management facility was not accessible to the customer during a specified reporting period.

5.9.1.1.1 Explanation on Parameter Definition

This parameter states the total time access to the Network/Service Management facility was not available irrespective of whether or not the customer attempted access.

There would be a time out for this parameter. If access becomes available beyond the time out the time prior to access being available will be added to the cumulative unavailable time.

5.9.1.2 Equation

$$P901[\text{Time}] = \frac{\sum_1^n (tout_{n+1} - tout_n)}{t_2 - t_1}$$

where (see figure 21a):

i	First outage in time period $[t_1, t_2]$
n	Last outage in time period $[t_1, t_2]$

5.9.1.3 Measure

Time.

5.9.2 P902: Number of outages [Number]

5.9.2.1 Definition of Parameter

The parameter "number of outages" is expressed as the number of times access to the Network/Service Management facility was not available to the customer during a specified period.

5.9.2.1.1 Explanation on Parameter Definition

Lack of access to the Network/Service Management facility should be counted as one if the unavailability is greater than a pre-defined period. Additionally the times of each outage is also recorded.

These specified periods should be set on a service by service basis by the stakeholders e.g. regulator or a national institution responsible for QoS of telecommunication services.

5.9.2.2 Equation

Numerical count of the number of access unavailability commencement characterised by the number of t1 in figure 19.

$$P902[\text{Number}] = \sum_{t_2}^{t_1} Outages$$

where (see figure 21a):

$P902$	Number of outage periods in time period $[t_1, t_2]$
t_1	Start of observation period
t_2	End of observation period
$Outages$	Outages in time period $[t_1, t_2]$

5.9.2.3 Measure

Cumulative number of outages during the specified period of time.

5.9.3 P903: Response time for reply to requests [Time]

5.9.3.1 Definition of Parameter

The parameter "response time for reply to requests" is expressed as the time elapsed from the instant customer requests access to the Network/Service Management facility to the instant such a request was carried out.

5.9.3.1.1 Explanation on Parameter Definition

There would be a time out T_{91} set for a service. Implementation of the request after the time out will not be counted as a request that has been fulfilled for the purposes of this parameter.

5.9.3.2 Equation

$$P903 [Time] = \frac{\sum_{i=1}^N (t_{3,i} - t_{1,i})}{N}$$

where (see figure 21b):

N	Number of Network/Service Management access requests
i	Index of each N/S Management request
$t_{1,i}$	Instant when access request was made
$t_{3,i}$	Instant when actions associated with the request was completed

5.9.3.3 Measure

This parameter is expressed in units of time.

5.9.4 P904: Successful request response [%]

5.9.4.1 Definition of Parameter

The parameter "Network/Service Management successful request response" of a Network/Service Management system is expressed as the ratio (percentage) of the number of requests made by the customer successfully handled (within the specified time out period) to the total number of requests made over the observation period.

5.9.4.1.1 Explanation on Parameter Definition

This parameter provides a measure of the number of requests that were successfully dealt with by the Network/Service Management facility. The lack of fulfilment may be due to several causes, as illustrated in parameter P905. User's feedback may also be included for completeness.

5.9.4.2 Equation

$$P904[\%] = \frac{\sum_{t_1}^{t_2} n}{N} \times 100$$

where (see figure 21b):

t_1	Commencement period of the specified period of observation
t_2	End time of the period of observation
n	Number of successful implementations of customer's request for N/S management, and
N	Total number of requests within the specified period

5.9.4.3 Measure

Parameter value is expressed as a percentage.

5.9.5 P905: Overall reliability of network/service management service [OR]

5.9.5.1 Definition of Parameter

The parameter "overall reliability of Network/Service management service" is described and measured by the consistent combined performance of availability, response times, response rates, correctness and completeness in the processing and fulfilment of customer requests for Network/Service management facilities.

5.9.5.1.1 Explanation on Parameter Definition

This parameter expresses the combined effects of availability, response times, response rates and correctness and completeness at any time during a 24/7 period. It is a measure of the reliability of the resources directly contributing to the fulfilment of the customer requests to address and resolve network and or service management issues.

5.9.5.2 Equation

$$P905[OR] = \frac{\sum_{i=1}^N OR_i}{N}$$

Where OR is the mean opinion rating, with OR_i ($i = 1 \dots N$) being the individual opinion ratings for the N members of the panel.

i Index of expert/customer
 N Number of experts/customers in the panel

5.9.5.3 Measure

Opinion rating [OR] as defined in clause 4.1.

5.9.6 P906: Accessibility of the network/service management facility [Time & %]

P906a[Time] Hours staff can be accessed (human operator) - (Survey).
 P906b[%] Percentage of attempts where an operator was not reach in less than 3 minutes.
 P906c[%] Percentage of successful log-ins to the server with regard to the total attempt number required.

Reference: Successful log-in ratio; EG 202 009-2 [i.2], EG 202 057-4 [i.6].

5.9.7 P907: Response time of the operator of the network/service management facility [Time & %]

Time elapsed between the end of dialling and reaching an operator to complaint management:

P907a[Time] mean time to answer; and
 P907b[%] percentage of calls answered within 20 seconds.

Reference: Response time for admin/billing enquiries; EG 202 009-2 [i.2], ES 202 057-1 [i.3].

P907c[%] percentage of calls answered within 2 minutes (Information from switchboard (PABX)).

5.9.8 P908: Network/Service (N/S) Management access time [Time]

P908[Time] Time in seconds within the fastest 80 % and 95 % of logins to the network/service management server.

Reference: Login time; EG 202 009-2 [i.2], EG 202 057-4 [i.6].

5.9.9 P909: Number of customer complaints related to network/service management by the customer [Number]

P909[Number] Number of complaints related to network/service management by the customer logged per customer.

Reference: Number of customer complaints; EG 202 009-2 [i.2], ES 202 057-1 [i.3].

5.9.10 P910: Overall quality of the network/service management process [OR]

P910[OR] Assessment of the overall quality of the network/service management process by a representative user panel.

Reference: Quality of customer relations; EG 202 009-2 [i.2], ES 202 057-1 [i.3].

5.9.11 P911: Provider ability to match the customer's wishes for network/service management conditions [OR]

P911[OR] Assessment of the provider ability to match the customer's wishes by a representative user panel (e.g. range of parameters manageable, etc.).

Reference: Quality of customer relations; EG 202 009-2 [i.2], ES 202 057-1 [i.3].

5.9.12 P912: User friendliness of the means available to the customer for the operations he has to perform [OR]

P912[OR] Assessment of the user friendliness by a representative user panel.

Reference: Quality of customer relations; EG 202 009-2 [i.2], ES 202 057-1 [i.3].

The following parameter is SP oriented.

5.9.13 P913: Organizational efficiency of the network/service management service (SPO) [OR]

5.9.13.1 Definition of Parameter

The parameter "organisational efficiency of the Network/Service management" service is described and characterised by the combined effects of human, network and other pertinent resources made available by the SP to process and fulfil any volume of customer requests to the Network /Service Management facility on a 24/7 basis.

5.9.13.1.1 Explanation on Parameter Definition

Whereas the individual parameters 901 through 905 deal with the specific performance criteria of the Network/Service management facility by the customer, this parameter focuses on the overall efficiency whereby it is judged by the ability to handle and process satisfactorily requests from customers at all times, including the busiest period. This parameter therefore indicates whether adequate resources in terms of human, network and other necessary resources have been made available by the SP.

5.9.13.2 Equation

Opinion rating scores expressed as a mean value with an indication of the standard deviation.

$$P913[OR] = \frac{\sum_{i=1}^N OR_i}{N}$$

Where OR is the mean opinion rating, with OR_i ($i = 1 \dots N$) being the individual opinion ratings for the N members of the panel.

i	Index of expert/customer
N	Number of experts/customers

A similar equation may be used for the panel members' opinion rating.

5.9.13.3 Measure

Opinion rating [OR] as defined in clause 4.1.

5.10 Customer Relationship Stage: Cessation

The cessation procedure terminates the commercial relationship between the customer and the SP. Two points are important for the customer: His cessation request should be accepted and confirmed by the SP in the first step. In the second step, the cessation becomes effective and the commercial relationship is finally terminated, including the termination of any kind of service usage.

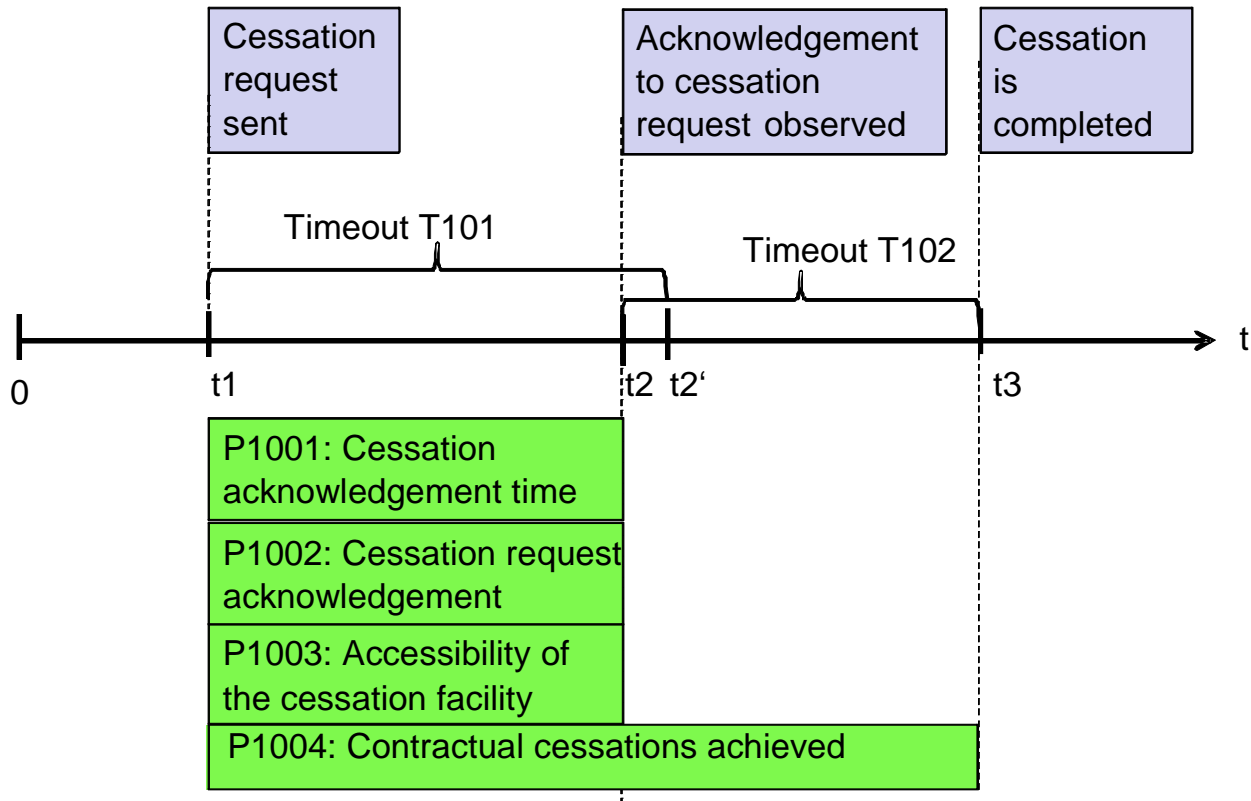

Figure 22: Events and parameters for Cessation

The parameters identified for this stage are:

- P1001: Cessation acknowledgement time [Time]
- P1002: Cessation request acknowledgement [%]
- P1003: Accessibility of the cessation facility [%]
- P1004: Contractual cessations achieved [%]
- P1005: Correctness and completeness in taking the customer cessation request into account [Number & %]
- P1006: Response time of the cessation facility [Time & %]
- P1007: Overall quality of the cessation process [OR]
- P1008: Number of customer complaints related to cessation [Number]
- P1009: Ease of the cessation process [OR]

5.10.1 P1001: Cessation acknowledgement time [Time]

5.10.1.1 Definition of Parameter

The parameter "cessation acknowledgement time" is expressed as the time elapsed from the instant of sending the cessation request to the instant of receipt by the customer of the acknowledgment from the SP.

5.10.1.1.1 Explanation on Parameter Definition

When a customer wants to cease the contract with his SP he sends a cessation request to the SP. This parameter reflects the actual period between sending out this request and the receipt of following acknowledgment of SP by the customer.

A timeout value T_{101} has to be defined to prevent the expected event from unduly long waiting.

5.10.1.2 Equation

$$P1001 [\text{Time}] = \frac{\sum_{i=1}^N (t_{2,i} - t_{1,i})}{N}$$

where

N	Number of cessation requests
i	Index of each cessation request
$t_{1,i}$	Point of time when cessation request i is sent
$t_{2,i}$	Point of time when cessation acknowledgement i is actually received

5.10.1.3 Measure

The indicator is expressed in units of time expressed in minutes, hours or days as appropriate.

The timeout value T_{101} is required to prevent from unduly long waiting for the service provisioning event. Acknowledgements that do not occur within the timeout period are counted as unsuccessful attempts which deliver no contribution to this parameter.

5.10.2 P1002: Cessation request acknowledgement [%]

5.10.2.1 Definition of Parameter

The parameter "cessation requests acknowledgement" is expressed as the ratio (percentage) of the number of cessation requests that were acknowledged to the number of such requests made in a specified period.

5.10.2.1.1 Explanation on Parameter Definition

When a customer wants to cease the contract with his SP he sends a cessation request to the SP. This parameter reflects the ratio between sent requests and the received acknowledgement of SP by the customer.

A timeout value T_{101} has to be defined to prevent the expected event from unduly long waiting.

5.10.2.2 Equation

$$P1002 [\%] = \frac{N_A}{N_S}$$

where

N_A	Number of acknowledged cessation requests
N_S	Number of sent cessation requests

5.10.2.3 Measure

The indicator is expressed as a percentage.

5.10.3 P1003: Accessibility of the cessation facility [%]

5.10.3.1 Definition of Parameter

The parameter "accessibility of the cessation facility" is expressed as the ratio (percentage) of the number of successful attempts to the total number of attempts to reach the cessation facility.

5.10.3.1.1 Explanation on Parameter Definition

This parameter reflects the accessibility rate of the customer to the cessation facility of SP in a specified time interval. When a customer wants to cease the contract with his SP he sends it a cessation request. This parameter reflects the rate of accessibility of SP staff or facilities. Different modes can be used, e.g. web, email, letter. SP information about service hours can also be used.

Depending on the chosen access mode different values for the timeout T101 should be applied.

5.10.3.2 Equation

$$P1003 [\%] = \frac{\sum N_R}{\sum N_S} \times 100\%$$

with $N_R = \begin{cases} 1, & \text{if event of access to cessation facility is successful} \\ 0, & \text{else} \end{cases}$

and $N_S = \begin{cases} 1, & \text{if access event to cessation facility is started} \\ 0, & \text{else} \end{cases}$

where

$\sum N_R$	Number of successful access events to cessation facility
$\sum N_S$	Number of started access events to cessation facility

All measures are related to the reporting period.

5.10.3.3 Measure

The indicator is expressed as a percentage.

5.10.4 P1004: Contractual cessations achieved [%]

5.10.4.1 Definition of Parameter

The parameter "contractual cessations achieved" is expressed as the ratio (percentage) of the number of contractual cessations requested to the total number of such requests made within a specified period.

5.10.4.1.1 Explanation on Parameter Definition

When customer wants to cease the contract with SP he sends a cessation request to operator. He expects that his cessation is handled within a short period of time. This parameter reflects the rate of achieved contractual cessations within a specified period.

A period of time is allowed for handling the cessation at SP.

A timeout value T₁₀₁ + T₁₀₂ has to be defined to prevent the expected event from unduly long waiting.

5.10.4.2 Equation

$$P1004 [\%] = \frac{N_{CA}}{N_{CR}} \times 100\%$$

where

N_{CA}	Number of cessation requests achieved
N_{CR}	Number of cessation requests

5.10.4.3 Measure

The indicator should be expressed as a percentage.

5.10.5 P1005: Correctness and completeness in taking the customer cessation request into account [Number & %]

- P1005a[Number] First time failure: Number of times the request has not been completed satisfactorily at the first time with respect to the total number of requests.
 P1005b[%] Rate of call to the support due to an issue not solved after the first call.
 P1005c[Number] Number of attempts before reception of any kind of acknowledgment from the provider.
 P1005d[Number] Number of cessation requests that are not completed satisfactorily within a given period of time stated as an objective by the SP.

Reference: Quality of customer relations; EG 202 009-2 [i.2], ES 202 057-1 [i.3].

5.10.6 P1006: Response time of the cessation facility [Time & %]

Time elapsed between the end of dialling and reaching an operator to cessation facility:

- P1006a[Time] mean time to answer; and
 P1006b[%] percentage of calls answered within 20 seconds.

Reference: Response time for admin/billing enquiries; EG 202 009-2 [i.2], ES 202 057-1 [i.3].

- P1006c[%] percentage of calls answered within 2 minutes (Information from switchboard (PABX)).

5.10.7 P1007: Overall quality of the cessation process [OR]

- P1007[OR] Assessment of the overall quality of the cessation process by a representative user panel.

Reference: Quality of customer relations; EG 202 009-2 [i.2], ES 202 057-1 [i.3].

5.10.8 P1008: Number of customer complaints related to cessation [Number]

- P1008[Number] Number of complaints related to cessation logged per customer.

Reference: Number of customer complaints; EG 202 009-2 [i.2], ES 202 057-1 [i.3].

5.10.9 P1009: Ease of the cessation process [OR]

Assessment of the ease of the cessation process by a representative user panel:

- P1009a[OR] Ease with which all activities associated with the cessation of the contract may be carried out with the provider.
 P1009b[OR] Ease with which forms can be filled and ease with which they are taken into account by the provider.

Reference: Quality of customer relations; EG 202 009-2 [i.2], ES 202 057-1 [i.3].

6 Evaluation specific methodology/system

While the previous clauses discuss general issues related to QoS parameter assessments (clause 4) and define the QoS parameters themselves for all customer relationship stages (clause 5), this clause specifies evaluation specific topics like:

- trigger points used to determine a QoS parameter;

- the accuracy of the indicator which is closely related to the number of available data sets for each QoS parameter;
- the representativeness of each QoS parameter for the complete customer population; and
- some recommendations to represent the measures generated by the assessment of a QoS parameter.

While clause 5 provides generic definitions of parameters, this clause is related to evaluation specific matters and their use cases. Although listed in clause 5, parameters P105 to 108, P205 to P210, P309 to P314 , P409 to P411, P509 to P511, P627 to P631, P646 to P651, P667 to P670, P706 to P710, P810 to P 814 and P906 to P912 are not considered in clause 6 as the evaluation methodology is already described in another guide, namely EG 202 057 set [i.3], [i.4], [i.5] and [i.6]. Comparable outcomes of a QoS parameter assessment are ensured only if the same conditions are applied.

Furthermore, different data sources might be available to assess the defined parameters. Wherever this situation is applicable, the specific conditions should be specified before the assessment and they should be mentioned after the assessment when the results are reported. Otherwise there is a danger of mixing up results which were generated under different circumstances making comparisons meaningless.

6.1 Customer Relationship Stage: Preliminary information (PI)

6.1.1 P101: Integrity of PI [OR]

6.1.1.1 Evaluation specific description

Preferably the opinion rating is carried out by an expert panel. The number of members in the team is at the discretion of the stakeholder/s. Expertise required for the panel are telecommunications law, technical familiarity with the use of the service (mostly for content), academic knowledge of language used (mainly for language) and marketing (for style).

Panel may rate the OR for each of the three components for the main modes of providing PI (e.g. printed form, electronic, voice etc). Where only a limited number of modes are provided these may be rated in its entirety. Where a larger number of modes are provided only the main ones need be rated. The stakeholder may decide which modes are to be rated.

The stakeholder may decide weighting to be given for content, language and style of the PI provided for each mode.

Precondition: Preliminary Information has been delivered.

6.1.1.2 Trigger points

The rating may be carried out whenever a new service is to be marketed and/or when significant changes are made to an existing service.

Table 4: P101 trigger point

Event	Trigger point from customer's point of view	Condition
PI is delivered to the customer	Start/Stop: t_2 in figure 7	

6.1.1.3 Accuracy of indicator (metric of the measure)

The accuracy of this indicator depends on the manning of the panel. The more opinions are gathered within the OR, the more accurate the overall result will be. For more information on this, see clause 4.

6.1.1.4 Representativeness

The segmentation of the population may be made to reflect the service usage patterns (see clauses 4.2 and 4.3).

6.1.1.5 Presentation of parameter values

The OR score may be presented on a regular basis in one of the following ways, depending upon the sample size:

- Mean of the OR values.
- Histograms of the distribution of OR scores.

The opinion ratings are to be presented on a segment basis. The following segmentation is recommended:

- Residential customers:
 - Young people aged between 11 and 21 years.
 - Adults aged between 21 and 65 years.
 - Elderly aged 65 and over.
- Business customers:
 - Business customers aged 21 and above.

Where other user segments are selected opinion ratings for these may also be reported.

A chart can be used to display the results of the different available modes.

6.1.2 P102: Pricing transparency [OR]

6.1.2.1 Evaluation specific description

Preferably the opinion rating is carried out by an expert panel. The number of members in the panel is at the discretion of the stakeholder/s and will be reported.

Examining if there is a significant difference between the opinion of the expert panel and that of the public is recommended for services for which there is likelihood of such difference. The two sets of ratings (Expert panel and Consumer Survey) could complement each other and provide assurance to the potential customers. Opinion ratings based on the feedback from end-customers may be taken into account to adjust both sources of rating information.

Expertise required in the panel is technical familiarity with the use of the service or type of services.

Precondition: Preliminary Information is delivered.

6.1.2.2 Trigger points

OR may be established whenever PI for a new service is being introduced into the market. It is also established whenever there is/are change/s to the tariff structure introduced by the provider and the PI is amended.

Table 5: P102 trigger point

Event	Trigger point from customer's point of view	Condition
PI is delivered to the customer	Start/Stop: t_2 in figure 7	

6.1.2.3 Accuracy of indicator (metric of measure)

The accuracy of this indicator depends on the manning of the panel. The more opinions are gathered within the OR, the more accurate the overall result will be. For more information on this, see clause 4.

6.1.2.4 Representativeness

Tariffs are normally applicable to the whole customer population. Where there are special offerings to segments of the population, e.g. disabled, elderly or any other segment, the tariff information could be subject to OR scores for each of these categories.

6.1.2.5 Presentation of parameter values

Opinion rating of the expert panel should be presented with an indication on the distribution of the members' individual scores taking into account the various types of services. The mean value should be given as a synthetic indication.

Where the opinion of the public has also been taken into consideration the OR of both the public and the expert panel should be published.

Results should be provided on a regular basis with a clear indication on the panel composition and size.

A chart can be used to display the results of the various types of services.

6.1.3 P103: Availability of PI [%]

6.1.3.1 Evaluation specific description

The data may come from two sources; one set of data would be from the customer survey and the other from the records of the SP.

6.1.3.2 Trigger points

Start trigger is always "customer is requesting PI via [mode]", end trigger points are either "PI is delivered within the specified time period" (successful outcome) or "PI is not delivered within the specified time period" (unsuccessful outcome due to a timeout). The PI delivery can use any available mode, e.g. the request sent via a web page and the delivery via normal mail. Or the request is sent via a voice call, the delivery by emailing a PDF document.

Table 6: P103 trigger points

Mode	Start trigger	Successful stop trigger	Unsuccessful stop trigger
Request is sent via an email	Customer sends a request for PI via email to a SP (t_1 in figure 7)	Customer receives the desired PI within mode-dependent expected time period (t_3 in figure 7)	Customer receives other information than PI within mode-dependent expected time period OR Customer does not receive any kind of information within mode-dependent expected time period (timeout condition) (t_3 in figure 7)
Request is sent via a voice call	Customer calls an SP to deliver PI to him	Same as above	Same as above
Request is sent via a letter / postcard	Customer sends a request for PI via a letter/postcard to a SP	Same as above	Same as above
Request is sent via a web page	Customer sends a request for PI via a web page to a SP	Same as above	Same as above
Request is given to a member of shop staff	Customer talks to someone in an SP's shop to receive PI	Same as above	Same as above

Examples of time dependent timeouts are:

Table 7: Examples of time dependent timeouts

Mode	Sending request to SP	Delay in delivering PI
Email	{30} minutes	{A few hours}
Voice call	No delay, real-time	Immediate delivery in the same phone call or follow-up phone call within {2} hours
Letter / postcard	{2} days	{2} days
Web page	No delay, real-time	Immediate delivery via files/written information on homepage
Shop	real-time, restricted by number of people in shop	Immediate delivery
NOTE: The values in brackets "{}" are provided for information.		

An email request may be followed by postal delivery of the PI. This would result in an overall timeout of {2} days. The request given directly to a shop assistant would lead to the expectation that the PI is delivered immediately.

6.1.3.3 Accuracy of indicator (metric of measure)

The accuracy of this indicator depends on the number of available data sets.

6.1.3.4 Representativeness

The availability is estimated from the sample. The sample chosen is, wherever possible aimed to represent the whole of the population.

6.1.3.5 Presentation of parameter values

Availability is expressed as a percentage that should be provided on a regular basis (boxplots). A chart can be used to display the results of the different available modes.

6.1.4 P104: Response time for the provision of PI [Time]

6.1.4.1 Evaluation specific description

The assessment of this parameter may come from a Consumer Survey or from an Expert panel (preferred scenario). The number of members in the panel is at the discretion of the stakeholder/s and will be reported.

Panel members record the time to provide PI for each mode.

Response times may be measured at a time to be recommended by the stakeholder e.g. at regular intervals, whenever a significant change is detected to an earlier reported time.

Timeout condition: If no PI delivery event occurs up to t_3 in figure 7, this parameter cannot be calculated.

6.1.4.2 Trigger points

Response times may be measured at the introduction of a service and new modes of providing PI.

Trigger points are; when a request is made for PI and when the PI is delivered to the enquirer.

Table 8: P104 trigger points

Mode	Start trigger	Successful stop trigger	Unsuccessful stop trigger
Request is sent via an email	Customer sends a request for PI via email to a SP	Customer receives the desired PI within mode-dependent expected time period	Customer receives other information than PI within mode-dependent expected time period OR Customer does not receive any kind of information within mode-dependent expected time period (timeout condition)
Request is sent via a voice call	Customer calls a SP to deliver PI to him	Same as above	Same as above
Request is sent via a letter / postcard	Customer sends a request for PI via a letter/postcard to a SP	Same as above	Same as above
Request is sent via a web page	Customer sends a request for PI via a web page to a SP	Same as above	Same as above
Request is given to a member of shop staff	Customer talks to someone in a SP's shop to receive PI	Same as above	Same as above

Table 9: Examples of time dependent timeouts

Mode	Sending request to SP	Delay in delivering PI
Email	{30} minutes	{A few hours}
Voice call	No delay, real-time	Immediate delivery in the same phone call or follow-up phone call within {2} hours
Letter / postcard	{2} days	{2} days
Web page	No delay, real-time	Immediate delivery via files/written information on homepage
Shop	No delay, real-time	Immediate delivery
NOTE: The values in brackets "{}" are provided for information.		

6.1.4.3 Accuracy of indicator (metric of measure)

Refer to accuracy of indicator in clause 4.3.4.

6.1.4.4 Representativeness

The response time is normally estimated by sampling. The sample is chosen wherever possible to represent the whole population.

6.1.4.5 Presentation of parameter values

The time taken may be published as the mean time taken for each of the following categories of providing information:

- By post.
- By electronic mail.
- By telephone (two way conversation). Here more than one conversation is necessary to obtain the information the total time of actual conversation time would constitute the tie for supply of the information.
- By one way telephone message.
- By Internet web pages.

In each case the sample size is also to be quoted.

Additionally the spread may be quoted for 2 and 3 standard deviations in each case.

Observations should also be presented in histograms as far as possible.

A chart can be used to display the results of the different available modes.

6.2 Customer Relationship Stage: Contract Establishment

6.2.1 P201: Integrity of contract information [OR]

6.2.1.1 Evaluation specific description

Preferably the opinion rating is carried out by an expert panel. The number of members in the panel is at the discretion of the stakeholder/s. These could be regulator or any national institution who undertakes to provide responsible information to the users.

Expertise required in the panel is telecommunications law and technical familiarity with the use of the service. Members of the assessment team may be trained to professionally evaluate all aspects of the service.

There are three separate instances of integrity checks:

- 1) Normal or standard contracts reflecting the PI supplied.
- 2) The customised contract where the customer has asked for specific changes in the terms and conditions of the contract.
- 3) Amendments carried out after the standard or customised contract is signed.

The panel members should be trained to appreciate and assess the key points in a contract between the SP and a customer/user. The members ought to look specifically for compliance of the information provided in the PI with the information provided in the contract. They also ought to look for ambiguity e.g. what have not been said being of relevance. The members will have an insight into the legal aspects of the use of this service or family of services to enable them to critically evaluate the legal aspects and from the customer's and SP's point of view.

6.2.1.2 Trigger points

Opinion rating is to be carried out whenever a new service is introduced into the market. Any significant change to the terms and conditions will also attract a review of the opinion rating. Otherwise there is no need to review the opinion rating.

Table 10: P201 trigger points

Event	Trigger point from customer's point of view	Condition
Final contract is received by customer	Start/Stop: t_3 in figure 8a	Normal contract
Final customised contract is received by customer	Start/Stop: t_3 in figure 8a	When customer asks for customisation
Final amended contract is received by customer	Start/Stop: t_3 in figure 8a	When customer asks for post contract amendment/s

6.2.1.3 Accuracy of indicator (metric of measure)

The accuracy of this indicator depends on the manning of the panel. The more opinions are gathered within the OR, the more accurate the overall result will be. For more information on this, see clause 4.

6.2.1.4 Representativeness

Normally the contractual terms are standard for the whole population except in cases where customisation by individual organisations is required.

6.2.1.5 Presentation of parameter values

The rating may be expressed as the mean of the members' individual ratings at specified periods. Histograms of the panel members OR should be provided.

A chart can be used to display the results of the different available contracts.

6.2.2 P202: Compliance of contractual terms with PI [%]

6.2.2.1 Evaluation specific description

Preferably discrepancies (errors) in contract document from the information given in PI is assessed by an expert panel. In this case one expert is adequate for the panel. The expert may look specifically for compliance in the PI with the information provided in the contract. The expert panel will have an insight into the legal aspects of the use of this service or family of services to enable them to critically evaluate the legal aspects and from the customer's and SP's point of view.

The three cases of integrity checks indicated in clause 6.2.1.1 could also be considered here for compliance of contractual terms with the amendments requested by the customer.

A contract with one or more mistakes or discrepancies from the PI should be counted as one faulty contract.

Access to currently available typical contract document for each service and type of contract the SP should have made available to the panel members.

6.2.2.2 Trigger points

The contract document may be evaluated for errors by the panel members at the introduction of a service and whenever there is a significant change to the terms and conditions of service being offered or whenever a contract is revised by the provider.

Table 11: P202 trigger points

Event	Trigger point from customer's point of view	Condition
Final contract is received by customer	Start/Stop: t_3 in figure 8a	Normal contract
Final contract after customisation is received by customer	Start/Stop: t_3 in figure 8a	Customer asks for customisation
Final contract after post contract amendment is received by customer	Start/Stop: t_3 in figure 8a	Customer asks for amendment after contract was signed

6.2.2.3 Accuracy of indicator (metric of measure)

Not applicable.

6.2.2.4 Representativeness

Not applicable.

6.2.2.5 Presentation of parameter values

Compliance refers to error rate which is expressed as the percentage of the total number of faulty contracts with the number of contracts in the sample. The results should be provided on a regular basis with the list of contracts reviewed and an indication of the results for each contract category, each time there is a change in the contracts.

A chart can be used to display the results of the different available contracts (boxplots).

6.2.3 P203: Flexibility for customisation before contract [OR]

6.2.3.1 Evaluation specific description

Preferably opinion ratings assessment is based on survey of customers who have had experience of customisation to their own requirements before contract was placed.

Where the number of customers who has sought customisation is manageable for the survey all customers may be sought for the survey. Where this is not possible due to large numbers a sample of customer may be surveyed. The sample may aim to select a representative selection of the customer population or experts.

6.2.3.2 Trigger points

Whenever a customer requests customisation this triggers inclusion in a separate log of this fact. This should be accessible, at request, by an external body for the purpose of gathering opinion rating.

Table 12: P203 trigger points

Event	Trigger point from customer's point of view	Condition
Standard contract proposal is received by customer	Start: t_1 in figure 8b	
Customer sends proposal with his customisation desires	t_4 in figure 8b	
Customised contract is received by customer	t_5 in figure 8b	

6.2.3.3 Accuracy of indicator (metric of measure)

The accuracy of this indicator depends on the manning of the panel. The more opinions are gathered within the OR, the more accurate the overall result will be. For more information on this, see clause 4.

6.2.3.4 Representativeness

If the total number of contracts where customisation was requested is manageable all are counted in estimating the opinion rating. Where the number is significantly large, a representative sample may be selected to represent the profile of the customer population. For instance, if there are 100 SME and 1 000 Corporate then the sample to be chosen may be in the same ratio of SME to the Corporate.

6.2.3.5 Presentation of parameter values

The following should be published:

- Opinion rating of the panel should be presented with an indication on the distribution of the members' individual scores taking into account the various types of services.
- Sample size.

A chart can be used to display the results for the various types of services.

6.2.4 P204: Ease and flexibility to amend terms after formal contract [OR]

6.2.4.1 Evaluation specific description

Preferably opinion ratings assessment is based on survey of customers who have had experience of amendments to terms and conditions to their own requirements after contract was placed.

Where the number of customers who has sought customisation is manageable for the survey all customers are sought for the survey. Where this is not possible due to large numbers of contracts, a sample of customers may be surveyed. The selection of the sample could aim to reflect profile of the customer population.

6.2.4.2 Trigger points

Whenever a customer requests amendments to contract after formal agreement this triggers inclusion in a separate log of this fact. This should be accessible, at request, by the QoSAP for the purpose of gathering opinion rating.

Table 13: P204 trigger points

Event	Trigger point from customer's point of view	Condition
Customer sends proposal with his post contract amendment request	Start: t_4 in figure 8a respectively 8b	
Amended contract received by customer	Stop: t_5 in figure 8a respectively 8b	

6.2.4.3 Accuracy of indicator (metric of measure)

The accuracy of this indicator depends on the manning of the panel. The more opinions are gathered within the OR, the more accurate the overall result will be. For more information on this, see clause 4.

6.2.4.4 Representativeness

If the total numbers of contracts where amendments after signature are manageable these are counted in estimating the opinion rating. Where the number is significantly large, a representative sample may be selected to represent the profile customer population. The criteria to be chosen for such selection could reflect the profile of the customer population. For example if there are 100 SME and 1 000 Corporate then the sample to be chosen may be in the same ratio of SME to the Corporate.

6.2.4.5 Presentation of parameter values

The following should be published:

- Opinion rating of the panel should be presented with an indication on the distribution of the members' individual scores taking into account the various types of services.
- Sample size.

A chart can be used to display the results for the various types of services.

6.3 Customer Relationship Stage: Service provisioning

6.3.1 P301: Meeting promised provisioning date [%]

6.3.1.1 Evaluation specific description

Precondition: Provisioning done by the SP.

Evaluation of this parameter can be achieved by:

- Analysis by the QoSAP of data stored at the SP.
- Survey of relevant customers.

6.3.1.2 Trigger points

Table 14: P301 trigger points

Trigger point from customer's point of view	Technical Description	Methodology/system specific trigger points
SP announces the scheduled provisioning date	Start: t_1 in figure 9a	Announcement is received by customer
Successful provisioning on announced provisioning date	Stop: t_2 in figure 9a	Customer registers a correct provisioning on the announced date
Unsuccessful provisioning on announced provisioning date	Stop: t_2 in figure 9a	Customer registers an unsuccessful provisioning attempt on the announced date
Successful provisioning not on the announced date	Stop: t_2 in figure 9a	Customer registers a correct provisioning, but not on the announced date

6.3.1.3 Accuracy of indicator (metric of measure)

The accuracy of this indicator depends on the number of samples used. for evaluation. The higher the number of samples, the higher the accuracy of results. More information available in TS 102 250-6 [i.9].

6.3.1.4 Representativeness / confidence level

If not all the contracts are considered, the number of samples should be defined to ensure that the confidence level is at least x% (see also clause 4.3.3).

6.3.1.5 Presentation of parameter values

The results of this parameter are reported as:

- percentage of provision meeting promised date;
- reporting period;
- number and types of contracts considered.

Results should be provided on a regular basis with a clear indication on the panel composition and size or/and volume of SP data reviewed.

A chart can be used to display the results for the various types of services.

6.3.2 P302: Time for provisioning [Time]

6.3.2.1 Evaluation specific description

Precondition: Provisioning date received by the customer.

Evaluation of this parameter can be achieved by:

- analysis by the QoSAP of data stored at the SP; or
- survey of relevant customers.

6.3.2.2 Trigger points

Table 15: P302 trigger points

Event	Trigger point from customer's point of view	Condition
Provisioning period is announced by SP after contract is concluded	Start: t_1 in figure 9b	Contract is signed
Successful provisioning within time period specified by provider	Stop: t_3 in figure 9b	Provisioning is done before announced period ends at t_4 in figure 9b
Successful provisioning after time period specified by provider	Stop: t_3 in figure 9b exceeds announced period (timeout condition) which is limited by t_4 in figure 9b	Provisioning is not done before announced period ends at t_4 in figure 9b

6.3.2.3 Accuracy of indicator (metric of measure)

If the service provisioning takes place without a previous announcement by the SP, the date of signature of the contract should be considered instead.

6.3.2.4 Representativeness

The parameter can be applied to any customer group of interest (e.g. customer segments or the whole customer population of a SP).

6.3.2.5 Presentation of parameter values

Depending on the sample size per assessed customer segment, these presentations are recommended:

- Histograms.
- Probability Distribution Function (PDF).
- Cumulative Distribution Function (CDF).
- Quantile values.

Results should be provided on a regular basis with a clear indication on the panel composition and size or/and volume of SP data reviewed.

A chart can be used to display the results for the various types of services.

6.3.3 P303: Successful provisioning within specified period [%]

6.3.3.1 Evaluation specific description

Precondition: Provisioning period received by the customer.

Preferably the customer population who have had service provisioned in the recent past is surveyed. Evaluation of this parameter can be achieved by:

- Analysis by an the QoSAP of data stored at the SP.
- Survey of relevant customers.

6.3.3.2 Trigger points

Table 16: P303 trigger points

Event	Trigger point from customer's point of view	Condition
Provisioning period is announced by SP after contract is concluded	Start: t_1 in figure 9b	Contract is signed
Successful provisioning within time period specified by provider	Stop: t_4 in figure 9b	Provisioning is done before announced period ends at t_4 in figure 9b
Unsuccessful or too late provisioning within time period specified by provider	Stop: t_4 in figure 9b	Provisioning is not done before announced period ends at t_4 in figure 9b

6.3.3.3 Accuracy of indicator (metric of measure)

If the service provisioning takes place without a previous announcement by the SP, the date mentioned in the contract should be considered instead.

6.3.3.4 Representativeness

The parameter can be applied to any customer group of interest (e.g. customer segments or the whole customer population of a SP).

6.3.3.5 Presentation of parameter values

Although the basic parameter delivers a single percentage, it is expected to be processed on a regular basis so that higher aggregations of this parameter, depending on the sample size per assessed customer segment, can be represented in terms of:

- Histograms.
- Probability Distribution Function (PDF).
- Cumulative Distribution Function (CDF).
- Quantile values.

Results should be provided on a regular basis with a clear indication on the panel composition (if relevant) and size or/and volume of SP data reviewed.

A chart can be used to display the results for the various types of services.

6.3.4 P304: Contract cancelled due to non fulfilment [%]

6.3.4.1 Evaluation specific description

The expected amount of available data for this parameter may be low. Therefore, a panel of experts should assess the customer's situation.

Precondition: Provisioning done.

6.3.4.2 Trigger points

Table 17: P304 trigger points

Event	Trigger point from customer's point of view	Condition
Provisioning date is announced	Start: A) Fixed date: t_1 in figure 9a B) Period: t_1 in figure 9b	Customer is informed about date or period of provisioning
Non-fulfilment of contract	Stop: A) Fixed date: after promised provisioning date in figure 9a B) Period: after t_4 in figure 9b	Customer decides that the SP is not able or is not willing to fulfil the contract as agreed before and cancels the contract
Fulfilment of contract	Stop: A) Fixed date: t_2 in figure 9a B) Period: t_3 in figure 9b	Contract is fully and in-time fulfilled

6.3.4.3 Accuracy of indicator (metric of measure)

The accuracy of the indicator depends heavily on the subjective perception of the customers which cancel their contracts. E.g. depending on their knowledge of technology, they may cancel their contracts sooner or later.

6.3.4.4 Representativeness

Due to low numbers of expected samples, all cancelled customer contracts should be taken into account. A segmentation of customers is only recommended, if the sample numbers per segment allow the calculation of according statistical measures.

6.3.4.5 Presentation of parameter values

Although the basic parameter delivers a single percentage, it is expected to be processed on a regular basis so that higher aggregations of this parameter, depending on the sample size of the customer panel, can be represented in terms of:

- Histograms.
- Boxplots.

6.3.5 P305: Completeness of fulfilment of contractual specification in the provision of a service [%]

6.3.5.1 Evaluation specific description

Precondition: Provisioning done.

This parameter should not be related to time. Whenever a service provisioning event occurs, the parameter can be calculated, independent of the fact if the event occurs too late.

Since the completeness of fulfilment is related the expectations that customers have, there are two ways of assessing this parameter:

- Analysis by a panel of experts of a sample of contracts.
- Survey of customers.

The audit results based on expert knowledge should be adjusted to the customers' expectations.

6.3.5.2 Trigger points

Table 18: P305 trigger points

Event	Trigger point from customer's point of view	Condition
Provisioning done	Start/Stop: A. Fixed date: t_2 in figure 9a B. Period: t_3 in figure 9b	Service provisioning is done. It does not matter if in time, too early or too late

6.3.5.3 Accuracy of indicator (metric of measure)

Refer to accuracy of indicator in clause 4.3.4.

6.3.5.4 Representativeness

The parameter can be applied to any customer group of interest (e.g. customer segments or the whole customer population of a SP).

6.3.5.5 Presentation of parameter values

Results should be provided with an indication whether they are obtained from audits carried out by experts or from customer interrogations. As far as possible an indication of the breakdown of the causes for failed fulfilment should be given.

Results should be provided on a regular basis (Boxplots) with a clear indication on the panel composition and size or/and volume of SP data reviewed.

6.3.6 P306: Punctuality of service provisioning [Time]

6.3.6.1 Evaluation specific description

Precondition: Appointment planned and achieved.

There are two ways of assessing this parameter:

- Analysis by a panel of experts of a sample of contracts.
- Survey of customers.

The audit results based on expert knowledge should be adjusted to the customers' expectations.

This parameter can be deployed in both scenarios: the one for a fixed provisioning date and the one for a provisioning period. In the former case the time difference between $t_{1,i}$ and $t_{2,i}$ is relevant, whereas in the latter case the time difference between $t_{2,i}$ and $t_{3,i}$ is the correct one.

6.3.6.2 Trigger points

Table 19: P306 trigger points

Event	Trigger point from customer's point of view	Condition
Date of announced service provisioning arrives	Start: a) Fixed date: Service provisioning is expected on the same day. t_1 in figure 10 is equal to arrival of promised date in figure 9a b) Period: Service provisioning is expected at the appointed point of time. t_1 in figure 10 is equal to t_2 in figure 9b	a) Provisioning date reached b) Appointment point of time reached
Service provisioning is done	Stop: a) Fixed date: t_2 in figure 10 is equal to t_2 in figure 9a b) Period: t_2 in figure 10 is equal to t_3 in figure 9b	Successful and completed provisioning within time period specified by provider
Service provisioning is not done	Stop: a) Fixed date: t_2 in figure 10 does not occur b) Period: t_2 in figure 10 is equal to t_3 in figure 9b; t_2 does not occur or is later than t_4 in figure 9b	No provisioning or too late provisioning

6.3.6.3 Accuracy of indicator (metric of measure)

Precondition: Appointment planned and achieved.

Refer to accuracy of indicator in clause 4.3.4.

6.3.6.4 Representativeness

The parameter can be applied to any customer group of interest (e.g. customer segments or the whole customer population of a SP).

6.3.6.5 Presentation of parameter values

Depending on the sample size per assessed customer segment, these presentations are recommended:

- Histograms.
- Probability Distribution Function (PDF).
- Cumulative Distribution Function (CDF).
- Quantile values.

Results should be provided on a regular basis (Boxplots) with a clear indication on the panel composition and size or/and volume of SP data reviewed.

A chart can be used to display the results for the various types of services.

6.3.7 P307: Punctuality of equipment delivery for service provisioning [Time]

6.3.7.1 Evaluation specific description

Precondition: Appointment made or equipment delivery announced.

Evaluation of this parameter can be achieved by:

- Analysis by an the QoSAP of data stored at the SP.
- Survey of relevant customers.

6.3.7.2 Trigger points

Table 20: P307 trigger points

Event	Trigger point from customer's point of view	Condition
Date of announced equipment delivery arrives	Start: t_1 in figure 10	Equipment delivery is expected
Equipment delivery is done	Stop: t_2 in figure 10	Equipment arrives at customer's premises

6.3.7.3 Accuracy of indicator (metric of measure)

Refer to accuracy of indicator in clause 4.3.4.

6.3.7.4 Representativeness

The parameter can be applied to any customer group of interest (e.g. customer segments or the whole customer population of a SP).

6.3.7.5 Presentation of parameter values

Depending on the sample size per assessed customer segment, these presentations are recommended:

- Histograms.
- Probability Distribution Function (PDF).
- Cumulative Distribution Function (CDF).
- Quantile values.

Results should be provided on a regular basis with a clear indication on the panel composition and size or/and volume of SP data reviewed.

A chart can be used to display the results for the various types of services.

6.3.8 P308: Provisioning not complete and correct first time [%]

6.3.8.1 Evaluation specific description

Precondition: Provisioning done.

There are two ways of assessing this parameter:

- Analysis by a panel of experts of a sample of contracts or of data stored at the SP (in particular to check if the provisioning is complete or not).
- Survey of customers.

The audit results based on expert knowledge should be adjusted to the customers' expectations.

The stop triggers used here are related to the first provisioning attempt! Subsequent attempts are not applicable for this parameter.

6.3.8.2 Trigger points

Table 21: P308 trigger points

Event	Trigger point from customer's point of view	Condition
Provisioning is done	Start/Stop: a) Fixed date: t_2 in figure 9a b) Period: t_3 in figure 9b	The stop triggers used here are related to the first provisioning attempt! Subsequent attempts are not applicable for this parameter

6.3.8.3 Accuracy of indicator (metric of measure)

Refer to accuracy of indicator in clause 4.3.4.

6.3.8.4 Representativeness

The parameter can be applied to any customer group of interest (e.g. customer segments or the whole customer population of a SP).

6.3.8.5 Presentation of parameter values

Although the basic parameter delivers a single percentage, it is expected to be processed on a regular basis (Boxplots) so that higher aggregations of this parameter, depending on the sample size per assessed customer segment, can be represented in terms of:

- Histograms.
- Probability Distribution Function (PDF).
- Cumulative Distribution Function (CDF).
- Quantile values.

Results should be provided on a regular basis with a clear indication on the panel composition and size or/and volume of SP data reviewed.

A chart can be used to display the results for the various types of services.

6.4 Customer Relationship Stage: Service alteration

6.4.1 P401: Time for alteration [Time]

6.4.1.1 Evaluation specific description

Precondition: Alteration period received.

The customer population who have had service alterations carried out in the recent past may be surveyed.

Where the customer population is manageable a 100 % of the population may be surveyed. Where the number is large, a sample reflecting the population profile may be surveyed.

Evaluation of this parameter can be achieved by:

- Analysis by the QoSAP of data stored at the SP.
- Survey of relevant customers.

6.4.1.2 Trigger points

Table 22: P401 trigger points

Event	Trigger point from customer's point of view	Condition
Date of service alteration is announced by SP	Start: t_1 in figure 11	
Service alteration takes place	Stop: t_3 in figure 11	
Alteration period expired	Stop: t_4 in figure 11	Timeout condition

6.4.1.3 Accuracy of indicator (metric of measure)

The accuracy of this indicator depends on the number of samples used for evaluation. The higher the number of samples, the higher the accuracy of results. More information available in TS 102 250-6 [i.9].

6.4.1.4 Representativeness

The parameter can be applied to any customer group of interest (e.g. customer segments or the whole customer population of a SP).

6.4.1.5 Presentation of parameter values

Depending on the sample size per assessed customer segment, these presentations are recommended:

- Histograms.
- Probability Distribution Function (PDF).
- Cumulative Distribution Function (CDF).
- Quantile values.

Results should be provided on a regular basis (Boxplots) with a clear indication where the data come from (panel composition and size or SP data).

A chart can be used to display the results for the various customer segments.

6.4.2 P402: Successful service alteration within specified period [%]

6.4.2.1 Evaluation specific description

Precondition: Alteration period received by customer.

Preferably the customer population who have had service alterations carried out in the recent past is surveyed.

Evaluation of this parameter can be achieved by:

- Analysis by the QoSAPof data stored at the SP.
- Survey of relevant customers.

6.4.2.2 Trigger points

Table 23: P402 trigger points

Event	Trigger point from customer's point of view	Condition
Alteration period is announced by SP	Start: t_1 in figure 11	Announcement received
Successful alteration within time period specified by provider	Stop: t_4 in figure 11	Provisioning is done before announced period ends at t_4 in figure 11
Unsuccessful or too late alteration within time period specified by provider	Stop: t_4 in figure 11	Provisioning is not done before announced period ends at t_4 in figure 11

6.4.2.3 Accuracy of indicator (metric of measure)

The accuracy of this indicator depends on the number of samples used for evaluation. The higher the number of samples, the higher the accuracy of results. More information available in TS 102 250-6 [i.9].

6.4.2.4 Representativeness

The parameter can be applied to any customer group of interest (e.g. customer segments or the whole customer population of a SP).

6.4.2.5 Presentation of parameter values

Although the basic parameter delivers a single percentage, it is expected to be processed on a regular basis so that higher aggregations of this parameter, depending on the sample size per assessed customer segment, can be represented in terms of:

- Histograms.
- Probability Distribution Function (PDF).
- Cumulative Distribution Function (CDF).
- Quantile values.

Results should be provided on a regular basis (Boxplots) with a clear indication where the data come from (panel composition and size or SP data).

A chart can be used to display the results for the various types of services.

6.4.3 P403: Completeness of fulfilment of contractual specification in the alteration of a service [%]

6.4.3.1 Evaluation specific description

Precondition: Alteration done.

The customer population who have had service alterations carried out in the recent past may be surveyed. Evaluation of this parameter can be achieved by:

- Analysis by the QoSAP of data stored at the SP.
- Survey of relevant customers.

6.4.3.2 Trigger points

Table 24: P403 trigger points

Event	Trigger point from customer's point of view	Condition
Service alteration done	Start/Stop: t_3 in figure 11	Service alteration is done. It does not matter if this happens in time!

6.4.3.3 Accuracy of indicator (metric of measure)

Refer to accuracy of indicator in clause 4.3.4.

6.4.3.4 Representativeness

The parameter can be applied to any customer group of interest (e.g. customer segments or the whole customer population of a SP).

6.4.3.5 Presentation of parameter values

Although the basic parameter delivers a single percentage, it is expected to be processed on a regular basis so that higher aggregations of this parameter, depending on the sample size per assessed customer segment, can be represented in terms of:

- Histograms.
- Probability Distribution Function (PDF).
- Cumulative Distribution Function (CDF).
- Quantile values.

Results should be provided on a regular basis (Boxplots) with a clear indication where the data come from (panel composition and size or SP data).

A chart can be used to display the results for the various types of services.

6.4.4 P404: Punctuality of appointments for service alteration [Time]

6.4.4.1 Evaluation specific description

Precondition: Appointment planned and achieved.

The customer population who have had service alterations carried out in the recent past may be surveyed. Evaluation of this parameter can be achieved by:

- Analysis by the QoSAP of data stored at the SP.
- Survey of relevant customers.

6.4.4.2 Trigger points

Table 25: P404 trigger points

Event	Trigger point from customer's point of view	Condition
Date of announced alteration arrives	Start: t_2 in figure 11 resp. t_2 in figure 12	Appointment point of date reached
Alteration is done	Stop: t_3 in figure 11 resp. t_3 in figure 12	Successful and completed alteration within time period specified by provider
Alteration is not done	Stop: t_3 in figure 11 resp. t_3 in figure 12 does not occur or is later than t_4 in figure 11	No alteration or too late alteration

6.4.4.3 Accuracy of indicator (metric of measure)

Refer to accuracy of indicator in clause 4.3.4.

6.4.4.4 Representativeness

The parameter can be applied to any customer group of interest (e.g. customer segments or the whole customer population of a SP).

6.4.4.5 Presentation of parameter values

Depending on the sample size per assessed customer segment, these presentations are recommended:

- Histograms.
- Probability Distribution Function (PDF).
- Cumulative Distribution Function (CDF).
- Quantile values.

Results should be provided on a regular basis (Boxplots) with a clear indication where the data come from (panel composition and size or SP data).

A chart can be used to display the results for the various types of services.

6.4.5 P405: Punctuality of equipment delivery for service alteration [Time]

6.4.5.1 Evaluation specific description

Precondition: Appointment planned and achieved.

The customer population who have had service alterations carried out in the recent past may be surveyed. Evaluation of this parameter can be achieved by:

- Analysis by the QoSAP of data stored at the SP.
- Survey of relevant customers.

6.4.5.2 Trigger points

Table 26: P405 trigger points

Event	Trigger point from customer's point of view	Condition
Date of announced equipment delivery arrives	Start: t_2 in figure 11 resp. t_2 in figure 12	Appointment point of date reached
Equipment is delivered	Stop: t_3 in figure 11 resp. t_3 in figure 12	Successful and completed equipment delivery within time period specified by provider
Equipment is not delivered	Stop: t_3 in figure 11 resp. t_3 in figure 12 does not occur or is later than t_4 in figure 11	No equipment delivery or too late equipment delivery

6.4.5.3 Accuracy of indicator (metric of measure)

Refer to accuracy of indicator in clause 4.3.4.

6.4.5.4 Representativeness

The parameter can be applied to any customer group of interest (e.g. customer segments or the whole customer population of a SP).

6.4.5.5 Presentation of parameter values

Depending on the sample size per assessed customer segment, these presentations are recommended:

- Histograms.
- Probability Distribution Function (PDF).
- Cumulative Distribution Function (CDF).
- Quantile values.

Results should be provided on a regular basis (Boxplots) with a clear indication where the data come from (panel composition and size or SP data).

A chart can be used to display the results for the various types of services.

6.4.6 P406: Service alteration not complete and correct first time [%]

6.4.6.1 Evaluation specific description

Precondition: Alteration done.

The customer population who have had service alterations carried out in the recent past may be surveyed. The stop triggers used here are related to the first provisioning attempt! Subsequent attempts are not applicable for this parameter.

Evaluation of this parameter can be achieved by:

- Analysis by the QoSAP of data stored at the SP.
- Survey of relevant customers.

6.4.6.2 Trigger points

Table 27: P406 trigger points

Event	Trigger point from customer's point of view	Condition
Alteration is done	Start/Stop: t_3 in figure 11	The stop trigger used here is related to the first alteration attempt! Subsequent attempts are not applicable for this parameter

6.4.6.3 Accuracy of indicator (metric of measure)

Refer to accuracy of indicator in clause 4.3.4.

6.4.6.4 Representativeness

The parameter can be applied to any customer group of interest (e.g. customer segments or the whole customer population of a SP).

6.4.6.5 Presentation of parameter values

Although the basic parameter delivers a single percentage, it is expected to be processed on a regular basis so that higher aggregations of this parameter, depending on the sample size per assessed customer segment, can be represented in terms of:

- Histograms.
- Probability Distribution Function (PDF).
- Cumulative Distribution Function (CDF).
- Quantile values.

Results should be provided on a regular basis (Boxplots) with a clear indication where the data come from (panel composition and size or SP data).

A chart can be used to display the results for the various types of services.

6.4.7 P407: Conformity and success of service alteration [%]

6.4.7.1 Evaluation specific description

Precondition: Alteration done.

The calculation of this parameter is done by aggregation of the underlying parameters (see clause 5.4.7.1). It is not necessary to calculate this parameter on a "per event" basis.

6.4.7.2 Trigger points

Table 28: P407 trigger points

Event	Trigger point from customer's point of view	Condition
Alteration is done	Start/Stop: t_3 in figure 11	Alteration event occurs before or at t_4 in figure 11

6.4.7.3 Accuracy of indicator (metric of measure)

Refer to accuracy of indicator in clause 4.3.4.

6.4.7.4 Representativeness

The parameter can be applied to any customer group of interest (e.g. customer segments or the whole customer population of a SP). This parameter depends on P402 and P403.

6.4.7.5 Presentation of parameter values

Although the basic parameter delivers a single percentage, it is expected to be processed on a regular basis so that higher aggregations of this parameter, depending on the sample size per assessed customer segment, can be represented in terms of:

- Histograms.
- Probability Distribution Function (PDF).
- Cumulative Distribution Function (CDF).
- Quantile values.

Results should be provided on a regular basis (Boxplots) according to the assessment of P402 and P403.

A chart can be used to display the results for the various types of services.

6.4.8 P408: Technical reliability of service within an agreed period after alteration [%]

6.4.8.1 Evaluation specific description

Precondition: Alteration done.

The customer population who have had service alterations carried out in the recent past is surveyed. Evaluation of this parameter can be achieved by:

- Survey of relevant customers.
- Analysis by a panel of experts of data stored at SP.

6.4.8.2 Trigger points

Table 29: P408 trigger points

Event	Trigger point from customer's point of view	Condition
Reliability period has gone by	Start/Stop: t_3 n figure 11	No service restrictions have been observed within reliability period

6.4.8.3 Accuracy of indicator (metric of measure)

Refer to accuracy of indicator in clause 4.3.4.

6.4.8.4 Representativeness

The parameter can be applied to any customer group of interest (e.g. customer segments or the whole customer population of a SP).

6.4.8.5 Presentation of parameter values

Although the basic parameter delivers a single percentage, it is expected to be processed on a regular basis so that higher aggregations of this parameter, depending on the sample size per assessed customer segment, can be represented in terms of:

- Histograms.
- Probability Distribution Function (PDF).
- Cumulative Distribution Function (CDF).
- Quantile values.

Results should be provided on a regular basis (Boxplots) with a clear indication on the panel composition and size or/and volume of SP data reviewed.

A chart can be used to display the results for the various types of services.

6.4.9 P409: Response time of the alteration service [Time & %]

6.4.9.1 Evaluation specific description

The customer population who have had service alterations carried out in the recent past may be surveyed. Evaluation of this parameter can be achieved by:

- Analysis by the QoSAP of data stored at the SP.
- Survey of relevant customers.
- Analysis by a panel of experts of a sample of contracts.

6.4.9.2 Trigger points

Table 30: P409 trigger points

Event	Trigger point from customer's point of view	Condition
Reliability period has gone by	Start/Stop: t_5 in figure 11	No service restrictions have been observed within reliability period

6.4.9.3 Accuracy of indicator (metric of measure)

Refer to accuracy of indicator in clause 4.3.4.

6.4.9.4 Representativeness

The parameter can be applied to any customer group of interest (e.g. customer segments or the whole customer population of a SP).

6.4.9.5 Presentation of parameter values

Although the basic parameter delivers a single percentage, it is expected to be processed on a regular basis so that higher aggregations of this parameter, depending on the sample size per assessed customer segment, can be represented in terms of:

- Histograms.
- Probability Distribution Function (PDF).

- Cumulative Distribution Function (CDF).
- Quantile values.

Results should be provided on a regular basis (Boxplots) with a clear indication where the data come from (panel composition and size or SP data).

A chart can be used to display the results for the various types of services.

6.4.10 P412: Organisational efficiency of service provider to carry out service alteration (SPO) [OR]

6.4.10.1 Evaluation specific description

The customer population who have had service alterations carried out in the recent past may be surveyed. Evaluation of this parameter can be achieved by:

- Survey of relevant customers.
- Analysis of SP data by a panel of experts. It may be necessary for them to obtain relevant data, where available, from the SP and make an informed judgement in other cases to arrive at an OR value.

6.4.10.2 Trigger points

Table 31: P412 trigger points

Event	Trigger point from customer's point of view	Condition
	Start: Beginning of offering services by SP	
	Stop: Cessation of offering services by SP	

6.4.10.3 Accuracy of indicator (metric of measure)

The accuracy of this indicator depends on the manning of the panel. The more opinions are gathered within the OR, the more accurate the overall result will be. For more information on this, see clause 4.

6.4.10.4 Representativeness

Not applicable as the organisational efficiency is assessed from all customer's viewpoint.

6.4.10.5 Presentation of parameter values

The following should be published:

- Opinion rating of the panel should be presented with an indication on the distribution of the members' individual scores taking into account the various types of services.
- Sample size.

Results should be provided on a regular basis with a clear indication where the data come from (panel composition and size or SP data).

A chart can be used to display the results for the various types of services.

6.5 Customer Relationship Stage: Technical upgrade

6.5.1 P501: Time for technical upgrade of a service [Time]

6.5.1.1 Evaluation specific description

Precondition: Upgrade period received.

The customer population who have had technical upgrades carried out in the recent past may be surveyed. Evaluation of this parameter can be achieved by:

- Analysis by the QoSAP of data stored at the SP.
- Direct interrogation of relevant customers.

6.5.1.2 Trigger points

Table 32: P501 trigger points

Event	Trigger point from customer's point of view	Condition
Date of technical upgrade is announced by SP	Start: t_1 in figure 13	
Technical upgrade takes place	Stop: t_3 in figure 13	
Alteration period expired	Stop: t_4 in figure 13	Timeout condition

6.5.1.3 Accuracy of indicator (metric of measure)

Refer to accuracy of indicator in clause 4.3.4.

6.5.1.4 Representativeness

The parameter can be applied to any customer group of interest (e.g. customer segments or the whole customer population of a SP).

6.5.1.5 Presentation of parameter values

Depending on the sample size per assessed customer segment, these presentations are recommended:

- Histograms.
- Probability Distribution Function (PDF).
- Cumulative Distribution Function (CDF).
- Quantile values.

Results should be provided on a regular basis with a clear indication where the data come from (panel composition and size or SP data).

A chart can be used to display the results for the various types of services.

6.5.2 P502: Successful technical upgrade within a specified period [%]

6.5.2.1 Evaluation specific description

Precondition: Upgrade period received.

Preferably the customer population who have had technical upgrades carried out in the recent past is surveyed. Evaluation of this parameter can be achieved by:

- Analysis by the QoSAP of data stored at the SP.
- Survey of relevant customers.

6.5.2.2 Trigger points

Table 33: P502 trigger points

Event	Trigger point from customer's point of view	Condition
Upgrade period is announced by SP	Start: t_1 in figure 13	Announcement received
Successful upgrade within time period specified by provider	Stop: t_4 in figure 13	Provisioning is done before announced period ends at t_4 in figure 13
Unsuccessful or too late upgrade within time period specified by provider	Stop: t_4 in figure 13	Provisioning is not done before announced period ends at t_4 in figure 13

6.5.2.3 Accuracy of indicator (metric of measure)

The accuracy of this indicator depends on the number of samples used for evaluation. The higher the number of samples, the higher the accuracy of results. More information available in TS 102 250-6 [i.9].

6.5.2.4 Representativeness

The parameter can be applied to any customer group of interest (e.g. customer segments or the whole customer population of a SP).

6.5.2.5 Presentation of parameter values

Although the basic parameter delivers a single percentage, it is expected to be processed on a regular basis so that higher aggregations of this parameter, depending on the sample size per assessed customer segment, can be represented in terms of:

- Histograms.
- Probability Distribution Function (PDF).
- Cumulative Distribution Function (CDF).
- Quantile values.

Results should be provided on a regular basis (Boxplots) with a clear indication where the data come from (panel composition and size or SP data).

A chart can be used to display the results for the various types of services.

6.5.3 P503: Completeness of fulfilment of specification in the technical upgrade of a service [%]

6.5.3.1 Evaluation specific description

Precondition: outage ends.

The customer population who have had technical upgrades carried out in the recent past may be surveyed. Evaluation of this parameter can be achieved by:

- Analysis by the QoSAP of data stored at the SP.
- Survey of relevant customers.

6.5.3.2 Trigger points

Table 34: P503 trigger points

Event	Trigger point from customer's point of view	Condition
Technical upgrade done	Start/Stop: t_3 in figure 13	Technical upgrade is done. It does not matter if this happens in time!

6.5.3.3 Accuracy of indicator (metric of measure)

Refer to accuracy of indicator in clause 4.3.4.

6.5.3.4 Representativeness

The parameter can be applied to any customer group of interest (e.g. customer segments or the whole customer population of a SP).

6.5.3.5 Presentation of parameter values

Although the basic parameter delivers a single percentage, it is expected to be processed on a regular basis so that higher aggregations of this parameter, depending on the sample size per assessed customer segment, can be represented in terms of:

- Histograms.
- Probability Distribution Function (PDF).
- Cumulative Distribution Function (CDF).
- Quantile values.

Results should be provided on a regular basis (Boxplots) with a clear indication where the data come from (panel composition and size or SP data).

A chart can be used to display the results for the various types of services.

6.5.4 P504: Punctuality of appointments for technical upgrade [Time]

6.5.4.1 Evaluation specific description

Precondition: Appointment planned and achieved.

Preferably the customer population who have had technical upgrades carried out in the recent past is surveyed. Evaluation of this parameter can be achieved by:

- Analysis by the QoSAP of data stored at the SP.
- Survey of relevant customers.

6.5.4.2 Trigger points

Table 35: P504 trigger points

Event	Trigger point from customer's point of view	Condition
Date of announced technical upgrade arrives	Start: t_2 in figure 13 resp. t_2 in figure 14	Appointment point of date reached
Technical upgrade is done	Stop: t_3 in figure 13 resp. t_3 in figure 14	Successful and completed upgrade within time period specified by provider
Technical upgrade is not done	Stop: t_3 in figure 13 resp. t_3 in figure 14 do not occur or are later than t_4 in figure 13	No upgrade or too late upgrade

6.5.4.3 Accuracy of indicator (metric of measure)

Refer to accuracy of indicator in clause 4.3.4.

6.5.4.4 Representativeness

The parameter can be applied to any customer group of interest (e.g. customer segments or the whole customer population of a SP).

6.5.4.5 Presentation of parameter values

Depending on the sample size per assessed customer segment, these presentations are recommended:

- Histograms.
- Probability Distribution Function (PDF).
- Cumulative Distribution Function (CDF).
- Quantile values.

Results should be provided on a regular basis (Boxplots) with a clear indication where the data come from (panel composition and size or SP data).

A chart can be used to display the results for the various types of services.

6.5.5 P505: Outage time due to technical upgrade [Time]

6.5.5.1 Evaluation specific description

Precondition: Upgrade done.

The customer population who have had technical upgrades carried out in the recent past may be surveyed. Evaluation of this parameter can be achieved by:

- Analysis by the QoSAP of data stored at the SP.
- Survey of relevant customers.

6.5.5.2 Trigger points

Table 36: P505 trigger points

Event	Trigger point from customer's point of view	Condition
Outage begins	Start: t_3 in figure 13	Technical upgrade procedure started and causes outage of service usage
Outage ends	Stop: t_5 in figure 13	Procedure is finished and service returns to normal operation

6.5.5.3 Accuracy of indicator (metric of measure)

Refer to accuracy of indicator in clause 4.3.4.

6.5.5.4 Representativeness

The parameter can be applied to any customer group of interest (e.g. customer segments or the whole customer population of a SP).

6.5.5.5 Presentation of parameter values

Depending on the sample size per assessed customer segment, these presentations are recommended:

- Histograms.
- Probability Distribution Function (PDF).
- Cumulative Distribution Function (CDF).
- Quantile values.

Results should be provided on a regular basis (Boxplots) with a clear indication where the data come from (panel composition and size or SP data).

A chart can be used to display the results for the various types of services.

6.5.6 P506: Technical upgrade not complete and correct first time [%]

6.5.6.1 Evaluation specific description

Precondition: Outage ends.

The customer population who have had technical upgrades carried out in the recent past may be surveyed. The stop triggers used here are related to the first provisioning attempt! Subsequent attempts are not applicable for this parameter.

Evaluation of this parameter can be achieved by:

- Analysis by the QoSAP of data stored at the SP.
- Survey of relevant customers.

6.5.6.2 Trigger points

Table 37: P506 trigger points

Event	Trigger point from customer's point of view	Condition
Technical upgrade is completed	Start/Stop: t_5 in figure 13	Technical upgrade is completely completed which means the outage period has already passed. The stop trigger used here is related to the first alteration attempt! Subsequent attempts are not applicable for this parameter

6.5.6.3 Accuracy of indicator (metric of measure)

Refer to accuracy of indicator in clause 4.3.4.

6.5.6.4 Representativeness

The parameter can be applied to any customer group of interest (e.g. customer segments or the whole customer population of a SP).

6.5.6.5 Presentation of parameter values

Although the basic parameter delivers a single percentage, it is expected to be processed on a regular basis so that higher aggregations of this parameter, depending on the sample size per assessed customer segment, can be represented in terms of:

- Histograms.
- Probability Distribution Function (PDF).
- Cumulative Distribution Function (CDF).
- Quantile values.

Results should be provided on a regular basis with a clear indication where the data come from (panel composition and size or SP data).

A chart can be used to display the results for the various types of services.

6.5.7 P507: Conformity and success of technical upgrade [%]

6.5.7.1 Evaluation specific description

Precondition: Outage ends.

The calculation of this parameter is done by aggregation of the underlying parameters. It is not necessary to calculate this parameter on a "per event" basis.

6.5.7.2 Trigger points

Table 38: P507 trigger points

Event	Trigger point from customer's point of view	Condition
Technical upgrade is done	Start/Stop: t_5 in figure 13	Technical upgrade event occurs before or at t_5 in figure 13. The customer perceives the start of the upgrade with the outage period. The end is recognized by the end of the outage period

6.5.7.3 Accuracy of indicator (metric of measure)

Refer to accuracy of indicator in clause 4.3.4.

6.5.7.4 Representativeness

The parameter can be applied to any customer group of interest (e.g. customer segments or the whole customer population of a SP).

6.5.7.5 Presentation of parameter values

Although the basic parameter delivers a single percentage, it is expected to be processed on a regular basis so that higher aggregations of this parameter, depending on the sample size per assessed customer segment, can be represented in terms of:

- Histograms.
- Probability Distribution Function (PDF).
- Cumulative Distribution Function (CDF).
- Quantile values.

Results should be provided on a regular basis (Boxplots) according to the assessment of P502 and P503.

6.5.8 P508: Technical reliability of service within an agreed period after technical upgrade [%]

6.5.8.1 Evaluation specific description

Precondition: Outage ends.

The customer population who have had technical upgrades carried out in the recent past may be surveyed. Evaluation of this parameter can be achieved by:

- Analysis by the QoSAP of data stored at the SP.
- Survey of relevant customers.

6.5.8.2 Trigger points

Table 39: P508 trigger points

Event	Trigger point from customer's point of view	Condition
Reliability period has gone by	Start/Stop: t_6 in figure 13	No service restrictions have been observed within reliability period

6.5.8.3 Accuracy of indicator (metric of measure)

Refer to accuracy of indicator in clause 4.3.4.

6.5.8.4 Representativeness

The parameter can be applied to any customer group of interest (e.g. customer segments or the whole customer population of a SP).

6.5.8.5 Presentation of parameter values

Although the basic parameter delivers a single percentage, it is expected to be processed on a regular basis so that higher aggregations of this parameter, depending on the sample size per assessed customer segment, can be represented in terms of:

- Histograms.
- Probability Distribution Function (PDF).
- Cumulative Distribution Function (CDF).
- Quantile values.

Results should be provided on a regular basis with a clear indication where the data come from (panel composition and size or SP data).

A chart can be used to display the results for the various types of services.

6.5.9 P512: Organisational efficiency of SP to carry out technical upgrade (SPO) [OR]

6.5.9.1 Evaluation specific description

Preferably, the customer population who have had technical upgrades carried out in the recent past is surveyed. Evaluation of this parameter can also be achieved by assessment of SP data by a panel of experts. It may be necessary for them to obtain relevant data, where available, from the SP and make an informed judgement in other cases to arrive at an OR value.

6.5.9.2 Trigger points

Table 40: P512 trigger points

Event	Trigger point from customer's point of view	Condition
	Start: Beginning of offering technical upgrade services by SP	
	Stop: Cessation of offering services by SP	

6.5.9.3 Accuracy of indicator (metric of measure)

The accuracy of this indicator depends on the manning of the panel. The more opinions are gathered within the OR, the more accurate the overall result will be. For more information on this, see clause 4.

6.5.9.4 Representativeness

Not applicable.

6.5.9.5 Presentation of parameter values

The following should be published:

- Opinion rating of the panel should be presented with an indication on the distribution of the members' individual scores taking into account the various types of services.
- Sample size.

Results should be provided on a regular basis with a clear indication where the data come from (panel composition and size or SP data).

6.5.10 P513: Competence and preparedness of SP for technical upgrade (SPO) [OR]

6.5.10.1 Evaluation specific description

Preferably the evaluation of this parameter is achieved by assessment of SP data by a panel of experts. They should be familiar with the relevant technologies in order to rate the SP competence and preparedness in offering new services. Information about SP and his roadmap can be taken into account.

6.5.10.2 Trigger points

Table 41: P513 trigger points

Event	Trigger point from customer's point of view	Condition
Upcoming new technologies		Information related to the deployment of new technologies is made available.

6.5.10.3 Accuracy of indicator (metric of measure)

The accuracy of this indicator depends on the manning of the panel. The more opinions are gathered within the OR, the more accurate the overall result will be. For more information on this, see clause 4.

6.5.10.4 Representativeness

The parameter can be applied to any customer group of interest (e.g. customer segments or the whole customer population of a SP).

6.5.10.5 Presentation of parameter values

Depending on the sample size per assessed customer segment, these presentations are recommended:

- Histograms.
- Probability Distribution Function (PDF).
- Cumulative Distribution Function (CDF).
- Quantile values.

Results should be provided on a regular basis with a clear indication where the data come from (panel composition and size or SP data).

6.6 Customer Relationship Stage: Service Support

6.6.1 Documentation

6.6.1.1 P611: Documentation delivery time [Time]

6.6.1.1.1 Evaluation specific description

Preferably, the customer population who have had documentation requested in the recent past is surveyed. Evaluation of this parameter can be achieved by:

- Analysis by the QoSAP of data stored at the SP.
- Survey of relevant customers.

Delay in providing the documentation is to be measured when such documentation is not provided at service provisioning.

Whenever time to provide documentation is being measured these could be grouped with the mode of provision of the documentation. Electronic provision of documentation, paper copies, web based documentation etc. could be classified as different modes.

Timeout condition: If no documentation delivery event occurs up to t_3 in figure 15, this parameter cannot be calculated.

6.6.1.1.2 Trigger points

The trigger points are t_1 and t_2 in the timeline diagram shown at the beginning of this stage (figure 15).

6.6.1.1.3 Accuracy of indicator (metric of measure)

Refer to accuracy of indicator in clause 4.3.4.

6.6.1.1.4 Representativeness

Each mode of provision of documentation should be monitored separately when there is a delay in supply of documentation.

6.6.1.1.5 Presentation of parameter values

Expressed in units of time, expressed as mean for each mode.

Depending on the sample size per assessed customer segment, these presentations are recommended:

- Histograms.
- Probability Distribution Function (PDF).
- Cumulative Distribution Function (CDF).
- Quantile values.

Results should be provided on a regular basis with a clear indication where the data come from (panel composition and size or SP data).

A chart can be used to display the results for the various available modes.

6.6.1.2 P612: Availability of documentation within specified period of time [%]

6.6.1.2.1 Evaluation specific description

Records of the SP should indicate the number of occasions the documentation was not provided during the specified time.

Where documentation is revised and updated a separate set of statistics similar to the main documentation may be made to apply.

A 100 % sample of the provisioning of service for the reporting period may be considered.

A customer survey may also be carried out (by a third party) to complement the SP's results.

6.6.1.2.2 Trigger points

The trigger point is the occurrence of t_3 . At this stage, those contracts where documentation was supplied would be noted. The actual time t_2 when documentation was delivered may also be noted for P 613.

Table 42: P612 trigger points

Event	Trigger point from customer's point of view	Condition
Service provided or a changes to the service	Start: t_1 in figure 15.	Changes can be: Provision of new services Changes in existing services
Documentation is received by customer	Stop: t_3 in figure 15.	The term "Documentation" comprises also the cases where the documentation is amended

6.6.1.2.3 Accuracy of indicator (metric of measure)

Not applicable.

6.6.1.2.4 Representativeness

As 100 % of the records is analyzed, the results are expected to be fully representative.

6.6.1.2.5 Presentation of parameter values

The results from the SP's records may be expressed as a percentage. The results from a customer survey may also be expressed in percentage.

6.6.1.3 P613: Integrity (correctness and completeness) of documentation [OR]

6.6.1.3.1 Evaluation specific description

Evaluation of documentation should be carried out by:

- A panel of experts qualified in studying documentation of ICT services. They would be expected to have technical expertise as well as ability to look at the documentation objectively from the customer's viewpoint.
- User's viewpoint may also be gathered where this is considered to add value to the opinion rating.

6.6.1.3.2 Trigger points

The evaluation will normally be carried out at the introduction of a service and whenever a new revision or addition is introduced.

Table 43: P613 trigger points

Event	Trigger point from customer's point of view	Condition
Documentation is received by customer	Start/Stop: t_2 in figure 15	

6.6.1.3.3 Accuracy of indicator (metric of measure)

The accuracy of this indicator depends on the manning of the panel. The more opinions are gathered within the OR, the more accurate the overall result will be. For more information on this, see clause 4.

6.6.1.3.4 Representativeness

As the evaluation will be carried out for the whole documentation available, the results are expected to be fully representative.

6.6.1.3.5 Presentation of parameter values

Opinion rating of the panels should be presented as the distribution of the members' individual scores with an indication on the results distribution with regard to the various types of services and on the breakdown of these results.

A chart can be used to display the results of the different available modes but more importantly for each mode should be given the range of the worse decile.

6.6.1.4 P614: Modes of documentation [Number]

6.6.1.4.1 Evaluation specific description

Number of modes in which documentation is available to the customer is compiled by the SP and verified by an expert panel.

6.6.1.4.2 Trigger points

Number of modes is compiled at the launch of a service and updated whenever a new mode is added. The trigger point would be launch of a service and subsequent additions to the modes.

6.6.1.4.3 Accuracy of indicator (metric of measure)

Not applicable.

6.6.1.4.4 Representativeness

As all the modes are taken into account, the results are expected to be fully representative.

6.6.1.4.5 Presentation of parameter values

The results are presented as the list and number of modes in which the documentation is available.

6.6.1.5 P615: Legibility of documentation [OR]

6.6.1.5.1 Evaluation specific description

The legibility is evaluated by an expert panel. It should evaluate the documentation for visual clarity, use of language and layout and allocate an OR value. The skills required for this evaluation are marketing (to evaluate visual clarity and layout), knowledge of language (in its standard form), technical expertise (to evaluate technical clarity) and an awareness of those with special needs where appropriate.

6.6.1.5.2 Trigger points

The opinion rating is carried out normally at the introduction of the documentation for the first time and subsequently when revision and/or amendment to it are carried out in a substantial form.

6.6.1.5.3 Accuracy of indicator (metric of measure)

The accuracy of this indicator depends on the manning level of the panel. The more opinions are gathered within the OR, the more accurate the overall result will be. For more information on this, see clause 4.

6.6.1.5.4 Representativeness

Not applicable.

6.6.1.5.5 Presentation of parameter values

Opinion rating of the panel should be presented as the distribution of the members' individual scores with an indication on the results distribution with regard to the various types of services and on the breakdown of these results. The mean value should be given as a synthetic indication.

A chart can be used to display the results of the different available modes but more importantly for each mode should be given the range of the worst decile.

6.6.1.6 P616: Overall reliability of documentation services [OR]

6.6.1.6.1 Evaluation specific description

The delivered performance of parameters 611 through 615 are reviewed by an expert panel over the reporting period and form an opinion rating for the overall reliability of the SP's quality of documentation services.

The opinion rating is intended to reflect the viewpoint of the customer and not make undue allowance to the difficulties of the SP.

A survey of customer's opinion rating for this parameter may also be sought. These data may also be published in parallel with the expert panel data.

6.6.1.6.2 Trigger points

The overall reliability of the document is assessed after time t_2 when the documentation is available.

6.6.1.6.3 Accuracy of indicator (metric of measure)

The accuracy of this indicator depends on the manning of the panel. The more opinions are gathered within the OR, the more accurate the overall result will be. For more information on this, see clause 4.

A qualitative judgment of the accuracy of the panel OR may be made by comparing the OR rating from the customer survey.

6.6.1.6.4 Representativeness

Not applicable.

6.6.1.6.5 Presentation of parameter values

Opinion rating of the panels should be presented as the distribution of the members' individual scores with an indication on the results distribution with regard to the various services and on the breakdown of these results. The mean value should be given as a synthetic indication.

Results should be provided on a regular basis according to the assessment of P611 through P615.

A chart can be used to display the results of the different available modes but more importantly for each mode should be given the range of the worse decile.

6.6.2 Technical support

6.6.2.1 P621: Accessibility of the technical support [%]

6.6.2.1.1 Evaluation specific description

Precondition: Problem occurred and accessibility data captured.

Evaluation of this parameter can be achieved by one or several of the following means:

- Analysis by the QoSAP of data stored at the SP.
- Survey of relevant customers (preferred scenario).
- Assessment by a panel of experts according to their own experience in contacting the technical support.

6.6.2.1.2 Trigger points

Table 44: P621 trigger points

Event	Trigger point from customer's point of view	Condition
Problem occurred, try to contact support	Start: t_1 in figure 16	Customer wants to access technical support after occurrence of problem
Contact established	Stop: t_2 in figure 16	Customer established contact to SP technical support
Timeout for accessing technical support reached	Stop: t_2' in figure 16	Timeout T62 for accessing technical support reached

6.6.2.1.3 Accuracy of indicator (metric of measure)

Refer to accuracy of indicator in clause 4.3.4.

6.6.2.1.4 Representativeness

The parameter can be applied to any customer group of interest (e.g. customer segments or the whole customer population of a SP).

6.6.2.1.5 Presentation of parameter values

Although the basic parameter delivers a single percentage, it is expected to be processed per hour so that the results are given with respect to the hour of the day, the day of the week, holiday time, etc. and higher aggregations of this parameter, depending on the sample size per assessed customer segment, can be represented in terms of:

- Histograms.
- Probability Distribution Function (PDF).
- Cumulative Distribution Function (CDF).

- Quantile values.

Results should be provided on a regular basis (Boxplots) with a clear indication where the data come from (panel composition and size or SP data).

A chart can be used to display the results for the various types of services.

6.6.2.2 P622: Technical solutions achieved within a specified period [%]

6.6.2.2.1 Evaluation specific description

Precondition: Problem description provided to service desk.

Evaluation of this parameter can be achieved by:

- Analysis by the QoSAP of data stored at the SP.
- Survey of relevant customers.
- Assessment by a panel of experts according to the information they got in contacting the technical support.

6.6.2.2.2 Trigger points

Table 45: P622 trigger points

Event	Trigger point from customer's point of view	Condition
Need for change described	Start: t_3 in figure 16	Customer described his needs to technical support
Timeout for accessing technical support reached	Stop: t_5 in figure 16	Timeout T_{63} for receiving solution proposal from SP technical support reached

6.6.2.2.3 Accuracy of indicator (metric of measure)

Refer to accuracy of indicator in clause 4.3.4.

6.6.2.2.4 Representativeness

The parameter can be applied to any customer group of interest (e.g. customer segments or the whole customer population of a SP).

6.6.2.2.5 Presentation of parameter values

Although the basic parameter delivers a single percentage, it is expected to be processed on a regular basis so that higher aggregations of this parameter, depending on the sample size per assessed customer segment, can be represented in terms of:

- Histograms.
- Probability Distribution Function (PDF).
- Cumulative Distribution Function (CDF).
- Quantile values.

Results should be provided on a regular basis (Boxplots) with a clear indication where the data come from (panel composition and size or SP data).

6.6.2.3 P623: Number of attempts before successful solution [Number]

6.6.2.3.1 Evaluation specific description

Precondition: Solution proposal applied.

Only after successful solution (i.e. outcome of P624) can this parameter be evaluated.

Evaluation of this parameter can be achieved by:

- Analysis by the QoSAP of data stored at the SP.
- Survey of relevant customers.

6.6.2.3.2 Trigger points

Table 46: P621 trigger points

Event	Trigger point from customer's point of view	Condition
Solution proposal applied	Start: t_5 in figure 16 in combination with a successful outcome of P624	SP solution proposal applied
End of specified analysis period	Stop: t_6 in figure 16	End of specified analysis period, covered by timeout T_{64}

6.6.2.3.3 Accuracy of indicator (metric of measure)

Refer to accuracy of indicator in clause 4.3.4.

6.6.2.3.4 Representativeness

The parameter can be applied to any customer group of interest (e.g. customer segments or the whole customer population of a SP).

6.6.2.3.5 Presentation of parameter values

Although the basic parameter delivers a single number, it is expected to be processed on a regular basis so that higher aggregations of this parameter, depending on the sample size per assessed customer segment, can be represented in terms of:

- Histograms.
- Probability Distribution Function (PDF).
- Cumulative Distribution Function (CDF).
- Quantile values.

Results should be provided on a regular basis (Boxplots) with a clear indication where the data come from (panel composition and size or SP data).

A chart can be used to display the results for the various types of services.

6.6.2.4 P624: Integrity of technical solutions [OR]

6.6.2.4.1 Evaluation specific description

Precondition: Solution proposal applied.

Evaluation of this parameter can be achieved by:

- Survey of relevant customers.
- Assessment by a panel of experts based on answers received from the SP to questions raised during the interview(s) described for P621.

It can be useful to take also advantage of an analysis by the QoSAP of data stored at the SP.

6.6.2.4.2 Trigger points

Table 47: P621 trigger points

Event	Trigger point from customer's point of view	Condition
Solution proposal applied	Start/Stop: t_5 in figure 16	SP solution proposal applied

6.6.2.4.3 Accuracy of indicator (metric of measure)

The accuracy of this indicator depends on the manning of the panel. The more opinions are gathered within the OR, the more accurate the overall result will be. For more information on this, see clause 4.

6.6.2.4.4 Representativeness

The parameter can be applied to any customer group of interest (e.g. customer segments or the whole customer population of a SP).

6.6.2.4.5 Presentation of parameter values

Depending on the sample size per assessed customer segment, these presentations are recommended:

- Histograms.
- Probability Distribution Function (PDF).
- Cumulative Distribution Function (CDF).
- Quantile values.

Results should be provided on a regular basis (Boxplots) with a clear indication where the data come from (panel composition and size or SP data).

A chart can be used to display the results for the various types of services.

6.6.2.5 P625: Reliability of technical solutions achieved [%]

6.6.2.5.1 Evaluation specific description

Precondition: Solution proposal applied.

Evaluation of this parameter can be achieved by:

- Analysis by the QoSAP of data stored at the SP.
- Survey of relevant customers.
- Assessment by a panel of experts based on answers received from the SP.

6.6.2.5.2 Trigger points

Table 48: P625 trigger points

Event	Trigger point from customer's point of view	Condition
Solution proposal applied	Start: t_5 in figure 16	SP solution proposal applied
End of specified analysis period	Stop: t_6 in figure 16	End of specified stability period, covered by timeout T_{64}

6.6.2.5.3 Accuracy of indicator (metric of measure)

Refer to accuracy of indicator in clause 4.3.4.

6.6.2.5.4 Representativeness

The parameter can be applied to any customer group of interest (e.g. customer segments or the whole customer population of a SP).

6.6.2.5.5 Presentation of parameter values

Although the basic parameter delivers a single percentage, it is expected to be processed on a regular basis so that higher aggregations of this parameter, depending on the sample size per assessed customer segment, can be represented in terms of:

- Histograms.
- Probability Distribution Function (PDF).
- Cumulative Distribution Function (CDF).
- Quantile values.

Results should be provided on a regular basis with a clear indication on the panel composition and size or/and volume of SP data reviewed.

A chart can be used to display the results for the various types of services.

6.6.2.6 P626: Modes of technical support [Number]

6.6.2.6.1 Evaluation specific description

Precondition: Solution proposal applied.

Evaluation of this parameter can be achieved by:

- Analysis by the QoSAP of data stored at the SP.
- Assessment by a panel of experts based on answers received from the SP.

6.6.2.6.2 Trigger points

Number of modes is compiled at the launch of a service and updated whenever a new mode is added. The trigger point would be launch of a service and subsequent additions to the modes.

6.6.2.6.3 Accuracy of indicator (metric of measure)

Not applicable.

6.6.2.6.4 Representativeness

The parameter can be applied to any customer group of interest (e.g. customer segments or the whole customer population of a SP).

6.6.2.6.5 Presentation of parameter values

The results are presented as the list and number of modes in which the technical support is available.

A chart can be used to display the results for the various types of services.

6.6.3 Commercial support

6.6.3.1 P641: Accessibility of the commercial support [%]

6.6.3.1.1 Evaluation specific description

Precondition: Need to contact the commercial support to get a reply to any commercial issue occurred.

Evaluation of this parameter can be achieved by:

- Analysis by the QoSAP of data stored at the SP.
- Survey of relevant customers (preferred scenario).
- Assessment by a panel of experts based on answers received from the SP.

6.6.3.1.2 Trigger points

Table 49: P641 trigger points

Event	Trigger point from customer's point of view	Condition
Need for contact occurred	Start: t_1 in figure 17	Customer accessing commercial support
Contact established	Stop: t_2 in figure 17	Customer established contact to SP commercial support
Timeout for accessing commercial support reached	Stop: t_2' in figure 17	Timeout T_{65} for accessing commercial support reached

6.6.3.1.3 Accuracy of indicator (metric of measure)

Refer to accuracy of indicator in clause 4.3.4.

6.6.3.1.4 Representativeness

The parameter can be applied to any customer group of interest (e.g. customer segments or the whole customer population of a SP).

6.6.3.1.5 Presentation of parameter values

Although the basic parameter delivers a single percentage, it is expected to be processed per hour so that the results are given with respect to the hour of the day, the day of the week, holiday time, etc. and higher aggregations of this parameter, depending on the sample size per assessed customer segment, can be represented in terms of:

- Histograms.
- Probability Distribution Function (PDF).
- Cumulative Distribution Function (CDF).

- Quantile values.

Results should be provided on a regular basis (Boxplots) with a clear indication where the data come from (panel composition and size or SP data).

A chart can be used to display the results for the various types of services.

6.6.3.2 P642: Commercial solution delivery time [Time]

6.6.3.2.1 Evaluation specific description

Precondition: Need for change described to commercial support.

Evaluation of this parameter can be achieved by:

- Analysis by the QoSAP of data stored at the SP.
- Survey of relevant customers.

6.6.3.2.2 Trigger points

Table 50: P642 trigger points

Event	Trigger point from customer's point of view	Condition
Need for change described to commercial support	Start: t_3 in figure 17	Customer described his needs to commercial support
Solution proposal received by customer from commercial support	Stop: t_4 in figure 17	Solution proposal received by customer
Timeout for accessing commercial support reached	Stop: t_5 in figure 17	Timeout T_{66} for receiving solution proposal from SP commercial support reached

6.6.3.2.3 Accuracy of indicator (metric of measure)

Refer to accuracy of indicator in clause 4.3.4.

6.6.3.2.4 Representativeness

The parameter can be applied to any customer group of interest (e.g. customer segments or the whole customer population of a SP).

6.6.3.2.5 Presentation of parameter values

Depending on the sample size per assessed customer segment, these presentations are recommended:

- Histograms.
- Probability Distribution Function (PDF).
- Cumulative Distribution Function (CDF).
- Quantile values.

Results should be provided on a regular basis (Boxplots) with a clear indication where the data come from (panel composition and size or SP data).

A chart should be used to display the results for the various types of services.

6.6.3.3 P643: Commercial solutions achieved within a specified period [%]

6.6.3.3.1 Evaluation specific description

Precondition: Need for change described to commercial support.

Evaluation of this parameter can be achieved by:

- Analysis by the QoSAP of data stored at the SP.
- Survey of relevant customers.
- Assessment by a panel of experts based on answers received from the SP.

6.6.3.3.2 Trigger points

Table 51: P643 trigger points

Event	Trigger point from customer's point of view	Condition
Need for change described	Start: t_3 in figure 17	Customer described his needs to commercial support
Timeout for accessing commercial support reached	Stop: t_5 in figure 17	Timeout T_{66} for receiving solution proposal from SP commercial support reached

6.6.3.3.3 Accuracy of indicator (metric of measure)

Refer to accuracy of indicator in clause 4.3.4.

6.6.3.3.4 Representativeness

The parameter can be applied to any customer group of interest (e.g. customer segments or the whole customer population of a SP).

6.6.3.3.5 Presentation of parameter values

Although the basic parameter delivers a single percentage, it is expected to be processed on a regular basis so that higher aggregations of this parameter, depending on the sample size per assessed customer segment, can be represented in terms of:

- Histograms.
- Probability Distribution Function (PDF).
- Cumulative Distribution Function (CDF).
- Quantile values.

Results should be provided on a regular basis (Boxplots) with a clear indication where the data come from (panel composition and size or SP data).

A chart can be used to display the results for the various types of services.

6.6.3.4 P644: Integrity of solution achieved by the SP [OR]

6.6.3.4.1 Evaluation specific description

Solution proposal received.

Evaluation of this parameter can be achieved by:

- Analysis by the QoSAP of data stored at the SP.
- Survey of relevant customers.
- Assessment by a panel of experts based on answers received from the SP.

6.6.3.4.2 Trigger points

Table 52: P644 trigger points

Event	Trigger point from customer's point of view	Condition
Solution proposal received	Start/Stop: t_4 in figure 17	Solution proposal received by customer

6.6.3.4.3 Accuracy of indicator (metric of measure)

The accuracy of this indicator depends on the manning of the panel. The more opinions are gathered within the OR, the more accurate the overall result will be. For more information on this, see clause 4.

6.6.3.4.4 Representativeness

The parameter can be applied to any customer group of interest (e.g. customer segments or the whole customer population of a SP).

6.6.3.4.5 Presentation of parameter values

Depending on the sample size per assessed customer segment, these presentations are recommended:

- Histograms.
- Probability Distribution Function (PDF).
- Cumulative Distribution Function (CDF).
- Quantile values.

Results should be provided on a regular basis (Boxplots) with a clear indication where the data come from (panel composition and size or SP data).

A chart can be used to display the results for the various types of services.

6.6.3.5 P645: Modes of commercial support [Number]

6.6.3.5.1 Evaluation specific description

Precondition: Solution proposal received.

Evaluation of this parameter can be achieved by:

- Analysis by the QoSAP of data stored at the SP.
- Assessment by a panel of experts based on answers received from the SP.

6.6.3.5.2 Trigger points

Number of modes is compiled at the launch of a service and updated whenever a new mode is added. The trigger point would be launch of a service and subsequent additions to the modes.

6.6.3.5.3 Accuracy of indicator (metric of measure)

Not applicable.

6.6.3.5.4 Representativeness

The parameter can be applied to any customer group of interest (e.g. customer segments or the whole customer population of a SP).

6.6.3.5.5 Presentation of parameter values

The results are presented as the list and number of modes in which the commercial support is available.

6.6.3.6 P652: Organisational efficiency of commercial support (SPO) [OR]

6.6.3.6.1 Evaluation specific description

Evaluation of this parameter can be achieved by:

- Survey of relevant customers.
- Assessment by a panel of experts. It may be necessary for them to obtain relevant data, where available, from the SP and make an informed judgement in other cases to arrive at an OR value.

6.6.3.6.2 Trigger points

Table 53: P652 trigger points

Event	Trigger point from customer's point of view	Condition
	Start: Beginning of offering commercial support services by the SP	
	Stop: Cessation of offering commercial support services by the SP	

6.6.3.6.3 Accuracy of indicator (metric of measure)

The accuracy of this indicator depends on the manning of the panel. The more opinions are gathered within the OR, the more accurate the overall result will be. For more information on this, see clause 4.

6.6.3.6.4 Representativeness

Not applicable.

6.6.3.6.5 Presentation of parameter values

The following should be published:

- Opinion rating of the panel should be presented with an indication on the distribution of the members' individual scores taking into account the various types of services.
- Sample size.

Results should be provided on a regular basis with a clear indication on the panel composition and size or/and volume of SP data reviewed.

6.6.4 Complaint management

6.6.4.1 P661: Accessibility of the complaint management desk [%]

6.6.4.1.1 Evaluation specific description

Precondition: Complaint reason occurred.

Evaluation of this parameter can be achieved by:

- Analysis by the QoSAP of data stored at the SP.
- Survey of relevant customers (preferred scenario).
- Assessment by a panel of experts according to their own experience in contacting the complaint management desk.

6.6.4.1.2 Trigger points

Table 54: P661 trigger points

Event	Trigger point from customer's point of view	Condition
Complaint filled	Start: t_1 in figure 18	Complaint reason occurred and customer wants to access complaint management
Complaint management contacted	Stop: t_2 in figure 18	Complaint management accessed by customer
Timeout for accessing the complaint management reached	Stop: t_2' in figure 18	Timeout T_{67} for accessing the complaint management reached

6.6.4.1.3 Accuracy of indicator (metric of measure)

Refer to accuracy of indicator in clause 4.3.4.

6.6.4.1.4 Representativeness

The parameter can be applied to any customer group of interest (e.g. customer segments or the whole customer population of a SP).

6.6.4.1.5 Presentation of parameter values

Although the basic parameter delivers a single percentage, it is expected to be processed per hour so that the results are given with respect to the hour of the day, the day of the week, holiday time, etc. and higher aggregations of this parameter, depending on the sample size per assessed customer segment, can be represented in terms of:

- Histograms.
- Probability Distribution Function (PDF).
- Cumulative Distribution Function (CDF).
- Quantile values.

Results should be provided on a regular basis with a clear indication on the panel composition and size or/and volume of SP data reviewed.

A chart can be used to display the results for the various types of services.

6.6.4.2 P662: Recognition of the customer complaints [%]

6.6.4.2.1 Evaluation specific description

Precondition: Complaint filed.

Evaluation of this parameter can be achieved by:

- Analysis by the QoSAP of data stored at the SP.
- Survey of relevant customers.
- Assessment by a panel of experts based on answers received from the SP.

6.6.4.2.2 Trigger points

Table 55: P662 trigger points

Event	Trigger point from customer's point of view	Condition
Complaint reason occurred	Start: t_3 in figure 18	Complaint reason occurred and customer wants to access complaint management
Complaint accepted	Stop: t_4 in figure 18	SP accepted customer's complaint
Timeout for complaint filed reached	Stop: t_4 in figure 18	Timeout T_{68} for accepting customer complaint by SP reached

6.6.4.2.3 Accuracy of indicator (metric of measure)

Refer to accuracy of indicator in clause 4.3.4.

6.6.4.2.4 Representativeness

The parameter can be applied to any customer group of interest (e.g. customer segments or the whole customer population of a SP).

6.6.4.2.5 Presentation of parameter values

Although the basic parameter delivers a single percentage, it is expected to be processed on a regular basis so that higher aggregations of this parameter, depending on the sample size per assessed customer segment, can be represented in terms of:

- Histograms.
- Probability Distribution Function (PDF).
- Cumulative Distribution Function (CDF).
- Quantile values.

Results should be provided on a regular basis with a clear indication on the panel composition and size or/and volume of SP data reviewed.

A chart can be used to display the results for the various types of services.

6.6.4.3 P663: Complaint solutions not complete and correct first time [%]

6.6.4.3.1 Evaluation specific description

Precondition: Complaint filed.

Evaluation of this parameter can be achieved by:

- Analysis by the QoSAP of data stored at the SP.
- Survey of relevant customers.

6.6.4.3.2 Trigger points

Table 56: P621 trigger points

Event	Trigger point from customer's point of view	Condition
Complaint reason occurred	Start: t_3 in figure 18	Complaint reason occurred and customer wants to access complaint management
Complaint accepted	Stop: t_4 in figure 18	SP accepted customers complaint
Timeout for complaint filed reached	Stop: t_4 in figure 18	Timeout T_{68} for accepting customer complaint by SP reached

6.6.4.3.3 Accuracy of indicator (metric of measure)

Refer to accuracy of indicator in clause 4.3.4.

6.6.4.3.4 Representativeness

The parameter can be applied to any customer group of interest (e.g. customer segments or the whole customer population of a SP).

6.6.4.3.5 Presentation of parameter values

Although the basic parameter delivers a single percentage, it is expected to be processed on a regular basis so that higher aggregations of this parameter, depending on the sample size per assessed customer segment, can be represented in terms of:

- Histograms.
- Probability Distribution Function (PDF).
- Cumulative Distribution Function (CDF).
- Quantile values.

Results should be provided on a regular basis with a clear indication on the panel composition and size or/and volume of SP data reviewed.

A chart can be used to display the results for the various types of services.

6.6.4.4 P664: Integrity of complaint resolution [%]

6.6.4.4.1 Evaluation specific description

Evaluation of performance values for this parameter requires both customer survey as well as objective figures from the SP on the number of complaints resolved to enable a panel of experts to provide a meaningful ratio. This is to ensure that customers are quite happy that the complaints have been resolved to their satisfaction.

6.6.4.4.2 Trigger points

The evaluation of the SP by the panel may be carried out once in a reporting period taking into account all complaints that have been deemed as resolved.

6.6.4.4.3 Accuracy of indicator (metric of measure)

There may be discrepancy between the findings of the customer survey and objective data from the SP. Where the difference is significant, reason for the discrepancy may be investigated.

6.6.4.4.4 Representativeness

Not applicable.

6.6.4.4.5 Presentation of parameter values

Parameter values may be expressed as a percentage based on the SP data as well as mean of the customer survey.

Results should be provided on a regular basis with a clear indication on the panel composition and size or/and volume of SP data reviewed.

A chart can be used to display the results for the various types of services.

6.6.4.5 P665: Customer perception of the complaint management [OR]

6.6.4.5.1 Evaluation specific description

Due to the highly subjective nature of this parameter it is necessary to carry out a survey among the customers to ascertain meaningful values for the parameter. The customers should have had the experience of making complaint and the process of its resolution. Recent complaints should be preferred for the survey.

In addition to the survey an expert panel may cross check the OR perceived by the customers by making appropriate enquiries.

Members of an expert panel may also wish to consider the delivered performance of parameters P661, P662, P663, and P664 over the reporting period in arriving at a OR score for the Integrity of the CM service offered by the SP.

Expertises required in the panel are cultural familiarity of the market in which the service is operating, knowledge of features of the service and a sound understanding of the psychological aspects of customer behaviour.

6.6.4.5.2 Trigger points

The evaluation of the SP by the panel may only be carried out after the complaint has been resolved to the satisfaction of the customer. This would be at t5 in the timeline diagram.

6.6.4.5.3 Accuracy of indicator (metric of measure)

The accuracy of this indicator depends on the manning of the panel. The more opinions are gathered within the OR, the more accurate the overall result will be. For more information on this, see clause 4.

There may be discrepancies between the findings of the customer survey and audit panel. Where the discrepancy is significant, reason for the discrepancy may be investigated and any necessary changes incorporated either to the panel's ratings or the way customer survey is carried out.

6.6.4.5.4 Representativeness

Complaints may be classified into four broad categories:

- Technical;
- Commercial;

- Billing and charging; and
- Other categories.

In each category separate panel assessments and customer surveys ought to be carried out.

6.6.4.5.5 Presentation of parameter values

Opinion rating may be expressed as the mean of the customer survey scores and separately those of the panel member's scores.

The following should be published:

- Opinion rating of the panel should be presented with an indication on the distribution of the members' individual scores.
- Sample and panel composition and size.

6.6.4.6 P666: Overall quality of the complaint management process [OR]

6.6.4.6.1 Evaluation specific description

Performance values or this parameter is recommended from customer surveys as well as opinion rating by an expert panel.

Members of an expert panel may consider the delivered performance of parameters P661, P663, and P664 over the reporting period in the formation of an opinion rating for the overall quality of the SP's CM service. The opinion rating is intended to reflect the viewpoint of the customer and not make undue allowance to the difficulties of the SP.

A survey of customer's opinion rating for this parameter may also be sought and may also be published in parallel with the panel member's OR.

6.6.4.6.2 Trigger points

Not applicable as customer survey and panel ratings are carried out on a historical basis.

6.6.4.6.3 Accuracy of indicator (metric of measure)

The accuracy of this indicator depends on the manning of the panel. The more opinions are gathered within the OR, the more accurate the overall result will be. For more information on this, see clause 4.

There may be discrepancy between the findings of the customer survey and audit panel. Where the difference is significant, reason for the discrepancy may be investigated and any necessary changes incorporated either to the panel's ratings or the way customer survey is carried out.

6.6.4.6.4 Representativeness

Not applicable.

6.6.4.6.5 Presentation of parameter values

The following should be published:

- Opinion rating of the panel should be presented with an indication on the distribution of the members' individual scores.
- Sample and panel composition and size.

6.6.4.7 P671: Organisational efficiency of complaint management system (SPO) [OR]

6.6.4.7.1 Evaluation specific description

In the evaluation of this parameter the following issues are to be addressed:

- 1) Handling of high volume of complaint requests.
- 2) Load rate of employees at the reception.
- 3) Load rate of the employees handling complaints.
- 4) Number of attempts before complaint is acknowledged.
- 5) Number of attempts before complaint is resolved.
- 6) Availability of necessary hardware for the CM system.
- 7) Logistics of the management of the CM system.

Preferably an expert panel carries out the task of evaluating the above issues. It may be necessary for them to obtain relevant data, where available, from the SP and make an informed judgement in other cases to arrive at an OR value. Additionally a customer survey may also be carried out to assess first hand customer's opinion.

6.6.4.7.2 Trigger points

Not applicable as customer survey and panel ratings are carried out on a historical basis.

6.6.4.7.3 Accuracy of indicator (metric of measure)

The accuracy of this indicator depends on the manning of the panel. The more opinions are gathered within the OR, the more accurate the overall result will be. For more information on this, see clause 4.

Possible discrepancy between the findings of the customer survey and audit panel should be dealt as explained in clause 4.2.

6.6.4.7.4 Representativeness

Not applicable.

6.6.4.7.5 Presentation of parameter values

Opinion rating of the panel should be presented with an indication on the distribution of the members' individual scores. The mean value should be given as a synthetic indication.

When a parallel customer survey is carried out their OR scores may also be provided.

Results should be provided on a regular basis with a clear indication on the panel composition and size.

Chart should be used to display the results for the hour of the day, day of the week, etc.

6.7 Customer Relationship Stage: Repair services

6.7.1 P701: Accessibility of repair services [%]

6.7.1.1 Evaluation specific description

Estimation of value for this parameter is dependent upon the records made available by the SP.

6.7.1.2 Trigger points

Trigger points do not apply as the parameter values are estimated from historical records.

6.7.1.3 Accuracy of indicator (metric of measure)

As 100 % of the records were analyzed, the results are expected to be fully representative.

6.7.1.4 Representativeness

As 100 % of the records are involved in the QoS assessment, the results are expected to be fully representative.

6.7.1.5 Presentation of parameter values

Although the basic parameter delivers a single percentage, it is expected to be processed per hour so that the results are given with respect to the hour of the day, the day of the week, holiday time, etc. and higher aggregations of this parameter, depending on the sample size per assessed customer segment, can be represented in terms of:

- Histograms.
- Probability Distribution Function (PDF).
- Cumulative Distribution Function (CDF).
- Quantile values.

Results should be provided on a regular basis with a clear indication on the volume of SP data reviewed.

A chart can be used to display the results for the various types of services.

6.7.2 P702: Successful repairs carried out within a specified period [%]

6.7.2.1 Evaluation specific description

Only repairs successfully completed at the first attempt should be counted. Repeated repairs are to be counted separately in the total number of repair requests.

Evaluation of this parameter can be achieved by:

- Analysis by the QoSAP of data stored at the SP.
- Survey of relevant customers.

6.7.2.2 Trigger points

Table 57: P702 trigger points

Event	Trigger condition from customer's point of view	Condition
Repair request accepted	Start: t_2 in figure 19	Commencement of repair event
Repair completed	Stop: t_4 in figure 19	Repair completed and service back to normal
Repair not achieved	Stop: t_5 in figure 19	Repair did not happen within the time interval given by T_{72} plus T_{73}

6.7.2.3 Accuracy of indicator (metric of measure)

Not applicable.

6.7.2.4 Representativeness

Customer survey may be carried out, where possible, on 100 % of the customer population. Where customer population is large, a representative sample to reflect the whole population, the geographical coverage and usage pattern may be chosen.

6.7.2.5 Presentation of parameter values

Although the basic parameter delivers a single percentage, it is expected to be processed on a regular basis so that higher aggregations of this parameter, depending on the sample size per assessed customer segment, can be represented in terms of:

- Histograms.
- Probability Distribution Function (PDF).
- Cumulative Distribution Function (CDF).
- Quantile values.

Results should be provided on a regular basis with a clear indication on the panel composition and size or/and volume of SP data reviewed.

A chart can be used to display the results for the various types of services on a per month basis.

6.7.3 P703: Repairs not complete and correct first time [%]

6.7.3.1 Evaluation specific description

The customer population who have had repairs carried out in the recent past may be surveyed for unsuccessful repairs at the first attempt.

Where the customer population is manageable, 100 % of the population is surveyed. Where the number is large a sample reflecting the population profile is surveyed.

The records of the SP may also be analysed by the QoSAP in addition to the survey.

6.7.3.2 Trigger points

Not applicable as the survey is carried out at the end of the repair (after occurrence of t_4).

6.7.3.3 Accuracy of indicator (metric of measure)

Where 100 % of the samples are analyzed, the results are fully representative.

6.7.3.4 Representativeness

Customer survey may be carried out, where possible, on 100 % of the customer population. Where customer population is large a representative sample to reflect the whole population, the geographical coverage and usage pattern may be chosen.

6.7.3.5 Presentation of parameter values

Although the basic parameter delivers a single percentage, it is expected to be processed on a regular basis so that higher aggregations of this parameter, depending on the sample size per assessed customer segment, can be represented in terms of:

- Histograms.
- Probability Distribution Function (PDF).

- Cumulative Distribution Function (CDF).
- Quantile values.

Results should be provided on a regular basis with a clear indication on the panel composition and size or/and volume of SP data reviewed.

A chart can be used to display the results for the various types of services on a per month basis.

6.7.4 P704: Punctuality of appointments for repairs [OR & Time]

6.7.4.1 Evaluation specific description

Evaluation of this parameter can be achieved by:

- Analysis by the QoSAP of data stored at the SP.
- Survey of relevant customers.

The customer population who have had repairs carried out in the recent past may be surveyed for their OR of the punctuality of the SP or its agent.

Where the customer population is manageable a 100 % of the population is surveyed. Where the number is large a sample reflecting the population profile is surveyed.

The survey may ask the customers if the SP or its agent kept to the promised time for repair/s within the grace period for lateness.

If the appointment is rescheduled by the customer it may be treated as the same repair, not a separate one, hence not added to the total number of repairs. If, however the SP reschedules the repair appointment it may be counted as an appointment not kept.

6.7.4.2 Trigger points

T5: repair commencement as per schedule allowing a grace period for lateness.

Table 58: P704 trigger points

Event	Trigger condition from customer's point of view	Condition
Repair finally expected	Start: t_5 in figure 19	Expiration of allowed repair interval
Repair completed	Stop: t_4 in figure 19	Repair completed and service back to normal

6.7.4.3 Accuracy of indicator (metric of measure)

The accuracy of this indicator depends on the manning of the panel. The more opinions are gathered within the OR, the more accurate the overall result will be. For more information on this, see clause 4.

P704a [OR]: The accuracy of the OR will depend upon the credibility of the customers surveyed in the information supplied on the punctuality. This would be based on their recollection of whether the SP or its agent was late. In the absence of any substantive information the customer opinion should be considered credible. However in the interpretation of results the reader should be aware the possibility of honest mistakes by the customer as the survey is carried on historical events.

P704b [Time]: Refer to accuracy of indicator in clause 4.3.4.

6.7.4.4 Representativeness

Customer survey may be carried out, where possible, on 100 % of the customer population. Where customer population is large a representative sample to reflect the whole population, the geographical coverage and usage pattern may be chosen.

6.7.4.5 Presentation of parameter values

P704a: Opinion rating of the panel should be presented on a regular basis with an indication on the distribution of the members' individual scores taking into account the various types of services in one of the following ways:

Results should be provided on a regular basis with a clear indication on the panel composition and size or/and volume of SP data reviewed.

P704b: The SP's record should be expressed as the distribution of delay in keeping appointments expressed in units of time, e.g. minutes/hours or days.

Depending on the sample size per assessed customer segment, these presentations are recommended:

- Histograms.
- Probability Distribution Function (PDF).
- Cumulative Distribution Function (CDF).
- Quantile values.

Results should be provided on a regular basis (Boxplots) with a clear indication where the data come from (panel composition and size or SP data).

6.7.5 P705: Efficiency of the repair service [OR]

6.7.5.1 Evaluation specific description

The customer population who have had repairs carried out in the recent past may be surveyed.

Where the customer population is manageable a 100 % of the population may be surveyed. Where the number is large, a sample reflecting the population profile may be surveyed.

6.7.5.2 Trigger points

Not applicable as the survey is carried out at the end of the repair (after occurrence of t_d).

6.7.5.3 Accuracy of indicator (metric of measure)

The accuracy of this indicator depends on the manning of the panel. The more opinions are gathered within the OR, the more accurate the overall result will be. For more information on this, see clause 4.

Not applicable if 100 % of the samples is analyzed.

6.7.5.4 Representativeness

Customer survey may be carried out, where possible, on 100 % of the customer population. Where customer population is large a representative sample to reflect the whole population, the geographical coverage and usage pattern may be chosen.

6.7.5.5 Presentation of parameter values

Opinion rating of the panel should be presented with an indication on the distribution of the members' individual scores taking into account the various types of services. The mean value should be given as a synthetic indication.

Results should be provided on a regular basis with a clear indication on the panel composition and size.

A chart can be used to display the results for the various types of services.

6.7.6 P711: Organisational efficiency of repair service (SPO) [OR]

6.7.6.1 Evaluation specific description

The customer population who have had repairs carried out in the recent past may be surveyed.

Where the customer population is manageable, a 100 % of the population may be surveyed. Where the number is large a sample reflecting the population profile may be surveyed.

6.7.6.2 Trigger points

Not applicable as the survey is carried out at the end of the repair (after occurrence of t_4).

6.7.6.3 Accuracy of indicator (metric of measure)

The accuracy of this indicator depends on the manning of the panel. The more opinions are gathered within the OR, the more accurate the overall result will be. For more information on this, see clause 4.

6.7.6.4 Representativeness

Customer survey may be carried out, where possible, on 100 % of the customer population. Where customer population is large a representative sample to reflect the whole population, the geographical coverage and usage pattern may be chosen.

6.7.6.5 Presentation of parameter values

Opinion rating of the panel should be presented with an indication on the distribution of the members' individual scores taking into account the various types of services. The mean value should be given as a synthetic indication.

Results should be provided on a regular basis with a clear indication on the panel composition and size.

A chart can be used to display the results for the various types of services.

6.8 Customer Relationship Stage: Metering, Charging, Billing

6.8.1 P801: Accessibility of the tariff information [%]

6.8.1.1 Evaluation specific description

Precondition: Access to expense control information in chosen mode.

Evaluation of this parameter can be achieved by:

- Analysis by the QoSAP of data stored at the SP.
- Survey of relevant customers.
- Assessment by a panel of experts based on answers received from the SP.

6.8.1.2 Trigger points

Table 59: P801 trigger points

Event	Trigger point from customer's point of view	Condition
Access to expense control information	Start: t_1 in figure 20a	Customer accessing expense control information in chosen mode
Document found	Stop: t_2 in figure 20a	Expense control information accessed by customer
Timeout for accessing the expense control information reached	Stop: t_2 in figure 20a	Timeout T_{81} for accessing the expense control information reached

6.8.1.3 Accuracy of indicator (metric of measure)

Refer to accuracy of indicator in clause 4.3.4.

6.8.1.4 Representativeness

The parameter can be applied to any customer group of interest (e.g. customer segments or the whole customer population of a SP).

6.8.1.5 Presentation of parameter values

Although the basic parameter delivers a single percentage, it is expected to be processed per hour so that the results are given with respect to the hour of the day, the day of the week, holiday time, etc. and higher aggregations of this parameter, depending on the sample size per assessed customer segment, can be represented in terms of:

- Histograms.
- Probability Distribution Function (PDF).
- Cumulative Distribution Function (CDF).
- Quantile values.

Results should be provided on a regular basis with a clear indication where the data come from (panel composition and size or/and volume of SP data reviewed).

A chart can be used to display the results for the various types of services.

6.8.2 P802: Successful notification of exceeding billing budget [%]

6.8.2.1 Evaluation specific description

Precondition: Billing budget overrun occurred.

Evaluation of this parameter can be achieved by:

- Analysis by the QoSAP of data stored at the SP.
- Survey of relevant customers.
- Assessment by a panel of experts according to the information received from the SP.

6.8.2.2 Trigger points

Table 60: P802 trigger points

Event	Trigger point from customer's point of view	Condition
Billing budget overrun occurred	Start: t_3 in figure 20b	Customer exceeds his billing budget
Billing budget overrun notification received	Stop: t_4 in figure 20b	Customer receives overrun notification from SP
Timeout for billing budget overrun notification reached	Stop: t_4 in figure 20b	Customer does not receive any notification from SP within timeout period T_{82}

6.8.2.3 Accuracy of indicator (metric of measure)

Refer to accuracy of indicator in clause 4.3.4.

6.8.2.4 Representativeness

The parameter can be applied to any customer group of interest (e.g. customer segments or the whole customer population of a SP).

6.8.2.5 Presentation of parameter values

Although the basic parameter delivers a single percentage, it is expected to be processed on a regular basis so that higher aggregations of this parameter, depending on the sample size per assessed customer segment, can be represented in terms of:

- Histograms.
- Probability Distribution Function (PDF).
- Cumulative Distribution Function (CDF).
- Quantile values.

Results should be provided on a regular basis with a clear indication on the panel composition and size or/and volume of SP data reviewed.

A chart can be used to display the results for the various types of services.

6.8.3 P803: Notification time (delay) of exceeding billing budget [Time]

6.8.3.1 Evaluation specific description

Precondition: Billing budget overrun occurred.

Evaluation of this parameter can be achieved by:

- Analysis by the QoSAP of data stored at the SP.
- Survey of relevant customers (preferred scenario).
- Assessment by a panel of experts according to the information received from the SP.

6.8.3.2 Trigger points

Table 61: P803 trigger points

Event	Trigger point from customer's point of view	Condition
Billing budget overrun occurred	Start: t_3 in figure 20b	Customers billing budget exceeded
Billing budget overrun notification received	Stop: t_4 in figure 20b	Billing budget overrun notification received by customer
Timeout for exceeding billing budget notification	Stop: t_4 in figure 20b	Timeout T_{82} for receiving the billing budget notification reached

6.8.3.3 Accuracy of indicator (metric of measure)

Refer to accuracy of indicator in clause 4.3.4.

6.8.3.4 Representativeness

The parameter can be applied to any customer group of interest (e.g. customer segments or the whole customer population of a SP).

6.8.3.5 Presentation of parameter values

Depending on the sample size per assessed customer segment, these presentations are recommended:

- Histograms.
- Probability Distribution Function (PDF).
- Cumulative Distribution Function (CDF).
- Quantile values.

Results should be provided on a regular basis with a clear indication where the data come from (panel composition and size or SP data).

6.8.4 P804: Accessibility of the account management [%]

6.8.4.1 Evaluation specific description

Precondition: Access to account information management.

Evaluation of this parameter can be achieved by:

- Analysis by the QoSAP of data stored at the SP.
- Survey of relevant customers (preferred scenario).
- Assessment by a panel of experts according to the information received from the SP.

6.8.4.2 Trigger points

Table 62: P804 trigger points

Event	Trigger point from customer's point of view	Condition
Access to account information	Start: t_5 in figure 20c	Customers wants to access his account information
Real-time account information accessed	Stop: t_6 in figure 20c	Successful account information access by customer
Timeout for accessing real-time account information reached	Stop: t_6 in figure 20c	Timeout T_{83} for accessing account information reached

6.8.4.3 Accuracy of indicator (metric of measure)

Refer to accuracy of indicator in clause 4.3.4.

6.8.4.4 Representativeness

The parameter can be applied to any customer group of interest (e.g. customer segments or the whole customer population of a SP).

6.8.4.5 Presentation of parameter values

Although the basic parameter delivers a single percentage, it is expected to be processed per hour so that the results are given with respect to the hour of the day, the day of the week, holiday time, etc. and higher aggregations of this parameter, depending on the sample size per assessed customer segment, can be represented in terms of:

- Histograms.
- Probability Distribution Function (PDF).
- Cumulative Distribution Function (CDF).
- Quantile values.

Results should be provided on a regular basis with a clear indication on the panel composition and size or/and volume of SP data reviewed.

A chart can be used to display the results for the various types of services.

6.8.5 P805: Time to update charging information [Time]

6.8.5.1 Evaluation specific description

Precondition: Access to account information.

Evaluation of this parameter can be achieved by:

- Analysis by the QoSAP of data stored at the SP.
- Survey of relevant customers (preferred scenario).
- Assessment by a panel of experts according to the information received from the SP.

6.8.5.2 Trigger points

Table 63: P805 trigger points

Event	Trigger point from customer's point of view	Condition
Access to account information	Start: t_5 in figure 20c	Customers wants to access his account information
Real-time account information accessed	Stop: t_6 in figure 20c	Successful account information access by customer
Timeout for accessing real-time account information reached	Stop: t_6 in figure 20c	Timeout T_{83} for accessing account information reached

6.8.5.3 Accuracy of indicator (metric of measure)

Refer to accuracy of indicator in clause 4.3.4.

6.8.5.4 Representativeness

The parameter can be applied to any customer group of interest (e.g. customer segments or the whole customer population of a SP).

6.8.5.5 Presentation of parameter values

Although the basic parameter delivers a single time value, it is expected to be processed on a regular basis so that higher aggregations of this parameter, depending on the sample size per assessed customer segment, can be represented in terms of:

- Histograms.
- Probability Distribution Function (PDF).
- Cumulative Distribution Function (CDF).
- Quantile values.

Results should be provided on a regular basis with a clear indication where the data come from (panel composition and size or SP data).

6.8.6 P806: Timeliness of bill delivery [%]

6.8.6.1 Evaluation specific description

Precondition: Bill expected.

Evaluation of this parameter can be achieved by:

- Analysis by the QoSAP of data stored at the SP.
- Survey of relevant customers.

6.8.6.2 Trigger points

Table 64: P806 trigger points

Event	Trigger point from customer's point of view	Condition
Bill expected	Start: t_7 in figure 20d	Expected point of time of bill delivery
Bill delivered	Stop: t_8 in figure 20d	Successful delivery of bill
Timeout for bill delivery reached	Stop: t_8 in figure 20d	Timeout T_{84} for bill delivery reached

6.8.6.3 Accuracy of indicator (metric of measure)

Refer to accuracy of indicator in clause 4.3.4.

6.8.6.4 Representativeness

The parameter can be applied to any customer group of interest (e.g. customer segments or the whole customer population of a SP).

6.8.6.5 Presentation of parameter values

Although the basic parameter delivers a single percentage, it is expected to be processed on a regular basis so that higher aggregations of this parameter, depending on the sample size per assessed customer segment, can be represented in terms of:

- Histograms.
- Probability Distribution Function (PDF).
- Cumulative Distribution Function (CDF).
- Quantile values.

Results should be provided on a regular basis with a clear indication where the data come from (panel composition and size or SP data).

A chart can be used to display the results for the various types of services.

6.8.7 P807: Bill delivery delay [Time]

6.8.7.1 Evaluation specific description

Precondition: Bill expected.

Evaluation of this parameter can be achieved by:

- Analysis by the QoSAP of data stored at the SP.
- Survey of relevant customers.

6.8.7.2 Trigger points

Table 65: P807 trigger points

Event	Trigger point from customer's point of view	Condition
Bill expected	Start: t_7 in figure 20d	Expected point of time of bill receipt
Bill received	Stop: t_8 in figure 20d	Successful receipt of bill
Timeout for bill receipt reached	Stop: t_8 in figure 20d	Timeout T_{84} for bill receipt reached

6.8.7.3 Accuracy of indicator (metric of measure)

Refer to accuracy of indicator in clause 4.3.4.

6.8.7.4 Representativeness

The parameter can be applied to any customer group of interest (e.g. customer segments or the whole customer population of a SP).

6.8.7.5 Presentation of parameter values

Depending on the sample size per assessed customer segment, these presentations are recommended:

- Histograms.
- Probability Distribution Function (PDF).
- Cumulative Distribution Function (CDF).
- Quantile values.

Results should be provided on a regular basis with a clear indication where the data come from (panel composition and size or SP data).

6.8.8 P808: Late notification of amount due [%]

6.8.8.1 Evaluation specific description

Precondition: Bill expected.

Evaluation of this parameter can be achieved by:

- Analysis by the QoSAP of data stored at the SP.
- Survey of relevant customers (preferred scenario).
- Assessment by a panel of experts according to the information received from the SP.

6.8.8.2 Trigger points

Table 66: P808 trigger points

Event	Trigger point from customer's point of view	Condition
Advice of direct debit expected	Start: t_9 in figure 20e	Expected point of time for advice of direct debit change
Advice of direct debit delivered	Stop: t_{10} in figure 20e	Successful delivery of advice
Timeout for advice of direct debit delivery reached	Stop: t_{10} in figure 20e	Timeout T_{85} for delivery of advice reached

6.8.8.3 Accuracy of indicator (metric of measure)

Refer to accuracy of indicator in clause 4.3.4.

6.8.8.4 Representativeness

The parameter can be applied to any customer group of interest (e.g. customer segments or the whole customer population of a SP).

6.8.8.5 Presentation of parameter values

Although the basic parameter delivers a single percentage, it is expected to be processed on a regular basis so that higher aggregations of this parameter, depending on the sample size per assessed customer segment, can be represented in terms of:

- Histograms.
- Probability Distribution Function (PDF).

- Cumulative Distribution Function (CDF).
- Quantile values.

Results should be provided on a regular basis with a clear indication on the panel composition and size or/and volume of SP data reviewed.

A chart can be used to display the results for the various types of services.

6.8.9 P809: Modes of billing information transfer [Number]

6.8.9.1 Evaluation specific description

Precondition: Bill received.

Evaluation of this parameter can be achieved by:

- Analysis by the QoSAP of data stored at the SP.
- Assessment by a panel of experts according to the information received from the SP.

6.8.9.2 Trigger points

Number of modes is compiled at the launch of a service and updated whenever a new mode is added. The trigger point would be launch of a service and subsequent additions to the modes.

6.8.9.3 Accuracy of indicator (metric of measure)

Refer to accuracy of indicator in clause 4.3.4.

6.8.9.4 Representativeness

The parameter can be applied to any customer group of interest (e.g. customer segments or the whole customer population of a SP).

As all the modes are taken into account, the results are expected to be fully representative.

6.8.9.5 Presentation of parameter values

The results are presented as the list and number of modes in which the documentation is available.

6.8.10 P815: Organisational efficiency of the billing service (SPO) [OR]

6.8.10.1 Evaluation specific description

Evaluation of this parameter can be achieved by:

- Survey of relevant customers.
- Assessment of SP data by a panel of experts. It may be necessary for them to obtain relevant data, where available, from the SP and make an informed judgement in other cases to arrive at an OR value.

6.8.10.2 Trigger points

Table 67: P815 trigger points

Event	Trigger point from customer's point of view	Condition
Bill expected	Start: t_7 in figure 20d	Expected point of time of bill receipt
Bill received	Stop: t_8 in figure 20d	Successful receipt of bill
Timeout for bill receipt reached	Stop: t_8T in figure 20d	Timeout for bill receipt reached

6.8.10.3 Accuracy of indicator (metric of measure)

The accuracy of this indicator depends on the manning of the panel. The more opinions are gathered within the OR, the more accurate the overall result will be. For more information on this, see clause 4.

6.8.10.4 Representativeness

Not applicable.

6.8.10.5 Presentation of parameter values

Opinion rating of the panel should be presented with an indication on the distribution of the members' individual scores taking into account the various types of services.

Depending on the sample size per assessed customer segment, these presentations are recommended:

- Histograms.
- Probability Distribution Function (PDF).
- Cumulative Distribution Function (CDF).
- Quantile values.

Results should be provided on a regular basis with a clear indication on the panel composition and size or/and volume of SP data reviewed.

A chart can be used to display the results for the various types of services.

6.9 Customer Relationship Stage: Network / Service Management by the customer

6.9.1 P901: Outage duration [Time]

6.9.1.1 Evaluation specific description

For an outage to be eligible to be taken into account the Network/Service Management facility should be unavailable for a period longer than a threshold value e.g. 1 second. This threshold value may be decided by a national stakeholder, e.g. regulator or a representative institution. The outage needs to be monitored on a customer by customer basis. This is more easily implemented for large organisations than for residential customers. For the latter the SP may provide this facility on a sampling basis and may be audited by stakeholders e.g. regulator or a representative institution. Where sampling has been implemented the SP could state in the presentation of parameter values (for a reporting period) the confidence limits for the values obtained.

6.9.1.2 Trigger points

Table 68: P901 trigger points

Event	Trigger point from customer's point of view	Condition
Outage commences	t_{out1} in figure 21a	First outage in specified period starts
Outage ends	t_{out2} in figure 21a	First outage in specified period ends
.....
Outage commences	t_{outn} in figure 21a	Last outage in specified period starts
Outage ends	t_{outn+1} in figure 21a	Last outage in specified period ends

6.9.1.3 Accuracy of indicator (metric of measure)

For large organisations where outages for the individual customer can be employed the accuracy of the value of the parameter will be the maximum systematic error of the monitoring devices. Manufacturers of the monitoring devices would be able to provide this information.

For residential customers and SME where the monitoring is carried out on a sampling basis the SP can provide an estimate of the accuracy and confidence of the estimated values.

6.9.1.4 Representativeness

Every large customer (e.g. corporate organisation) who uses Network/Service Management facility on a regular basis would normally have their own monitoring devices.

While selecting residential and SME for presenting outages the following considerations may be taken into account:

- Where there are significant differences in different geographical areas within the SP's coverage to warrant separate outage reportings.
- Where there are different sensitivities among SME along the lines of their industry requirements to warrant reporting of outages (e.g. some industries may tolerate a large number of small outages but not one large outage and vice versa).

6.9.1.5 Presentation of parameter values

Total outage is expressed as:

- 1) Total time distribution of outage times presented appropriately (see clause 4.3).
- 2) As a percentage of the total time during the reporting period.

Where necessary results may also be provided for different groups of customers.

6.9.2 P902: Number of outages [Number]

6.9.2.1 Evaluation specific description

For an outage to be counted, the Network/Service Management facility should be unavailable for a period longer than a threshold value e.g. 1 second. This threshold value may be decided by stakeholders, e.g. regulator or a representative institution. The outage needs to be monitored on a customer by customer basis. This is easier to implement for large organisations than for residential customers. For the latter the SP may provide this facility on a sampling basis and this arrangement may be audited by an Expert Panel on request of the national stakeholder e.g. regulator or a representative institution. Where sampling has been implemented, the SP could state in the presentation of parameter values (for a reporting period) the confidence limits for the values obtained.

6.9.2.2 Trigger points

Table 69: P902 trigger points

Event	Trigger point from customer's point of view	Condition
Outage commences	t_{out1} in figure 21a	First outage in specified period starts
Outage ends	t_{out2} in figure 21a	First outage in specified period ends
.....
Outage commences	t_{outn} in figure 21a	Last outage in specified period starts
Outage ends	t_{outn+1} in figure 21a	Last outage in specified period ends

6.9.2.3 Accuracy of indicator (metric of measure)

For large organisations where outages for the individual customer can be defined, the accuracy of the value of the parameter will be the maximum systematic error in the counting of the number of outages by the monitoring devices. Manufacturers of the monitoring devices would be able to provide this information.

For residential customers and SME where the monitoring is carried out on a sampling basis the SP can provide an estimate of the accuracy and confidence of the estimated values.

6.9.2.4 Representativeness

Every large customer (e.g. corporate organisation) using Network/Service Management facility on a regular basis would have their own monitoring devices.

While selecting residential and SME for presenting outages the following considerations may be taken into account:

- Where there are significant differences in different geographical areas within the SP's coverage to warrant separate outage reportings.
- Where there are different sensitivities among SME along the lines of their industry requirements to warrant reporting of outages (e.g. some industries may tolerate a large number of small outages but not one large outage and vice versa).

6.9.2.5 Presentation of parameter values

The number of outages is expressed by the cumulative number of outages during the reporting period (see also clause 4.3).

Results should be provided on a regular basis (Boxplots) with a clear indication on size or/and volume of SP data reviewed.

Where necessary this value may be reported for various segments of the market.

6.9.3 P903: Response time for reply to requests [Time]

6.9.3.1 Evaluation specific description

Time to carry out the customer's N/S Management request may be measured from the instant a request was made to the instant the request was fulfilled. A timeout indicates whether the request was carried out or not. Where the request was not carried out within the time out or not fully carried out the request may be registered as "not carried out" or "failed". Repeat requests may be treated as a separate request.

6.9.3.2 Trigger points

Table 70: P903 trigger points

Event	Trigger point from customer's point of view	Condition
Access request	Start: t_1 in figure 21b	Customer sends his request
Request carried out	Stop: t_2 in figure 21b	Successful execution of request
Timeout for request reached	Stop: t_3 in figure 21b	Timeout T_{91} for customer request reached

6.9.3.3 Accuracy of indicator (metric of measure)

For large organisations where outages for the individual customer can be employed the accuracy of the value of the parameter will be the maximum systematic error of the monitoring devices. Manufacturers of the monitoring devices would be able to provide this information.

For residential customers and SME where the monitoring is carried out on a sampling basis the SP can provide an estimate of the accuracy and confidence of the estimated values.

6.9.3.4 Representativeness

Every large customer (e.g. corporate organisation) who uses Network/Service Management facility on a regular basis would have their own monitoring devices.

While selecting residential and SME for presenting outages the following considerations may be taken into account:

- Where there are significant differences in different geographical areas within the SP's coverage to warrant separate outage reportings.
- Where there are different sensitivities among SME along the lines of their industry requirements to warrant reporting of outages (e.g. some industries may tolerate a large number of small outages but not one large outage and vice versa).

6.9.3.5 Presentation of parameter values

Although the basic parameter delivers a single time value, it is expected to be processed per hour so that the results are given with respect to the hour of the day, the day of the week, holiday time, etc. and higher aggregations of this parameter, depending on the sample size per assessed customer segment, can be represented in terms of:

- Histograms.
- Probability Distribution Function (PDF).
- Cumulative Distribution Function (CDF).
- Quantile values.

Results should be provided on a regular basis (Boxplots) with a clear indication where the data come from (panel composition and size or SP data).

Pies like those given in annex A should be used to display the results for the hour of the day, day of the week, etc.

Where necessary this value may be reported for various segments of the market.

6.9.4 P904: Successful request response [%]

6.9.4.1 Evaluation specific description

Reasons for not having successful outcome for a customer request may be any of the following:

- Request not resolved.
- Request resolved partially or not satisfactorily.
- No response from N/S management centre and hence a repeat attempt.

Recording of customer opinion at the end of each request may only be possible on sophisticated monitoring systems which in turn may be available only to large customers. Where this facility is available a count may be made of the unsuccessful request attempts. Where this is not possible a customer survey is advised to obtain a measure of the response rate for the N/S facility.

Customer survey may be made on a 100 % sampling basis for large organisations and on a sampling basis for residential customers and SME.

6.9.4.2 Trigger points

Table 71: P904 trigger points

Event	Trigger point from customer's point of view	Condition
Access request	Start: t_1 in figure 21b	Customer sends his request
Request carried out	Stop: t_2 in figure 21b	Successful execution of request
Timeout for request reached	Stop: t_3 in figure 21b	Timeout T_{91} for customer request reached

6.9.4.3 Accuracy of indicator (metric of measure)

Where customer survey is deployed to obtain value for this parameter the accuracy is dependent upon identifying the customers who did not have complete satisfaction to their request to the N/S management facility.

6.9.4.4 Representativeness

While selecting residential and SME for presenting outages the following considerations may be taken into account:

- Where there are significant differences in different geographical areas within the SP's coverage to warrant separate outage reportings.
- Where there are different sensitivities among SME along the lines of their industry requirements to warrant reporting of outages (e.g. some industries may tolerate a large number of small outages but not one large outage and vice versa).

6.9.4.5 Presentation of parameter values

Opinion rating of the panel should be presented with an indication on the distribution of the members' individual scores taking into account the various types of services.

Results should be provided on a regular basis with a clear indication on the panel composition and size or/and volume of SP data reviewed.

A chart can be used to display the results for the various types of services.

6.9.5 P905: Overall reliability of network/service management service [OR]

6.9.5.1 Evaluation specific description

Members of the expert panel may look at the delivered performance of parameters 901, 902, 903, 904 and 905 over the reporting period and form an opinion rating for the overall reliability of the SP's quality of management services.

The opinion rating is intended to reflect the viewpoint of the customer and not make undue allowance to the difficulties of the SP.

Preferably, a survey of customer's opinion rating for this parameter should also be sought. These data should also be published in parallel with the panel member's data.

6.9.5.2 Trigger points

Not applicable as the survey is carried out well after the customer has completed the N/S management activities.

6.9.5.3 Accuracy of indicator (metric of measure)

The accuracy of this indicator depends on the manning of the panel. The more opinions are gathered within the OR, the more accurate the overall result will be. For more information on this, see clause 4.

There may be discrepancy between the findings of the customer survey and audit panel. Where the difference is significant, reason for the discrepancy may be investigated and any necessary changes incorporated either to the panel's ratings or the way customer survey is carried out.

6.9.5.4 Representativeness

Not applicable.

6.9.5.5 Presentation of parameter values

Opinion rating of the panel is expressed as the distribution of the members' individual scores with an indication on the results distribution. The mean value of the panel member's scores should be given as a synthetic indication.

Where customer survey has been carried out the OR is also published for the same period.

Results should be provided on a regular basis with a clear indication on the panel composition and size or/and volume of SP data reviewed.

A chart can be used to display the results for the various types of services.

6.9.6 P913: Organizational efficiency of the network/service management service (SPO) [OR]

6.9.6.1 Evaluation specific description

Evaluation of documentation may be carried out by:

- A panel of experts qualified to evaluate Network/Service Management systems and the resources required to achieve this. They would be expected to have technical expertise as well as usability to look at the economic considerations objectively from the customer's and SP's viewpoint.
- A customer survey may also be carried out where this is considered to add value to the opinion rating.

6.9.6.2 Trigger points

Not applicable as the survey is carried out well after the customer has completed the N/S management activities.

6.9.6.3 Accuracy of indicator (metric of measure)

The accuracy of this indicator depends on the manning of the panel. The more opinions are gathered within the OR, the more accurate the overall result will be. For more information on this, see clause 4.

6.9.6.4 Representativeness

For large customers a customer survey may be carried out, where possible, on a 100 % of the customer population. Where residential customers and SME are being surveyed this may not be possible and a representative sample to reflect the whole population, the geographical coverage and usage pattern may be chosen.

6.9.6.5 Presentation of parameter values

Opinion rating of the panel should be presented with an indication on the distribution of the members' individual scores taking into account the various types of services. The mean value should be given as a synthetic indication.

Results should be provided on a regular basis with a clear indication on the panel composition and size or/and volume of SP data reviewed.

A chart can be used to display the results for the various types of services.

6.10 Customer Relationship Stage: Cessation

6.10.1 P1001: Cessation acknowledgement time [Time]

6.10.1.1 Evaluation specific description

Precondition: Cessation request sent.

The customer population who have had cessations events in the recent past may be surveyed. Evaluation of this parameter can be achieved by:

- Survey of relevant customers.
- Analysis by the QoSAP of data stored at the service provider.

6.10.1.2 Trigger points

Table 72: P1001 trigger points

Event	Trigger point from customer's point of view	Condition
Cessation request sent	Start: t_1 in figure 22	Cessation request is sent by customer to SP
Acknowledgement to cessation request received	Stop: t_2 in figure 22	Acknowledgement is received by customer before reaching timeout
Timeout reached	Stop: t_2' in figure 22	Acknowledgement is not received by customer before reaching timeout T_{101}

6.10.1.3 Accuracy of indicator (metric of measure)

Refer to accuracy of indicator in clause 4.3.4.

6.10.1.4 Representativeness

The parameter can be applied to any customer group of interest (e.g. customer segments or the whole customer population of a SP).

6.10.1.5 Presentation of parameter values

Depending on the sample size per assessed customer segment, these presentations are recommended:

- Histograms.
- Probability Distribution Function (PDF).
- Cumulative Distribution Function (CDF).
- Quantile values.

Results should be provided on a regular basis with a clear indication on the panel composition and size or/and volume of SP data reviewed.

A chart can be used to display the results for the various types of services.

6.10.2 P1002: Cessation request acknowledgement [%]

6.10.2.1 Evaluation specific description

Precondition: Cessation Request sent.

The customer population who have had cessations events in the recent past may be surveyed. Evaluation of this parameter can be achieved by three ways:

- Analysis by the QoSAP of data stored at the service provider.
- Survey of relevant customers.
- Assessment by a panel of experts according to the information received from the SP.

6.10.2.2 Trigger points

Table 73: P1002 trigger points

Event	Trigger point from customer's point of view	Condition
Cessation request send	Start: t_1 in figure 22	Cessation request is sent by customer to SP
Acknowledgement to cessation request received	Stop: t_2 in figure 22	Acknowledgement is received by customer before reaching timeout
Timeout reached	Stop: t_2' in figure 22	Acknowledgement is not received by customer before reaching timeout T_{101}

6.10.2.3 Accuracy of indicator (metric of measure)

Refer to accuracy of indicator in clause 4.3.4.

6.10.2.4 Representativeness

The parameter can be applied to any customer group of interest (e.g. customer segments or the whole customer population of a SP).

6.10.2.5 Presentation of parameter values

Although the basic parameter delivers a single percentage, it is expected to be processed on a regular basis so that higher aggregations of this parameter, depending on the sample size per assessed customer segment, can be represented in terms of:

- Histograms.
- Probability Distribution Function (PDF).
- Cumulative Distribution Function (CDF).
- Quantile values.

Results should be provided on a regular basis with a clear indication on the panel composition and size or/and volume of SP data reviewed.

A chart can be used to display the results for the various types of services.

6.10.3 P1003: Accessibility of the cessation facility [%]

6.10.3.1 Evaluation specific description

Precondition: Cessation Request sent.

The customer population who have had cessations events in the recent past may be surveyed. Evaluation of this parameter can be achieved by three ways:

- Analysis by the QoSAP of data stored at the SP.
- Survey of relevant customers.
- Assessment by a panel of experts according to the information received from the SP.

6.10.3.2 Trigger points

Table 74: P1003 trigger points

Event	Trigger point from customer's point of view	Condition
Cessation request send	Start: t_1 in figure 22	Cessation request is sent by customer to SP
Acknowledgement to cessation request received	Stop: t_2 in figure 22	Acknowledgement is received by customer before reaching timeout
Timeout reached	Stop: t_2' in figure 22	Acknowledgement is not received by customer before reaching timeout T_{101}

6.10.3.3 Accuracy of indicator (metric of measure)

Refer to accuracy of indicator in clause 4.3.4.

6.10.3.4 Representativeness

The parameter can be applied to any customer group of interest (e.g. customer segments or the whole customer population of a SP).

6.10.3.5 Presentation of parameter values

The results of this parameter are reported as:

- percentage;
- reporting period;
- number of contracts considered.

Results should be provided on a regular basis with a clear indication on the panel composition and size or/and volume of SP data reviewed.

A chart can be used to display the results for the various types of services.

6.10.4 P1004: Contractual cessations achieved [%]

6.10.4.1 Evaluation specific description

Precondition: Cessation Request sent and accepted.

The customer population who have had cessations events in the recent past may be surveyed. Evaluation of this parameter can be achieved by three ways:

- Analysis by the QoSAP of data stored at the SP.
- Survey of relevant customers.
- Assessment by a panel of experts according to their own experience with the SP.

6.10.4.2 Trigger points

Table 75: P1004 trigger points

Event	Trigger point from customer's point of view	Condition
Cessation request send	Start: t_1 in figure 22	Cessation request is sent by customer to SP
Acknowledgement to cessation request received	Stop: t_3 in figure 22	Acknowledgement is received by customer before reaching timeout
Timeout reached	Stop: t_3 in figure 22	Acknowledgement is not received by customer before reaching the sum of timeouts T_{101} and T_{102}

6.10.4.3 Accuracy of indicator (metric of measure)

Refer to accuracy of indicator in clause 4.3.4.

6.10.4.4 Representativeness

The parameter can be applied to any customer group of interest (e.g. customer segments or the whole customer population of a SP).

6.10.4.5 Presentation of parameter values

The results of this parameter are reported as:

- percentage;
- reporting period;
- number of contracts considered.

Results should be provided on a regular basis with a clear indication on the panel composition and size or/and volume of SP data reviewed.

A chart can be used to display the results for the various types of services.

Annex A: Aggregate rating of a customer relationship stage (or performance category) from a set of individual performance parameter ratings

A.1 Background

For a high level overall assessment of the performance of a customer relationship stage it may sometimes be helpful if an aggregate performance figure is available to reflect the individual parameter values of that stage.

An aggregate rating (AR) for performance on a category of performance (e.g. Preliminary Information, Provision of service, Repair service etc.) may be estimated from a set of more detailed quantitative and/or qualitative performance parameters on which indicator values have been assigned using the method described here. Another way recommended is to provide a detailed information using a graphic display similar to that given for ITU-T Recommendation P.505 [i.15].

A.2 Description

The aggregate of the individual ratings of the constituent parameter indicators is estimated by applying a weighting to represent their relative importance in the performance category.

Equation for the aggregate rating:

$$AR = w_1 \times p_1 + w_2 \times p_2 + w_3 \times p_3 + \dots + w_n \times p_n = \sum_{i=1}^n w_i \times p_i$$

where

p_i is the performance parameter result with index i

w_i is the weight of the performance parameter result p_i , expressed as percentage

n is the number of assessed performance parameters in this category

i is the index of the assessed performance parameter

The weighting is expressed as a percentage and will add up to 100 %:

$$\sum_{i=1}^n w_i = 100\%$$

A.3 Transformation rules

In the AR equation, p_i are performance indicators expressed on a continuous unipolar seven point opinion scale. To be specific, all values between the minimum and the maximum value of this opinion scale may arise. It is open for the specific application if the scaling is interpreted as a row from 0 to 6 or as a row from 1 to 7.

Where opinion ratings have been expressed on a bipolar seven point scale these may be converted to unipolar scale for the purposes of aggregation and reconverted to bipolar scale in the aggregate where useful. However, aggregation can also be done on the bipolar scales.

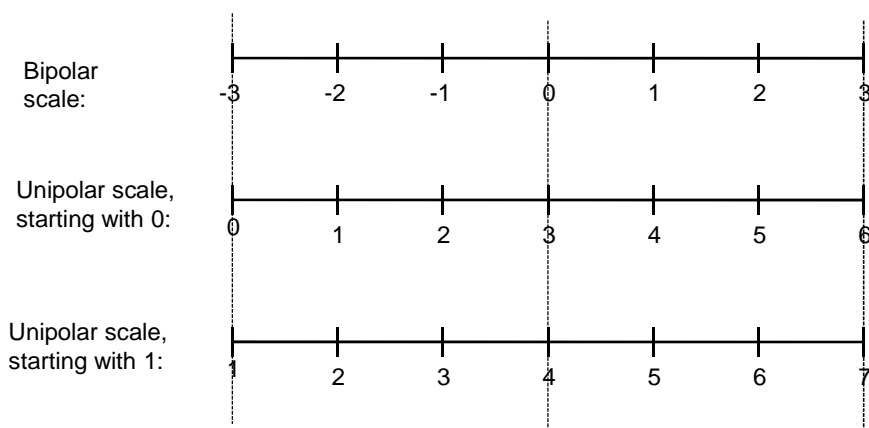

Figure A.1: Example of simple linear transformation of bipolar and unipolar scales

Where parameter indicators are numerical values e.g. percentages or ratios or any other numeric these need to be converted into a seven point scale by a panel. The panel will study the indicator value and use their professional knowledge of the technology and economic skills to give an opinion rating [OR] on a seven point scale for this indicator value.

The use of pre-defined transformation rules is recommended. The possible outcomes of performance parameters should be discussed and assessed to define transformation rules in advance. This procedure prevents the panel from being biased by the actual results, but reflects their knowledge and expectations.

A.4 Example of weighting and transformational rules

Application of weighting and the transformational rules are illustrated below:

The performance category (or customer relationship stage) of Preliminary Information (PI) has four parameters:

- Integrity of PI in Opinion Rating [OR], here on a bipolar seven point scale. Actual value assumed is -2.
- Pricing Transparency in OR, here on a bipolar seven point scale. Actual value assumed is 1.
- Availability of PI in percentage. Actual value assumed is 80 %.
- Response time for PI in units of time. Actual value assumed is 9 hours for the email mode (request and response via email).

These consecutive steps are applied for aggregation purposes:

Step 1: Convert OR ratings for Integrity of PI and Pricing Transparency from bipolar seven point scale to unipolar seven point scale.

EXAMPLE 1: Integrity of PI rating reads -2 and is transformed to 1 on a unipolar seven point scale starting with 0. The rating for Pricing Transparency reads 1 and is transformed to 4 on the same unipolar scale as mentioned for the Integrity.

Step 2: Panel assesses the value of Availability expressed as a percentage to a unipolar seven point scale value by evaluating the percentage in the economic conditions of the market and taking into considerations the influential factors.

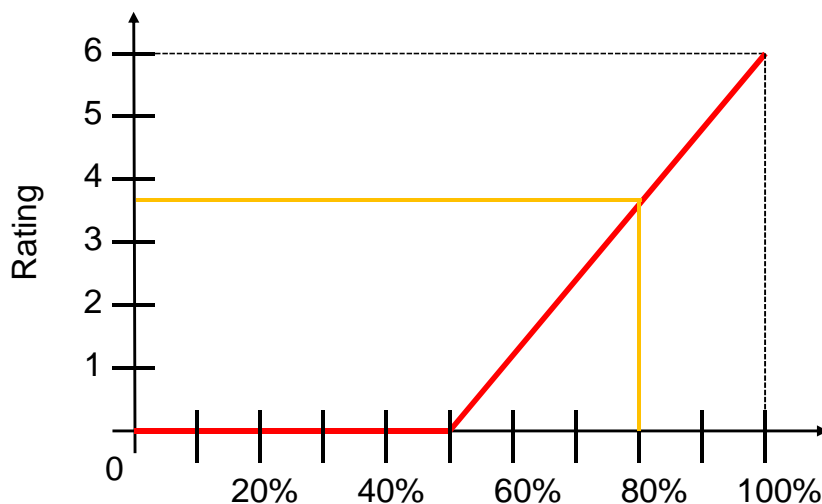

Figure A.2: Example of an availability rate of 80 % transformed into a rating value of 3,7

Step 3: Panel assesses the value of time for providing PI to the customer considering the mode of request made (telephone, email, post etc) and the mode in which the PI is provided (e.g. phone, email letter etc) and evaluates the operating environment for the supply of PI. A value on a unipolar seven point scale is then given.

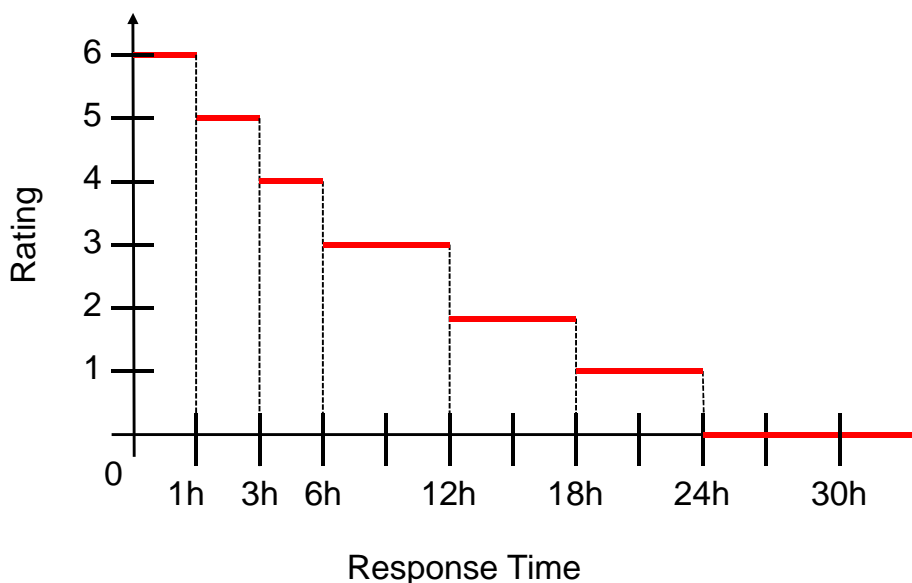

Figure A.3: Example of a response time of 9 hours assessed with a rating value of 3

Step 4: The panel determines the weighting for each of the four parameters in the overall context of the Aggregate Rating of the category 'Preliminary Information'. The total weighting of the 4 parameters would add up to 100 %.

EXAMPLE 2: One possible set could be:

- Integrity of PI: 25 %.
- Pricing Transparency: 40 %.
- Availability: 20 %.
- Response Time: 15 %.

Step 5: The two seven point scores from Step 1, the transformed seven point scores from Steps 2 and 3 and weighting are inserted into the equation for AR. The resulting value is reconverted into bipolar 7 point scale.

EXAMPLE 3: $AR = \sum_{i=1}^n w_i \times p_i = 0.25 \times 1 + 0.4 \times 4 + 0.2 \times 3.7 + 0.15 \times 3 = 3.04$

Conversion into the bipolar seven point scale would lead to an overall aggregated rating of 0,04.

A.5 Example of a graphic display of QoS assessment results

This clause provides two different examples showing how a graphic display can help to grasp the various aspects of the QoS.

The current trend is that a graphic display is the best appropriate solution to provide a synthetic view of the most critical customer relationship stages according to the user's expectation on QoS.

Different modes of presentation can be used depending what is the communication intention:

- If the intention is to make easy the comparison between the QoS achieved for different offers, it can be appropriate to choose a presentation with reference to the mean performance in the market segment.
- If the intention is to highlight the gaps in QoS, it would be more appropriate to choose a presentation with a common scale for all the parameter and showing that the smaller the areas, the better the QoS.
- For different purposes a combination of the above can be chosen.

A.5.1 Provisioning stage assessment

The following table shows the results of the assessment of a set of QoS parameters related to the customer relationship stage "Provisioning of the service".

Table A.1: Example of assessment results of QoS parameters related to the CRS "Provisioning"

QoS parameter	Measure	Reference threshold	Extreme value	Critical	
P301 Meeting promised provisioning date	60	80	100	Critical	[%]
P302 Time for provisioning	8	10	15	Critical	[Time]
P303 Successful provisioning within a specified period	80	95	100	Critical	[%]
P304 Contract cancelled due to non fulfilment of contract	10	5	20		[%]
P305 Completeness of fulfilment of contractual specification in the provision of a service	95	99	100	Critical	[%]
P306 Punctuality of service provisioning	0,2	0,15	±1		[Time]
P307 Punctuality of equipment delivery for service provisioning	1	1	±8		[Time]
P308 Provisioning not complete and correct first time	10	5	20	Critical	[%]
P309 Provisioning time	8	7	30		[Time]

NOTE: Mean values of the market segment is a possible reference threshold.

The adopted graphic display given as an example has the following features:

- Each QoS parameter is represented by a pie slice.
- The size of the pie slice depends on the scale on the radius defined by the values for the outside circle and the middle circle.
- The value on the outside circle is defined by the extreme value of the agreed range (in the given example the extreme value observed in the market segment).
- The value on the middle circle is defined by the reference threshold (in the given example the mean value observed in the market segment).

- The pie slices are displayed with different colours depending whether they are representing a critical parameter and whether the observed value is within (green) or outside (red) the reference range so that when the QoS parameters are within the reference range the pie looks green and when they are outside this range the pie looks red.

In this example, the bigger the size of the sectors, the better the QoS. Of course, other representations can be used depending of the communication target.

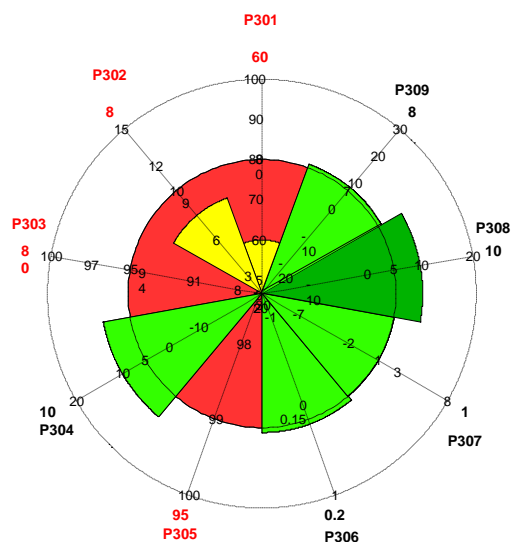

Figure A.4: QoS parameters of the provisioning stage

A.5.2 Example for the comparison of the QoS achieved by different SP

Table A.2 shows the number of users' complaints per million subscribers for 4 different SP.

Table A.2: Example of number of users' complaints per million subscribers for 4 different SP

Customer relationship stages	Reference threshold	Extreme value	Critical	SP A	SP B	SP C	SP D
Preliminary information	9,0	15,0		5,2	13,7	11,0	4,4
Contract establishment	27,0	40,0	Critical	12,9	36,5	39,6	21,1
Service provisioning	30,4	60,0	Critical	15,2	58,3	40,1	13,3
Service operation	19,4	40,0	Critical	9,7	34,3	26,1	16,7
Commercial support	6,1	10,0		3,5	8,5	9,6	5,6
Technical support	11,5	25,0		6,9	21,8	14,0	3,3
Repair services	53,1	100,0	Critical	17,7	91,7	91,4	40,0
Metering, Charging, Billing	46,1	80,0	Critical	18,2	79,6	71,8	46,7
Cessation	42,6	80,0	Critical	16,0	74,1	67,4	52,2

NOTE: Mean values of the market segment is a possible reference threshold.

The following examples were build in the same conditions as the previous ones to highlight how a graphic display of the above figures helps discovering, in a qualitative way, what are the crucial QoS aspects for each of these providers. In this example, since it represents complaints, the smaller the size of the sectors, the better the QoS.

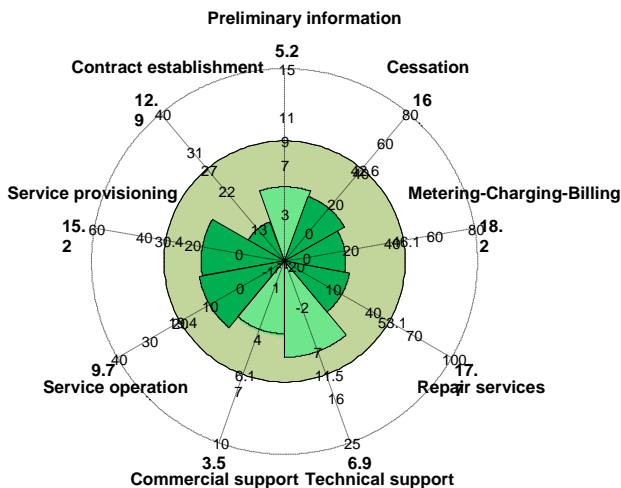

Figure A.5: QoS assessment of the customer relationship stages SP A

In these graphics the pale green circle highlights the acceptability thresholds, the customer relationship stages are in green (dark green for the crucial stages) when they are within the thresholds and in red (dark red for the crucial stages) when they are beyond the thresholds. Various combination can be seen in the following graphics.

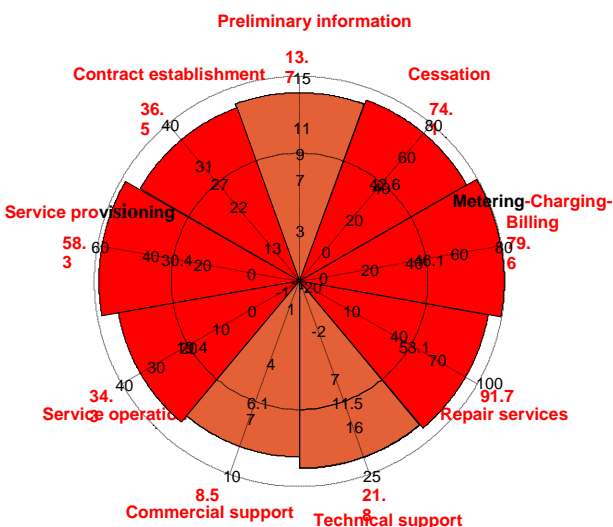

Figure A.6: QoS assessment of the customer relationship stages SP B

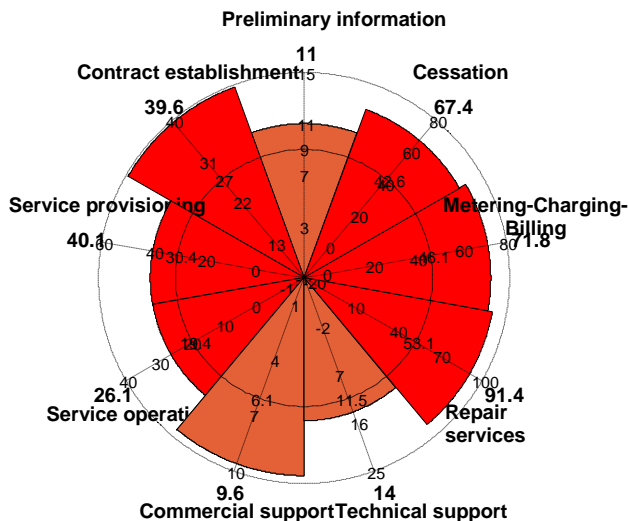

Figure A.7: QoS assessment of the customer relationship stages SP C

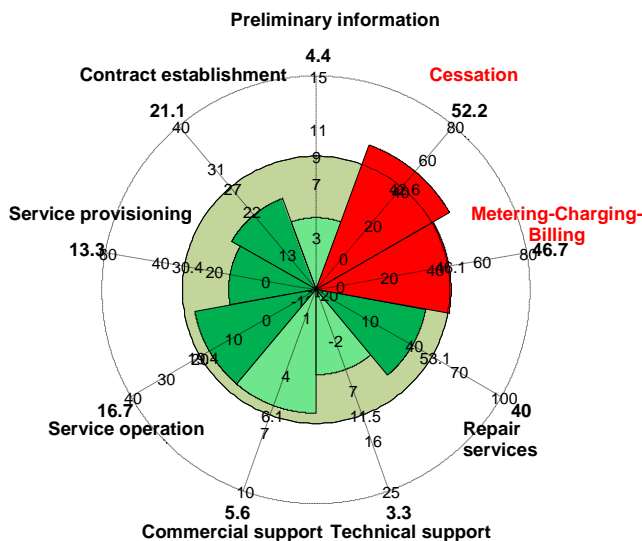

Figure A.8: QoS assessment of the customer relationship stages SP D

History

Document history		
V1.1.1	January 2011	Publication
V1.1.2	July 2011	Publication
V1.1.5	January 2013	Membership Approval Procedure MV 20130322: 2013-01-21 to 2013-03-22