

**Methods for Testing and Specification (MTS);
Internet Protocol Testing (IPT);
Generic approach to interoperability testing**



Reference

REG/MTS-00129-IOP-TstApproach

Keywords

interoperability, IP, telephony, testing

ETSI

650 Route des Lucioles
F-06921 Sophia Antipolis Cedex - FRANCE

Tel.: +33 4 92 94 42 00 Fax: +33 4 93 65 47 16

Siret N° 348 623 562 00017 - NAF 742 C
Association à but non lucratif enregistrée à la
Sous-Préfecture de Grasse (06) N° 7803/88

Important notice

Individual copies of the present document can be downloaded from:

<http://www.etsi.org>

The present document may be made available in more than one electronic version or in print. In any case of existing or perceived difference in contents between such versions, the reference version is the Portable Document Format (PDF). In case of dispute, the reference shall be the printing on ETSI printers of the PDF version kept on a specific network drive within ETSI Secretariat.

Users of the present document should be aware that the document may be subject to revision or change of status. Information on the current status of this and other ETSI documents is available at

<http://portal.etsi.org/tb/status/status.asp>

If you find errors in the present document, please send your comment to one of the following services:

http://portal.etsi.org/chaicor/ETSI_support.asp

Copyright Notification

No part may be reproduced except as authorized by written permission.
The copyright and the foregoing restriction extend to reproduction in all media.

© European Telecommunications Standards Institute 2010.
All rights reserved.

DECT™, **PLUGTESTS™**, **UMTS™**, **TIPHON™**, the TIPHON logo and the ETSI logo are Trade Marks of ETSI registered for the benefit of its Members.

3GPP™ is a Trade Mark of ETSI registered for the benefit of its Members and of the 3GPP Organizational Partners.

LTE™ is a Trade Mark of ETSI currently being registered

for the benefit of its Members and of the 3GPP Organizational Partners.

GSM® and the GSM logo are Trade Marks registered and owned by the GSM Association.

Contents

Intellectual Property Rights	6
Foreword.....	6
1 Scope	7
2 References	7
2.1 Normative references	7
2.2 Informative references.....	7
3 Definitions and abbreviations.....	8
3.1 Definitions.....	8
3.2 Abbreviations	9
4 Types of testing	9
4.1 Interoperability testing	9
4.2 Conformance testing.....	10
4.3 Combining interoperability testing and conformance testing.....	11
5 Interoperability testing process overview.....	11
6 Basic concepts	12
6.1 Means of Testing.....	12
6.2 Equipment Under Test (EUT)	13
6.3 Qualified Equipment (QE)	13
6.3.1 QEs and Devices.....	13
6.3.2 Designating the first QE	13
6.4 System Under Test (SUT).....	13
6.5 Test interface	14
6.6 Test driver	14
6.7 Test coordinator.....	14
6.8 Interoperability test cases	14
6.9 Means of Communication	15
7 Generic interoperability test architectures.....	15
7.1 Test architectures with a single QE.....	15
7.2 Test architectures with multiple QEs.....	16
7.2.1 An example using 3 QEs	16
7.2.2 Testing IP hosts with multiple QEs	17
8 Developing interoperability tests.....	18
8.1 Overview	18
8.2 Specify abstract architecture.....	19
8.3 Prepare draft IFS Proforma	19
8.4 Specify Test Suite Structure	20
8.4.1 Identify test groups	20
8.4.2 Define test coverage within each test group	20
8.5 Write Test Purposes.....	21
8.6 Write test cases	21
8.6.1 Pre-test conditions	21
8.6.2 Test steps and verdicts	22
8.6.2.1 Test steps.....	22
8.6.2.2 Verdicts	22
8.6.2.3 Specification of test steps and verdicts.....	22
8.6.3 Example	23
8.6.4 Pre-amble and post-amble	24
8.6.4.1 Alternative test case presentation forms.....	25
8.7 Validate test cases	26
8.8 Finalize IFS	26
9 Interoperability testing process	26

9.1	Overview	26
9.2	Prepare for testing	27
9.2.1	Test arrangement	27
9.2.2	Test planning	28
9.3	Testing	29
9.3.1	Manual testing	29
9.3.2	Automated testing	29
9.4	Write test report.....	29
Annex A: Example IFS (Internet Key Exchange protocol, IKEv2).....		30
A.1	Introduction	30
A.2	Instructions for completing the IFS proforma	30
A.2.1	General structure of the IFS proforma.....	30
A.2.2	Additional information	30
A.3	IFS proforma	31
A.3.1	Implementation identification	31
A.3.2	Protocol Summary, RFC 4306	31
A.4	IKEv2 entities.....	31
A.4.1	Roles.....	31
A.4.2	IKEv2 Initiator functions.....	32
A.4.2.1	IKE exchange types	32
A.4.2.1.1	IKE SA establishment functions	32
A.4.2.1.2	Child SA establishment functions	32
A.4.2.1.3	INFORMATIONAL exchange functions.....	33
A.4.3	IKEv2 Responder functions	33
A.4.3.1	IKE exchange types	33
A.4.3.1.1	IKE SA establishment functions	33
A.4.3.1.2	Child SA establishment functions	34
A.4.3.1.3	INFORMATIONAL exchange functions.....	34
Annex B: Example IFS (TIPHON Profile of SIP, Release 3).....		35
B.1	Introduction	35
B.2	Instructions for completing the IFS proforma	35
B.2.1	General structure of the IFS proforma.....	35
B.2.2	Additional information	35
B.3	IFS proforma	36
B.3.1	Implementation identification	36
B.3.2	Protocol Summary, EN 301 xxx.....	36
B.4	SIP entities.....	36
B.4.1	Roles.....	36
B.4.2	User Agent capabilities	37
B.4.2.1	Registration.....	37
B.4.2.2	Basic call.....	37
B.4.3	Registrar capabilities	38
B.4.3.1	Registration.....	38
B.4.4	Proxy capabilities	38
B.4.4.1	Proxy in the serving and intermediate network.....	38
B.4.4.1.1	Registration	38
B.4.4.1.2	Basic call	38
B.4.4.2	Proxy in the home network	39
B.4.4.2.1	Registration	39
B.4.4.2.2	Basic call.....	39
B.4.5	Gateway capabilities.....	39
B.4.5.1	Basic call.....	39

Annex C: Bibliography40
History41

Intellectual Property Rights

IPRs essential or potentially essential to the present document may have been declared to ETSI. The information pertaining to these essential IPRs, if any, is publicly available for **ETSI members and non-members**, and can be found in ETSI SR 000 314: "*Intellectual Property Rights (IPRs); Essential, or potentially Essential, IPRs notified to ETSI in respect of ETSI standards*", which is available from the ETSI Secretariat. Latest updates are available on the ETSI Web server (<http://webapp.etsi.org/IPR/home.asp>).

Pursuant to the ETSI IPR Policy, no investigation, including IPR searches, has been carried out by ETSI. No guarantee can be given as to the existence of other IPRs not referenced in ETSI SR 000 314 (or the updates on the ETSI Web server) which are, or may be, or may become, essential to the present document.

Foreword

This ETSI Guide (EG) has been produced by ETSI Technical Committee Methods for Testing and Specification (MTS), and is now submitted for the ETSI standards Membership Approval Procedure.

1 Scope

The present document, "A generic approach to interoperability testing", gives general guidance on the specification and execution of interoperability tests for communication systems specifically in the context of product certification. It provides a framework within which interoperability test specifications for a wide range of product types can be developed. The guidelines are expressed as recommendations rather than strict rules and leave enough freedom to allow test specifiers to adopt and adapt processes to suit each particular project while still ensuring that test specifications accurately reflect the requirements of the base standards and can be executed consistently across a range of configurations.

Interoperability testing is the structured and formal testing of functions supported remotely by two or more items of equipment communicating by means of standardized protocols. It is not the detailed verification of protocol requirements specified in a conformance test suite, neither is it the less formal development testing often associated with "plug-fest" and "interop" events (frequently referred to as "bake-offs"). A methodology for the latter type of testing is described in EG 202 810 [i.8].

Although some consideration is given within the methodology to the operating and reporting aspects of interoperability testing, the primary focus of the present document is on the specification of interoperability testing architectures, test plans and test suites.

2 References

References are either specific (identified by date of publication and/or edition number or version number) or non-specific. For specific references, only the cited version applies. For non-specific references, the latest version of the reference document (including any amendments) applies.

Referenced documents which are not found to be publicly available in the expected location might be found at <http://docbox.etsi.org/Reference>.

NOTE: While any hyperlinks included in this clause were valid at the time of publication ETSI cannot guarantee their long term validity.

2.1 Normative references

The following referenced documents are necessary for the application of the present document.

Not applicable.

2.2 Informative references

The following referenced documents are not necessary for the application of the present document but they assist the user with regard to a particular subject area.

- [i.1] ETSI ES 201 873-1: "Methods for Testing and Specification (MTS); The Testing and Test Control Notation version 3; Part 1: TTCN-3 Core Language".
- [i.2] Void.
- [i.3] ETSI TS 101 884: "Telecommunications and Internet Protocol Harmonization Over Networks (TIPHON) Release 3; Technology Mapping; Implementation of TIPHON architecture using SIP".
- [i.4] ETSI EG 202 107: "Methods for Testing and Specification (MTS); Planning for validation and testing in the standards-making process".
- [i.5] ISO/IEC 9646 (parts 1 to 7): "Information technology - Open Systems Interconnection - Conformance testing methodology and framework".
- [i.6] IETF RFC 3261: "SIP: Session Initiation Protocol".

- [i.7] IETF RFC 4306: "Internet Key Exchange (IKEv2) Protocol".
- [i.8] ETSI EG 202 810: "Methods for Testing and Specification (MTS); Automated Interoperability Testing; Methodology and Framework".
- [i.9] ETSI ES 202 553: "Methods for testing and Specification (MTS); TPLan: A notation for expressing test Purposes".

3 Definitions and abbreviations

3.1 Definitions

For the purposes of the present document, the following terms and definitions apply:

conformance: compliance with requirements specified in applicable standards ISO/IEC 9646 [i.5]

conformance testing: testing the extent to which an Implementation Under Test (IUT) satisfies both static and dynamic conformance requirements ISO/IEC 9646 [i.5]

NOTE: The purpose of conformance testing is to determine to what extent a single implementation of a particular standard conforms to the individual requirements of that standard.

device: item of software or hardware which either alone or in combination with other devices implements the requirements of a standardized specification

Equipment Under Test (EUT): grouping of one or more devices which has not been previously shown to interoperate with previously Qualified Equipment (QE)

Implementation Under Test (IUT): an implementation of one or more Open Systems Interconnection (OSI) protocols in an adjacent user/provider relationship, being the part of a real open system which is to be studied by testing (ISO/IEC 9646-1 [i.5])

interoperability: ability of two systems to interoperate using the same communication protocol

interoperability testing: activity of proving that end-to-end functionality between (at least) two communicating systems is as required by the base standard(s) on which those systems are based

interoperability test suite: collection of test cases designed to prove the ability of two (or more) systems to interoperate

InterWorking Function (IWF): translation of one protocol into another one so that two systems using two different communication protocols are able to interoperate

Qualified Equipment (QE): grouping of one or more devices that has been shown and certified, by rigorous and well-defined testing, to interoperate with other equipment

NOTE 1: Once an EUT has been successfully tested against a QE, it may be considered to be a QE, itself.

NOTE 2: Once a QE is modified, it loses its status as QE and becomes again an EUT.

System Under Test (SUT): one or more QEs and an EUT

test case: specification of the actions required to achieve a specific test purpose, starting in a stable testing state, ending in a stable testing state and defined in either natural language for manual operation or in a machine-readable language (such as TTCN-3) for automatic execution

test purpose: description of a well-defined objective of testing, focussing on a single interoperability requirement or a set of related interoperability requirements

3.2 Abbreviations

For the purposes of the present document, the following abbreviations apply:

API	Application Programming Interface
EP	End Point
EUT	Equipment Under Test
GFT	Graphical presentation Format for TTCN-3
IFS	Interoperable Features Statement
IUT	Implementation Under Test
IWF	InterWorking Function
MMI	Man-Machine Interface
MoC	Means of Communication
MoT	Means of Testing
OSI	Open Systems Interconnection
PICS	Protocol Implementation Conformance Statement
QE	Qualified Equipment
SIP	Session Initiation Protocol
SUT	System Under Test
TP	Test Purpose
TSS	Test Suite Structure

4 Types of testing

Equipment implementing standardized protocols and services can be formally tested in two related but different ways, which each have benefits and limitations:

- conformance testing can show that a product correctly implements a particular standardized protocol:
 - establishes whether or not the implementation in question meets the requirements specified for the protocol itself. For example, it will test protocol message contents and format as well as the permitted sequences of messages.
- interoperability testing can demonstrate that a product will work with other like products:
 - assesses the ability of the implementation to support the required trans-network functionality between itself and another, similar implementation to which it is connected.

Conformance testing in conjunction with interoperability testing provides both the proof of conformance and the guarantee of interoperation.

4.1 Interoperability testing

The term "interoperability testing" is often used in relation to the semi-formal testing carried out at multi-vendor events as part of the product development process. While such events, often referred to as "plug-fests", "interop" and "bake-offs", are valuable sources of information on the ability of similar products to communicate, they generally do not offer the structured and, therefore, repeatable, testing that is an essential part of a certification scheme. For a certification (or branding or logo) scheme to be meaningful, it is necessary that interoperability testing is carried out in accordance with a comprehensive and structured suite of tests. In the context of the present document, it is exactly this type of testing which is referred to as "interoperability testing". For other types of schemes, such as those arranged between manufacturers for marketing or other purposes this approach is still valid.

NOTE: It is possible that other organizations within the global standardization community will have interpretations of this term which differ to a greater or lesser extent.

The purpose of interoperability testing is to prove that end-to-end functionality between (at least) two communicating systems is as required by the standard(s) on which those systems are based.



Figure 1: Illustration of interoperability testing

The important factors which characterize interoperability testing are:

- the Equipment Under Test (EUT) and the Qualified Equipment (QE) together define the boundaries for testing (figure 1);
- the EUT and QE come from different suppliers (or, at least, different product lines);
- interoperability tests are performed at interfaces that offer only normal user control and observation (i.e. not at specialized interfaces introduced solely for testing purposes);
- interoperability tests are based on functionality as experienced by a user (i.e. they are not specified at the protocol level). In this context a user may be human or a software application;
- the tests are performed and observed at functional interfaces such as Man-Machine Interfaces (MMIs), protocol service interfaces and Application Programming Interfaces (APIs).

The fact that interoperability tests are performed at the end points and at functional interfaces means that interoperability test cases can only specify functional behaviour. They cannot explicitly cause or test protocol error behaviour.

4.2 Conformance testing

The purpose of conformance testing is to determine to what extent a single implementation of a particular standard conforms to the individual requirements of that standard.



Figure 2: Illustration of conformance testing

The important factors which characterize conformance testing are as follows:

- the System or Implementation Under Test (SUT or IUT) defines the boundaries for testing (figure 2);
- the tests are executed by a dedicated test system that has full control of the SUT and the ability to observe all communications from the SUT;
- the tests are performed at open standardized interfaces that are not (usually) accessible to a normal user. (i.e. they are specified at the protocol level).

Because the conformance tester maintains a high degree of control over the sequence and contents of the protocol messages sent to the IUT it is able to explore a wide range of both expected and unexpected (invalid) behaviour.

It is not within the scope of the present document to define a conformance testing methodology. However, because interoperability testing and conformance testing complement one another, the reader of the present document would be well-advised to study the established ISO conformance testing methodology defined in ISO/IEC 9646 parts 1 to 7 [i.5] as applied in all ETSI conformance test specifications.

4.3 Combining interoperability testing and conformance testing

Conformance and interoperability are both important and useful approaches to the testing of standardized protocol implementations although it is unlikely that one will ever fully replace the other. Conformance testing is able to show that a particular implementation complies with the protocol requirements specified in the associated base standard. However, it is difficult for such testing to be able to prove that the implementation will interoperate with similar implementations in other products. On the other hand, interoperability testing can clearly demonstrate that two implementations will cooperate to provide the specified end-to-end functions but cannot easily prove that either of them conforms to the detailed requirements of the protocol specification.

The purpose of interoperability testing is not only to show that products from different manufacturers can work together but also to show that these products can interoperate using a specific protocol. Without this additional aspect, interoperability testing could be considered to be almost meaningless. Within the context of standardization, it is of little interest to know that two products can interoperate unless there is a guarantee that they are connected together by means of a standardized protocol. It is, therefore, advisable to test the conformance of an implementation before testing for interoperability with other (similarly tested) implementations.

Although there are quite distinct differences between conformance testing and interoperability testing, it is valid to consider using the techniques together to give combined results. Such an approach will almost certainly involve some compromise and it is unlikely that it would provide the breadth and depth of testing that conformance and interoperability can offer when applied individually. However, some limited conformance testing with extensive interoperability testing, for example, may be useful in certain situations. The test configuration shown in figure 3 permits complete interoperability testing to be undertaken while limited protocol conformance monitoring takes place.

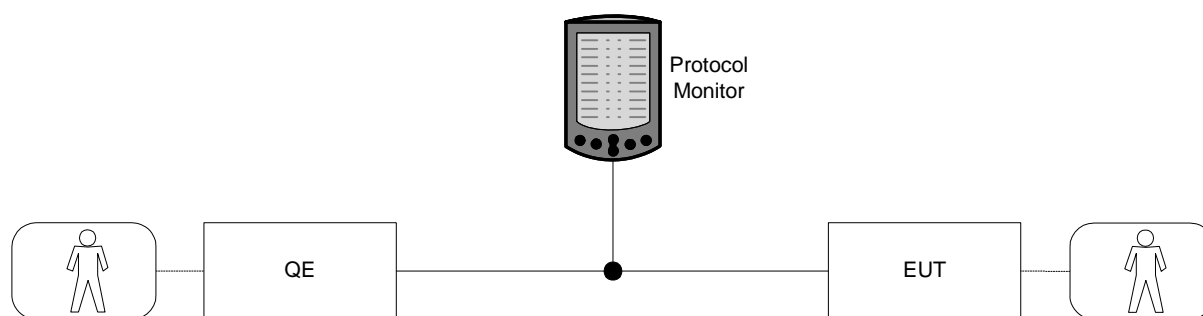

Figure 3: Interoperability testing with conformance monitoring

While this arrangement cannot provide a complete proof of conformance, analysis of the protocol monitor output will be able to show whether protocol signalling between the EUT and QE conformed to the appropriate standard(s) throughout the testing.

5 Interoperability testing process overview

The present document provides users with guidelines on the main steps associated with interoperability testing. The intention is that the guidelines should be simple and pragmatic so that the document can be used as a "cook-book" rather than a rigid prescription of how to perform interoperability testing.

The main components of the guidelines are described in clauses 8 and 9 and are as follows:

- development of interoperability test specifications, including:
 - identification of interoperable functions;
 - identification of abstract architectures;
 - specification of interoperability test suite structure and test purposes;
 - specification of interoperability test cases.

- the testing process, including:
 - test planning;
 - specification of test configurations;
 - execution of the tests;
 - logging results and producing test reports.

As their name implies, guidelines are only for guidance and the actual process followed should use and adapt whichever of these guidelines are most applicable in each particular situation. In some cases this may mean the application of all aspects.

6 Basic concepts

Figure 4 illustrates the main concepts specified in the present document. It shows the two main components of the methodology, namely the Means of Testing (MoT) and the System Under Test (SUT). The MoT includes the roles of test drivers and a test coordinator, the interoperability test cases and mechanisms for logging and reporting. The SUT comprises the Equipment Under Test (EUT) and one or more items of Qualified Equipment (QE). The Means of Communication (MoC) between the QE and the EUT is considered to be neither part of the SUT nor of the MoT.

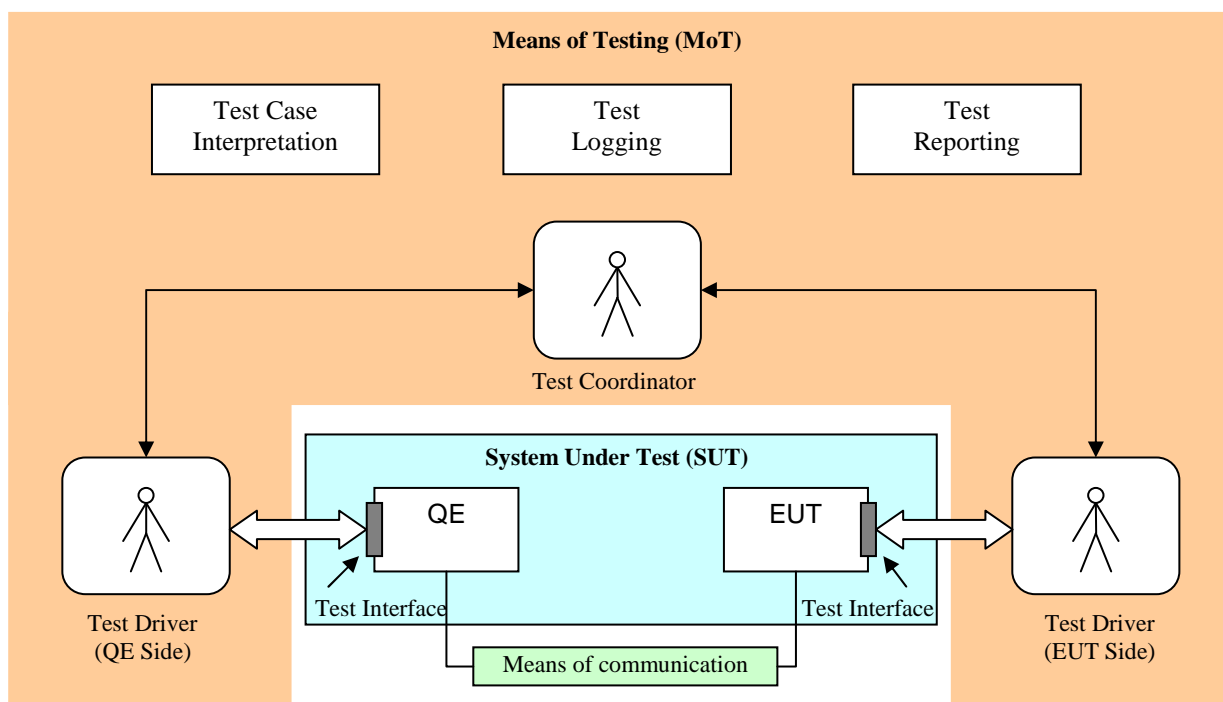

Figure 4: Illustration of main concepts

6.1 Means of Testing

The combination of equipment and procedures that realizes and performs the selection and execution of test cases is known as the Means of Testing (MoT). Test cases may be executed either by a human operator or by an automated program (see clause 6.6). The MoT should also be capable of logging test results and of producing test reports (see clause 9.4). The MoT includes neither the System Under Test nor the means by which devices in the System Under Test communicate.

6.2 Equipment Under Test (EUT)

In any interoperability testing architecture there will always be one connected item which is the subject of the test. This item is referred to as the Equipment Under Test or EUT. In general, any single test configuration will only have one EUT (with the exception of the case illustrated in clause 6.3.2). An EUT may be end-user equipment (such as a terminal), network equipment (such as a router) or a software application.

EUTs can be composed of any number of component parts each of which is referred to as a device. This may be a physical device, a software package or a combination of the two. The simplest case is where the EUT is a single device.

The interconnection configuration between devices in an EUT is purely a matter for the supplier and is not prescribed in the test architectures, nor is it considered to be an explicit part of the interoperability test for that EUT.

An EUT will not have been previously tested successfully for interoperability in a similar configuration although it may have been tested for conformance. While this methodology does not require previous conformance testing, it is recommended that this activity is performed, for the reasons mentioned in clause 4.3.

6.3 Qualified Equipment (QE)

6.3.1 QEs and Devices

When testing an EUT for interoperability, it is essential that the test architecture includes equipment that has already been proven to interoperate with similar equipment from other suppliers. Such items are referred to as the Qualified Equipment (QE). Any single test configuration may have one or more QEs. A QE may be end-user equipment (such as a terminal), network equipment (such as a router) or a software application.

QEs can also be composed of a number of component parts, each of which is, again, referred to as a device. This may be a physical device, a software package or a combination of the two. The simplest case is where the QE is a single device. Thus, a QE is a collection of devices that, in a given configuration, has undergone and passed certification based on interoperability testing.

The interconnection configuration between devices in a QE is purely a matter for the test system implementer and is not prescribed in the test architectures.

Any given QE will have initially been tested as an EUT but, once the full range of interoperability tests have been successfully performed, it can be considered to be a QE. However, any modification to the design or implementation of such a QE will require it to be tested again as an EUT.

This methodology does not force an EUT to be tested against all possible QEs in the pool of QEs that may be available in a particular testing scheme. However, the likelihood of multi-vendor interoperability is increased if it can be demonstrated that a particular EUT interoperates with a large number of different QEs.

6.3.2 Designating the first QE

In cases of new and developing technologies, no Qualified Equipment is likely to exist. The first instance of interoperability testing for a particular scheme will involve two (or more) EUTs rather than a number of QEs and one EUT [i.8].

Once these EUTs are shown to successfully interoperate, they will all be designated as QEs with none having precedence over any other. The testing scheme can then continue with new EUTs joining the pool of the existing QEs that have already been tested in a given configuration.

It is strongly recommended that any EUT has undergone conformance testing prior to interoperability testing.

6.4 System Under Test (SUT)

The System Under Test (SUT) is the combination of one or more QEs and one single EUT (with the exception of the case illustrated in clause 6.3.2). It does not, however, include the Means of Communication (MoC) (see clause 6.9).

6.5 Test interface

The interfaces that are made available by the SUT in order to perform testing are known as the test interfaces. These interfaces are accessed by the test drivers. Interfaces internal to the SUT may be used for logging and/or analysis but they are not considered to be an essential part of the test configuration.

In the simplest case, a test interface will be the normal user interfaces offered by the product undergoing testing (EUT) and by the QEs that are part of the SUT. Terminal equipment, for example, may be tested using a keypad, or a point-and-click dialog, or a combination of the two. Other EUTs, such as protocol stacks, may offer an API over which interoperability testing can be performed either manually using a terminal application or automatically using programmable test equipment.

An EUT will offer at least one interface to either the test driver and/or the QEs.

Any interface between the SUT and the Means of Communication (see clause 6.9) is not considered to be a test interface.

6.6 Test driver

As interoperability testing involves control and observation at the functional (rather than signalling) level, interoperability tests should be described in terms of activities by the user of the endpoint equipment. A test driver realizes the actions specified to be performed in a test case at one specific test interface. In many cases, this user can be considered to be a human but in others it will be more appropriate to think of the user as an application within a software system.

As a means of improving testing efficiency and consistency, the role of the test driver may be performed by an automatic device programmed to carry out the specified test steps.

The following examples illustrate both of these cases:

EXAMPLE 1: *Human User:* A test architecture is established with two IP telephony terminals connected to the same network supporting VoIP. Interoperability tests are specified at the terminals in terms such as "Take telephone A off-hook; Dial the E.164 number of telephone B etc."

EXAMPLE 2: *Application User:* A test architecture is established with two SIP Servers connected together but no user terminals because at the time of testing there are no suitable applications available. Interoperability tests are specified in terms such as "Cause INVITE message to be sent from QE to IP address at EUT; On receipt of INVITE from QE, cause 100 TRYING message to be sent from EUT to QE; etc."

In the first case, the human test driver will be performing valid tasks of a normal user of the system, using only the interfaces (e.g. MMI) offered by a product. In the second case, the test driver will be manipulating the EUT and the QE by whatever means is possible (for example, over an API) to ensure that specific messages are sent and observed.

6.7 Test coordinator

In any given instance of testing there will be at least two interfaces over which the tests will be run (see clause 6.5). The test coordinator is responsible for managing the two (or more) test drivers and synchronizing their actions, if needed.

The test coordinator is only a conceptual role and, in a practical case of testing, this role may be taken by, for instance, one of the test drivers.

6.8 Interoperability test cases

An Interoperability test case is the detailed set of instructions (or steps) that needs to be followed in order to perform the test. In the case where the test driver is a human operator, these instructions will be in natural language (see clause 8.6). In the case where the tests are automated, they may be written in a programming language or test language such as TTCN-3. The combined test cases should cover all events at each of the available test interfaces.

6.9 Means of Communication

The QE and EUT are connected by the Means of Communication (MoC). This, for example, may be a simple wire or a complex network of interconnected devices. In all cases this underlying transport mechanism is not considered to be part of the SUT.

It is assumed that the underlying communication layers have been previously tested to establish that they are conformant.

7 Generic interoperability test architectures

Figure 5 shows a generic architecture for interoperability testing. All interoperability testing architectures that show the relationship between the EUT, the QEs and the test operators can be derived from this model. The test driver for the EUT is optional, depending on the kind of equipment being tested. As an example, an EUT which is an interworking function (see clause 7.2) would probably not require a test driver function.

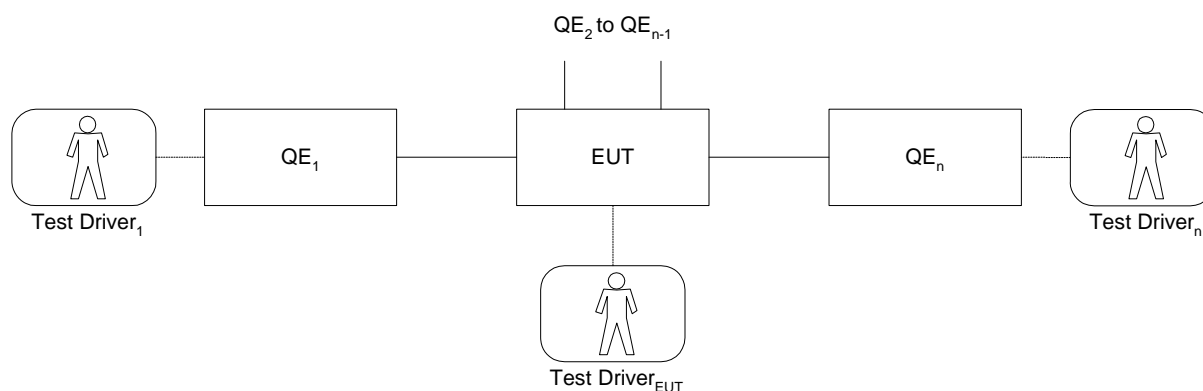

Figure 5: Generalized interoperability testing architecture

For simplicity, figure 5 shows that the QE and the EUT offer only a single interface to a single test driver. However, it is possible that an EUT or QE could offer more than one interface to one or more test drivers. This relationship need not necessarily be a one-to-one mapping.

7.1 Test architectures with a single QE

Figure 6 shows the simplest architecture where there is only one QE.

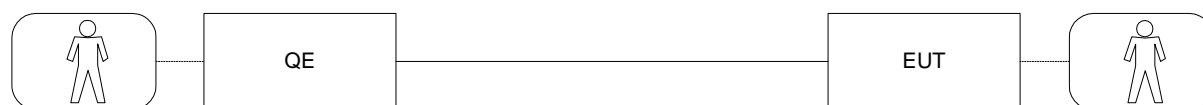

Figure 6: Basic interoperability test architecture

A typical example of this would be the case of testing terminal equipment such as a SIP phone from a given manufacturer. The QE is a SIP phone (from a different manufacturer) that has been tested previously. This is illustrated in figure 7.

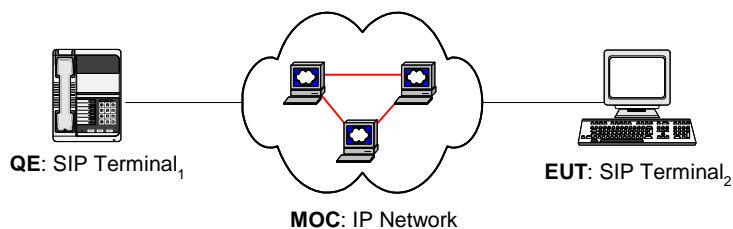

Figure 7: Example of the basic interoperability test architecture for SIP phones

7.2 Test architectures with multiple QEs

Figure 8 shows the generic architecture for an SUT with two QEs and with no test driver for the EUT.



Figure 8: Basic interoperability test architecture with 2 QEs and no EUT test driver

The generic test architecture in figure 8 is illustrated by the specific example in figure 9 which shows, in abstract form, the interconnection of a SIP Server (the EUT) with two SIP-capable terminals (QE1 and QE2).

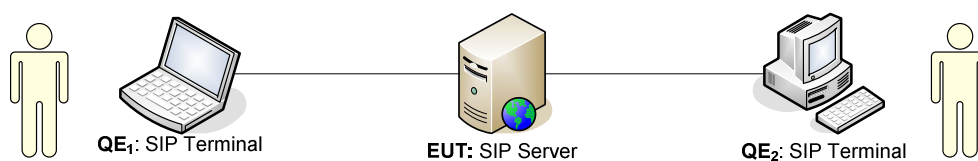

Figure 9: Interoperability test architecture for a SIP Server

7.2.1 An example using 3 QEs

Figure 10 shows the generic architecture with 3 QEs and with no test driver for the EUT.

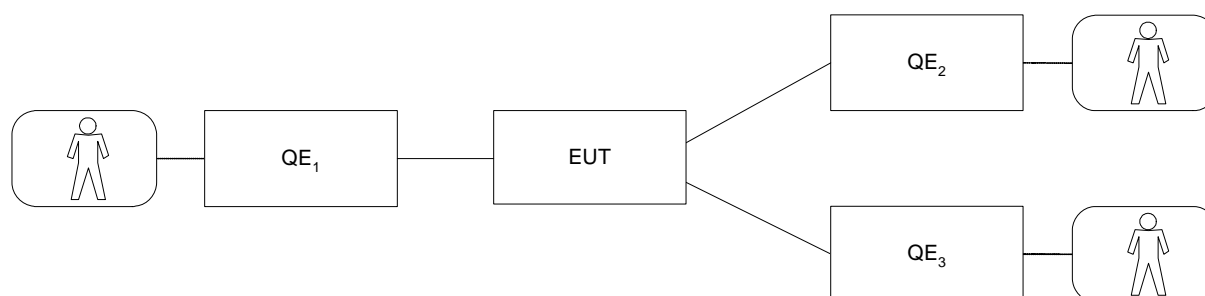

Figure 10: Basic interoperability architecture with 3 QEs and no EUT test driver

A concrete example of this architecture is shown in figure 11 which shows interoperability testing of the call diversion service using three QEs; one to make a call and two to show that the transfer has indeed taken place.

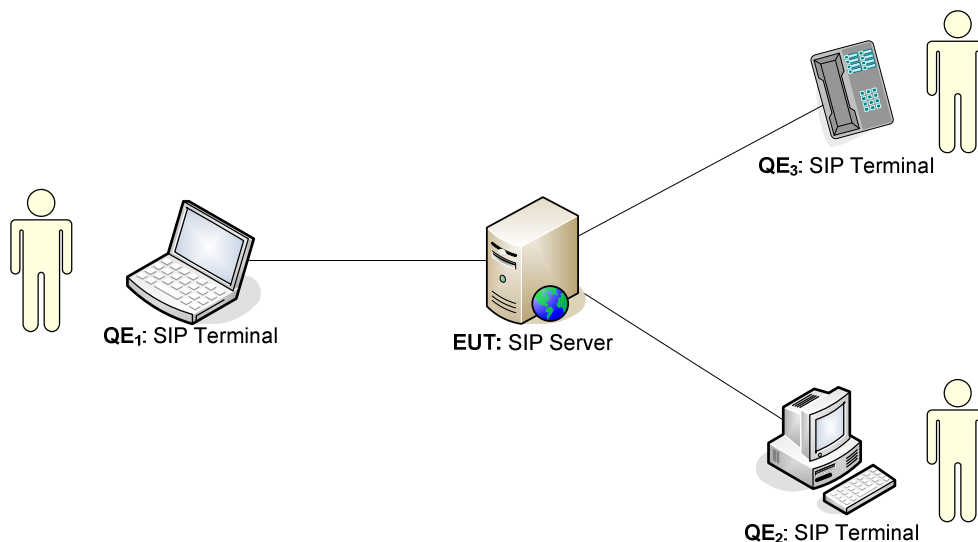

Figure 11: Using three QEs to test the call diversion service

7.2.2 Testing IP hosts with multiple QEs

Figure 12 shows a more complex architecture for testing the interoperability of an Internet host (Host₄) with routers and other hosts. The Means of Communication in this architecture is the Internet and the Ethernet local network. Because the interplay between the two routers and host is a key part of the test the routers are not included in the MoC.

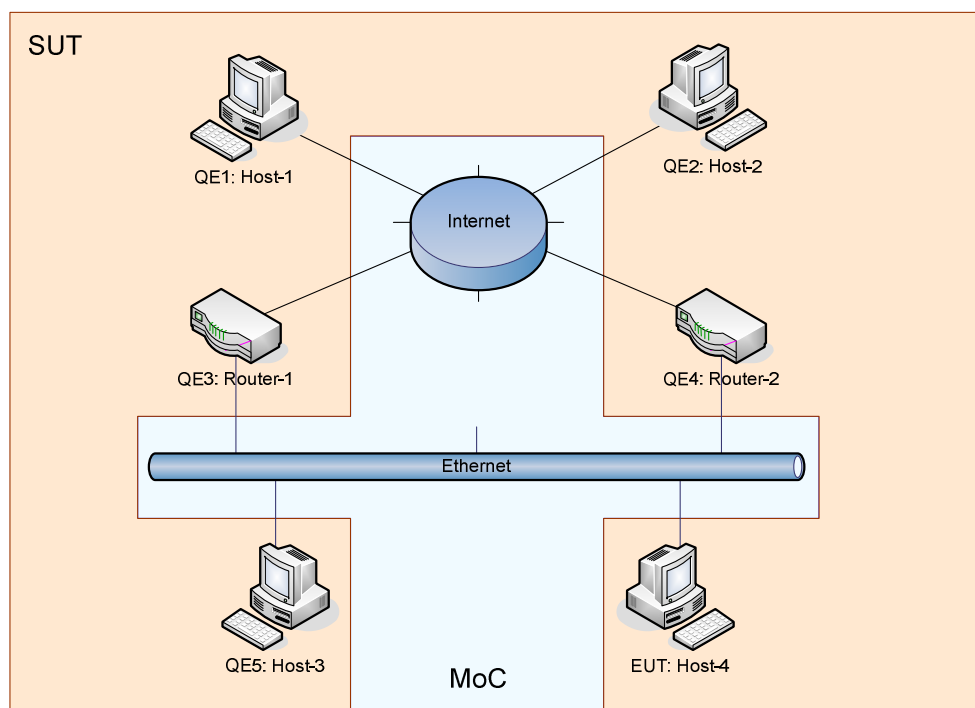

Figure 12: Interoperability testing an IP host with multiple QEs

8 Developing interoperability tests

8.1 Overview

The development of an interoperability test specification should follow a similar path to that taken when developing a conformance test specification. A close parallel can also be seen between the component parts of each type of test specification.

The steps involved in the process of developing an interoperability test specification are as follows:

- specify abstract architecture;
- prepare draft Interoperable Features Statement (IFS);
- specify Test Suite Structure (TSS);
- write Test Purposes (TP);
- write test cases;
- validate test cases;
- finalize IFS.

This process is expressed graphically in figure 13.

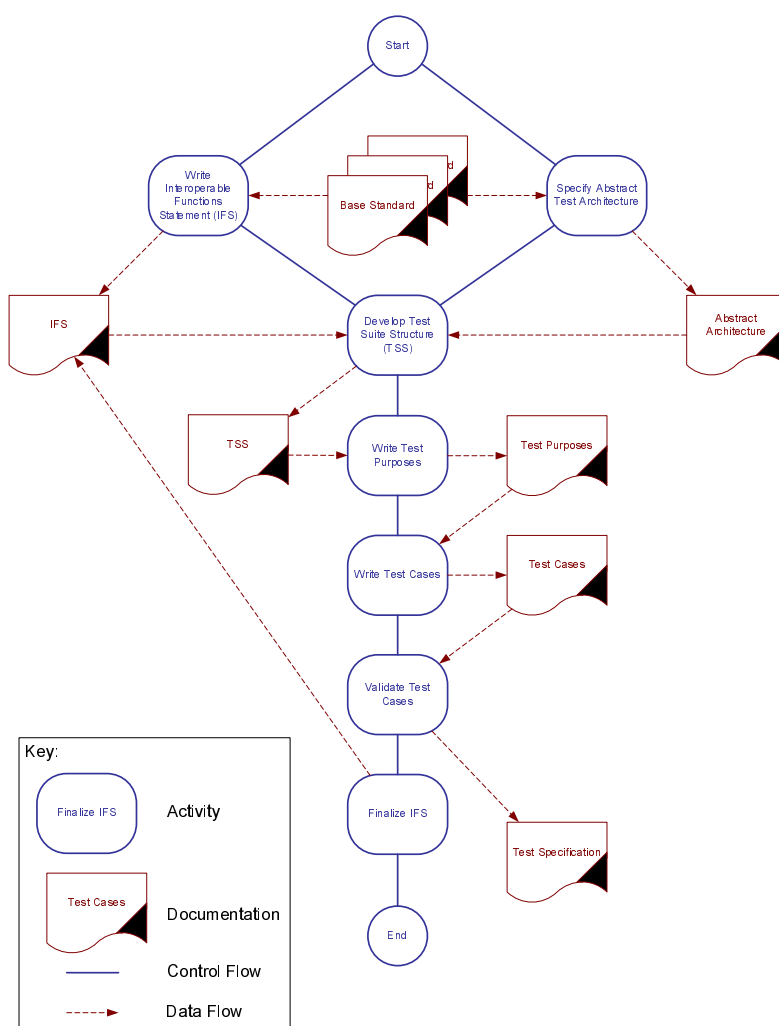

Figure 13: Developing an interoperability test specification

8.2 Specify abstract architecture

An abstract testing architecture provides a general framework within which specific test arrangements should fit in order to perform the specified suite of tests. Defining this architecture at an early stage should help to provide a structure for the test cases specified later. Abstract architectures can be expressed in diagrammatic, tabular or textual form and should clearly identify:

- the EUT;
- the QE(s);
- the communications paths between the EUT and QE(s);
- valid types of equipment for the EUT and QE(s);
- if required, the expected protocol to be used in providing communication between the EUT and QE(s).

Figure 14 shows in diagrammatic form an example of an abstract architecture for the testing of a stateful SIP proxy. In this example, one SIP proxy is identified as the EUT with another proxy plus two SIP end points identified as QEs. The Means of Communication is not specified although it is implied that it should carry SIP.

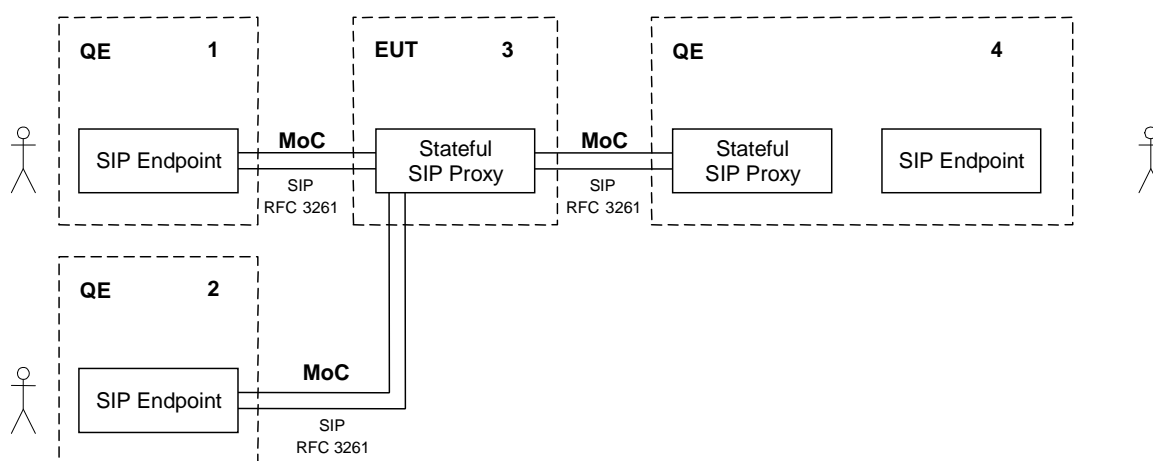

Figure 14: Example abstract architecture diagram

This abstract architecture could equally well be represented in a table, as shown in table 1.

Table 1: Example abstract architecture table

Item	EUT/QE	Equipment type	Connected to item	MoC
1	QE	SIP Endpoint	3	SIP (RFC 3261 [i.6])
2	QE	SIP Endpoint	3	SIP (RFC 3261 [i.6])
3	EUT	Stateful SIP Proxy	1	SIP (RFC 3261 [i.6])
			2	SIP (RFC 3261 [i.6])
			4	SIP (RFC 3261 [i.6])
4	QE	Stateful SIP Proxy + SIP Endpoint	3	SIP (RFC 3261 [i.6])

The abstract architecture should be derived from the requirements of the base protocol standard(s), and should be specified in a form that makes it simple to map each element of a concrete test scenario to it.

8.3 Prepare draft IFS Proforma

The purpose of an Interoperable Features Statement (IFS) is to identify those standardized functions which an EUT should support, those which are optional and those which are conditional on the support of other functions. Although not strictly part of the interoperability test suite, the IFS helps to provide a structure to the suite of tests which will subsequently be developed.

In addition, the IFS can be used as a proforma by a manufacturer in identifying which functions an EUT will support when interoperating with similar equipment from other manufacturers.

If it exists, the ideal starting point in the development of an IFS is the Protocol Implementation Conformance Statement (PICS) which should clearly identify the options and conditions which apply to the protocol to be tested. Like the PICS, the IFS should be considered part of the base protocol specification and not a testing document.

At this stage of the test suite development, the IFS can only be considered as a complete draft. As the test suite evolves, it is possible that errors and omissions in the IFS will be identified. These should be recorded for correction at a later stage (see clause 8.8). Example IFSs (for the IETF Internet Key Exchange protocol, IKEv2 [i.7] and the TIPHON profile of IETF SIP [i.3]) can be found in annexes A and B.

8.4 Specify Test Suite Structure

8.4.1 Identify test groups

There is no hard and fast rule that can be used to determine how a test suite should be divided up into test groups other than to say that there should be a logical basis to the choice of groups. In many cases, the division will be rather arbitrary and based on the preferences of the author(s). However, the following categorizations should be considered when identifying appropriate test groups within a Test Suite Structure (TSS):

- Abstract architecture: A test group for each valid configuration specified. For example:
 - terminal-to-terminal direct;
 - terminal-to-terminal via a gatekeeper;
 - terminal-to-terminal via an intervening network.
- Functionality: A test group for each of the major functions supported. For example:
 - basic voice call establishment;
 - basic voice call clearing;
 - supplementary service, call transfer.
- Success or failure: A test group for normal behaviour and another for exceptional behaviour.

8.4.2 Define test coverage within each test group

Once a logical set of test groups has been defined, the required range of functions to be tested in each group should be specified. As an example, the coverage for a basic voice call establishment test group might include:

- successful call from User A to User B;
- successful call from User B to User A;
- unanswered call from User A to User B;
- unanswered call from User B to User A;
- call attempt from User A to a busy User B;
- call attempt from User B to a busy User A.

NOTE: In the examples above, it would be necessary to have specified the meaning of "User A" and "User B" in the context of the abstract architecture.

There should be enough information in the test coverage to ensure that tests can be specified for all of the interoperable functions of an implementation.

8.5 Write Test Purposes

Before writing the individual steps that are required to complete a test case, a full description of the objective of each test case should be specified in its Test Purpose (TP). Without this objective, it may not be clear how the test should be defined. The following example explains the intent of the associated test case in enough detail that there should be no ambiguity for the test writer.

Test Purpose: To verify that a call to User B can be successfully established by User A and that speech communication is possible between User A and User B.

It is worth noting that the above example might be considered too complex as a conformance TP in that it specifies two test criteria (successful call establishment and speech communication) but as an interoperability TP, it is perfectly valid.

It is acceptable to write TPs in natural English (as can be seen in the example above). Indeed, ISO/IEC 9646 [i.5] recommends that test specifications include a concise and unambiguous description of each test which focuses on its purpose. TPs define *what* is to be tested rather than *how* the testing is performed and are based on the *requirements* identified in the relevant standard (or standards) from which the test specification is derived.

There is considerable benefit to be gained by having all TPs written in a similar and consistent way. This can be achieved using the structured Test Purpose notation, TPLan (see ES 202 553 [i.9]).

The benefits of using TPLan are:

- a consistency in test purpose descriptions - less room for misinterpretation;
- a clear identification of the TP pre-conditions, test description, and verdict criteria;
- the ability to check syntax automatically and to highlight it in text editors;
- the ability to graphically or textually render TP descriptions for the needs of different users.

TPLan provides a framework for a consistent representation (format, layout, structure and logical ordering) and a consistent use of words and patterns of words. This is achieved without unnecessarily restricting the expressive power of pure prose. TPLan allows the use of an extendable set of keywords in combination with free-text strings (enclosed by single quotes). Thus, the TP writer has considerable freedom of expression in the use of unstructured text between the keywords. The following example shows how a TP can be fully specified using TPLan.

```
TP id      : TP_CALL_0347
Summary   : 'User A is able to call User B'
RQ ref    : RQ_003_0592
Role      : PINX
Config    : CF_CALL_05
TC Ref    : TC_CALL_0347

with {
  User_B idle
  and User_A configured 'to be able to make calls to User B'
}
ensure that {
  when { User_A initiates a call to the address of User_B }
  then { User_B indicates an incoming_call }
  when { User_B answers the incoming_call }
  then { User_A and User_B can communicate }
}
```

8.6 Write test cases

8.6.1 Pre-test conditions

In some instances, although not necessarily all, it is useful to be able to specify some pre-conditions to a test case. This often takes the form of instructions for configuring the EUT and QE to ensure that the Test Purpose is met fully. An example of a valid pre-test condition is "*Configure EUT and QE to communicate using SIP with G.711 μ Law codec*".

8.6.2 Test steps and verdicts

8.6.2.1 Test steps

Test cases describe the detailed steps that should be followed in order to achieve the stated purpose of each test. These steps should be specified in a clear and unambiguous way but without placing unreasonable restrictions on how the step is performed. Clarity and precision are important to ensure that the step is followed exactly. The lack of restrictions is necessary if the test could apply to a range of different types of implementation. As an example, the test step "*Pick up User A's telephone handset and dial the number of User B*" is certainly clear and unambiguous but it can only apply to a classical, physical telephone and not to a soft phone or even a mobile handset. Expressing this step as "*Initiate a new call at User A to the address of User B*" is no less clear or unambiguous but it can be applied to any type of telephone.

8.6.2.2 Verdicts

At the end of each test case (and, where necessary, interspersed with the test steps) it is important to specify the criterion for assigning a verdict to the test case. This is probably best expressed as a question such as "*Can speech from User B be heard and understood?*". Verdict criteria need to be specified as clearly and unambiguously as test steps and without restrictions. If a criterion is expressed as a question, it should be constructed in such a way that "Yes" and "No" are the only possible answers and it should be clear which result represents a "Pass" verdict and which represents a "Fail".

Both intermediate and final verdicts should be constructed in such a way that failure automatically implies failure of the overall test. Intermediate verdicts should not be included simply to provide information. As an example, in an interoperability test suite for telephony functions, it would not be necessary to have an intermediate verdict "*Is dial-tone present?*" if dial-tone is intended to be generated locally. If, on the other hand, dial-tone should (or could) be generated by the remote end, such a verdict would be perfectly valid.

Although it is clear that a "Pass" verdict will always mean that, for a specific test, the EUT and QE(s) interoperate correctly, it may not be the case that a "Fail" verdict implies that they do not. The MoC plays an essential role in almost all interoperability tests but is not part of the SUT (see figure 4). A "Fail" verdict may be caused by a fault or unexpected behaviour in the MoC. Thus, each "Fail" verdict should be investigated thoroughly, possibly using monitoring equipment as shown in figure 3, to determine its root cause before either validating the verdict as a true failure (if the root cause is within the SUT) or retesting (if the root cause is determined to be outside the SUT).

8.6.2.3 Specification of test steps and verdicts

Test steps and verdicts should be specified at the level appropriate to the functions to be tested. For example, if the purpose of an interoperability test suite is to test a telephony application where SIP is the underlying protocol, the test steps should specify actions and observations at the user terminal or agent (e.g. "*Answer incoming call*" and "*Is ringing tone heard?*"). If, however, the object is to establish the interoperability of two SIP protocol stacks, the tests should specify actions and observations possible at the application interfaces of the stacks (e.g. "*Cause SIP INVITE message to be sent*" or "*Was 180 Ringing received?*").

As interoperability testing most often involves the activation and observation of user functions, it is reasonable for test cases to be specified as series of steps to be performed by human test drivers. Such test cases are more often referred to as Test Descriptions. In situations where automation of user functions is possible, test cases could also be written in any of the following:

- test specification languages (e.g. TTCN-3);
- programming languages (e.g. C++);
- scripting languages (e.g. PERL).

It should be noted that although test cases written only in machine-readable form offer great benefits in terms of repeatability and speed of execution, they cannot, generally, be used by human test drivers as instruction for running the tests manually. Thus, when it is not known how the tests will be performed, it is advisable to write them in a structured form of a natural language such as English. However, while an automated test programme or script can easily accommodate alternative behaviour paths to handle exceptional conditions (such as an unexpected error message), such multiple paths are very difficult to include in a structured and easy-to-read English test description.

8.6.3 Example

No assumptions should be made about the knowledge of the EUT or QE possessed by the person (or machine) carrying out the test. The sequence of actions involved in each test case should be specified in full. An example of a complete test case description (including Test Purpose and pre-conditions) is shown in table 2.

Table 2: Example test description specification

Identifier	TC_SS_0001_01		
Summary:	Supervised call transfer from User B to User A		
Test Purpose:	<pre>ensure that { when { A call is established between User_C and User_B } then { User_B can transfer the call from User_B to User_A after User_B and User_A communicate } }</pre>		
TP Identifier	TP_SS_0001	Configuration:	Test Architecture 2
Pre-test conditions:	<ul style="list-style-type: none"> User A, User B and User C configured with Bearer Capability set to "Speech, 64 kbit/s" User A configured to support the Call Transfer service 		
Step	Test sequence	Verdict	
		Pass	Fail
1	Initiate new call at User C to the address of User B		
2	Accept call at User B		
3	Activate the "recall" button (or equivalent) at User B's terminal		
4	<i>Is dial tone (or an equivalent indication) present at User B's terminal?</i>	Yes	No
5	Initiate a new call from User B to the address of User A		
6	<i>Is User A's terminal alerting (visual or audible indication)?</i>	Yes	No
7	Accept call at User A		
8	Apply speech at User A		
9	<i>Can speech from User A be heard and understood at User B?</i>	Yes	No
10	<i>Can speech from User A be heard and understood at User C?</i>	No	Yes
11	Apply speech at User B		
12	<i>Can speech from User B be heard and understood at User A?</i>	Yes	No
13	<i>Can speech from User B be heard and understood at User C?</i>	No	Yes
14	Clear call at User B		
15	Apply speech at User A		
16	<i>Can speech from User A be heard and understood at User C?</i>	Yes	No
17	Apply speech at User C		
18	<i>Can speech from User C be heard and understood at User A?</i>	Yes	No
19	Clear the call at User A		
20	Clear the call at User C		
Observations:			

8.6.4 Pre-amble and post-amble

In the example test description shown in table 2 it is clear that Steps 1 and 2 are essential for establishing the call and that Steps 19 and 20 are equally necessary for clearing the call but none of these steps play a significant part in the test itself as there are no verdicts associated with them. In conformance testing terminology, they can be considered to be the pre-ample (Steps 1 and 2) and the post-ample (Steps 19 and 20) and it may be useful to segregate these steps from the main testing sequence as shown by the dotted lines in table 3. Other methods of segregation (such as shading or the use of prefixes to the step numbers) are equally valid and may even be combined for greater effect.

Table 3: Test case example showing segregation of pre-ample and post-ample

Identifier	TC_SS_0002_01		
Summary:	Supervised call transfer from User B to User A		
Test Purpose:	<pre>ensure that { when { A call is established between User_C and User_B } then { User_B can transfer the call from User_B to User_A after User_B and User_A communicate } }</pre>		
TP Identifier	TP_SS_0001	Configuration:	Test Architecture 2
Pre-test conditions:	<ul style="list-style-type: none"> User A, User B and User C configured with Bearer Capability set to "Speech, 64 kbit/s" User A configured to support the Call Transfer service 		
Step	Test sequence	Verdict	
		Pass	Fail
P1	Initiate new call at User C to the address of User B		
P2	Accept call at User B		
3	Activate the "recall" button (or equivalent) at User B's terminal		
4	<i>Is dial tone (or an equivalent indication) present at User B's terminal?</i>	Yes	No
5	Initiate a new call from User B to the address of User A		
6	<i>Is User A's terminal alerting (visual or audible indication)?</i>	Yes	No
7	Accept call at User A		
8	Apply speech at User A		
9	<i>Can speech from User A be heard and understood at User B?</i>	Yes	No
10	<i>Can speech from User A be heard and understood at User C?</i>	No	Yes
11	Apply speech at User B		
12	<i>Can speech from User B be heard and understood at User A?</i>	Yes	No
13	<i>Can speech from User B be heard and understood at User C?</i>	No	Yes
14	Clear call at User B		
15	Apply speech at User A		
16	<i>Can speech from User A be heard and understood at User C?</i>	Yes	No
17	Apply speech at User C		
18	<i>Can speech from User C be heard and understood at User A?</i>	Yes	No
P19	Clear the call at User A		
P20	Clear the call at User C		
Observations:			

8.6.4.1 Alternative test case presentation forms

Test descriptions written in a structured and tabulated natural language (as in table 3) are ideal when the tests themselves are to be performed manually by human test drivers. If, however, tests are to be performed automatically using computer-based test drivers, test cases should, perhaps, be written in an appropriate programming or scripting language. The following text shows how the example test case could be expressed in the TTCN-3 core language [i.1].

```
// Supervised Transfer test case
testcase tc_supervisedTransfer()
runs on UserTerminalType
{ timer t_response := 100E-3;

  var default def := activate( a_catchTimeout() );

  // Preamble: Establish call between Users B & C
  m3s.send (m_CallEstablish_1);
  m2s.receive (m_CallEstablish_1);
  m2s.send (m_CallAccept_1);
  m3s.receive (m_CallAccept_1);

  // Register recall test
  m2s.send (m_Recall);
  t_response.start;
  m2d.receive (m_DialTone);
  setverdict(pass);
  t_response.stop;

  // Hold call test
  m2s.send (m_CallEstablish_2);
  m1s.receive (m_CallEstablish_2);
  t_response.start;
  m1s.send (m_Alerting);
  m2s.receive (m_Alerting);
  setverdict(pass);
  t_response.stop;

  // Speech test 1
  m1s.send (m_CallAccept_2);
  m2s.receive (m_CallAccept_2);
  m1d.send (m_DTMF123456);
  t_response.start;
  alt
  { [] m3d.receive (m_DTMF123456)
    { setverdict(fail);
      stop;
    }

    [] m2d.receive (m_DTMF123456)
    {}
  }
  setverdict(pass);
  ResponseTimer.stop

  // Speech test 2
  m2d.send (m_DTMF123456);
  t_response.start;
  alt
  { [] m3d.receive (m_DTMF123456)
    { setverdict(fail);
      stop;
    }

    [] m1d.receive (m_DTMF123456)
    { setverdict(pass);
      t_response.stop;
    }
  }

  // Transfer test 1
  m2s.send (m_CallRelease_1);
  m1d.send (m_DTMF123456);
  t_response.start;
  m3d.receive (m_DTMF123456);
  setverdict(pass);
  t_response.stop;

  // Transfer test 2
  m3d.send (m_DTMF123456);
```

```

t_response.start;
mld.receive (m_DTMF123456)
setverdict (pass);
t_response.stop

// Postamble: Clear down the call
m3s.send (m_CallRelease_2);
m1s.send (m_CallRelease_2);
}
}

```

8.7 Validate test cases

The ideal method of validating test cases is to set up a physical test configuration and then perform each of the tests to ensure that:

- the specified pre-conditions establish the EUT and QE in the necessary configuration for the test;
- no unnecessary pre-conditions are specified;
- the abstract architecture can be realized in a concrete configuration which enables the specified test to be executed;
- the individual test steps are expressed in an unambiguous way and are easy to follow;
- all necessary steps are covered from the start of the test to its completion;
- each test case fully realizes the objective of its test purpose;
- the combined intermediate and final verdicts do, in fact, lead to a true assessment of the test purpose.

In many cases, it will not be possible to validate the test cases by execution because there will not be suitable equipment available. In such situations, the simplest alternative is to carry out a structured walk-through of each test case (preferably with independent reviewers) checking every step and verdict in turn to assess the completeness and validity of the test case. Further information on walk-through and other validation methods can be found in EG 202 107 [i.4], "Planning for validation and testing in the standards-making process".

8.8 Finalize IFS

During the development of the Test Purposes, test description and test cases it is possible that inconsistencies, gaps and other inaccuracies will be identified in the draft IFS. Now that the development is complete, these identified changes should be consolidated into the final IFS ready for publication.

9 Interoperability testing process

9.1 Overview

Although it is possible to automate interoperability testing, it is likely that test cases will be written in a structured natural language to be followed by human test drivers. It is, therefore, important to ensure that the defined steps and verdicts of each test case are carefully followed and recorded.

Interoperability testing involves the following three stages:

- preparing for testing;
- testing;
- writing the Test Report.

The process is expressed graphically in figure 13.

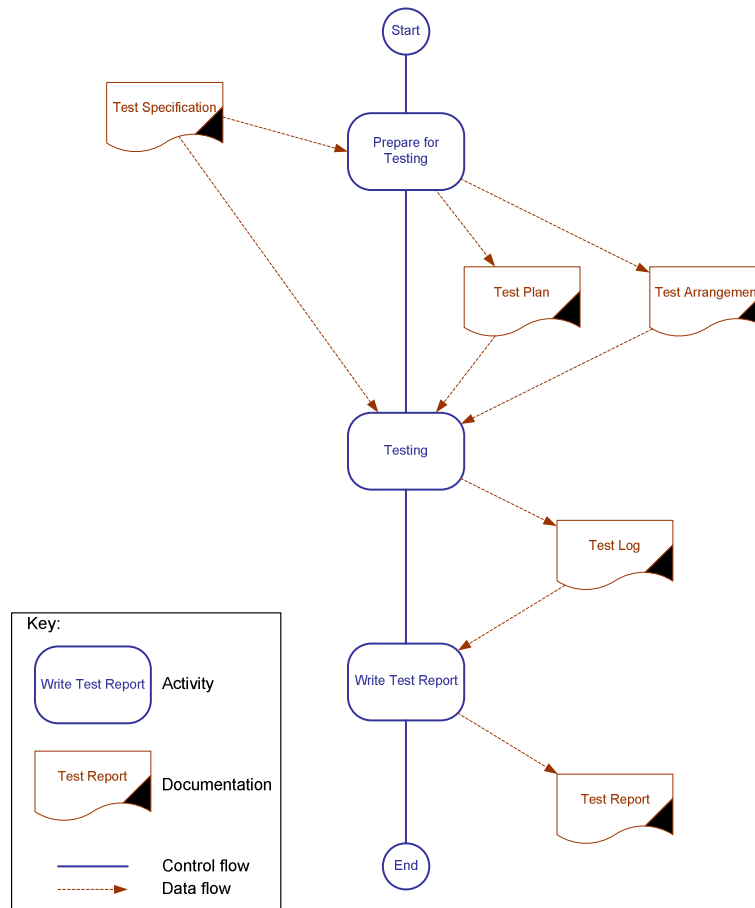

Figure 15: Interoperability testing

9.2 Prepare for testing

9.2.1 Test arrangement

Before actual testing can take place, there are a number of activities that should be completed. The first of these is to specify a test arrangement (figure 17) mapping the abstract architecture (figure 16) in the test specification to the concrete configurations that are going to be used for testing. This mapping should identify the manufacturer, product name and build status of the EUT and the QE(s). It should also specify how the various items of equipment are to be physically interconnected.

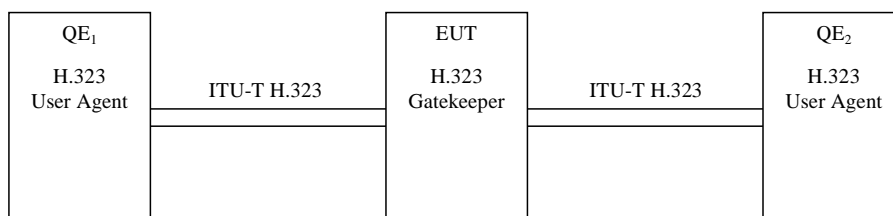

Figure 16: Example of an abstract architecture

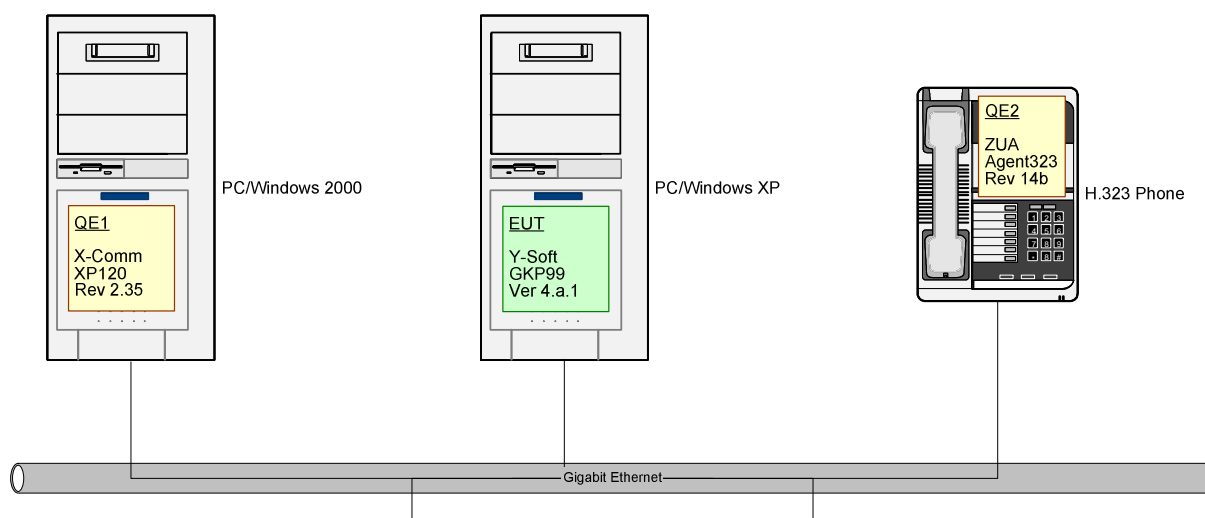

Figure 17: Test arrangement based on the example abstract architecture

In addition to the definition of physical test arrangements, it may also be useful to specify other system configuration requirements which could include items such as the necessary numbering plan and the choice of codecs to be used in the testing.

9.2.2 Test planning

It is always advisable to take the time to prepare a plan of testing before beginning the work itself. A test plan should include:

- identification of which test cases are to be included;
- identification of which (optional) test cases are not to be included;
- indication of the order in which the tests are to be performed and the relationships between tests;
- specification of the test arrangements required for each group of tests;
- identification of equipment and facilities required to establish the necessary test configurations;
- identification of the human resources required during the testing period.

The information above should be consolidated into a formal plan against which progress can be monitored. Figure 18 shows an example test plan presented as a Gantt chart although any form of planning diagram (e.g. PERT or Timeline) could also be used.

ID	Task Name	Start	End	Duration	Resource Name	Feb 2003							Mar 2003														
						20	21	22	23	24	25	26	27	28	1	2	3	4	5	6	7	8	9	10	11	12	13
1	Specify Test Arrangements	20/02/2003	21/02/2003	2d	JT	█	█																				
2	Select Tests to be run	20/02/2003	21/02/2003	2d	AW	█	█																				
3	Acquire necessary equipment	24/02/2003	29/02/2003	5d	AW			█	█	█	█	█															
4	Run Tests in Group 1	03/03/2003	03/03/2003	1d	JT																						
5	Run Tests in Group 2	04/03/2003	06/03/2003	3d	JT																						
6	Run Tests in Group 3	07/03/2003	07/03/2003	1d	JT																						
7	Collate Test Verdicts and Observations	10/03/2003	11/03/2003	2d	JT																						
8	Write Test Report	12/03/2003	14/03/2003	3d	AW																						

Tests in Group 1 use Test Configuration A
 Tests in Group 2 use Test Configuration B
 Tests in Group 3 use Test Configuration B

Figure 18: Example test plan

9.3 Testing

9.3.1 Manual testing

The sequence of tests specified should be grouped in a logical way that ensures efficient use of test configurations and a "bottom-up" flow of tests (testing basic functionality first and then progressing to more complex functions). It is, therefore, important to carry out the tests in the sequence specified, exactly following the steps defined in each test case.

Throughout the testing process, it is essential that a record of each verdict (both intermediate and final) is kept for each test case. If the test cases are specified in a tabular form, this can be used as a proforma for logging the test results. Alternatively, a simple table listing each of the test cases and their associated verdicts could be used. An example of how such a table could be constructed is shown in table 4.

Table 4: Example table summarizing test verdicts

Test case	Title	Verdict						Overall verdict	Observations
		1	2	3	4	5	6		
BS-1	Voice call establishment from User A to User B	✓	✓	✓	✓	✓	✓	Pass	
BS-2	Voice call establishment from User B to User A	✓	✓	✓	✓	✓	✓	Pass	
BS-3	Call establishment from User A to User B using en-bloc sending	*						Fail	User B's terminal failed to alert although ringing tone was heard at User A's terminal

Table 4 shows a test summary in fairly simple form. If necessary, additional information, such as a time-stamp or identification of the test driver(s), can be included.

9.3.2 Automated testing

If the test cases have been automated (as described in clause 8.6.2.3), the sequencing of tests and the logging of verdicts will be predetermined by the test programme. It will still be necessary to take care in establishing and modifying the test arrangements as required to ensure that the expected configurations are tested.

9.4 Write test report

A test report should summarize the testing activity and provide a clear indication of whether the tested equipment can be considered to be interoperable or not. It should include the following:

- Organizational information:
 - when the testing took place;
 - where the testing took place;
 - who carried out the testing.
- Equipment information:
 - test configurations used;
 - hardware and software identities for EUT and all QEs;
 - hardware and software revision states for EUT and all QEs;
 - identification of the standards (including versions) implemented in each MoC.
- Testing information:
 - identification of the specific test specification upon which the testing was based;
 - identification of omitted tests (with a reason for omission if appropriate);
 - full summary of test verdicts.

Annex A: Example IFS (Internet Key Exchange protocol, IKEv2)

A.1 Introduction

The supplier of an Internet Key Exchange version 2 (IKEv2) protocol implementation which is claimed to conform to RFC 4306 [i.7] may complete the following Interoperable Features Statement (IFS) proforma if the implementation is to be submitted for interoperability testing. The IFS is a statement of which functions supported by the protocol have been implemented. The IFS can have a number of uses, including:

- as a detailed indication of the functional capabilities of the implementation;
- as a basis for initially checking the possibility of interoperating with another implementation;
- as the basis for selecting appropriate tests against which to assess the ability of the implementation to interoperate with other implementations.

A.2 Instructions for completing the IFS proforma

A.2.1 General structure of the IFS proforma

The IFS proforma is a fixed format questionnaire divided into clauses each containing a group of individual items. Each item is identified by an item number, the name of the item (question to be answered), and the reference(s) to the clause(s) that specifies (specify) the item in the main body of the standard.

The "Status" column indicates whether an item is applicable and if so whether support is mandatory or optional. The following terms are used:

M	mandatory (the function is required by RFC 4306 [i.7]);
O	optional (the function is not required by RFC 4306 [i.7], but if the function is implemented, it is required to conform to the protocol specifications);
O.<n>	optional, but support of at least one of the group of options labelled by the same numeral <n> is required;
C:<cond>	conditional requirement, depending on support for the item or items listed in condition <cond> explained below the table of appearance;
N/A	not applicable, this feature is not contained in the profile.

References to the specification are made in the column "Reference".

Answers to the questionnaire items are to be provided either in the "Support" column, by simply marking an answer to indicate a restricted choice (Yes or No), or in the "Not Applicable" column (N/A).

A.2.2 Additional information

Items of additional information allow a supplier to provide further information intended to assist the interpretation of the IFS. It is not intended or expected that a large quantity will be supplied, and a IFS can be considered complete without any such information. Examples might be an outline of the ways in which a (single) implementation can be set up to operate in a variety of environments and configurations.

References to items of additional information may be entered next to any answer in the questionnaire, and may be included in items of exception information.

A.3 IFS proforma

A.3.1 Implementation identification

Supplier	
Contact point for queries about the IFS	
Implementation name(s) and version(s) (see note)	
Other information necessary for full identification - e.g. name(s) and version(s) for machines and/or operating systems; system name(s)	
NOTE: The terms name and version should be interpreted appropriately to correspond with a suppliers terminology (e.g. type, series, model).	

A.3.2 Protocol Summary, RFC 4306

Protocol version	
Addenda implemented (if applicable)	
Amendments implemented	
Date of statement	

A.4 IKEv2 entities

Table A.1: IKEv2 entities

Item	IKEv2 entities	Reference	Support
IE_1	IKE Endpoint		
Comments:			

A.4.1 Roles

Table A.2: IKE Endpoint roles

Item	Role	Reference	Support
EP_1	Initiator	RFC 4306 [i.7]	
EP_2	Responder	RFC 4306 [i.7]	
Comments:			

A.4.2 IKEv2 Initiator functions

A.4.2.1 IKE exchange types

Table A.3: Initiator's IKE exchange types

Item	Function	Reference	Status	Support
IX_1	IKE (parent) SA establishment	1.2	M	
IX_2	Child SA establishment	1.3	M	
IX_3	INFORMATIONAL exchange	1.4	M	
Comments:				

A.4.2.1.1 IKE SA establishment functions

Table A.4: Initiator's IKE SA establishment functions

Item	Function	Reference	Status	Support
IS_1	Use of retransmission timers	2.1	M	
IS_2	Use of sequence numbers for Message ID	2.2, 3.1	M	
IS_3	Window Size for overlapping requests	2.3, 3.10.1	M	
IS_4	State synchronization & connection timeouts	2.4	M	
IS_5	Version number and forward compatibility	2.5, 3.1	M	
IS_6	Cookies	2.6, 3.10.1	M	
IS_7	Cryptographic Algorithm Negotiation	2.7, 3.3.2	M	
IS_8	Rekeying	2.8, 2.17, 3.10.1	M	
IS_9	Authentication of the IKE_SA	2.15, 3.8	M	
IS_10	Extensible Authentication Protocol Method	2.16, 3.16	M	
IS_11	Error handling	2.21, 3.10.1	M	
IS_12	NAT Traversal	2.23, 3.10.1	M	
Comments:				

A.4.2.1.2 Child SA establishment functions

Table A.5: Initiator's Child SA establishment functions

Item	Function	Reference	Status	Support
IC_1	Use of retransmission timers	2.1	M	
IC_2	Use of sequence numbers for Message ID	2.2, 3.1	M	
IC_3	Window Size for overlapping requests	2.3, 3.10.1	M	
IC_4	State synchronization & connection timeouts	2.4	M	
IC_5	Version number and forward compatibility	2.5, 3.1	M	
IC_8	Cookies	2.6, 3.10.1	M	
IC_6	Rekeying	2.8, 2.17, 3.10.1	M	
IC_7	Traffic Selector Negotiation (see comments)	2.9, 3.13	M	
IC_8	Requesting an internal address on a remote network *	2.19, 3.15	O	
IC_9	Error handling	2.21, 3.10.1	M	
IC_10	IP Compression (IPComp) (see comments)	2.22, 3.10.1	O	
Comments:				
Included in the implicit establishment of a Child SA as part of an IKE SA establishment.				

A.4.2.1.3 INFORMATIONAL exchange functions

Table A.6: Initiator's INFORMATIONAL exchange functions

Item	Function	Reference	Status	Support
II_1	Notification exchange	1.4, 3.10	M	
II_2	Delete exchange	1.4, 3.11	M	
II_3	Configuration exchange	1.4, 3.15	M	
II_4	Informational messages outside an IKE_SA	1.5	O	
II_5	Use of retransmission timers	2.1	M	
II_6	Use of sequence numbers for Message ID	2.2, 3.1	M	
II_7	Window size for overlapping requests	2.3, 3.10.1	M	
II_8	Version numbers and forward compatibility	2.5, 3.1	M	
II_9	Requesting the peer's version	2.20, 3.15	O	
II_10	Error handling	2.21, 3.10.1	M	
Comments:				

A.4.3 IKEv2 Responder functions

A.4.3.1 IKE exchange types

Table A.7: Responder's IKE exchange types

Item	Function	Reference	Status	Support
RX_4	IKE (parent) SA establishment	1.2	M	
RX_5	Child SA establishment	1.3	M	
RX_6	INFORMATIONAL exchange	1.4	M	
Comments:				

A.4.3.1.1 IKE SA establishment functions

Table A.8: Responder's IKE SA establishment functions

Item	Function	Reference	Status	Support
RS_13	Use of sequence numbers for Message ID	2.2, 3.1	M	
RS_14	Window Size for overlapping requests	2.3, 3.10.1	M	
RS_15	Version number and forward compatibility	2.5, 3.1	M	
RS_16	Cookies	2.6, 3.10.1	M	
RS_17	Cryptographic Algorithm Negotiation	2.7, 3.3.2	M	
RS_18	Rekeying	2.8, 2.17, 3.10.1	M	
RS_1	Address and port agility	2.11	M	
RS_19	Authentication of the IKE_SA	2.15, 3.8	M	
RS_20	Extensible Authentication Protocol Method	2.16, 3.16	M	
RS_21	Error handling	2.21, 3.10.1	M	
RS_22	NAT Traversal	2.23, 3,10.1	M	
Comments:				

A.4.3.1.2 Child SA establishment functions

Table A.9: Responder's Child SA establishment functions

Item	Function	Reference	Status	Support
RC_11	Use of sequence numbers for Message ID	2.2, 3.1	M	
RC_12	Window Size for overlapping requests	2.3, 3.10.1	M	
RC_13	Version number and forward compatibility	2.5, 3.1	M	
RC_8	Cookies	2.6, 3.10.1	M	
RC_14	Rekeying	2.8, 2.17, 3.10.1	M	
RC_15	Traffic Selector Negotiation (see comments)	2.9, 3.13	M	
RC_1	Address and port agility	2.11	M	
RC_16	Requesting an internal address on a remote network (see comments)	2.19, 3.15	O	
RC_17	Error handling	2.21, 3.10.1	M	
RC_18	IP Compression (IPComp) (see comments)	2.22, 3.10.1	O	
Comments:				
Included in the implicit establishment of a Child SA as part of an IKE SA establishment.				

A.4.3.1.3 INFORMATIONAL exchange functions

Table A.10: Responder's INFORMATIONAL exchange functions

Item	Function	Reference	Status	Support
RI_11	Notification exchange	1.4, 3.10	M	
RI_12	Delete exchange	1.4, 3.11	M	
RI_13	Configuration exchange	1.4, 3.15	M	
RI_14	Informational messages outside an IKE_SA	1.5	O	
RI_15	Use of sequence numbers for Message ID	2.2, 3.1	M	
RI_16	Window size for overlapping requests	2.3, 3.10.1	M	
RI_17	Version numbers and forward compatibility	2.5, 3.1	M	
RI_5	Address and port agility	2.11	M	
RI_18	Requesting the peer's version	2.20, 3.15	O	
RI_19	Error handling	2.21, 3.10.1	M	
Comments:				

Annex B: Example IFS (TIPHON Profile of SIP, Release 3)

B.1 Introduction

The supplier of a protocol implementation which is claimed to conform to TS 101 884 [i.3] may complete the following Interoperable Features Statement (IFS) proforma if the implementation is to be submitted for interoperability testing. The IFS is a statement of which functions supported by the protocol have been implemented. The IFS can have a number of uses, including:

- as a detailed indication of the functional capabilities of the implementation;
- as a basis for initially checking the possibility of interoperating with another implementation;
- as the basis for selecting appropriate tests against which to assess the ability of the implementation to interoperate with other implementations.

B.2 Instructions for completing the IFS proforma

B.2.1 General structure of the IFS proforma

The IFS proforma is a fixed format questionnaire divided into clauses each containing a group of individual items. Each item is identified by an item number, the name of the item (question to be answered), and the reference(s) to the clause(s) that specifies (specify) the item in the main body of the standard.

The "Status" column indicates whether an item is applicable and if so whether support is mandatory or optional. The following terms are used:

M	mandatory (the function is required by TS 101 884 [i.3]);
O	optional (the function is not required by TS 101 884 [i.3], but if the function is implemented, it is required to conform to the protocol specifications);
O.<n>	optional, but support of at least one of the group of options labelled by the same numeral <n> is required;
C.<cond>	conditional requirement, depending on support for the item or items listed in condition <cond> explained below the table of appearance;
N/A	not applicable, this feature is not contained in the profile.

References to the specification are made in the column "Reference".

Answers to the questionnaire items are to be provided either in the "Support" column, by simply marking an answer to indicate a restricted choice (Yes or No), or in the "Not Applicable" column (N/A).

B.2.2 Additional information

Items of additional information allow a supplier to provide further information intended to assist the interpretation of the IFS. It is not intended or expected that a large quantity will be supplied, and a IFS can be considered complete without any such information. Examples might be an outline of the ways in which a (single) implementation can be set up to operate in a variety of environments and configurations.

References to items of additional information may be entered next to any answer in the questionnaire, and may be included in items of exception information.

B.3 IFS proforma

B.3.1 Implementation identification

Supplier	
Contact point for queries about the IFS	
Implementation name(s) and version(s) (see note)	
Other information necessary for full identification - e.g. name(s) and version(s) for machines and/or operating systems; system name(s)	
NOTE: The terms name and version should be interpreted appropriately to correspond with a suppliers terminology (e.g. type, series, model).	

B.3.2 Protocol Summary, EN 301 xxx

Protocol version	
Addenda implemented (if applicable)	
Amendments implemented	
Date of statement	

B.4 SIP entities

Table B.1: SIP entities

Item	SIP entities	Reference	Support
SE1	User agent		
SE2	Registrar		
SE3	Proxy		
SE4	Gateway		
Comments:			

B.4.1 Roles

Table B.2: User agent roles

Item	Role	Reference	Support
UA1	Originating user agent		
UA2	Terminating user agent		
Comments: The roles "originating" and "terminating" apply to a User Agent's role regarding a call. Since a user agent is going to take each position during its usage the capabilities are not listed separately in the following clauses. If there are capabilities that apply only for one role the status field will show a "condition" that will be explained below the corresponding table.			

Table B.3: Registrar roles

Item	Role	Reference	Support
RE1	Registrar in the home network		
Comments:			

Table B.4: Proxy roles

Item	Role	Reference	Support
PR1	Proxy in serving network		
PR2	Proxy in intermediate network		
PR3	Proxy in home network		
Comments:			

Table B.5: Gateway roles

Item	Role	Reference	Support
GW1	Originating gateway		
GW2	Terminating gateway		
Comments: The roles "originating" and "terminating" apply to a gateway's role regarding a call. Since a gateway is going to take each position during its usage the capabilities are not listed separately in the corresponding clauses. If there are capabilities that apply only for one role the status field will show a "condition" that will be explained below the corresponding table.			

B.4.2 User Agent capabilities

B.4.2.1 Registration

Table B.6: User Agent: registration capabilities

Item	Function	Reference	Status	Support
U_REG1	Unicast registration	[i.3] 5.1.1	M	
U_REG2	Multicast registration	[i.6] 10.2.6	O	
U_REG3	Authenticated registration	[i.3] 5.1.1.1	M	
U_REG3	Additive registration	[i.3] 5.1.1.1	M	
U_REG4	Refreshing contact addresses	[i.3] 5.2.1	M	
U_REG5	Removing contact addresses/Deregistration	[i.3] 5.3.1	M	
Comments:				

B.4.2.2 Basic call

Table B.7: User agent basic call capabilities

Item	Function	Reference	Status	Support
U_BC1	Call establishment without authentication	[i.3] 5.2.2.1.1	M	
U_BC2	Call establishment with authentication	[i.3] 6.2.1	O	
U_BC3	Call clearing of an active call	[i.3] 6.2.1	M	
U_BC4	Call clearing before destination answers	[i.3] 6.2.1	M	
U_BC5	Rejection of incoming call	[i.3] 6.2.1.1	M	
U_BC6	Call clearing authenticated	[i.3] 6.2.1.2	M	
Comments:				

B.4.3 Registrar capabilities

B.4.3.1 Registration

Table B.8: Registrar capabilities

Item	Function	Reference	Status	Support
U_REG1	Unicast registration	[i.3] 5.1.1	M	
U_REG2	Multicast registration	[i.6] 10.2.6	O	
U_REG3	Authenticated registration	[i.3] 5.1.2.1.1	M	
U_REG4	Additive registration	[i.3] 5.1.1.1	M	
U_REG5	Refreshing contact addresses	[i.3] 5.2.2	M	
U_REG6	Removing contact addresses/Deregistration	[i.3] 5.3.2	M	
Comments:				

B.4.4 Proxy capabilities

B.4.4.1 Proxy in the serving and intermediate network

B.4.4.1.1 Registration

Table B.9: Serving/Intermediate proxy registration capabilities

Item	Function	Reference	Status	Support
S_REG1	Unicast registration	[i.3] 5.1.2	M	
S_REG2	Multicast registration	[i.6] 10.2.6	C.1	
S_REG3	Additive registration	[i.3] 5.1.1.1	M	
S_REG4	Refreshing contact addresses	[i.3] 5.2.3	M	
S_REG5	Removing contact addresses/Deregistration	[i.3] 5.3.3	M	
Comments:				
C.1: <i>if PR1 then M else N/A.</i>				

B.4.4.1.2 Basic call

Table B.10: Serving/Intermediate proxy basic call capabilities

Item	Function	Reference	Status	Support
S_BC1	Call establishment without authentication	[i.3] 6.3.1	M	
S_BC2	Call clearing of an active call	[i.3] 6.3.1	M	
S_BC3	Call clearing before destination answers	[i.3] 6.3.1	M	
Comments:				

B.4.4.2 Proxy in the home network

B.4.4.2.1 Registration

Table B.11: Home proxy registration capabilities

Item	Function	Reference	Status	Support
H_REG1	Unicast registration	[i.3] 5.1.2	M	
H_REG3	Additive registration	[i.3] 5.1.1.1	M	
H_REG4	Refreshing contact addresses	[i.3] 5.2.2	M	
H_REG5	Removing contact addresses/Deregistration	[i.3] 5.3.3	M	
Comments:				

B.4.4.2.2 Basic call

Table B.12: Home proxy basic call capabilities

Item	Function	Reference	Status	Support
H_BC1	Call establishment with authentication	[i.3] 6.4.1	M	
H_BC2	Call clearing of an active call	[i.3] 6.4.2	M	
H_BC3	Call clearing before destination answers	[i.3] 6.4.2	M	
H_BC4	Call clearing authenticated	[i.3] 6.4.2	M	
Comments:				

B.4.5 Gateway capabilities

B.4.5.1 Basic call

Table B.13: User agent basic call capabilities

Item	Function	Reference	Status	Support
G_BC1	Call establishment without authentication	[i.3] 5.2.2.1.1	M	
G_BC2	Call establishment with authentication	[i.3] 6.10.1	C.1	
G_BC3	Call clearing of an active call	[i.3] 6.9/6.10.2	M	
G_BC4	Call clearing before destination answers	[i.3] 6.10.2	C.2	
Comments:				
C.1: <i>if GW1 then O else N/A.</i>				
C.2: <i>if GW1 then M else N/A.</i>				

Annex C: Bibliography

- "Interconnectability testing method-AICTS", Sawai, K.; Konno, T.; Hatafuku, M.; Gotoh, K.; Suzuki, S.; Kazama, K., Networks, 1995. Theme: Electrotechnology 2000: Communications and Networks. [in conjunction with the] International Conference on Information Engineering, Proceedings of IEEE Singapore International Conference on, 1995 Page(s): 289 - 293.
- "Relating interoperability testing with conformance testing", Sungwon Kang, Global Telecommunications Conference, 1998. GLOBECOM 1998. The Bridge to Global Integration. IEEE, Volume: 6, 1998 Page(s): 3768 -3773 vol.6.
- "Interoperability testing of VoIP systems", Griffeth, N.; Hao, R.; Lee, D. Sinha, R.K.; Global Telecommunications Conference, 2000. GLOBECOM '00. IEEE, Volume: 3, 2000 Page(s): 1565 -1570 vol.3.
- IEEE 100: "The Authoritative Dictionary of IEEE Standards Terms", Seventh Edition.
- ETSI ES 201 873-3: "Methods for Testing and Specification (MTS); The Testing and Test Control Notation version 3; Part 3: TTCN-3 Graphical presentation Format (GFT)".

History

Document history		
V1.1.2	April 2007	Publication
V1.2.1	June 2010	Membership Approval Procedure MV 20100801: 2010-06-02 to 2010-08-02